

VIRTUAL KNOTS AND LINKS WITH UNKNOTTING INDEX (n, m)

K. KAUR AND M. PRABHAKAR

ABSTRACT. In [13], K. Kaur, S. Kamada *et al.* posed a problem of finding a virtual knot, if exists, with an unknotting index (n, m) , for any pair of non-negative integers (n, m) . In this paper, we address this question by providing infinite families of virtual knots with unknotting index (n, m) , for a given pair of non-negative integers (n, m) . Additionally, we extend our result for virtual links also.

1. INTRODUCTION

Virtual knots were introduced by L. H. Kauffman [11] as a natural generalization of classical knots, and independently by M. Goussarov, M. Polyak and O. Viro [6]. Various knot invariants from the literature have been naturally extended to virtual knot invariants and, more generally, to virtual link invariants, as well. In recent years, several invariants have been introduced to distinguish two given virtual knots. These include the index polynomial [8], two variable polynomials [14], affine index [12], arc shift number and region arc shift number [5], multi-variable polynomial [18], zero polynomial, [9] and n -th writhe [22] of virtual knots.

The concept of an unknotting operation holds a significant importance in the knot theory as well as in the virtual knot theory to define an unknotting invariant. In literature, very few unknotting invariants are known for virtual knots. Although a virtual knot extends from a knot, not every unknotting operation applicable to knots necessarily applies to virtual knots. While well known local moves such as crossing change, delta move and sharp move are unknotting operations for classical knots [17], but for virtual knots, these local moves are not unknotting operations [19, 20]. One of the unknotting operations for virtual knots is known as virtualization, which is a replacement of classical crossing by virtual crossing. Taking crossing change and virtualization operation together, a new unknotting invariant for virtual knots called the unknotting index has been introduced in [13]. This work has been further extended to virtual links by K. Kaur *et al.* in [16]. The unknotting index of a virtual knot is a pair of non-negative integers, compared with respect to the dictionary order. This unknotting index is an extension of the usual unknotting number. Similar to usual unknotting number, there is no general mechanism for computing the unknotting index of a given virtual knot/link. This unknotting index is known for some well known families of virtual knots and links, see [13, 16].

In [13], It was proved that for any non-negative integer n there exists a virtual knot whose unknotting index is $(1, n)$. For any pair (n, m) of non-negative integers,

2020 *Mathematics Subject Classifications.* 57K12, 57K10

Key words and phrases. Virtual knot, polynomial invariants, unknotting index.

following question has been arised by A. Kaur *et al.* in [13],

Find a virtual knot K with $U(K) = (n, m)$.

In this paper, we address this problem by constructing an infinite family of virtual knots whose unknotting index is (n, m) , for any given pair (n, m) . For any pairs $(0, m)$ and $(1, m)$, we provide infinitely many prime virtual knots with unknotting index $(0, m)$ and $(1, m)$, respectively. Moreover, for any pair (n, m) of non-negative integers, we establish the existence of an infinite family of virtual knots whose unknotting index is (n, m) . Furthermore, we extend this result to virtual links.

This paper is organized as follows. Section 2 contains preliminaries that are required to prove the main results of the paper. Specifically, we define the unknotting index for virtual knots and revisit the concept of n -th writhe for virtual knots. In Section 3, we present the main results of this paper. We conclude this paper in Section 4.

2. PRELIMINARIES

A virtual link diagram exhibits two types of crossings: classical crossings and virtual crossings, see Fig. 1.



FIGURE 1

Equivalence between two virtual link diagrams is established by deforming one virtual link diagram to another through a finite sequence of classical Reidemeister moves RI, RII, RIII, as shown in Fig. 2(a), and virtual Reidemeister moves VR I, VR II, VR III, SV, as shown in Fig. 2(b).

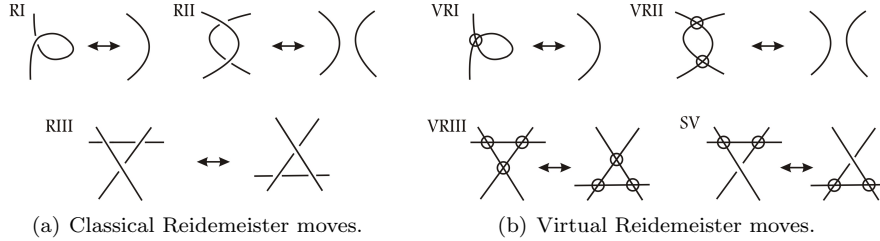

FIGURE 2. Reidemeister moves.

A diagram D of a virtual knot K is said to be (n, m) -unknottable if by virtualizing n classical crossings and crossing change operation at m classical crossings of D , the resulting diagram can be deformed into a diagram of the trivial knot. Note that the diagram D is $(\mathcal{C}(D), 0)$ -unknottable, where $\mathcal{C}(D)$ is the number of classical crossings of D .

Definition 2.1. [13] The *unknotting index* of a diagram D , denoted by $U(D)$, is the minimum among all pairs (n, m) such that D is (n, m) -unknottable. Here the minimality is taken with respect to the dictionary order.

Definition 2.2. [13] The *unknotting index* of a virtual knot K , denoted by $U(K)$, is defined as

$$U(K) = \min\{U(D) | D \in [K]\},$$

where the minimality is taken with respect to the dictionary order.

The unknotting index for a virtual link is defined in the similar lines, see [16, Definition 1.1]. A virtual knot/link L is trivial if and only if $U(L) = (0, 0)$. In case of a classical link L , the unknotting index $U(L) = (0, u(L))$, where $u(L)$ is the usual unknotting number of L .

In general, it is a difficult task to find the unknotting index for a given virtual knot or link. In [13, 16], some lower bounds has been established on this unknotting index for virtual knots and links using n -th writhe invariant [22] and span value [1, 16]. Using these lower bounds the unknotting index for some well known families of virtual knots and links has been computed, see [13, 16].

Let D be an oriented virtual knot diagram. An *arc* is an edge between two consecutive classical crossings along the orientation. Now assign an integer value to each arc in D in such a way that the labeling around each crossing point of D follows the rule shown in Fig. 3. L. H. Kauffman proved [12, Proposition 4.1] that such integer labeling, called a *Cheng coloring*, always exists for an oriented virtual knot diagram.

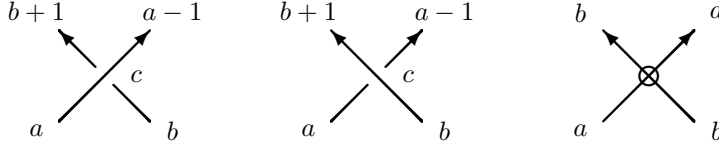

FIGURE 3. Labeling around crossing

After labeling, assign a weight $W_D(c)$ [12], to each classical crossing c . For the crossing c in Fig. 3,

$$W_D(c) = \text{sgn}(c)(a - b - 1).$$

In [1], Z. Cheng and H. Gao assigned an integer value, called *index value*, to each classical crossing c of a virtual knot diagram and denoted it by $\text{Ind}(c)$. By the definition of the index of a crossing c , it is easy to observe that $|\text{Ind}(c)| \leq |\mathcal{C}(D)|$, where $|\mathcal{C}(D)|$ denote the cardinality of $\mathcal{C}(D)$. It was proved [1, Theorem 3.6] that

$$(1) \quad \text{Ind}(c) = W_D(c) = \text{sgn}(c)(a - b - 1)$$

with a and b be labels as presented in Fig. 3.

In [22], S. Satoh and K. Taniguchi introduced the n -th writhe. For each $n \in \mathbb{Z} \setminus \{0\}$ the n -th writhe $J_n(D)$ of an oriented virtual knot diagram D is defined as the number of positive sign crossings minus number of negative sign crossings of D with index value n . Note that $J_n(D)$ is indeed coefficient of t^n in the affine index polynomial. This n -th writhe is a virtual knot invariant, for more details we refer to [22].

Proposition 2.1. [22, Theorem 1.5] *Let K be a virtual knot.*

- (a) *If $J_n(K) \neq J_{-n}(K)$ for some $n \in \mathbb{Z} \setminus \{0\}$, then $(1, 0) \leq U(K)$.*
- (b) *$(0, \sum_{n \neq 0} |J_n(K)|/2) \leq U(K)$.*

A *flat virtual knot diagram* is a virtual knot diagram obtained by forgetting the over/under-information of every real crossing. It means that a flat virtual knot is an equivalence class of flat virtual knot diagrams by *flat Reidemeister moves* which are Reidemeister moves (see Figs. 2(a) and 2(b)) without the over/under information. We will say that a virtual knot invariant is a *flat virtual knot invariant*, if it is independent of crossing change operation.

Lemma 2.1. [13] *Let K be a virtual knot and \bar{K} its flat projection. If \bar{K} is non-trivial, then $U(K) \geq (1, 0)$.*

Remark 2.1. *Let K be a virtual knot with $U(K) \geq (1, 0)$. Then K cannot be deformed into the trivial knot by applying the crossing change operation. Thus the flat projection \bar{K} of K is non-trivial. By using Lemma 2.1, we can say the flat projection \bar{K} is non-trivial if and only if $U(K) \geq (1, 0)$.*

In [1], Z. Cheng and H. Gao defined an invariant, called span, for 2-component virtual links using Gauss diagram. Consider a diagram $D = D_1 \cup D_2$ of a virtual link $L = K_1 \cup K_2$. Let us traverse along D_1 and consider the linking crossings of D_1 and D_2 . If α_+ (respectively, α_-) is the number of over linking crossings with positive sign (respectively, negative sign) and β_+ (respectively, β_-) is the number of under linking crossings with positive sign (respectively, negative sign), then $span(D)$ of D is defined as

$$span(D) = |(\alpha_+ - \alpha_-) - (\beta_+ - \beta_-)|.$$

Further, the definition of span value is extended in [16] for virtual links having arbitrary components. Span value of a virtual link diagram $D = D_1 \cup D_2 \cup \dots \cup D_n$ is defined as

$$span(D) = \sum_{i \neq j} span(D_i \cup D_j).$$

Since $span(D_i \cup D_j)$ is a virtual link invariant, $span(D)$ is also a virtual link invariant.

Let S be a subset of $\mathcal{C}(D)$ and $|S|$ denote the cardinality of S . Then $\Lambda(D)$ and $\ell(D)$ are defined as

$$\Lambda(D) = \{S \subseteq \mathcal{C}(D) \mid |S| = span(D) \text{ and } span(D_S) = 0\},$$

$$\ell_D = \min\{|\text{lk}(D_S)| \mid S \in \Lambda(D)\},$$

where D_S is a diagram obtained from D by virtualizing all the crossings of S .

For a virtual link diagram D of 2-components, ℓ_D is a virtual link invariant [16, Proposition 2.1].

Theorem 2.1. [16] *If $D = D_1 \cup D_2 \cup \dots \cup D_n$ is a diagram of a virtual link L , then*

$$\left(span(D), \sum_{i \neq j} \ell_{D_i \cup D_j} + \frac{1}{2} \sum_{i=1}^n \sum_{k \in \mathbb{Z} \setminus \{0\}} |J_k(D_i)| \right) \leq U(L).$$

3. MAIN RESULTS

In this section, we construct an infinite family of virtual knots with unknotting index (n, m) , for any given pair of non-negative integers (n, m) . In particular, for non-negative pairs $(0, m)$ and $(1, m)$, we establish the existence of infinite prime virtual knots with unknotting index $(0, m)$ and $(1, m)$. To establish the main result in Theorem 3.4 for any (n, m) , we prove the Lemma 3.1, Lemma 3.2 and Theorem 3.3. Additionally, we extend these result to virtual links in Theorem 3.1.

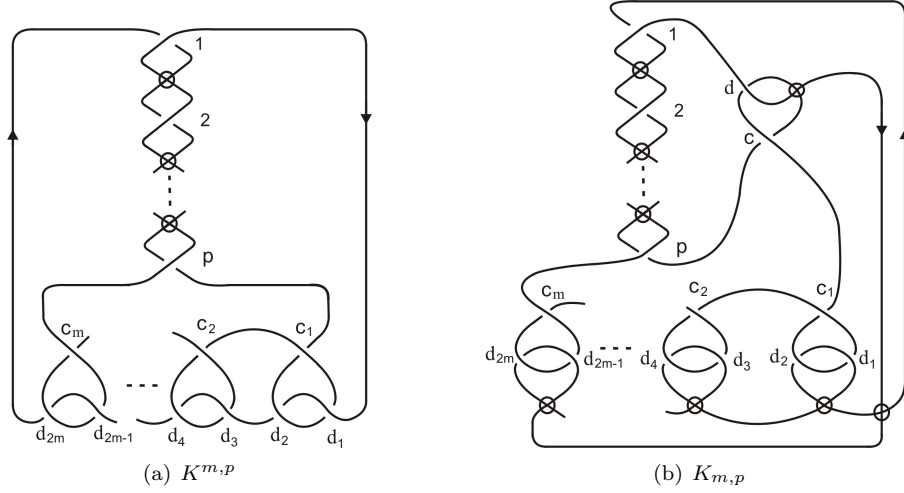
 FIGURE 4. Virtual knot diagram $K^{m,p}$ and $K_{m,p}$.

Theorem 3.1. *For any positive integer m , there exists an infinite family of prime virtual knots with unknotting index $(0, m)$.*

Proof. To establish this result, we construct a virtual knot diagram $K^{m,p}$ as shown in Fig. 4(a), where m and $p \geq 2$ are positive integers. Let c_1, c_2, \dots, c_m and d_1, \dots, d_{2m} denote the classical crossings as shown in the diagram $K^{m,p}$. Then the index values of these crossings are given as

$$\begin{aligned} \text{Ind}(c_i) &= 0, \text{ for } i = 1, 2, \dots, m, \\ \text{Ind}(d_i) &= \begin{cases} p-1, & \text{for } i = 1, 3, \dots, 2m-1, \\ -(p-1), & \text{for } i = 2, 4, \dots, 2m. \end{cases} \end{aligned}$$

The index value of the classical crossings in the vertical block of $K^{m,p}$ is

$$\text{Ind}(1) = \text{Ind}(2) = \dots = \text{Ind}(p) = 0.$$

The sign value of all the classical crossings in $K^{m,p}$ except c_i crossings is (-1) and $\text{sgn}(c_i) = +1$ for $i = 1, 2, \dots, m$. Since $p \geq 2$, $1 - p \neq 0$. Therefore, the writhe invariants $J_{(p-1)}$ and $J_{(1-p)}$ are given by

$$J_{(p-1)}(K^{m,p}) = \sum_{i=1}^m \text{sgn}(d_{2i-1}) = -m \quad \text{and} \quad J_{-(p-1)}(K^{m,p}) = \sum_{i=1}^m \text{sgn}(d_{2i}) = -m.$$

By using Proposition 2.1(b), we have

$$(2) \quad U(K^{m,p}) \geq (0, \frac{1}{2}|J_{(p-1)}(K^{m,p})| + \frac{1}{2}|J_{(1-p)}(K^{m,p})|) = (0, m).$$

Also by applying crossing change operations at d_2, d_4, \dots, d_{2m} crossings, the resulting diagram becomes a trivial knot diagram as shown in Fig. 5. Therefore,

$$(3) \quad U(K^{m,p}) \leq (0, m).$$

Evidently, Eq. 2 and Eq. 3 implies $U(K^{m,p}) = (0, m)$.

Observe that for different integers $p_1, p_2 \geq 2$,

$$J_{p_1-1}(K^{m,p_1}) = J_{p_2-1}(K^{m,p_2}) = -m,$$

$$\text{and } J_{p_1-1}(K^{m,p_2}) = J_{p_2-1}(K^{m,p_1}) = 0.$$

Since the n -th writhe is a virtual knot invariant, K^{m,p_1} and K^{m,p_2} represent diagrams of two different virtual knots. Therefore, for a fixed value m , there are infinitely many positive integers $p \geq 2$ such that $U(K^{m,p}) = (0, m)$. Hence the result. \square

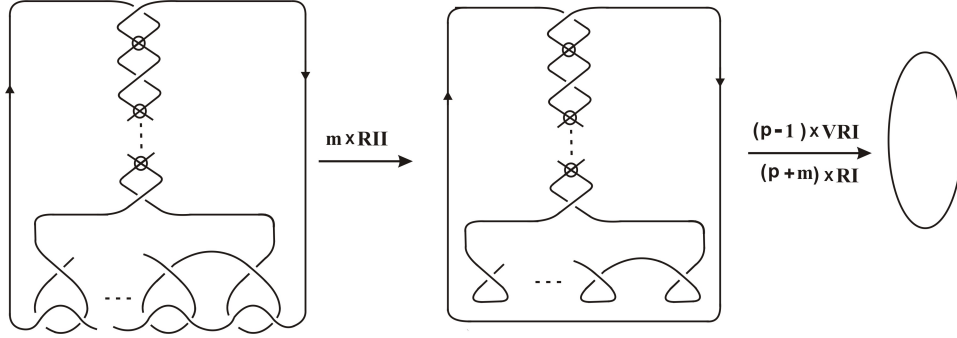

FIGURE 5

Theorem 3.2. *For given any positive integer m , there exist infinitely many prime virtual knots whose unknotting index is $(1, m)$.*

Proof. To establish this result, we construct a virtual knot diagram $K_{m,p}$ as shown in Fig. 4(b), where m and $p \geq 5$ are positive integers.

Observe that by virtualizing crossing d followed by crossing change operations at d_2, d_4, \dots, d_{2m} crossings, we get a diagram of the trivial knot as shown in Fig. 6. Hence

$$(4) \quad U(K_{m,p}) \leq (1, m).$$

Now we have to find the lower bound on $U(K_{m,p})$. Let c, c_1, c_2, \dots, c_m and d, d_1, \dots, d_{2m} denote the crossings in $K_{m,p}$ as shown in Fig. 4(b). Then the index values of the crossings are

$$\text{Ind}(d) = p - 1, \quad \text{Ind}(c) = -1, \quad \text{and} \quad \text{Ind}(c_i) = 0, \quad \text{for } i = 1, 2, \dots, m,$$

$$\text{Ind}(d_i) = \begin{cases} p, & \text{for } i = 1, 3, \dots, 2m - 1, \\ -p, & \text{for } i = 2, 4, \dots, 2m. \end{cases}$$

The index value of the classical crossings in the vertical block of $K_{m,p}$ is one, *i.e.*,

$$\text{Ind}(1) = \text{Ind}(2) = \dots = \text{Ind}(p) = -1.$$

The sign value of all the classical crossings in $K_{m,p}$ except c_i crossings is (-1) and $\text{sgn}(c_i) = +1$ for $i = 1, 2, \dots, m$. Since $p \geq 5$, $p-1 \neq \pm p \neq -1$. Therefore,

$$(5) \quad J_{-1}(K_{m,p}) = \text{sgn}(c) + \sum_{i=k}^p \text{sgn}(k) = 1 - p, \quad J_{p-1}(K_{m,p}) = \text{sgn}(d) = -1,$$

$$J_{-p}(K_{m,p}) = \sum_{i=1}^m \text{sgn}(d_{2i}) = -m \quad \text{and} \quad J_p(K_{m,p}) = \sum_{i=1}^m \text{sgn}(d_{2i-1}) = -m.$$

It is evident that there is only one crossing, crossing d , with index value $(p-1)$ and no crossing with index value $-(p-1)$. Consequently, $J_{-(p-1)}(K_{m,p}) = 0$ and $J_{(p-1)}(K_{m,p}) \neq J_{-(p-1)}(K_{m,p})$. By using Proposition 2.1(a), we have $U(K) \geq (1, 0)$.

Let K' be a virtual knot diagram obtained from $K_{m,p}$ by virtualizing one crossing, say ξ . For convenience, we assume that labeling of crossings in the diagram K' remains same as the labeling in $K_{m,p}$. Sign of all the crossings in K' are same as the sign of the corresponding crossings in $K_{m,p}$.

Case 1. Suppose that $\xi = c_j, j \in \{1, 2, \dots, m\}$. Then the index values of all the classical crossings in K' except d_{2j-1} and d_{2j} remains same as in $K_{m,p}$, and $\text{Ind}(d_{2j-1}) = p+1 = -\text{Ind}(d_{2j})$. Since $p \geq 5$, $\pm(p+1) \neq \pm(p-1)$. Consequently, there is only one crossing, crossing d , with index value $(p-1)$ and no crossing having index value $-(p-1)$. Hence, $J_{-(p-1)}(K_{m,p}) = 0$ and $J_{(p-1)}(K_{m,p}) \neq J_{-(p-1)}(K_{m,p})$. By using Proposition 2.1(a), we have $U(K) \geq (1, 0)$ which implies $U(K_{m,p}) \geq (2, 0)$.

Case 2. Suppose that $\xi = c$. Then only the index value of the crossing d changes to $\text{Ind}(d) = p$. All other classical crossings in K' have the same index value as in $K_{m,p}$. Since $p \geq 5$, the writhe invariants of K' are given as,

$$J_{-1}(K') = \sum_{i=k}^p \text{sgn}(k) = -p, \quad J_{-p}(K') = \sum_{i=1}^m \text{sgn}(d_{2i}) = -m,$$

$$J_p(K') = \text{sgn}(d) + \sum_{i=1}^m \text{sgn}(d_{2i-1}) = -1 - m.$$

Clearly, $J_p(K') \neq J_{-p}(K')$. By using Proposition 2.1(a), we have $U(K') \geq (1, 0)$ which implies $U(K_{m,p}) \geq (2, 0)$.

Case 3. Suppose that $\xi = j$, where $j \in \{1, 2, \dots, p\}$. Then the index values of the classical crossings of K' are

$$\text{Ind}(1) = \dots = \text{Ind}(j-1) = \text{Ind}(j+1) = \dots = \text{Ind}(p) = \text{Ind}(c) = -1,$$

$$\text{Ind}(d) = p-2, \quad \text{and} \quad \text{Ind}(c_i) = 0, \quad \text{for } i = 1, 2, \dots, m,$$

$$\text{Ind}(d_i) = \begin{cases} (p-1), & \text{for } i = 1, 3, \dots, 2m-1, \\ -(p-1), & \text{for } i = 2, 4, \dots, 2m. \end{cases}$$

Since $p \geq 5$, $p - 2 \neq \pm(p - 1) \neq -1$. Consequently, there is only one crossing, crossing d , in K' having index value $(p - 2)$ and no other crossing have index value $\pm(p - 2)$. Hence, $J_{p-2}(K') = \text{sgn}(d) = -1$ and $J_{-(p-2)}(K') = 0$. By using Proposition 2.1(a), we have $U(K') \geq (1, 0)$ which implies $U(K_{m,p}) \geq (2, 0)$.

Case 4. Suppose that $\xi = d_{2i}$, for $i \in \{1, 2, \dots, m\}$. Then

$$\text{Ind}(c) = \text{Ind}(c_i) = -1, \text{Ind}(d) = p - 2, \text{ and } \text{Ind}(1) = \text{Ind}(2) = \dots = \text{Ind}(p) = -2.$$

All other classical crossings in K' have the same index value as in $K_{m,p}$. It is evident that, $\pm(p - 2) \neq -2 \neq -1$ as $p \geq 5$. Consequently, there is only one crossing, crossing d , in K' having index value $p - 2$ and there is no crossing having index $-(p - 2)$. Therefore, $J_{(p-2)}(K') = -\text{sgn}(d) = -1$ and $J_{-(p-2)}(K') = 0$. By using Proposition 2.1(a), we have $U(K') \geq (1, 0)$ which implies $U(K_{m,p}) \geq (2, 0)$.

Case 5. Suppose that $\xi = d_{2i-1}$, for $i \in \{1, 2, \dots, m\}$. Then

$$\text{Ind}(c) = -1, \text{Ind}(c_i) = 1, \text{Ind}(d) = p, \text{ and } \text{Ind}(1) = \text{Ind}(2) = \dots = \text{Ind}(p) = 0.$$

All other classical crossings in K' have the same index values as in $K_{m,p}$. The writhe invariants of K' ,

$$J_{-1}(K') = \text{sgn}(c) = 1, \quad J_1(K') = \text{sgn}(c_i) = 1, \quad J_{-p}(K') = \sum_{j=1}^m \text{sgn}(d_{2j}) = -m,$$

$$\text{and } J_p(K') = \text{sgn}(d) + \sum_{i \neq j=1}^m \text{sgn}(d_{2j-1}) = -1 - (m - 1) = -m.$$

By using Proposition 2.1(b), we have

$$U(K') \geq \left(0, \frac{1}{2}|J_p(K')| + \frac{1}{2}|J_{-p}(K')| + \frac{1}{2}|J_1(K')| + \frac{1}{2}|J_{-1}(K')|\right) = (0, m + 1).$$

Thus $U(K_{m,p}) \geq (1, m + 1)$.

Case 6. Suppose that $\xi = d$. Then

$$\text{Ind}(c) = \text{Ind}(c_i) = \text{Ind}(k) = 0, \text{ where } i = 1, 2, \dots, m, \text{ and } k = 1, 2, \dots, p,$$

$$\text{Ind}(d_i) = \begin{cases} 1 - p, & \text{for } i = 2, 4, \dots, 2m, \\ -(1 - p), & \text{for } i = 1, 3, \dots, 2m - 1. \end{cases}$$

The writhe invariants of K' are given as

$$J_{1-p}(K') = \sum_{j=1}^m \text{sgn}(d_{2j}) = -m, \quad J_{p-1}(K') = \sum_{j=1}^m \text{sgn}(d_{2j-1}) = -m.$$

By using Proposition 2.1(b), we have

$$U(K') \geq \left(0, \frac{1}{2}|J_{p-1}(K')| + \frac{1}{2}|J_{1-p}(K')|\right) = (0, m).$$

Hence $U(K_{m,p}) \geq (1, m)$.

Using Eq. 4 and Case 6, we have $(1, m) \geq U(K_{m,p}) \geq (1, m)$. Hence $U(K_{m,p}) = (1, m)$.

Consider two distinct integers $p_1, p_2 \geq 5$. Then from Eq. 5, we have $J_{(-1)}(K_{m,p_1}) = (1 - p_1) \neq -(1 - p_2) = J_{(-1)}(K_{m,p_2})$. Since the n -th writhe is a virtual knot invariant,

K_{m,p_1} and K_{m,p_2} represent diagrams of two distinct virtual knots. Thus for a fixed value m , there exists infinitely many integers $p \geq 5$ such that $U(K_{m,p}) = (1, m)$. This establishes the result. □

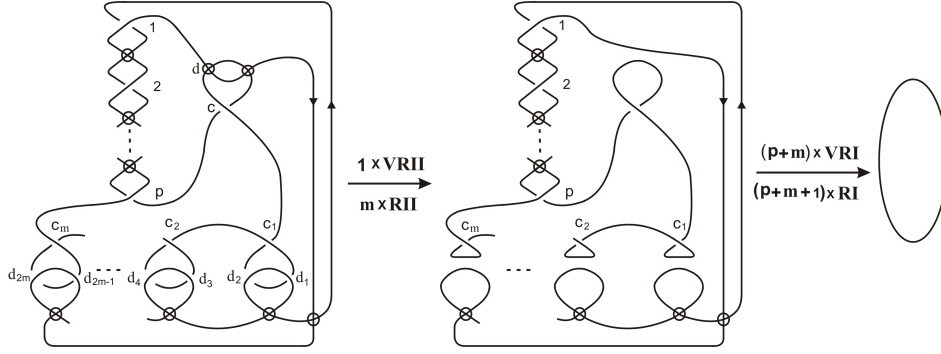

FIGURE 6

To show the existence of virtual knots with unknotting index (n, m) , we use the concept of composite knots. However, simply taking compositions of $K_{m,p}$ or $K^{m,p}$ virtual knot diagrams is insufficient to prove the result. For instance, using Theorem 3.1, and Theorem 3.2 it is evident that construction of any virtual knot with a composition of these virtual knots such that the unknotting index is $(n, 1)$ is impossible. In order to establish the main result, first we construct a class of virtual knot diagrams and define few notations.

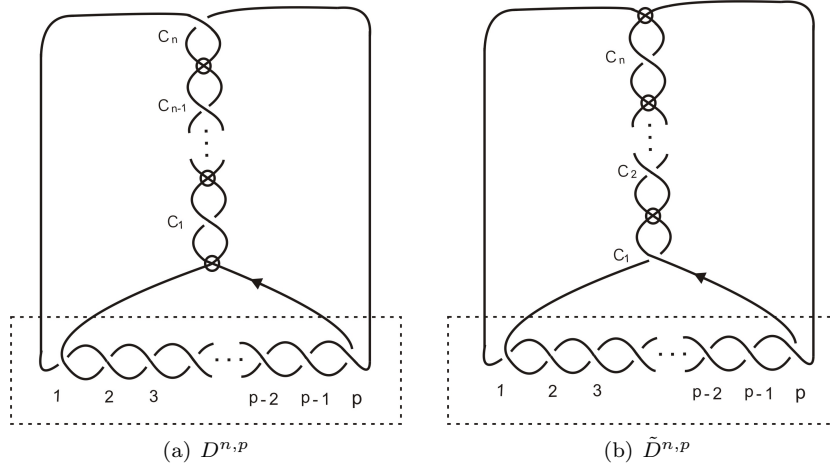

FIGURE 7. Virtual knot diagrams $D^{n,p}$ and $\tilde{D}^{n,p}$.

Construct virtual knot diagrams denoted by $D^{n,p}$ and $\tilde{D}^{n,p}$ with n number of virtual crossings as shown in Fig. 7(a) and 7(b), respectively. Here, we discuss the

unknotting index for a special class of virtual knots that are obtained by virtualizing some m number of classical crossings in $D^{n,p}$ and $\tilde{D}^{n,p}$. In particular, due to similarity in $D^{n,p}$ and $\tilde{D}^{n,p}$, we discuss only the class of virtual knots that are obtained from $D^{n,p}$. We label the crossings of $D^{n,p}$ and $\tilde{D}^{n,p}$ that are shown in the respective rectangular boxes in Fig. 7 with integers. We denote these crossings as horizontal block crossings. For convenience, whenever we virtualize some crossings in $D^{n,p}$ and $\tilde{D}^{n,p}$, labeling in the resulting diagram remains same. We denote $D_{q,r}^{n,p}$ as a virtual knot diagram obtained from $D^{n,p}$ by virtualizing q crossings at odd labelings and r crossings at even labelings in the horizontal block.

Lemma 3.1. *If D is a virtual knot diagram $D_{q,r}^{n,p}$ with odd p , then whenever $q-r > 2$ or $q-r < 0$, there exist at least one $k \in \mathbb{Z} \setminus \{0\}$ such that $J_k(D) = -1$ and $J_{-k}(D) = 0$.*

Proof. Let D be a virtual knot diagram $D_{q,r}^{n,p}$, where p is an odd natural number. Then the index value of the classical crossings in the horizontal block of D corresponds to odd and even labelings is $(-n)$ and n , respectively. Let c_1, c_2, \dots, c_n denote the classical crossings of D corresponding to c_i crossings of $D^{n,p}$ as shown in Fig. 7(a). Then

$$\text{Ind}(c_i) = (2i - n - q + r), \text{ for } i = 1, 2, \dots, n, \text{ and}$$

$$\text{Ind}(c_i) = -\text{Ind}(c_j) \text{ if and only if } i + j = n + q - r.$$

It is evident that all the c_i crossings in D have distinct index values.

If $q-r > 2$, then $\text{Ind}(c_1) = 2 - n - (q-r) < -n$.

Assume that there exist some $i \in \{2, 3, \dots, n\}$ such that $\text{Ind}(c_1) = -\text{Ind}(c_i)$. This implies that $i = n + q - r - 1$. As $q-r > 2$, we have $i = n + q - r - 1 > n + 1$, which is a contradiction to the fact that $i \leq n$. Consequently, there is no crossing other than c_1 in D , whose index value is $\pm \text{Ind}(c_1)$. Thus, for $k = \text{Ind}(c_1)$, we have

$$J_k(D) = \text{sgn}(c_1) = -1 \text{ and } J_{-k}(D) = 0.$$

If $q-r < 0$, then $\text{Ind}(c_n) = n - (q-r) > n$.

Assume that there exist some $i \in \{2, 3, \dots, n\}$ such that $\text{Ind}(c_n) = -\text{Ind}(c_i)$. This implies that $i = q - r < 0$, which is a contradiction to the fact that $i \geq 1$. Consequently, there is no crossing other than c_n in D , whose index value is $\pm \text{Ind}(c_n)$. Therefore, for $k = \text{Ind}(c_n)$, we have

$$J_k(D) = \text{sgn}(c_n) = -1 \text{ and } J_{-k}(D) = 0.$$

Hence the desired result. \square

Theorem 3.3. *If D is a diagram of a virtual knot K , that is obtained by virtualizing $m = q + r$ number of classical crossings in the horizontal block of $D^{n,p}$, see Fig. 7(a), where p is an odd positive integer, and q and r are the number of crossings virtualized at odd and even labelings, respectively, then*

$$U(K) = \begin{cases} \left(r - q, \left\lfloor \frac{p+n-2r}{2} \right\rfloor \right), & \text{if } -n < q-r < 0, \\ \left(0, \left\lfloor \frac{p+n-m}{2} \right\rfloor \right), & \text{if } 0 \leq q-r \leq 2, \\ \left(q-r-2, \left\lfloor \frac{p+n-2q+2}{2} \right\rfloor \right), & \text{if } 2 < q-r < n+2, \\ (n, 0), & \text{Otherwise.} \end{cases}$$

Proof. Let D be a virtual knot diagram of a virtual knot K that is obtained by virtualizing $q + r$ number of classical crossings in the horizontal block of $D^{n,p}$ with odd p as shown in Fig. 7(a), where q and r are the number of crossings virtualized at odd and even labelings, respectively. Observe that D is exactly the virtual knot diagram $D_{q,r}^{n,p}$. Let c_1, c_2, \dots, c_n denote the classical crossings of D corresponding to c_i crossings of $D^{n,p}$ as shown in Fig. 7(a). Then

$$\text{Ind}(c_i) = (2i - n - q + r), \text{ for } i = 1, 2, \dots, n, \quad \text{and,}$$

$$\text{Ind}(c_i) = -\text{Ind}(c_j) \text{ if and only if } i + j = n + q - r.$$

The index value of the classical crossings in the horizontal block of D corresponds to odd and even labelings is $(-n)$ and n , respectively.

With these observations, we first prove the result for $0 \leq q - r \leq 2$.

The total number of classical crossings in D are $p + n - m$. When $p + n - m$ is even, then all classical crossings in D have non-zero *index*. Otherwise, there exist only one crossing in D whose *index* value is zero. Since sign of each crossing in D is -1 ,

$$\sum_{k \neq 0} |J_k(D)/2| = \left\lfloor \frac{p + n - m}{2} \right\rfloor.$$

Hence by using Proposition 2.1(b), we have

$$(6) \quad U(K) \geq \left(0, \left\lfloor \frac{p + n - m}{2} \right\rfloor\right).$$

Applying crossing change operation at all the crossings in the horizontal block labeled with even integers and at $c_n, c_{n-1}, \dots, c_{\lfloor \frac{n+2}{2} \rfloor}$, if $q - r = 0$, or at $c_1, c_2, \dots, c_{\lfloor \frac{n}{2} \rfloor}$, if $q - r = 1$, or at $c_n, c_{n-1}, \dots, c_{\lfloor \frac{n+4}{2} \rfloor}$, if $q - r = 2$. Then the resulting diagram is a diagram of the trivial knot and the total number of crossing changes is equal to $\left\lfloor \frac{p+n-m}{2} \right\rfloor$. Hence

$$(7) \quad U(K) \leq \left(0, \left\lfloor \frac{p + n - m}{2} \right\rfloor\right)$$

Eq. 6 and Eq. 7 implies that,

$$U(K) = \left(0, \left\lfloor \frac{p + n - m}{2} \right\rfloor\right).$$

When $2 < q - r < n + 2$, it is evident that by Lemma 3.1 and Proposition 2.1(a), we have $U(K) \geq (1, 0)$. Hence virtualization is required to deform D into the trivial knot.

Let D' be the diagram obtained from D by virtualizing $t = n_1 + q_1 + r_1$ number of crossings, where n_1, q_1 and r_1 be the number of c'_i s, odd labeling and even labeling crossings that are virtualized in D . Then D' is equivalent to the virtual knot diagram $D_{q',r'}^{n',p}$, where $n' = n - n_1, q' = q + q_1$ and $r' = r + r_1$.

If $t < q - r - 2$, then $n_1 + 2q_1 + 2 < (q + q_1) - (r + r_1)$, i.e., $2 < q' - r'$. If $t = q - r - 2$ and $q' - r' \neq 2$, then also $q' - r' > 2$.

By Lemma 3.1, there exist at least one k such that $J_k(D') = -1$ and $J_{-k}(D') = 0$. From Proposition 2.1(a) and Remark 2.1, the flat projection of D' is non-trivial. In case $t = q - r - 2$ and $q' - r' = 2$, there are $p + n - 2q + 2$ number of classical crossings in D' and

$$\sum_{k \neq 0} |J_k(D')/2| = \left\lfloor \frac{p + n - 2q + 2}{2} \right\rfloor \text{ (as in the case } 0 \leq q - r \leq 2\text{)}.$$

Therefore, we have

$$(8) \quad U(K) \geq \left(q - r - 2, \left\lfloor \frac{p + n - 2q + 2}{2} \right\rfloor \right).$$

For the reverse inequality, virtualize $q - r - 2$ number of crossings labeled with even integers in the horizontal block of D . Then in the resulting diagram D' , we have $q' - r' = 2$, and hence D' satisfies the condition $0 \leq q' - r' \leq 2$. Therefore, $U(D') = \left(0, \left\lfloor \frac{p + n - 2q + 2}{2} \right\rfloor \right)$ and hence

$$(9) \quad U(K) \leq \left(q - r - 2, \left\lfloor \frac{p + n - 2q + 2}{2} \right\rfloor \right).$$

Eq. 8 and Eq.9 implies

$$U(K) = \left(q - r - 2, \left\lfloor \frac{p + n - 2q + 2}{2} \right\rfloor \right).$$

In the case when $q - r \geq n + 2$ or $q - r \leq -n$, observe that either $q - r > 2$ or $q - r < 0$.

By Lemma 3.1 and Proposition 2.1(a), we have $U(K) \geq (1, 0)$.

Observe that by virtualizing c_1, c_2, \dots, c_n crossings in D , the resulting diagram becomes a diagram of the trivial knot. Thus

$$(10) \quad U(K) \leq (n, 0).$$

Now we prove that, by virtualizing less than n number of crossings in D , the flat virtual knot corresponding to the resulting virtual knot is always non-trivial.

Let D' be the diagram obtained from D by virtualizing $t = n_1 + q_1 + r_1$ number of crossings, where n_1, q_1 , and r_1 be the number of c'_i s, odd labeling and even labeling crossings that are virtualized in D , respectively. Then D' is equivalent to the virtual knot diagram $D'_{q', r'}$, where $n' = n - n_1, q' = q + q_1$ and $r' = r + r_1$.

If $q - r \geq n + 2$ and $t < n$, then $t < n \leq q - r - 2$ and hence $2 < q' - r'$.

If $q - r \leq -n$ and $t < n$, then $t < n \leq r - q$ and hence $q' - r' < 0$. In both the cases, by Lemma 3.1 and Proposition 2.1(a), the flat projection of D' is non-trivial. Therefore, $U(K) \geq (n, 0)$ and hence by Eq. 10, we have

$$U(K) = (n, 0).$$

In case when $-n < q - r < 0$, we use similar arguments as given the case of $2 < q - r < n + 2$ of Theorem 3.3, to conclude

$$U(K) = (r - q, \left\lfloor \frac{p + n - 2r}{2} \right\rfloor).$$

Hence the proof of the theorem. \square

Remark 3.1. If D is a virtual knot diagram obtained from $D^{n,p}$ (or $\tilde{D}^{n-1,p}$) by virtualizing some c_j , $1 \leq j \leq n$, crossing, then D is equivalent to D^{n-1} (or $\tilde{D}^{n-1,p}$). Thus, using Theorem 3.3, we can find unknotting index of any virtual knot obtained by virtualizing some crossings in $D^{n,p}$ (or $\tilde{D}^{n,p}$).

Lemma 3.2. *If a diagram D of a virtual knot K satisfies the following two conditions*

- (a) whenever $\text{Ind}(c_i) = \text{Ind}(c_j)$, then $\text{sgn}(c_i) = \text{sgn}(c_j)$, for any $c_i, c_j \in \mathcal{C}(D)$,
and
- (b) $\text{Ind}(c) \neq 0$, for any $c \in \mathcal{C}(D)$,

then D is a diagram of K with minimum number of classical crossings.

Proof. Let D a diagram of virtual knot K satisfying the two conditions given in the hypothesis. To establish that D is a diagram with minimum number of classical crossings, it is enough to show that $\sum_k |J_k(D)| = |\mathcal{C}(D)|$.

Let $C_k(D) = \{c \in \mathcal{C}(D) | \text{Ind}(c) = k\}$, for an integer $k \neq 0$. Since number of crossings in D are finite, there exist $N \in \mathbb{N}$ such that $|\text{Ind}(c)| \leq N$, for all $c \in \mathcal{C}(D)$.

This implies that there exists only finitely many $C_k(D)$, which are subsets of $\mathcal{C}(D)$. Since index value of a crossing is unique and there is no crossing with index zero,

$$(11) \quad C_k(D) \cap C_l(D) = \emptyset, \text{ for } k \neq l \quad \text{and hence} \quad \mathcal{C}(D) = \cup_k C_k(D).$$

By hypothesis, since crossings of same *index* have same sign in D , we have

$$(12) \quad |J_k(D)| = \left| \sum_{\text{Ind}(c)=k} \text{sgn}(c) \right| = |C_k(D)|.$$

Eq. 11 and Eq. 12 implies that

$$(13) \quad \sum_k |J_k(D)| = \sum_k |C_k(D)| = |\mathcal{C}(D)|.$$

Observe that, if D' is any diagram that is equivalent to D with m number of classical crossings, then

$$(14) \quad \sum_{k \neq 0} |J_k(D')| \leq \sum_{k \neq 0} \left(\sum_{\text{Ind}(c)=k} |\text{sgn}(c)| \right) = \sum_{k \neq 0} |C_k(D')| \leq |\mathcal{C}(D')| = m,$$

since the index value of each crossing is unique. As the n -th writhe is a virtual knot invariant, from eq (13) and eq (14), we have

$$|\mathcal{C}(D)| = \sum_k |J_k(D)| = \sum_{k \neq 0} |J_k(D')| \leq m.$$

Hence the number of crossings in any diagram which is equivalent to D , are at least $|\mathcal{C}(D)|$. Thus D is a diagram of K with minimum number of classical crossings. \square

Before proving the Theorem 3.4, we define $D_{q,r,t}^{n,p,m}$ as a virtual knot diagram obtained from the diagram $D^{n,p,m}$ as shown in Fig. 8(a) by virtualizing $q + r + t$ number of crossings, where t, q, r are the number of d'_i s crossing, odd and even labeling crossings in the horizontal block, respectively. It is evident that for $m = 0$, $D^{n,p,m}$ is the virtual knot diagram $D^{n,p}$ as shown in Fig. 7.

Theorem 3.4. *For any $n, m \in \mathbb{N}$, there exist an infinite family of virtual knots with unknotting index (n, m) .*

Proof. Let $n, m \in \mathbb{N}$. Consider $q \in \mathbb{N}$ and p be any odd integer such that $p > q > n + 2$. Construct a virtual knot diagram D from the diagram $D^{n,p,m}$ given in Fig. 8(a), by virtualizing q crossings with odd labelings in the horizontal block. For our convenience, labeling of crossing in D remains same as in the diagram $D^{n,p,m}$ shown in Fig. 8(a). Then the *index values* of the crossings c_1, c_2, \dots, c_n and d_1, d_2, \dots, d_{2m} in the diagram D are given as,

$$\text{Ind}(c_i) = 2i - n - q, \text{ for } i = 1, 2, \dots, n,$$

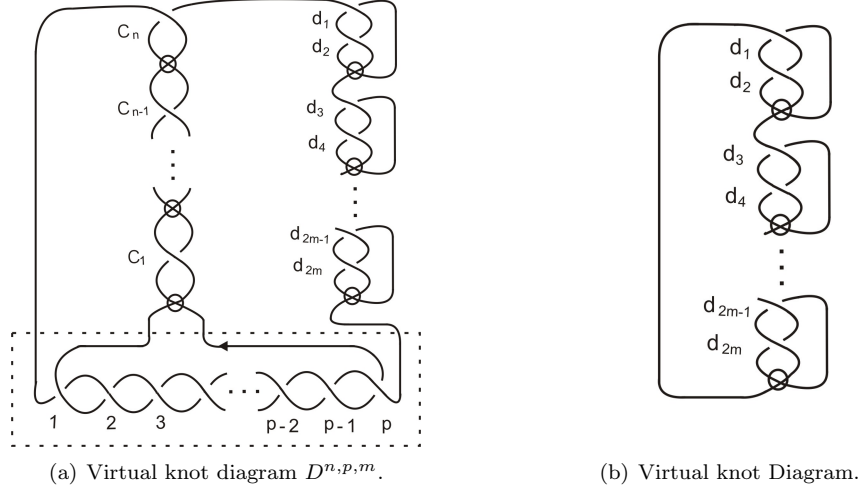

FIGURE 8

and $\text{Ind}(d_j) = (-1)^{j+1}$, for $j = 1, 2, \dots, 2m$.

The *index values* of the crossings of D in the horizontal block corresponding to odd and even labelings are $(-n)$ and n , respectively. It is evident that the flat projection \overline{D} of D is equivalent to the flat projection of the diagram $D_{q,0}^{n,p}$, which is non-trivial by Lemma 3.1, Proposition 2.1(a) and Remark 2.1. Hence \overline{D} is non-trivial and by Remark 2.1, $U(K) > (1, 0)$, where K is the virtual knot corresponding to diagram D . Therefore, virtualization is required to deform D to a trivial knot diagram.

Let K' be the virtual knot presented by a diagram D' which is obtained from D by virtualizing $s = n_1 + t + q_1 + r_1$ number of crossings, where n_1, t, q_1 and r_1 be the number of c'_i 's, d'_i 's, odd labeling and even labeling crossings that are virtualized in D , respectively.

If $n_1 < n$ and $s \leq n$, then $-r_1 \geq n_1 + q_1 + t - n$. As $q > n + 2$ is given, therefore

$$\begin{aligned} (q + q_1) - r_1 &> (n + 2) + q_1 - r_1 \\ &\geq (n + 2) + q_1 + (n_1 + q_1 + t - n) \\ &= 2 + 2q_1 + t + n_1 \geq 2. \end{aligned}$$

it is evident that the flat projection $\overline{D'}$ of D' is equivalent to the flat projection of $D_{q',r'}^{n',p}$ with $q' - r' > 2$, where $q' = q + q_1, r' = r_1$ and $n' = n + n_1$. By Lemma 3.1, Proposition 2.1 and Remark 2.1, the flat projection of $D_{q',r'}^{n',p}$ is non-trivial and hence $\overline{D'}$ is a non-trivial flat projection. Again by Lemma 2.1, $U(K') \geq (1, 0)$ which implies $U(K) \geq (n + 1, 0)$.

When $n_1 = n$, the diagram D' is equivalent to the diagram shown in Fig. 8(b). Thus, $\sum_{k \neq 0} |J_k(D')| = 2m$ and the flat projection of $\overline{D'}$ of D' is equivalent to the flat

projection of the diagram shown in Fig. 8(b) which is trivial. Hence $\overline{D'}$ is a trivial flat projection. By using Remark 2.1 and Proposition 2.1, we have

$$(15) \quad U(K') \geq (0, m), \quad \text{which implies} \quad U(K) \geq (n, m).$$

To obtain the upper bound, virtualize crossings c_1, c_2, \dots, c_n , and apply crossing change operations at crossings d_2, d_4, \dots, d_{2m} in D' . Then the resulting diagram is a diagram of the trivial knot, see Fig. 9, and hence

$$(16) \quad U(K) \leq (n, m).$$

Eq. 15 and Eq. 16 implies that $U(K) = (n, m)$.

Observe that, the crossings of D are of same sign and having non-zero index, by Lemma 3.2, D is a diagram of K having minimum number of classical crossings. Consider odd positive integers $p_1 \neq p_2$, satisfying $p_1 > q > n+2$ and $p_2 > q > n+2$. Let $D_i, i \in \{1, 2\}$ be the virtual knot diagram obtained from $D^{n, p_i, m}, i \in \{1, 2\}$ by virtualizing q number of crossing labeled with odd integers in the horizontal block. Clearly, the unknotting index of virtual knot K_i corresponding to diagram $D_i, i \in \{1, 2\}$ is (n, m) . Observe that, D_i is a diagram of K_i having minimum number of classical crossings. The total number of classical crossings in D_i is $(n + 2m + p_i - q)$. Since $n + 2m + p_1 - q \neq n + 2m + p_2 - q$, virtual knots corresponding to D_1 and D_2 are not equivalent.

For fixed $n, m \in \mathbb{N}$ and any $q > n + 2$, there exists infinitely many odd integers p satisfying $p > q > n + 2$. Hence, there exists infinitely many virtual knots with unknotting index (n, m) . \square

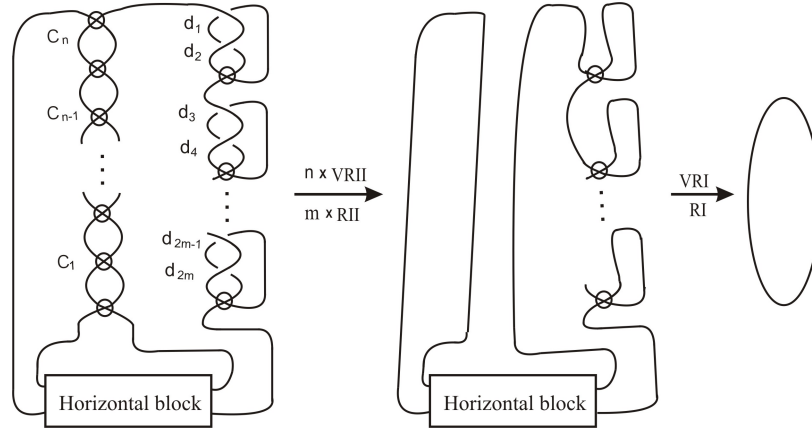

FIGURE 9. A diagram of the trivial knot.

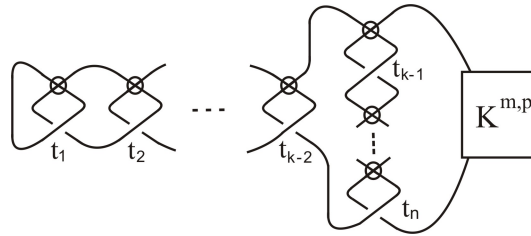

FIGURE 10. Virtual link diagram $D = D_1 \cup D_2 \cup \dots \cup D_k$.

Proposition 3.1. *For any pair (n, m) of positive integers, there exists infinitely many k -component virtual links.*

Proof. We prove this result by considering the two cases $k \leq n$ and $k > n$.

Case 1. Suppose that $k \leq n$. Consider a virtual link L presented by diagram $D = D_1 \cup D_2 \cup \dots \cup D_k$ as shown in Fig. 10. Let t_1, t_2, \dots, t_n be the linking crossings of D as shown in Fig. 10. It is easy to see that there is no linking crossing between D_i and D_j when $j \neq i + 1$. For $1 \leq i \leq k - 2$, there is only one linking crossing, crossing t_i , between D_i and D_{i+1} . While t_{k-1}, t_k, \dots, t_n are linking crossings between D_{k-1} and D_k . Thus the span value of the diagram D is given as

$$\begin{aligned} \text{span}(D) &= \sum_{i \neq j} \text{span}(D_i \cup D_j) = \sum_{i=1}^{k-1} \text{span}(D_i \cup D_{i+1}) \\ &= \sum_{i=1}^{k-2} \text{span}(D_i \cup D_{i+1}) + \text{span}(D_{k-1} \cup D_k) = \left(\sum_{i=1}^{k-2} 1 \right) + (n - k + 2) = n. \end{aligned}$$

By using Theorem 2.1, minimum n number of virtualizations are required to deform D into the trivial link. These n virtualizations must be at linking crossings. Since there are exactly n linking crossings in the diagram D , it is evident that $\sum_{i \neq j} \ell_{D_i \cup D_j} = 0$. By using Theorem 2.1 and Theorem 3.1, we have

$$\begin{aligned} (17) \quad U(L) &\geq \left(\text{span}(D), \sum_{i \neq j} \ell_{D_i \cup D_j} + \frac{1}{2} \sum_{i=1}^n \sum_{k \in \mathbb{Z} \setminus \{0\}} |J_k(D_i)| \right) \\ &= \left(n, 0 + \frac{1}{2} \sum_{k \in \mathbb{Z} \setminus \{0\}} |J_k(K^{m,p})| \right) = (n, m). \end{aligned}$$

For upper bound, by virtualizing all linking crossings in D followed by crossing change operations at d_2, d_4, \dots, d_{2m} crossings of $K^{m,p}$, the resulting diagram becomes a diagram of the trivial link. Hence

$$(18) \quad U(D) \leq (n, m).$$

Eq. 17 and Eq. 18 implies that $U(D) = (n, m)$.

As discussed in the proof of Theorem 3.1 that the virtual knot diagrams $K^{m,p}$ for different values of $p \geq 2$, represent non-equivalent virtual knots. Thus different values of $p \geq 2$, yields distinct k -component virtual links whose unknotting index is (n, m) .

Case 2. Suppose that $k > n$. Take any k' such that $k' \leq n$. Then the result holds for k' as discussed in *Case 1* of Proposition 3.1. Let L' be the k' -component link with unknotting index (n, m) as shown in Fig. 10. Consider a k -component link, say L , which is a disjoint union of L' and $(k - k')$ trivial knots. Thus L is our desired k -component link. Hence the proof of the result. \square

4. CONCLUSION

This paper addresses the problem posed by A. Kaur et al. in [13] regarding the existence of virtual knots with unknotting index (n, m) . We establish the infinite

families of virtual knots with unknotting index (n, m) for any given pair of non-negative integers $(n; m)$, and extend the findings to virtual links as well. Specifically, for pairs $(0, m)$ and $(1, m)$, we construct infinitely many prime virtual knots with unknotting index $(0, m)$ and $(1, m)$ respectively. It would be interesting to find a family of prime virtual knots with unknotting index (n, m) .

5. ACKNOWLEDGMENT

The authors would like to thank Prof. Jitender Singh for his remarks and suggestions during the preparation of this paper. First author was supported by National Board of Higher Mathematics (NBHM)(Ref. No. 0204/16(11)/2022/R&D-II/11983), Government of India. Second author acknowledges the support given by the Science and Engineering Board (SERB), Department of Science and Technology, Government of India Under the Mathematical Research Impact Centric Support (MATRICS) grant-in-aid with F.No.MTR/2021/00394 and by the NBHM, Government of India under grant-in-aid with F.No.02011/2/20223NBHM(R.P.)/R&D II/970.

REFERENCES

- [1] Z. Cheng and H. Gao, A polynomial invariant of virtual links, *J. Knot Theory Ramifications* **22**(12) (2013) 1341002.
- [2] Z. Cheng, A polynomial invariant of virtual knots, *Proc. Amer. Math. Soc.* **142**(02) (2014) 713-725.
- [3] R. Fenn, R. Rimányi, and C. Rourke, The braid-permutation group, *Topology* **36**(01) (1997) 123-135.
- [4] L. C. Foltwaczny, L. H. Kauffman, A linking number definition of the affine index polynomial and applications, *J. Knot Theory Ramifications* **22**(12) (2013) 1341004.
- [5] A. Gill, K. Kaur and M. Prabhakar, Arc shift number and region arc shift number for virtual knots, *J. Korean Math. Soc.* **56**(04) (2019) 1063-1081.
- [6] M. Goussarov, M. Polyak and O. Viro, Finite type invariants of classical and virtual knots, *Topology* **39**(05) (2000) 1045-1068.
- [7] A. Henrich, A sequence of degree one Vassiliev invariants for virtual knots, *J. Knot Theory Ramifications* **19**(04) (2010) 461-487.
- [8] Y. H. Im, K. Lee, S. Y. Lee, Index polynomial invariant of virtual links, *J. Knot Theory Ramifications* **19**(05) (2010) 709-725.
- [9] M. Jeong, A zero polynomial of virtual knots, *J. Knot Theory Ramifications* **25**(01) (2016) 1550078.
- [10] T. Kanenobu, Forbidden moves unknot a virtual knot, *J. Knot Theory Ramifications* **10**(01) (2001) 89-96.
- [11] L. Kauffman, Virtual knot theory, *European J. Combin.* **20**(07) (1999) 663-690.
- [12] L. Kauffman, An affine index polynomial invariant of virtual knots, *J. Knot Theory Ramifications* **22**(04) (2013) 1340007.
- [13] K. Kaur, S. Kamada, A. Kawauchi and M. Prabhakar, An unknotting index for virtual knots, *Tokyo J. Math.* **42**(02) (2019) 357-370.
- [14] K. Kaur, M. Prabhakar and A. Vesnin, Two-variable polynomial invariants of virtual knots arising from at virtual knot invariants, *J. Knot Theory Ramifications* **27**(13) (2018) 1842015.
- [15] K. Kaur, A. Gill and M. Prabhakar, Arc shift number for some virtual knots, *Trends Math.* Birkhauser/Springer 2019.
- [16] K. Kaur, M. Prabhakar, A. Vesnin, An unknotting index for virtual links, *Topology Appl.* **264** (2019) 352-368.
- [17] A. Kawauchi, A survey of knot theory, *Birkhäuser Verlag, Basel* 1996.
- [18] Y. Miyazawa, A multi-variable polynomial invariant for virtual knots and links, *J. Knot Theory Ramifications* **17**(11) (2008) 1311-1326.
- [19] H. Murakami, Some metrics on classical knots, *Math. Ann.* **270**(01) (1985) 35-45.

- [20] H. Murakami and Y. Nakanishi, On a certain move generating link-homology, *Math. Ann.* **284**(01) (1989) 75–89.
- [21] S. Satoh, Crossing changes, delta moves, and sharp moves on welded knots, *Rocky Mountain J. Math.* **48**(03) (2018) 967–979.
- [22] S. Satoh and K. Taniguchi, The writhes of a virtual knot, *Fund. Math.* **225**(01) (2014) 327–342.
- [23] D. S. Silver and S. G. Williams, On a class of virtual knots with unit Jones polynomial, *J. Knot Theory Ramifications* **13**(03) (2004) 367–371.

DEPARTMENT OF MATHEMATICS, GURU NANAK DEV UNIVERSITY AMRITSAR, INDIA
Email address: kirandeeppofficial@gmail.com

DEPARTMENT OF MATHEMATICS, INDIAN INSTITUTE OF TECHNOLOGY ROPAR, INDIA
Email address: prabhakar@iitrpr.ac.in