

Model Evaluation and Anomaly Detection in Temporal Complex Networks using Deep Learning Methods

Alireza Rashnu, Sadegh Aliakbary*

Faculty of Computer Science and Engineering, Shahid Beheshti University, Tehran, Iran

ARTICLE INFO

Keywords:

Complex Network
Network Modeling
Graph Neural Network
Graph Comparison
Anomaly Detection
Deep learning

ABSTRACT

Modeling complex networks allows us to analyze the characteristics and discover the basic mechanisms governing phenomena such as disease outbreaks, information diffusion, transportation efficiency, social influence, and even human brain function. Consequently, various network generative models (called temporal network models) have been presented to model how the network topologies evolve dynamically over time. Temporal network models face the challenge of results evaluation because common evaluation methods are appropriate only for static networks. This paper proposes an automatic approach based on deep learning to handle this issue. In addition to an evaluation method, the proposed method can also be used for anomaly detection in evolving networks. The proposed method has been evaluated on five different datasets, and the evaluations show that it outperforms the alternative methods based on the error rate measure in different datasets.

1. Introduction

Complex network structures are ubiquitous in various real-world systems, ranging from social networks to biological systems and technological infrastructures [1]. Studying these networks has become increasingly important in recent years, as they can provide this opportunity to understand complex systems' behavior and dynamics [2]. In particular, the analysis of complex networks has been used to gain insights into a wide range of phenomena, including the spread of diseases [3] and the diffusion of information [4]. Network generation models are a powerful tool for understanding, analyzing, simulating, and designing complex systems that can be represented as networks. Network modeling plays a crucial role in helping us understand the intricate structure and organization of interconnected systems with the aim of understanding how the system functions and responds to different perturbations. By modeling the dynamics of complex systems, we can simulate and analyze how information, influence, or phenomena spread through the network like epidemics [5].

On the other hand, evaluating the output of network generative models can be difficult because there is no clear objective measure of what constitutes a "good" output. Unlike discriminative models, where the output can be evaluated based on its accuracy in predicting a known label or class, generative models are designed to create new data similar to the training data. This means that any specific criteria do not necessarily constrain the output of a generative model and can be highly subjective. Furthermore, generative models often produce probabilistic outputs, meaning that the same input can result in different outputs each time the model is executed. This makes it difficult to compare the output of a generative model to a ground truth dataset, as there may be multiple valid outputs for a given input. As a result, evaluating the output of generative models often requires a combination of quantitative and qualitative analysis and human judgment. Generally, researchers have used three approaches to evaluate the output of network generative models:

- 1) Statistical methods. The structural features of an artificial graph (such as the degree distribution, distribution of the clustering coefficient, and transitivity) and its real counterpart are compared [6-8].
- 2) Indirect assessment. A classification model is trained with real graphs and tested with generated graphs. If the artificial graph is similar to the target graph, the classification model gives a score of one; otherwise, a zero score is received [9].
- 3) Quality-based approach. The identical edges in the structure of the generated graph and the real graph are kept constant for model evaluation. In contrast, the other links of the synthetic graph nodes are changed randomly. In this case, if the statistical parameters of the synthetic graph, such as degree distribution, density, diameter, etc., do not change compared to the real graph, the generating model has shown good performance [10].

Although these methods are inherently designed for evaluating static graph generative models, some dynamic generative models have used them for model evaluation [11-15]. Dynamic networks change and therefore, evaluation methods designed for static networks may not be appropriate for dynamic

* Corresponding author. Tel.: +98-21-29904110

E-mail addresses: a.rashnou@mail.sbu.ac.ir (A. Rashnu), s_aliakbary@sbu.ac.ir (S. Aliakbary)

networks. For example, metrics that measure the centrality of nodes in a static network may not be useful for understanding the dynamics of a network over time because it will not necessarily have a fixed value.

Temporal networks, characterized by their evolving connections over time, introduce a layer of complexity beyond traditional static network models. Predicting node status within such dynamic contexts necessitates a nuanced understanding of how graph similarity, often explored in static settings, translates to temporal dynamics. Our research addresses this critical gap by elucidating the interconnectedness between graph similarity metrics and the evolving states of nodes in temporal networks. By leveraging insights from graph similarity learning, we discern patterns in temporal network dynamics that influence node status predictions. Our approach acknowledges the dynamic nature of real-world systems, where nodes interact and evolve over time, rendering traditional static analyses insufficient for capturing the full spectrum of network behaviors. Furthermore, our work recognizes the limitations of existing evaluation methods designed primarily for static graph generative models when applied to dynamic network settings.

In this paper, we consider the challenge of evaluating dynamic complex network generative models' output using different graph embedding mechanisms, recurrent neural networks (RNN), and fully connected layers. In other words, given the history of a dynamic network and a new snapshot, the proposed model called DGSP-GCN (Dynamic Graph Similarity Prediction based on Graph Convolutional Network) predicts how likely the hypothetical snapshot will be the future of the same temporal network. While it is true that DGSP-GCN leverages existing embedding methods, its contribution lies in the novel synthesis, customization, and application of these techniques within a unified framework tailored for dynamic graph node-level similarity prediction. Our experiments illustrate that the proposed model outperforms the baselines. The main contributions of this paper are as follows:

- 1) Using the attention mechanism in the representation of the node level to improve the embedding process;
- 2) Presenting a new automatic method based on deep learning to ameliorate the analysis and output evaluation of dynamic complex network generative models as well as anomaly detection in such structures.

The rest of this paper is organized as follows: Section 2 reviews the state-of-the-art graph similarity prediction models. In Section 3, the problem statement is presented. Section 4 illustrates our proposed method. Section 5 shows the experimental evaluations. Finally, section 6 concludes and explains the future works.

2. Literature review

In the vast realm of data analysis, understanding the unique attributes and relationships within complex structures has appeared as a paramount challenge. Within this context, graph similarity learning has emerged as an intriguing avenue, enabling researchers to uncover hidden correlations, discover underlying patterns, and extract valuable insights from interconnected data. The primary goal of graph similarity learning is to develop effective techniques that capture the inherent similarities and dissimilarities between graphs [16]. We can discern their structural, topological, and semantic characteristics by measuring the similarity between graphs. This holistic understanding allows us to categorize graphs more accurately, identify anomalies, and better understand their underlying dynamics [17]. For instance, in social network analysis, graph similarity learning can help identify communities or clusters of individuals with similar social connections. Moreover, graph similarity learning has applications in recommendation systems, which can be used to identify similar users or items based on their interconnected relations.

In summary, graph similarity learning is a vital tool in data analysis that allows us to unlock hidden insights, understand complex structures, and make informed decisions in various domains. Our work aims to reconcile the realms of graph similarity learning with the intricacies of temporal network dynamics, thereby shedding light on evolving system states and facilitating predictive insights into node behaviors. Generally, graph similarity learning approaches are divided into categories, including graph kernels, graph embedding methods, and graph neural networks (GNN). We will examine each one below.

2.1. Methods based on graph kernels

A graph kernel is a function that measures the similarity between two graphs by mapping them into a high-dimensional feature space. Graph kernels are commonly used in machine-learning tasks involving graph-structured data [18]. The basic idea behind graph kernels is to define a function that maps each graph into a vector of features that capture its structural properties. The similarity between the two graphs can then be computed as the inner product of their feature vectors in the high-dimensional space [19].

There are many different types of graph kernels, each with its strengths and weaknesses. Some popular graph kernels include the random walk kernel [20], the subtree kernel [21], and the neighborhood hash kernel [22]. The choice of kernel depends on the specific application and the properties of the graphs being analyzed. While graph kernel methods have many advantages, they also face several challenges that must be carefully considered when applying them to real-world problems [16]. Here are some of the main challenges:

- **Computational Complexity:** Graph kernel methods can be computationally expensive, especially for large graphs. Since these methods involve comparing graphs based on structural or topological properties, the computations can become time-consuming and resource-intensive as the size of the graphs increases. This can limit their scalability and efficiency in handling large-scale graph datasets.
- **Kernel Choosing:** There are many different types of graph kernels, each with its own strengths and weaknesses. Choosing the right kernel for a particular problem can be challenging, and there is often no clear best choice.
- **Sensitivity to Graph Representations:** Graph kernel methods heavily rely on the representations of graphs, such as node or edge labels, that are provided as input. Small changes or variations in these representations may lead to significantly different kernel values, affecting the similarity measures between graphs.

2.2. Graph embedding methods

Graph embedding methods for similarity are techniques used to represent graphs as low-dimensional vectors, which can be used to measure similarity between graphs. These methods aim to capture the structural and semantic information of the graph in the embedding space, such that similar graphs are mapped to nearby points in the embedding space. There are various graph embedding methods for similarity, including node and graph embedding methods. In the case of node embedding, the aim is a representation of each node to a vector by some methods like node2vec [23, 24], which can be aggregated to obtain an embedding for the entire graph [25]. Graph embedding methods aim to directly learn the representation of the entire graph by considering the graph structure like [26-28]. However, there are several challenges associated with graph embedding methods, including [17]:

- **Heterogeneity:** Graphs can be heterogeneous, containing different nodes and edges. Embedding methods need to handle this heterogeneity and capture the relationships between different types of nodes and edges.
- **Structure-oriented:** Although structural features such as node degree distribution, clustering coefficient distribution, number of triangles, network diameter, etc., are used to generate vectors at the node and graph levels, the node and edge level features are not considered for embedding.
- **Loss of Graph Structure Interpretability:** Embedding methods aim to represent graphs in low-dimensional vector spaces. While this enables numerical comparisons and similarity metrics, it can lead to a loss of interpretability in terms of the original graph structure. The transformed representations may not directly reveal the inherent graph properties and relationships, making comprehending the reasons behind similarity or dissimilarity scores challenging.

2.3. GNN-based methods

GNN methods are a class of machine learning techniques that have emerged as powerful tools for graph similarity prediction. By leveraging their ability to capture and learn from complex graph structures, GNNs offer a promising approach for comparing the similarity of different graphs. Through a series of iterative aggregation and transformation steps, GNNs can effectively encode the inherent structural properties of graphs into low-dimensional representations, commonly referred to as node or graph embeddings [29-31]. Not only do these learned embeddings encapsulate the topological relationships and attributes of individual nodes, but they also capture the global structural patterns and dependencies present in the graph as a whole. By harnessing the expressive power of GNNs, graph similarity prediction can benefit from the rich representations learned by the network, facilitating more accurate and nuanced comparisons between complex and heterogeneous graph structures in diverse domains.

One popular approach for graph similarity prediction using GNNs is to use Siamese networks [32-35], which consist of two identical GNNs that take in two different graphs as input and output a similarity score. The two GNNs share the same weights, allowing them to learn a common representation of the graphs. Another approach is to use a contrastive loss function, which encourages the GNN to learn representations that are close together for similar graphs and far apart for dissimilar graphs [36]. This can be combined with a Siamese network architecture to learn a similarity function. Other GNN-based approaches for graph similarity prediction include using attention mechanisms to focus on important substructures within the graphs [37]. While Graph Neural Network (GNN) based methods have shown promising results in graph similarity learning, they also have a few disadvantages. Here are some of them [17]:

- **Computational Complexity:** GNNs can be computationally expensive, especially for large graphs with a high number of nodes and edges. The complexity increases as the graphs' size and complexity grow, making it challenging to scale GNN-based methods to large-scale graph similarity learning tasks.

- Interpretability and Explainability: The complex nature of the GNN architecture makes it challenging to understand how and why certain patterns are learned and used for similarity comparisons. Interpreting the decisions made by GNN-based models can be difficult.

3. Proposed method

3.1. Problem statement

With the help of synthesized networks, we can represent complex systems through graph structure. The node's connections in real networks are a specific and meaningful pattern. Therefore, the corresponding synthesized network should match the real network. Put differently, the closer the synthetic network is to the target network, the more precise the outcomes of different tests conducted on the synthetic networks will be.

If \mathbb{G} is a dynamic complex network and its snapshots contain $\{G_1, G_2, \dots, G_T\}$, then the problem is to predict the similarity of a network G_r (perhaps a synthesized graph) with G_{T+1} of \mathbb{G} . To formalize this prediction task, Eq. (1) introduces the inputs and output of the problem, where f is a function that takes in the sequence $\{G_1, G_2, \dots, G_T\}$ and G_r to compute the similarity and $S(G_{T+1}, G_r)$ is the similarity between G_{T+1} and G_r . We assume that the considered networks are static graph-temporal signals. This implies that the arrangement of the network remains constant throughout time, but the attributes of the network nodes alter over time.

$$f(\{G_1, G_2, \dots, G_T\}, G_r) = S(G_{T+1}, G_r) \quad (1)$$

One of the paramount applications of predicting the similarity between evolving network states lies in anomaly detection within dynamic complex networks. Sudden deviations in the similarity score of $f(\{G_1, G_2, \dots, G_T\}, G_{T+1})$ might indicate potential anomalies, such as malicious activities or unexpected patterns. Consequently, leveraging this similarity-based approach offers a proactive mechanism to identify and mitigate threats or disruptions in dynamic network environments. Beyond anomaly detection, the predictive framework holds pivotal significance in evaluating the efficacy and performance of dynamic generative models. Generative models that emulate and reproduce complex networks' structural and temporal characteristics necessitate rigorous evaluation metrics. Researchers and practitioners can quantitatively assess dynamic generative models' fidelity, robustness, and generalization capabilities by juxtaposing the predicted similarity scores with ground truth or benchmark snapshots. Such evaluations ensure that generative models capture essential temporal dynamics, structural nuances, and emergent behaviors inherent to real-world complex networks, thereby fostering advancements in network synthesis, simulation, and reconstruction methodologies.

Algorithm 1. Algorithm of noise injection approach

```

Input: Buckets #Bucketi = {G0, G2, ..., GT, Gr}
Output: List_of_labels, Buckets
1: Dictionary ← {}
2: List_of_labels[len(Buckets)] ← {1}
3: Number_of_nodes ← len(Bucket[0][0].nodes)
4: for i = 0 to Number_of_nodes do
5:   Dictionary[i] ← [0,0]
6: for bucket : Buckets do
7:   for node = 0 to Number_of_nodes do
8:     if (min(bucket[node]) < Dictionary[node][0]) then
9:       Dictionary[node][0] ← min(bucket[node])
10:    if (max(bucket[node]) > Dictionary[node][1]) then
11:      Dictionary[node][1] ← max(bucket[node])
12: Index_of_randomly_selected_buckets ← random(range(0, len(Buckets)-1), random(range(0, len(Buckets)-1), 1))
13: for bucket_index : Index_of_randomly_selected_buckets do
14:   Number_of_randomly_selected_nodes ← random(range(0, len(Buckets[0][0].nodes)-1), 1)
15:   Index_of_randomly_selected_nodes ← random(range(0, len(Buckets[0][0].nodes)-1), Number_of_randomly_selected_nodes)
16:   List_of_labels[bucket_index] ← 1 - (Number_of_randomly_selected_nodes / (len(Buckets[0][0].nodes)))
17:   for node_index : Index_of_randomly_selected_nodes do
18:     Buckets[bucket_index][node_index].node_feature[-1] ← random(Dictionary[node_index][0], Dictionary[node_index][1])

```

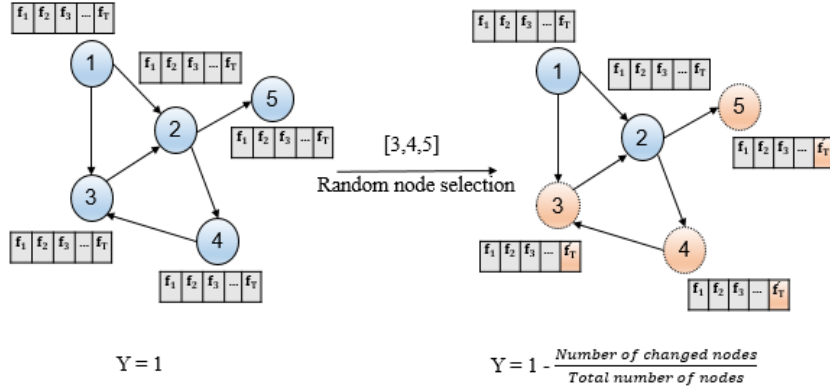

Fig. 1. The process of preparing datasets with the help of the noise injection approach to train the proposed model.

3.2. Noise injection approach

Referring to Eq. (1), when G_r aligns perfectly with G_{T+1} , the resultant similarity metric will be unity (i.e., $S(G_{T+1}, G_r) = 1$). Conversely, any divergence or alteration in G_r leads to a proportional decrement in the similarity value. To illustrate, if G_r undergoes a 20% modification, the similarity is quantified as $S(G_{T+1}, G_r) = 0.8$. Motivated by this foundational understanding, we harness the concept of noise injection to curate a comprehensive training dataset for our deep learning-based model, denoted as f . This research's datasets encompass distinct temporal snapshots organized into various buckets. We systematically introduce varied noise levels into G_r within these buckets, representing the terminal snapshot. Subsequently, we delineate the label for each bucket predicated on the computed similarity distance, thereby facilitating a robust training paradigm for our predictive model. Fig. 1 and Algorithm 1 illustrate the noise injection approach. First of all, we assign a $Y = 1$ similarity label to each of the buckets of datasets, which shows the degree of complete similarity of the last snapshot with its real state. Then, we randomly select several buckets. Next, some nodes are randomly selected, like nodes 3, 4, and 5 in Fig.1, and to inject a logical noise, a random value between the minimum and maximum value that the node has in the entire dataset is replaced by the last feature of the node. Finally, the bucket similarity label is calculated using Eq. (2).

$$Y_{\text{Bucket}[i]} = 1 - \frac{\text{Number of changed nodes}}{\text{Total number of nodes}} \quad (2)$$

3.3. DGSP-GCN method

Since the datasets used in this research are dynamic complex networks, we utilized GNN and recurrent neural network layers. GNN layers are used to propagate information between nodes in a graph, allowing the network to learn features that capture the local and global structure of the graph. This is achieved by aggregating information from neighboring nodes and updating the node representations based on this information. Fig. 2 illustrates the architecture of our proposed model. In the first stage, by the use of the GCN layer, we represent the nodes and edges of each snapshot to 32-dimensional vectors; next, we pass these vectors to a recurrent neural network layer to capture the relationships between the sequence elements over time. Following this, in the third stage, we use a mean pooling layer due to forecasting at the graph level. Eventually, with the help of a MLP, we predict the similarity rate of the last snapshot, G_r , with the future of the snapshots from G_1 to G_T . Actually, the snapshot of G_r is equivalent to the G_{T+1} of the input bucket, which has been injected with noise with a probability of 50%. Also, the similarity prediction process by the proposed method can be seen in Algorithm 2.

However, several kinds of edge and node advanced embedding architectures exist. After our experiments, we will use one of them as the first and second phases of DGSP-GCN architecture because they have been tested for different datasets and have already shown good performance. They include:

- 1) GConvGRU [38]. It consists of multiple layers of GConvGRU cells. Each cell has two main components: a GCN layer and the Gated Recurrent Unit (GRU) layer.
- 2) GConvLSTM [38]. It combines the GCN and LSTM networks to capture both spatial and temporal dependencies in the graph data.
- 3) TGCN [39]. Its architecture comprises several layers, such as GCN, GRU, and temporal pooling.
- 4) AGCRN [40]. It consists of two main components, including gated convolutional layers and recurrent units, to effectively capture spatial and temporal dependencies in the data.
- 5) A3TGCN [41]. It is a powerful architecture that combines TGCN and attention mechanisms for spatiotemporal forecasting tasks.

Although we utilize existing embedding architectures, it is crucial to note that our approach involves substantial customization and adaptation to suit the requirements of dynamic graph similarity prediction. We have meticulously tailored these methods to accommodate the temporal dynamics inherent in our dataset, thereby enhancing their efficacy in capturing evolving graph structures over time.

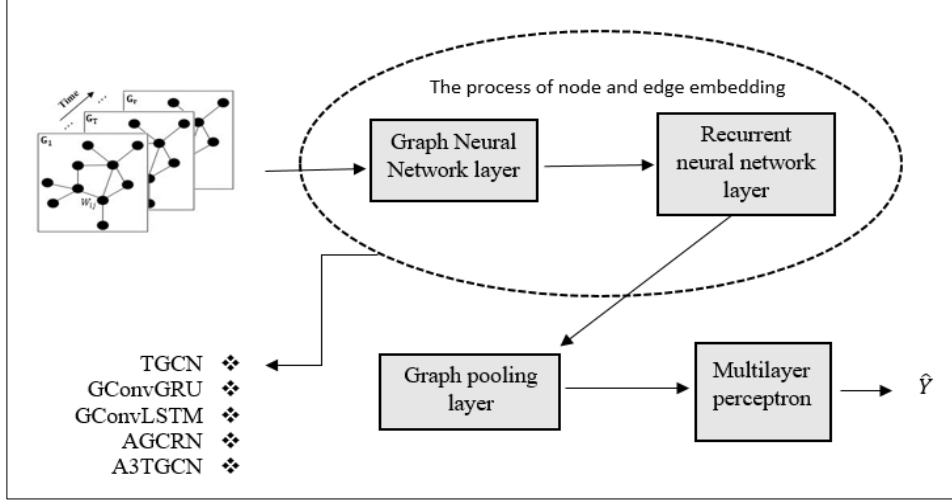

Fig. 2. The architecture of DGSP-GCN model

Algorithm 2: Algorithm of DGSP-GCN

Input: Bucket #Bucket_i = {G₀, G₂, ..., G_T, G_r}
Output: Y_{hat} #predicted similarity between G_{T+1} and G_r

- 1: Vectors_of_nodes ← []
- 2: for snapshot : Bucke.snapshots do
- 3: Node_embedding_list ← []
- 4: for node : snapshot.nodes do
- 5: Node_embedding_list.append(graph_convolution_layer(snapshot)) # 32-dimensional vector for each node
- 6: Vectors_of_nodes.append(recurrent_neur_network(Node_embedding_list)) # recurrent_neural network like LSTM
- 7: Vector_of_bucket ← ∅
- 8: for vector : Vectors_of_nodes do
- 9: Vector_of_bucket ← Vector_of_bucket + vector
- 10: Y_{hat} ← dence_layer_with_32neuron(Vector_of_bucket/len(Vectors_of_nodes))
- 11: Y_{hat} ← dence_layer_with_64neuron(Y_{hat})
- 12: Y_{hat} ← dence_layer_with_1neuron(Y_{hat})

3.4. The performance measures

Evaluating machine learning models is crucial in assessing their performance and effectiveness. The choice of appropriate evaluation metrics holds immense importance due to objective assessment. In other words, evaluation metrics provide an objective and standardized way of measuring and comparing model performance. To evaluate the performance of our regression model, it is common to use Eq. (3), Eq. (4), and Eq. (5), where N is the number of samples, Y is the real label, and \hat{Y} is the label predicted by the model.

$$\text{Mean Squared Error (MSE)} = \frac{1}{N} \sum_{i=1}^N (Y - \hat{Y})^2 \quad (3)$$

$$\text{Mean Absolute Error (MAE)} = \frac{1}{N} \sum_{i=1}^N |Y - \hat{Y}| \quad (4)$$

$$\text{Root Mean Squared Error (RMSE)} = \sqrt{\frac{1}{N} \sum_{i=1}^N (Y - \hat{Y})^2} \quad (5)$$

Giving higher weights to larger errors is one of the advantages of MSE, thereby indicating the importance of reducing significant deviations. Nevertheless, one disadvantage of it is that it squares the errors, which can lead to an amplification of the impact of outliers. On the other hand, although MAE is less sensitive to outliers and provides a robust measure of error, it may not fully capture the relative importance of different errors. However, RMSE combines the benefits of both MSE and MAE by calculating the square root of the average squared difference between predicted and actual values. Therefore, with the help of these measures, we can evaluate the performance of the proposed model in different aspects.

4. Experiments

4.1. Evaluation methods

In order to comprehensively assess the performance of our model, we conducted a thorough comparative analysis against a set of baselines. This evaluation methodology allows us to gauge the effectiveness and superiority of our proposed approach in tackling the given problem. However, previous methods in graph comparison are limited to static graphs, while the datasets used in this research are temporal. That is why we have presented two baselines, including time series regression and random methods, to compare the performance of the proposed model. In the case of the random method, a random number between zero and one is generated as \hat{Y} for each sample of the test dataset. Although the random method's performance is not impressive, it does assure us that our proposed model for similarity prediction is not performing worse than the least effective baseline. Another baseline idea we presented is the use of time series regression. Fig. 3 and Algorithm 3 describe the process of similarity prediction. In this case, a regression model is trained for each node in every sample of the test dataset. The model gets the features of the node from snapshots 1 to T-1 to predict its feature for the next snapshot. In other words, this model predicts the last feature for each node after receiving n-1 previous features of the node. Eventually, the amount of $\hat{Y}_{\text{Bucket}[i]}$ calculate based on Eq. (6).

$$\hat{Y}_{\text{Bucket}[i]} = \frac{1}{m} \sum_{j=1}^m 1 - |Y_j - \hat{Y}_j| \quad (6)$$

Where m is the number of nodes in each sample, Y_j is the real label of the node of the last snapshot and \hat{Y}_j is the predicted label by the time series regression model. The absolute difference between these two values represents the amount of noise injected into the last feature of each bucket node.

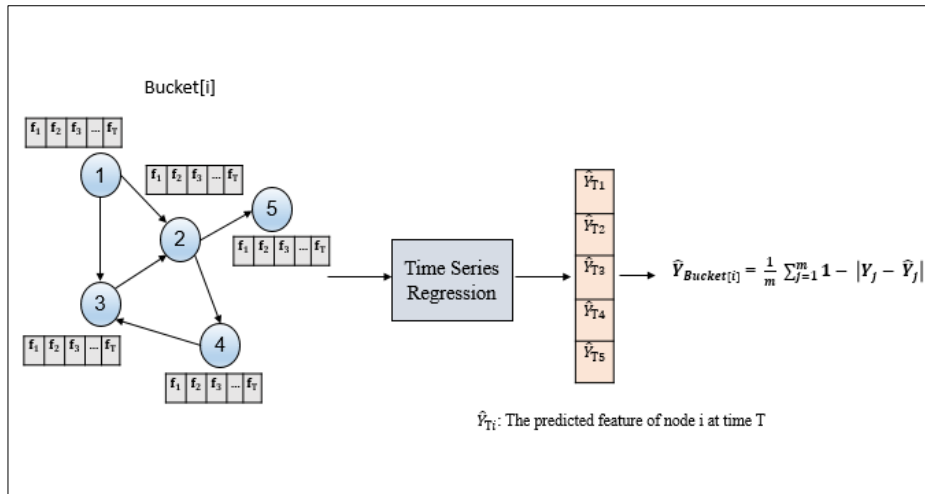

Fig. 3. The process of time series regression for prediction of bucket's label for each sample of the test dataset.

Algorithm 3: Algorithm of time series regression method

```

Input: Buckets
Output: Y_hat
1: Time  $\leftarrow$  []
2: for i : list(range(len(Buckets[0].node[0].feature)-1)) do
3:   Time.append(i)
4: Y_hat  $\leftarrow$  []
5: for bucket : Buckets do
6:   List_Y_hat_nodes  $\leftarrow$  []
7:   List_Y_test_nodes  $\leftarrow$  []
8:   for node_features : len(bucket.node) do
9:     node_features  $\leftarrow$  min_max_normalization(node_features)
10:    LinearRegression.fit(Time, node_features[0:-1])
11:    List_Y_hat_nodes.append(LinearRegression.predict(Time[-1]+1))
12:    List_Y_test_nodes.append(node_features[-1])
13:    Noise_list  $\leftarrow$  []
14:    for j : len(List_Y_test_nodes) do
15:      Noise_list.append(1 - absolute(List_Y_test_nodes[j] - List_Y_hat_nodes[j]))
16: Y_hat.append(mean(Noise_list)

```

4.2. Data description

This section emphasizes a robust and comprehensive data description to provide a solid foundation for our research findings and analysis. Data plays a crucial role in shaping the outcomes of any study, and by thoroughly understanding the datasets used, we can ensure the validity and reliability of our results. Therefore, we use five real-world available datasets, which are a kind of static graph-temporal signals. They include the following:

- 1) WikiMath [42]. This is a collection of important math articles from Wikipedia, presented as a graph where each page is a vertex and links between them are edges. The weight of each edge represents the number of links from the source page to the target page. The target is the number of daily visits to these pages.
- 2) Chickenpox [43]. This is a collection of information about chickenpox cases in Hungary. The data includes the number of chickenpox cases each week, where each city is a vertex and the road between them an edge.
- 3) PedalMe [44]. This is a dataset of Bicycle deliveries in London. The data is represented as a graph, where different areas are the vertices, and the connections between them are the edges. The vertex features show the number of deliveries requested each week.
- 4) MetraLa [45]. This dataset predicts traffic patterns in the Los Angeles Metropolitan area. The data was gathered from 207 loop detectors on highways throughout Los Angeles County.
- 5) MontevideoBus [46]. This dataset contains information about the number of passengers who boarded buses at various stops in Montevideo city. The weight of these connections represents the distance between stops.

These datasets are summarized in Table 1. To train and evaluate our proposed model for each dataset, we use the cross-validation method with $K=3$.

Table 1: The used datasets in our experiments.

Dataset	#Nodes	#Edges	#Snapshots	Frequently
WikiMath	1068	27079	731	Daily
Chickenpox	20	102	520	Weekly
PedalMe	15	225	30	Weekly
MetraLa	207	1722	3224	5-Minutes
MontevideoBus	678	690	734	1-Hours

4.3. Experimental result analysis

The hyper-parameters of our proposed model include epoch, number of snapshots per bucket, node embedding dimensions, and learning rate. The experiment's hyper-parameters were manually set to 30, 10, 32, and 0.01 for all datasets based on experiments, respectively. Each embedding recurrent layer in the architectures of the proposed model has its merits and demerits, and the best layer to use will depend on our experiments. That is why, according to the results of experiments in Table 2 and Figures 4, 5, 6, 7, and 8, the performance of the proposed model in the same condition for the A3TGCN layer is almost better than others because of an attention mechanism layer. This attention-driven strategy enables A3TGNC to capture the intricate relationships and importance of neighboring nodes, resulting in highly informative and context-aware embeddings. At its core, the attention mechanism allows the model to dynamically assign weights or importance scores to each neighbor during the aggregation process, considering both local and global information. By adaptively attending to the most relevant nodes, A3TGNC effectively focuses its attention on the crucial aspects of the graph, emphasizing nodes that contribute significantly to the target node's representation. This attention-based approach offers several significant advantages: firstly, it enables the model to assign higher weights to influential neighbors, thereby capturing the influence and impact of key nodes in the embedding process. Secondly, it allows A3TGNC to prioritize relevant structural patterns and dependencies, enhancing its ability to capture complex graph dynamics and characteristics. Thirdly, the attention mechanism enables the model to handle varying degrees of node importance, such as nodes with high centrality or rare but impactful nodes, enhancing the robustness and adaptability of the embedding generation process.

The bar graphs from Figure 4 to Figure 8 show the error rate of the proposed model and baselines based on the results of experiments in Table 2. Let's discuss Fig. 4 as an example of our experiments; the supplied bar chart denotes the percentage of error rates of the proposed model and other baselines based on MSE, MAE, and RMSE performance measures. As an overall trend, the lowest error rates can be observed for the proposed model with the A3TGCN layer. In contrast, these figures are higher for time series regression and especially for the random method than the others. To begin with, in MSE, the error rate for the proposed model with embedding layer including GConvGRU, GConvLSTM, TGCN, AGCRN, and A3TGCN is on an average of well over 10%. Also, the average MAE of the proposed model with different embedding architectures is almost 28%, and for RMSE, it is almost 34%. In the case of time series regression, these figures' percentages are 7%, 7%, and 8% higher than their counterparts in the proposed model with the A3TGCN embedding layer, respectively. It can also be seen that there is an almost similar trend for the other baseline.

Finally, after determining the optimal parameters and choosing an architecture for embedding, the final results of the proposed method can be seen in Table 3 with three dense layers, including 32, 64, and 1 neurons, respectively. We have used PyTorch [47] and PyTorch Geometric Temporal [48] libraries to implement the proposed model.

Table 2: The prediction results of the proposed model and other baselines

Dataset	Method	Recurrent layer	MSE	MAE	RMSE
Wiki Math	DGSP-GCN Method	GConvGRU	0.1367	0.3264	0.3598
		GConvLSTM	0.1262	0.3091	0.3579
		TGCN	0.1117	0.2800	0.3419
		AGCRN	0.1220	0.2843	0.3490
		A3TGCN	0.1012	0.2624	0.3224
	Random Method	-	0.1991	0.3676	0.4460
	Time series regression Method	-	0.1724	0.3523	0.4139
Chickenpox	DGSP-GCN Method	GConvGRU	0.1162	0.3015	0.3442
		GConvLSTM	0.1065	0.2683	0.3307
		TGCN	0.1067	0.2697	0.3173
		AGCRN	0.1043	0.2351	0.3011
		A3TGCN	0.0834	0.1797	0.2648
	Random Method	-	0.2136	0.3789	0.4620

	Time series regression Method	-	0.1489	0.3273	0.3858
PedalMe		GConvGRU	0.0904	0.3120	0.3016
		GConvLSTM	0.0889	0.2683	0.3021
	DGSP-GCN Method	TGCN	0.1216	0.2572	0.3489
		AGCRN	0.0977	0.2441	0.3125
		A3TGCN	0.0768	0.1750	0.2770
	Random Method	-	0.1871	0.3753	0.4319
Time series regression Method	-	0.1420	0.3539	0.3736	
MontevideoBus		GConvGRU	0.1216	0.3039	0.3470
		GConvLSTM	0.0934	0.2595	0.2995
	DGSP-GCN Method	TGCN	0.0900	0.2596	0.3006
		AGCRN	0.1163	0.2835	0.3341
		A3TGCN	0.0706	0.2038	0.2717
	Random Method	-	0.1950	0.3685	0.4412
Time series regression Method	-	0.1618	0.3284	0.4015	
MetraLa		GConvGRU	0.0456	0.1519	0.2056
		GConvLSTM	0.0668	0.1755	0.2215
	DGSP-GCN Method	TGCN	0.0477	0.1592	0.1845
		AGCRN	0.0936	0.2787	0.3150
		A3TGCN	0.0549	0.1803	0.2343
	Random Method	-	0.1859	0.3625	0.4312
Time series regression Method	-	0.1536	0.3164	0.3919	

Table 3: The errors of the DGSP-GCN model with the A3TGCN embedding layer

Dataset	MSE	MAE	RMSE
Wiki Math	0.0983	0.2289	0.3176
Chickenpox	0.0502	0.1117	0.2229
PedalMe	0.0629	0.1889	0.2416
MontevideoBus	0.0607	0.1907	0.2463
MetraLa	0.0508	0.1705	0.2253

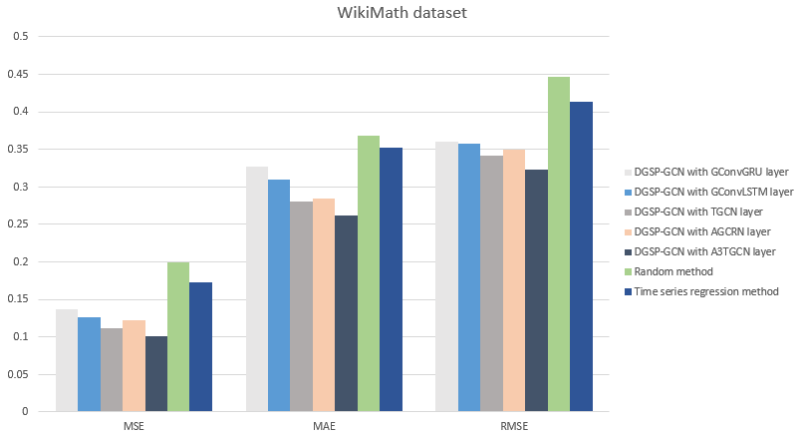

Fig. 4. The error rates of models for the Wikimath dataset.

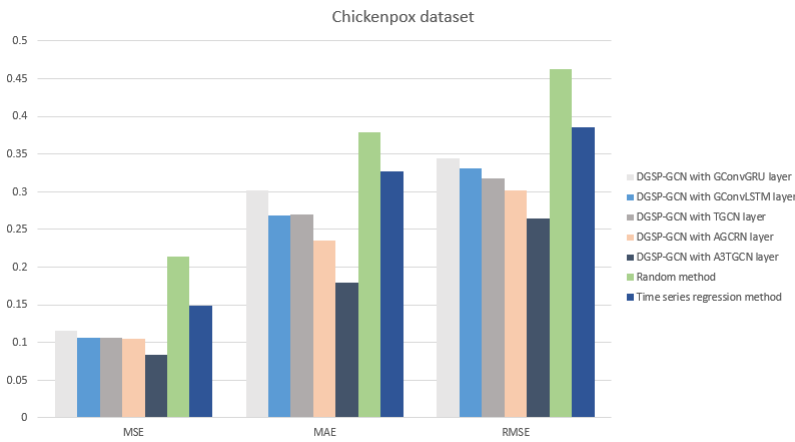

Fig. 5. The error rates of models for the Chickenpox dataset.

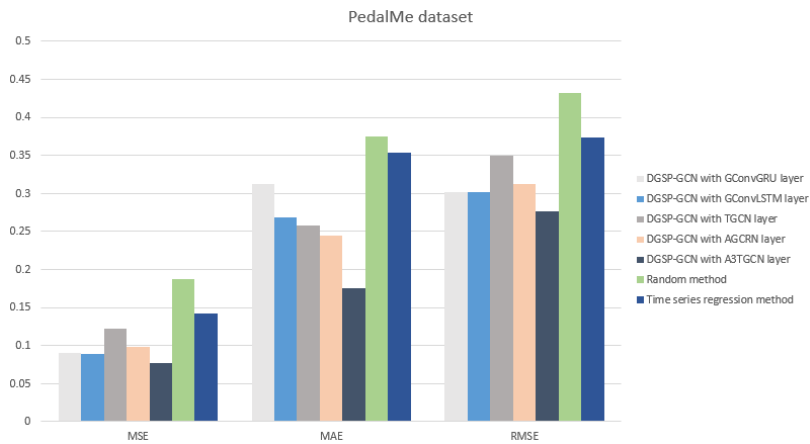

Fig. 6. The error rates of models for the PedalMe dataset.

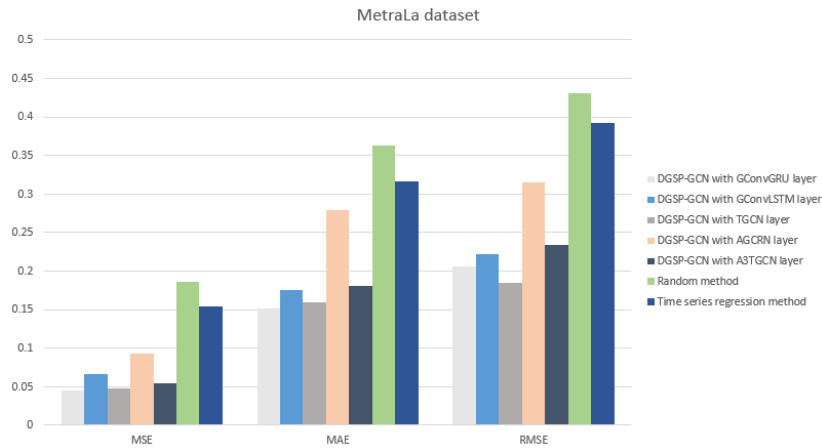

Fig. 7. The error rates of models for the MetraLa dataset.

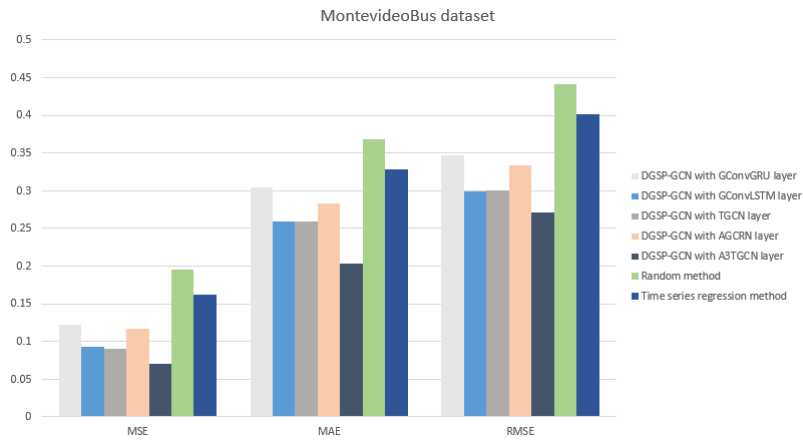

Fig. 8. The error rates of models for the MontevideoBus dataset.

5. Conclusion

There are many different kinds of challenges in complex network modeling based on machine learning, and solving them improves the performance of network generative models, especially their dynamic counterparts. An automatic evaluation approach based on deep learning is one of the most effective ways to improve the quality of artificially produced networks. Dynamic generative models have used statistical approaches of static modeling methods, which is not optimal due to time dependency in dynamic graph-based structures. Therefore, this paper proposes a deep learning-based model to solve the challenge of evaluating dynamic generative models. The proposed model contains several phases, including node and edge embedding. In the case of embedding, we have tested several embedding architectures like GConvGRU, GConvLSTM, TGCN, AGCRN, and A3TGCN. These architectures contain GCN and recurrent neural network layers.

On the one hand, the GCN is used to capture the graph's topological structure to obtain the spatial dependence; on the other hand, the recurrent neural network layer is used to capture the dynamic change of node attribute to obtain the temporal dependence. According to the conducted tests, the A3TGCN performs almost better than other embedding layers due to having an attention mechanism layer. Besides evaluating dynamic generative models, the proposed model can also be used in anomaly detection. Our model achieved the best prediction results under different horizons when evaluated on five real-world datasets and compared with the random and time series regression baselines. In other words, according to Table 3, the average error rate of the proposed model based on MSE, MAE, and RMSE performance measures with the A3TGCN embedding layer for the datasets presented in Table 1 are equal to 0.0645,

0.1781, and 0.2507, respectively. In contrast, these averages for the time series regression model based on Table 2 each are equal to 0.1557, 0.3356, and 0.3933. Also, these values for another baseline, the random model, are separately 0.1961, 0.3623, and 0.4424.

In light of the findings presented in this study, there are several promising avenues for future research. It would be valuable to improve the proposed model to apply to larger and different samples like dynamic graph-static and dynamic graph-temporal signals. This would provide further insights into the generalizability and sustainability of the observed outcomes. Last but not least, in this research, if G_r is a complex network, and $\{G_1, G_2, \dots, G_T\}$ is a set of snapshots from time step 1 to T . Then, the proposed model predicts the degree of similarity of G_r with G_{T+i} in such a way that $i = 1$. Therefore, improving the proposed model to predict the degree of similarity per $i \geq 1$ can be an effective and practical strategy.

Statements and Declarations

Author Contributions

Alireza Rashnu: Conceptualization, Methodology, Software, Validation, Formal analysis, Theoretical analysis, Investigation, Data curation, Writing - original draft, Writing – review & editing, Visualization.

Sadegh Aliakbary: Supervision, Writing – review & editing, Methodology, Project administration, Theoretical analysis.

Funding

The authors declare that no funds, grants, or other support were received during the preparation of this manuscript.

Competing Interests

The authors have no relevant financial or non-financial interests to disclose.

Data Availability

The datasets used during the current study are publicly available via the following links:

1. WikiMath Dataset:
https://raw.githubusercontent.com/benedekrozemberczki/pytorch_geometric_temporal/master/dataset/wikivital_mathematics.json
2. Chickenpox Dataset:
https://raw.githubusercontent.com/benedekrozemberczki/pytorch_geometric_temporal/master/dataset/chickenpox.json
3. PedalMe Dataset:
https://raw.githubusercontent.com/benedekrozemberczki/pytorch_geometric_temporal/master/dataset/pedalme_london.json
4. MetraLa Dataset:
https://graphmining.ai/temporal_datasets/METR-LA.zip
5. MontevideoBus Dataset:
https://raw.githubusercontent.com/benedekrozemberczki/pytorch_geometric_temporal/master/dataset/montevideo_bus.json

References

1. Boccaletti S, Bianconi G, Criado R, Del Genio C I, Gómez-Gardenes J, Romance M, Sendina-Nadal I, Wang Z, and Zanin M (2014) The structure and dynamics of multilayer networks. *Physics reports*. **544**(1): p. 1-122.
2. Albert R (2005) Scale-free networks in cell biology. *Journal of cell science*. **118**(21): p. 4947-4957.
3. Feng M, Li X, Li Y, and Li Q (2023) The impact of nodes of information dissemination on epidemic spreading in dynamic multiplex networks. *Chaos: An Interdisciplinary Journal of Nonlinear Science*. **33**(4).
4. Sabharwal S M and Aggrawal N (2023) A Survey on Information Diffusion over Social Network with the Application on Stock Market and its Future Prospects. *Wireless Personal Communications*. p. 1-27.
5. Yang K, Li J, Liu M, Lei T, Xu X, Wu H, Cao J, and Qi G (2023) Complex systems and network science: a survey. *Journal of Systems Engineering and Electronics*. **34**(3): p. 543-573.
6. Aliakbary S, Motallebi S, Rashidian S, Habibi J, and Movaghgar A (2015) Distance metric learning for complex networks: Towards size-independent comparison of network structures. *Chaos: An Interdisciplinary Journal of Nonlinear Science*. **25**(2).
7. Kullback S and Leibler R A (1951) On information and sufficiency. *The annals of mathematical statistics*. **22**(1): p. 79-86.
8. Gretton A, Borgwardt K M, Rasch M J, Schölkopf B, and Smola A (2012) A kernel two-sample test. *The Journal of Machine Learning Research*. **13**(1): p. 723-773.
9. Xu K, Hu W, Leskovec J, and Jegelka S (2018) How powerful are graph neural networks? arXiv preprint arXiv:1810.00826.
10. Bojchevski A, Shchur O, Zügner D, and Günnemann S (2018) Netgan: Generating graphs via random walks. in *International conference on machine learning*. of Conference.: PMLR.

11. Lei K, Qin M, Bai B, Zhang G, and Yang M (2019) GCN-GAN: A non-linear temporal link prediction model for weighted dynamic networks. in IEEE INFOCOM 2019-IEEE conference on computer communications. of Conference.: IEEE.
12. Goyal P, Chhetri S R, and Canedo A (2020) dyngraph2vec: Capturing network dynamics using dynamic graph representation learning. *Knowledge-Based Systems*. **187**: p. 104816.
13. Sankar A, Wu Y, Gou L, Zhang W, and Yang H (2020) Dysat: Deep neural representation learning on dynamic graphs via self-attention networks. in Proceedings of the 13th international conference on web search and data mining. of Conference.
14. Yang M, Zhou M, Kalander M, Huang Z, and King I (2021) Discrete-time temporal network embedding via implicit hierarchical learning in hyperbolic space. in Proceedings of the 27th ACM SIGKDD Conference on Knowledge Discovery & Data Mining. of Conference.
15. Niknam G, Molaei S, Zare H, Pan S, Jalili M, Zhu T, and Clifton D (2023) DyVGRNN: DYnamic mixture variational graph recurrent neural networks. *Neural Networks*. **165**: p. 596-610.
16. Nikolentzos G, Siglidis G, and Vazirgiannis M (2021) Graph kernels: A survey. *Journal of Artificial Intelligence Research*. **72**: p. 943-1027.
17. Ma G, Ahmed N K, Willke T L, and Yu P S (2021) Deep graph similarity learning: A survey. *Data Mining and Knowledge Discovery*. **35**: p. 688-725.
18. Borgwardt K M and Kriegel H-P (2005) Shortest-path kernels on graphs. in Fifth IEEE international conference on data mining (ICDM'05). of Conference.: IEEE.
19. Yanardag P and Vishwanathan S (2015) Deep graph kernels. in Proceedings of the 21th ACM SIGKDD international conference on knowledge discovery and data mining. of Conference.
20. Sugiyama M and Borgwardt K (2015) Halting in random walk kernels. *Advances in neural information processing systems*. **28**.
21. Shervashidze N, Schweitzer P, Van Leeuwen E J, Mehlhorn K, and Borgwardt K M (2011) Weisfeiler-lehman graph kernels. *Journal of Machine Learning Research*. **12**(9).
22. Hido S and Kashima H (2009) A linear-time graph kernel. in 2009 Ninth IEEE International Conference on Data Mining. of Conference.: IEEE.
23. Grover A and Leskovec J (2016) node2vec: Scalable feature learning for networks. in Proceedings of the 22nd ACM SIGKDD international conference on Knowledge discovery and data mining. of Conference.
24. Nikolentzos G, Meladianos P, and Vazirgiannis M (2017) Matching node embeddings for graph similarity. in Proceedings of the AAAI Conference on Artificial Intelligence. of Conference.
25. Tixier A J-P, Nikolentzos G, Meladianos P, and Vazirgiannis M (2019) Graph classification with 2d convolutional neural networks. in Artificial Neural Networks and Machine Learning-ICANN 2019: Workshop and Special Sessions: 28th International Conference on Artificial Neural Networks, Munich, Germany, September 17-19, 2019, Proceedings 28. of Conference.: Springer.
26. Hamilton W L, Ying R, and Leskovec J (2017) Representation learning on graphs: Methods and applications. arXiv preprint arXiv:1709.05584.
27. Wu B, Liu Y, Lang B, and Huang L (2018) Dgcnn: Disordered graph convolutional neural network based on the gaussian mixture model. *Neurocomputing*. **321**: p. 346-356.
28. Liu S, Demirel M F, and Liang Y (2019) N-gram graph: Simple unsupervised representation for graphs, with applications to molecules. *Advances in neural information processing systems*. **32**.
29. Zhou J, Cui G, Hu S, Zhang Z, Yang C, Liu Z, Wang L, Li C, and Sun M (2020) Graph neural networks: A review of methods and applications. *AI open*. **1**: p. 57-81.
30. Zhao W, Li Y, Fan T, and Wu F (2022) A novel embedding learning framework for relation completion and recommendation based on graph neural network and multi-task learning. *Soft Computing*. p. 1-13.
31. Dornaika F (2023) Multi-similarity semi-supervised manifold embedding for facial attractiveness scoring. *Soft Computing*. **27**(8): p. 5099-5108.
32. Wang S and Philip S Y (2019) Heterogeneous graph matching networks: Application to unknown malware detection. in 2019 IEEE International Conference on Big Data (Big Data). of Conference.: IEEE.
33. Ma G, Ahmed N K, Willke T L, Sengupta D, Cole M W, Turk-Browne N B, and Yu P S (2019) Deep graph similarity learning for brain data analysis. in Proceedings of the 28th ACM International Conference on Information and Knowledge Management. of Conference.
34. Lu J, Li S, Guo W, Zhao M, Yang J, Liu Y, and Zhou Z (2023) Siamese Graph Attention Networks for robust visual object tracking. *Computer Vision and Image Understanding*. **229**: p. 103634.
35. Liu B, Wang Z, Zhang J, Wu J, and Qu G (2024) DeepSIM: a novel deep learning method for graph similarity computation. *Soft Computing*. **28**(1): p. 61-76.
36. Li S, Li W, Luvembe A M, and Tong W (2023) Graph contrastive learning with feature augmentation for rumor detection. *IEEE Transactions on Computational Social Systems*.
37. Tan W, Gao X, Li Y, Wen G, Cao P, Yang J, Li W, and Zaiane O R (2023) Exploring attention mechanism for graph similarity learning. *Knowledge-Based Systems*. p. 110739.
38. Seo Y, Defferrard M, Vandergheynst P, and Bresson X (2018) Structured sequence modeling with graph convolutional recurrent networks. in *Neural Information Processing: 25th International Conference, ICONIP 2018, Siem Reap, Cambodia, December 13-16, 2018, Proceedings, Part I 25*. of Conference.: Springer.
39. Zhao L, Song Y, Zhang C, Liu Y, Wang P, Lin T, Deng M, and Li H (2019) T-gcn: A temporal graph convolutional network for traffic prediction. *IEEE transactions on intelligent transportation systems*. **21**(9): p. 3848-3858.
40. Bai L, Yao L, Li C, Wang X, and Wang C (2020) Adaptive graph convolutional recurrent network for traffic forecasting. *Advances in neural information processing systems*. **33**: p. 17804-17815.
41. Bai J, Zhu J, Song Y, Zhao L, Hou Z, Du R, and Li H (2021) A3t-gcn: Attention temporal graph convolutional network for traffic forecasting. *ISPRS International Journal of Geo-Information*. **10**(7): p. 485.

-
42. Petluri N and Al-Masri E (2018) Web traffic prediction of wikipedia pages. in 2018 IEEE International Conference on Big Data (Big Data). of Conference.: IEEE.
 43. Rozemberczki B, Scherer P, Kiss O, Sarkar R, and Ferenc T (2021) Chickenpox cases in Hungary: a benchmark dataset for spatiotemporal signal processing with graph neural networks. arXiv preprint arXiv:[2102.08100](https://arxiv.org/abs/2102.08100).
 44. Rozemberczki B, Scherer P, He Yixuan, Panagopoulos G., Astefanoaei M., Kiss Olivér, Béres Ferenc, Collignon Nicolas, and Sarkar Rik. (2023) Pedal Me Bicycle Deliveries: UCI Machine Learning Repository.
 45. Jagadish H V, Gehrke J, Labrinidis A, Papakonstantinou Y, Patel J M, Ramakrishnan R, and Shahabi C (2014) Big data and its technical challenges. Communications of the ACM. *57*(7): p. 86-94.
 46. Hernández D (2017) Public transport, well-being and inequality: coverage and affordability in the city of Montevideo. CEPAL Review.
 47. Imambi S, Prakash K B, and Kanagachidambaresan G (2021) PyTorch. Programming with TensorFlow: Solution for Edge Computing Applications. p. 87-104.
 48. Rozemberczki B, Scherer P, He Y, Panagopoulos G, Astefanoaei M S, Kiss O, Béres F, Collignon N, and Sarkar R (2021) PyTorch Geometric Temporal: Spatiotemporal Signal Processing with Neural Machine Learning Models. Proceedings of the 30th ACM International Conference on Information & Knowledge Management.