

Taut foliations and contact pairs in dimension three

Thomas Massoni*

May 27, 2024

Abstract

We present a new construction of codimension-one foliations from pairs of contact structures in dimension three. This constitutes a converse result to a celebrated theorem of Eliashberg and Thurston on approximations of foliations by contact structures. Under suitable hypotheses on the initial contact pairs, the foliations we construct are *taut*, allowing us to characterize taut foliations entirely in terms of contact geometry. This viewpoint reveals some surprising *flexible* phenomena for taut foliations, and provides new insight into the L -space conjecture.

The first part of the proof builds upon the work on Colin and Firmo on positive contact pairs. The second part involves a wide generalization of a technical result of Burago and Ivanov on the construction of branching foliations tangent to continuous plane fields, and might be of independent interest.

arXiv:2405.15635v1 [math.SG] 24 May 2024

*Department of Mathematics, Princeton University, USA. Email address: tmassoni@princeton.edu

Contents

0	Introduction	4
0.1	Overview and motivations	4
0.1.1	Foliations and contact structures	4
0.1.2	Eliashberg–Thurston approximation theorem	7
0.1.3	A dictionary between foliations and contact pairs	8
0.1.4	The L -space conjecture	10
0.2	Statement of results	10
0.2.1	A new construction of foliations	10
0.2.2	Application: transverse surgeries on taut foliations	12
0.3	Discussion and further directions	13
0.3.1	Towards a contact L -space conjecture	13
0.3.2	Variations and refinements	15
0.4	Acknowledgments	16
I	From contact pairs to foliations	17
1	Contact pairs revisited	17
1.1	The setup	17
1.2	Invariant plane fields	20
1.3	Local integrability	24
1.4	Proof of Theorem A	32
2	Constructing foliations from contact pairs	33
2.1	Polarized vector fields	33
2.2	Proof of Theorem B	38
3	Strongly tight contact pairs	38
3.1	Tautness and tightness	38
3.2	Transverse surgeries	41
4	Liouville pairs	44
4.1	Elementary properties	44
4.2	From hypertaut foliations to Liouville pairs	45
4.3	Proof of Theorem E	46
4.4	The skeleton	48
4.5	Semi-Anosov flows and unique integrability	49
II	Branching foliations	51
5	General construction	52
5.1	Tiles	52
5.2	Weak prefoliations	55

6	Upper enveloping tiles	58
6.1	Preliminaries	59
6.2	Forward curves	61
6.3	Forward envelopes	65
7	Extending the order	74
7.1	Forward order on pure X -lines	75
7.2	Backward domains of overlap	76
7.2.1	Backward domain of an envelope	76
7.2.2	Overlap of two envelopes	77
7.2.3	Initial corners	80
7.2.4	Triple overlaps	82
7.3	The preorder between envelopes	83
7.3.1	Definition of the preorder	83
7.3.2	Proof of the weak prefoliation axioms	86
7.3.3	Completed forward envelopes	91
8	Proof of Proposition 5.11	94
8.1	First extension	94
8.1.1	Step 1: geometric extension	94
8.1.2	Step 2: abstract extension	96
8.2	Second extension	97
8.2.1	Typology of backward corners	97
8.2.2	Upper neighbors	98
8.2.3	Gluing upper neighbors	100
8.3	Finishing the proof	101
A	Key ODE lemma	102
B	Taut plane fields	104
C	Approximation lemma	107
D	Periodic solutions to ODEs on the cylinder	108
	References	111

0 Introduction

Good things come in pairs.

Chinese proverb

Throughout this article, M denotes a closed, connected, oriented three-dimensional manifold. The term foliation will always refer to a *codimension one* foliation. All the foliations and contact structures under consideration will be *(co)oriented*.

The main result of this part is a construction of foliations from pairs of contact structures. This can be regarded as a converse result to a celebrated theorem of Eliashberg and Thurston [ET98].

Main Theorem. *Let (ξ_-, ξ_+) be a positive contact pair on M , with a positively transverse vector field v . Assume either that one of ξ_{\pm} is tight, or that they are everywhere transverse. Then there exists an aspherical C^0 -foliation \mathcal{F} on M transverse to v .*

In particular, $T\mathcal{F}$ and ξ_{\pm} are homotopic as oriented plane fields. If the vector field v is volume preserving, then the foliation \mathcal{F} is *taut*. This allows us to completely characterize the existence of taut foliations on 3-manifolds purely in terms of contact geometry. Therefore, this construction can be regarded as the first step of a program to address the *L-space conjecture* from the point of view of contact topology.

0.1 Overview and motivations

0.1.1 Foliations and contact structures

We review some definitions and basic properties of (codimension-one) foliations and contact structures on 3-manifolds.

Foliations. A 2-dimensional foliation \mathcal{F} on a 3-dimensional manifold M is, loosely speaking, a decomposition of M by surfaces, or *leaves*, which locally modelled on the standard foliation by horizontal planes on \mathbb{R}^3 . Alternatively, a smooth foliation may be described in terms of its tangent plane field $T\mathcal{F}$. Assuming that it is cooriented, it can be realized as the kernel of a smooth, nowhere vanishing 1-form α satisfying

$$\alpha \wedge d\alpha = 0. \tag{0.1}$$

Reciprocally, any smooth nowhere vanishing 1-form satisfying (0.1) defines a cooriented foliation \mathcal{F} with $T\mathcal{F} = \ker \alpha$ in a unique way by the Frobenius integrability theorem.

Foliations are among the most important structures on 3-manifolds and their theory is extremely rich. We refer to the encyclopedic books [CC00; CC03] and [Cal07] for a particularly exhaustive account of this theory and for the standard definitions. We wish to think about foliations as *fragile* objects which cannot be modified easily because of the integrability condition; a small perturbation of the 1-form α typically does not satisfy (0.1) anymore.

In this first part, we will mostly consider foliations and plane fields which are not smooth but only continuous. Let us recall the important

Definition 0.1. *A continuous plane field η on M is*

- **Locally integrable** if for every point $p \in M$, there exists a (germ of) \mathcal{C}^1 surface tangent to η passing through p ,
- **Integrable** if there exists a topological foliation \mathcal{F} on M with \mathcal{C}^1 -immersed leaves tangent to η ,
- **Uniquely integrable** if it is locally integrable, and at each point the germ of integral surface is unique.

We have the trivial implications

$$\text{Uniquely integrable} \implies \text{Integrable} \implies \text{Locally integrable},$$

but the converse implications are not true in general. Even one dimension lower, there exists continuous (Hölder regular) vector fields on \mathbb{R}^2 which are *not* tangent to foliations, or are tangent to many *distinct* foliations, see [BF03]. However, for Lipschitz continuous plane fields (or vector fields), these three definitions are equivalent by the Picard–Lindelöf–Cauchy–Lipschitz theorem. Besides, a given integrable continuous plane field might be tangent to many distinct foliations.

We are interested in foliations whose leaves are tangent to a continuous plane field:

Definition 0.2. A topological foliation \mathcal{F} on M is a \mathcal{C}^0 -**foliation** if its leaves are smoothly immersed surfaces tangent to a global continuous plane field on M .

Essentially, this is the lowest regularity class for which $T\mathcal{F}$ is defined as a continuous plane field. However, \mathcal{C}^0 -foliations have *no transverse regularity*. By a theorem of Calegari [Cal01], any topological foliation on a 3-manifold is topologically isotopic to a \mathcal{C}^0 -foliation. However, a \mathcal{C}^0 -foliation can typically *not* be upgraded to a smooth—or even \mathcal{C}^1 —foliation in a natural way.

Not every foliation on a 3-manifold is interesting. Indeed, Thurston showed that for every homotopy class of plane field on a closed 3-manifold, there exists a smooth foliation whose tangent plane field is in that class, see [Thu76]. However, these foliations have *Reeb components* by construction, making them too flexible to effectively measure the topology of the ambient manifold. Recall that a Reeb component of a foliation is a solid torus whose boundary is a leaf and such that the restriction of the foliation to the interior of the solid torus is a foliation by planes transverse to the core, see [Cal07, Example 4.7]. A foliation without Reeb components is called **Reebless**.

Another type of foliations was brought to prominence by the work of Thurston and Gabai: the class of *taut foliations*.

Definition 0.3. A (smooth) foliation \mathcal{F} on M is (**everywhere**) **taut** if for every $p \in M$, there exists an immersed loop in M transverse to \mathcal{F} and passing through p .

There exist many equivalent definitions of tautness, see [Cal07] for a sample. This definition still makes sense for \mathcal{C}^0 -foliations. It can be adapted for topological foliations in different yet *nonequivalent* ways, see [CKR19]. However, all these definitions are equivalent up to a \mathcal{C}^0 -small isotopy. While taut foliations are Reebless, the converse is not true in general but it holds on atoroidal manifolds. Importantly, the existence of a Reebless or taut foliation imposes strong restrictions on the topology and geometry of the ambient manifold M . For instance, Novikov’s theorem implies that if M carries a Reebless foliation \mathcal{F} , then the leaves of \mathcal{F} are π_1 -injective and the loops transverse to \mathcal{F} are non-contractible, see [Cal07]. This implies that M is irreducible and its universal cover is \mathbb{R}^3 .

One could think of Reebless and taut foliations as *brittle* objects, fragile and rigid at the same time. While it is known by the work of Gabai [Gab83] that every closed irreducible 3-manifold

with positive first Betti number carries a taut foliation, it is still an fundamental open problem to determine which *rational homology spheres* carry a Reebless or a taut foliation. The *L-space conjecture* described below provides some remarkable insight into that question.

Contact structures. A contact structure ξ on M is a smooth, *maximally non integrable* plane field. It can be (locally) represented as the kernel of a smooth 1-form α satisfying

$$\alpha \wedge d\alpha \neq 0 \tag{0.2}$$

pointwise. Since M is oriented and ξ is assumed to be cooriented, we can find a globally defined contact form α that satisfies either $\alpha \wedge d\alpha > 0$ or $\alpha \wedge d\alpha < 0$ everywhere on M . This sign does not depend on the choice of α . In the first case, ξ is called **positive** and in the second case, it is called **negative**. We further assume that α agrees with the coorientation of ξ , in the sense that it evaluates positively on vectors positively transverse to ξ .

By the Darboux theorem, a (positive) contact structure is locally modelled on the *standard* contact structure on \mathbb{R}^3 defined by the 1-form

$$\alpha_{\text{std}} := r^2 d\theta + dz.$$

Here, (r, θ, z) denote the standard cylindrical coordinates on \mathbb{R}^3 . Moreover, as opposed to foliations, contact structures are always smooth and quite *elastic*: a small C^1 perturbation of α is still a contact form, and by Gray stability theorem, the resulting contact structure is contact isotopic to the original one. We refer to the book [Gei09] for a thorough introduction to contact geometry and the standard definitions.

As for foliations, not every contact structure on a 3-manifold is interesting. Mirroring Thurston's existence theorem for foliations, Eliashberg showed that every homotopy class of oriented plane fields on M contains a contact structure, which is *overtwisted*. A contact structure ξ is **overtwisted** if there exists an embedded disk in M which is transverse to ξ except along its boundary and its center. It is **tight** otherwise, and **universally tight** if its universal cover is tight. Overtwisted disks are to contact structures what Reeb components are to foliations, as they make contact structures flexible. On the other hand, tight contact structures are more rigid and more scarce.

The choice of a contact form α induces a **Reeb vector field** R on M uniquely determined by

$$\alpha(R) = 1, \quad d\alpha(R, \cdot) = 0.$$

A contact structure is **hypertight** if it admits a contact form whose corresponding Reeb vector field has no contractible closed orbit. By a theorem of Hofer [Hof93], hypertight contact structures are universally tight, but the converse does not hold in general.¹

As opposed to Reebless or taut foliations, we would like to think of tight contact structures as *ductile* objects, both supple and rigid. Moreover, the classification problem for tight contact structures is perhaps more reasonable than its counterpart for taut foliations.² A *coarse classification* was established by [CGH09], and a fine classification is known for a number of 3-manifolds. Moreover, 3-dimensional contact topology benefits from an arsenal of tools and invariants, from convex surfaces to pseudoholomorphic curves.

¹The standard tight contact structure on S^3 is universally tight but not hypertight.

²It is not clear to us which equivalence relation on C^0 -foliations to consider, whereas the answer is clear for contact structures: contact isotopy!

Recently, Colin and Honda [CH20] showed a contact counterpart to Gabai’s existence theorem for taut foliations: every closed irreducible 3-manifold with positive first Betti number carries a hypertight contact structure. However, determining which rational homology spheres carry a (hyper)tight contact structure still remains an important open problem.

0.1.2 Eliashberg–Thurston approximation theorem

At first glance, foliations and contact structures appear to be diametrically opposed notions—compare (0.1) with (0.2). However, the two theories share many key features, such as the dichotomy between *flexibility* and *rigidity*. A first breakthrough revealing a deep connection between foliations and contact structures was obtained by Eliashberg and Thurston:

Theorem (Eliashberg–Thurston [ET98]). *Let \mathcal{F} be a \mathcal{C}^2 aspherical foliation on M . Then $T\mathcal{F}$ can be \mathcal{C}^0 -approximated by positive and negative contact structures. Moreover, if \mathcal{F} is taut, then its contact approximations are universally tight.*

Here, \mathcal{F} is **aspherical** if none of its leaves is homeomorphic to a sphere. By the Reeb Stability Theorem, \mathcal{F} is aspherical if and only if it is not homeomorphic to the product foliation by spheres on $S^1 \times S^2$, see [CC00, Theorem 6.1.6].

Tautness can be characterized by the existence of a closed 2-form ω that evaluates positively on leaves. If \mathcal{F} is taut, Eliashberg and Thurston constructed from such a 2-form a symplectic structure on $[-1, 1] \times M$, which is a *weak symplectic filling* of $(M, \xi_-) \sqcup (M, \xi_+)$ where ξ_{\pm} are negative and positive contact approximations of \mathcal{F} . They then appealed to a theorem of Eliashberg and Gromov to conclude that ξ_- and ξ_+ are universally tight.

This result provides an efficient way to construct (tight) contact structures by approximating (taut) foliations. It has been extended and generalized in various directions; we now summarize some of them.

\mathcal{C}^0 -foliations. Eliashberg–Thurston theorem was generalized to \mathcal{C}^0 -foliations independently by Kazez–Roberts [KR17] and Bowden [Bow16a].

Reebless foliations. Colin [Col02] showed that every \mathcal{C}^2 aspherical Reebless foliation \mathcal{F} can be approximated by universally tight contact structures. This has been strengthened by Bowden who showed that every \mathcal{C}^0 small contact approximation of \mathcal{F} is universally tight [Bow16b], and that Colin’s result holds for \mathcal{C}^0 -foliations [Bow16a].³

Foliations without invariant transverse measures. More recently, Zung showed in [Zun24] that a \mathcal{C}^2 foliation without invariant transverse measures \mathcal{F} can be approximated by contact structures whose Reeb vector fields are transverse to \mathcal{F} . Since \mathcal{F} is taut, these contact approximations are hypertight. Moreover, Zung (implicitly) shows that \mathcal{F} can be approximated by contact structures ξ_- and ξ_+ , negative and positive, respectively, supporting a *Liouville pair*: there exist contact forms α_{\pm} for ξ_{\pm} such that the 1-form

$$\lambda := e^{-s}\alpha_- + e^s\alpha_+ \tag{0.3}$$

on $\mathbb{R}_s \times M$ is a *Liouville form*, i.e., $d\lambda$ is a nondegenerate 2-form. We call the pair (α_-, α_+) a **Liouville pair** supported by (ξ_-, ξ_+) .

³However, it is not known if every sufficiently small contact approximation of a Reebless \mathcal{C}^0 -foliation is universally tight.

In view of Zung’s theorem and in order to simplify the terminology, we propose the following definition:

Definition 0.4. A \mathcal{C}^0 -foliation is **hypertaut** if it has no invariant transverse measures.

Hypertautness can be characterized by the existence of an *exact* 2-form $\omega = d\beta$ that evaluates positively on the leaves, see Lemma 4.3 below.

Anosov foliations. An interesting class of hypertaut foliations arises as the weak-(un)stable foliations of *Anosov flows*, see for instance the encyclopedic book [FH19] or the more accessible notes [Bar17]. In [Hoz22], Hozoori showed a correspondence between Anosov flows on 3-manifolds and a special class of Liouville pairs, that we call **Anosov Liouville pairs**. We upgraded this result in [Mas23] to a *homotopy equivalence* between the space of Anosov flows and the space of Anosov Liouville pairs. The latter structures can be thought of as very specific approximations of Anosov foliations that remember the hyperbolic nature of the flow.

Uniqueness of contact approximations. In [Vog16], Vogel proved that for most \mathcal{C}^2 foliations without torus leaves, all the (positive) contact structures in a sufficiently small neighborhood of $T\mathcal{F}$ are contact isotopic. Therefore, the contact approximations of Eliashberg–Thurston are unique for these foliations. However, some foliations on \mathbb{T}^3 have infinitely many pairwise non isotopic contact approximations.

Approximation versus deformation. A *contact deformation* of a \mathcal{C}^0 -foliation \mathcal{F} is a \mathcal{C}^0 -continuous 1-parameter family of plane fields (ξ_t) , $t \in [0, 1]$, where $\xi_0 = T\mathcal{F}$, and for $t > 0$, ξ_t is a contact structure. While \mathcal{C}^2 foliations ‘with enough holonomy’ can be deformed into contact structures (see [ET98, Proposition 2.9.2]), linear foliations without closed leaves on \mathbb{T}^3 do *not* admit contact deformations (see [Vog16, Corollary 9.11]). In contrast, Etnyre showed that any (cooriented) contact structure on a 3-manifold is a smooth deformation of a foliation, see [Etn07]. However, the foliations constructed by Etnyre *always* have Reeb components.⁴

0.1.3 A dictionary between foliations and contact pairs

While S^3 carries a (unique) tight contact structure, namely the standard one, it does not carry a Reebless foliation. Therefore, there is no hope to construct a geometrically relevant foliation from a *single* (tight) contact structure. Instead, one should consider a *pair* of contact structures with opposite orientation.

Definition 0.5. A **contact pair** on M is a pair (ξ_-, ξ_+) where ξ_- is a negative contact structure and ξ_+ is a positive contact structure. Both are cooriented. A **bicontact structure** is a contact pair (ξ_-, ξ_+) such that ξ_- and ξ_+ are everywhere transverse. A contact pair is **positive** if there exists a vector field v positively transverse to ξ_- and ξ_+ .

Alternatively, a contact pair (ξ_-, ξ_+) is positive if and only if at every point $p \in M$ with $\xi_-(p) = \xi_+(p)$, these two planes have the same orientation (and opposite coorientations). A bicontact structure is automatically positive. Positive contact pairs were introduced by Colin and Firmo in [CF11]. See also [CH20] for a summary (in English!) of Colin–Firmo’s paper.⁵

⁴Etnyre starts with an *open book decomposition* adapted to the contact structure, and inserts a suitable Reeb component at each component of the binding of the open book.

⁵Watch out: in [CH20], the authors use the terminology *contact pair* to mean *positive contact pair*!

Eliashberg–Thurston theorem and its variations naturally produce positive contact pairs as approximations of foliations. We shall think of the positive and negative contact approximations, and the way they interact, as capturing some information about the original foliation. We will need both of them to be able to ‘reconstruct’ the foliation, or rather produce a new one that is closely related to it.

To each adjective characterizing the rigidity class of a foliation—*Reebless*, *taut*, *hypertaut*, *Anosov*—we associate an adjective for positive contact pairs. Notice the implications:

$$\text{Anosov} \implies \text{Hypertaut} \implies \text{Taut} \implies \text{Reebless}.$$

Definition 0.6. Let (ξ_-, ξ_+) be a contact pair.

- It is **(universally) tight** if both ξ_{\pm} are (universally) tight.
- It is **strongly tight** if for every point $p \in M$, there exists a closed loop positively transverse to both ξ_{\pm} and passing through p .
- It is **Liouville** if there exists contact forms α_{\pm} for ξ_{\pm} such that (α_-, α_+) is a Liouville pair, i.e., the 1-form λ on $\mathbb{R} \times M$ defined by (0.3) is a Liouville form.
- It is **Anosov Liouville** if there exists contact forms α_{\pm} for ξ_{\pm} such that both (α_-, α_+) and $(-\alpha_-, \alpha_+)$ are Liouville pairs.

As we will see, the following implications hold:

$$\text{Anosov Liouville} \implies \text{Liouville} \implies \text{Strongly tight} \implies \text{Universally tight positive}.$$

Motivated by the previous results, we propose the following dictionary between foliations and positive contact pairs:

Foliations	Positive contact pairs
Reebless	Universally tight
Taut	Strongly tight
Hypertaut	Liouville
Anosov	Anosov Liouville

Table 1: A dictionary between foliations and positive contact pairs

An aspherical foliation satisfying a property in the left column is approximated by a positive contact pair with the corresponding property in the right column.⁶ With the notable exception of the (universally) tight case, we will show that a contact pair satisfying a property in the right column ‘integrates’ to a \mathcal{C}^0 -foliation with the corresponding property in the left column. In particular, a 3-manifold $M \neq S^1 \times S^2$ carries a taut \mathcal{C}^0 -foliation *if and only if* it carries a strongly tight contact pair; see Corollary D below.

⁶Strictly speaking, we do not know if Zung’s result for hypertaut foliations holds in the \mathcal{C}^0 setting. However, a hypertaut \mathcal{C}^0 -foliation approximates to a *Liouville fillable* contact pairs, see Proposition 4.4.

0.1.4 The L -space conjecture

It is an open problem to determine which irreducible rational homology spheres carry a taut foliation. The famous L -space conjecture provides a hypothetical answer:

Conjecture (L -space conjecture [BGW13; Juh15]). *Let M be an irreducible rational homology 3-sphere. The following are equivalent:*

1. M carries a cooriented taut foliation,
2. $\pi_1(M)$ is left-orderable,
3. M is not an L -space.

The second item can be thought of an algebraic characterization, while the third one comes from gauge theory. Here, a 3-manifold M is an L -space if its ‘hat’ Heegaard Floer homology is as small as possible, namely

$$\text{rank} \widehat{HF}(M) = |H(M, \mathbb{Z})|,$$

or alternatively if its reduced Heegaard Floer homology vanishes, $HF^{\text{red}}(M) = 0$. Lens spaces are examples of L -spaces. We refer to [Juh15] for an overview of Heegaard Floer homology. In this article, we are mostly interested in the relation between items 1 and 3 of the L -space conjecture. We do not know how the (non) orderability of $\pi_1(M)$ could relate to contact pairs.

In [OS04], Ozsváth and Szabó proved the implication $1 \implies 3$ by showing that the *contact class* of a contact approximation of the foliation provided by the Eliashberg–Thurston theorem is nonzero in HF^{red} . Interestingly, contact structures seem to have better interactions with gauge theory than foliations.⁷

One key difficulty to reverse Ozsváth–Szabó result and show that non- L -space irreducible rational homology spheres admit taut foliations is that very few general strategies are available to construct taut foliations. To our knowledge, all the known cases where the equivalence $1 \iff 3$ holds were obtained by rather ad hoc arguments, by considering a class of 3-manifolds and independently determining which are L -spaces and which admit a taut foliation. See for instance [BC17; Ras17; RR17; Han+20] for all graph manifolds, [Dun20] for a large census of hyperbolic manifolds, and [Kri20; Kri23; San23b; San23a; San23c] for 3-manifolds obtained by Dehn surgeries on suitable knots and links in S^3 . Moreover, these approaches are quite combinatorial and perhaps a bit miraculous in nature. Instead, we propose a general program to construct Reebless and taut foliations that remains closer to the argument of Ozsváth–Szabó. Before that, let us state and discuss our main results.

0.2 Statement of results

0.2.1 A new construction of foliations

In [CF11], the authors construct a *locally integrable* plane field from a *normal* positive contact pair. This technical condition can always be achieved after some *non generic* deformation of the pair. In Section 1, we explain how to generalize this construction for *any* contact pair, removing

⁷In [Zha22], Zhang associates to any *smooth* hypertaut foliation \mathcal{F} two nonzero invariants $c_{\pm}(\mathcal{F})$ in monopole Floer homology, without invoking the Eliashberg–Thurston theorem. However, this approach is still symplectic in nature as it relies on the construction of a suitable exact symplectic structure on $\mathbb{R} \times M$ depending on \mathcal{F} . This construction also requires a high degree of regularity for the foliation.

the normality condition. This will be important for some of our applications, in particular for Theorem E below.

To a contact pair (ξ_-, ξ_+) , we will associate a *canonical* vector field X satisfying $X \in \xi_- \cap \xi_+$, and vanishing exactly on the set $\Delta := \{p \in M \mid \xi_-(p) = \xi_+(p)\}$. As a first step to obtain a foliation \mathcal{F} from the contact pair, we construct a natural candidate for $T\mathcal{F}$:

Theorem A. *Let (ξ_-, ξ_+) be any positive contact pair on M and let $(\phi_t)_t$ be the flow of the associated vector field X .*

1. *The plane fields ξ_\pm^t defined by*

$$\xi_\pm^t(\phi_t(x)) := d\phi_t[\xi_\pm(x)] \quad (0.4)$$

converge uniformly to a continuous plane field η_u as t goes to $+\infty$.

2. *For a generic pair (ξ_-, ξ_+) , η_u is locally integrable on M .*

Moreover, η_u depends continuously on (ξ_-, ξ_+) .

Here, *generic* means that there exists an unspecified comeagre set of positive contact pairs for which 2 holds. We call η_u the **(weak-)unstable plane field** of the contact pair (ξ_-, ξ_+) . It is only continuous, and it is not necessarily *uniquely* integrable, even for bicontact structures; see for instance [ET98, Example 2.2.9]. However, we adapt the strategy of [BI08] to show:

Theorem B. *Let (ξ_-, ξ_+) be a positive contact pair on M . If either*

- ξ_- or ξ_+ is tight, or
- ξ_- and ξ_+ intersect along a generic link of saddle singularities (see Section 1.3),

then the unstable plane field η_u can be \mathcal{C}^0 -approximated by aspherical \mathcal{C}^0 -foliations.

This immediately implies the Main Theorem from the beginning of the introduction. Let us briefly sketch the proof of this result. By Theorem A, we can *canonically* associate to a generic positive contact pair (ξ_-, ξ_+) a pair (X, η_u) , where X is a smooth vector field and η_u is a continuous, locally integrable plane field tangent to X and invariant under the flow of X . We call such a pair a **polarized vector field**. By generically modifying (ξ_-, ξ_+) , we can further simplify the dynamics of X and precisely understand the behavior of η_u near the singularities of X . We then adapt the methods of [BI08] to show that η_u is tangent to a *branching foliation*, namely, a collection of immersed, ‘maximal’ surfaces in M which cover M , and which may intersect but cannot topologically cross. The whole Part II of this article is dedicated to this very technical and subtle construction. We finally appeal to a result in [BI08] to separate the leaves of the branching foliation and obtain a genuine foliation, at the expense of a \mathcal{C}^0 -small perturbation of η_u . This solves Problem 5.3 from [CH20].

In the special case where (ξ_-, ξ_+) is a bicontact structure, X is a **projectively (or conformally) Anosov flow** (see [ET98; Mit95]) and η_u coincides with the weak-unstable bundle of X . Our theorem implies that, without even modifying (ξ_-, ξ_+) , it is tangent to a branching foliation which can further be approximated by \mathcal{C}^0 -foliations.

With Theorem B in hand, it is now relatively easy to show:

Theorem C. *If (ξ_-, ξ_+) is a strongly tight contact pair, then η_u can be \mathcal{C}^0 -approximated by taut aspherical \mathcal{C}^0 -foliations.*

Combined with the results of [CKR19] and the (\mathcal{C}^0 version of) Eliashberg–Thurston theorem, we obtain:

Corollary D. *If $M \neq S^1 \times S^2$, then M carries a taut (topological) foliation if and only if it carries a strongly tight contact pair.*

In Section 4.2, we show that a Liouville contact pair is automatically positive and supports a Liouville pair whose Reeb vector fields are both transverse to η_u . This implies:

Theorem E. *If the contact pair (ξ_-, ξ_+) supports a Liouville pair, then η_u can be \mathcal{C}^0 -approximated by hypertaut \mathcal{C}^0 -foliations. Moreover, ξ_{\pm} are hypertight.*

Notice that supporting a Liouville pair is a \mathcal{C}^1 open condition for contact pairs. However, unlike strong tightness, it is *not* a \mathcal{C}^0 open condition. Besides, it is quite surprising to us that Liouville contact pairs are *automatically* hypertight; it is not true that a Liouville fillable contact structure is hypertight in general.

It turns out that the unstable plane field of a Liouville contact pair is quite rigid. For instance, it is \mathcal{C}^1 for Anosov Liouville pairs (see [Mas23]) and uniquely integrable in certain cases:

Theorem F (Corollary 4.15). *Let (ξ_-, ξ_+) be a Liouville contact pair on M . If either*

- ξ_{\pm} are everywhere transverse, or
- ξ_{\pm} intersect along a generic link of source singularities (see Section 1.3),

then η_u is uniquely integrable. Moreover, it is tangent to a hypertaut \mathcal{C}^0 -foliation.

Here, the Liouville condition imposes strong geometric and dynamical restrictions on η_u which force unique integrability. Perhaps more is true:

Question 0.7. *For a generic Liouville contact pair, is η_u uniquely integrable?*

Our techniques also provide a precise description of the *skeleton* of Liouville pairs on 3-manifolds:

Proposition G (Proposition 4.8). *Let (α_-, α_+) be a Liouville pair on M . The skeleton of the associated Liouville structure λ on $V = \mathbb{R}_s \times M$ defined by (0.3) is of the form*

$$\mathbf{ske}\ell(V, \lambda) = \text{graph}(\sigma) := \{(\sigma(x), x) \mid x \in M\}$$

for some continuous function $\sigma : M \rightarrow \mathbb{R}$.

In particular, the skeleton is a continuous, separating hypersurface homeomorphic to M . Interestingly, it is not smooth in general.

0.2.2 Application: transverse surgeries on taut foliations

Contact structures are more malleable objects than foliations. As an application of our machinery, we obtain that the existence of taut foliations is preserved under “large slope” surgeries along transverse links. For simplicity, we only discuss the case of knots, but our results immediately generalize to links.

Let $K \subset M$ be a framed knot. If $s \in \mathbb{Q}$ is a rational number, we denote by $M_K(s)$ the manifold obtained from M by performing a Dehn surgery of slope s along K .

If \mathcal{F} is a foliation on M transverse to K , performing a nontrivial Dehn surgery along K typically destroys \mathcal{F} , in the sense that \mathcal{F} does not induce a foliation on $M_K(s)$. It rather induces a singular foliation, which is singular along the image of K in $M_K(s)$. One could instead perform a *turbulization*⁸ (see [CC00, Example 3.3.11]) along K by spinning the leaves of \mathcal{F} along K hence creating a torus leaf around K , and inserting a Reeb component after surgery. Of course, this procedure *never* yields a taut foliation.

However, it is much easier to perform a surgery on an approximating contact pair and obtain a strongly tight contact pair on $M_K(s)$, provided that s is large enough. Combined with Theorem C, this implies:

Theorem H. *Let \mathcal{F} be a taut aspherical \mathcal{C}^0 -foliation on M , and $K \subset M$ be a framed knot transverse to \mathcal{F} . There exists $s_0 = s_0(K) \geq 0$ such that for every rational number $s \in \mathbb{Q}$ satisfying $|s| \geq s_0$, $M_K(s)$ carries a taut \mathcal{C}^0 -foliation \mathcal{F}' . Moreover, the image of K in $M_K(s)$ is transverse to \mathcal{F}' .*

See Section 3.2 for a detailed proof. As a corollary, we obtain a generalization of the main result of [LR14], with a somewhat easier and more natural proof.

Let $K \subset S^3$ be a nontrivial knot. We denote by $\mathcal{S}_K \subset \mathbb{Q}$ the set of rational slopes $s \in \mathbb{Q}$ such that there exists a taut \mathcal{C}^0 -foliation on $S^3 \setminus K$ which intersects the boundary of tubular neighborhood of K transversally along a nonsingular foliation of slope s . By a celebrated theorem of Gabai [Gab87], \mathcal{S}_K contains 0. By [LR14, Theorem 1.1], \mathcal{S}_K contains a neighborhood of 0. We actually get:

Corollary I. *\mathcal{S}_K is an open subset of \mathbb{Q} .*

We obtain this corollary as a rather brutal application of Theorem H for which we have little control on the number s_0 in such generality. Instead, it would be interesting to construct a concrete contact pair adapted to K and carefully analyze the slopes of the characteristic foliations of the contact structures on the boundary of a (potentially large) solid torus containing K . As a starting point, one could consider the case *fibred knots*. There is already an extensive literature on taut foliations in fibred knot complements, see [Rob01a; Rob01b; Kri20; Kri23]. Moreover, in view of the L -space conjecture and Heegaard Floer homology computations for Dehn surgeries on knots in S^3 (see [Kro+07; RR17]), one expects the following:

Conjecture. *If K is knot in S^3 with Seifert genus $g > 0$, then either $\mathcal{S}_K = \mathbb{Q}$, $\mathcal{S}_K = (-\infty, 2g-1) \cap \mathbb{Q}$, or $\mathcal{S}_K = (-2g+1, +\infty) \cap \mathbb{Q}$.*

However, to our knowledge, it is not known if $\mathcal{S}_K \subset \mathbb{Q}$ is an interval in general.

0.3 Discussion and further directions

0.3.1 Towards a contact L -space conjecture

While we are able to construct taut foliations from strongly tight contact pairs, our methods do not easily extend to tight contact pairs. However, we expect the following to be true:

Conjecture 1. *If $M \neq S^1 \times S^2$, then M carries a Reebless \mathcal{C}^0 -foliation if and only if it carries a tight positive contact pair.*

We give some evidence for this conjecture in Section 3.1. The main difficulty comes from the lack of regularity of the unstable plane field η_u , and the fact that Reeblessness is *not* a natural property for plane fields (see the *phantom Reeb components* from [CKR19]). Notice that this conjecture

⁸Sometimes spelled *turbularization*.

would immediately imply that on an *atoroidal* closed 3-manifold, the existence of a tight positive contact pair is equivalent to the existence of a taut foliation.

A contact pair can always be deformed into a positive one when one of its contact structures is overtwisted, see Proposition 1.4 below. However, there is little hope to construct geometrically interesting foliations from such a pair. Upgrading tight contact pairs to positive ones seems much more difficult. At the very least, we should further assume that the contact structures are homotopic as oriented plane fields, but this might not be enough. Indeed, Lin recently remarked that the existence of a taut foliation on a rational homology sphere imposes more constraints on the (monopole) Floer homology of the manifold, see [Lin23].⁹ In particular, HM_* has a *direct \mathbb{F} -summand*, where $\mathbb{F} = \mathbb{Z}/2\mathbb{Z}$. Moreover, the *contact invariants* of the contact approximations of the foliation have to pair to 1, for the natural perfect pairing

$$\langle \cdot, \cdot \rangle : HM_*(M) \otimes HM_*(-M) \longrightarrow \mathbb{F}$$

induced by the Poincaré duality isomorphism $HM^*(M) \cong HM_*(-M)$. This motivates the following

Definition 0.8. *A contact pair (ξ_-, ξ_+) on M is **algebraically tight** if the contact invariants $c(\xi_{\pm}) \in HM(\mp M)$ satisfy*

$$\langle c(\xi_-), c(\xi_+) \rangle = 1.$$

Notice that if (ξ_-, ξ_+) is algebraically tight, then ξ_- and ξ_+ are tight and homotopic as oriented plane fields. Indeed, the contact class of an overtwisted contact structure vanishes, and the grading of the contact class corresponds to the homotopy class of the contact structure (as an oriented plane field). We propose:

Conjecture 2. *Let (ξ_-, ξ_+) be an algebraically tight contact pair on M . Then (ξ_-, ξ_+) is homotopic through contact pairs to a positive one.*

Here, we think of the contact classes as potential *obstructions* to deforming a tight contact pair into a positive one. One possible approach to this conjecture would be to consider the set $\Delta_- \subset M$ where ξ_- and ξ_+ coincides with *opposite* orientations. It is generically an embedded link which is null-homologous if ξ_- and ξ_+ are homotopic. Perhaps one could study the link Floer or sutured Floer homology of the pair (M, Δ_-) and use the algebraic tightness hypothesis to precisely understand the topology of Δ_- . Additionally, there could be ‘elementary moves’ that would inductively simplify Δ_- . Some obstruction to performing these moves could be determined by Floer-theoretic invariants of the contact pair.

It remains to understand how to construct suitable tight contact structures on rational homology spheres. This is of course a very delicate problem, but perhaps more tractable than constructing taut foliations.

Question 0.9 (Contact realization). *Assume that M is an irreducible rational homology sphere.*

- *Which nonzero elements in the Floer homology of M can be realized as the contact class of a (necessarily tight) contact structure?*
- *If the Floer homology of M has a direct \mathbb{F} -summand, does M carry an algebraically tight contact pair?*

⁹It is known that (the various flavors of) monopole Floer homology and Heegaard Floer homology are isomorphic, so we simply refer to these invariants as ‘Floer homology’.

Assuming the previous two conjectures, a positive answer to the second item of this question would imply:

Conjecture 3. *If M is an irreducible rational homology sphere such that $HM_*(M)$ has a direct \mathbb{F} -summand, then M carries a Reebless \mathcal{C}^0 -foliation.*

Recently, Alfieri and Binns verified the existence of a direct \mathbb{F} -summand in Floer homology for a large class of non- L -space irreducible rational homology spheres [AB24].

0.3.2 Variations and refinements

We conclude this introduction with some potential generalizations of our main result.

Uniqueness of the foliation. While the polarized vector field (X, η_u) associated to a positive contact pair (ξ_-, ξ_+) is *canonical*, the (branching) foliation tangent to η_u that we construct is not. Indeed, it depends on a certain number of choices that are carefully described in Part II. Understanding how the foliation depends on these choices seems a completely impractical problem. In particular, we have a very limited understanding of the topology of the leaves of the foliation. One could think of our approach as sacrificing some knowledge about the leaves in order to gain extra flexibility that ultimately allows us to integrate η_u . This shall be contrasted with *branched surfaces theory*, a well-established approach to construct foliations and laminations in dimension three. Besides, a given continuous plane field might be tangent to many distinct foliations which have drastically different holonomy properties. However, η_u ‘remembers’ many of the geometric properties of the contact pair.

Parametric version. To simplify the construction of a (branching) foliation tangent to η_u , we impose some generic conditions on (ξ_-, ξ_+) that make the dynamics of X more tractable. We believe that the overall strategy of Part II is quite robust and some of these conditions may be weakened. In particular, we ask:

Question 0.10. *Let (ξ_-^t, ξ_+^t) , $t \in [0, 1]$, be smooth path of positive contact pairs on M , and assume that one of ξ_\pm^0 is tight. Does there exist a path of \mathcal{C}^0 -foliations (\mathcal{F}_t) , $t \in [0, 1]$, such that $T\mathcal{F}_t$ is uniformly \mathcal{C}^0 -close to η_u^t ?*

It is not absolutely clear to us which topology to consider on the space of \mathcal{C}^0 -foliations, since those are not determined by their tangent plane field. To answer this question, one would have to precisely understand the type of singularities that the associated vector field X can develop in a generic 1-parameter family, and adapt the various choices made in the non-parametric construction to this setting.

Version with boundary. We now assume that M is compact and has a nonempty boundary. Some of our constructions can be generalized to this setting. In particular, if (ξ_-, ξ_+) is a positive contact pair such that the associated vector field X is positively transverse to ∂M , then the construction of η_u goes through and yields a locally integrable plane field provided that the contact pair is generic. Moreover, the methods of Part II should extend to this setting so that Theorem B generalizes to manifolds with boundary. It would be interesting to first prescribe a 1-dimensional (branching) foliation tangent to $\eta_u \cap \partial M$ along ∂M and construct a (branching) foliation on M which restricts to the chosen one along ∂M . This way, one could potentially control the boundary slope of the foliation.

0.4 Acknowledgments

I am grateful to my PhD advisor John Pardon for his constant support and encouragements. This project greatly benefited from numerous discussions with Jonathan Bowden, Vincent Colin, Emmy Murphy, and Jonathan Zung. I would also like to thank Yasha Eliashberg, John Etnyre, Peter Ozsváth, and Bulent Tosun for their interest, and Anshul Adve and Siddhi Krishna for stimulating conversations.

Part I

From contact pairs to foliations

This first part contains the proofs of the main theorems stated in the introduction, assuming a technical result whose proof will be deferred to Part II.

1 Contact pairs revisited

In this section, we extend the main construction of [CF11] and we prove Theorem A. It will be important to avoid using the normal form for contact pairs from [CF11], as the deformation to a normal contact pair is *not generic*.

1.1 The setup

We first recall the following

Definition 1.1. A *contact pair* on M is a pair of cooriented contact structures (ξ_-, ξ_+) , negative and positive, respectively. A *bicontact structure* is a contact pair (ξ_-, ξ_+) such that ξ_{\pm} are everywhere transverse.

Let (ξ_-, ξ_+) be a contact pair. We write

- Δ_+ for the set of $p \in M$ such that $\xi_-(p) = \xi_+(p)$ as oriented planes,
- Δ_- for the set of $p \in M$ such that $\xi_-(p) = -\xi_+(p)$ as oriented planes,

and we let $\Delta := \Delta_- \sqcup \Delta_+$. The contact pair (ξ_-, ξ_+) is **positive** (resp. **negative**) if $\Delta_- = \emptyset$ (resp. $\Delta_+ = \emptyset$). Note that Δ has empty interior, since ξ_{\pm} define opposite orientations on M .

Remark 1.2. A contact pair (ξ_-, ξ_+) is positive if and only if there exists a (smooth) vector field v which is positively transverse to both ξ_- and ξ_+ . In that case, ξ_- and ξ_+ are homotopic as oriented plane fields, and their first Chern classes $c_1(\xi_-)$ and $c_1(\xi_+)$ agree. For a generic contact pair (ξ_-, ξ_+) , Δ is a smoothly embedded link. The Poincaré duals to the homology classes represented by Δ_{\pm} (with suitable orientations) are given by

$$\text{PD}[\Delta_{\pm}] = c_1(\xi_+) \pm c_1(\xi_-) \in H^2(M; \mathbb{Z}).$$

In particular, those are even classes which only depend on the homotopy classes of ξ_{\pm} . If (ξ_-, ξ_+) can be deformed through contact pairs into a positive contact pair, then Δ_- is null-homologous in M .

Assume now that Δ_- is null-homologous in M . Then ξ_- and ξ_+ are homotopic as plane fields if and only if the linking number $\text{lk}(\Delta_-, \Delta_+)$ of Δ_+ with Δ_- vanishes. This number is defined as the algebraic intersection number of Δ_+ (suitably oriented) with any oriented embedded surface $\Sigma \subset M$ with $\partial\Sigma = \Delta_-$. Let us choose an arbitrary Riemannian metric on g as well as a trivialization τ_- of TM in which ξ_- is constant. Identifying plane fields with their positive unit normal vectors, ξ_- becomes the constant map $M \rightarrow S^2$ equal to the North pole p_+ of S^2 , and ξ_+ becomes a map $\nu_+ : M \rightarrow S^2$. The South pole p_- of S^2 corresponds to $-\xi_-$. We then have

$$\Delta_{\pm} = \nu_+^{-1}(p_{\pm}).$$

Since $c_1(\xi_+) = c_1(\xi_-)$, ξ_- and ξ_+ are homotopic as oriented plane fields over the 2-skeleton of M . The obstruction to extending the homotopy over 3-cells is measured by a Hopf invariant for ν_+ with value in \mathbb{Z} . By an elementary version of the Pontryagin–Thom construction, this number equals the linking number $\text{lk}(\Delta_-, \Delta_+)$.

To summarize, ξ_- and ξ_+ are homotopic as oriented plane fields if and only if $[\Delta_-] = 0$ and $\text{lk}(\Delta_-, \Delta_+) = 0$.

As discussed in the introduction, it is a central question to understand when a contact pair can be deformed to a positive one:

Question 1.3. *Let (ξ_-, ξ_+) be a contact pair on M such that ξ_- and ξ_+ are homotopic as oriented plane fields. Can (ξ_-, ξ_+) be deformed into a positive contact pair? Are there further Floer-theoretic obstructions?*

The following proposition, suggested to us by Vincent Colin, gives an affirmative answer to this question when one of ξ_{\pm} is *overtwisted*:

Proposition 1.4. *Let ξ_+ be a positive contact structure on M .*

1. *There exists an overtwisted negative contact structure ξ_- on M such that (ξ_-, ξ_+) is a positive contact pair.*
2. *Let ξ_- be an overtwisted negative contact structure on M which is homotopic to ξ_+ as an oriented plane field. There exists path of negative contact structures $(\xi_-^\tau)_{0 \leq \tau \leq 1}$ such that $\xi_-^0 = \xi_-$, and (ξ_-^1, ξ_+) is a positive contact pair.*

Proof. By Etnyre [Etn07], there exists a smooth foliation \mathcal{F} on M such that ξ_+ is a deformation of $T\mathcal{F} = \eta$, in the sense that there exists a (smooth) 1-parameter family of smooth oriented plane fields $(\xi_+^\tau)_{0 \leq \tau \leq 1}$ such that $\xi_+^0 = \eta$, $\xi_+^1 = \xi_+$, and ξ_+^τ is a (positive) contact structure for $\tau > 0$. Moreover, the foliation \mathcal{F} has Reeb components by construction, and is approximated by *overtwisted* negative contact structures.¹⁰ Therefore, there exist an overtwisted negative contact structure ξ_-' and $0 < \tau \leq 1$ such that (ξ_-', ξ_+^τ) is a positive contact pair. Applying Gray’s stability yields 1. If ξ_- is a negative contact structure as in 2, then ξ_-' and ξ_- are two overtwisted negative contact structures which are homotopic as plane fields. Eliashberg’s classification of overtwisted contact structures [Eli89] implies that they are contact isotopic, and 2 follows easily. \square

Of course, Question 1.3 is much more interesting (and difficult!) in the the case where both ξ_{\pm} tight.

We now investigate some basic quantities associated with contact pairs. Let dvol be a volume form on M and α_{\pm} be contact forms for ξ_{\pm} satisfying

$$\alpha_+ \wedge d\alpha_+ = -\alpha_- \wedge d\alpha_- = \text{dvol}.$$

There exists a unique (smooth) vector field X on M such that

$$\alpha_{\pm}(X) = 0, \quad \iota_X \text{dvol} = \alpha_- \wedge \alpha_+.$$

¹⁰This essentially follows from an observation in [Etn07, Section 4]: an approximation of \mathcal{F} by a negative contact structure can equivalently be seen as an approximation by a positive contact structure after reversing the orientation of M ; in that case, the leaves of \mathcal{F} coming from the pages of the open book spiral towards the Reeb components in a *counterclockwise* manner, which implies overtwistedness.

Away from Δ , X is non-vanishing and spans the transverse intersection $\xi_- \pitchfork \xi_+$ with the correct orientation, and X vanishes along Δ . Note that X does not depend on the choice of dvol , so it only depends on the contact structures $\xi_{\pm} = \ker \alpha_{\pm}$. There exist smooth functions $f_0, g_0 : M \rightarrow \mathbb{R}$ defined by

$$\begin{aligned} d(\alpha_- \wedge \alpha_+) &= f_0 \text{dvol}, \\ \langle \alpha_-, \alpha_+ \rangle &= g_0 \text{dvol}, \end{aligned}$$

where

$$\langle \alpha_-, \alpha_+ \rangle := \alpha_- \wedge d\alpha_+ + \alpha_+ \wedge d\alpha_-.$$

The function g_0 does not depend on the choice of dvol , but the function f_0 does, since it is nothing more than the divergence of X for dvol :

$$\mathcal{L}_X \text{dvol} = f_0 \text{dvol}.$$

If dvol' is another volume form on M , there exists a unique function $\rho : M \rightarrow \mathbb{R}$ such that

$$\text{dvol}' = e^{\rho} \text{dvol}$$

and one easily checks that

$$f_0' = X \cdot \rho + f_0,$$

where f_0' is the divergence of X for dvol' . However, f_0 does not depend on dvol along Δ . Moreover:

Lemma 1.5. *Along Δ_+ , $f_0 \geq 2$ and along Δ_- , $f_0 \leq -2$.*

Proof. Along Δ_+ , there exists $u : \Delta_+ \rightarrow \mathbb{R}_{>0}$ such that

$$\alpha_+(p) = -u_+(p)\alpha_-(p).$$

Hence, if $p \in \Delta_+$,

$$f_0(p) = u_+(p) + \frac{1}{u_+(p)} \geq 2.$$

The case of Δ_- is similar. □

In particular, the divergence of X (for any volume form or metric) along Δ_+ (resp. Δ_-) is positive (resp. negative). We also define smooth functions $g_{\pm} : M \rightarrow \mathbb{R}$ by

$$\begin{aligned} \alpha_- \wedge d\alpha_+ &= g_+ \text{dvol}, \\ \alpha_+ \wedge d\alpha_- &= g_- \text{dvol}, \end{aligned}$$

so that $g_0 = g_- + g_+$ and $f_0 = g_- - g_+$. One easily checks that

$$\mathcal{L}_X \alpha_- = g_- \alpha_- + \alpha_+, \tag{1.1}$$

$$\mathcal{L}_X \alpha_+ = \alpha_- - g_+ \alpha_+. \tag{1.2}$$

Indeed, these formulae hold away from Δ since $\mathcal{L}_X \alpha_{\pm}$ vanish along X and can be written as linear combinations of α_{\pm} . The coefficients can be determined by wedging $\mathcal{L}_X \alpha_{\pm}$ with α_{\pm} . Since Δ has empty interior and all of the quantities involved are smooth, these formulae hold along Δ as well.

Remark 1.6. Let $p \in \Delta_+$. Since X is tangent to ξ_+ (and ξ_-), the linearization $d_p X$ of X at p has its image contained in $\xi_+(p)$. Indeed:

$$\alpha_+ \circ d_p X = \mathcal{L}_X \alpha_+(p) = d_p(\alpha_+(X)) + d\alpha_+(X(p), \cdot) = 0.$$

Let $L_p X : \xi_+(p) \rightarrow \xi_+(p)$ denote the restriction of $d_p X$ to $\xi_+(p)$. Then

$$\text{tr}(L_p X) = \text{tr}(d_p X) = \text{div}_p X = f_0(p) > 2$$

by Lemma 1.5, hence $\text{rank}(L_p X) \in \{1, 2\}$. If $\text{rank}(L_p X) = 2$, then the same holds for any nearby $p' \in \Delta_+$ and the constant rank theorem implies that Δ_+ is a 1-dimensional embedded submanifold of M near p . Moreover, Δ_+ is transverse to ξ_+ near p . If $\text{rank}(L_p X) = 1$, the situation is more complicated. Certainly, Δ_+ is ‘at most 2-dimensional’ near p . It might be a 2-dimensional embedded submanifold near p : the contact pair defined by the contact forms

$$\alpha_{\pm} = \pm dz - y dx$$

on \mathbb{R}^3 with standard coordinates (x, y, z) has $\Delta_+ = \{y = 0\}$. However, if $\text{rank}(d_p X) = 2$, then Δ_+ is 1-dimensional near p and tangent to $\xi_+(p)$ at p .

Besides, for a generic contact pair (ξ_-, ξ_+) , $\text{rank}(d_p X) = 2$ at every $p \in \Delta_+$, and $\text{rank}(L_p X) = 2$ at all but finitely many points in Δ_+ . It follows that Δ_+ is smoothly embedded link in M that is transverse to ξ_+ away from finitely many isolated points. The same properties hold for Δ_- .

1.2 Invariant plane fields

While Δ is a smoothly embedded link in M for a generic contact pair (ξ_-, ξ_+) , we won’t need to make such an assumption in the following proposition which generalizes [CF11, Proposition 2.4]. We fix an auxiliary volume form dvol on M which determines preferred of contact form α_{\pm} for ξ_{\pm} as in the previous section.

Proposition 1.7. Let (ξ_-, ξ_+) be any contact pair on M .

- There exists a unique continuous plane field η_u on $M \setminus \Delta_-$ satisfying
 1. X is tangent to η_u and η_u is invariant under the flow of X ,
 2. Away from Δ , $\eta_u \setminus \{0\}$ lies in the cone

$$C_+ := \{v \in T_p M \mid \alpha_{\pm}(v) > 0\} \cup \{v \in T_p M \mid \alpha_{\pm}(v) < 0\}$$

and along Δ_+ , η_u coincides with ξ_{\pm} .

Moreover, there exists a continuous 1-form α_s on M such that $\ker \alpha_s = \eta_u$ on $M \setminus \Delta_-$, $\alpha_s = 0$ on Δ_- , α_s is differentiable along X and

$$\mathcal{L}_X \alpha_s = r_s \alpha_s,$$

where $r_s : M \rightarrow \mathbb{R}$ is continuous function defined everywhere on M . Moreover, there exists a continuous 1-form α_u on M such that $\ker \alpha_u = \eta_s$ on $M \setminus \Delta_+$, $\alpha_u = 0$ on Δ_+ , α_u is differentiable along X and

$$\mathcal{L}_X \alpha_u = r_u \alpha_u,$$

where $r_u : M \rightarrow \mathbb{R}$ is a continuous function defined everywhere on M .

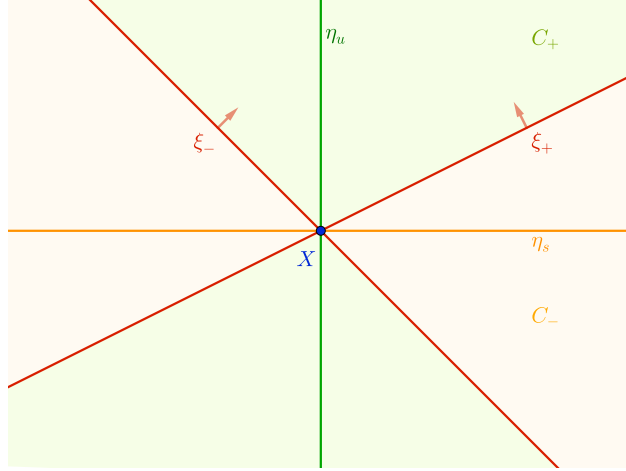

Figure 1: Away from Δ : the contact structures ξ_{\pm} with their respective coorientations, the cones C_{\pm} , and the plane fields η_u and η_s . The vector field X points toward the reader.

- Similarly, there exists a unique continuous plane field η_s on $M \setminus \Delta_+$ satisfying

1. X is tangent to η_s and η_s is invariant under the flow of X ,
2. Away from Δ , $\eta_s \setminus \{0\}$ lies in the cone

$$C_- := \{v \in T_p M \mid \pm \alpha_{\pm}(v) > 0\} \cup \{v \in T_p M \mid \pm \alpha_{\pm}(v) < 0\}$$

and along Δ_- , η_s coincides with ξ_{\pm} .

Moreover, there exists a continuous 1-form α_s on M such that $\ker \alpha_s = \eta_u$ on $M \setminus \Delta_-$, $\alpha_s = 0$ on Δ_- , α_s is differentiable along X and

$$\mathcal{L}_X \alpha_s = r_s \alpha_s,$$

where $r_s : M \rightarrow \mathbb{R}$ is continuous function defined everywhere on M .

The 1-forms α_u and α_s can be chosen so that the assignment

$$(\xi_-, \xi_+) \longmapsto (\alpha_s, \alpha_u)$$

defines a continuous map from the space of (smooth) positive contact pairs on M endowed with the C^∞ topology to the space of pairs of continuous 1-forms on M , endowed with the C^0 topology. We can further assume that

$$\alpha_s \wedge \alpha_u = \alpha_- \wedge \alpha_+, \quad r_s < r_u.$$

We call η_u (resp. η_s) the **(weak-)unstable** (resp. **(weak-)stable**) distribution of X . We call r_u (resp. r_s) the **expansion rate** in the weak-unstable (resp. weak-stable) direction of X (with respect to the specific choices of α_u and α_s). The plane fields η_u and η_s are both locally (but not necessarily uniquely) integrable on $M \setminus \Delta$. See Figure 1 for a sketch of the relative positions of ξ_{\pm} , η_u and η_s away from Δ .

Remark 1.8. If $\Delta = \emptyset$, i.e., if (ξ_-, ξ_+) is a bicontact structure, we recover the result of Eliashberg-Thurston [ET98] and Mitsumatsu [Mit95] which states that the flow Φ of X is a conformally/projectively Anosov. In that case, as their names suggest, η_u and η_s are the weak-unstable and weak-stable distributions of Φ , which are locally integrable but not necessarily uniquely integrable, see [ET98, Example 2.2.9]. In the more general setting where $\Delta \neq \emptyset$, we could call the flow Φ of X a *singular projectively Anosov flow*.

Proof of Proposition 1.7. We look for a 1-forms α_u and α_s of the form

$$\alpha_u = e^{-\sigma_u} \alpha_- + e^{\sigma_u} \alpha_+ \quad (1.3)$$

$$\alpha_s = e^{-\sigma_s} \alpha_- - e^{\sigma_s} \alpha_+ \quad (1.4)$$

where $\sigma_u, \sigma_s : M \rightarrow \mathbb{R}$ are continuous functions which are continuously differentiable along X . These 1-forms have to satisfy

$$\alpha_s \wedge \mathcal{L}_X \alpha_s = \alpha_u \wedge \mathcal{L}_X \alpha_u = 0,$$

which after some elementary computations is equivalent to

$$X \cdot \sigma_u = \sinh(2\sigma_u) + \frac{1}{2}g_0, \quad (1.5)$$

$$X \cdot \sigma_s = -\sinh(2\sigma_s) + \frac{1}{2}g_0. \quad (1.6)$$

For $p \in M$, we consider the ODE

$$(E_p) : \quad \dot{y}(t) = \sinh(2y(t)) + \frac{1}{2}g_0(\phi_X^t(p)),$$

where ϕ_X^t denotes the flow of X . After embedding M in some \mathbb{R}^N by the Whitney embedding theorem, we obtain a system of ODEs of the form of the ones studied in Appendix A, with

$$F(p, y, t) := \sinh(2y) + \frac{1}{2}g_0(\phi_X^t(p)).$$

This function F is easily seen to satisfy conditions (C1) and (C2) from Appendix A, so Lemma A.1 applies and we define $\sigma_u(p)$ as the unique initial value of (E_p) such that the corresponding maximal solution is defined on \mathbb{R} and is bounded. We readily get that $t \mapsto \sigma_u(\phi_X^t(p))$ is differentiable and is the unique bounded solution to (E_p) with initial value $\sigma_u(p)$, so σ_u is differentiable along X and solves (1.5). Note that on Δ , σ_u is given by

$$\sigma_u(p) = -\frac{1}{2} \sinh^{-1} \left(\frac{g_0(p)}{2} \right).$$

A similar argument shows that the assignment $(\xi_-, \xi_+) \mapsto \sigma_u \in \mathcal{C}^0(M)$ is continuous. Indeed, it is enough to show that if (ξ_-^n, ξ_+^n) , $n \geq 0$, is a sequence of positive contact pairs on M converging to (ξ_-, ξ_+) , then the corresponding sequence of functions σ_u^n , $n \geq 0$, converges to σ_u uniformly. The corresponding sequence of functions g_0^n , $n \geq 0$, converges to g_0 and the corresponding sequence of vector fields X_n , $n \geq 0$, converges to X , both in the \mathcal{C}^∞ topology. Therefore, we obtain a sequence of functions $F_n : M \times \mathbb{R} \times \mathbb{R} \rightarrow \mathbb{R}$ defined by

$$F_n(p, y, t) := \sinh(2y) + \frac{1}{2}g_0^n(\phi_{X_n}^t(p))$$

which converges to F in the $\mathcal{C}_{\text{loc}}^\infty$ topology. One easily checks that the hypotheses of Lemma A.2 are satisfied, hence σ_u^n converges to σ_u uniformly. As a result, α_u depends continuously on (ξ_-, ξ_+) .

We proceed similarly for σ_s by replacing X with $-X$.

Away from Δ_+ , α_u does not vanish and defines a continuous plane field η_s . Moreover, α_u vanishes along Δ_+ . Indeed, there exists a smooth function $u_+ : \Delta_+ \rightarrow \mathbb{R}_{>0}$ such that for $p \in \Delta_-$,

$$\alpha_+(p) = -u_+(p) \alpha_-(p).$$

This implies that if $p \in \Delta_+$,

$$g_0(p) = u_+(p) - \frac{1}{u_+(p)},$$

and since

$$g_0(p) = e^{-2\sigma_u(p)} - e^{2\sigma_u(p)},$$

we obtain that

$$e^{\sigma_u(p)} = \frac{1}{\sqrt{u_+(p)}},$$

hence

$$\alpha_u(p) = \sqrt{u_+(p)} \alpha_-(p) - \frac{1}{\sqrt{u_+(p)}} u_+(p) \alpha_-(p) = 0.$$

Similarly, α_s does not vanish away from Δ_- and defines a continuous plane field η_u on $M \setminus \Delta_-$, while it vanishes on Δ_- . Analogous computations show that $\eta_u = \xi_{\pm}$ along Δ_+ and $\eta_s = \xi_{\pm}$ along Δ_- .

The expansion rates r_u and r_s can now be computed, using (1.1), (1.2) and (1.5), (1.6):

$$r_u = \cosh(2\sigma_u) + \frac{1}{2}f_0, \tag{1.7}$$

$$r_s = -\cosh(2\sigma_s) + \frac{1}{2}f_0 \tag{1.8}$$

Therefore, r_u and r_s are continuous on M , and

$$r_u - r_s = \cosh(2\sigma_u) + \cosh(2\sigma_s) \geq 2.$$

Finally,

$$\alpha_s \wedge \alpha_u = 2 \cosh(\sigma_u - \sigma_s) \alpha_- \wedge \alpha_+,$$

but we can replace α_u and α_s with

$$\begin{aligned} \alpha'_u &:= \frac{1}{\sqrt{2 \cosh(\sigma_u - \sigma_s)}} \alpha_u, \\ \alpha'_s &:= \frac{1}{\sqrt{2 \cosh(\sigma_u - \sigma_s)}} \alpha_s, \end{aligned}$$

so that $\alpha'_s \wedge \alpha'_u = \alpha_- \wedge \alpha_+$ and $r'_u - r'_s = r_u - r_s \geq 2$. □

Remark 1.9. *It can be shown that $r_u = 0$ along Δ_- and $r_s = 0$ along Δ_+ . This is independent of the choice of α_u and α_s .*

1.3 Local integrability

To ensure local integrability of η_u along Δ_+ and of η_s along Δ_- , we will consider contact pairs satisfying some natural and *generic* conditions.

Definition 1.10. *The contact pair (ξ_-, ξ_+) is **regular** if the following conditions hold.*

- (R1) *The singular set $\Delta \subset M$ is a smoothly embedded link,*
- (R2) *There exist finitely many points q_i , $1 \leq i \leq n$, such that Δ has a quadratic contact with ξ_{\pm} at q_i , and away from these points, Δ is transverse to ξ_{\pm} ,*
- (R3) *At every point of Δ , the linearization of X has rank 2.*

It follows from standard transversality results that regular contact pairs form a comeagre set in the space of contact pairs. In particular, it is a dense subset by Baire's theorem. Writing $Q := \{q_i\}_{1 \leq i \leq n}$, it follows that points in $\Delta \setminus Q$ are of two types, depending on the sign of the determinant of the differential of X in the normal direction:

- Either this determinant is positive, and the singularity is a *source* (on Δ_+) or a *sink* (on Δ_-), or
- This determinant is negative, and the singularity is a *saddle*.

Hence, we can write

$$\Delta \setminus Q = \Delta_{\text{so}} \sqcup \Delta_{\text{si}} \sqcup \Delta_{\text{sa}},$$

where Δ_{so} (resp. Δ_{si} , Δ_{sa}) is the disjoint union of open intervals in Δ corresponding to source (resp. sink, saddle) points.

Note at every point $p \in \Delta_+$, the linearization of X is tangent to $\eta_u(p) = \xi_+(p)$ by Remark 1.6. Similarly, at every point $p \in \Delta_-$, the linearization of X is tangent to $\eta_s(p)$.

The next Proposition generalizes [CF11, Proposition 2.5] by removing the normality assumption. We also fill some gaps and clarify some subtleties.

Proposition 1.11. *Let (ξ_-, ξ_+) be a regular contact pair. Then η_u is locally integrable on $M \setminus \Delta_-$, and η_s is locally integrable on $M \setminus \Delta_+$.*

Proof. We show that η_u is locally integrable at every point $p \in M \setminus \Delta_-$. We distinguish four cases.

Case 0: $p \in M \setminus \Delta$. Then $X(p) \neq 0$ and local integrability of η_u at p is standard, see [CF11, Proposition 2.5].

Case 1: $p \in \Delta_{\text{so}}$. By the Unstable Manifold Theorem, there exists a germ of smooth surface $S^u = S^u(p)$ passing through p such that X is tangent to S^u and $T_p S^u = \eta_u(p) = \xi_{\pm}(p)$. Moreover, there exist smooth coordinates (x, y, z) near p in which the linearization of X at 0 writes

$$X_1 = ax\partial_x + by\partial_y,$$

where $a, b > 0$. Applying [Tak74, Theorem (1.13)], and noting that X has a line of singularities passing through 0, we obtain that X is *topologically* equivalent to the vector field

$$X' = x\partial_x + y\partial_y.$$

In these last coordinates, $S^u \subset \{z = 0\}$.

We claim that η_u is tangent to S^u in a neighborhood of p . Indeed, if $\eta_u(p')$ and $T_{p'}S^u$ disagree at a point $p' \in S^u$ near p , we consider a small disk D passing through p' and transverse to X . The intersection of η_u with this disk yields a continuous vector field on D , for which we can find a small flow line γ passing through p' . Because of the above (topological) normal form for X near p , there exists a point $p'' \in \gamma$ which is contained in the unstable manifold \tilde{S}^u of a point $\tilde{p} \in \Delta$ distinct from p . Under the backward flow of X , p' converges to p and p'' converges to \tilde{p} . This implies that the curve obtained by flowing γ along X for a sufficiently negative time cannot be everywhere tangent to η_u , which is a contradiction.

As a result, $TS^u = \eta_u$ along S^u , and S^u is a germ of integral surface of η_u around p . This also shows that η_u is *uniquely* integrable at p , and the characteristic foliations of ξ_{\pm} coincide on S^u and are directed by X . The previous paragraph also implies the following property: if $S \subset M \setminus \Delta$ is an connected immersed surface tangent to η_u and if the backward flow line of X passing through some $p' \in S$ converges to $p \in \Delta_{\text{so}}$, then S is contained in the unstable manifold of X at p , i.e., the saturation of $S^u(p)$ by the flow of X . This property will be crucial in Case 3 below.

Case 2: $p \in \Delta_{\text{sa}}$. The strategy of [CF11, Proof of Proposition 2.5] can be adapted to this more general setting.¹¹ By the Invariant Manifolds Theorem, there exist smooth coordinates (x, y, z) near p such that

- The linearization X_1 of X at 0 is

$$X_1 = ax\partial_x - by\partial_y,$$

where $a, b > 0$.¹²

- Δ is contained in $\{x = y = 0\}$,
- The weak unstable manifold of X is contained in $\{y = 0\}$ and the strong unstable manifold of X at 0 is contained in $\{y = z = 0\}$,
- The weak stable manifold of X is contained in $\{x = 0\}$ and the strong stable manifold of X at 0 is contained in $\{x = z = 0\}$.

It follows that in these coordinates, $\eta_u(0) = \text{span}\{\partial_x, \partial_y\}$. We can also find small constants $\epsilon, \delta_x, \delta_y > 0$ such that the following properties hold. Both η_u and X are transverse to the disks

$$\begin{aligned} D_x^{\pm} &:= \{x = \pm\epsilon, y^2 + z^2 \leq \delta_x^2\} \\ D_y^{\pm} &:= \{y = \pm\epsilon, x^2 + z^2 \leq \delta_y^2\} \end{aligned}$$

and all the flow lines of X starting on D_y^{\pm} either intersect D_x^{\pm} or converge to Δ . By flowing D_y^{\pm} along X , we obtain four smooth maps

$$f^{i,j} : D_y^i \cap \{jx > 0\} \longrightarrow D_x^j,$$

where $i, j \in \{-, +\}$. Moreover, $df^{i,j}$ send the intersection of D_y^i with η_u to the intersection of D_x^j with η_u , and if we write

$$p_x^{\pm} := (\pm\epsilon, 0, 0), \quad p_y^{\pm} := (0, \pm\epsilon, 0),$$

¹¹In [CF11], the authors use that at a saddle point, X is conjugated to its linearization; however, this conjugation is only *continuous* in general!

¹²Since X has positive divergence along Δ_+ , we even have $b < a$. Unlike in [CF11], this won't be relevant in our proof.

then

$$\lim_{p \rightarrow p_y^i} f^{i,j}(p) = p_x^j$$

for every $i, j \in \{-, +\}$. The latter can be seen by *topologically* conjugating X with its linearization at 0, see [Tak74, Theorem (1.13)]. See Figure 2 for a lower dimensional sketch.

Since η_u intersects D_y^\pm along a continuous vector field, we can find small integral curves $\gamma_y^\pm : (-\delta, \delta) \rightarrow D_y^\pm$ tangent to η_u and with $\gamma_y^\pm(0) = p_y^\pm$, where $0 < \delta < \delta_y$. Flowing these curves along X , i.e., applying the maps $f^{i,j}$, we obtain four curves

$$\gamma_x^{i,j} : I^i \longrightarrow D_x^j,$$

where $I^- = (-\delta, 0)$ and $I^+ = (0, \delta)$, which are both tangent to η_u . Moreover,

$$\lim_{t \rightarrow 0} \gamma_x^{i,j}(t) = p_x^j,$$

so the union of $\gamma_x^{i,j}$ and $\gamma_x^{-i,j}$ can be continuously extended to a curve

$$\gamma_x^j : (-\delta, \delta) \longrightarrow D_x^j$$

with $\gamma_x^j(0) = p_x^j$. The key point is that since the γ_x^\pm 's are continuous, continuously differentiable away from 0, and their derivatives extend continuously at 0, these curves are in fact \mathcal{C}^1 .

The union of all of the flow lines of X starting from γ_y^\pm produce two open surfaces S^\pm such that

$$S := S^- \cup \{|x| \leq \epsilon, y = z = 0\} \cup S^+$$

is a surface which can be written as the graph of a continuous function $f : U \subset \mathbb{R}^2 \rightarrow \mathbb{R}$ near 0. Here, U denotes an open neighborhood of 0 in \mathbb{R}^2 . Note that $S \cap D_x^\pm = \gamma_x^\pm$. By the previous paragraph, f is differentiable away from 0 and its graph is tangent to η_u . The differentiability of f along $\{|x| \leq \epsilon, y = z = 0\} \setminus \{0\}$ follows from the differentiability of γ_x^\pm . Moreover, f has (vanishing) partial derivatives at 0, and its partial derivatives are continuous on U . As a result, f is \mathcal{C}^1 on U and is everywhere tangent to η_u , so S is a local integral surface for η_u near 0.

Case 3: $p \in Q$. This is the most delicate case. For the sake of clarity, we divide it into three steps.

- *Step 0 : setting things up.* We start with a *topological* description of the flow lines of X near p . Following [CF11, Proof of Lemme 2.2], there exist smooth coordinates (x, y, z) around p such that the linearization of X at 0 is of the form

$$X_1 = ax\partial_x + z\partial_y,$$

where $a > 0$, and Δ is included in $\{x = 0, z + y^2 = 0\}$. We can further assume that the strong unstable manifold of X at 0 is included in $\{y = z = 0\}$. By [Tak74, Theorem (1.11)], for every $k \geq 1$, there exists a germ S^c of center manifold of class \mathcal{C}^k passing through 0 which is tangent to the plane $\{x = 0\}$ at 0, and such that X is tangent to S^c along it. Let us take $k = 10$ for safety. We denote by $Y = Y(y, z)$ the restriction of X to $\{x = 0\}$, which is of class \mathcal{C}^k and has vanishing 1-jet at 0. By [Tak74, Theorem (1.13)], X is *topologically* equivalent near 0 to the vector field

$$X' = ax\partial_x + z\partial_y + Y(y, z).$$

Notice that S^c contains Δ . Writing $Z(y, z) = z\partial_y + Y(y, z)$, Z is a \mathcal{C}^k vector field in the (y, z) -plane whose linearization at 0 is $z\partial_y$. Moreover, we can assume that in these new coordinates,

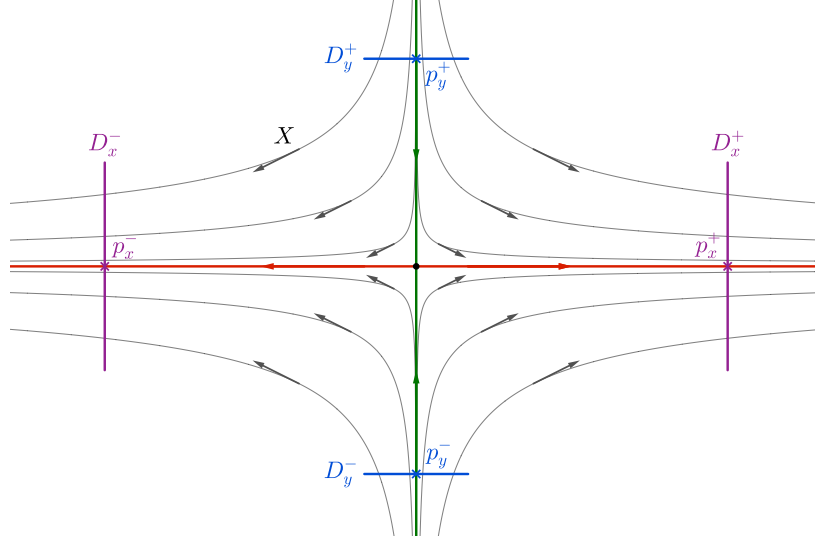

Figure 2: The 2-dimensional analogue of Case 2.

Δ is the line $\{x = z = 0\}$. This implies that for every y sufficiently small, $Y(y, 0) \cong 0$, so we can write $Y(y, z) = zQ(y, z)$, where Q is a C^{k-1} vector field vanishing at $(0, 0)$. We consider the vector field

$$G(y, z) := \partial_z + Q(y, z),$$

so that

$$Y = z(\partial_y + Q(y, z)).$$

Here, G is mostly horizontal. Moreover, the points in $\{y > 0, z = 0\}$ correspond to singularities of X in Δ_{so} , while the points in $\{y < 0, z = 0\}$ correspond to singularities of X in Δ_{sa} . Therefore, the flow lines of G passing through a point $(y, 0)$ with $y < 0$ are *topologically* negatively transverse to the y -axis, while the flow lines of G passing through $(y, 0)$ with $y > 0$ are topologically positively transverse to the y -axis. One easily deduces that the flow line of G passing through $(0, 0)$ only intersects the y -axis at $(0, 0)$ and stays in the half-plane $\{z > 0\}$ away from $(0, 0)$. Moreover, every flow line of G passing through $(y, 0)$ for $y < 0$ sufficiently close to 0 intersects $\{y > 0, z = 0\}$. Those flow lines corresponds to connections from Δ_{sa} to Δ_{so} in a neighborhood of p . The other stable branches of Δ_{sa} near p all escape the chosen coordinate neighborhood of p .

Since G has a unique flow line passing through 0, Y has a unique flow line converging to 0 in positive time, and a unique flow line converging to 0 in negative time. In summary, we obtain that

- There exists a unique flow line of X converging to 0, and
- The set of the points near 0 which are converging to 0 under the backward flow of X is a *topological* surface with boundary, whose boundary contains 0 and is contained in $\{y = z = 0\}$.

Unfortunately, we cannot conclude that this half-surface is tangent to η_u since we don't know that it is C^1 yet.

We now restrict our attention to the box

$$B_\epsilon := \{|x| \leq \epsilon, |y| \leq \epsilon + \sqrt{\epsilon}, |z| \leq \epsilon\}$$

for $\epsilon > 0$ small enough. Still from [CF11, Proof of Lemme 2.2], for ϵ sufficiently small, X is transverse to the vertical faces

$$F_x^\pm := \{x = \pm\epsilon\} \cap \mathbb{B}_\epsilon, \quad F_y^\pm := \{y = \pm(\epsilon + \sqrt{\epsilon})\} \cap \mathbb{B}_\epsilon,$$

and enters \mathbb{B}_ϵ along the face F_y^- and exits along the other vertical faces. Here, X has source singularities along $\Delta \cap \{y > 0\}$ and saddle singularities along $\Delta \cap \{y < 0\}$. Moreover, every backward flow line of X starting on $\partial\mathbb{B}_\epsilon$ either converges to a point in Δ , or exits $\partial\mathbb{B}_\epsilon$ through the face F_y^- or the top face $F_z^+ := \{z = \epsilon\} \cap \mathbb{B}_\epsilon$.

We can find continuous simple curves $\gamma_u^\pm \subset F_x^\pm$ starting at $x^\pm := \{x = \pm\epsilon, y = z = 0\}$ and ending on the interior of $F_x^\pm \cap \{z = -\epsilon\}$, the bottom edge of F_x^\pm , such that under the flow of $-X$, every point in $\gamma_u^\pm \setminus \{x^\pm\}$ converges to a point in $\Delta \cap \{y > 0\}$. In other words, points in $\gamma_u^\pm \setminus \{x^\pm\}$ lie in the intersection of the unstable disks of the source points in $\Delta \cap \{y > 0\}$ with F_x^\pm . Similarly, we can find a continuous simple curve $\gamma_b \subset F_y^-$ intersecting the interior of the bottom edge of F_y^- such that every point in γ_b converges to a point in $\Delta \cap \{y < 0\}$ under the flow of X , except one of its endpoints y_b which converges to 0. In other words, every point of γ_b lies in the stable manifold of a saddle point in Δ , or in the stable branch of X at 0. Notice that γ_b is contained in the intersection of S^c with F_y^- .

We define a smoothing Σ of the union of the exit vertical faces $F_x^- \cup F_y^+ \cup F_x^+$ as follows. We first consider a \mathcal{C}^0 -small smoothing \tilde{c} of the piecewise linear planar curve

$$c := \{x = -\epsilon, |y| \leq \epsilon + \sqrt{\epsilon}\} \cup \{|x| \leq \epsilon, y = \epsilon + \sqrt{\epsilon}\} \cup \{x = \epsilon, |y| \leq \epsilon + \sqrt{\epsilon}\}$$

such that \tilde{c} coincides with c away from a small neighborhood of the corners of c and is contained in the rectangle $\{|x| \leq \epsilon, |y| \leq \epsilon + \sqrt{\epsilon}\}$. We then set

$$\Sigma := \{(x, y, z) \in \mathbb{B}_\epsilon \mid (x, y) \in \tilde{c}, |z| \leq \epsilon\}.$$

An appropriate choice of \tilde{c} ensures that X is positively transverse to Σ , and the curves γ_u^\pm lie on Σ . If the curve \tilde{c} is parametrized by the variable $s \in [-1, 1]$, we obtain coordinates (s, z) on Σ in which Σ is simply the rectangle $[-1, 1] \times [-\epsilon, \epsilon]$. We will assume that x^+ and γ_u^+ are contained in $[-1, 0) \times [-\epsilon, \epsilon]$, and x^- and γ_u^- are contained in $(0, 1] \times [-\epsilon, \epsilon]$; see Figure 3.

In the next steps, we construct a germ of integral surface for η_u passing through 0 as follows. We construct two (germs of) integral surfaces with boundary $S^\pm \subset \mathbb{B}_\epsilon$, such that the unstable manifold of X at 0 is contained in the boundaries of S^\pm , and such that $S = S^- \cup S^+$ is the graph of a continuous function near 0. Then, the same argument as in Case 2 will show that S is \mathcal{C}^1 .

- *Step 1: construction of S^- .* We adapt the reasoning of Case 2. Choosing ϵ sufficiently small, the center manifold S^c intersects the face F_y^- along a \mathcal{C}^1 curve γ_c ; this curve divides F_y^- into two halves, and contains the curve γ_b . The specific form of the linearization of X at 0, and the topological normal form from Step 0 imply the following property: if $(x_n)_n$ is a sequence of points in $F_y^- \setminus \gamma_c$ converging to y_b from the $x > 0$ (resp. $x < 0$) side at a sufficiently small asymptotic slope with respect to the plane $\{z = 0\}$, then for n large enough, the flow line of X passing through x_n exits \mathbb{B}_ϵ along F_x^+ (resp. F_x^-), and the intersection of this flow line with the corresponding face converges to x^+ (resp. x^-) when n goes to ∞ . Since η_u is transverse to S^c at 0, it intersects γ_c transversally at y_b along the face F_y^- . We can further shrink ϵ to make the angle between $\eta_u(y_b)$ and the plane $\{z = 0\}$ sufficiently small. As in Case 2, we then choose a flow line of $\eta_u \cap F_y^-$ passing through y_b . We flow it along X to obtain a surface whose union with $\{y = z = 0\}$, denoted by S^- , is a surface with boundary tangent to η_u .

x^+ ,¹³ and which exits Σ at $(s_{\text{sup}}, \epsilon)$. By assumption, we have $s_{\text{sup}} < 1$. There exists a small $\delta > 0$ such that the point $x' := (s_{\text{sup}}, \epsilon - \delta)$ escapes B_ϵ when flown backward along X , and escapes Σ along its top or lateral boundary when flown along X_u . We now consider a flow line γ' of $-X_u$ starting at x' . It cannot intersect γ_{sup} , since otherwise, we could merge a portion of γ_{sup} with a portion of γ' and obtain a flow line of X_u starting at x^+ and escaping Σ along a point on the top boundary further right than $(s_{\text{sup}}, \epsilon)$, or on the lateral boundary of Σ , and both of these excluded by hypothesis. Therefore, γ' has to pass below x^+ and intersect γ_u^+ . This is also excluded, since some point on γ' converges to 0 under the backward flow of X by the topological normal form of X near p , which contradicts a previous argument.

To summarize, we now know that there exists a flow line of X_u passing through x^+ and which exits Σ on its lateral boundary $\partial_v^- \Sigma$. Such a flow line is not allowed to intersect γ_u^- , so it necessarily passes above x^- . We consider the set \mathcal{Z} of $z \in (-\epsilon, \epsilon)$ such that there exists a flow line of X_u starting at x^+ , passing through (s^-, z) , and escaping Σ along $\partial_v^- \Sigma$. Here, $x^- = (s^-, z^-)$. Similarly as before, we define $z_{\text{inf}} := \inf \mathcal{Z}$, and we can obtain a flow line γ_{inf} starting at x^+ and passing through (s^-, z_{inf}) . We know that $z_{\text{inf}} \geq z^-$. If $z_{\text{inf}} > z^-$, arguing as before, we could obtain a flow line γ'' of $-X_u$ starting at x^- and intersecting γ_u^+ , which is impossible. Therefore, $z_{\text{inf}} = z^-$ and γ_{inf} passes through x^- . In other terms, we have shown the existence of a pre-lasso.

We now explain how to construct a lasso, i.e., a pre-lasso such that all of its points converge to 0 under the backward flow of X . Let \mathcal{L} be the set of (unparametrized) pre-lassos $\ell \subset \Sigma$, i.e., the set of \mathcal{C}^1 curves on Σ tangent to X_u starting at x^+ and ending at x^- . We can assume without loss of generality that $z^+ = -1/2$ and $z^- = 1/2$. For $\ell \in \mathcal{L}$, we consider its intersection point $(0, z_0)$ with the vertical line $\{s = 0\} \cap \Sigma$. Arguing as before, by taking the infimum of such values of z_0 , we obtain a pre-lasso ℓ_0 passing through a point $(0, z_0)$ which converges to 0 under the backward flow of X . Arguing inductively, we can construct a sequence $(\ell_n)_n$ of pre-lassos such that for every n and every dyadic number \mathfrak{d} of height at most n in $[-1/2, 1/2]$, the intersection point of ℓ_n with $\{s = \mathfrak{d}\} \cap \Sigma$ converges to 0 under the backward flow of X , and ℓ_m intersects $\{s = \mathfrak{d}\} \cap \Sigma$ at this same point when $m \geq n$. Passing to a subsequence, these pre-lassos converge to a pre-lasso ℓ_∞ such that a dense subset of its points converge to 0 under the backward flow of X . Since the points on ℓ not converging to 0 form an open subset of ℓ , we obtain that ℓ_∞ is a lasso.

As explain before, we obtain a surface S^+ by flowing a lasso ℓ under the backward flow of X . The boundary of S^+ is then $\ell \cup (\{y = z = 0\} \cap B_\epsilon)$, and S^+ is everywhere tangent to η_u .

Finally, the union S of S^- and S^+ inside of B_ϵ is a continuous surface which can be written as the graph of a continuous function f . Arguing as in Case 2, by looking the intersection of this surface with F_x^\pm near x^\pm , we conclude that f is in fact \mathcal{C}^1 , so S is an integral surface for η_u passing through 0. \square

Remark 1.12. *Handling Case 3 is particularly tricky because we are not aware of a sufficiently nice \mathcal{C}^1 normal form for X near a quadratic point $p \in Q$.*

Remark 1.13. *It is worth noting that in [CF11], the authors assume that (ξ_-, ξ_+) is in normal form to show the existence of (η_u, η_s) , as they need to show that the limits of ξ_\pm along the flow of X exist. With the present method, we show the existence without any assumption on (ξ_-, ξ_+) . Then, even though [CF11] also uses the normal form to show local integrability along Δ , what is really*

¹³This is because a \mathcal{C}^1 function $\gamma : I \rightarrow \mathbb{R}$ defined on an interval containing 0 is a solution to the ODE $\dot{y}(t) = F(y(t))$ if and only if it satisfies $y(t) = y(0) + \int_0^t F(y(s)) ds$ for every $t \in I$.

needed for the proof is a precise understanding of the qualitative behavior of X near Δ . This can be achieved under some genericity assumption on (ξ_-, ξ_+) only, the point being that a plane field invariant under a possibly singular but sufficiently nice vector field tangent to it is locally integrable, even at the singularities.

The following lemma provides a more refined description of the integral surfaces of η_u passing through a quadratic point $p \in Q$:

Lemma 1.14. *Let $p \in Q$ be a quadratic contact point. There exists a unique flow line $\gamma_s = \gamma_s(p)$ of X converging to p . Moreover, there exists a unique (germ of) surface with boundary $S^u = S^u(p)$ whose boundary contains p and is contained in the unstable manifold of X at p , and such that X is tangent to S^u . The plane field η_u is tangent to S^u and is uniquely integrable along S^u in the following sense. If (S, q) is a germ of integral surface of η_u at $q \in M$, then*

- *If q lies in the interior of S^u , then $S \subset S^u$.*
- *If q lies in the boundary of S^u , then the unstable branches of X at p divide S into two surfaces with boundary, one of which is entirely contained in S^u .*

Therefore, every (germ of) integral surface S of η_u at p is the union of two surfaces with boundary S^+ and S^- , where

- *The boundary of S^\pm contains p and is contained in the unstable manifold of X at p ,*
- *S^+ is included in the saturation of S^u by the flow of X ,*
- *S^- contains γ_s .*

Hence, as a germ at p , S is entirely determined by its intersection with a small disk transverse to γ_s .

We call $\gamma_s(p)$ the **stable branch** of X at p , and $S^u(p)$ the **unstable half-disk** of X at p .

Proof. In the proof of Proposition 1.11, we saw that there is a unique flow line of X converging to p , and the flow lines converging to p in backward times form a topological half-disk containing p and the stable branches of X at p . We also constructed a C^1 half-disk near p tangent to η_u satisfying these properties, so these two half-disks coincide. In particular, this unstable half-disk is C^1 . Moreover, the lasso ℓ constructed in the proof of Proposition 1.11 is unique, and $y_b \in F_y^-$ is the unique point in F_y^- converging to 0 under the flow of X . See Figure 4 for a detailed picture of Σ .

We now show that η_u is uniquely integrable along S^u in the sense of the statement of the lemma. Otherwise, there would exist a point $p_0 \in \ell \subset \Sigma$ and a small integral curve γ_0 of X_u containing p_0 which is not contained in ℓ . After deleting a portion of γ_0 and without loss of generality, we can assume that $\gamma_0 \cap \ell = \{p_0\}$, p_0 is the left boundary point of γ_0 , and $p_0 \neq x^-$. Note that γ_0 necessarily lies above ℓ , as points below ℓ lie in the unstable manifolds of source singularity in Δ . Moreover, if γ_0 is sufficiently short, all of the points in $\gamma_0 \setminus \{p_0\}$ are flown to the back face F_y^- of the box B_ϵ under the backward flow of X . The intersection points of F_y^- with these flow lines form a continuous curve γ_0^- which is tangent to $\eta_u \cap F_y^-$, and one of its ends converges to y_b . It follows that $\gamma_0^- \cup \{y_b\}$ can be described near y_b as the graph of a C^1 curve. However, by Step 1 in Case 3 of the proof of Proposition 1.11, the (forward) flow lines of X starting at points in γ_0^- near $\{y_b\}$ would intersect ∂B_ϵ away from ℓ , which is a contradiction.

The description of an integrable surface S near p then follows from the proof of Proposition 1.11. \square

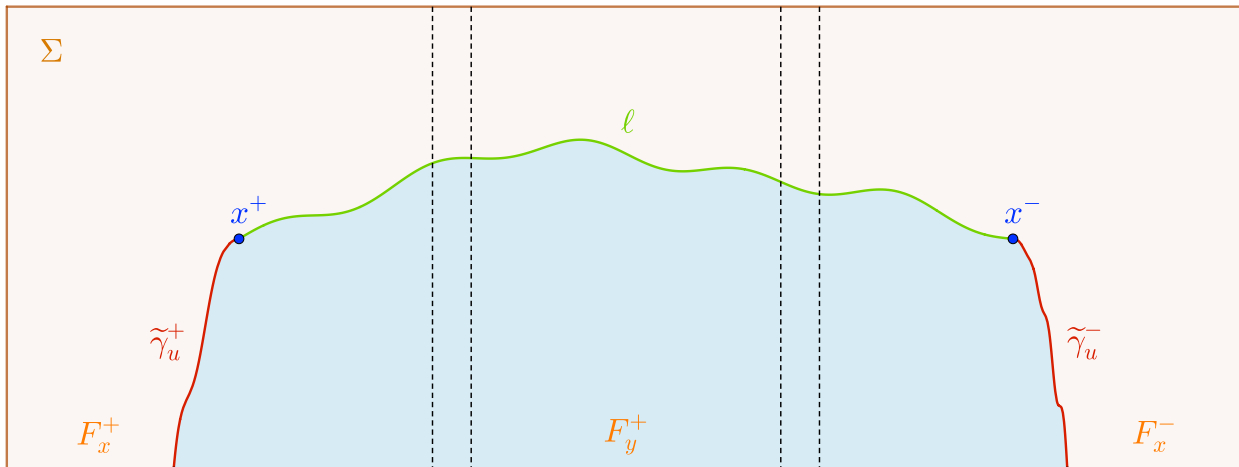

Figure 4: The surface Σ and its unique lasso ℓ . The curves $\tilde{\gamma}_u^\pm$ are the intersection of Σ with the unstable manifolds of the saddle points on Δ . The blue region is the intersection of Σ with the unstable manifolds of the source points on Δ . All of the points in the orange region leave the box B_ϵ when flowed backward along X .

Remark 1.15. *In the proof of Proposition 1.11, we showed that there is a unique germ of integral surface for η_u at a source point $p \in \Delta_{\text{so}}$, and a germ of integral surface at saddle point $p \in \Delta_{\text{sa}}$ is entirely determined by its intersection with small disks transverse to the unstable (or stable) branches of X at p .*

1.4 Proof of Theorem A

First of all, the plane fields ξ_\pm^t defined by (0.4) converge pointwise to (not necessarily continuous) plane fields η_\pm^∞ when t goes to $+\infty$. This can be obtained from the standard argument explained in [CF11, Section 2.4]. We choose an arbitrary Riemannian metric g on M and we denote by ν the orthogonal plane field to X defined away from Δ . We can then measure the angle $\theta_\pm^t(p)$ between $\xi_\pm(p) \cap \nu(p)$ and $\xi_\pm^t(p) \cap \nu(p)$, which satisfy

$$-\pi < \theta_-^t \leq \theta_+^t < \pi.$$

The contact conditions for ξ_\pm imply

$$\frac{d}{dt}\theta_+^t(p) > 0, \quad \frac{d}{dt}\theta_-^t(p) < 0,$$

for $p \in M \setminus \Delta$. Moreover, if $p \in \Delta$, then for every $t \in \mathbb{R}$, $\xi_+^t(p) = \xi_-^t(p) = \xi_+(p) = \xi_-(p)$. This shows that the limits η_\pm^∞ exist. If γ is a (possibly trivial) flow line of X , then by definition, the restrictions of η_\pm^∞ to γ are invariant under the flow of X . In particular, they are differentiable along X . Moreover, η_\pm^∞ are “sandwiched” between ξ_- and ξ_+ as in Proposition 1.7. The proof of the latter readily implies that η_\pm^∞ coincide with η_u along γ , hence these plane fields coincide on M . Now that we know that $\eta_\pm^\infty = \eta_u$ is continuous, we can argue as in [CF11, Lemme 3.1] and apply Dini’s theorem to show that the convergence of ξ_\pm^t to η_u is uniform. The first item of Theorem A is proved, and the second item immediately follows from Proposition 1.11. \square

2 Constructing foliations from contact pairs

In this section, we prove Theorem B from the introduction, up to a (very) technical result (Theorem 2.1) whose proof occupies Part II.

2.1 Polarized vector fields

Definition 2.1. *Let X be a smooth, possibly singular vector field on M . A **polarization** of X is a continuous, cooriented plane field η which contains X and is invariant under the flow of X . We call the pair (X, η) a **polarized vector field**.¹⁴*

In the previous sections, we saw that a positive contact pair (ξ_-, ξ_+) gives rise to a polarized vector field (X, η_u) which depends continuously on (ξ_-, ξ_+) .

By analogy with Definition 1.10, we say that a polarized vector field (X, η) on M is **regular** if the following conditions are satisfied:

1. The singular set Δ of X is a smoothly embedded link,
2. The linearization of X has rank 2 along Δ ,
3. Δ is transverse to η away from a finite set of points $Q \subset \Delta$ where it has “quadratic tangencies” with η , in the following sense. At each $p \in Q$, there exist smooth coordinates (x, y, z) in which the linearization of X at 0 is of the form

$$X_1 = ax\partial_x + z\partial_y,$$

and $\eta(0) = \text{span}\{\partial_x, \partial_y\}$. Moreover, $\Delta = \{x = 0, z = \pm y^2\}$ near p in these coordinates.

4. (X, η) satisfies the conclusions of Lemma 1.14 at these quadratic points.

The proof of Proposition 1.11 implies that η is locally integrable. Similarly, we have a decomposition

$$\Delta = \Delta_{\text{so}} \sqcup Q \sqcup \Delta_{\text{sa}}$$

in terms of source, quadratic, and saddle singularities.

The analysis of the different types of singularities of X along Δ in the proofs of Proposition 1.11 and Lemma 1.14 readily implies the following lemma which will be useful in Part II.

Lemma 2.2. *There exists a tubular neighborhood \mathcal{N} of Δ , made of a disjoint union of tubular neighborhoods of the connected components of Δ , and satisfying the following property. If a nontrivial flow line γ of X is entirely contained in \mathcal{N} , then γ connects a source singularity to a saddle singularity, both in the same component of Δ .*

To simplify some of our proofs, especially in Part II, we will make further generic assumptions on the contact pairs under consideration and their associated polarized vector fields. Recall that a **connection** of a vector field X is a nontrivial flow line γ converging to singularities of X in positive and negative times.

Definition 2.3. *Let (X, η) be a regular polarized vector field. A connection γ of X between singularities $\lim_{\pm\infty} \gamma =: p_{\pm} \in \Delta$ is **admissible** if it is of one of the four following types:*

¹⁴This terminology is motivated by the following observation: away from the singular set of X , η defines an oriented line subbundle of the plane bundle $TM/\langle X \rangle$ which is invariant under the flow of X . After choosing a (locally defined) transverse plane field to X , this line bundle can be identified with an oriented line field transverse to X .

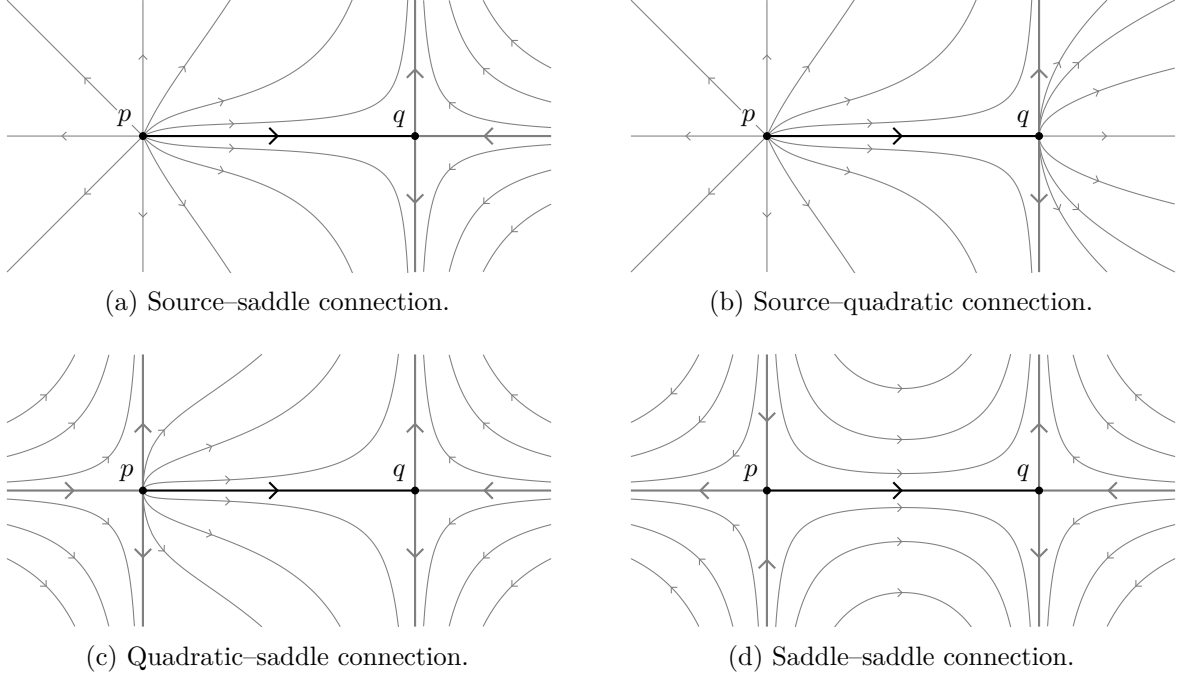

Figure 5: The four types of admissible connections.

- (A1) p_- is a source singularity and p_+ is a saddle singularity,
- (A2) p_- is a source singularity and p_+ is a quadratic singularity,
- (A3) p_- is a quadratic singularity, p_+ is a saddle singularity, and γ is not an unstable branch of p_- ,
- (A4) Both p_{\pm} are saddle singularities, $p_- \neq p_+$, and p_{\pm} are not connected to any other saddle singularities.

The four types of admissible connections are depicted in Figure 5. We will also require a strengthening of case (A4) above, which will only become relevant in Section 7.3 of Part II.

Definition 2.4. A **broken triple saddle connection** is a finite sequence $(\gamma_0, \dots, \gamma_{n+1})$, $n \geq 0$, of pairwise distinct unoriented connections of X such that

- γ_0 and γ_{n+1} are saddle-saddle connections,
- For every $0 \leq i \leq n$, γ_i and γ_{i+1} share an endpoint,
- For every $1 \leq i \leq n$, γ_i belongs to the unstable manifold of a source or quadratic singularity of X .

Definition 2.5. A regular polarized vector field (X, η) is **admissible** if X only has admissible connections, and no broken triple saddle connections. A regular positive contact pair (ξ_-, ξ_+) is **admissible** if its associated polarized vector field (X, η_u) is admissible.

The next lemma follows from standard general position arguments applied to the stable and unstable manifolds of the singularities of X :

Lemma 2.6. *Any regular positive contact pair can be (smoothly) approximated by an admissible one with the same singular set Δ . Therefore, admissible positive contact pairs form a comeagre subspace of the space positive contact pairs.*

We will need further assumptions on the contact pairs under consideration to prevent the existence of *disks of tangency* for their associated polarized vector fields.

Definition 2.7. *A **disk of tangency** for a polarized vector field (X, η) is an immersion $f : D \rightarrow M$ of the open 2-disk in M such that*

- *f is tangent to η ,*
- *f extends to a continuous map $\bar{f} : \bar{D} \rightarrow M$ whose restriction to $\partial\bar{D} \cong S^1$ maps to a closed orbit of X .*

The presence of such disks could obstruct some of the main constructions in Part II below. However, if one of the contact structures in the pair is tight, or if $\Delta_{\text{so}} = \emptyset$ (see the hypothesis of Theorem B), then these disks cannot exist:

Proposition 2.8. *Let (ξ_-, ξ_+) be an admissible positive contact pair. If its associated polarized vector field (X, η_u) has a disk of tangency, then $\Delta_{\text{so}} \neq \emptyset$ and both ξ_- and ξ_+ are overtwisted.*

Proof. Let $f : D \rightarrow M$ be a disk of tangency that extends to $\bar{f} : \bar{D} \rightarrow M$, and let γ be the closed orbit of X such that $\bar{f}(\partial\bar{D}) \subset \gamma$.

Notice that \bar{f} is an immersion as well: intersect γ with a small transversal surface Σ and consider the intersection of $f(D)$ with Σ . It is a collection of flow lines of the continuous vector field X_u obtained by intersecting η_u with Σ . These flow lines converge to the point $p_0 = \gamma \cap \Sigma$, so they extend in a C^1 way at that point. This implies that \bar{f} is a C^1 immersion tangent to η_u .

Let \tilde{X} denote the pullback of X to \bar{D} . It is a continuous, uniquely integrable vector field tangent to $\partial\bar{D}$ with isolated singularities in D . These singularities are of three types: source (index +1), birth-death (index 0), or saddle (index -1). By the Poincaré–Hopf theorem, there must be a source singularity in D , i.e., $f(D) \cap \Delta_{\text{so}} \neq \emptyset$.

Let us temporarily assume that \bar{f} is an embedding and write $\mathcal{D} := \bar{f}(\bar{D})$. Since $L := \partial\mathcal{D}$ is Legendrian for both ξ_- and ξ_+ , and since X is tangent to L and to η_u , the Thurston–Bennequin numbers $\text{tb}_{\pm}(L)$ of L for ξ_{\pm} are both zero. Since a Legendrian knot K bounding an embedded disk in a tight contact 3-manifold has $\text{tb}(K) \leq -\chi(\bar{D}) = -1$ by [Ben83], this implies that ξ_- and ξ_+ are both overtwisted.

We now explain how to reduce to the case where \bar{f} is an embedding. We will repeatedly use the Poincaré–Bendixson theorem (see [Tes12, Theorem 7.16]) and the following fact: if a domain in D is bounded by a closed orbit of \tilde{X} , then it contains a singularity of \tilde{X} . This can be seen as an easy consequence of the hairy ball theorem.

Let us consider the oriented graph $G = (V, E)$ on D whose vertices are the singularities of \tilde{X} and whose oriented edges are the flow lines of \tilde{X} connecting two singularities; see Figure 6. Notice that these flow lines are stable branches of the saddle and birth-death singularities, since there are no sinks, and there are finitely many of them. This implies that G is a finite graph. We now argue that G is a tree. We first show by contradiction that G has no cycle. If G has a cycle, we choose an innermost one and we denote it by c . We also consider $\bar{D}_c \subset D$ the closed domain bounded by c in D . Let δ be an edge in c connecting the singularity p to the singularity q . We distinguish three cases:

1. *p and q are saddles.* By the admissibility condition, we have $p \neq q$ and the two unstable branches of q cannot converge to singularities in positive time. One of these two branches is contained inside of \overline{D}_c . It cannot limit to a closed orbit as the latter would bound a domain in which \tilde{X} has no singularity. Therefore, the Poincaré–Bendixson theorem implies that it limits to a connected, *strict* subgraph G' of G included in \overline{D}_c with at least one edge. Moreover, the graph G' has the following property: if δ' is an edge in G' limiting to a singularity z , which is a saddle or a birth-death, then at least one of the two unstable branches of z is also an edge in G' . This readily implies that G' contains a cycle, since there are finitely many singularities. Recall that c is an innermost cycle, so G' necessarily contains c , and in particular it contains δ , which is impossible since q is a saddle.
2. *p is a source or birth-death and q is a saddle.* None of the two unstable branches of q can be an edge of the cycle c , since the admissibility condition would imply that it converges to another saddle singularity, and this situation is prohibited by the first case. Therefore, the stable branch of q different than δ is an edge in c . If the unstable branch of q contained in \overline{D}_c does not limit to a singularity, the argument of the first case applies and leads to a contradiction. This unstable branch could limit to a saddle z in \overline{D}_c , but the unstable branches of z cannot limit to singularities, and we similarly obtain a contradiction.
3. *p is a source and q is a birth-death.* The unstable branches of q cannot converge to singularities by admissibility. Therefore, there is an unstable flow line in the unstable half-disk of q , different than the unstable branches, which is an edge in c , possibly equal to δ if $p = q$. Once again, the behavior of the unstable branch of q contained in \overline{D}_c leads to a contradiction.

To summarize, we have shown that the graph G is a forest, namely, a disjoint union of trees. Notice that since there is no cycle of singularities, every flow line of \tilde{X} either converges to a singularity or to a closed orbit. This allows us to restrict to the case where D does not contain any nontrivial closed orbit of \tilde{X} . We can argue by induction on the number of connected components of G . Indeed, if G_0 denotes a connected component of G , then every leaf of G_0 admits an unstable flow line (unstable branch or a flow line contained in the unstable manifold) which is not contained in G . This flow line must limit to a closed orbit γ of \tilde{X} . If γ bounds a disk D_γ disjoint from G_0 , we restrict f to D_γ , reducing the number of connected components of the graph of singularities of \tilde{X} . Otherwise, every closed orbit of \tilde{X} contained in D_γ bounds a disk disjoint from G_0 . If such an orbit exists, we restrict f to the disk it bounds, reducing the number of connected components. Otherwise, we restrict f to D_γ , and we are done.

We now show that G is connected. Notice that the argument in previous paragraph readily implies that \tilde{X} has contracting holonomy along ∂D . The Poincaré–Bendixson theorem also implies that all of the stable branches of singularities are edges in G . Let G_1, \dots, G_n , $n \geq 1$, denote the connected components of G . For every $1 \leq i \leq n$, there is an open neighborhood \mathcal{N}_i of G_i in D with smooth boundary such that \tilde{X} is outward transverse to $\partial \mathcal{N}_i$. We can further assume that these neighborhood are pairwise disjoint. To construct such neighborhoods, we consider the union of small bands around each edge in G and small disks around the vertices. The conditions on G imply that we can modify this neighborhood so that \tilde{X} becomes outward transverse to its boundary. We also consider a slightly smaller disk $D' \subset D$ such that \tilde{X} is outward transverse to $\partial D'$. If $n \geq 2$, we would obtain a nonsingular vector field on $D' \setminus \bigcup_{1 \leq i \leq n} \mathcal{N}_i$ which is impossible for degree reasons. Therefore, G is connected and D' retracts onto G under the backward flow of \tilde{X} .

We now show that f is injective. It is enough to show that the restriction of f to the vertices of G is injective. Indeed, if two distinct points $p, q \in D$ are such that $f(p) = f(q)$, then our previous

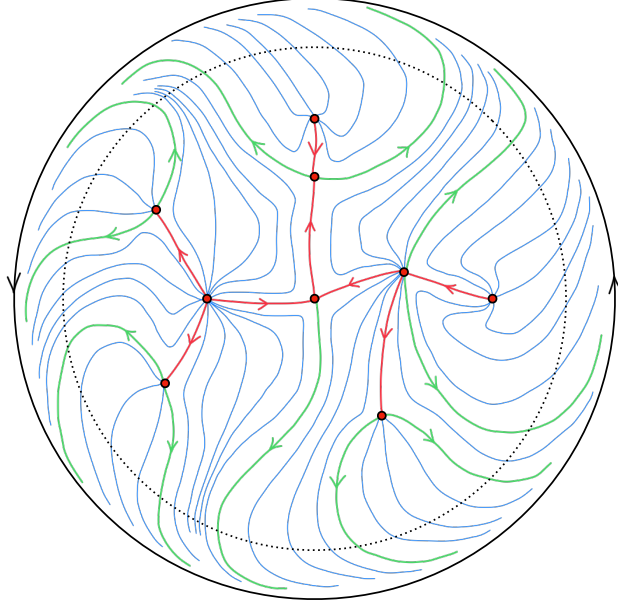

Figure 6: A tree on a leaf. In red: the tree G . In green: the stable branches limiting to the boundary orbit. In blue: flow lines of \tilde{X} . The outer circle is a closed orbit of \tilde{X} , the dotted circle is transverse to \tilde{X} . Notice the non-admissible connection...

arguments imply that they lie on two distinct flow lines of \tilde{X} which converge to two singularities in negative time. These singularities are necessarily distinct since f is an immersion. Therefore, we obtain two distinct vertices of G with the same image under f . We define an equivalence relation \sim on the vertices of G by

$$p \sim q \iff f(p) = f(q).$$

Since f is an immersion, this relation extends to the edges of G . We denote the quotient graph by $H := G/\sim$ and the associated quotient map by $\tilde{f} : G \rightarrow H$. The graph H can also be described as the graph in M whose vertices are the singularities $f(p)$, $p \in V(G)$, and the edges are the flow lines of X connecting them. It is then easy to see that \tilde{f} is a covering map in the graph theoretical sense. Since H is covered by the *finite* tree G , H itself a tree and \tilde{f} is an isomorphism. This implies that $f|_G$ is injective, thus f is injective.

We are left to show that the restriction of \bar{f} to $\partial\bar{D}$ is injective. If not, then this map winds around the closed orbit γ at least twice. With the above notations, the intersection of the transversal Σ with $\bar{f}(\bar{D})$ is a finite collection of flow lines of X_u which only intersect at p_0 . If γ_u^0 is such a flow line, we consider its image γ_u^1 under the return map of X on Σ . By our assumptions, γ_u^0 and γ_u^1 are distinct and only intersect at p_0 . After choosing coordinates (x, y) on Σ in which X_u is almost flat, we can represent γ_u^0 and γ_u^1 as graphs of \mathcal{C}^1 functions defined for $x \leq 0$ and passing through $(0, 0) \cong p_0$. Without loss of generality, we can assume that $\gamma_u^0 \leq \gamma_u^1$. We now consider the iterate images of γ_u^0 under the return map and obtain a sequence of flow lines γ_u^i , $i \geq 0$, satisfying $\gamma_u^i \leq \gamma_u^{i+1}$ for every $i \geq 0$. Here, we are using that η_u is cooriented and invariant under the flow of X . The γ_u^i 's have to be pairwise disjoint, which is impossible since $\bar{f}|_{\partial\bar{D}}$ winds around γ finitely many times. \square

Remark 2.9. *Disks of tangency should be compared to the (twisted) disks of contact from [GO89], and the sink disks from [Li02], which play a crucial role in the theory of branched surfaces and laminations. The presence of such disks obstructs the construction of a lamination from a branched*

surface, and it is often a delicate combinatorial problem to modify a branched surface and remove those disks. While it can be particularly hard to certify that a given branched surface is sink disk free, or if a lamination extends to a foliation in its complement, Proposition 2.8 provides a very natural and tractable way to preclude the existence of disks of tangency.

2.2 Proof of Theorem B

Let (ξ_-, ξ_+) be a positive contact pair satisfying the hypotheses of Theorem B. After a generic C^∞ -small perturbation away from Δ , which induces a small C^0 perturbation of η_u , we can assume that this contact pair is admissible by Lemma 2.6. By Proposition 2.8, the polarized flow (X, η_u) has no disks of tangency. We now appeal to the

Technical Theorem 2.1. *Let (X, η) be an admissible polarized vector field on M without disks of tangency. For every $\epsilon > 0$, there exists a C^0 -foliation \mathcal{F}_ϵ such that $d_{C^0}(\eta, T\mathcal{F}_\epsilon) < \epsilon$. Moreover, there exists a continuous map $h_\epsilon : M \rightarrow M$ such that for every leaf L of \mathcal{F}_ϵ , the restriction $h_\epsilon|_L : L \rightarrow M$ is a C^1 immersion tangent to η .*

The proof of this highly nontrivial result is deferred to Part II and will occupy the whole second half of this paper.

Let \mathcal{F} be a C^0 -foliation approximating η_u together with a continuous map $h : M \rightarrow M$ as above. By [KR19, Theorem 4.1] (see also [Bow16a, Remark 3.3]), we can further assume that the leaves of \mathcal{F} are smoothly immersed. We show by contradiction that \mathcal{F} has no spherical leaves. Otherwise, we readily obtain an embedded sphere S in M whose tangent bundle is homotopic to $\eta_u|_S$, and since ξ_\pm are homotopic to η_u ,

$$|\langle e(\xi_\pm), [S] \rangle| = |\langle e(\eta_u), [S] \rangle| = \chi(S) = 2.$$

However, by Bennequin–Eliashberg’s inequality (see [Eli92]),

$$\langle e(\xi), [S] \rangle = 0$$

for a tight contact structure ξ , hence both ξ_\pm are overtwisted. By applying the map h , we also obtain a C^1 -immersed sphere $f : S^2 \rightarrow M$ tangent to η_u , and pulling back X along f , we get a (continuous, uniquely integrable) vector field \tilde{X} on S^2 with isolated singularities which are sources (index +1), saddles (index -1), or birth-death singularities (index 0). The Poincaré–Hopf theorem readily implies that \tilde{X} has at least one source singularity, so $\Delta_{\text{so}} \neq \emptyset$. This contradicts the hypotheses of Theorem B, and finishes the proof. \square

Remark 2.10. *Technically speaking, the hypothesis that (X, η) has no disk of tangency is not absolutely necessary for Theorem 2.1 to hold. It could be weakened, e.g., by requiring that every disk of tangency is contained in an open subset of M on which η is uniquely integrable. However, we do not know if the latter condition is achieved for the polarized vector field of a generic positive contact pair.*

3 Strongly tight contact pairs

3.1 Tautness and tightness

The following definition already appears in [CF11] and [CH20].

Definition 3.1. *A contact pair (ξ_-, ξ_+) on M is **strongly tight** if for all $p, q \in M$, there exists a smooth arc from p to q positively transverse to both ξ_\pm .*

A strongly tight contact pair is necessarily positive. It will be convenient to reformulate this definition in various ways that are similar to some of the many characterizations of taut foliations. In Appendix B, we generalize some of these definitions to (continuous) plane fields, which might also be of independent interest.

Proposition 3.2. *Let (ξ_-, ξ_+) be a positive contact pair on M . The following are equivalent:*

1. (ξ_-, ξ_+) is strongly tight,
2. For every $p \in M$, there exists a smooth loop positively transverse to ξ_{\pm} passing through p ,
3. There exists a smooth closed 2-form ω such that $\omega|_{\xi_{\pm}} > 0$,
4. There exists a smooth volume preserving vector field positively transverse to ξ_{\pm} ,
5. η_u is a taut plane field (see Definition B.1).

In particular, ξ_{\pm} are weakly semi-fillable, hence universally tight.

Proof. The implications

$$1 \implies 2 \implies 3 \implies 4 \implies 5$$

are standard. The last implication follows from Proposition B.3. If η_u is taut, since the distributions ξ_{\pm}^t defined by (0.4) converge uniformly to η_u as t goes to $+\infty$, it is not hard to show that (ξ_-^T, ξ_+^T) is strongly tight for T sufficiently large; see the proof of [CF11, Proposition 3.7]. Hence, (ξ_-, ξ_+) is strongly tight as well. Weak semi-fillability follows from the argument in [ET98, Corollary 3.2.8]. \square

The third or fourth characterization immediately imply that strong tightness is an open condition in the \mathcal{C}^0 topology. Moreover, if \mathcal{F} is a taut \mathcal{C}^0 -foliation on M and if ξ_{\pm} are positive and negative contact structures on M which are sufficiently \mathcal{C}^0 -close to $T\mathcal{F}$, then (ξ_-, ξ_+) is strongly tight. Reciprocally, we have:

Theorem 3.3 (Theorem C). *Let (ξ_-, ξ_+) be a strongly tight contact pair. Then η_u can be \mathcal{C}^0 -approximated by taut \mathcal{C}^0 -foliations.*

Proof. The strong tightness of (ξ_-, ξ_+) implies that η_u is a taut plane field by Proposition 3.2. Moreover, ξ_{\pm} are both tight so Theorem B applies. Since (everywhere) tautness is an open condition for continuous plane fields, \mathcal{C}^0 -foliations sufficiently close to η_u are also taut. \square

Remark 3.4. *In [CF11, Proposition 3.6], it is shown that strongly tight contact pairs can be deformed into positive pairs without quadratic singularities, i.e., for which $\Delta = \Delta_+$ is transverse to ξ_{\pm} everywhere. It would be interesting to better understand the structure of η_s , the stable plane field of the pair, near Δ where it ‘vanishes’.*

The strong tightness assumption on the pair (ξ_-, ξ_+) is quite restrictive and hard to work with in practice. A natural weakening would be to only assume that (ξ_-, ξ_+) is a positive contact pair and that both ξ_{\pm} are tight (in particular, Theorem B applies). In that case, Colin–Firmo [CF11, Théorème 3.3] showed that if η_u is uniquely integrable, then it is tangent to a foliation without Reeb components with nullhomologous core, and moreover M carries a Reebless foliation. The unique integrability assumption is crucial for their argument and is unfortunately impractical. As a plausible generalization of this result, we propose:

Conjecture 3.5. *If (ξ_-, ξ_+) is a tight positive contact pair, then η_u can be \mathcal{C}^0 -approximated by a \mathcal{C}^0 -foliation without nullhomologous Reeb components, and M carries a Reebless \mathcal{C}^0 -foliation.*

This conjecture would have the following important consequences:

- A closed oriented 3-manifold carries a Reebless foliation if and only if it carries a positive pair of tight contact structures.
- An atoroidal closed oriented 3-manifold carries a taut foliation if and only if it carries a positive pair of tight contact structures.
- On an atoroidal rational homology sphere, the unstable plane field of a positive pair of tight contact structures can be \mathcal{C}^0 -approximated by taut \mathcal{C}^0 -foliations.
- An atoroidal rational homology sphere carries a pair of transverse taut foliations if and only if it carries a tight bicontact structure.

As noted in [CF11], under the hypotheses of Conjecture 3.5, Bennequin’s inequality for transverse curves implies that *no closed curve transverse to η_u can bound an embedded disk in M* . Unfortunately, this property is *not* open in the \mathcal{C}^0 topology! If it were, it would be possible to approximate η_u by a foliation \mathcal{F} with trivial meridional holonomy along its Reeb components. Following the strategy of the proof of [CF11, Théorème 3.3], it would then be possible to remove the Reeb components of \mathcal{F} and get a Reebless foliation \mathcal{F}' . Of course, the homotopy class of $T\mathcal{F}'$ might be different than the one of η_u . It seems more credible that some foliations approximating η_u might have Reeb components with nontrivial meridional holonomy, and some might not (compare this to the *phantom Reeb components* from [CKR19]). In Appendix D, we prove a two dimensional result showing that closed transverse curves are the only obstructions to finding foliations by circle, see Proposition D.1. This serves as evidence for the above conjecture and might be of independent interest.

Interestingly, Etnyre [Etn07] shows that a Reeb component with *nontrivial* meridional holonomy can be approximated by a contact pair (ξ_-, ξ_+) where one of ξ_{\pm} is universally tight while the other one is overtwisted. Moreover, a Reeb component with *trivial* meridional holonomy can be approximated by a pair of *universally tight* contact structures:

Example 3.6. On $\mathbb{R}^2 \times S^1$ with coordinates (r, θ, z) , where (r, θ) denote standard polar coordinates on \mathbb{R}^2 , we define

$$\alpha := (1 - r^2)dz + r dr, \tag{3.1}$$

$$\beta := \frac{1}{2}r^2 d\theta. \tag{3.2}$$

These are both smooth, nowhere vanishing 1-forms. The kernel of α is tangent to a smooth foliation \mathcal{F} on $\mathbb{R}^2 \times S^1$ for which $D^2 \times S^1$ is a Reeb component. Moreover,

$$\begin{aligned} \langle \alpha, \beta \rangle &:= \alpha \wedge d\beta + \beta \wedge d\alpha \\ &= r dr \wedge d\theta \wedge dz \\ &> 0, \end{aligned}$$

and

$$\alpha \wedge d\alpha = \beta \wedge d\beta = 0,$$

so \mathcal{F} can be linearly deformed into two contact structures with opposite signs

$$\xi_{\pm}^{\tau} := \ker(\pm\alpha + \tau\beta)$$

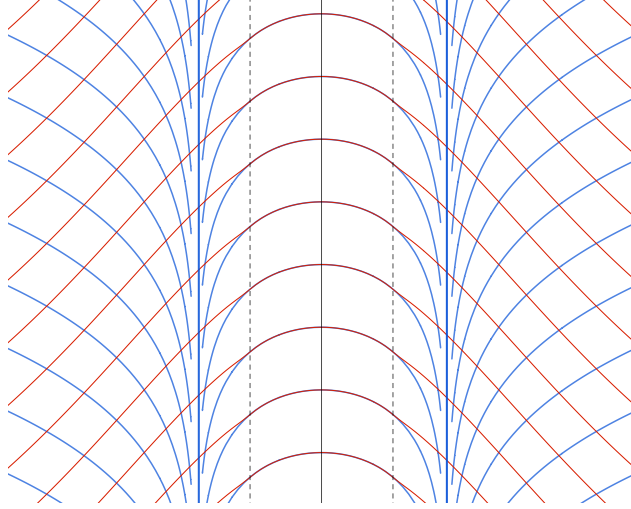

Figure 7: A θ -slice of the foliations \mathcal{F} (in blue) and \mathcal{G} (in red).

for any $\tau > 0$, and (ξ_-^τ, ξ_+^τ) is a positive contact pair. Both ξ_\pm^τ are universally tight since their lifts to $\mathbb{R}^2 \times \mathbb{R}$ are contactomorphic to the standard positive and negative tight contact structures on \mathbb{R}^3 , respectively. This can be seen by considering a (z, θ) -invariant foliation by planes \mathcal{G} on \mathbb{R}^3 which coincides with (the lift of) \mathcal{F} near $\{r = 0\}$ and is transverse to \mathcal{F} elsewhere (see Figure 7). The characteristic foliation of ξ_\pm^τ along a leaf of \mathcal{G} has a unique singularity at 0, is radial near $\{r = 0\}$, and is diffeomorphic to the standard radial foliation on \mathbb{R}^2 . Therefore, after applying a (z, θ) -equivariant diffeomorphism of \mathbb{R}^3 which maps \mathcal{G} to the standard foliation of \mathbb{R}^3 by horizontal planes, and maps the characteristic foliations of ξ_\pm^τ along the leaves of \mathcal{G} to radial foliations on the horizontal planes, the contact structure ξ_\pm^τ becomes

$$\tilde{\xi}_\pm^\tau := \ker (dz + f_\tau(r)d\theta),$$

where $f_\tau : \mathbb{R}_{r \geq 0} \rightarrow \mathbb{R}_{\geq 0}$ vanishes at $r = 0$ and is positive elsewhere. It easily follows that $\tilde{\xi}_\pm^\tau$ is contactomorphic to the standard tight contact structure $\ker (dz + r^2 d\theta)$ on \mathbb{R}^3 . A similar argument applies to ξ_\pm^τ .

This shows that on an open 3-manifold, some foliations with Reeb components can be linearly deformed into a positive pair of universally tight contact structures.

3.2 Transverse surgeries

We now show that strongly tight contact pairs are preserved under transverse surgeries of sufficiently large slopes. Theorem H will follow easily.

Proposition 3.7. *Let (ξ_-, ξ_+) be a strongly tight contact pair on M and $K \subset M$ be a knot positively transverse to ξ_\pm and equipped with some framing. There exists $s_0 > 0$ such that for any rational number s satisfying $|s| \geq s_0$, $M_K(s)$ carries a strongly tight contact pair (ξ_-^s, ξ_+^s) . Moreover, the image of K in $M_K(s)$ is positively transverse to ξ_\pm^s .*

Proof. After possibly perturbing K to make it disjoint from Δ , there exists a small tubular neighborhood $\mathcal{N}_K \cong S^1 \times D^2$ of $K \cong S^1 \times \{0\}$ such that

- The vector field ∂_t is positively transverse to ξ_\pm in \mathcal{N}_K , and the framing of K in the standard coordinates on \mathcal{N}_K becomes trivial,

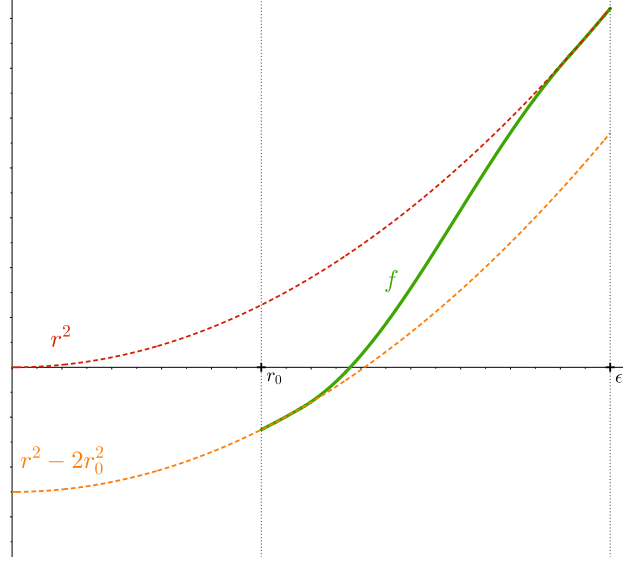

Figure 8: The function f .

- For every $t \in S^1$, X is tangent to $\{t\} \times D^2$ and

$$\xi_{\pm} \cap T(\{t\} \times D^2) = \langle X \rangle.$$

We can apply [CF11, Proposition 3.5] to find a new positive pair (ξ'_-, ξ'_+) with associated vector field X' and singular set Δ' such that

- ξ'_{\pm} is isotopic to ξ_{\pm} rel $M \setminus \mathcal{N}_K$,
- The vector field ∂_t is positively transverse to ξ'_{\pm} in \mathcal{N}_K ,
- For every $t \in S^1$, the characteristic foliation of ξ'_{\pm} on $\{t\} \times D^2$ is spanned by X' and has two singularities, a source and a saddle, in canceling position.

It follows that Δ' coincides with Δ outside of \mathcal{N}_K , and $\Delta' \cap \mathcal{N}_K$ has two parallel components, made of source and saddle singularities, respectively. We can further arrange that the new source component coincides with K and that there exists a small $\epsilon > 0$ such that in $S^1 \times D_{\epsilon}^2 \subset S^1 \times D^2 \cong \mathcal{N}_K$, ξ'_{\pm} is the kernel of the 1-form

$$\alpha_{\pm}^0 := \pm dt + r^2 d\theta,$$

where (r, θ) denotes the polar coordinates on D^2 . Notice that (ξ'_-, ξ'_+) is still strongly tight.

We now modify $\xi_{\pm}^0 := \ker \alpha_{\pm}^0$ in $S^1 \times D_{\epsilon}^2$ relative to $T_{\epsilon} := S^1 \times \partial D_{\epsilon}$ and perform an *admissible contact surgery* on the new contact structures simultaneously. To this end, we consider a sufficiently small radius $0 < r_0 < \epsilon$ such that $r_0^2 \in \mathbb{Q}$, and we write $r_0^2 = p/q$ for some coprime positive integers $p, q \in \mathbb{Z}_{>0}$. Along $T_{r_0} := S^1 \times \partial D_{r_0}$, the characteristic foliation of ξ_+^0 has slope $s := -1/r_0^2 = -q/p$. We modify ξ_-^0 inside of $S^1 \times D_{\epsilon}$ so that its characteristic foliation also has slope s on T_{r_0} . We choose a smooth function $f : [r_0, \epsilon] \rightarrow \mathbb{R}$ satisfying

- $f' > 0$,
- $f(r) = r^2$ near ϵ ,
- $f(r) = r^2 - 2r_0^2$ near r_0 .

See Figure 8. We then define

$$\tilde{\alpha}_-^0 := -dt + f(r)d\theta$$

inside of $S^1 \times ([r_0, \epsilon] \times S^1)$, which coincides with α_-^0 near T_ϵ . It is a negative contact form whose kernel “twists more” than the one of α_-^0 . Moreover, its characteristic foliation on T_{r_0} coincides with the one of α_+^0 . It is then easy to perform a *contact cut* (see [Ler01; BE13]) along T_{r_0} for both α_+^0 and $\tilde{\alpha}_-^0$. This is possible since their moment maps for the S^1 -action on a neighborhood of T_{r_0} given by a translation of slope s in the (θ, t) direction coincide. After this operation, we obtain two contact structures ξ_\pm^s on the Dehn filling of $S^1 \times ([r_0, \epsilon] \times S^1)$ of slope s along T_{r_0} , which coincide with ξ'_\pm near T_ϵ . After extending them by ξ'_\pm outside of $S^1 \times D_\epsilon$, we obtain two contact structures, still denoted by ξ_\pm^s , on $M_K(s)$. If r_0 is sufficiently small, i.e., if $|s|$ is sufficiently large, then (ξ_-^s, ξ_+^s) is strongly tight in $S^1 \times D_\epsilon$. Since (ξ'_-, ξ'_+) is strongly tight in M , it is also strongly tight in $M \setminus (S^1 \times D_\epsilon)$ and (ξ_-^s, ξ_+^s) is strongly tight in $M_K(s)$. To perform a surgery of large positive slope, we can apply a similar argument to ξ'_- , or equivalently, reverse the orientation of M and consider the positive contact pair (ξ'_+, ξ'_-) . \square

Proof of Theorem H. Let \mathcal{F} be a taut \mathcal{C}^0 -foliation on M different from the standard foliation on $S^1 \times S^2$, and let K be a framed knot transverse to \mathcal{F} . By [KR17, Theorem 1.2], $T\mathcal{F}$ can be approximated by a strongly tight contact pair (ξ_-, ξ_+) such that K is positively transverse to ξ_\pm . By Proposition 3.2, for any $s \in \mathbb{Q}$ such that $|s|$ is sufficiently large, $M_K(s)$ carries a strongly tight contact pair (ξ'_-, ξ'_+) such that K' , the image of K after surgery, is positively transverse to ξ'_\pm . This implies that K' is transverse to η'_u , the unstable plane field of (ξ'_-, ξ'_+) . Applying Theorem C, we readily obtain a taut \mathcal{C}^0 -foliation \mathcal{F}' in $M_K(s)$ such that K' is transverse to \mathcal{F}' . \square

Proof of Corollary I. Note that $s \in \mathcal{S}_K$ if and only if $S_K^3(s)$ admits a taut \mathcal{C}^0 -foliation transverse to K'_s , the image of K after surgery. If $s = p/q$, for coprime p and q (or $p = 0$ and $q = 1$ if $s = 0$), the choice of a framing for K'_s is equivalent to the choice of integers $u, v \in \mathbb{Z}$ such that $up - vq = 1$, which is also equivalent to the choice of a matrix in $\mathrm{SL}(2, \mathbb{Z})$ representing a mapping class of the torus $T^2 = S^1 \times S^1$ sending the meridian curve (the second component) to a curve of slope s . This matrix can be written as

$$A = \begin{pmatrix} u & q \\ v & p \end{pmatrix},$$

and sends a curve of slope $s' = p'/q'$ to a curve of slope

$$r = \frac{vq' + pp'}{uq' + qp'} = s \cdot \frac{s' + v/p}{s' + u/q}$$

if $s \neq 0$, and of slope

$$r = -\frac{1}{u + s'}$$

otherwise (in which case $v = -1$). In both cases, r converges to s as s' goes to $\pm\infty$, and every slope r sufficiently close to s can be written as such for some $s' \in \mathbb{Q}$ with $|s'|$ sufficiently large. Since a s -slope surgery on a nontrivial knot in S^3 never produces $S^1 \times S^2$ by Gabai’s *Property R* theorem [Gab87] (and some elementary homological considerations for $s \neq 0$), the proof now easily follows from Theorem H. \square

4 Liouville pairs

4.1 Elementary properties

We recall that a Liouville pair is a pair of contact forms (α_-, α_+) on M , negative a positive, respectively, such that the 1-form

$$\lambda = e^{-s}\alpha_- + e^s\alpha_+$$

is a positive Liouville form on $\mathbb{R}_s \times M$. In other terms, $\omega := d\lambda$ is a non-degenerate 2-form on $\mathbb{R} \times M$, and $\omega \wedge \omega$ is a positive volume form.

If (α_-, α_+) is a Liouville pair and $\sigma : M \rightarrow \mathbb{R}$ is a smooth function, then $(e^{-\sigma}\alpha_-, e^{\sigma}\alpha_+)$ is also a Liouville pair. We say that these two Liouville pairs are **equivalent**. Up to equivalence, we can always assume that (α_-, α_+) is **balanced**, i.e.,

$$\alpha_+ \wedge d\alpha_+ = -\alpha_- \wedge d\alpha_-.$$

In that case, we denote by

$$\text{dvol} := \alpha_+ \wedge d\alpha_+$$

the associated volume form. Writing

$$d(\alpha_- \wedge \alpha_+) = f_0 \text{dvol}$$

as before, where $f_0 : M \rightarrow \mathbb{R}$ is a smooth function, elementary calculations show that the Liouville condition is equivalent to

$$f_0 > -2. \tag{4.1}$$

The following lemma was already observed in [Mas23].

Lemma 4.1. *Let (α_-, α_+) be a Liouville pair on M . Then the underlying contact pair $(\xi_-, \xi_+) = (\ker \alpha_-, \ker \alpha_+)$ is positive, and $r_u > 0$ (see Proposition 1.7 for the notation).*

Proof. The fact that (ξ_-, ξ_+) is positive immediately follows from Lemma 1.5 and inequality (4.1). For α_u defined by (1.3), the expression (1.7) together with inequality (4.1) imply $r_u > 0$. \square

If (ξ_-, ξ_+) is a contact pair and (α_-, α_+) is a Liouville pair such that $(\ker \alpha_-, \ker \alpha_+) = (\xi_-, \xi_+)$, we say that (ξ_-, ξ_+) **supports** (α_-, α_+) . The following lemma shows that such a Liouville pair (if it exists) is unique up to homotopy.

Lemma 4.2. *Let (ξ_-, ξ_+) be a contact pair. The space of Liouville pairs (α_-, α_+) supported by (ξ_-, ξ_+) is either empty or contractible.*

Proof. Let (α_-, α_+) be a Liouville pair for (ξ_-, ξ_+) . We can assume that it is balanced. It defines a volume form dvol and a vector field X . It is enough to show that the space of *balanced* Liouville pairs for (ξ_-, ξ_+) is contractible. Any such Liouville pair can be written as

$$\alpha'_\pm = e^\sigma \alpha_\pm$$

for some smooth function $\sigma : M \rightarrow \mathbb{R}$. Moreover, the Liouville condition is equivalent to

$$2X \cdot \sigma + f_0 > -2. \tag{4.2}$$

As a result, the space of balanced Liouville pairs for (ξ_-, ξ_+) is diffeomorphic to the space of functions σ satisfying (4.2). The latter is obviously convex, hence contractible. \square

4.2 From hypertaut foliations to Liouville pairs

The following lemma is well-known for \mathcal{C}^2 foliations by the work of Sullivan [Sul76]. It is extended in [CC00] to \mathcal{C}^0 -foliations; see [CC00, Lemma 10.2.6] and [CC00, Theorem 10.2.12].

Lemma 4.3. *Let \mathcal{F} be a cooriented \mathcal{C}^0 -foliation on M . The following are equivalent:*

1. \mathcal{F} carries no (nontrivial) invariant transverse measures,
2. There exists a smooth 1-form β such that

$$d\beta|_{T\mathcal{F}} > 0.$$

We say that \mathcal{F} is a **hypertaut** \mathcal{C}^0 -foliation if it satisfies these properties. Equivalently, \mathcal{F} is hypertaut if for some/any Riemannian metric g on M , there exists a smooth nonsingular *zero-flux* vector field v transverse to \mathcal{F} . Here, the *flux* of v through a closed oriented surface $\Sigma \subset M$ is defined as

$$\text{Flux}(v)[\Sigma] := \int_{\Sigma} \langle v, \nu_{\Sigma} \rangle \omega_{\Sigma},$$

where ν_{Σ} is the positive normal vector to Σ and ω_{Σ} is the area form on Σ induced by g .

The next proposition is a version of [ET98, Corollary 3.2.5].

Proposition 4.4. *Let \mathcal{F} be a hypertaut \mathcal{C}^0 -foliation on M . Then \mathcal{F} can be \mathcal{C}^0 -approximated by contact structures ξ_- and ξ_+ , negative and positive, respectively, such that there exists a Liouville structure on $[-1, 1] \times M$ which is an exact filling of $(-M, \xi_-) \sqcup (M, \xi_+)$.*

Proof. Let β be a smooth 1-form on M such that $d\beta$ dominates \mathcal{F} . Since \mathcal{F} has no closed (spherical) leaf, it can be approximated by negative and positive contact structures ξ_- and ξ_+ by [KR17]. We can further assume that $d\beta|_{\xi_{\pm}} > 0$. Let α be a continuous 1-form defining $T\mathcal{F}$, and $\tilde{\alpha}$ be a smoothing of α satisfying $\tilde{\alpha} \wedge d\beta > 0$. For $\epsilon > 0$, we consider the 1-form

$$\lambda := \epsilon \tilde{\alpha} + \beta$$

on $[-1, 1]_{\epsilon} \times M$. If ϵ is sufficiently small, then $\omega := d\lambda$ is symplectic and dominates ξ_{\pm} on $\{\pm 1\} \times M$. We now appeal to [Eli91, Proposition 3.1] (see also [Eli04, Proposition 4.1]) to modify λ near $\{\pm 1\} \times M$ and obtain the desired Liouville filling. \square

It is not clear to us how to recover a hypertaut foliation from a Liouville fillable positive contact pair. It is also unclear whether the Liouville structure obtained from a hypertaut \mathcal{C}^0 -foliation by the previous proposition is unique up to homotopy (the contact approximations of \mathcal{F} might not be unique). However, for \mathcal{C}^2 hypertaut foliations, it is possible to construct a more specific type of Liouville structure, namely, one induced by a Liouville pair. This construction relies on the following proposition which is the main result of Jonathan Zung's article [Zun24]:

Proposition 4.5 ([Zun24]). *If \mathcal{F} is a \mathcal{C}^2 hypertaut foliation, then there exist 1-forms α and β such that*

$$\ker \alpha = T\mathcal{F}, \quad \alpha \wedge d\beta > 0, \quad \beta \wedge d\alpha \geq 0.$$

The first inequality simply means that $d\beta$ is a dominating 2-form for \mathcal{F} .

Corollary 4.6. *If \mathcal{F} is a hypertaut \mathcal{C}^2 foliation, then there exists a Liouville pair (α_-, α_+) on M such that the contact structures $\xi_{\pm} = \ker \alpha_{\pm}$ are \mathcal{C}^0 -close to $T\mathcal{F}$.*

Proof. For $\epsilon > 0$, we define

$$\alpha_{\pm} := \epsilon\beta \pm \alpha, \quad (4.3)$$

where α and β are as in Proposition 4.5. Following [ET98], we write

$$\langle \alpha, \beta \rangle := \alpha \wedge d\beta + \beta \wedge d\alpha.$$

One easily computes

$$\begin{aligned} \alpha_+ \wedge d\alpha_+ &= \epsilon \langle \alpha, \beta \rangle + O(\epsilon^2), \\ \alpha_- \wedge d\alpha_- &= -\epsilon \langle \alpha, \beta \rangle + O(\epsilon^2), \\ d(\alpha_- \wedge \alpha_+) &= -2\epsilon d(\alpha \wedge \beta). \end{aligned}$$

For ϵ small enough, α_{\pm} are contact forms with opposite orientations. Moreover, (α_-, α_+) is a Liouville pair if and only if

$$-d(\alpha_- \wedge \alpha_+) < 2\sqrt{-(\alpha_+ \wedge d\alpha_+) \cdot (\alpha_- \wedge d\alpha_-)},$$

which is equivalent to

$$d(\alpha \wedge \beta) < \langle \alpha, \beta \rangle + O(\epsilon).$$

This condition is satisfied for ϵ small enough, since

$$d(\alpha \wedge \beta) = \beta \wedge d\alpha - \alpha \wedge d\beta < \beta \wedge d\alpha + \alpha \wedge d\beta = \langle \alpha, \beta \rangle.$$

The 1-forms α_{\pm} might only be \mathcal{C}^1 , but they can easily be smoothed to yield a smooth Liouville pair. \square

4.3 Proof of Theorem E

Let (ξ_-, ξ_+) be a contact pair on M supporting a Liouville pair (α_-, α_+) . By Proposition 4.7 below, we can assume that the Reeb vector field of α_+ is positively transverse to η_u , i.e., $d\alpha_+|_{\eta_u} > 0$. Since ξ_{\pm} are (strongly) semi-fillable, they are both tight. By Theorem B, η_u can be \mathcal{C}^0 -approximated by a \mathcal{C}^0 -foliation \mathcal{F} , and we can further arrange that $d\alpha_+|_{T\mathcal{F}} > 0$. By Lemma 4.3, \mathcal{F} is hypertaut.

Proposition 4.7. *Let (α_-, α_+) be a Liouville pair on M , with underlying positive contact pair (ξ_-, ξ_+) and unstable plane field η_u . Then (α_-, α_+) is equivalent to a Liouville pair (α'_-, α'_+) whose Reeb vector fields R'_{\pm} are both transverse (with opposite signs) to η_u .*

Proof. As usual, we assume that (α_-, α_+) is balanced, and we use the notations of the proof of Proposition 1.7. By (1.3) and (1.4), we can write

$$\alpha_- = \frac{1}{2 \cosh(\sigma_u - \sigma_s)} (e^{\sigma_s} \alpha_u + e^{\sigma_u} \alpha_s), \quad (4.4)$$

$$\alpha_+ = \frac{1}{2 \cosh(\sigma_u - \sigma_s)} (e^{-\sigma_s} \alpha_u - e^{-\sigma_u} \alpha_s). \quad (4.5)$$

Let $\sigma : M \rightarrow \mathbb{R}$ be some smooth function and $(\alpha'_-, \alpha'_+) := (e^{-\sigma} \alpha_-, e^{\sigma} \alpha_+)$. We compute $\alpha_s(R'_{\pm})$ in terms of σ . From the identities

$$\alpha'_{\pm}(R'_{\pm}) = 1, \quad (4.6)$$

$$\mathcal{L}_X \alpha'_{\pm}(R'_{\pm}) = 0, \quad (4.7)$$

we get (after some slightly tedious computations)

$$\alpha_s(R'_+) = -\frac{\overbrace{2e^{\sigma_u - \sigma} \cosh(\sigma_u - \sigma_s)}^{>0}}{X \cdot (\sigma_u - \sigma_s) + r_u - r_s} (X \cdot (\sigma - \sigma_s) - X \cdot \ln \cosh(\sigma_u - \sigma_s) + r_u), \quad (4.8)$$

$$\alpha_s(R'_-) = -\frac{2e^{\sigma - \sigma_u} \cosh(\sigma_u - \sigma_s)}{\underbrace{-X \cdot (\sigma_u - \sigma_s) + r_u - r_s}_{>0}} (X \cdot (\sigma - \sigma_s) + X \cdot \ln \cosh(\sigma_u - \sigma_s) - r_u). \quad (4.9)$$

From (1.5), (1.6), (1.7), and (1.8), one easily computes

$$\pm X \cdot (\sigma_u - \sigma_s) + r_u - r_s = e^{\pm 2\sigma_u} + e^{\pm 2\sigma_s} > 0.$$

Furthermore, we claim that

$$-X \cdot \ln \cosh(\sigma_u - \sigma_s) + r_u > 0.$$

Indeed, by (1.5) and (1.6),

$$\begin{aligned} X \cdot \ln \cosh(\sigma_u - \sigma_s) &= \tanh(\sigma_u - \sigma_s) X \cdot (\sigma_u - \sigma_s) \\ &= \tanh(\sigma_u - \sigma_s) (\sinh(2\sigma_u) + \sinh(2\sigma_s)) \\ &= 2 \tanh(\sigma_u - \sigma_s) (\sinh(\sigma_u + \sigma_s) \cosh(\sigma_u - \sigma_s)) \\ &= 2 \sinh(\sigma_u - \sigma_s) \sinh(\sigma_u + \sigma_s) \\ &= \cosh(2\sigma_u) - \cosh(2\sigma_s). \end{aligned}$$

Here, we used the classical formulae

$$\begin{aligned} \sinh(x) + \sinh(y) &= 2 \sinh\left(\frac{x+y}{2}\right) \cosh\left(\frac{x-y}{2}\right) \\ 2 \sinh(x) \sinh(y) &= \cosh(x+y) - \cosh(x-y). \end{aligned}$$

Therefore, using (1.7),

$$\begin{aligned} -X \cdot \ln \cosh(\sigma_u - \sigma_s) + r_u &= \cosh(2\sigma_s) - \cosh(2\sigma_u) + \cosh(2\sigma_u) + f_0/2 \\ &= \cosh(2\sigma_s) + f_0/2 \\ &> 0, \end{aligned}$$

since $f_0 > -2$. Let us fix some $\epsilon > 0$ such that

$$-X \cdot \ln \cosh(\sigma_u - \sigma_s) + r_u > \epsilon.$$

By Lemma C.1, we can choose σ so that

$$|X \cdot (\sigma - \sigma_s)|_{C^0} < \epsilon.$$

This ensures

$$\begin{aligned} \alpha_s(R'_+) &< 0, \\ \alpha_s(R'_-) &> 0, \end{aligned}$$

so R'_\pm are both transverse to $\eta_u = \ker \alpha_s$ as desired. Note that we do not need σ to be C^0 -close to σ_s . \square

4.4 The skeleton

For a general Liouville manifold (V, λ) with Liouville vector field Z and Liouville flow (ϕ_Z^t) , the **skeleton** is defined as

$$\mathfrak{ske}\ell(V, \lambda) := \bigcup_{\substack{K \subset V \\ \text{compact}}} \bigcap_{t > 0} \phi_Z^{-t}(K).$$

In this section, we determine the geometric structure of the skeleton of a Liouville pair, defined as the skeleton of the associated Liouville structure. This result applies in particular to *Anosov Liouville structures*, defined in [Mas23].

Proposition 4.8. *Let (α_-, α_+) be a Liouville pair on M . The skeleton of the associated Liouville structure*

$$\lambda = e^{-s}\alpha_- + e^s\alpha_+$$

on $V = \mathbb{R}_s \times M$ is of the form

$$\mathfrak{ske}\ell(V, \lambda) = \text{graph}(\sigma) = \{(\sigma(p), p) \mid p \in M\}$$

for some continuous function $\sigma : M \rightarrow \mathbb{R}$. Moreover, σ is continuously differentiable along the vector field X associated with the contact pair $(\xi_-, \xi_+) = (\ker \alpha_-, \ker \alpha_+)$, and the restriction of the Liouville flow to the skeleton is orbit equivalent to the flow of X .¹⁵

Proof. First of all, we can assume that (α_-, α_+) is balanced, after applying a graphical diffeomorphism $\varphi : (s, p) \mapsto (s + \sigma_0(p), p)$ for a suitable smooth function $\sigma_0 : M \rightarrow \mathbb{R}$. Then, with the previous notations, the Liouville vector field for λ is given by

$$Z(s, p) = \frac{1}{\cosh(2s) + f_0(p)/2} \left((\sinh(2s) + g_0(p)/2) \partial_s + X(p) \right).$$

Writing

$$\begin{aligned} F(s, p) &= \sinh(2s) + g_0(p)/2, \\ \tilde{Z} &= F\partial_s + X, \end{aligned}$$

the vector fields Z and \tilde{Z} share the same skeleton. The flow line of \tilde{Z} starting at (s_0, p_0) is given by

$$\phi_{\tilde{Z}}^t(s_0, p_0) = (\sigma(t), \phi_X^t(p_0)),$$

where σ satisfies the ODE

$$E_{(s_0, p_0)} : \begin{cases} \dot{\sigma}(t) = F(\sigma(t), \phi_X^t(p_0)), \\ \sigma(0) = s_0. \end{cases}$$

By definition, $(s_0, p_0) \in \mathfrak{ske}\ell = \mathfrak{ske}\ell(V, \lambda)$ if and only if the corresponding maximal solution to $E_{(s_0, p_0)}$ is bounded. Lemma A.1 implies that for every $p_0 \in M$, there exists a unique $\sigma(p_0) \in \mathbb{R}$ such that $(\sigma(p_0), p_0) \in \mathfrak{ske}\ell$; with the notation of the proof of Proposition 1.7, $\sigma = \sigma_u$, which is continuous and continuously differentiable along X . Therefore, under the balancing condition, $\mathfrak{ske}\ell = \text{graph}(\sigma_u)$. Finally, the restriction of the Liouville flow to the skeleton is clearly orbit equivalent to the flow of X because of the form of \tilde{Z} . \square

¹⁵Two flows are orbit equivalent if there exists a homeomorphism sending the oriented flow lines of the first to oriented flow lines of the second, possibly with a different parametrization.

Remark 4.9. We see from the proof that the regularity of the skeleton, i.e., the regularity of the function σ , is the same as the regularity of the function σ_u . If X is Anosov, then it is as regular as the weak-stable bundle of X , which is always \mathcal{C}^1 but not necessarily \mathcal{C}^2 .

Proposition 4.8 shows in particular that the skeleton of the Liouville structure associated to a Liouville pair is a codimension one topological submanifold homeomorphic to M . It would be interesting to investigate the converse:

Question 4.10. Let λ_0 be a Liouville structure on $V = M \times \mathbb{R}$. If $\text{ske}(V, \lambda_0) \subset V$ is a codimension one compact embedded topological submanifold, does there exist a Liouville pair (α_-, α_+) on M with associated Liouville structure λ on V such that (V, λ_0) and (V, λ) are exact symplectomorphic?

4.5 Semi-Anosov flows and unique integrability

In this section, we define and study a certain type of 3-dimensional flows whose behavior interpolates between projectively Anosov and Anosov flows.

Definition 4.11. Let $\Phi = (\phi_t)_t$ be a smooth flow on M generated by a vector field X , and $\Lambda \subset M$ be a Φ -invariant compact subset disjoint from the singular set of X . A **semi-Anosov splitting** for Φ on Λ is a continuous, Φ -invariant splitting

$$T_\Lambda M = E^{ws} \oplus E^u$$

along Λ , where E^u is 1-dimensional, E^{ws} is 2-dimensional, $X \in E^{ws}$, and for some/any metric g on M , there exist constants $C > 0$ and $0 < a < b$ such that

- For every $v \in E^u$ and $t \geq 0$,

$$\|d\phi_t(v)\| \geq Ce^{bt}\|v\|,$$

- For every $v \in E^{ws}$ and $t \geq 0$,

$$\|d\phi_t(v)\| \leq Ce^{at}\|v\|.$$

We call E^u the **(strong-)unstable bundle** of Φ , and E^{ws} the **weak-stable bundle** of Φ . We also call $E^{wu} := \langle X \rangle \oplus E^u$ the **weak-unstable bundle** of Φ . We call Φ **semi-Anosov** if it is nonsingular and admits a semi-Anosov splitting on M .

It is easy to see that semi-Anosov flows are projectively Anosov (and without contracting closed orbits), but not necessarily Anosov. This raises the following

Question 4.12. Is there a 3-manifold M carrying a semi-Anosov flow, but no Anosov flow?

The next proposition is very similar to the Anosov case, and the proof is essentially the same.

Proposition 4.13. If Φ admits a semi-Anosov splitting on Λ , then E^u is uniquely integrable and its leaves are smooth.

Proof. It follows from a version of the Hadamard-Perron theorem [FH19, Theorem B.5.2] which implies a version of the Unstable Manifold theorem [FH19, Theorem 6.1.1]. \square

We now establish a connection between Liouville pairs and semi-Anosov flows.

Proposition 4.14. Let (α_-, α_+) be a Liouville pair with associated vector field X , and let $\Lambda \subset M$ be a compact subset disjoint from Δ and invariant by X . Then the flow of X admits a semi-Anosov splitting along Λ .

Proof. Since $\Delta \cap \Lambda = \emptyset$, η_s and η_u are defined on Λ , and there exists continuous, non-vanishing 1-forms α_s, α_u such that $\ker \alpha_{u/s} = \eta_{s/u}$ and

$$\mathcal{L}_X \alpha_{s/u} = r_{s/u} \alpha_{s/u},$$

where $r_s < r_u$ and $r_u > 0$. We let $E^{ws} := \eta_s$ and we want to find a suitable 1-dimensional, Φ -invariant subbundle $E^u \subset \eta_u$. On $N_X := TM/\langle X \rangle$ restricted to Λ , we have a dominated splitting

$$N_X = \bar{\eta}_s \oplus \bar{\eta}_u,$$

where $\bar{\eta}_{s/u} := \eta_{s/u}/\langle X \rangle$. Dualizing (α_s, α_u) , we get continuous sections $\bar{e}_{s/u}$ of $\bar{\eta}_{s/u}$ and we define a (continuous) metric \bar{g} on N_X for which (\bar{e}_s, \bar{e}_u) is orthonormal. Moreover, there exist constants $C > 0$ and $0 < a < b$ such that

- For every $v \in \bar{\eta}_u$ and $t \in \mathbb{R}$,

$$\|d\phi_t(v)\| \geq C e^{bt} \|v\|,$$

- For every $v \in \bar{\eta}_s$ and $t \in \mathbb{R}$,

$$\|d\phi_t(v)\| \leq C e^{at} \|v\|.$$

The proof of [Doe87, Proposition 1.1] readily implies that there exists a Φ -invariant 1-dimensional subbundle $E^u \subset \eta_u$ defined along Λ satisfying the desired conditions. \square

We conclude with the following result, which is essentially the only instance in which we can ensure that η is a uniquely integrable plane field:

Corollary 4.15. *Let (ξ_-, ξ_+) be a regular contact pair on M supporting a Liouville pair (α_-, α_+) . If Δ has no saddle singularities, then η_u is uniquely integrable, and its integral foliation is a hypertaut \mathcal{C}^0 -foliation.*

Proof. If $\Delta = \emptyset$, combining Proposition 4.13, Proposition 4.14 and Proposition 4.7, η_u is uniquely integrable, its integral foliation is a \mathcal{C}^0 -foliation, and there exists a smooth contact form α'_+ whose Reeb vector field is transverse to \mathcal{F} . Equivalently, $d\alpha'_+$ is positive on the leaves of \mathcal{F} , which implies hypertautness.

If $\Delta \neq \emptyset$ and $\Delta = \Delta_{\text{so}}$, we consider a small tubular neighborhood U of Δ such that X is transverse to ∂U and outward pointing. We then define

$$\mathcal{V} := \bigcup_{t>0} \phi_t(U), \quad \Lambda := M \setminus \mathcal{V},$$

so that Λ is compact and invariant under the flow of X . By the proof of Proposition 1.11, η_u is uniquely integrable on \mathcal{V} , since it is uniquely integrable near Δ . Moreover, the reasoning of the previous paragraph shows that η_u is uniquely integrable on Λ as well. \square

Unfortunately the hypothesis of this corollary are quite restrictive. We ask:

Question 4.16. *Can the condition $\Delta_{\text{sa}} = \emptyset$ in Corollary 4.15 be removed? To show this, it would be sufficient to find a uniquely integrable vector field X_u defined away from Δ such that $\eta_u = \text{span}\{X, X_u\}$.*

Part II

Branching foliations

In this part, (X, η) denotes a polarized vector field on M which is admissible (see Definition 2.5) and without disks of tangency (see Definition 2.7). We also choose some arbitrary Riemannian metric \mathbf{g} on M .

The goal of this part is to prove the Technical Theorem 2.1. It is completely independent of the first part and does not rely on any notion from contact or symplectic topology.

Because of the lack of smoothness and unique integrability of η , we will not be able to construct a foliation tangent to η directly. However, we will construct a weaker structure tangent to η called a *branching foliation*.

Branching foliations are defined in [BI08, Definition 4.1]. Roughly speaking, those are collections of ‘maximal’ surfaces which are allowed to touch but not to cross, and whose union is M . We recall the precise definition for the convenience of the reader.

Definition 4.17. *A leaf collection tangent to η is a set of maps $\mathcal{F} = \{f_i : \Sigma_i \rightarrow M\}_{i \in I}$ indexed by a set I such that for every $i \in I$,*

- Σ_i is a smooth surface (i.e., a 2-dimensional manifold without boundary),
- $f_i : \Sigma_i \rightarrow M$ is a \mathcal{C}^1 immersion tangent to η .

A leaf collection \mathcal{F} is a **branching foliation** if

- For every $i \in I$, the length metric for the intrinsic \mathcal{C}^0 Riemannian metric $\mathbf{g}_i := f_i^* \mathbf{g}$ on Σ_i is complete,
- For every $i, j \in I$, f_i and f_j have no topological crossings (see [BI08, Definition 4.1]),
- The leaves of \mathcal{F} cover M :

$$\bigcup_{i \in I} f_i(\Sigma_i) = M.$$

Notice that this definition does not depend on the choice of the metric \mathbf{g} since M is compact. Crucially, branching foliations can be \mathcal{C}^0 perturbed into genuine foliations by separating the leaves without introducing crossings. More precisely, the combination of [BI08, Lemma 7.1] and [BI08, Theorem 7.2] imply the following

Theorem 4.18. *If η is tangent to a branching foliation, then it can be \mathcal{C}^0 -approximated by a \mathcal{C}^0 -foliation \mathcal{F} . Moreover, there exists a continuous map $h : M \rightarrow M$ such that for every leaf $L \in \mathcal{F}$, the restriction $h|_L : L \rightarrow M$ is a \mathcal{C}^1 immersion tangent to η .*

We can further assume that h is close to the identity, hence of degree 1 and surjective, and that the leaf collection

$$\mathcal{F} := \{h|_L : L \rightarrow M \mid L \in \mathcal{F}\}$$

is a branching foliation tangent to η . However, we will not need these additional properties.

We are now left to show that η is tangent to a branching foliation. To that end, we will essentially follow the strategy of [BI08] and we explain how to adapt their proof to our setup. Recall that the structure of interest is a pair (X, η) where

- X is a smooth vector field which plays the role of E^s from [BI08],

- η is a continuous plane field containing X and invariant under its flow, which plays the role of E^{cs} in [BI08].

However, there are two major differences between our vector field X and the vector field E^s from [BI08]: unlike E^s , X may have close orbits and singularities. A careful inspection of the proofs in [BI08] reveals that the presence of closed orbits (without singularities) is not a serious issue. However, the presence of singularities dramatically complicates the arguments and requires more general notions of *surfaces*, *patches*, *prefoliations*, etc. Furthermore, the hypothesis that (X, η) has no disks of tangency will be essential, as these disks could obstruct the construction of prefoliations, and more specifically the construction of *upper enveloping surfaces*. The (forward) structure of these surfaces is also more involved in our singular setting, and we will need to be particularly careful about their behavior near Δ .

5 General construction

Because of the presence of saddle and quadratic singularities, we will need to consider more general surfaces in M tangent to η than the ones in [BI08]. In particular, we will consider surfaces with corners with suitable local forms near Δ . We will call these surfaces *tiles*. We then generalize the main technical concept from [BI08], namely, the one of a *prefoliation*. These structures are intermediate steps in the construction of a genuine branching foliations, in the sense that their leaves are possibly non-maximal tiles. Prefoliations, and their weaker version defined below, also come with the structure of a (pre)order at every point of M , allowing to distinguish which tiles are above and below others, even though they geometrically coincide. The main technical—and most difficult!—step is to extend a (weak) prefoliation by suitably enlarging its tiles and adding new ones, while also extending the order structure. See Proposition 5.11 below, whose proof will occupy Sections 6, 7, and 8. As in [BI08], this extension is particularly nontrivial because of the global behavior of the vector field X (see [BI08, Section 6.1], in particular Figures 1 and 2).

5.1 Tiles

We now fix a neighborhood \mathcal{N} of Δ as in Lemma 2.2. We say that smooth local coordinates (x, y, z) around a point $p \in M$ are **adapted** to η if ∂_z is positively transverse to η and $\eta(0) = \text{span}\{\partial_x, \partial_y\}$ in these coordinates. Every point $p \in M$ admits such local coordinates. If moreover $p \in \Delta_{sa}$, then the projections of the stable and unstable branches of X at p on the (x, y) -plane determine four local quadrants at 0 in \mathbb{R}^2 . If $p \in Q$, then the projections of the unstable branches of X at p on the (x, y) -plane determine two local half-planes at 0 in \mathbb{R}^2 , one of which corresponds to the unstable half-disk of p . The projection of the stable branch at p divides the other half-plane into two quadrants.

Definition 5.1 (See [BI08], Definition 4.1). *A **surface** in M is a C^1 immersion $f : U \rightarrow M$, where U is a connected surface with boundary and convex and concave corners.*

The rest of [BI08, Definition 4.1] is still valid for this more general notion of surface.

Definition 5.2 (See [BI08], Definition 4.2). *An η -**surface** is a surface $f : U \rightarrow M$ tangent to η , invariant under the flow of X , and such that U is homeomorphic to a simply connected subset of \mathbb{R}^2 .*

The invariance condition means that the flow of the pullback $\widetilde{X} := f^*X$ of X to U is complete, or that the surface “consists of whole trajectories of X ”. Here, \widetilde{X} is a continuous and uniquely integrable vector field on U . We call a nonsingular flow line of \widetilde{X} a **X -line** on U . Since (X, η) has no disks of tangency, \widetilde{X} has no nontrivial closed orbit on U , and X -lines are homeomorphic to \mathbb{R} .

Definition 5.3. Let $f : U \rightarrow M$ be an η -surface, and D_0 be a connected open subset of U . If $p \in \overline{f(D_0)}$, we say that f is **locally graphical near p over D_0** if there exists a small open ball B centered at p with smooth coordinates (x, y, z) adapted to η , a connected domain $D \subset \mathbb{R}^2$, a diffeomorphism $\varphi : D \rightarrow D_0 \cap f^{-1}(B)$ and a map $\tilde{f} : D \rightarrow \mathbb{R}$ such that $f \circ \varphi : D \rightarrow B \subset \mathbb{R}^3$ is the graph of \tilde{f} over $D \subset \mathbb{R}^2$ in the following sense:

$$\forall (x, y) \in D, \quad f \circ \varphi(x, y) = (x, y, \tilde{f}(x, y)) \in \mathbb{R}^3.$$

Furthermore, we say that f has a **puncture** at p in D_0 if D is the complement of 0 in a neighborhood of 0 , and f has a **slit** at p in D_0 if D is the complement of a \mathcal{C}^1 embedded curve starting at 0 in a neighborhood of 0 , after possibly shrinking B in each case.

Notice that if D_0 is a sufficiently small disk centered at $a \in U$, then f is automatically locally graphical near $f(a)$ over D_0 , since f is an immersion tangent to η . The local behavior of f near a can be described as follows.

1. If $f(a) \in \Delta$, then either a is in the interior of U , hence 0 is in the interior of D , or a is a boundary point or a corner of U , and the same holds for 0 in D . In the latter case, we further distinguish three cases.
 - (a) $f(a) \in \Delta_{\text{so}}$. The intersection of D with a small open neighborhood of 0 is a sector bounded by two embedded \mathcal{C}^1 curves meeting at 0 , corresponding to two flow lines of X emanating from a .
 - (b) $f(a) \in \Delta_{\text{sa}}$. Recall that the projections of the stable and unstable branches at $f(a)$ on the (x, y) -plane in the above coordinates determine four (local) quadrants at 0 . If a is a boundary point of U , the intersection of D with a small open neighborhood V of 0 is exactly the intersection with V of the union of two consecutive quadrants. If a is a convex corner of U , then $D \cap V$ is exactly the intersection with V of one of the quadrants. If a is a concave corner of U , then $D \cap V$ is exactly the intersection with V of three consecutive quadrants.
 - (c) $f(a) \in Q$. Recall that the projections of the unstable branches at $f(a)$ on the (x, y) -plane determine two (local) half-planes at 0 , and the projection of the stable branch divides one of these half-planes into two quadrants. The other half-plane corresponds to the projection of the unstable half-disk of $f(a)$. The description of the different possibilities for $D \cap V$ when a is a boundary point or a corner of U is left as an exercise to the reader.
2. If $f(a) \notin \Delta$, meaning that $X(f(a)) \neq 0$, we can further assume that X coincides with ∂_x in the above local coordinates. By the invariance of η under X , $\tilde{f} : D \rightarrow \mathbb{R}$ is a function of y only. Note that a cannot be a corner of U . If a is in the interior of U , then D can be chosen of the form $(-\epsilon, \epsilon)^2$, and if a is a boundary point of U , D can be chosen of the form $(-\epsilon, \epsilon) \times [0, \epsilon)$ or $(-\epsilon, \epsilon) \times (-\epsilon, 0]$, where $\epsilon > 0$ is sufficiently small. We can further distinguish two cases:
 - (a) The orbit of X passing through $f(a)$ is not periodic. In that case, f maps the flow line of \tilde{X} in U passing through a to the flow line of X in M passing through $f(a)$ bijectively.
 - (b) The orbit of X passing through $f(a)$ is periodic. In that case, the flow line of \tilde{X} in U passing through a is not closed, since U is simply connected and (X, η) has no disks of tangency. The restriction of f to this flow line covers the closed orbit of X in M passing through $f(a)$ infinitely many times, in positive and negative times.

Notice that f sends the corners of U to Δ , and $f^{-1}(\Delta)$ is a discrete subset of U . Moreover, f sends the boundary components of $U \cap f^{-1}(\Delta)$ to entire flow lines of X .

As in [BI08], we can consider the **completion** of an η -surface $f : U \rightarrow M$. The completion \bar{U} is the completion of U for the intrinsic metric on U , and f uniquely extends to a continuous map $\bar{f} : \bar{U} \rightarrow M$. However, the completion of an η -surface in our singular setting is not necessarily an η -surface, since \bar{U} might fail to be a smooth surface and \bar{f} might fail to be an immersion. This occurs when f is not locally graphical near a singularity $p \in \Delta$ or has a slit at p . Because of this issue, we need to be particularly careful about the way the η -surfaces we consider intersect \mathcal{N} and behave near Δ .

If $p \in \Delta$ and D_0 is a connected component of $f^{-1}(\mathcal{N})$ such that $p \in \overline{f(D_0)}$, we call D_0 a **singular region** of f for p .

Definition 5.4. *Let $f : U \rightarrow M$ be an η -surface.*

- f is **well-cornered** if for every $p \in \Delta$ and every singular region $D_0 \subset U$ for p , f is locally graphical near p over D_0 and has no puncture nor slit at p in D_0 .
- f is **unstable-complete** if for every $a \in U$,
 1. If $f(a)$ lies in the unstable disk of a source singularity $p \in \Delta_{\text{so}}$, then there exists an open subset $V \subset U$ containing the point a such that the restriction $f|_V : V \rightarrow M$ is a diffeomorphism onto this unstable disk.
 2. If $f(a)$ lies in the interior of the unstable half-disk of a quadratic singularity $q \in Q$, then there exists an open subset $V \subset U$ containing the point a such that the restriction $f|_V : V \rightarrow M$ is a diffeomorphism onto the interior of this unstable half-disk.
- f is an η -**tile**, or **tile for simplicity**, if it is well-cornered and unstable-complete.

More concretely, a tile f has the following behavior near a singularity $p \in \Delta$:

- If $p \in \Delta_{\text{so}}$, then the domain D from Definition 5.3 contains a neighborhood of 0.
- If $p \in \Delta_{\text{sa}}$ and if 0 is not in the interior of D , then after possibly shrinking B , the interior of D is either the interior of a quadrant, or the interior of the union of two or three adjacent quadrants.
- If $p \in Q$ and if 0 is not in the interior of D , then after possibly shrinking B , the interior of D is the interior of a quadrant, the interior of the union of the two quadrants, the interior of the (projection of the) unstable half-plane, or the interior of the union of this half-plane with one quadrant.

We only have described the possibilities for the *interior* of D (intersected with a neighborhood of 0). The precise description of D is left as an exercise to the reader.

Lemma 5.5 (See [BI08], Lemma 4.3). *The completion $\bar{f} : \bar{U} \rightarrow M$ of a tile $f : U \rightarrow M$ is a tile. Moreover, $\bar{U} \setminus U$ is contained in $\partial\bar{U}$.*

Proof. If $a \in \bar{U} \setminus U$ is such that $\bar{f}(a) \notin \Delta$, then the proof of [BI08, Lemma 4.3] shows that a is in the set-theoretic boundary of \bar{U} and near a , \bar{U} is obtained from U by adding a X -line. Otherwise, if $\bar{f}(a) \in \Delta$, then the effect of the completion near a corresponds to taking the closure of the domain D from Definition 5.3. Then \bar{U} differs from U near a by adding the point a together with boundary components which are X -lines. It easy follows that \bar{U} is surface with boundary and corners, and that \bar{f} is a tile. The details of the proof are left to the reader. \square

We can now extend the definitions in [BI08, Section 4] to tiles as follows. An **edge** of a tile $f : U \rightarrow M$ is a connected component of $\bar{U} \setminus \bar{f}^{-1}(\Delta)$. A point in $\bar{f}^{-1}(\Delta) \cap \partial\bar{U}$ is a **boundary singularity**. It is either a corner of \bar{U} , or a point between two edges which are X -lines with opposite orientations. The latter will be called a **fake corner**. Notice \bar{f} sends fake corners to points in $Q \cup \Delta_{\text{sa}}$. An edge or boundary singularity (corner or fake corner) is **proper** if it is contained in U , and **improper** otherwise. Two edges are **adjacent** if they meet at a corner or at a fake corner. As in [BI08], an edge has a forward or backward coorientation. This notion can be extended to (genuine) corners, but not to fake corner. We warn the reader that we will use the terminology *forward/backward corner* in a different way below.

The definition [BI08, Definition 4.4] also extends in a straightforward way: a **marked tile** is a pair (f, a) where $f : U \rightarrow M$ is a tile and $a \in U$. It is a **forward (resp. backward)** marked tile if the marking a belongs to a forward (resp. backward) edge or corner, and **passing** marked tile if the marking a belongs to the interior of U . Unlike in [BI08], there is no natural notion of “forward or backward half-tile” at a point $a \in U$. For instance, a could belong to a X -line connecting two singularities in the interior of U , and this X -line would not divide U into two half-surfaces.

5.2 Weak prefoliations

Similarly as in [BI08, Definition 4.5], if \mathcal{A} is a collection of tiles and $p \in M$, we set

$$\mathcal{A}_p := \{(f, a) \mid f \in \mathcal{A}, f(a) = p\}$$

and

$$\mathcal{A}_\star := \bigsqcup_{p \in M} \mathcal{A}_p.$$

If $f \in \mathcal{A}$, we will typically denote a corresponding element in \mathcal{A}_\star by f_\star .

The definition of the *geometric order* in [BI08, Definition 4.6] extends in a straightforward way to a collection \mathcal{A} of tiles. The notion of *patch* from Definition 4.7 of [BI08] is harder to adapt and is not crucial for our argument.

We now introduce a natural equivalence relation on marked tiles.

Definition 5.6. *Two marked tiles $f_\star = (f : U \rightarrow M, a)$ and $g_\star = (g : V \rightarrow M, b)$ are **equivalent** if there exists a pointed diffeomorphism $\varphi : (U, a) \rightarrow (V, b)$ such that $g \circ \varphi = f$. In that case, we write $f_\star \approx g_\star$.*

It is straightforward to check that \approx is an equivalence relation on marked tiles. Notice that if $(f, a) \approx (g, b)$, then $f(a) = g(b)$, and the diffeomorphism φ as above is unique, since f is an immersion and U is connected.

Remark 5.7. *It might happen that a single tile $f : U \rightarrow M$ admits two distinct markings $a, b \in U$ such that $(f, a) \approx (f, b)$. In that case, it is easy to check that the corresponding diffeomorphism φ has no fixed points and acts properly discontinuously on U . Therefore, the quotient $\Sigma := U/\varphi$ has a natural manifold structure and f induces an immersion $\Sigma \rightarrow M$ which is tangent to η . In other words, f is a nontrivial cover a surface tangent to η , but this surface is not a tile since Σ is not simply connected. Furthermore, if U only has one proper edge, then Σ has a closed boundary component which is mapped to a closed orbit of X in M .*

Definition 5.8 (See [BI08], Definition 4.8). *A **weak prefoliation** (\mathcal{A}, \preceq) is a collection \mathcal{A} of tiles together with a partial preorder \preceq on \mathcal{A}_\star satisfying the following axioms.¹⁶*

¹⁶A preorder on a set is a transitive and reflexive binary relation. It is an order if and only if it is antisymmetric. Dropping the antisymmetry requirement makes weak prefoliations more flexible than the prefoliations from [BI08]. See also the next footnote.

0. Two marked tiles $f_\star \in \mathcal{A}_p$ and $g_\star \in \mathcal{A}_q$ are comparable by \lesssim if and only if $p = q$. Moreover, if $f_\star \lesssim g_\star$ and $g_\star \lesssim f_\star$ then $f_\star \approx g_\star$.
1. The preorder \lesssim is a refinement of the geometric order in the following sense: if $f_\star \lesssim g_\star$, then g_\star is geometrically locally above f_\star .
2. The preorder \lesssim is coherent along the intersection of tiles in the following sense: if $\gamma : [0, 1] \rightarrow M$ is continuous path, and if $\gamma_1 : [0, 1] \rightarrow U_1$ and $\gamma_2 : [0, 1] \rightarrow U_2$ are lifts of γ to tiles $f_1 : U_1 \rightarrow M$ and $f_2 : U_2 \rightarrow M$, respectively, then $(f_1, \gamma_1(0)) \lesssim (f_2, \gamma_2(0))$ if and only if $(f_1, \gamma_1(1)) \lesssim (f_2, \gamma_2(1))$.

In Axiom 0, we *do not* assume that $f_\star \lesssim g_\star$ if $f_\star \approx g_\star$. In other words, two equivalent tiles might be strictly comparable by \lesssim , while two nonequivalent tiles are necessarily strictly comparable by \lesssim . We write $f_\star \simeq g_\star$ if $f_\star \lesssim g_\star$ and $g_\star \lesssim f_\star$, and $f_\star \prec g_\star$ if $f_\star \lesssim g_\star$ and $f_\star \not\approx g_\star$. If $f_\star \simeq g_\star$, we say that f_\star and g_\star are **order-equivalent**.¹⁷

Axioms 0 and 1 readily imply that if $g_\star \in \mathcal{A}_p$ is strictly locally above $f_\star \in \mathcal{A}_p$, then $f_\star \prec g_\star$. Combined with Axiom 2, this implies that there are no topological crossings between tiles in \mathcal{A} ; see the discussion after [BI08, Definition 4.8].

Axiom 2 can be modified by further requiring that γ is \mathcal{C}^1 , tangent to η , and either tangent or transverse to X . A slight adaptation of the discussion after [BI08, Definition 4.8] shows that this seemingly weaker version of Axiom 2 is in fact equivalent to it. Indeed, if $\gamma : [0, 1] \rightarrow M$ is only continuous, then γ_1 can be approximated by a piecewise \mathcal{C}^1 curve $\tilde{\gamma}_1$ in U with the same endpoints as γ_1 , which intersects the same X -lines and singularities as γ_1 , and whose \mathcal{C}^1 segments are either tangent or transverse to \tilde{X} .¹⁸ Therefore, $\tilde{\gamma} := f \circ \tilde{\gamma}_1$ admits a lift $\tilde{\gamma}_2 : [0, 1] \rightarrow U_2$ to f_2 with the same endpoints as γ_2 .

A weak prefoliation is **forward (resp. backward)** if its tiles only have edges with forward (resp. backward) coorientations, and it is **complete** if its tiles are all complete. It **covers** M if for every $p \in M$, $\mathcal{A}_p \neq \emptyset$.

Example 5.9. A branching foliation \mathcal{F} has a natural (weak) prefoliation structure, constructed in the proof of [BI08, Theorem 7.2]. We give a slightly different construction. First of all, the leaves in \mathcal{F} are obviously tiles. Now, if $f_\star = (f : U \rightarrow M, a)$ and $g_\star = (g : V \rightarrow M, b)$ are two marked leaves in \mathcal{F}_p , $p \in M$, we define the relation $\lesssim_p^{\mathcal{F}}$ as follows: $f_\star \lesssim_p^{\mathcal{F}} g_\star$ if for every (continuous, or \mathcal{C}^1) path $\gamma : [0, 1] \rightarrow U$ starting at $\gamma(0) = a$ which lifts to a path $\tilde{\gamma}$ to g_\star , $(g, \tilde{\gamma}(1))$ is locally above $(f, \gamma(1))$. Since f_\star and g_\star have no topological crossings, they are comparable by \lesssim_p . Moreover, it is not hard to show that $f_\star \lesssim_p^{\mathcal{F}} g_\star$ and $g_\star \lesssim_p^{\mathcal{F}} f_\star$ if and only if $f_\star \approx g_\star$, so axiom 0 of Definition 5.8 is satisfied. Axioms 1 and 2 immediately follow from the definition of $\lesssim^{\mathcal{F}}$.

Definition 5.10 (See [BI08], Definition 4.9). Let \mathcal{A} be a weak prefoliation. An **extension** of \mathcal{A} is the data of

- A weak prefoliation \mathcal{B} ,
- An map $i : \mathcal{A} \rightarrow \mathcal{B}$, called an **extension map**,

¹⁷Obviously, \lesssim induces a genuine order on the quotient $\mathcal{A}_\star / \simeq$. Alternatively, we could circumvent the lack of antisymmetry of \lesssim by considering a more general definition of tiles, allowing their domains to be arbitrary surfaces different than the closed disk and the sphere.

¹⁸To see that, one can cover U with open disks which are either flow boxes for \tilde{X} or standard neighborhoods of the isolated singularities of \tilde{X} .

- For every $f \in \mathcal{A}$ with $f : U \rightarrow M$ and $i(f) : U' \rightarrow M$, an embedding $\varphi_f : U \hookrightarrow U'$ satisfying $i(f) \circ \varphi_f = f$,

such that i preserves the preorders. More precisely, the map i induces a map $i_\star : \mathcal{A}_\star \rightarrow \mathcal{B}_\star$ defined by

$$i_\star(f_\star) := (i(f), \varphi_f(a)),$$

where $f_\star = (f, a) \in \mathcal{A}$. We require that the following holds:

$$\forall f_\star, g_\star \in \mathcal{A}_\star, \quad f_\star \lesssim^{\mathcal{A}} g_\star \iff i_\star(f_\star) \lesssim^{\mathcal{B}} i_\star(g_\star).$$

Unfortunately, Proposition 4.11, Proposition 4.12 and Proposition 4.13 from [BI08] do not individually extend in a straightforward way to our setup. Instead, we will combine modified versions of these statements and show:

Proposition 5.11. *Let \mathcal{A} be a complete and backward (resp. forward) weak prefoliation. There exists an extension $\mathcal{A} \rightarrow \mathcal{B}$ where \mathcal{B} is complete, forward (resp. backward), and covers M .*

The proof of this proposition occupies the next four sections. We now show how it implies the Technical Theorem 2.1.

Proof of the Technical Theorem 2.1. Similarly as in [BI08], there is $r_0 > 0$ such that every ball of radius r_0 centered at a point in $M \setminus \mathcal{N}$ admits smooth coordinates (x, y, z) in which $X = \partial_x$, and the angle between η and $\text{span}\{\partial_x, \partial_y\}$ is at most 10^{-10} . We can rescale the metric \mathbf{g} so that $r_0 \geq 100$.

Applying Proposition 5.11 inductively, we construct a sequence of complete weak prefoliations $(\mathcal{A}^n)_{n \geq 0}$ such that

- $\mathcal{A}^0 = \emptyset$,
- \mathcal{A}^1 is forward and covers M ,
- For every $n \geq 0$, \mathcal{A}^{n+1} is an extension of \mathcal{A}^n , with an extension map $i^n : \mathcal{A}^n \rightarrow \mathcal{A}^{n+1}$,
- For every $k \geq 0$, \mathcal{A}^{2k} is backward and \mathcal{A}^{2k+1} is forward.

For every $f \in \mathcal{A}^1$, we consider the sequence of tiles $(f^n)_{n \geq 1}$ inductively defined by

$$f^1 := f, \quad \forall n \geq 0, \quad f^{n+1} = i^n(f^n).$$

If $f^n : U_n \rightarrow M$, then by definition there exists a sequence of embeddings

$$U_1 \xrightarrow{\varphi^1} U_2 \xrightarrow{\varphi^2} \dots \xrightarrow{\varphi^{n-1}} U_n \xrightarrow{\varphi^n} U_{n+1} \xrightarrow{\varphi^{n+1}} \dots$$

such that for every $n \geq 1$, $f^{n+1} \circ \varphi^n = f^n$. Taking the colimit of the above diagram yields a surface U_∞ , a sequence of embeddings $(\psi^n : U_n \rightarrow U_\infty)_{n \geq 1}$, and an immersion $f^\infty : U_\infty \rightarrow M$ such that for every $n \geq 1$, $f^\infty \circ \psi^n = f^n$ and $\psi^{n+1} \circ \varphi^{n+1} = \psi^n$. In particular, f^∞ is tangent to η . If $a_\infty \in U_\infty$, then for $n \geq 1$ sufficiently large, there exists $a_n \in U_n$ such that $\psi^n(a_n) = a_\infty$. We say that the marked tile $(f^n, a_n) \in \mathcal{A}_\star^n$ is an *ancestor* of (f^∞, a_∞) . For $1 \leq m \leq n$, we write

$$\begin{aligned} \varphi_n^m &:= \varphi^{n-1} \circ \dots \circ \varphi^m, \\ U_n^m &:= \varphi_n^m(U_m) \subset U_n, \\ U_\infty^m &:= \psi^m(U_m) \subset U_\infty, \\ a_n^m &:= \varphi_n^m(a_m) \in U_n. \end{aligned}$$

We claim that the surface f^∞ is open and complete. Indeed, let $a_\infty \in U_\infty$ and (f^n, a_n) be an ancestor of (f^∞, a_∞) . If $f^n(a_n) \notin \Delta$, then $a_{n+1} = \varphi^n(a_n)$ is in the interior of U_{n+1} , since either a_n is in the interior of U_n , or it is in an edge of U_n and a_{n+1} is not in an edge of U_{n+1} because these surfaces have edges with opposite coorientations. If $f^n(a_n) \in \Delta$ is a source, then it is already in the interior of U_n , and if it is a saddle or a quadratic singularity, then $a_{n+2} = a_{n+2}^n$ is in the interior of U_{n+2} by a similar argument as above. In both cases, $a_\infty = \psi^{n+1}(a_{n+1}) = \psi^{n+2}(a_{n+2})$ is in the interior of U_∞ . To show completeness, it is enough to show that every closed ball for the intrinsic metric f^*g on U_∞ is compact, by the Hopf–Rinow–Cohn-Vossen Theorem [BBI01, Theorem 2.5.28]. The key observation is that if $a_\infty \in U_\infty$ and (f^n, a_n) is an ancestor of (f^∞, a_∞) , then for every $k \geq 1$, the point $a_{n+3k} = a_{n+3k}^n \in U_{n+3k}$ is at distance at least k from the boundary of U_{n+3k} . For $k = 1$, we can argue as follows. If $\gamma : [0, 1] \rightarrow \overline{U_{n+3}}$ is a piecewise \mathcal{C}^1 (or rectifiable) curve from a_{n+3} to an edge of U_{n+3} , and if $t_0 \in [0, 1]$ is the last time such that $\gamma(t_0) \in \partial U_{n+3}$, then there exists $t_1 \in [t_0, 1]$ such that $f^{n+3}(\gamma(t_1)) \notin \mathcal{N}$.¹⁹ The endpoints of γ belong to (the closures of) X -lines with the same coorientations in $\overline{U_{n+3}} \setminus U_{n+3}^n$, and the normalization of r_0 implies that the length of either $\gamma|_{[t_0, t_1]}$ or $\gamma|_{[t_1, 1]}$ is at least 1, so the length of γ is at least 1. The general case $k \geq 1$ can be obtained by induction. Therefore, if $B = B(a_\infty, r) \subset U_\infty$ is a closed intrinsic ball of radius $r > 0$ centered at a_∞ , then $B \subset U_\infty^N$ for a sufficiently large $N \geq 1$, and $B_N = (\psi^N)^{-1}(B) \subset U_N$ coincides with a closed intrinsic ball of radius r in U_N . By [BBI01, Theorem 2.5.28], B_N is compact since U_N is complete, so $B = \psi^N(B_N)$ is compact as well.

We now define

$$\mathcal{A}^\infty := \{f^\infty \mid f \in \mathcal{A}^1\}.$$

For every $p \in M$, $\mathcal{A}_p^\infty \neq \emptyset$ by our hypothesis. If \lesssim^n denotes the preorder on \mathcal{A}_*^n , we define a preorder \lesssim^∞ on \mathcal{A}_*^∞ as follows: if $f_*^\infty, g_*^\infty \in \mathcal{A}_*^\infty$, we set $f_*^\infty \lesssim^\infty g_*^\infty$ if and only if there exists $n \geq 1$ and ancestors $f_*^n, g_*^n \in \mathcal{A}_*^n$ of f_*^∞ and g_*^∞ , respectively, satisfying $f_*^n \lesssim^n g_*^n$. It is straightforward to check that \lesssim^∞ is well-defined and that $(\mathcal{A}^\infty, \lesssim^\infty)$ is a weak prefoliation. In particular, two surfaces $f^\infty, g^\infty \in \mathcal{A}^\infty$ have no topological crossings. Therefore, we have shown that \mathcal{A}^∞ is a branching foliation tangent to η , and Theorem 4.18 finishes the proof. \square

Remark 5.12. *Let us define a **partial branching foliation** in the same way as a branching foliation, without the condition that the leaves cover M . Then, Example 5.9 readily shows that a partial branching foliation induces a complete and backward/forward weak prefoliation. Proposition 5.11 and the previous proof immediately imply the following: for any partial branching foliation \mathcal{F}° , there exists a branching foliation \mathcal{F} with $\mathcal{F}^\circ \subset \mathcal{F}$.*

6 Upper enveloping tiles

In this section, we extend the notions of *upper enveloping surface* and *forward envelope* from [BI08, Section 6.1] to our setup. We will assume that the reader is familiar with the notion of a one-dimensional prefoliation on the plane from [BI08, Section 5]. Our proof of the existence of forward envelopes essentially follows the strategy of [BI08], but we find convenient to phrase it in a slightly more abstract way.

¹⁹For this to be true, we crucially need to apply the forward or backward extensions thrice, because of the possible presence of connections between two saddles.

6.1 Preliminaries

Let (\mathcal{A}, \preceq) be a (possibly empty) weak prefoliation which is backward and complete. Our goal is to extend the tiles in \mathcal{A} to tiles with only forward edges. The first step is to define new neighboring tiles, the *forward envelopes*, which play the role of “upper neighbors” of the existing tiles (or are new tiles if \mathcal{A} was empty). In the present section, we extend the definition of forward envelopes to our setup. In the next section, we extend the preorder to these tiles and to their completions. In the section after, we glue the tiles in \mathcal{A} to their newly created neighbors and we further extend the preorder one last time. Before getting to the heart of the matter, let us make some remarks and introduce some terminology.

The flow of X induces a natural \mathbb{R} -action on \mathcal{A}_* by “sliding the marked point” along a X -line. More precisely, for every $f_* = (f : U \rightarrow M, a) \in \mathcal{A}_*$ and $t \in \mathbb{R}$, we define the t -**translation** of f_* by

$$f_*^t := (f, \tilde{\phi}^t(a)),$$

where $\tilde{\phi}^t$ denotes the flow of $\tilde{X} = f^*X$. For every $p \in M$, we have

$$f_* \in \mathcal{A}_p \iff f_*^t \in \mathcal{A}_{\phi^t(p)},$$

where ϕ^t denotes the flow of X . Therefore, this operation extends to a bijection

$$\Phi^t : \mathcal{A}_p \rightarrow \mathcal{A}_{\phi^t(p)}$$

which obviously defines a \mathbb{R} -action on \mathcal{A}_* .

If $p \in M \setminus \Delta$ and $D \subset M$ is an open 2-disk transverse to X centered at p , then \mathcal{A} induces a *one-dimensional prefoliation* (in the sense of [BI08, Section 5.2]) on D for the (continuous) oriented line field obtained as the trace of η on D . More precisely, if X_η denotes a unit vector field directing this line field, then the intersections of tiles in \mathcal{A} with D is a collection \mathcal{A} of flow lines of X_η , and for every $q \in D$, the preorder \preceq induces a total order on the set of flow lines of X_η passing through q as in [BI08, Section 5.2] (see also the beginning of [BI08, Section 5.1]). We call the data of \mathcal{A} equipped with this order the **trace** of \mathcal{A} on D .

We say that a singularity $p \in \Delta_{\text{sa}} \cup Q$ is **surrounded by unstable manifolds** if either

- Every stable branch at p intersects the unstable manifold of a source or quadratic singularity, or
- $p \in \Delta_{\text{sa}}$, p is connected to $q \in \Delta_{\text{sa}}$, and three of the stable branches of p and q intersect unstable manifolds of source or quadratic singularities.

We define the **unstable locus** $M^{\text{un}} \subset M$ as the union of interiors of unstable manifolds of source and quadratic singularities, together with the singularities in $\Delta_{\text{sa}} \cup Q$ surrounded by unstable manifolds and their unstable branches.

We define the **regular locus** of M as $M^{\text{reg}} := M \setminus \Delta$. We further partition the singularity locus Δ into two sets

$$\Delta^{\text{good}} := \Delta \cap M^{\text{un}}, \quad \Delta^{\text{bad}} := \Delta \setminus \Delta^{\text{good}},$$

and we define the **good locus** by $M^{\text{good}} := M \setminus \Delta^{\text{bad}} = M^{\text{reg}} \cup \Delta^{\text{good}}$. Roughly speaking, this is the set of points at which it will make sense to define upper enveloping tiles.

Finally, we define the **pure locus** of M as $M^{\text{pure}} := M^{\text{reg}} \setminus M^{\text{un}}$. It is foliated by the flow lines of X disjoint from the unstable locus. We say that such a flow line is **pure**. Notice that we have

$$M^{\text{good}} = M^{\text{un}} \sqcup M^{\text{pure}}.$$

Let $p \in \Delta_{\text{sa}} \cup Q$. If $p \in \Delta_{\text{sa}}$ and no stable branch of X at p is in M^{un} , we say that p is a **pure saddle singularity**. If exactly one stable branch of X at p is contained in M^{pure} , we say that p is a **quadratic-like singularity**. We denote by $\Delta_{\text{sa}}^{\text{pure}}$ the set of pure saddle singularities of X , and by Q^* the set of quadratic-like singularities of X .

We now describe the behavior of η on M^{un} .

Lemma 6.1. *The plane field η is uniquely integrable on M^{un} .*

Proof. We need to show that η is uniquely integrable at the singularities surrounded by unstable manifolds and along their unstable branches. This will immediately follow from the two slightly stronger claims:

1. *If there exists a connection γ from $p \in \Delta_{\text{so}} \cup Q$ to $q \in \Delta_{\text{sa}} \cup Q$, then η is uniquely integrable at q and along the unstable branches at q on the side of γ .*
2. *If moreover there exists a connection γ' from q to $q' \in \Delta_{\text{sa}}$, then η is uniquely integrable at q' and along the unstable branch at q' on the quadrant at q' determined by γ and γ' .*

The meaning of the underlined parts will be clarified in the proof. Let S^u denote the interior of the unstable manifold of X at p .

For the first claim, let S be a small open \mathcal{C}^1 disk tangent to η and passing through a point q_0 lying on one of the unstable branches γ^u at q , and let S_γ be the closure of the connected component of $S \setminus \gamma_u$ on the side of γ . This side can be characterized as follows: if D is a small smooth disk in M transverse to X centered at a point $p_0 \in \gamma$ close to q , then the points in S_γ sufficiently close to γ^u all get sent to D or to q under the negative flow of X , and the corresponding flow lines stay close to $\gamma \cup \{q\} \cup \gamma^u$. Let \widehat{S}_γ be the union of the saturation of S_γ by the flow of X with γ , so that \widehat{S}_γ is a \mathcal{C}^1 surface with boundary and corner tangent to η . Since \widehat{S}_γ intersects S^u along γ , and η is uniquely integrable there, the interior of \widehat{S}_γ is entirely contained in S^u . Therefore, S_γ is contained in $S^u \cup \gamma^u$. If $q_0 = q$, then S_γ is defined in a similar way, and its interior contains point in γ , which belong to the unstable manifold of p . This implies that S_γ is contained in the union of S^u with q and the two unstable branches at q . The desired unique integrability property of η follows.

For the second claim, γ^u will denote the unstable branch at q' lying on the side determined by γ and γ' . Similarly, let S be a small open \mathcal{C}^1 disk tangent to η and passing through a point $q'_0 \in \gamma^u$, and let $S_{\gamma, \gamma'}$ be the closure of the connected component of $S \setminus \gamma^u$ in the side determined by γ and γ' . This side can be characterized as follows: if D is as before, then the points in $S_{\gamma, \gamma'}$ sufficiently close to γ^u all get sent to D or to q' under the negative flow of X , and these flow lines stay close to $\gamma \cup \{q\} \cup \gamma' \cup \{q'\} \cup \gamma^u$. Let $\widehat{S}_{\gamma, \gamma'}$ be the union of the saturation of $S_{\gamma, \gamma'}$ by the flow of X with γ' , so that $\widehat{S}_{\gamma, \gamma'}$ is a \mathcal{C}^1 surface with boundary and corners tangent to η . Since $\widehat{S}_{\gamma, \gamma'}$ intersects γ' and lies on the side of γ' determined by γ , the previous point implies that $\widehat{S}_{\gamma, \gamma'}$ is entirely contained in $S^u \cup \gamma' \cup \gamma^u$, hence $S_{\gamma, \gamma'}$ is contained in $S^u \cup \gamma^u$. Finally, if $q'_0 = q'$, we denote by $S_{\gamma, \gamma'}$ the closure of the connected component of $S \setminus (\gamma' \cup \gamma^u)$ lying in the quadrant at q' determined by γ and γ' . Arguing as before, we deduce that $S_{\gamma, \gamma'}$ is entirely contained in $S^u \cup \gamma' \cup \{q'\} \cup \gamma^u$. The desired unique integrability property of η follows. \square

Therefore, η induces a foliation \mathcal{F}^{un} on M^{un} . Notice that M^{un} is invariant under the flow of X , and contains no nontrivial closed orbits of X (independently of the hypothesis that (X, η) has no disk of tangency).

Lemma 6.2. *Let $f : L \rightarrow M$ be a (complete) leaf of η in M^{un} . Its universal cover $\tilde{f} : \tilde{L} \rightarrow M$ is a tile. We call it an **unstable tile**.*

Proof. By construction, f and \tilde{f} are made of unstable manifolds of source singularities and interiors of unstable manifolds of quadratic singularities, glued together along unstable connections of saddle or quadratic singularities surrounded by them. One easily deduces, using the Poincaré–Bendixson theorem and the Hopf theorem, that L is not a sphere, hence \tilde{L} is homeomorphic to a simply connected subset of \mathbb{R}^2 . Moreover, \tilde{f} is unstable-complete by definition. We are left to show that \tilde{f} is well-cornered at every singularity in $\Delta_{\text{sa}} \cup Q$. It is clearly the case at a singularity surrounded by unstable manifolds, by construction. Let $p \in \Delta_{\text{sa}}$ be surrounded by unstable manifolds, and γ be a connection from p to $q \in \Delta_{\text{sa}}$ which is *not* surrounded by unstable manifolds. Then, the unstable branches at q both belong to M^{pure} and every singular region $D_0 \subset \tilde{L}$ for q contains an open half-disk D'_0 mapping to a half-disk D in M containing a portion of γ , and whose ‘straight’ part of the boundary is contained in the union of q and its unstable branches. This shows that \tilde{f} is well-cornered at q .

Since X only has admissible connections, it is now enough to show the following claim: if $g : U \rightarrow M$ is a \mathcal{C}^1 parametrization of the (interior of) the unstable manifold of singularity $p \in \Delta_{\text{so}} \cup Q$, then g is well-cornered. We will only treat the case of a source singularity, the case of a quadratic singularity being similar. Let $q \in \Delta_{\text{sa}} \cup Q$, and let $D_0 \subset U$ be a singular region of g for q . Since all of the X -lines in g converge to $g^{-1}(p)$ in negative time, D_0 cannot intersect X -lines corresponding to the unstable branches at q . Therefore, if D_0 contains a X -line corresponding to a connection from p to q , then D_0 contains a small open half-disk D'_0 similar as before. Otherwise, D_0 contains a small open quadrant C_0 mapped to an open quadrant C in M whose ‘corner’ boundary is sent to the union of q with two consecutive unstable and stable branches. In both cases, g is well-cornered at q over D_0 . \square

6.2 Forward curves

To construct and study forward envelopes, it will be crucial to understand the ‘forward’ structure of the tiles under consideration with respect to the pullback of the vector field X . The forward structures of surfaces in [BI08] is much easier to understand due to the absence of singularities of X . In the context of this article, we will need to carefully subdivide tiles into various regions, and extend the definition of *forward curves*. A crucial step is to understand how two forward curves with the same endpoints are related to each other, which is achieved in Lemma 6.7 below. We also collect some technical results that will be useful later.

Definition 6.3. *Let $f : U \rightarrow M$ be a tile.*

- The **regular locus** of f is the open subset $U^{\text{reg}} := f^{-1}(M^{\text{reg}}) \subset U$. It is foliated by X -lines.
- The **good locus** of f is the open subset $U^{\text{good}} := f^{-1}(M^{\text{good}}) \subset U$.
- The **unstable locus** of f is the open subset $U^{\text{un}} := f^{-1}(M^{\text{un}}) \subset U$. A connected component of U^{un} is called an **unstable component** of f .
- The **pure locus** of f is the subset $U^{\text{pure}} := f^{-1}(M^{\text{pure}}) \subset U$. A X -line in U^{pure} is called **pure**.

We now we fix a marked tile $f_\star = (f : U \rightarrow M, a)$ for the rest of this section.

Definition 6.4. A **forward (resp. backward) curve** in U is a C^1 immersed curve $\gamma : [0, 1] \rightarrow U$ such that for every $t \in [0, 1]$, either

1. $\gamma(t) \in U^{\text{un}}$, or
2. $\gamma(t) \in U^{\text{reg}}$ and $\dot{\gamma}(t)$ is positively (resp. negatively) transverse to the X -line passing through $\gamma(t)$.

Furthermore, we say that γ is **strictly forward (resp. backward)** if it satisfies condition 2 above at every $t \in [0, 1]$.

We emphasize that we do not impose any constraints on the part of a forward curve which is contained in U^{un} . Outside of that part, the curve has to be transverse to the X -lines it meets. If $\gamma : [0, 1] \rightarrow U$ is a curve, we denote by $\check{\gamma} : [0, 1] \rightarrow U$ the corresponding reversed curve defined by $\check{\gamma}(t) := \gamma(-t)$, $t \in [0, 1]$. Obviously, γ is forward if and only if $\check{\gamma}$ is backward.

The following lemma will be particularly useful in Section 7 below and serves as a warm-up.

Lemma 6.5. Let $\gamma : [0, 1] \rightarrow U$ be a forward curve.

1. If $\ell \subset U^{\text{pure}}$ is a pure X -line, then γ intersects ℓ at most once.
2. If $\gamma(0) = \gamma(1)$, then γ is entirely contained in an unstable component of f .

Proof. We show 1 by contradiction. Without loss of generality, let us assume that $\gamma(0) \in \ell$ and $\gamma(1) \in \ell$. We can further modify γ so that $\gamma(0) = \gamma(1)$ and $\gamma'(0) = \gamma'(1)$, by flowing γ along \widetilde{X} near its starting point, since γ is positively transverse to ℓ at $t = 0$. After a small perturbation, we can further assume that γ has finitely many (and transverse) self-intersections. The latter can be resolved (whether they occur in U^{un} or U^{pure}) in order to obtain a finite collection of *embedded* forward curves. We can therefore assume that γ is embedded, and bounds a domain $D \subset U$ homeomorphic to a closed disk. We now analyze the possible behaviors of ℓ in D . Observe that γ cannot intersect ℓ except at $x = \gamma(0) = \gamma(1)$, so one of the two connected components of $\ell \setminus \{x\}$ is entirely contained in D . Assume first the ‘negative’ component is contained in D . Then by Poincaré–Bendixson and the absence of closed orbits of \widetilde{X} , ℓ necessarily converges in negative times to a singularity $x_0 \in U$ contained in the interior of D . Moreover, since ℓ is pure, then x_0 is not a source and at least one stable branch of \widetilde{X} at x_0 lies in U^{pure} . The latter cannot intersect γ since γ is forward, so it must converge in negative times to a saddle singularity x_1 (and x_0 is a saddle as well). Once again, one of the stable branches at x_1 must lie in U^{pure} , and intersect γ nor converge to a singularity in negative times, a contradiction. The same argument applies when the ‘positive’ component of $\ell \setminus \{x\}$ is contained in D by considering unstable branches instead of stable branches.

The second item follows immediately, as a forward curve which is not entirely contained in U^{un} must intersect a pure X -line. \square

Using similar arguments, one can easily show that the unstable components of a tile are simply connected. The proof is left as an exercise for the reader. Combined with the previous lemma, this implies that a forward curve is homotopic relative to U^{pure} (hence homotopic through forward curves) to an *embedded* one.

Definition 6.6. Let $\gamma_0 : [0, 1] \rightarrow U$ and $\gamma_1 : [0, 1] \rightarrow U$ be two forward curves with the same endpoints, namely, $\gamma_0(0) = \gamma_1(0)$ and $\gamma_0(1) = \gamma_1(1)$.

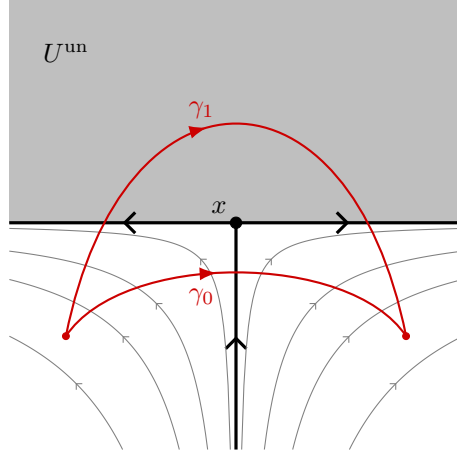

Figure 9: A (full) T -move.

- We say that γ_0 and γ_1 are **forward-homotopic** if they are homotopic relative to their endpoints through forward curves.
- We say that γ_1 is obtained from γ_0 by a **full T -move** if these two curves only intersect at their endpoints and bound a compact domain D in U containing exactly one singularity of \tilde{X} . We further require that this singularity is quadratic-like, and γ_0 intersects its pure stable branch. See Figure 9.
- We say that γ_1 is obtained from γ_0 by a (**local**) T -move if there exists a segment $I \subset [0, 1]$ such that γ_0 and γ_1 coincide on $[0, 1] \setminus I$, and $\gamma_{1|I}$ is obtained from $\gamma_{0|I}$ by a full T -move.

Notice that two forward-homotopic curves intersect the same pure X -lines and the same unstable components in U . Two forward curves that differ from a T -move across a singularity x intersect the same pure X -lines except for the pure stable branch and unstable branches at x , and they intersect the same unstable components in U except for the unstable component at $f(x) \in Q^*$.

Two forward curves with the same endpoints are not necessarily forward-homotopic, but they become forward-homotopic after performing finitely many local T -moves:

Lemma 6.7. *Let γ_0 and γ_1 be two forward curves in U with the same endpoints. There exists forward curves $\tilde{\gamma}_0$ and $\tilde{\gamma}_1$ such that*

- For $i \in \{0, 1\}$, γ_i and $\tilde{\gamma}_i$ are forward-homotopic,
- $\tilde{\gamma}_0$ and $\tilde{\gamma}_1$ differ by a finite sequence of local T -moves.

Proof. After applying forward-homotopies, we can assume that γ_0 and γ_1 are embedded and intersect at finitely many points. We can further reduce to the case where γ_0 and γ_1 only intersect at their endpoints. Let D be the compact domain in U bounded by γ_0 and γ_1 . It contains finitely many singularities of \tilde{X} . We will show the desired statement by induction on the number of these singularities.

If D contains no singularity of \tilde{X} , then every X -line in the interior of $D \cap U^{\text{pure}}$ must intersect both γ_0 and γ_1 by Poincaré–Bendixson. If there is no such X -line, then (the interiors of) γ_0 and γ_1 are contained in the same unstable component and the result is immediate. Otherwise, since D is compact, we can find an open neighborhood U_0 of $D \cap U^{\text{pure}}$ foliated by X -lines intersecting γ_0 and γ_1 once each, and such that $D \setminus U_0$ intersects finitely many unstable components of U . We then use

the flow of \tilde{X} to forward-homotope γ_0 to a forward curve $\tilde{\gamma}_0$ which coincides with γ_1 on U_0 , and we further homotope $\tilde{\gamma}_0$ on each of the finitely many components of $D \setminus U_0$ to match γ_1 .

Let us now assume that $x \in D$ is a singularity of \tilde{X} . We analyze the three different possible cases.

- **Case 1:** $f(x) \in \Delta_{\text{so}}$. Then at least one X -line in the unstable manifold of x intersects γ_0 or γ_1 , say γ_0 . We can forward-homotope γ_0 to $\tilde{\gamma}_0$ so that $\tilde{\gamma}_0$ and γ_1 bound a compact domain $D' \subset D$ which does not contain x , hence reducing the number of singularities of \tilde{X} between the two forward curves.
- **Case 2:** $f(x) \in Q$. If $x \in U^{\text{un}}$, we argue as in Case 1. Otherwise, the stable branch at x lies in U^{pure} and must intersect γ_0 or γ_1 , say γ_0 . We then perform a local T -move on γ_0 along this stable branch to reduce the number of singularities of \tilde{X} in D .
- **Case 3:** $f(x) \in \Delta_{\text{sa}}$. If $x \in U^{\text{un}}$, then we can argue as before. Otherwise, at least one stable branch at x lies in U^{pure} and intersects γ_0 or γ_1 , say γ_0 . If the other stable branch at x lies in U^{un} , then $f(x) \in Q^*$ and we argue as in Case 2. Otherwise, it lies in U^{pure} and either intersects γ_0 , or converge in negative times to another saddle singularity x' in D . In the latter case, at least one stable branch at x' is contained in U^{pure} , and it must intersect γ_0 . In both cases, one of the two unstable branches at x is ‘trapped’ in a domain bounded by γ_0 and by stable and unstable branches at x and at x' if it exists. If this unstable branch converges to another saddle singularity, the unstable branches of the latter are also trapped and cannot converge to singularities. However, this is impossible by Poincaré–Bendixson and the absence of closed orbits of \tilde{X} .

In all three cases, we constructed a forward-homotopy of γ_0 or γ_1 , or performed some local T -move, reducing the number of singularities between γ_0 and γ_1 . Note that for embedded forward curves, T -moves and forward-homotopies commute, so these operations can be performed in the order prescribed by the statement. \square

Let us now consider the following situation. Assume that there exist two saddle singularities x_0 and x_1 in U such that

- There exists a connection γ from x_0 to x_1 ,
- One stable branch at x_0 is contained in U^{pure} while the other is contained in U^{un} ,
- The stable branch at x_1 different than γ is contained in U^{un} .

Then one can perform a sequence of two consecutive T -moves, one across x_0 followed by another one across x_1 , as depicted in Figure 10. We call this operation a **double T -move**. By our assumptions on X , there cannot be longer sequences of T -moves.

Let now $g_\star = (g : V \rightarrow M, b)$ be another marked tile satisfying $g(b) = f(a)$. The following lemma will be useful in the next sections.

Lemma 6.8. *Let $\gamma_0, \gamma_1 : [0, 1] \rightarrow U$ be two forward curves such that $\gamma_0(0) = \gamma_1(0) = a$ and $\gamma_0(1) = \gamma_1(1)$. If both γ_0 and γ_1 admit lifts $\tilde{\gamma}_0$ and $\tilde{\gamma}_1$ to g_\star , then $\tilde{\gamma}_0(1) = \tilde{\gamma}_1(1)$.*

Proof. If a forward curve γ is obtained from γ_0 by a T -move across some singularity $x \in U$, we say that it is a *negative T -move* if γ intersects the pure stable branch at x . In that case, γ lifts to g_\star to a curve $\tilde{\gamma}$ with $\tilde{\gamma}(1) = \tilde{\gamma}_0(1)$. Here, we used that g has no slits.

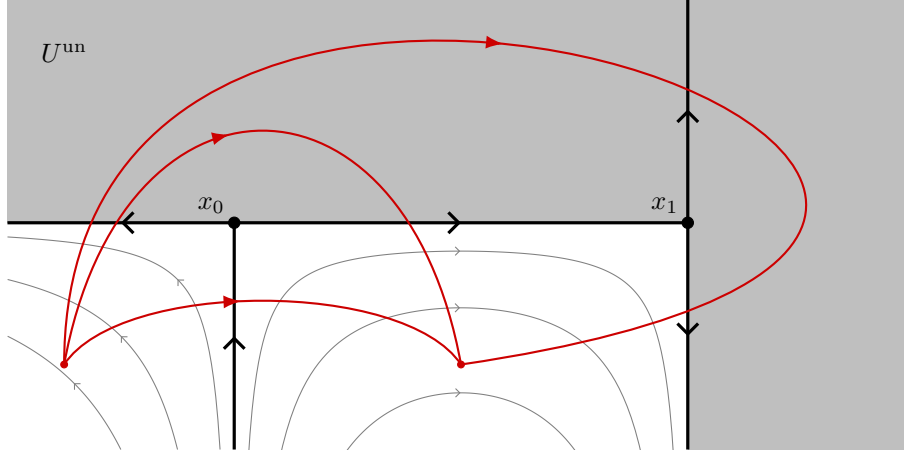

Figure 10: A double T -move.

The result is clear when γ_0 and γ_1 are forward-homotopic. In general, it is a consequence of the following immediate refinement of Lemma 6.7: there exists a forward curve γ in U such that for every $i \in \{0, 1\}$, γ is obtained from γ_i by performing a forward-homotopy followed by finitely many *negative* T -moves. Therefore, γ lifts to g_\star to a curve $\tilde{\gamma}$ satisfying $\tilde{\gamma}_0(1) = \tilde{\gamma}(1) = \tilde{\gamma}_1(1)$. \square

In the next sections, we will need a strengthening of the unstable-complete condition from Definition 5.4:

Definition 6.9. A tile $f : U \rightarrow M$ is **strongly unstable-complete** if for every connected component V of $U^{\text{un}} \subset U$, there exists an unstable tile $g : W \rightarrow M$ and a diffeomorphism $\varphi : V \rightarrow W$ such that $g \circ \varphi = f$.

Notice that a complete and forward tile is automatically strongly unstable-complete.

6.3 Forward envelopes

We consider a (possibly empty) weak prefoliation $(\mathcal{A}, \lesssim^{\mathcal{A}})$ which is backward and complete. If $p \in M$, a **section** of $(\mathcal{A}_p, \lesssim_p^{\mathcal{A}})$ is a subset $\Sigma_0 \subset \mathcal{A}_p$ which is *downward closed*: for all $f_\star \in \Sigma_0$ and $g_\star \in \mathcal{A}_p$, if $g_\star \lesssim_p^{\mathcal{A}} f_\star$ then $g_\star \in \Sigma_0$. Typical examples of sections are:

- $\Sigma_0 = \emptyset$,
- $\Sigma_0 = \{g_\star \in \mathcal{A}_p \mid g_\star \lesssim_p^{\mathcal{A}} f_\star\}$, where $f_\star \in \mathcal{A}_p$.

We now extend the definition of an *upper enveloping surface* from [BI08]:

Definition 6.10 (See [BI08], Definition 6.1). An **upper enveloping tile** is a pair (f, Σ) , where $f : U \rightarrow M$ is a tile and $\Sigma : U \rightarrow \mathcal{P}(\mathcal{A}_\star)$ is a map which assigns a section $\Sigma(a) \subset \mathcal{A}_{f(a)}$ to every $a \in U$, such that the following conditions hold.

0. Either f has exactly one proper edge e_0 , and this edge is a pure X -line with forward coorientation, or f has no proper edge but has a distinguished unstable component U_0 . In the first case, we call e_0 the **initial edge** of f and we say that f is of **pure type**, and in the second case, we call U_0 the **initial unstable component** of f and we say that f is of **unstable type**. In both cases, we refer to e_0 or U_0 as the **initial locus** of f , and we denote it by I_0 .

1. f is strongly unstable-complete, in the sense of Definition 6.9.
2. Every point in U^{good} can be reached from the initial edge or unstable component by a forward curve.
3. Let $a \in U^{\text{reg}}$ and $D \subset M$ be a smooth open 2-disk transverse to X and containing $f(a)$. Let $\gamma : [0, 1] \rightarrow U$ be a strictly forward curve starting at a and contained in $f^{-1}(D)$, and let \mathcal{A} be the trace of \mathcal{A} on D . We require that the curve $f \circ \gamma$ on D is contained in the one-dimensional upper envelope of $(f(a), \Sigma(a) \cap D)$ with respect to \mathcal{A} (as defined in [BI08, Section 5.1]). Moreover, we require that for every $t \in [0, 1]$, $\Sigma(\gamma(t))$ is the shadow of $(f(a), \Sigma(a) \cap D)$ at $f(\gamma(t))$ (as defined in [BI08, Section 5.1]).
4. Σ is coherent along X -lines, in the following sense: for every $a \in U$ and $t \in \mathbb{R}$, $\Sigma(\tilde{\phi}^t(a)) = \Phi^t(\Sigma(a))$.
5. Σ is coherent at singularities, in the following sense. Let $a \in f^{-1}(\Delta)$ and $g_\star \in \mathcal{A}_{f(a)}$, where $g_\star = (g : U \rightarrow M, b)$, and assume that there exist
 - a X -line γ in U converging to the point a in positive (resp. negative) times, and
 - two points $a' \in \gamma$ and $b' \in V$ such that $f(a') = g(b')$ and the X -line in V passing through b' converges to b in positive (resp. negative) times.

Then the following holds:

$$g_\star \in \Sigma(a) \iff (g, b') \in \Sigma(a').$$

These conditions easily imply that Σ is coherent along unstable components in the following sense. If $a, a' \in U$ belong to the same unstable component of f , then for every $g_\star = (g : V \rightarrow M, b) \in \mathcal{A}_{f(a)}$, $b \in V^{\text{un}}$ and there is a unique $b' \in V^{\text{un}}$ in the same unstable component as b such that $g(b') = f(a')$. In that case, we have:

$$(g, b) \in \Sigma(a) \iff (g, b') \in \Sigma(a').$$

Moreover, if $a_0 \in U$ belongs to the initial locus I_0 of f , then the map Σ is entirely determined by $\Sigma(a_0) \subset \mathcal{A}_{f(a_0)}$. If $p = f(a_0)$ and $\Sigma(a_0) = \Sigma_0$, we say that the upper enveloping tile $F = (f, \Sigma)$ **starts at** (p, Σ_0) . Notice that f is of pure type if and only if $p \in M^{\text{pure}}$, and f is of unstable type if and only if $p \in M^{\text{un}}$. It will be convenient to include the choice of an initial *basepoint* a_0 and consider *pointed* upper enveloping tiles $F_\circ = (f, \Sigma, a_0)$. We will typically denote upper enveloping tiles by capital letters, such as F for (f, Σ) , G for (g, Σ') , etc. and triples (f, Σ, a_0) as above by F_\circ .²⁰ Following [BI08], we call the map Σ the **shadow** of F .

For the rest of this section, we fix a point $p \in M^{\text{good}}$ and a section $\Sigma_0 \subset \mathcal{A}_p$. We denote by $\mathcal{E}_p(\Sigma_0)$ the collection of pointed upper enveloping tiles starting at (p, Σ_0) .

The following lemma is a generalization of [BI08, Lemma 6.2]. Although the main idea is the same, the proof is much more complicated in our setup.

Lemma 6.11. *There exists an upper enveloping tile starting at (p, Σ_0) .*

Proof. If $p \in M^{\text{un}}$, we simply consider the unstable tile f passing through p with an appropriate basepoint, and we extend Σ_0 in the only possible way (recall that η is uniquely integrable along unstable tiles).

If $p \in M^{\text{pure}}$, we construct an upper envelope starting at p in 3 steps.

²⁰We choose the subscript \circ and not \star to emphasize that the basepoint lies in the initial locus I_0 of the tile, and plays a different role than a marked point.

- *Step 1: constructing a forward strip.* By definition, there is a pure flow line of X passing through p . Let $D \subset M$ be a small open smooth disk transverse to X and passing through p , and \mathcal{A} be the trace of \mathcal{S} on D . It is a two-dimensional prefoliation in the sense of [BI08, Section 5.1]. Let $f_0 : [0, \epsilon) \rightarrow D$ be the (forward) upper envelope for $(p, \Sigma_0 \cap D)$ with respect to \mathcal{A} , with shadow $\bar{\Sigma}_0$, defined up to some $\epsilon > 0$. As opposed to [BI08, Lemma 6.2], we do not impose any lower bound on ϵ . Let now $f : [0, \epsilon) \times \mathbb{R} \rightarrow M$ be the extension of f_0 under the flow of X , defined by $f(x, t) := \varphi_X^t(f_0(x))$. The one-dimensional shadow $\bar{\Sigma}_0$ extends to a shadow Σ for f . Notice that f is not quite a tile yet, since it might fail to be strongly unstable-complete and well-cornered. To remedy this, we will further extend f .
- *Step 2: unstable-completion.* Since the unstable locus of f is open, there exists countably many open intervals $I_n \subset [0, \epsilon)$, $n \in \mathbb{N}$, such that this unstable locus is exactly the disjoint union of the subsets $I_n \times \mathbb{R}$. Therefore, there exists countably many closed intervals (possibly reduced to a point) $J_n \subset [0, \epsilon)$, $n \in \mathbb{N}$, such that the pure locus (complement of the unstable locus) is the disjoint union of the subsets $J_n \times \mathbb{R}$. We choose J_0 such that $0 \in J_0$. For every $n \in \mathbb{N}$, there exists an unstable tile $g_n : V_n \rightarrow M$ and a \mathcal{C}^1 map $\varphi_n : I_n \times \mathbb{R} \rightarrow V_n$ satisfying $g_n \circ \varphi_n = f|_{I_n \times \mathbb{R}}$. If I_n is of the form (a, b) with $b < \epsilon$, then g_n is injective: the curve $t \in (a, b) \mapsto \varphi_n(t, 0)$ in V_n does not intersect the same X -line twice, as it reaches two distinct edges of V_n on both sides. Therefore, φ_n is an embedding. If $b = \epsilon$, g_n might fail to be injective, e.g., if the transverse disk D ‘spirals’ around a source singularity. However, one can easily shrink ϵ (or modify D) so that g_n becomes an embedding. Recall that the completion of an unstable tile does not have closed boundary components, thanks to our hypothesis that (X, η) has no disk of tangency.

We denote by $\tilde{f} : \tilde{U} \rightarrow M$ the extension of f obtained by gluing the g_n ’s to f along the φ_n ’s. There is a natural embedding $\varphi : [0, \epsilon) \times \mathbb{R} \hookrightarrow \tilde{U}$ satisfying $\tilde{f} \circ \varphi = f$. By construction, \tilde{U} is homeomorphic to a simply connected subset of \mathbb{R}^2 , and \tilde{f} is strongly unstable-complete. The shadow Σ extends in a unique way to a shadow $\tilde{\Sigma}$ for \tilde{f} , and the conditions of Definition 6.10 are all satisfied. However, we need to extend \tilde{f} a bit further in order to make it well-cornered.

- *Step 3: filling the slits.* Let $q \in \Delta_{\text{sa}} \cup Q$, not surrounded by unstable manifolds, and $D_0 \subset \tilde{U}$ be a singular region of \tilde{f} for q . Notice that if \tilde{f} fails to be graphical near q over D_0 , or has a puncture or a slit at q in D_0 , then one of the two cases happen:
 - **Case 1:** There exist two X -lines intersecting D_0 and mapping to opposite stable branches at q .
 - **Case 2:** There exist two X -lines intersecting D_0 and mapping to opposite unstable branches at q .

We claim that Case 1 never happens. Otherwise, we could find a third X -line ℓ_u intersecting D_0 and mapping to an unstable branch at q . Since q is not surrounded by unstable manifolds, ℓ_u and at least one of the stable X -lines lie \tilde{U}^{pure} . We denote the latter one by ℓ_s . By definition of \tilde{f} , there exists an embedded and strictly forward curve γ in \tilde{U} intersecting both ℓ_s and ℓ_u *positively*. Moreover, γ belongs to $\varphi([0, \epsilon) \times \mathbb{R})$. Let us assume without loss of generality (up to reverting X and considering backward curves instead) that γ starts on ℓ_u and ends on ℓ_s . We then ‘slide’ γ near its endpoint along ℓ_s towards q and then along ℓ_u to obtain a *closed* strictly forward curve intersecting ℓ_u ; see Figure 11. By construction, this curve belongs to $\varphi([0, \epsilon) \times \mathbb{R})$ which is impossible.

We now focus on Case 2. There are two subcases depending on whether $q \in \Delta_{\text{sa}}$ or $q \in Q$. If $q \in \Delta_{\text{sa}}$, the previous case implies that D_0 intersects a unique X -line mapping to a stable branch

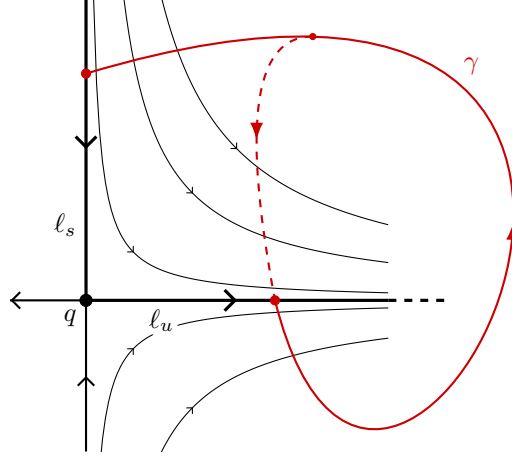

Figure 11: Sliding γ near its endpoint in Case 1.

at q , and this X -line lies in \tilde{U}^{un} . Therefore, if \tilde{f} is not well-cornered at q over D_0 , then it has a slit corresponding to the other stable branch at q . Similarly, if $q \in Q$ and if \tilde{f} is not well-cornered at q over D_0 , then arguing as before shows that no X -line intersecting D_0 is mapped to the stable branch at q , and \tilde{f} has a slit corresponding to the stable branch at q . Note that it might happen that one of the unstable branches at q is the initial edge of \tilde{f} , i.e., the X -line corresponding to $f|_{\{0\} \times \mathbb{R}}$. In that case, it is easy to see that \tilde{f} is well-cornered at q over D_0 .

To summarize, in both subcases, if \tilde{f} is not well-cornered at q over D_0 , then it has a slit corresponding to a stable branch of q , and the other stable branch lies in M^{un} ; see Figure 12. Moreover, this stable branch might possibly be connected to another singularity q_- in negative times, in which case $q_- \in \Delta_{\text{sa}}$.

We now explain how to fill the slits to make \tilde{f} well-cornered, and how to extend $\tilde{\Sigma}$. With the previous notations, let $V \subset \tilde{U}$ be the saturation of D_0 by X -lines. It is an open subset homeomorphic to an open disk. Clearly, there exists an embedding $\hat{\varphi}_{q,D_0} = \hat{\varphi} : V \hookrightarrow \hat{V}$ where \hat{V} is homeomorphic to an open disk and $\hat{\varphi}(V) \subset \hat{V}$ is the complement of a proper embedding of $[0, \infty)$ into \hat{V} , and such that $\tilde{f}|_V$ extends on \hat{V} to a map \hat{f}_{q,D_0} satisfying:

- $\hat{f}_{q,D_0} \circ \hat{\varphi} = \tilde{f}|_V$,
- \hat{f}_{q,D_0} is an injective immersion of an open disk into M tangent to η whose image contains q .

We can now glue \tilde{f} and \hat{f}_{q,D_0} along V to remove the slit at q over D_0 . Performing this operation at every singularity with a slit, we obtain an immersion $\hat{f} : \hat{U} \rightarrow M$ tangent to η , where \hat{U} is homeomorphic to a simply connected domain of \mathbb{R}^2 . We further have to extend $\tilde{\Sigma}$ to \hat{U} so that the properties of Definition 6.10 are satisfied. We fix q and D_0 as before, so that \tilde{f} has a simple slit at q over D_0 , and we will view $D_0 \subset V \subset \hat{V}$ as subsets of \hat{U} . Let $x_0 \in \hat{V}$ lying on the X -line mapped to the unstable branch l_s at q , and let $p_0 := \hat{f}(x_0)$. Let $D \subset M$ be a small embedded disk in M passing through p_0 and transverse to X . Let $\gamma_0 : [-1, 1] \rightarrow \hat{V}$ be a strictly forward curve with $\gamma_0(0) = x_0$ and such that $\hat{f} \circ \gamma_0$ parametrized the intersection of D with $\hat{f}(\overline{D_0})$, where $\overline{D_0}$ denotes the closure of D_0 in \hat{U} . We have to show that $\hat{f} \circ \gamma_0$ is contained in the one-dimensional upper envelope of $(\hat{f} \circ \gamma_0(-1), \tilde{\Sigma}(\gamma_0(-1)) \cap D)$ in D , and that $\tilde{\Sigma}(\gamma_0(t)) \cap D$ coincides with its shadow at $\hat{f} \circ \gamma_0(t)$ for every $t \in [-1, 1] \setminus \{0\}$. In particular, this provides the

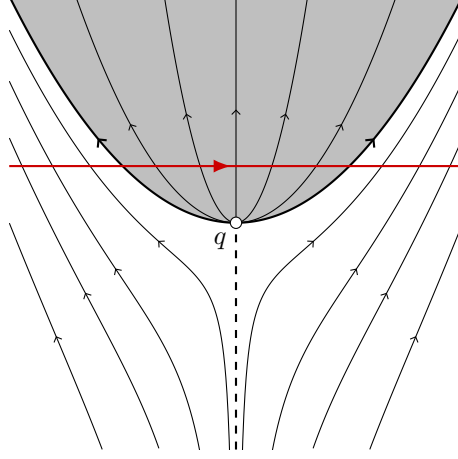

Figure 12: A slit at q . The red line corresponds to the forward curve induced by f_0 .

desired extension of $\tilde{\Sigma}$ at x_0 , by considering the shadow of the former upper envelope at that point. To show the claim, we first observe that since \mathcal{A} is backward and complete by hypothesis, a tile in \mathcal{A} passing through q is of one of the following forms near q : a quadrant with backward boundary and convex corner at q , three quadrants (if $q \in \Delta_{\text{sa}}$) or the union of a quadrant and a half plane (if $q \in Q$) with backward boundary and concave corner at q , or it contains q in the interior of its domain; see Figure 13. This induces a partition of \mathcal{A}_q into three subsets $\mathcal{A}_q^{\text{cvx}}$, $\mathcal{A}_q^{\text{ccv}}$, and \mathcal{A}_q^0 , depending on whether a marked tile has a convex corner, concave corner, or no corner at q . Moreover, let p_+ be points in \mathcal{N} in the right unstable branches at q , and let x_+ be the preimage in \widehat{V} of p_+ by \widehat{f} . Then ‘sliding the marked point along stable/unstable branches at q ’ induces natural injective maps $\varsigma_0 : \mathcal{A}_{p_0} \rightarrow \mathcal{A}_q$ and $\varsigma_+ : \mathcal{A}_{p_+} \rightarrow \mathcal{A}_q$, which preserve the preorder \preceq . Moreover, because of the form of the tiles in \mathcal{A}_q , ς_0 is bijective, and ς_+ is a bijection onto $\mathcal{A}_q^0 \sqcup \mathcal{A}_q^{\text{ccv}}$. Let $\gamma_+ : [0, 1] \rightarrow \widehat{V}$ be an embedded strictly forward curve in \widehat{V} from x_+ to $\gamma_0(1)$. If D_+ is an embedded disk in M transverse to X and containing $\widehat{f} \circ \gamma_+$, then $\widehat{f} \circ \gamma_+$ is contained in the one-dimensional upper envelope for $(p_+, \tilde{\Sigma}(x_+) \cap D_+)$, and $\tilde{\Sigma}(\gamma_+(t)) \cap D_+$ coincides with its shadow at $\widehat{f} \circ \gamma_+(t)$ for every $t \in [0, 1]$. We define a section $\widehat{\Sigma}_+ \subset \mathcal{A}_{p_0} = \mathcal{A}_{p_0} \cap D$ as the smallest section of \mathcal{A}_{p_0} (with respect to the inclusion) containing $\tilde{\Sigma}_+ := \varsigma_0^{-1} \circ \varsigma_+(\tilde{\Sigma}(x_+) \cap D)$.²¹ Notice that $\widehat{\Sigma}_+ \setminus \tilde{\Sigma}_+$ only contains curves with a right boundary at p_0 , corresponding to tiles which have a convex corner at q , i.e., whose images under ς_0 lie in $\mathcal{A}_q^{\text{cvx}}$. Therefore, the invariance of the various structures of interest under the flow of X implies the curve $\gamma_{0|[0,1]}$ is contained in the one-dimensional upper envelope of $(p_0, \widehat{\Sigma}_+)$ in D and its shadow at $\widehat{f} \circ \gamma_0(t)$ for $t \in (0, 1]$ is exactly $\tilde{\Sigma}(\gamma_0(t)) \cap D$. Now, if $\widehat{\Sigma}_- \subset \mathcal{A}_{p_0}$ denotes the shadow at p_0 of the one-dimensional upper envelope of $(\widehat{f} \circ \gamma_0(-1), \tilde{\Sigma}(\gamma_0(-1)) \cap D)$ in D , then $\widehat{\Sigma}_+ \subset \widehat{\Sigma}_-$, and $\widehat{\Sigma}_- \setminus \widehat{\Sigma}_+$ only contains curves with a right boundary at p_0 . This implies that $\gamma_{0|(0,1]}$ is contained in the latter upper envelope, and its shadow at $\widehat{f} \circ \gamma_0(t)$ for $t \in (0, 1]$ is $\tilde{\Sigma}(\gamma_0(t)) \cap D$, as desired.

Moreover, if $x \in \widehat{V}$ is the preimage of q under \widehat{f} , there is a unique way to extend $\widehat{\Sigma}$ at x so that

²¹Concretely, if (A, \preceq) is a preordered set and $\Sigma \subset A$, then the smallest section of A containing Σ is

$$\widehat{\Sigma} = \bigcup_{s \in \Sigma} \{a \in A \mid a \preceq s\}.$$

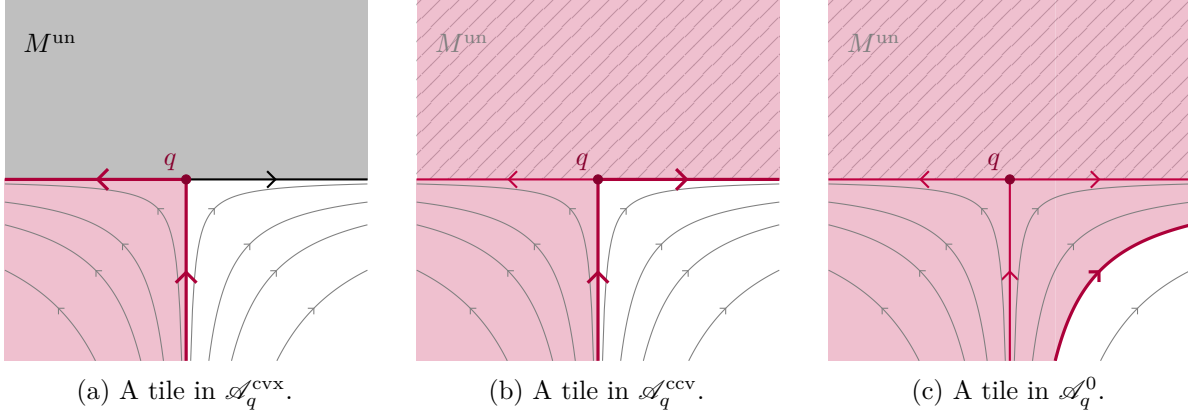

Figure 13: The three types of tiles in \mathcal{A}_q .

condition 5 of Definition 6.10 is satisfied.

Unfortunately, \widehat{f} might still fail to be well-cornered, as new slits can appear in the extension process. This situation arises exactly when \widetilde{f} has a slit corresponding to a stable branch of a singularity q which is connected to another singularity $q_- \in \Delta_{\text{sa}}$ in negative times, and one of the stable branches at q_- lies in M^{un} . In that case, filling the slit at q creates a slit at q_- corresponding to the other stable branch at q_- . Our admissibility conditions on X guarantee that the latter stable branch is not connected to another singularity of X . We can then apply the previous argument at these ‘secondary slits’ to further extend $(\widehat{f}, \widehat{\Sigma})$ to a pair $(\widehat{f}, \widehat{\Sigma})$, where \widehat{f} is now a *tile*. By construction, all the conditions of Definition 6.10 are satisfied, hence $(\widehat{f}, \widehat{\Sigma})$ is an upper enveloping tile starting at (p, Σ_0) .

□

We now define a natural preorder, the *extension preorder*, on $\mathcal{E}_p(\Sigma_0)$.

Definition 6.12. Let $F_\circ = (f : U \rightarrow M, \Sigma, a_0)$ be a pointed upper enveloping tile. An **extension** of F is a pointed upper enveloping tile $G_\circ = (g : V \rightarrow M, \Sigma', b_0)$ together with an embedding $\varphi : U \rightarrow V$ satisfying

- $g \circ \varphi = f$,
- $\Sigma' \circ \varphi = \Sigma$,
- $\varphi(a_0) = b_0$.

If φ is a diffeomorphism, we say that F_\circ and G_\circ are **equivalent**. Otherwise, we say that G_\circ is a **strict extension** of F_\circ . We call φ the **extension morphism**, and we write $\varphi : F_\circ \hookrightarrow G_\circ$, or simply $F_\circ \hookrightarrow G_\circ$.

If F and G are upper enveloping tiles without basepoints, we say that G is an **extension of F** (resp. F and G are **equivalent**) if there exist basepoints a_0 and b_0 for F and G , respectively, such that (G, b_0) is an extension of (F, a_0) (resp. (F, a_0) and (G, b_0) are equivalent).

Observe that the extension morphism φ is *unique*: if φ and ψ are two extension morphisms from F_\circ to G_\circ , then the set $\{a \in U \mid \varphi(a) = \psi(a)\}$ is nonempty and closed, and it is open since $g \circ \varphi = g \circ \psi$ and g is an immersion. This implies that if $\varphi : F_\circ \hookrightarrow G_\circ$ and $\psi : G_\circ \hookrightarrow F_\circ$, then ϕ and

ψ are diffeomorphism which are inverse of each other. In particular, F_\circ and G_\circ are equivalent. This shows that preorder \hookrightarrow on $\mathcal{E}_p(\Sigma_0)$ is a partial order up to equivalence.

We will be interested in the maximal elements for this preorder. By the following lemma, those are exactly the upper enveloping tiles without backward edges:

Lemma 6.13. *An upper enveloping tile admits a strict extension if and only if it has an edge with backward coorientation.*

Proof. Let $F = (f : U \rightarrow M, \Sigma)$ be an upper enveloping tile with a choice of initial basepoint $a_0 \in I_0$.

Let us first assume that $F_\circ = (F, a_0)$ admits a strict extension $\varphi : F_\circ \hookrightarrow G_\circ$, where $G_\circ = (g : V \rightarrow M, \Sigma', b_0)$. We identify U with the subset $\varphi(U) \subset V$. Since the extension is strict, the latter inclusion is strict. Let $x \in V \setminus U$, and γ be a forward curve from a_0 to x in V . Let $C_0 \subset [0, 1]$ be the connected component of $\gamma^{-1}(U)$ containing 0, and $t_0 := \sup C_0$. Since U is open in V , $x_0 := \gamma(t_0) \notin U$. Moreover, $x_0 \notin V^{\text{un}}$, since f and g are strongly unstable-complete, so $x_0 \in V^{\text{pure}}$. If ℓ denotes the pure X -line passing through x_0 , then ℓ corresponds to a backward (improper) edge of f .

We now assume that F has an improper backward edge corresponding to a flow line γ of X in M^{pure} . Let $p \in \gamma$. By condition 3 of Definition 6.10, Σ induces a section $\Sigma_p \subset \mathcal{A}_p$ in a natural way, by extending the one-dimensional envelope and its shadow at p . By Lemma 6.11, we consider an upper enveloping tile $H_\circ = (h : W \rightarrow M, \Sigma'', c_0)$ starting at (p, Σ_p) . We can then extend F across γ by attaching H to obtain an immersion $g : V \rightarrow M$ tangent to η together with a map $\Sigma' : V \rightarrow \mathcal{P}(\mathcal{A}_*)$ extending Σ and Σ'' . If γ is not connected to a singularity of X in positive or negative times, then one easily checks that (g, Σ') is an upper enveloping tile, and that it is a strict extension of F . In general, g might have *slits*. This happens precisely when γ is part of an improper *concave* corner of f , and/or γ is connected in negative times to a quadratic-like singularity $q \in Q^*$. The methods from Step 3 in the proof of Lemma 6.11 can be adapted to fill these slits (potentially in two steps for ‘double slits’) to obtain the desired extension of F . The (tedious yet straightforward) details are left to the reader. \square

The previous lemma motivates the following

Definition 6.14 (See [BI08], Definition 6.10). *A **forward envelope** is an upper enveloping tile such that all of its edges have forward coorientation.*

The construction of a forward envelope in our setup will be more delicate than in [BI08]. A crucial step is to show that the preorder \hookrightarrow on $\mathcal{E}_p(\Sigma_0)$ is *directed*.

Lemma 6.15. *Two pointed upper enveloping tiles F_\circ and G_\circ starting at (p, Σ_0) admit a common extension. More precisely, there exist a pointed upper enveloping tile H_\circ starting at (p, Σ_0) and two extension morphisms $\varphi : F_\circ \hookrightarrow H_\circ$ and $\psi : G_\circ \hookrightarrow H_\circ$.*

Proof. Let us write $F_\circ = (f : U \rightarrow M, \Sigma, a_0)$ and $G_\circ = (g : V \rightarrow M, \Sigma', b_0)$. We can first extend F_\circ and G_\circ so that both f and g are *T-complete*, in the following sense: if U contains a X -line mapped to a stable branch of a quadratic-like singularity, then U contains the corresponding unstable tile as well. This can be achieved by applying the strategy of Lemma 6.13 at the improper backward edges of f and g corresponding to such stable branches, and applying it a second time in the situations corresponding to double T -moves.

We denote by \mathcal{U} the collection of open subset $U' \subset U$ containing a_0 such that

- U' is *forward*, namely, for every point in $x \in U' \cap U^{\text{good}}$, there exists a forward curve from a_0 to x contained in U' ,

- There exists an embedding $\iota : U' \hookrightarrow V$ such that $\iota(a_0) = b_0$ and $g \circ \iota = f|_{U'}$.

The embedding ι is then uniquely determined as follows: if $\gamma : [0, 1] \rightarrow U$ is forward curve in U' from a_0 to x , then it lifts to g_* to a forward curve $\tilde{\gamma} = \iota \circ \gamma$ in V from b_0 to $\iota(x)$. Since such a lift is unique, any other embedding ι' as in the second item would satisfy $\iota'(x) = \iota(x)$.

We argue that \mathcal{U} is not empty. It is obvious if $p \in M^{\text{un}}$, since f and g are strongly unstable-complete. If $p \in M^{\text{pure}}$, it follows from condition 3 in Definition 6.10, since 1-dimensional upper envelopes are unique (see also [BI08, Corollary 6.4]). Moreover, Lemma 6.8 readily implies that \mathcal{U} is stable under taking unions. We then define

$$U_g := \bigcup_{U' \in \mathcal{U}} U',$$

with a corresponding embedding $\iota : U_g \rightarrow M$. Note that U_g is saturated by the flow of \tilde{X} and strongly unstable-complete. We make the following claim, which will be proved later.

Claim. *If γ is a forward curve in U from x_0 to x_1 , then*

1. *If $x_0 \in U_g$, then $x_1 \in U_g$ if and only if $\gamma \subset U_g$,*
2. *If $x_1 \in U_g$, then $x_0 \in U_g$ and $\gamma \subset U_g$.*

Specializing at $x_0 = a_0$, this claim together with the conditions in Definition 6.10 readily imply that f and g have the same shadow on U_g , in the sense that $\Sigma' \circ \iota = \Sigma|_{U_g}$.

We construct a common extension of F_\circ and G_\circ by gluing f and g along U_g via ι . More precisely, we define

$$W := (U \sqcup V) / \sim_\iota,$$

where $x \sim_\iota y$ if and only if $x \in U_g$, $y \in V$, and $y = \iota(x)$. We have natural injective maps $\varphi : U \hookrightarrow M$ and $\psi : V \hookrightarrow M$, together with a unique map $h : W \rightarrow M$ satisfying $h \circ \varphi = f$ and $h \circ \psi = g$. We extend Σ and Σ' to a map $\Sigma'' : W \rightarrow \mathcal{P}(\mathcal{A}_*)$ satisfying $\Sigma'' \circ \varphi = \Sigma$ and $\Sigma'' \circ \psi = \Sigma'$.

So far, W is only defined as a *topological space*. We will show that it has a natural structure of 2-manifold, possibly with boundary, such that φ and ψ are smooth, and h is a \mathcal{C}^1 immersion tangent to η . Note that W is simply connected by the Seifert–Van Kampen theorem.

We analyze how f and g overlap near a point $x \in \partial U_g \subset U$. We first assume that $x \in U^{\text{pure}}$, and we denote by ℓ the X -line passing through x . Let us consider a small neighborhood of O_q of $q := f(x)$ in M such that the connected component of $f^{-1}(O_q)$ containing x is diffeomorphic to an open disk. Denoting this connected component by U_x , we can further assume that $U_x \subset U^{\text{reg}}$. We will show that $U_x \cap U_g$ is the left open half-disk in U_x bounded by ℓ , and that the connected component of $g^{-1}(O_q)$ intersecting $V_x := \iota(U_x \cap U_g)$ is precisely V_x . In particular, g has an improper edge bounding the side of V_x corresponding to the flow line of X passing through q . Informally, g is entirely contained in f near x , and we can use f to define a chart for W near $\varphi(x)$.

To prove this, we consider two points $x_0, x_1 \in U_x$, where x_0 is to the left of ℓ and x_1 is to the right of ℓ , as well as a (strictly) forward curve γ from x_0 to x_1 contained in U_x . Since $x \in \partial U_g$, there must exist points along γ arbitrarily close to x belonging to U_g , and item 2 of the claim above implies that $x_0 \in U_g$. Moreover, if $x_1 \in U_g$, then by item 1 of the claim above, γ would be entirely contained in U_g , contradicting that $x \in \partial U_g \subset U \setminus U_g$. Therefore, we obtained that $x_0 \in U_g$ and $x_1 \notin U_g$. This implies the desired description for $U_x \cap U_g$, and the description of g easily follows.

We now assume that $x \in f^{-1}(\Delta)$. Then $f(x) \in \Delta_{\text{sa}} \cup Q$. With the above notations, the previous argument can be adapted to show that $U_x \cap U_g$ is an open quadrant or the interior of the union of two or three consecutive quadrants near x , and g is entirely contained in f near x . The case of two

opposite open forward quadrants can be ruled out by considering two forward curves in U_g starting at a_0 and ending in these two quadrants. These curves can be extended passed consecutive stable and unstable branches at x in order to obtain two forward curves from a_0 to a common $x' \in U$. None of the stable branches at x are in U^{un} , since otherwise U_g would contain two consecutive quadrants at x . Moreover, one of these stable branches is not connected to any other singularity, and we assume that it is the stable branch involved in the previous extension. Since our two forward curves are related by forward-homotopies and T -moves, and that the chosen stable branch cannot be involved in a T -move, it must intersect both forward curves. A contradiction quickly follows by analyzing which portions of the forward curves are contained in U_g . The other possible cases for the shape of U_g at x are easier to investigate, and the details are left to the reader.

We can define a collection of open subsets \mathcal{V} of V in the same manner as for U , and the corresponding maximal element V_f coincides with $\iota(U_g)$, with associated embedding $\iota^{-1} : \iota(U_g) \hookrightarrow V$. By symmetry, a similar description of the overlap between g and f holds near $\partial V_f \subset V$. Therefore, there exists a (unique) smooth structure on W making φ and ψ smooth and for which h is \mathcal{C}^1 .

From the above arguments, it is easy to check that h is an upper enveloping tile starting at (p, Σ_0) . If $c_0 := \varphi(a_0) = \psi(b_0)$, then $H_\circ := (h : W \rightarrow M, \Sigma'', c_0)$ is a common extension of F_\circ and G_\circ , via φ and ψ .

We finish the proof by showing the claim. We first make the following observation: if γ_0 and γ_1 are two forward curves in U with the same endpoints, then γ_0 is contained in U_g if and only if γ_1 is. Indeed, by Lemma 6.7, γ_0 and γ_1 differ by a finite sequence of T -moves and a forward isotopy. Since the latter preserves the set of pure X -lines and unstable components intersected by a forward curve, we can reduce to the case where γ_0 and γ_1 differ by a full T -move. Then, the desired equivalence easily follows from the conditions in Definition 6.10 and the fact that f and g are T -complete and without slits.

Now, with the notations from the claim, we first assume that $x_0 \in U_g$ and we denote by γ_0 a forward curve in U_g from a_0 to x_0 . The concatenation $\tilde{\gamma}_1 := \gamma_0 * \gamma$ is then a forward curve from a_0 to x_1 . If $\gamma \subset U_g$, then γ lifts to $(g, \iota(x_0))$, and $\tilde{\gamma}_1$ lifts to $g_\star = (g, b_0)$. In that case, by conditions 0, 1 and 3 of Definition 6.10, there exists a neighborhood U' of γ which is an element of \mathcal{U} , hence $\gamma \subset U_g$. We now assume that $x_1 \in U_g$, and we show that $\gamma \subset U_g$, hence $x_0 \in U_g$ as well. Let γ_1 be a forward curve in U_g from a_0 to x_1 , and γ_0 be a forward curve in U from a_0 to x_0 . We still write $\tilde{\gamma}_1 = \gamma_0 * \gamma$. Since γ_1 and $\tilde{\gamma}_1$ are two forward curves from a_0 to x_1 and $\gamma_1 \subset U_g$, the previous paragraph implies that $\tilde{\gamma}_1 \subset U_g$, hence $\gamma \subset U_g$ as desired. \square

We can now prove the main result of this section:

Proposition 6.16 (See [BI08], Lemma 6.11). *There exists a forward envelope starting at (p, Σ) . It is unique up to equivalence.*

Proof. By the previous observations and lemmas, it suffices to show that $\mathcal{E}_p(\Sigma_0)$ admits a maximal element with respect to the extension preorder. Indeed, a maximal element is a forward envelope starting at (p, Σ_0) , and it is unique up to equivalence since the preorder is directed. In particular, it is a greatest element.

We consider the disjoint union

$$\underline{U} := \bigsqcup_{\substack{F_\circ \in \mathcal{E}_p(\Sigma_0), \\ f: U \rightarrow M}} U,$$

which ranges over all the pointed upper enveloping surfaces $F_\circ = (f : U \rightarrow M, \Sigma, a_0)$ starting at (p, Σ_0) . We denote the component corresponding to F_\circ by U_{F_\circ} . To avoid set-theoretic issues, we

can restrict to the ones with $U \subset \mathbb{R}^2$. By definition, every tile is equivalent to one whose domain is a subset of \mathbb{R}^2 .

There is a natural map $\underline{f} : \underline{U} \rightarrow M$ whose restriction on the component corresponding to $F_\circ = (f : U \rightarrow M, \Sigma, a_0)$ is f . We define an equivalence relation \equiv on \underline{U} as follows: if $a \in U_{F_\circ}$ and $b \in U_{G_\circ}$, then $a \equiv b$ if and only if there exists a common extension H_\circ of F_\circ and G_\circ with extension morphisms $\varphi : F_\circ \hookrightarrow H_\circ$ and $\psi : G_\circ \hookrightarrow H_\circ$ such that $\varphi(a) = \psi(b)$. By the existence of common extensions and the uniqueness of extension morphisms, it is easy to check that \equiv is a well-defined equivalence relation on \underline{U} . Moreover, if $a \equiv b$ then $\underline{f}(a) = \underline{f}(b)$. Therefore, \underline{f} induces a map

$$f^\infty : U^\infty \rightarrow M, \quad U^\infty := \underline{U} / \equiv .$$

Here, we endow U^∞ with the quotient topology.

We now show that U^∞ is a 2-dimensional manifold, possibly with boundary. By definition, U^∞ admits a smooth atlas for which f^∞ is a \mathcal{C}^1 immersion tangent to η , and U^∞ is saturated by the flow of X . Note that U^∞ has a distinguished base point a_0^∞ corresponding to the class of the initial base point of any element in $\mathcal{E}_p(\Sigma_0)$, and every point in U^∞ can be connected to a_0^∞ by a continuous path. Moreover, for every $F_\circ = (f : U \rightarrow M, \Sigma, a_0) \in \mathcal{E}_p(\Sigma_0)$, there is a natural smooth embedding $q_{F_\circ} : U \hookrightarrow U^\infty$ satisfying $f^\infty \circ q_{F_\circ} = f$. Lemma 6.15 easily implies that U^∞ is Hausdorff and satisfies the following property : for every compact $K \subset U^\infty$, there exists $F_\circ \in \mathcal{E}_p(\Sigma_0)$ and a compact $K' \subset U$ such that $K = q_{F_\circ}(K')$. One deduces that U^∞ is simply connected and aspherical, since every U_{F_\circ} is. Observe that if $p \in M^{\text{un}}$ then U^∞ has no boundary. Otherwise, U^∞ has a unique boundary component and it contains a_0^∞ . Furthermore, U^∞ admits a (continuous) Riemannian metric (by either pulling back the Riemannian metric \mathbf{g} on M along f^∞ , or patching together the intrinsic Riemannian metrics on the U_{F_\circ} 's). Since it is Hausdorff, it is metrizable and since it is connected, it is second-countable; see [Spi99, Appendix A, Theorem 1].²² Therefore, we have shown that U^∞ is a smooth surface, possibly with boundary, which embeds in to \mathbb{R}^2 .

The η -surface $f^\infty : U^\infty \rightarrow M$ is obviously strongly unstable-complete. One easily checks that it is well-cornered, using that every path $\gamma : [0, 1] \rightarrow U^\infty$ admits a lift $\tilde{\gamma} : [0, 1] \rightarrow U_{F_\circ}$ for some $F_\circ \in \mathcal{E}_p(\Sigma_0)$, i.e., it satisfies $q_{F_\circ} \circ \tilde{\gamma} = \gamma$. Therefore, f^∞ is a tile.

The collection of shadows of elements $F_\circ \in \mathcal{E}_p(\Sigma_0)$ naturally induces a shadow Σ^∞ for f^∞ . It is uniquely characterized by the following property : for every $F_\circ \in \mathcal{E}_p(\Sigma_0)$, $\Sigma^\infty \circ q_{F_\circ} = \Sigma$, where Σ denotes the shadow of F_\circ . It is straightforward to check that $(f^\infty, \Sigma^\infty)$ is an upper enveloping tile, using that any path in U^∞ can be lifted to a path in some U_{F_\circ} . Therefore, $F_\circ^\infty := (f^\infty, \Sigma^\infty, a_0^\infty)$ is an element of $\mathcal{E}_p(\Sigma_0)$. By construction, F_\circ^∞ is an extension of every $F_\circ \in \mathcal{E}_p(\Sigma_0)$, which means that it is a greatest element for the extension order. \square

7 Extending the order

Let \mathcal{U} denote the collection of forward envelopes starting at the pairs (p, Σ_0) where

- $p \in M^{\text{good}}$, and p **does not belong to the pure stable branch of a quadratic-like singularity**,²³
- $\Sigma_0 \subset \mathcal{A}_p$ is any section.

²²We are grateful to Ryan Unger for pointing out this reference to us.

²³This condition is not strictly necessary, but it will greatly simplify the construction of the preorder on \mathcal{U} by drastically reducing the number of cases to consider in several proofs.

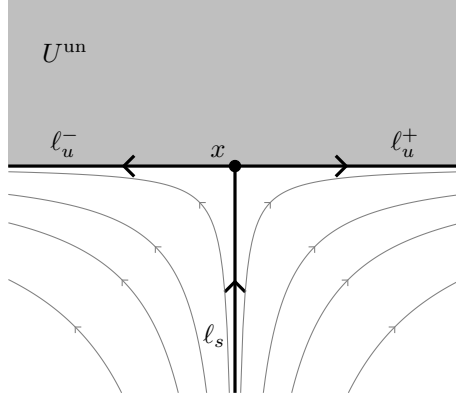

Figure 14: A special triple.

To avoid set-theoretic issues, we can restrict our attention to the forward envelopes whose domains are subsets of \mathbb{R}^2 , which is always the case up to equivalence.

We will extend the results of [BI08, Section 6.2] to our setup. More precisely, we will define a preorder \preceq on \mathcal{U}_* making (\mathcal{U}, \preceq) a weak prefoliation. This preorder has to satisfy the following checklist:

- It is compatible with the geometric order and coherent along intersections,
- It extends to the set of *completed* forward envelopes $\overline{\mathcal{U}}$,
- Every marked tile in \mathcal{A}_* with marking on an edge has an *upper neighbor* (see [BI08, Definition 4.10] and Section 8.2.2 below) in $\overline{\mathcal{U}}$.

Unfortunately, these requirements are not enough to entirely specify \preceq and make it a total relation. We will adapt the methods of [BI08] and define \preceq by successive ‘layers’, depending on how the forward envelopes intersect. This will crucially rely on the *forward structure* with respect to X on forward envelopes, which essentially allows us to reduce the construction to a 1-dimensional problem. However, this forward structure is more complicated in our setup because of the presence of singularities.

7.1 Forward order on pure X -lines

Let $f : U \rightarrow M$ be a tile.

Definition 7.1. We denote by $\mathcal{L} = \mathcal{L}_f$ the set of pure X -lines of f (see Definition 6.3). We define a (strict) preorder \triangleleft on \mathcal{L} as follows: if $\ell_0, \ell_1 \in \mathcal{L}$, then $\ell_0 \triangleleft \ell_1$ if and only if there exists a forward curve from ℓ_0 to ℓ_1 . We denote by \trianglelefteq the corresponding (nonstrict) preorder.

Lemma 6.5 immediately implies that \trianglelefteq is a *partial order*. We call it the **forward order** on \mathcal{L} . Recall that two forward-homotopic curves intersect the same X -lines in \mathcal{L} . If they differ by a T -move across a singularity $x \in U$, the sets of X -lines in \mathcal{L} that they intersect differ as follows. One intersects the stable branch $\ell_s \in \mathcal{L}$ of x but not its unstable branches $\ell_u^-, \ell_u^+ \in \mathcal{L}$, and the other intersects ℓ_u^- and ℓ_u^+ but not ℓ_s . Otherwise, they intersect the same X -lines in $\mathcal{L} \setminus \{\ell_s, \ell_u^-, \ell_u^+\}$. Here, we chose our notations so that $\ell_u^- \triangleleft \ell_u^+$, see Figure 14. We call $(\ell_s, \ell_u^-, \ell_u^+)$ a **special triple** in \mathcal{L} . The next lemma is an easy consequence of Lemma 6.5. The proof is left to the reader.

Lemma 7.2. We have the following properties:

1. ℓ_s and ℓ_u^\pm are not comparable with respect to \triangleleft .
2. If $\ell \in \mathcal{L}$, then

$$\begin{aligned} \ell_s \triangleleft \ell &\iff \ell_u^+ \triangleleft \ell, \\ \ell \triangleleft \ell_s &\iff \ell \triangleleft \ell_u^-, \\ \ell_u^- \trianglelefteq \ell \trianglelefteq \ell_u^+ &\iff \ell \in \{\ell_u^-, \ell_u^+\}. \end{aligned}$$

Notice that if f is the underlying tile of a forward envelope with a (necessarily unique and forward) proper edge, then this edge corresponds to *the smallest* element of $(\mathcal{L}, \triangleleft)$. If f has no edge and has an initial unstable component U_0 , then the minimal elements of $(\mathcal{L}, \trianglelefteq)$ are exactly the X -lines in $\partial U_0 \subset U$ with backward coorientation with respect to U_0 .

7.2 Backward domains of overlap

In this section, we adapt the definitions from [BI08, Section 6.2.1]. Our goal is to precisely describe how marked forward envelopes overlap in the backward region determined by the marked point. This will be crucial in the definition of the preorder on forward envelopes in the next section. As in [BI08, Section 6.2], this preorder will depend on how two marked forward envelopes overlap in this backward region.

7.2.1 Backward domain of an envelope

We fix a point $p \in M^{\text{good}}$ together with a marked forward envelope $f_\star = (f : U \rightarrow M, a) \in \mathcal{U}_p$, which implicitly comes with the additional data of a shadow Σ and an initial locus I_0 .

We denote by $\mathcal{I}_{f_\star} \subset \mathcal{L}_f$ the set of all X -lines in \mathcal{L}_f intersected by the *backward* curves starting at a , or alternatively, by the forward curves from I_0 to a . If f is of pure type and a lies on the initial edge e_0 of f , we set $\mathcal{I}_{f_\star} := \{e_0\}$ instead. This set is well-defined by the second item of Definition 6.10. It is empty exactly when f is of unstable type and $a_0 \in I_0 = U_0$.

Because of the presence of unstable components and special triples in \mathcal{I}_{f_\star} , this set is not necessarily an interval for the preorder \trianglelefteq , unlike in [BI08]. To remedy this, we define an equivalence relation \sim_T on \mathcal{I}_{f_\star} . We first define a homogeneous relation \sim_T^{pre} as follows: if $\ell_0, \ell_1 \in \mathcal{I}_{f_\star}$, then $\ell_0 \sim_T^{\text{pre}} \ell_1$ if and only if $\ell_0 = \ell_1$, or ℓ_0 and ℓ_1 belong to the same special triple. We then define \sim_T as the transitive closure of \sim_T^{pre} . Notice that a X -line ℓ belongs to at most two distinct special triples, in which case ℓ coincides with the positive or negative unstable branch of one and with the stable branch of the other. The **reduction** of \mathcal{I}_{f_\star} is defined by

$$\mathcal{I}_{f_\star}^{\text{red}} := \mathcal{I}_{f_\star} / \sim_T.$$

By Lemma 7.2, the partial order \trianglelefteq naturally induces a partial order $\trianglelefteq^{\text{red}}$ on $\mathcal{I}_{f_\star}^{\text{red}}$, and we have:

Lemma 7.3. *The poset $(\mathcal{I}_{f_\star}^{\text{red}}, \trianglelefteq^{\text{red}})$ embeds into $([0, 1], \leq)$ as a closed subset.*

Proof. Let $\gamma : [0, 1] \rightarrow U$ be a forward curve from I_0 to a , and let $C := \gamma^{-1}(U^{\text{pure}})$. Then C is a closed subset of $[0, 1]$ in bijection with the set of pure X -lines intersected by γ . Let $\lambda : C \hookrightarrow \mathcal{I}_{f_\star}$ be the increasing map sending $t \in C$ to the X -line passing through $\gamma(t)$. It induces a nondecreasing map $\lambda^{\text{red}} : C \rightarrow \mathcal{I}_{f_\star}^{\text{red}}$ which is surjective by Lemma 6.7. We define an equivalence relation \sim on C as follows: if $t, t' \in C$, then $t \sim t'$ if and only if $\lambda^{\text{red}}(t) = \lambda^{\text{red}}(t')$. One easily checks that if $t < t'$ and $t \sim t'$, then $\{t, t'\} \subset \partial C$ and $(t, t') \cap C$ is either empty or a single point, depending on whether

$\lambda(t)$ and $\lambda(t')$ are negative and positive branches of a special triple or of a double special triple, respectively. The order \leq induces an order \leq^{red} on the quotient $C^{\text{red}} := C / \sim$. Since λ^{red} induces an isomorphism between $(C^{\text{red}}, \leq^{\text{red}})$ and $(\mathcal{I}_{f_\star}^{\text{red}}, \leq^{\text{red}})$, it is enough to show that $(C^{\text{red}}, \leq^{\text{red}})$ embeds into $([0, 1], \leq)$ as a closed subset.

Let \mathcal{U} be the collection of connected components of $[0, 1] \setminus C$ of the form (t, t') with $t \sim t'$. We consider the closed set

$$\widehat{C} := [0, 1] \setminus \bigcup_{U \in \mathcal{U}} U \subset [0, 1].$$

Notice that $C \subset \widehat{C}$ is closed, and \sim extends to \widehat{C} so that \leq^{red} extends to a total order on the quotient $\widehat{C}^{\text{red}} := \widehat{C} / \sim$, and the induced map $C^{\text{red}} \rightarrow \widehat{C}^{\text{red}}$ is (strictly) order preserving. Moreover, the image of the latter map is closed for the order topology. We can loosely think of quotienting \widehat{C} by \sim as ‘collapsing the gaps’ between the connected components of \widehat{C} . Recall the following characterization due to Cantor (see [Jec03, Theorem 4.3] for the unbounded case): every totally ordered set which is bounded, dense, separable, and complete is either a singleton or isomorphic to $([0, 1], \leq)$. It is straightforward to check that $(\widehat{C}^{\text{red}}, \leq^{\text{red}})$ satisfies these properties, hence embeds into $([0, 1], \leq)$ as a closed subset. The composition $C^{\text{red}} \rightarrow \widehat{C}^{\text{red}} \rightarrow [0, 1]$ yields the desired embedding. \square

A priori, the embedding of Lemma 7.3 depends on the choice of forward curve. However, one can easily show that a different forward curve induces the same embedding up to post-composition with an increasing homeomorphism of $[0, 1]$. Alternatively, one can appeal to the following elementary fact: if a poset (I, \preceq) embeds into $([0, 1], \leq)$ as a closed subset, then this embedding is continuous for the order topology, and it is unique up to post-composition with an increasing homeomorphism of $[0, 1]$.²⁴

We now fix an embedding as in the previous lemma, and we define $I_{f_\star} \subset [0, 1]$ to be the image of $\mathcal{I}_{f_\star}^{\text{red}}$ under this embedding. We denote by \mathcal{D}_{f_\star} the domain in U defined as the union of all of the X -lines in \mathcal{I}_{f_\star} , together with all of the unstable components of f crossed by the forward curves from I_0 to a . We call \mathcal{D}_{f_\star} the **backward domain** of f_\star .²⁵

7.2.2 Overlap of two envelopes

Let us consider a second marked forward envelope $g_\star = (g : V \rightarrow M, b) \in \mathcal{U}_p$ with corresponding poset $\mathcal{I}_{g_\star} \subset \mathcal{L}_g$ and backward domain $\mathcal{D}_{g_\star} \subset V$. If $\gamma : [0, 1] \rightarrow U$ is a *backward* curve starting from a , a **lift** of γ to g_\star is a curve $\tilde{\gamma} : [0, 1] \rightarrow V$ starting from b satisfying $f \circ \gamma = g \circ \tilde{\gamma}$. If it exists, such a lift is unique and is a backward curve in V . We define $\mathcal{I}_{f_\star \cap g_\star} \subset \mathcal{I}_{f_\star}$ to be the set of all X -lines in \mathcal{L}_{f_\star} intersected by some backward curve starting at a which lifts to g_\star . If g is of pure type and b belongs to the initial edge e'_0 of g , we set $\mathcal{I} := \{e'_0\}$ instead. We define the **backward domain of overlap** $\mathcal{D}_{f_\star \cap g_\star} \subset \mathcal{D}_{f_\star}$ to be the union of all of the X -lines in $\mathcal{I}_{f_\star \cap g_\star}$ together with all of the unstable components of f crossed by the aforementioned backward curves lifting to g_\star . Notice that $\mathcal{I}_{f_\star \cap g_\star}$ is an *upward section* of \mathcal{I}_{f_\star} , in the following sense: for all $\ell_0 \in \mathcal{I}_{f_\star \cap g_\star}$ and $\ell_1 \in \mathcal{I}_{f_\star}$, if $\ell_0 \preceq \ell_1$ then $\ell_1 \in \mathcal{I}_{f_\star \cap g_\star}$. The same is true for the reduction

$$\mathcal{I}_{f_\star \cap g_\star}^{\text{red}} := \mathcal{I}_{f_\star \cap g_\star} / \sim_T, \quad \mathcal{I}_{f_\star \cap g_\star}^{\text{red}} \subset \mathcal{I}_{f_\star}^{\text{red}}.$$

²⁴If $\iota : I \rightarrow [0, 1]$ is such an embedding with closed image C , then ι is open so $\iota^{-1} : C \rightarrow I$ is continuous. Since C is compact and the order topology on I is Hausdorff, ι^{-1} is a homeomorphism, hence ι is continuous. If $\iota' : I \rightarrow [0, 1]$ is another embedding with closed image C' , we simply extend $\iota' \circ \iota^{-1} : C \rightarrow [0, 1]$ to an increasing homeomorphism $\phi : [0, 1] \rightarrow [0, 1]$ such that ϕ is affine on the connected components of $[0, 1] \setminus C$, and $\iota' = \phi \circ \iota$.

²⁵Beware: this domain has a more complicated topology than the domain D_X from [BI08, Section 6.2.1]. Because of the way we defined it, \mathcal{D}_{f_\star} might not be simply connected as it can have punctures. This is not gonna be relevant for our arguments, and these missing points can be added for psychological comfort.

Let $I_{f_* \cap g_*} \subset I_{f_*}$ denote the image of $\mathcal{I}_{f_*}^{\text{red}}$ under the chosen embedding from Lemma 7.3. Notice that $I_{f_* \cap g_*}$ can be empty, for instance if g is of unstable type and b belongs to the initial unstable component of g . We refer to the situation $I_{f_* \cap g_*} = \emptyset$ as case (I0). Otherwise, if $I_{f_* \cap g_*} \neq \emptyset$, we define

$$m := \inf I_{f_* \cap g_*} \in I_{f_*},$$

and we distinguish several cases:

- (I1) $m \in I_{f_* \cap g_*}$, and $I_{f_* \cap g_*} = [m, 1] \cap I_{f_*}$. Then $\mathcal{I}_{f_* \cap g_*}$ is of one of the following three types:
- (i) $\mathcal{I}_{f_* \cap g_*} = \{\ell \in \mathcal{I}_{f_*} \mid \ell_m \trianglelefteq \ell\}$, where $\ell_m \in \mathcal{I}_{f_*}$. Here, ℓ_m is the least element of $\mathcal{I}_{f_* \cap g_*}$. If ℓ_m is the negative unstable branch of a special triple in \mathcal{I}_{f_*} , then it corresponds to the initial edge of g_* .²⁶
 - (ii) $\mathcal{I}_{f_* \cap g_*} = \{\ell_s\} \cup \{\ell \in \mathcal{I}_{f_*} \mid \ell_u^- \trianglelefteq \ell\}$, where $(\ell_s, \ell_u^-, \ell_u^+)$ is a special triple in \mathcal{I}_{f_*} . Here, ℓ_s and ℓ_u^- are the two minimal elements of $\mathcal{I}_{f_* \cap g_*}$.
 - (iii) $\mathcal{I}_{f_* \cap g_*} = \{\ell_s, \ell'_s\} \cup \{\ell \in \mathcal{I}_{f_*} \mid \ell_u'^- \trianglelefteq \ell\}$, where $(\ell_s, \ell_u^-, \ell_u^+)$ and $(\ell'_s, \ell_u'^-, \ell_u'^+)$ are a special triples in \mathcal{I}_{f_*} with $\ell'_s = \ell_u^-$. Here, ℓ_s, ℓ'_s and $\ell_u'^-$ are the three minimal elements of $\mathcal{I}_{f_* \cap g_*}$.

In these three cases, the minima of \mathcal{I}_{f_*} might be forward edges of an unstable component of U contained in $\mathcal{D}_{f_* \cap g_*}$, except in case (i) if ℓ_m corresponds to the initial edge of g_* .

- (I2) $m \notin I_{f_* \cap g_*}$, and $I_{f_* \cap g_*} = (m, 1] \cap I_{f_*}$. In that case, there exists a (possibly non unique) $\ell_m \in \mathcal{I}_{f_*}$ such that $\mathcal{I}_{f_* \cap g_*} = \{\ell \in \mathcal{I}_{f_*} \mid \ell_m \triangleleft \ell\}$. We can further distinguish three cases:
- (i) ℓ_m does not belong to a special triple in \mathcal{I}_{f_*} , and ℓ_m is the infimum of $\mathcal{I}_{f_* \cap g_*}$ in \mathcal{I}_{f_*} ,
 - (ii) There exists a special triple $(\ell_s, \ell_u^-, \ell_u^+)$ such that ℓ_u^+ is not the stable branch of another special triple, and $\ell_m \in \{\ell_s, \ell_u^+\}$. In that case, $\mathcal{I}_{f_* \cap g_*}$ has exactly two maximal lower bounds in \mathcal{I}_{f_*} , namely ℓ_s and ℓ_u^+ .
 - (iii) There exists a special triple $(\ell_s, \ell_u^-, \ell_u^+)$ such that ℓ_u^+ is the stable branch of another special triple $(\ell'_s, \ell_u'^-, \ell_u'^+)$, and $\ell_m \in \{\ell_s, \ell'_s, \ell_u^+\}$. In that case, $\mathcal{I}_{f_* \cap g_*}$ has exactly three maximal lower bounds in \mathcal{I}_{f_*} , namely ℓ_s, ℓ'_s , and ℓ_u^+ .

Notice that the case $\mathcal{I}_{f_* \cap g_*} = \{\ell_s\} \cup \{\ell \in \mathcal{I}_{f_*} \mid \ell_u^+ \trianglelefteq \ell\}$, where $(\ell_s, \ell_u^-, \ell_u^+)$ is a special triple with $\ell_s, \ell_u^+ \in \mathcal{I}_{f_*}$, cannot occur. Indeed, if both ℓ_s and ℓ_u^+ are in $\mathcal{I}_{f_* \cap g_*}$, then the unstable locus in U corresponding to this special triple is in $\mathcal{D}_{f_* \cap g_*}$, since forward envelopes have at most one proper edge,²⁷ and it follows that ℓ_u^- is also in $\mathcal{I}_{f_* \cap g_*}$. Other cases can be ruled out by similar arguments. This discussion implies:

Lemma 7.4. *Exactly one of the following holds:*

- (I0) $\mathcal{I}_{f_* \cap g_*} = \emptyset$.
- (I1) $\mathcal{I}_{f_* \cap g_*}$ has one, two, or three minimal elements.
- (I2) $\mathcal{I}_{f_* \cap g_*}$ has no minimal element but has one, two, or three maximal lower bounds in \mathcal{I}_{f_*} .

Moreover, a unique minimal element of $\mathcal{I}_{f_* \cap g_*}$ is a least element, and a unique maximal lower bound of $\mathcal{I}_{f_* \cap g_*}$ in \mathcal{I}_{f_*} is an infimum.

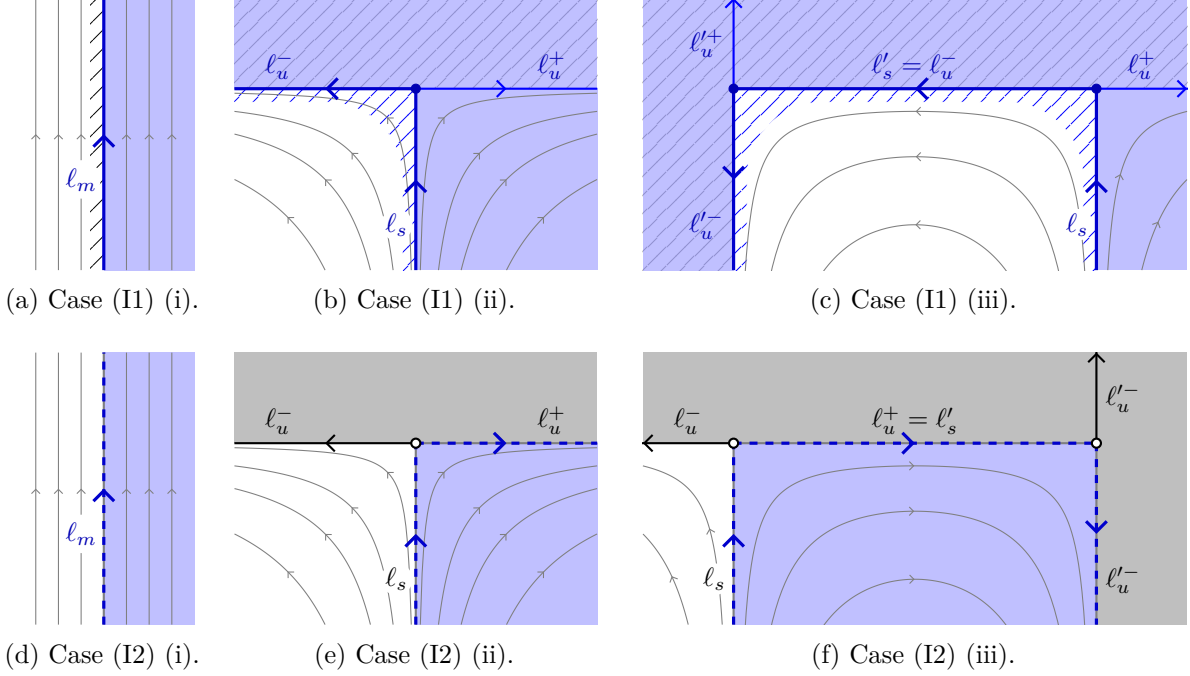

Figure 15: Double overlaps. In each picture, the whole rectangle corresponds to \mathcal{D}_{f_*} , and the blue region corresponds to $\mathcal{D}_{f_* \cap g_*}$. The blue hatched regions are possible unstable regions contained in \mathcal{D}_{f_*} . Thick blue lines belong to \mathcal{D}_{f_*} , while dashed blue lines do not. The gray regions are unstable regions in \mathcal{D}_{f_*} .

Figure 15 summarizes all the possibilities for these cases, as well as the corresponding domains $\mathcal{D}_{f_* \cap g_*}$.

There is a natural (strictly) order preserving map $\alpha_{f_* \cap g_*} : \mathcal{I}_{f_* \cap g_*} \rightarrow \mathcal{I}_{g_*}$ defined as follows. If $p \in M^{\text{pure}}$ and ℓ is the X -line in U passing through a , we define $\alpha_{f_* \cap g_*}(\ell)$ as the X -line in V passing through b . Otherwise, if $\ell \in \mathcal{I}_{f_* \cap g_*}$ and $\gamma : [0, 1] \rightarrow U$ is a forward curve from ℓ to a which admits a lift $\tilde{\gamma} : [0, 1] \rightarrow V$ to g with $\tilde{\gamma}(1) = b$, then $\alpha_{f_* \cap g_*}(\ell)$ is the X -line in V passing through $\tilde{\gamma}(0)$. By Lemma 6.8, this definition does not depend on the choice of the forward curve γ . By construction, $\alpha_{f_* \cap g_*}$ is strictly order preserving.

There is also a natural map $\varphi_{f_* \cap g_*} : \mathcal{D}_{f_* \cap g_*} \rightarrow \mathcal{D}_{g_*}$ satisfying

$$g \circ \varphi_{f_* \cap g_*} = f|_{\mathcal{D}_{f_* \cap g_*}}, \quad (7.1)$$

defined as follows. If $p \in M^{\text{pure}}$ and $x \in \mathcal{D}_{f_* \cap g_*}$ belongs to the X -line passing through a , then there exists a unique $t \in \mathbb{R}$ such that $x = \phi_{f_* X}^t(a)$ and $\varphi_{f_* \cap g_*}(x) := \phi_{g_* X}^t(b)$. Otherwise, if $x \in \mathcal{D}_{f_* \cap g_*}$ and $\gamma : [0, 1] \rightarrow U$ is a forward curve from x to a and $\tilde{\gamma} : [0, 1] \rightarrow V$ is a lift of γ to g ending at b , then we define $\varphi_{f_* \cap g_*}(x) := \tilde{\gamma}(0)$. Lemma 6.8 readily implies that $\varphi_{f_* \cap g_*}$ is well-defined and independent of the choice of γ . It satisfies the equality (7.1) by construction.

Exchanging g_* and f_* , we similarly obtain a poset $\mathcal{I}_{g_* \cap f_*} \subset \mathcal{I}_{g_*}$ and a domain $\mathcal{D}_{g_* \cap f_*} \subset \mathcal{D}_{g_*}$, as well as maps $\alpha_{g_* \cap f_*} : \mathcal{I}_{g_* \cap f_*} \rightarrow \mathcal{I}_{g_*}$ and $\varphi_{g_* \cap f_*} : \mathcal{D}_{g_* \cap f_*} \rightarrow \mathcal{D}_{g_*}$. By definition, the image of $\varphi_{f_* \cap g_*}$ is contained in $\mathcal{D}_{g_* \cap f_*}$, and $\varphi_{g_* \cap f_*} \circ \varphi_{f_* \cap g_*} = \text{id}_{\mathcal{D}_{f_* \cap g_*}}$. Similarly, $\varphi_{f_* \cap g_*} \circ \varphi_{g_* \cap f_*} = \text{id}_{\mathcal{D}_{g_* \cap f_*}}$, hence

²⁶Recall that we exclude the case where ℓ_m is the stable branch of a quadratic-like singularity and corresponds to the initial edge of g_* .

²⁷We also implicitly use the unique integrability properties of η established in the proof of Lemma 6.1.

$\varphi_{f_\star \cap g_\star}$ is a diffeomorphism between $\mathcal{D}_{f_\star \cap g_\star}$ and $\mathcal{D}_{g_\star \cap f_\star}$. Likewise, $\alpha_{f_\star \cap g_\star}$ induces an order preserving bijection between $\mathcal{I}_{f_\star \cap g_\star}$ and $\mathcal{I}_{g_\star \cap f_\star}$ whose inverse is given by $\alpha_{g_\star \cap f_\star}$.

Notice that if $\mathcal{I}_{f_\star \cap g_\star} = \emptyset$, then $p \in M^{\text{un}}$ and $U_c = \mathcal{D}_{f_\star \cap g_\star} \subset U$ is an unstable component of f . Similarly, if $\mathcal{I}_{f_\star \cap g_\star}$ has a least element ℓ_m which is not a forward boundary component of $\mathcal{D}_{f_\star \cap g_\star}$ in \mathcal{D}_{f_\star} , then there exists an unstable component $U_c \subset \mathcal{D}_{f_\star \cap g_\star}$ such that ℓ_m is a backward boundary component of U_c . In both cases, we say that U_c is the **initial unstable component of overlap** of f_\star and g_\star .

7.2.3 Initial corners

Let $q \in \Delta_{\text{sa}} \cup Q$. Recall that q is a **pure** saddle singularity if no stable branch of X at q is in M^{pure} , and q is a **quadratic-like** singularity if exactly one stable branch of X at q is contained in M^{pure} . The set of pure saddle singularities of X is denoted by $\Delta_{\text{sa}}^{\text{pure}}$, and the set of quadratic-like singularities of X is denoted by Q^* .

If $q \in \Delta_{\text{sa}}^{\text{pure}} \cup Q^*$, a **corner at q** is a pair $c = (\gamma_s, \gamma_u)$, where γ_s and γ_u are a stable and unstable branches of X at q , respectively, both contained in M^{pure} . We denote by \mathfrak{C}_q the set of corners at q , and \mathfrak{C} the set of all corners. Note that \mathfrak{C}_q has four elements if $q \in \Delta_{\text{sa}}^{\text{pure}}$, and two elements if $q \in Q^*$.

A corner $c = (\gamma_s, \gamma_u) \in \mathfrak{C}$ is **forward** (resp. **backward**) if γ_u lies to the right (resp. to the left) of γ_s . To make sense of this orientation, we consider the (unit) vector $v_s, v_u \in \eta(q)$ defined as

$$v_s := \lim_{t \rightarrow +\infty} \frac{\hat{\gamma}_s(t)}{|\dot{\gamma}_s(t)|}, \quad v_u := \lim_{t \rightarrow -\infty} \frac{\hat{\gamma}_u(t)}{|\dot{\gamma}_u(t)|}.$$

If (v_s, v_u) is positively (resp. negatively) oriented, with respect to the orientation on $\eta(q)$, then γ_u is to the left (resp. to the right) of γ_s . We denote by $\mathfrak{C}_q^+ \subset \mathfrak{C}_q$ the set of forward corners at q , by $\mathfrak{C}^+ \subset \mathfrak{C}$ the set of all corners. Note that \mathfrak{C}_q^+ has two elements if $q \in \Delta_{\text{sa}}^{\text{pure}}$, and one element if $q \in Q^*$. Moreover, there is a canonical ‘projection’ map

$$\mathfrak{p} : \mathfrak{C}^+ \rightarrow \Delta_{\text{sa}}^{\text{pure}} \cup Q^*.$$

We now refine case (I2) above in the description of the backward overlap of f_\star and g_\star . We assume that $\mathcal{I}_{f_\star \cap g_\star}$ (hence $\mathcal{I}_{g_\star \cap f_\star}$) satisfies case (I2) of Lemma 7.4. We say that a corner $c \in \mathfrak{C}^+$ is the **initial (forward) corner of overlap** of f_\star and g_\star if, after possibly switching f_\star and g_\star , there exists a maximal lower bounds $\ell_s \in \mathcal{I}_{f_\star}$ of $\mathcal{I}_{f_\star \cap g_\star}$ and a maximal lower bound $\ell_u \in \mathcal{I}_{g_\star}$ of $\mathcal{I}_{g_\star \cap f_\star}$ such that $c = (f \circ \ell_s, g \circ \ell_u)$. A more subtle situation can occur. If $c = (\gamma_s, \gamma_u) \in \mathfrak{C}_q^+$ and $c' = (\gamma'_s, \gamma'_u) \in \mathfrak{C}_{q'}^+$ are two forward corners such that $\gamma_u = \gamma'_s =: \gamma_0$, in which case q and q' are saddle singularities connected by γ_u , we say that (c, c') is the **initial (forward) double corner of overlap** of f_\star and g_\star if, after possibly switching f_\star and g_\star , $\mathcal{I}_{f_\star \cap g_\star} \subset \mathcal{I}_{f_\star}$ has an infimum ℓ_s , $\mathcal{I}_{g_\star \cap f_\star} \subset \mathcal{I}_{g_\star}$ has an infimum ℓ'_u , and $\gamma_s = f \circ \ell_s$ and $\gamma'_u = g \circ \ell'_u$. Then, after possibly switching f_\star and g_\star , one of the following cases holds:

- (C1) Both $\mathcal{I}_{f_\star \cap g_\star} \subset \mathcal{I}_{f_\star}$ and $\mathcal{I}_{g_\star \cap f_\star} \subset \mathcal{I}_{g_\star}$ satisfy case (I2) (i) above, and have respective infima ℓ_{f_\star} and ℓ_{g_\star} . Then, either
 - (i) f_\star and g_\star have an initial corner of overlap $c = (\ell_{f_\star}, \ell_{g_\star})$, or
 - (ii) f_\star and g_\star have an initial double corner of overlap (c, c') , where $c = (f \circ \ell_{f_\star}, \gamma)$ and $c' = (\gamma, g \circ \ell_{g_\star})$ for some saddle-saddle connection γ of X .
- (C2) Exactly one of $\mathcal{I}_{f_\star \cap g_\star}$ or $\mathcal{I}_{g_\star \cap f_\star}$ satisfies case (I2) (i) while the other satisfies case (I2) (ii). More precisely,

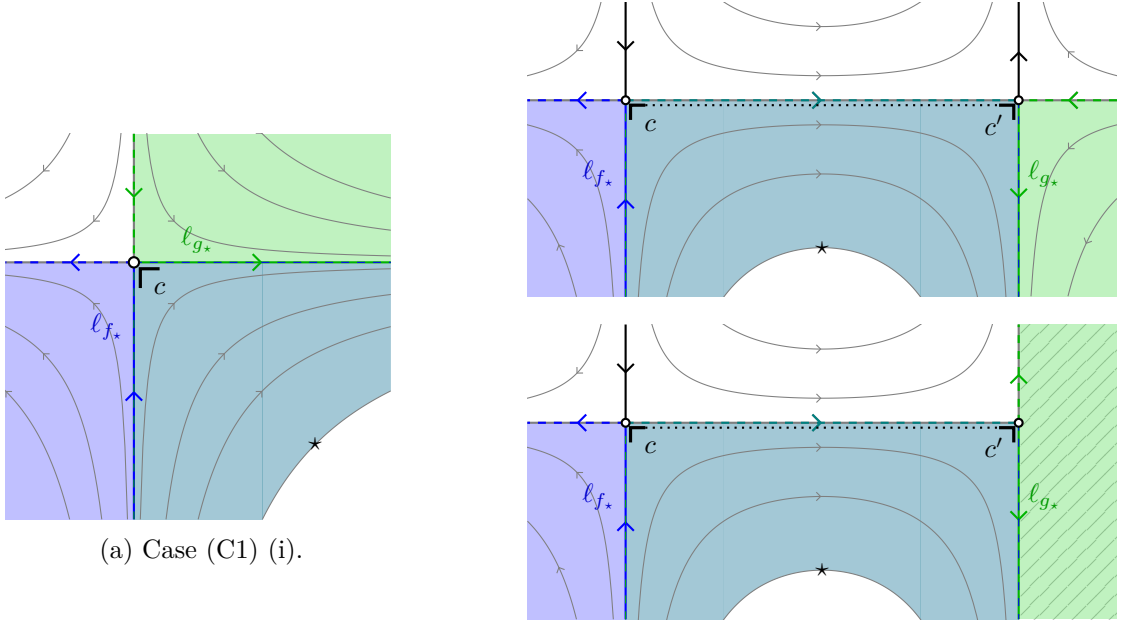

(a) Case (C1) (i).

(b) Case (C1) (ii). The right stable branch at c' might be in M^{pure} (top) or in M^{un} (bottom).

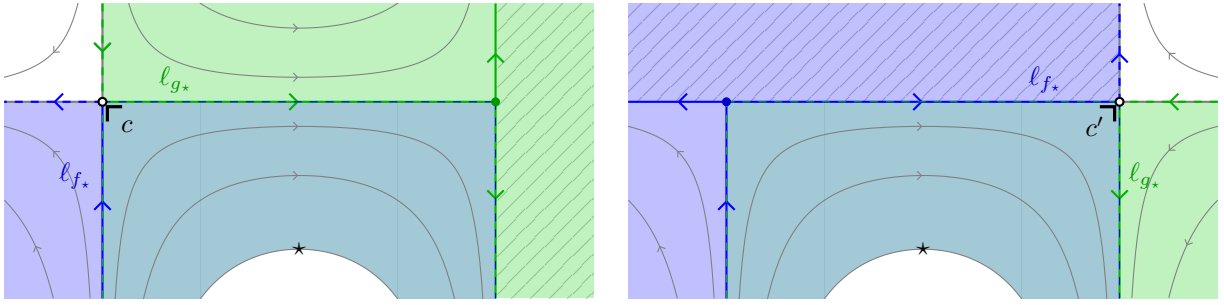

(c) Case (C2) (i).

(d) Case (C2) (ii).

Figure 16: Possible cases for initial (double) corners of overlap. The regions in blue correspond to \mathcal{D}_{f_\star} , the regions in green correspond to \mathcal{D}_{g_\star} , and their region of overlap is in teal. The thinly hatched regions are in M^{un} .

- (i) $\mathcal{I}_{f_\star \cap g_\star}$ has an infimum ℓ_s in \mathcal{I}_{f_\star} , while $\mathcal{I}_{g_\star \cap f_\star}$ has exactly two maximal lower bounds ℓ'_s and ℓ'^+_u in \mathcal{I}_{g_\star} , such that $c = (f \circ \ell_s, g \circ \ell'_s)$ and $c' = (g \circ \ell'_s, g \circ \ell'^+_u)$ form a double corner. In that case, c is the initial corner of overlap of f_\star and g_\star .
- (ii) $\mathcal{I}_{f_\star \cap g_\star}$ has exactly two maximal lower bounds ℓ_s and ℓ^+_u in \mathcal{I}_{f_\star} , while $\mathcal{I}_{g_\star \cap f_\star}$ has an infimum ℓ'^+_u in \mathcal{I}_{g_\star} , such that $c = (f \circ \ell_s, f \circ \ell^+_u)$ and $c' = (f \circ \ell'^+_u, g \circ \ell'^+_u)$ form a double corner. In that case, c' is the initial corner of overlap of f_\star and g_\star .

See Figure 16 for illustrations of all these cases.

We now describe how the shadows of f_\star and g_\star interact at an initial corner. This will be relevant in the definition of the extended preorder on \mathcal{U} . We begin with some definition.

If $c = (\gamma_s, \gamma_u) \in \mathfrak{C}_q^+$ is a forward corner at q , then for any points $q_s \in \gamma_s$ and $q_u \in \gamma_u$, there exist well-defined order preserving map $\varsigma_s : \mathcal{A}_{q_s} \hookrightarrow \mathcal{A}_q$ and $\varsigma_u : \mathcal{A}_{q_u} \hookrightarrow \mathcal{A}_q$ obtained by sliding the

marked point along the stable and unstable branch at c , respectively, to the corner point q . Here, we use that \mathcal{A} is complete. Similar maps already appeared in the proof of Lemma 6.11. If c is the initial corner of overlap of f_\star and g_\star , and $\ell_s \in \mathcal{I}_{f_\star}$ and $\ell_u \in \mathcal{I}_{g_\star}$ are the corresponding ‘entrance X -lines’ of f_\star and g_\star along c , respectively, we choose arbitrary points $x_s \in \ell_s$ and $x_u \in \ell_u$ so that $q_s := f(x_s) \in \gamma_s$ and $q_u := g(x_u) \in \gamma_u$. We then set

$$\begin{aligned}\Sigma(c) &:= \varsigma_s(\Sigma(x_s)) \subset \mathcal{A}_q, \\ \Sigma'(c) &:= \varsigma_u(\Sigma'(x_u)) \subset \mathcal{A}_q.\end{aligned}$$

Note that these sets are independent of the points x_s and x_u by axiom 4 of Definition 6.10. We then define $\widehat{\Sigma}(c) \subset \mathcal{A}_q$ and $\widehat{\Sigma}'(c) \subset \mathcal{A}_q$ as the smallest sections of \mathcal{A}_q (with respect to the inclusion) containing $\Sigma(c)$ and $\Sigma'(c)$, respectively. Since those are two sections, and the preorder on \mathcal{A}_q is total, one is included in the other. If $\widehat{\Sigma}(c) = \widehat{\Sigma}'(c)$, we say that f_\star and g_\star are **geometrically coherent at c** . Otherwise, we say that they are **geometrically noncoherent**.

We extend this definition to a double corner (c, c') . In the above notations, we consider points $q_s \in \gamma_s$, $q'_u \in \gamma'_u$, and $q_0 \in \gamma_0$. Sliding the marked points as before induces order preserving maps organized as follows:

$$\begin{array}{ccccc}\mathcal{A}_q & \xleftarrow{\varsigma_u} & \mathcal{A}_{q_0} & \xleftarrow{\varsigma'_s} & \mathcal{A}_{q'} \\ \varsigma_s \uparrow & & & & \uparrow \varsigma'_u \\ \mathcal{A}_{q_s} & & & & \mathcal{A}_{q'_u}\end{array}$$

We then consider $x_s \in \ell_s$, $x'_u \in \ell'_u$, and we define

$$\begin{aligned}\Sigma(c) &:= \varsigma_s(\Sigma(x_s)) \subset \mathcal{A}_q, \\ \Sigma'(c') &:= \varsigma'_u(\Sigma'(x'_u)) \subset \mathcal{A}_{q'}.\end{aligned}$$

As before, these sets do not depend on the choices of x_s and x'_u . Denoting $\widehat{\Sigma}(c) \subset \mathcal{A}_q$ and $\widehat{\Sigma}'(c') \subset \mathcal{A}_{q'}$ the smallest sections containing $\Sigma(c)$ and $\Sigma'(c')$, respectively, we define

$$\begin{aligned}\Sigma_0(c) &:= \varsigma_u^{-1}(\widehat{\Sigma}(c)) \subset \mathcal{A}_{q_0}, \\ \Sigma'_0(c') &:= (\varsigma'_s)^{-1}(\widehat{\Sigma}'(c')) \subset \mathcal{A}_{q_0},\end{aligned}$$

and we denote by $\widehat{\Sigma}_0(c)$ and $\widehat{\Sigma}'_0(c')$ the smallest sections of \mathcal{A}_{q_0} containing each of them. If $\widehat{\Sigma}_0(c) = \widehat{\Sigma}'_0(c')$, we say that f_\star and g_\star are **geometrically coherent at (c, c')** . Otherwise, we say that they are **geometrically noncoherent**.

7.2.4 Triple overlaps

We finally consider a third marked forward envelope $h_\star = (h : W \rightarrow M, c) \in \mathcal{U}_p$ with corresponding poset $\mathcal{I}_{h_\star} \subset \mathcal{L}_h$ and backward domain $\mathcal{D}_{h_\star} \subset W$. We define the ‘triple intersections’ by:

$$\begin{aligned}\mathcal{I}_{f_\star \cap g_\star \cap h_\star} &:= \mathcal{I}_{f_\star \cap g_\star} \cap \mathcal{I}_{f_\star \cap h_\star} \subset \mathcal{I}_{f_\star}, \\ \mathcal{D}_{f_\star \cap g_\star \cap h_\star} &:= \mathcal{D}_{f_\star \cap g_\star} \cap \mathcal{D}_{f_\star \cap h_\star} \subset \mathcal{D}_{f_\star}.\end{aligned}$$

Lemma 6.8 easily implies

Lemma 7.5 (see [BI08], Lemma 6.12). *The following identities hold:*

$$\begin{aligned}\alpha_{f_\star \cap g_\star}(\mathcal{I}_{f_\star \cap g_\star \cap h_\star}) &= \mathcal{I}_{g_\star \cap f_\star \cap h_\star}, & \varphi_{f_\star \cap g_\star}(\mathcal{D}_{f_\star \cap g_\star \cap h_\star}) &= \mathcal{D}_{g_\star \cap f_\star \cap h_\star}, \\ \alpha_{f_\star \cap g_\star}^{-1}(\mathcal{I}_{g_\star \cap h_\star}) &= \mathcal{I}_{f_\star \cap g_\star \cap h_\star}, & \varphi_{f_\star \cap g_\star}^{-1}(\mathcal{D}_{g_\star \cap h_\star}) &= \mathcal{D}_{f_\star \cap g_\star \cap h_\star}, \\ \alpha_{g_\star \cap h_\star} \circ \alpha_{f_\star \cap g_\star}(\ell) &= \alpha_{f_\star \cap h_\star}(\ell), & \varphi_{g_\star \cap h_\star} \circ \varphi_{f_\star \cap g_\star}(x) &= \varphi_{f_\star \cap h_\star}(x),\end{aligned}$$

for every $\ell \in \mathcal{I}_{f_\star \cap g_\star \cap h_\star}$ and $x \in \mathcal{D}_{f_\star \cap g_\star \cap h_\star}$.

Notice that by Lemma 7.3, either $I_{f_\star \cap g_\star \cap h_\star} = I_{f_\star \cap g_\star}$ or $I_{f_\star \cap g_\star \cap h_\star} = I_{f_\star \cap h_\star}$ or equivalently, either $I_{f_\star \cap g_\star} \subset I_{f_\star \cap h_\star}$ or $I_{f_\star \cap h_\star} \subset I_{f_\star \cap g_\star}$. In view of the cases (I0), (I1), and (I2) above, one easily deduces:

Lemma 7.6. *Up to permuting g_\star and h_\star , the following inclusions hold:*

$$\mathcal{I}_{f_\star \cap g_\star} \subset \mathcal{I}_{f_\star \cap h_\star}, \quad \mathcal{D}_{f_\star \cap g_\star} \subset \mathcal{D}_{f_\star \cap h_\star} \quad (7.2)$$

Note that this lemma depends on the hypothesis that none of the forward envelopes we consider have an initial edge corresponding to the pure stable branch of a quadratic-like singularity.

7.3 The preorder between envelopes

We are now ready to define a weak prefoliation structure on the collection \mathcal{U} of forward envelopes. As in [BI08, Section 6.2], we construct a preorder \lesssim on \mathcal{U}_\star in several steps. We first define a total order \lesssim_p on \mathcal{U}_p at every point $p \in M^{\text{good}}$ in five steps, before extending it to every $p \in M$.

7.3.1 Definition of the preorder

Let $f_\star, g_\star \in \mathcal{U}_p$ be two marked forward envelopes passing through $p \in M^{\text{good}}$, with respective domains U and V , and shadows Σ and Σ' .

The geometric relation \prec^{geo} . This relation corresponds to the relation $>_1$ from [BI08, Section 6.2.2], and is defined in a similar way. We set $f_\star \prec_p^{\text{geo}} g_\star$ if there exists $a_0 \in \mathcal{D}_{f_\star \cap g_\star}$ with $b_0 = \varphi_{f_\star \cap g_\star}(a_0)$ such that we either have

- (a) $\Sigma(a_0) \subsetneq \Sigma'(b_0)$, or
- (b) (g, b_0) is locally strictly above (f, a_0) .

The inclusion relation \prec^{inc} . This relation corresponds to the relation $>_2$ from [BI08, Section 6.2.2] and is defined in a similar way. We say that f_\star is a **strict subenvelope** of g_\star if f_\star and g_\star are not comparable by \prec_p^{geo} , and $\mathcal{D}_{f_\star} = \mathcal{D}_{f_\star \cap g_\star}$ but $\mathcal{D}_{g_\star \cap f_\star} \subsetneq \mathcal{D}_{g_\star}$. In this situation, f_\star and g_\star are comparable by \prec^{inc} and we set $f_\star \prec_p^{\text{inc}} g_\star$.

The relation at corners \prec^{cor} . This relation has no equivalent in [BI08] and is a feature of the presence of saddle and quadratic singularities. We start with some definitions.

Definition 7.7. *A collection of forward corners $\mathfrak{c} \subset \mathfrak{C}^+$ is **admissible** if it satisfies the following conditions.*

1. \mathfrak{c} contains exactly one forward corner at each pure saddle singularity, and no corner at quadratic-like singularities,

2. If (c, c') is a forward double-corner, then $\{c, c'\} \cap \mathfrak{c} = \emptyset$.

Choice 1. The relation \prec^{cor} depends on the choice of an admissible collection of forward corners $\mathfrak{c} \subset \mathfrak{C}^+$.

This choice will be crucial later when we extend the weak prefoliation structure to completed envelopes, see Section 7.3.3 below.

We first assume that f_\star and g_\star are not comparable by $\prec^{\text{geo}} \cup \prec^{\text{inc}}$ and have an initial corner of overlap c . After possibly renaming them, we further assume that they meet along c in the way described in Section 7.2.3. Then, we set $f_\star \prec_p^{\text{cor}} g_\star$ if one of the following holds:

1. f_\star and g_\star are geometrically noncoherent at c , and $\widehat{\Sigma}(c) \subsetneq \widehat{\Sigma}'(c)$,
2. f_\star and g_\star are geometrically coherent at c , and $c \in \mathfrak{c}$.

Otherwise, we set $g_\star \prec_p^{\text{cor}} f_\star$.

We now assume that f_\star and g_\star are not comparable by $\prec^{\text{geo}} \cup \prec^{\text{inc}}$ and have an initial double corner of overlap (c, c') where they meet in the way described in Section 7.2.3. Then, we set $f_\star \prec_p^{\text{cor}} g_\star$ if f_\star and g_\star are geometrically noncoherent at c and $\widehat{\Sigma}_0(c) \subsetneq \widehat{\Sigma}'_0(c)$. Otherwise, we set $g_\star \prec_p^{\text{cor}} f_\star$.

The relation along unstable components \prec^{un} . This relation has no equivalent in [BI08] and is a feature of the presence of source and quadratic singularities. We need to introduce some terminology and make some auxiliary choices before defining it.

Let $L \hookrightarrow M$ be a leaf of η in M^{un} . A **forward boundary component** of L is a connected component of the complement of the backward edges of L in ∂L . We denote by \mathcal{B}_L^+ the set of forward boundary components of L . A forward boundary component might be closed or might contain one or two corners. Moreover, a boundary component might contain two consecutive flow lines of X with opposite orientations, corresponding to pure unstable branches γ_u^\pm at a quadratic-like singularity q . We say that the pure stable branch γ_s at q is a **spike** for L if it is connected to a (pure) saddle singularity in negative times. In that case, q is a saddle singularity as well. Since X has no broken triple saddle connections (see Definition 2.4), L has *at most one* spike. The forward boundary component γ_u^- of L will be called a **distinguished boundary component** and will be denoted by $b_L^\dagger \in \mathcal{B}_L^+$. A total order on \mathcal{B}_L^+ for which b_L^\dagger (if it exists) is maximal will be called **admissible**. We define \mathfrak{D}_L^+ as the collection of all admissible total orders on \mathcal{B}_L^+ , and we set

$$\mathfrak{D}^+ := \prod_L \mathfrak{D}_L^+,$$

where the product runs over all the leaves of η in M^{un} . The admissibility condition will become relevant in the proof of Lemma 7.12, to ensure transitivity of the full preorder.

Choice 2. The relation \prec^{un} depends on the choice of a collection of admissible orders $\mathfrak{o} \in \mathfrak{D}^+$.

Let $U_c \subset \mathcal{D}_{f_\star}$ be an unstable component of f which is not initial if f is of unstable type, and let $h := f|_{U_c}$ be the corresponding unstable tile, which covers a leaf $L \hookrightarrow M$ of η in M^{un} . An **entrance edge** of f_\star to U_c is a forward edge of U_c which belongs to \mathcal{D}_{f_\star} . It exists since U_c is not initial, but it is not necessarily unique. However, there are at most three of those. If there are two, then they correspond to consecutive stable and unstable branches of a singularity of X , and if there are three, then they correspond to a succession of a stable branch of a saddle singularity q , a connection between q and another saddle singularity q' , and an unstable branch of q' . Such an entrance edge

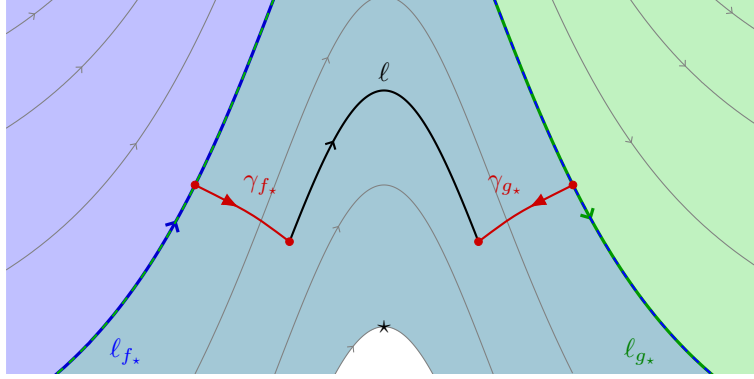

Figure 17: Overlap of f_* and g_* for \prec^{or} . The blue region corresponds to \mathcal{D}_{f_*} , the green region corresponds to \mathcal{D}_{g_*} , and their region of overlap is in teal.

projects to \bar{L} via the universal covering map, and to a forward boundary component $b_{f_*} \in \mathcal{B}_L^+$. Obviously, the latter is independent on the choice of entrance edge.

We set $f_* \prec_p^{\text{un}} g_*$ if f_* and g_* are not comparable by $\prec_p^{\text{geo}} \cup \prec_p^{\text{inc}} \cup \prec_p^{\text{cor}}$, and the following holds. There exists an initial unstable component of overlap $U_c \subset \mathcal{D}_{f_* \cap g_*}$ between f_* and g_* corresponding to a leaf $L \hookrightarrow M$ as above, together with forward boundary components $b_{f_*}, b_{g_*} \in \mathcal{B}_L^+$ induced by an entrance edge of f_* to U_c and of g_* to $\varphi_{\mathcal{D}_{f_* \cap g_*}}(U_c)$, respectively, which satisfy $b_{f_*} <^{\circ} b_{g_*}$. Here, $<^{\circ}$ denotes the total order on \mathcal{B}_L^+ coming from $\mathfrak{o} \in \mathfrak{D}^+$. Notice that b_{f_*} and b_{g_*} are necessarily distinct, since f_* and g_* don't have an initial (double) corner of overlap.

The X-lines orientation relation \prec^{or} . This relation corresponds to the relation $>_3$ from [BI08, Section 6.2.4]. We define $f_* \prec_p^{\text{or}} g_*$ if f_* and g_* are not comparable by $\prec_p^{\text{geo}} \cup \prec_p^{\text{inc}} \cup \prec_p^{\text{cor}} \cup \prec_p^{\text{un}}$, and the following holds. There exist maximal lower bounds $\ell_{f_*} \in \mathcal{I}_{f_*}$ and $\ell_{g_*} \in \mathcal{I}_{g_*}$ of $\mathcal{I}_{f_* \cap g_*} \subset \mathcal{I}_{f_*}$ and $\mathcal{I}_{g_* \cap f_*} \subset \mathcal{I}_{g_*}$, respectively, and two forward curves $\gamma_{f_*} : [0, 1] \rightarrow U$ and $\gamma_{g_*} : [0, 1] \rightarrow V$ such that

- $\gamma_{f_*}(0) \in \ell_{f_*}$ and $\gamma_{g_*}(0) \in \ell_{g_*}$,
- γ_{f_*} and $\varphi_{g_* \cap f_*}(\gamma_{g_*|_{(0,1]}})$ are disjoint,
- There exist a pure X-line $\ell \in \mathcal{I}_{f_* \cap g_*}$ and real numbers $s < t$ such that $\ell(s) \in \gamma_{f_*}$ and $\varphi_{f_* \cap g_*}(\ell(t)) \in \gamma_{g_*}$.

For short, we use the orientation on the pure X-lines near ℓ_{f_*} and ℓ_{g_*} to define the relation in this situation, see Figure 17.

Strictly speaking, this definition depends on an overall choice of orientation on \mathbb{R} : we could have replaced the condition $s < t$ with $t < s$ in the above third bullet.

Combining the five relations. We are now in the position to define a relation \succsim_p on \mathcal{U}_p as follows. First, we set

$$f_* \prec_p g_* \text{ if and only if } f_* \prec_p^{\heartsuit} g_* \text{ for some } \heartsuit \in \{\text{geo, inc, cor, un, or}\}.$$

We say that f_* and g_* are **forward-equivalent** if there exists an equivalence $\varphi : f_* \xrightarrow{\sim} g_*$ satisfying $\Sigma' \circ \varphi = \Sigma$. In particular, $f_* \approx_p g_*$. Then, we define:

$f_\star \lesssim_p g_\star$ if and only if $f_\star \prec_p g_\star$, or f_\star and g_\star are forward-equivalent.

So far, the relation \lesssim_p is only defined for $p \in M^{\text{good}}$. We extend it to every $p \in M$ as follows: $f_\star \lesssim_p g_\star$ if and only if there exists $q \in M^{\text{good}}$ and a continuous path $\gamma : [0, 1] \rightarrow M$ with $\gamma(0) = p$, $\gamma(1) = q$, which lifts to both f_\star and g_\star , and $f_{\gamma_\star} \lesssim_q g_{\gamma_\star}$. Here, f_{γ_\star} and g_{γ_\star} are obtained from f_\star and g_\star by sliding the marked points along γ in the obvious way.

The collection of homogeneous relations $\{\lesssim_p\}_{p \in M}$ naturally induces a homogeneous relation \lesssim on \mathcal{U}_\star .

7.3.2 Proof of the weak prefoliation axioms

This section is dedicated to the proof of

Proposition 7.8. *The set \mathcal{U} of forward envelopes equipped with the relation \lesssim is a weak prefoliation.*

We split the proof into the following four lemmas.

Lemma 7.9 (Definition 5.8, Axiom 2). *The relation \lesssim is coherent along intersections.*

Proof. The relation \lesssim is trivially coherent along unstable components and along pure X -lines by definition. It is also coherent along forward curves for the same reasons as in the proof of [BI08, Lemma 6.15]. We are left to show that it is coherent at singularities in M^{bad} . If $p \notin M^{\text{good}}$ and $f_\star \in \mathcal{U}_p$, then the marked point of f_\star lies in the interior of the domain of f . Therefore, coherence of \lesssim along intersections contained in M^{good} immediately implies coherence at p . \square

Lemma 7.10 (Definition 5.8, Axiom 0). *For every $p \in M$, \lesssim_p is total. Moreover, for all $f_\star, g_\star \in \mathcal{U}_\star$, $f_\star \simeq g_\star$ if and only if f_\star and g_\star are forward-equivalent.*

Proof. First assume $p \in M^{\text{good}}$, and consider $f_\star, g_\star \in \mathcal{U}_p$ with our usual notations for their domains, shadows, and marked points.

If f_\star and g_\star are comparable by \prec_p^{geo} , say $f_\star \prec_p^{\text{geo}} g_\star$, then f_\star and g_\star are not equivalent and $g_\star \not\prec_p^{\text{geo}} f_\star$. Indeed, arguing as in [BI08, Section 6.2.2] by considering forward curves from/to a_0 , it is easy to see that for every $x \in \mathcal{D}_{f_\star \cap g_\star}$, $\Sigma(x) \subset \Sigma'(\varphi_{f_\star \cap g_\star}(x))$ and (f, x) is not locally strictly above $(g, \varphi_{f_\star \cap g_\star}(x))$.

If f_\star and g_\star are not comparable by \prec_p^{geo} , then for every $x \in \mathcal{D}_{f_\star \cap g_\star}$, $\Sigma(x) = \Sigma'(\varphi_{f_\star \cap g_\star}(x))$ and (f, x) and $(g, \varphi_{f_\star \cap g_\star}(x))$ locally coincide.²⁸ We now analyze how f_\star and g_\star ‘first meet’ along $\mathcal{D}_{f_\star \cap g_\star}$ depending on which case from Lemma 7.4 holds:

(I0) $\mathcal{I}_{f_\star \cap g_\star} = \emptyset$. In that case, f_\star and g_\star have an initial unstable component of overlap $U_c \subset \mathcal{D}_{f_\star \cap g_\star}$.

If both U_c and $\varphi(U_c)$ correspond to the initial unstable components of f_\star and g_\star , respectively, then f_\star and g_\star are forward-equivalent by Proposition 6.16.

If U_c corresponds to the initial unstable component of f_\star , but $\varphi(U_c)$ does not correspond to the initial unstable component of g_\star , then f_\star and g_\star are comparable by \prec^{inc} and $f_\star \prec^{\text{inc}} g_\star$. The case where U_c and $\varphi(U_c)$ are swapped is similar.

Otherwise, f_\star and g_\star are comparable by \prec^{un} , since U_c does not correspond to their initial unstable components and they don’t have an initial (double) corner of overlap. Obviously, either $f_\star \prec_p^{\text{un}} g_\star$ or $g_\star \prec_p^{\text{un}} f_\star$ holds, but not both.

²⁸Notice that they automatically locally coincide in the forward direction as soon as their shadows coincide, because of basic properties of forward envelopes.

- (I1) $\mathcal{I}_{f_\star \cap g_\star}$ has minimal elements. If f_\star and g_\star have an initial (double) corner of overlap, then they are comparable by \prec_p^{cor} , and only one of $f_\star \prec_p^{\text{cor}} g_\star$ or $g_\star \prec_p^{\text{cor}} f_\star$ holds. We now assume that they do not have an initial (double) corner of overlap.

If they have an initial unstable component of overlap, we proceed as in the last step of the previous item. Otherwise, f_\star and g_\star are comparable by \prec_p^{inc} . Indeed, if $\mathcal{I}_{f_\star \cap g_\star}$ has a unique minimal element, which is a minimum, then this minimum corresponds to the initial edge of either f_\star or g_\star , depending on whether it is the minimum of \mathcal{I}_{f_\star} or not. If $\mathcal{I}_{f_\star \cap g_\star}$ has strictly more than one minimal element, then it is easy to see that $g_\star \prec_p^{\text{inc}} f_\star$.

- (I2) $\mathcal{I}_{f_\star \cap g_\star}$ has no minimal elements. Observe that if f_\star and g_\star are comparable by $\prec_p^{\text{cor}} \cup \prec_p^{\text{inc}} \cup \prec_p^{\text{un}}$, then $\mathcal{I}_{f_\star \cap g_\star}$ is either empty or has a minimal element. Therefore, we need to show that f_\star and g_\star are comparable by \prec_p^{or} . For that, we consider a forward curve $\gamma_0 : [0, 1] \rightarrow U$ from the initial component of f to a , and a forward curve $\gamma_1 : [0, 1] \rightarrow V$ from the initial component of g to b . There exist $t_0, t_1 \in [0, 1]$ such that $\gamma_0(t_0)$ and $\gamma_1(t_1)$ belong X -lines $\ell_0 \subset U$ and $\ell_1 \subset V$ which are maximal lower bounds for $\mathcal{I}_{f_\star \cap g_\star} \subset \mathcal{I}_{f_\star}$ and $\mathcal{I}_{g_\star \cap f_\star} \subset \mathcal{I}_{g_\star}$, respectively. For $t > t_0$, $\gamma_0(t) \in \mathcal{D}_{f_\star \cap g_\star}$ and for $t > t_1$, $\gamma_1(t) \in \mathcal{D}_{g_\star \cap f_\star}$. Moreover, there exists $\epsilon > 0$ such that $\gamma_{f_\star} := \gamma_{0|_{[t_0, t_0+\epsilon]}}$ and $\gamma_{g_\star} := \gamma_{1|_{[t_1, t_1+\epsilon]}}$ are strictly forward, and γ_{f_\star} and $\varphi_{g_\star \cap f_\star}(\gamma_{g_\star|_{[t_1, t_1+\epsilon]}})$ are disjoint. Since f_\star and g_\star do not have an initial unstable domain of overlap, there exists either

0. A pure X -line ℓ intersecting both γ_{f_\star} and γ_{g_\star} ,
1. A special triple $(\ell_s, \ell_u^-, \ell_u^+)$ such that ℓ_s intersects one of γ_{f_\star} and γ_{g_\star} and ℓ_u^- or ℓ_u^+ intersects the other,
2. Two special triples $(\ell_s, \ell_u^-, \ell_u^+)$ and $(\ell'_s, \ell'_u^-, \ell'_u^+)$ with $\ell'_s \in \{\ell_u^-, \ell_u^+\}$ such that ℓ_s intersects one of γ_{f_\star} and γ_{g_\star} and ℓ'_u^- or ℓ'_u^+ intersects the other.

In cases 1 and 2, we can modify γ_{f_\star} or γ_{g_\star} by performing suitable T -moves to reduce to case 0 while keeping the two curves disjoint. This implies that f_\star and g_\star are comparable by \prec_p^{or} . It remains to show that $f_\star \prec_p^{\text{or}} g_\star$ and $g_\star \prec_p^{\text{or}} f_\star$ cannot hold simultaneously. If both inequalities hold, then after performing suitable T -moves and forward isotopies, we would obtain the following situation: there exists two forward curves γ_{f_\star} and γ_{g_\star} as above, together with two pure X -lines or pure ‘broken X -lines’ (as in cases 1 and 2 above), one from γ_{f_\star} to γ_{g_\star} and the other one from γ_{g_\star} to γ_{f_\star} . This would imply the existence of a pure X -line which is ‘trapped’ (in positive or negative times) in a compact region of U , which is impossible. The details are left to the reader.

Finally, we assume that $p \notin M^{\text{good}}$. In particular, $p \in \Delta_{\text{sa}} \cup Q$, and the marked points of f_\star and g_\star belong to the interior of their domains of definition. We can slide these marked points along a stable or unstable branch at p to obtain marked tiles $(f, a'), (g, b') \in \mathcal{U}_{p'}$ where $p' \in M^{\text{good}}$. Therefore, (f, a') and (g, b') are comparable by $\succ_{p'}$ by the above, so f_\star and g_\star are comparable by \succ_p by definition. Finally, if $f_\star \succ_p g_\star$ and $g_\star \succ_p f_\star$, then the same holds at some nearby $p' \in M^{\text{good}}$ by sliding the marked point a and b to nearby a' and b' , hence $(f, a') \approx_{p'} (g, b')$. Sliding the marked points back yields $f_\star \approx_p g_\star$. \square

Lemma 7.11 (Definition 5.8, Axiom 1). *For all $f_\star, g_\star \in \mathcal{U}_\star$, if $f_\star \succ g_\star$, then g_\star is locally above f_\star .*

Proof. The proof is essentially the same as the one of [BI08, Lemma 6.13]. Let $p \in M$ and $f_\star, g_\star \in \mathcal{U}_p$. Assume first that $p \in M^{\text{good}}$. If f_\star and g_\star are comparable by \prec_p^{geo} , say $f_\star \prec_p^{\text{geo}} g_\star$, then we connect the point a_0 given by the definition to the marked point a of f by a forward curve. Properties of upper enveloping tiles (see Definition 6.10) and one-dimensional envelopes (see [BI08, Section 5])

immediately imply that g_\star is locally above f_\star . If f_\star and g_\star are not comparable by \prec_p^{geo} , then f_\star is not locally strictly above g_\star , and since one of these two forward tiles is locally above the other (for the same reasons as in [BI08, Lemma 6.5]), then g_\star is locally above f_\star . If $p \notin M^{\text{good}}$ and f_\star is locally strictly above g_\star , then there exists $p' \in M^{\text{good}}$ on one of the stable or unstable branches at p such that if $(f, a'), (g, b') \in \mathcal{U}_{p'}$ denote the marked tiles obtained by sliding the marked points of f_\star and g_\star , respectively, then (f, a') is locally strictly above (g, b') . Therefore, $(g, b') \prec_{p'}^{\text{geo}} (f, a')$, hence $g_\star \prec f_\star$. \square

We finish the proof of Proposition 7.8 with the trickiest property:

Lemma 7.12. *The relation \lesssim is transitive.*

Proof. Let $p \in M$. Notice that if $f_\star, g_\star, h_\star \in \mathcal{U}_p$ and f_\star and g_\star are forward-equivalent, then $f_\star \lesssim_p h_\star$ if and only if $g_\star \lesssim_p h_\star$, by definition. Therefore, in view of Lemma 7.10, transitivity of \lesssim_p is equivalent to the statement: *every triple of elements in \mathcal{U}_p admits an extremum (maximum or minimum)*. Moreover, by Lemma 7.9, it is enough to consider the case $p \in M^{\text{good}}$. By Lemma 7.6, we can assume that $\mathcal{I}_{f_\star \cap g_\star} \subset \mathcal{I}_{f_\star \cap h_\star}$ and $\mathcal{D}_{f_\star \cap g_\star} \subset \mathcal{D}_{f_\star \cap h_\star}$. We enumerate all the possible cases for the order between f_\star and g_\star .

1. f_\star and g_\star are comparable by \prec^{geo} . Assume that there exist $a_0 \in \mathcal{D}_{f_\star \cap g_\star}$ and $b_0 = \varphi_{f_\star \cap g_\star}(a_0)$ such that $\Sigma_f(a_0) \neq \Sigma_g(b_0)$, and consider $c_0 := \varphi_{f_\star \cap h_\star}(a_0) \in \mathcal{D}_{h_\star}$. This is well-defined since $a_0 \in \mathcal{D}_{f_\star \cap g_\star} \subset \mathcal{D}_{f_\star \cap h_\star}$. Then, among the three sections $\Sigma_f(a_0)$, $\Sigma_g(b_0)$ and $\Sigma_h(c_0)$ of \mathcal{U}_p , there must exist a *strict* maximum or minimum for the inclusion, implying that the corresponding marked tiles is an extremum in $\{f_\star, g_\star, h_\star\}$. Otherwise, there exists a_0 and b_0 as above such that (g, b_0) is locally strictly above (f, a_0) . In that case, $p \in M^{\text{pure}}$. Intersecting f_\star , g_\star and h_\star with a small embedded disk in M passing through p and transverse to X , we obtain three 1-dimensional envelopes for the restriction of \mathcal{A} to that disk, two of which are strictly comparable by the geometric order. We further consider two cases.
 - (a) If $c_0 = \varphi_{f_\star \cap h_\star}(a_0)$ does not belong to the initial edge of h (if it exists), then one of the three 1-dimensional envelopes is strictly below or above the two others, and the corresponding marked forward envelope is an extremum in $\{f_\star, g_\star, h_\star\}$.
 - (b) Otherwise, f_\star and g_\star ‘begin to overlap’ along the initial edge of h_\star . If $\Sigma_h(c_0) \neq \Sigma_f(a_0)$, then since $\Sigma_f(a_0) = \Sigma_g(b_0)$ by assumption, h_\star is comparable by \prec^{geo} with both f_\star and g_\star . Moreover, it is either below or above both of them for \prec^{geo} , so h_\star is an extremum of $\{f_\star, g_\star, h_\star\}$. If $\Sigma_h(c_0) = \Sigma_f(a_0) = \Sigma_g(b_0)$, then h_\star is comparable by \prec^{inc} with both f_\star and g_\star , and h_\star is similarly an extremum of $\{f_\star, g_\star, h_\star\}$.
2. f_\star and g_\star are comparable by \prec^{inc} . We first assume that g_\star is a strict subenvelope of f_\star ; in particular, $\mathcal{D}_{g_\star} = \mathcal{D}_{g_\star \cap f_\star}$. Notice that $\mathcal{D}_{h_\star \cap g_\star} \subset \mathcal{D}_{h_\star \cap f_\star}$ by Lemma 7.5. By the previous case, we can assume that g_\star and h_\star are not comparable by \prec^{geo} . We also have $\mathcal{D}_{g_\star} = \mathcal{D}_{g_\star \cap h_\star}$, so either g_\star and h_\star are order-equivalent, or g_\star is a strict subenvelope of h_\star . Hence, either f_\star or g_\star is an extremum in $\{f_\star, g_\star, h_\star\}$. We now assume that f_\star is a strict subenvelope of g_\star . Hence, $\mathcal{D}_{f_\star} = \mathcal{D}_{f_\star \cap g_\star} \subset \mathcal{D}_{f_\star \cap h_\star} = \mathcal{D}_{f_\star}$. In particular, $\mathcal{D}_{g_\star \cap f_\star} = \mathcal{D}_{g_\star \cap h_\star}$ and $\mathcal{D}_{h_\star \cap f_\star} = \mathcal{D}_{h_\star \cap g_\star}$, and by case 1 above, we can assume that f_\star and g_\star are not comparable by \prec^{geo} , and f_\star and h_\star are not comparable by \prec^{geo} . In this situation, f_\star is a (not necessarily strict) subenvelope of g_\star and h_\star , so $\{f_\star, g_\star, h_\star\}$ has an extremum by the previous argument.
3. f_\star and g_\star are comparable by \prec^{cor} . We consider three cases.

(a) f_\star and g_\star have a simple initial corner of overlap c , which is not connected to another forward corner. Since we do not consider forward envelopes starting at the pure stable branch of a quadratic-like singularity, c is a pure corner. We consider two subcases.

i. $\mathcal{D}_{f_\star \cap g_\star} \subsetneq \mathcal{D}_{f_\star \cap h_\star}$. Then c is also the initial corner of overlap of g_\star and h_\star . In that case, $\mathcal{D}_{g_\star \cap h_\star} = \mathcal{D}_{g_\star \cap f_\star}$ so by case 1 above, we can assume that g_\star and h_\star are not comparable by \prec^{geo} , hence they are comparable by \prec^{cor} . Let $a_0 \in U$ be a point on the X -line corresponding to the branch at c bounding $\mathcal{D}_{f_\star \cap g_\star}$ in \mathcal{D}_{f_\star} , and $c_0 := \varphi_{f_\star \cap h_\star}(a_0)$. Note that f_\star and h_\star play a symmetric role here. If $\Sigma_f(a_0) \neq \Sigma_h(c_0)$, then $\widehat{\Sigma}_f(c) \neq \widehat{\Sigma}_h(c)$ (see Section 7.2.3 for the notation), and either f_\star or h_\star is an extremum of $\{f_\star, g_\star, h_\star\}$. Otherwise, $\widehat{\Sigma}_f(c) = \widehat{\Sigma}_h(c)$, and the order of f_\star with g_\star for \prec^{cor} is the same as the one of h_\star with g_\star , implying that g_\star is an extremum of $\{f_\star, g_\star, h_\star\}$.

ii. $\mathcal{D}_{f_\star \cap g_\star} = \mathcal{D}_{f_\star \cap h_\star}$. By case 1 above, we can assume that f_\star and h_\star are not comparable by \prec^{geo} , and moreover they are not comparable by \prec^{inc} . We consider three further subcases.

- f_\star and h_\star are comparable by \prec^{cor} . Then c is also the initial corner of overlap between f_\star and g_\star , and $\mathcal{D}_{g_\star \cap f_\star} \subsetneq \mathcal{D}_{g_\star \cap h_\star}$ so we can appeal to case 3(a)i above.
- f_\star and h_\star are comparable by \prec^{un} . Then one easily sees that h_\star and g_\star are also comparable by \prec^{un} and share the same initial unstable domain of overlap as h_\star and f_\star . Since the entrance edges of f_\star and g_\star lie on the same forward boundary component of the leaf corresponding to that unstable component, but the entrance edge(s) of h_\star necessarily lies on a different forward boundary component, the order of f_\star with h_\star for \prec^{un} is the same as the one of g_\star with h_\star , implying that h_\star is an extremum of $\{f_\star, g_\star, h_\star\}$.
- f_\star and h_\star are comparable by \prec^{or} . Then g_\star and h_\star are comparable by \prec^{or} as well, and it follows from the definition of \prec^{or} and the behavior of X -lines near a forward corner that the order of f_\star with h_\star for \prec^{or} is the same as the one of g_\star with h_\star , implying that h_\star is an extremum of $\{f_\star, g_\star, h_\star\}$.

(b) f_\star and g_\star have a simple initial corner of overlap c , which is connected to another forward corner c' . We again consider two subcases.

i. c' is a corner at a pure saddle singularity. We further assume that f_\star and h_\star are comparable by \prec^{cor} and c' is their initial corner of overlap, as all the other cases can be treated as in case 3(a).

Up to permuting f_\star , g_\star and h_\star , we can assume that (c, c') is a double corner and f_\star and h_\star meet along (c, c') . We will use the notations of Section 7.2.3. We consider the sections $\widehat{\Sigma}_f(c), \widehat{\Sigma}_g(c) \subset \mathcal{A}_q, \widehat{\Sigma}_g(c'), \widehat{\Sigma}_h(c') \subset \mathcal{A}_{q'}$, and $\Sigma_g(b_0), \widehat{\Sigma}_{f,0}(c), \widehat{\Sigma}_{h,0}(c') \subset \mathcal{A}_{q_0}$. Here, b_0 lies on the boundary of $\mathcal{D}_{g_\star \cap f_\star} \subset \mathcal{D}_{g_\star}$ and $g(b_0) = q_0$. Tracing through the definitions of these sets, one easily shows:

$$\widehat{\Sigma}_f(c) \subset \widehat{\Sigma}_g(c) \implies \widehat{\Sigma}_{f,0}(c) \subset \Sigma_g(b_0), \quad (7.3)$$

$$\widehat{\Sigma}_g(c) \subset \widehat{\Sigma}_f(c) \iff \Sigma_g(b_0) \subset \widehat{\Sigma}_{f,0}(c), \quad (7.4)$$

and similarly,

$$\widehat{\Sigma}_h(c') \subset \widehat{\Sigma}_g(c') \implies \widehat{\Sigma}_{h,0}(c') \subset \Sigma_g(b_0),$$

$$\widehat{\Sigma}_g(c') \subset \widehat{\Sigma}_h(c') \iff \Sigma_g(b_0) \subset \widehat{\Sigma}_{h,0}(c').$$

This immediately implies the following:

- If $\widehat{\Sigma}_f(c) \subset \widehat{\Sigma}_g(c)$ and $\widehat{\Sigma}_g(c') \subsetneq \widehat{\Sigma}_h(c')$, then $\widehat{\Sigma}_{f,0}(c) \subsetneq \widehat{\Sigma}_{h,0}(c')$.

- If $\widehat{\Sigma}_g(c) \subset \widehat{\Sigma}_f(c)$ and $\widehat{\Sigma}_h(c') \subset \widehat{\Sigma}_g(c')$, then $\widehat{\Sigma}_{f,0}(c) \subset \widehat{\Sigma}_{h,0}(c')$.

By the definition of \prec^{cor} , we have:

$$\begin{aligned} \widehat{\Sigma}_h(c) \subset \widehat{\Sigma}_g(c) &\implies h_\star \prec^{\text{cor}} g_\star, \\ \widehat{\Sigma}_g(c) \subset \widehat{\Sigma}_f(c) &\implies g_\star \prec^{\text{cor}} f_\star, \end{aligned} \tag{7.5}$$

$$\widehat{\Sigma}_{h,0}(c) \subset \widehat{\Sigma}_{f,0}(c) \implies h_\star \prec^{\text{cor}} f_\star. \tag{7.6}$$

It is easy to conclude that in all the possible cases for the inclusions between $\widehat{\Sigma}_f(c)$ and $\widehat{\Sigma}_g(c)$, and between $\widehat{\Sigma}_g(c)$ and $\widehat{\Sigma}_h(c)$, $\{f_\star, g_\star, h_\star\}$ has an extremum.

- ii. *c' is a corner at a quadratic-like singularity.* If (c', c) is a double forward corner, all the possible cases can be treated as 3(a), so we assume that (c, c') is a double forward corner. For the same reasons, we assume that f_\star and h_\star are comparable by \prec^{cor} and (c, c') is their initial corner of overlap, so that $\mathcal{D}_{g_\star \cap f_\star} \subseteq \mathcal{D}_{g_\star \cap h_\star}$. Here, f_\star and g_\star intersect as in case (C2)(i) of Section 7.2.3, see Figure 16c, while f_\star and h_\star intersect as in case (C1) (ii), see Figure 16b (in particular the bottom one).

We use the same notations as before. We also consider points $y_0 \in \mathcal{D}_{g_\star}$ and $z_0 \in \mathcal{D}_{h_\star}$ such that $\varphi_{h_\star \cap g_\star}(z_0) = y_0$, and z_0 lies on the X -line corresponding to the minimum of $\mathcal{I}_{h_\star \cap g_\star}$ in \mathcal{I}_{h_\star} , so that $h(z_0)$ belongs to the right unstable branch of the singularity at c' .

The implications (7.3) and (7.4) still hold, as well as

$$\Sigma_h(z_0) \subset \Sigma_g(y_0) \implies \widehat{\Sigma}_{h,0}(c') \subset \Sigma_g(b_0).$$

The implications (7.5) and (7.6) hold for similar reasons, as well as

$$\Sigma_h(z_0) \subset \Sigma_g(y_0) \implies h_\star \prec g_\star.$$

Indeed, if $\Sigma_h(z_0) \subsetneq \Sigma_g(y_0)$, then g_\star and h_\star are comparable by \prec^{geo} and $h_\star \prec^{\text{geo}} g_\star$. If $\Sigma_h(z_0) = \Sigma_g(y_0)$, then g_\star and h_\star are not comparable by \prec^{geo} , and two possibilities arise. Either z_0 belong to the initial edge of h_\star , and $h_\star \prec^{\text{inc}} g_\star$, or g_\star and h_\star are comparable by \prec^{un} and their initial unstable domain of overlap corresponds to the unstable tile L at q' (recall that f_\star and h_\star do not meet along c). Moreover, the connection in $c \cap c'$ is a spike for L , and the entrance edge for g_\star is the distinguished boundary component of L . By our conventions for admissible orders on unstable tiles, we have $h_\star \prec^{\text{un}} g_\star$.

Examining all the possible inclusions between $\widehat{\Sigma}_f(c)$ and $\widehat{\Sigma}_g(c)$, and between $\Sigma_g(y_0)$ and $\Sigma_h(z_0)$, it is easy to show that $\{f_\star, g_\star, h_\star\}$ always has an extremum.

- (c) f_\star and g_\star have an initial double corner of overlap (c, c') . The cases where h_\star is comparable by \prec^{geo} , \prec^{inc} , or \prec^{cor} with either f_\star or g_\star can be treated as in 3(a) or 3(b), up to permutation. In the remaining cases, h_\star is comparable with both f_\star and g_\star by one of the two relations \prec^{un} or \prec^{or} , and the strategy of case 3(a)ii applies.
4. f_\star and g_\star are comparable by \prec^{un} . The only case that has not been treat yet, up to permutation, is when f_\star , g_\star , and h_\star are all comparable by \prec^{un} and share the same initial unstable domain of overlap. In this situation, transitivity immediately follows from the definition of \prec^{un} .
5. f_\star and g_\star are comparable by \prec^{or} . The only case that has not been treated yet, up to permutation, is when f_\star , g_\star , and h_\star are all comparable by \prec^{or} , and $\mathcal{D}_{f_\star \cap g_\star} = \mathcal{D}_{f_\star \cap h_\star}$ and $\mathcal{D}_{g_\star \cap f_\star} = \mathcal{D}_{g_\star \cap h_\star}$. Without loss of generality, let us assume that $f_\star \prec^{\text{or}} g_\star$ and $g_\star \prec^{\text{or}} h_\star$. We consider forward curves γ_{f_\star} , γ_{g_\star} , and γ_{h_\star} as in the definition of \prec^{or} ; by item (I2) in the proof of Lemma 7.10,

we can assume that there exist a pure X -line $\ell_0 \in \mathcal{I}_{f_* \cap g_*}$ from γ_{f_*} to γ_{g_*} and a pure X -line $\ell_1 \in \mathcal{I}_{g_* \cap h_*}$ from γ_{g_*} to γ_{h_*} . Let $\ell'_1 \in \mathcal{I}_{f_* \cap g_*}$ denote $\alpha_{g_* \cap f_*}(\ell_1)$. If $\ell'_1 = \ell_0$, we readily obtain a pure X -line from γ_{f_*} to γ_{h_*} and $f_* \prec^{\text{or}} h_*$. Otherwise, $\varphi_{g_* \cap f_*}(\gamma_{g_*|_{(0,1]}})$ induces a strictly forward curve intersecting ℓ_0 and ℓ'_1 , so either $\ell_0 \triangleleft \ell'_1$ or $\ell'_1 \triangleleft \ell_0$. Let us consider the case $\ell_0 \triangleleft \ell'_1$ first. Using Lemma 6.7, it is easy to show that either ℓ'_0 intersects γ_{f_*} , or is part of a broken X -line intersecting γ_{f_*} as in cases 1 and 2 in of item (I2) in the proof of Lemma 7.10. It follows that $f_* \prec^{\text{or}} h_*$. The case $\ell_0 \triangleleft \ell'_1$ can be treated similarly by considering $\ell'_0 := \alpha_{f_* \cap g_*}(\ell_0)$ and ℓ_1 instead, and showing that ℓ'_0 is part of a (broken) pure X -line intersecting γ_{h_*} .

□

7.3.3 Completed forward envelopes

In this section, we extend the previously constructed weak prefoliation structure on \mathcal{U} to the collection of *completed* forward envelopes $\overline{\mathcal{U}}$. Notice that since \mathcal{U} covers M^{good} (minus the stable branches at quadratic-like singularities), $\overline{\mathcal{U}}$ covers M .

Let $f, g \in \mathcal{U}$ be forward envelopes (with our usual notations), with completions $\bar{f}, \bar{g} \in \overline{\mathcal{U}}$, and $a \in \bar{U}$ and $b \in \bar{V}$ such that $\bar{f}(a) = \bar{g}(b) =: p$. We write $\bar{f}_* = (\bar{f}, a)$ and $\bar{g}_* = (\bar{g}, b)$.

If $p \in M^{\text{good}}$, then the extension of \lesssim_p to $\overline{\mathcal{U}}_p$ is entirely determined by axioms 1 and 2 of Definition 5.8. Indeed, a either belongs to U or to a forward edge of \bar{U} , and similarly for b . Near p , \bar{f}_* and \bar{g}_* locally look like a disk or a half-disk bounded by the flow line of X passing through p . Therefore, we can distinguish two cases:

1. \bar{f}_* and \bar{g}_* locally coincide. Then we can slide the marked points along a (possibly trivial) small curve γ from p to $p' \in M$ such that the new marked points satisfy $a' \in U$ and $b' \in V$. Then, we set $\bar{f}_* \dot{\lesssim}_p \bar{g}_*$ if $(f, a') \lesssim_{p'} (g, b')$, and $\bar{g}_* \dot{\lesssim}_p \bar{f}_*$ otherwise. Notice that this does not depend on the choice of γ , since f and g intersect along a path-connected set near p .
2. One of \bar{f}_* and \bar{g}_* is locally strictly above the other, since f and g cannot topologically cross. We set $\bar{f}_* \dot{\lesssim}_p \bar{g}_*$ if \bar{g}_* is locally strictly above \bar{f}_* , and $\bar{g}_* \dot{\lesssim}_p \bar{f}_*$ otherwise.

The previous arguments can easily be adapted to extend \lesssim_p to $\overline{\mathcal{U}}_p$ for $p \in Q^*$, because of the shape of forward tiles near a quadratic-like singularities, see Figure 13. Crucially, the interiors of two such tiles intersect along a *path-connected* set near p when they locally coincide. It is then straightforward to check that $\dot{\lesssim}_p$ is an extension of \lesssim_p to $\overline{\mathcal{U}}_p$ and that the axioms of Definition 5.8 are satisfied on $M \setminus \Delta_{\text{sa}}^{\text{pure}}$.

The extension of \lesssim_p to $\overline{\mathcal{U}}_p$ for $p \in \Delta_{\text{sa}}^{\text{pure}}$ is more subtle. We consider two cases:

1. \bar{f}_* and \bar{g}_* intersect along a stable or unstable branch at p . We then slide the marked points along this branch to obtain $(\bar{f}, a'), (\bar{g}, b') \in \overline{\mathcal{U}}_{p'}$ and we set $\bar{f}_* \dot{\lesssim}_p \bar{g}_*$ if $(\bar{f}, a') \dot{\lesssim}_{p'} (\bar{g}, b')$, and $\bar{g}_* \dot{\lesssim}_p \bar{f}_*$ otherwise. Notice that $\dot{\lesssim}_{p'}$ is already defined.
2. \bar{f}_* and \bar{g}_* do not intersect along the stable and unstable branches at p . In that case, they form two opposite (forward) quadrants at p , and they only intersect at p near p . Let $\Sigma_{\bar{f}}^{\perp} \subset \mathcal{A}_p$ denotes the set of marked tiles $h_* \in \mathcal{A}_p$ such that either h_* is locally geometrically below f , or they locally coincide (relative to the domain of f) and after sliding the marked points inside the interiors of the domain of f and h , $(h, z') \in \Sigma_f(x')$. Here, x' and z' denote the slid marked points of f and h , respectively, satisfying $f(x') = h(z')$. We further denote by $\widehat{\Sigma}_{\bar{f}}^{\perp} \subset \mathcal{A}_p$ the section generated by $\Sigma_{\bar{f}}^{\perp}$. We similarly define $\widehat{\Sigma}_{\bar{g}}^{\perp} \subset \mathcal{A}_p$. If $\widehat{\Sigma}_{\bar{f}}^{\perp} \subsetneq \widehat{\Sigma}_{\bar{g}}^{\perp}$ (resp. $\widehat{\Sigma}_{\bar{g}}^{\perp} \subsetneq \widehat{\Sigma}_{\bar{f}}^{\perp}$), we set

$\bar{f}_\star \dot{\succ}_p \bar{g}_\star$ (resp. $\bar{g}_\star \dot{\succ}_p \bar{f}_\star$). This corresponds to the ‘geometrically coherent’ case in the definition of \prec^{cor} .

Furthermore, if there exists $\bar{h}_\star \in \overline{\mathcal{U}}_p$ such that

- \bar{f}_\star and \bar{h}_\star intersect as in case 1 and $\bar{f}_\star \dot{\succ}_p \bar{h}_\star$ (resp. $\bar{h}_\star \dot{\succ}_p \bar{f}_\star$),
- \bar{g}_\star and \bar{h}_\star intersect as in case 1 and $\bar{h}_\star \dot{\succ}_p \bar{g}_\star$ (resp. $\bar{g}_\star \dot{\succ}_p \bar{h}_\star$),

then necessarily $\widehat{\Sigma}_f^\perp \subset \widehat{\Sigma}_g^\perp$ (resp. $\widehat{\Sigma}_g^\perp \subset \widehat{\Sigma}_f^\perp$). If moreover $\widehat{\Sigma}_f^\perp = \widehat{\Sigma}_g^\perp$, then we set $\bar{f}_\star \dot{\succ}_p \bar{g}_\star$ (resp. $\bar{g}_\star \dot{\succ}_p \bar{f}_\star$).

If $\widehat{\Sigma}_f^\perp = \widehat{\Sigma}_g^\perp$ and no such $\bar{h}_\star \in \overline{\mathcal{U}}_p$ exists, we set $\bar{f}_\star \dot{\succ}_p \bar{g}_\star$ if \bar{f}_\star is bounded by the forward corner in \mathfrak{c} , and $\bar{g}_\star \dot{\succ}_p \bar{f}_\star$ otherwise.²⁹

It is not a priori clear that $\dot{\succ}$ is coherent at $p \in \Delta_{\text{sa}}^{\text{pure}}$ in case 1, since f and g can locally intersect along a *disconnected* set. This corresponds to the situation that we now describe. Let us pick local coordinates (x, y, z) about p adapted to η such that the stable branches at p are contained in $\{x = 0\}$ and the unstable branches at p are contained in $\{y = 0\}$. In these coordinates, we identify f and g with the graphs of two functions, still denoted by f and g , over domains $D_f, D_g \subset \mathbb{R}_{x,y}^2$. After possibly shrinking the coordinate neighborhood of p , we further assume

$$\begin{aligned} D_f &= \{-\epsilon < x < 0\} \cup \{-\epsilon < y < 0\}, \\ D_g &= \{0 < x < \epsilon\} \cup \{0 < y < \epsilon\}, \end{aligned}$$

for some $\epsilon > 0$. Moreover, f and g continuously extend to 0 along $\{x = 0\} \cup \{y = 0\}$. Writing

$$\begin{aligned} Q_- &:= \{0 < x < \epsilon, -\epsilon < y < 0\}, \\ Q_+ &:= \{-\epsilon < x < 0, 0 < y < \epsilon\}, \end{aligned}$$

we have

$$D_f \cap D_g = Q_- \sqcup Q_+,$$

and this set is *disconnected*. We choose arbitrary points $x_- \in Q_-$ and $x_+ \in Q_+$, and we set $f \prec_\pm g$ if one of the following holds:

- $f|_{Q_\pm} \leq g|_{Q_\pm}$ and $f|_{Q_\pm} \neq g|_{Q_\pm}$,
- $f|_{Q_\pm} = g|_{Q_\pm}$, and $(f, x_\pm) \prec (g, x_\pm)$.

Otherwise, we set $g \prec_\pm f$. In the latter case, $g|_{Q_\pm} \leq f|_{Q_\pm}$ and $(g, x_\pm) \prec (f, x_\pm)$ if $f|_{Q_\pm} = g|_{Q_\pm}$, since f and g are forward envelopes and $(f, x_\pm) \not\approx (g, x_\pm)$. Moreover, when $f|_{Q_\pm} = g|_{Q_\pm}$, (f, x_\pm) and (g, x_\pm) are comparable by \prec^{geo} or \prec^{cor} , and in the latter case their initial corner over overlap c_\pm bounds Q_\pm . See Figure 18. The coherence at p of the relation $\dot{\succ}$ between \bar{f} and \bar{g} can be stated as follows:

Lemma 7.13. *$f \prec_- g$ if and only if $f \prec_+ g$.*

²⁹Alternatively, we could use the forward corner at p not in \mathfrak{c} . This choice has to be the same for all completed forward envelopes at p , but it does not need to be the same for all pure saddle singularities.

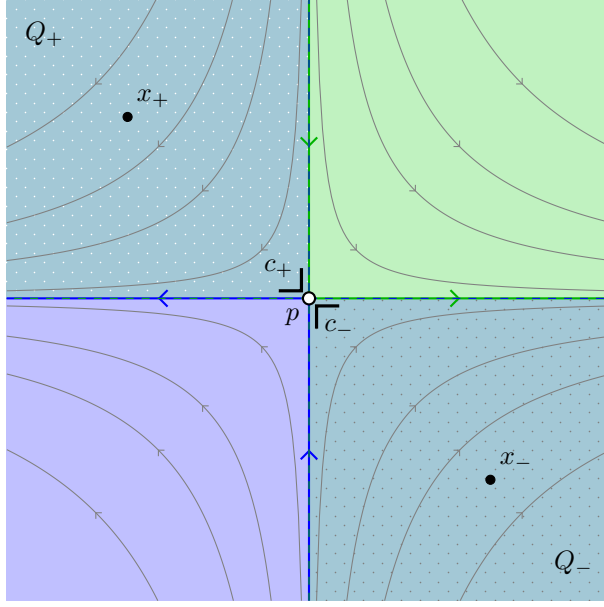

Figure 18: Overlap of f and g near p . The blue region corresponds to D_f , the green region corresponds to D_g , and their overlap is in teal. The quadrant with gray dots represents Q_- while the quadrant with white dots represents Q_+ .

Proof. Without loss of generality, we assume $c_+ \in \mathbf{c}$. By sliding marked points to the corners and completing, we obtain sections $\widehat{\Sigma}_f(c_\pm), \widehat{\Sigma}_g(c_\pm) \subset \mathcal{A}_p$ as in Section 7.2.3. Because of the shape of backward tiles passing through p and of the flow of X near p , one easily shows

$$\widehat{\Sigma}_f(c_-) = \widehat{\Sigma}_f(c_+), \quad \widehat{\Sigma}_g(c_-) = \widehat{\Sigma}_g(c_+). \quad (7.7)$$

Moreover, if $\widehat{\Sigma}_f(c_-) \subset \widehat{\Sigma}_g(c_-)$ then $f|_{Q_-} \leq g|_{Q_-}$ (and similarly for f and g swapped and for c_+). Indeed, we consider two cases.

1. There exists $y_- \in Q_-$ such that $\Sigma_f(y_-) \neq \emptyset$. Then every backward tile in $\Sigma_f(y_-)$ intersects $\{x = y = 0\}$ and is geometrically below f . If it passes through 0, then it induces an element in $\widehat{\Sigma}_f(c) \subset \widehat{\Sigma}_g(c)$, and this tile is also geometrically below g over Q_- , implying $f(y'_-) \leq g(y'_-)$ for every $y'_- \in Q_-$ in the forward region of Q_- containing y_- by the definition of one-dimensional envelopes (see [BI08, Section 5]). Moreover, for every $y'_- \in Q_-$ in the backward region of Q_- containing y_- , $\Sigma_f(y'_-) \neq \emptyset$ and the same argument shows that $f(y_-) \leq g(y_-)$. Therefore, $f|_{Q_-} \leq g|_{Q_-}$.
2. Otherwise, $\Sigma_f(y_-) = \emptyset$ for every $y_- \in Q_-$. Then no tile in $\widehat{\Sigma}_f(c_-)$ intersects $Q_- \times (-\epsilon, \epsilon)$, and f is necessarily geometrically below g over Q_- . Indeed, $f|_{Q_-}$ coincides with the restriction to Q_- of (the underlying tile of) the forward envelope starting at $((\epsilon/2, 0), \emptyset)$ which is geometrically the lowest such tile.

We now show:

$$\widehat{\Sigma}_g(c_\pm) \subset \widehat{\Sigma}_f(c_\pm) \implies g \prec_\pm f, \quad (7.8)$$

$$\widehat{\Sigma}_f(c_\pm) \subsetneq \widehat{\Sigma}_g(c_\pm) \implies f \prec_\pm g, \quad (7.9)$$

which will immediately imply the desired result. To show (7.8), we assume $\widehat{\Sigma}_g(c_\pm) \subset \widehat{\Sigma}_f(c_\pm)$ and we consider the order for f and g with respect to \prec_- .

1. $f|_{Q_-} \neq g|_{Q_-}$. Then since $g|_{Q_-} \leq f|_{Q_-}$ by the above argument, $g \prec_- f$.
2. $f|_{Q_-} = g|_{Q_-}$. Then $f_\star = (f, x_-)$ and $g_\star = (g, x_-)$ are comparable by either \prec^{geo} or \prec^{cor} . First, for every $y_- \in Q_-$, $\Sigma_g(y_-) \subset \Sigma_f(y_-)$. Otherwise, there would exist a marked backward tile $a_\star \in \Sigma_g(y_-) \setminus \Sigma_f(y_-)$ which would geometrically coincide with f and g over Q_- , since $f \leq a \leq g$ over Q_- by elementary properties of one-dimensional envelopes and their shadows (see [BI08, Section 5]). However, sliding the marked point of a_\star to the singularity at c_- would produce a marked tile in $\widehat{\Sigma}_g(c_-) \setminus \widehat{\Sigma}_f(c_-)$, a contradiction. This implies that if f_\star and g_\star are comparable by \prec^{geo} , then $g_\star \prec^{\text{geo}} f_\star$. Otherwise, f_\star and g_\star are comparable by \prec^{cor} and since $c_- \notin \mathfrak{c}$, we have $g_\star \prec^{\text{cor}} f_\star$ independently of the geometric (in)coherence of f_\star and g_\star at c_- .

Notice that the same argument applies to \prec_+ , since $c_+ \in \mathfrak{c}$ so the order \prec^{cor} for geometrically coherent forward envelopes meeting at c_+ compared to c_- is reversed. Here, the choice of admissible corners ‘twisting’ \prec^{cor} in the geometrically coherent case is essential.

The proof of (7.9) is the same up to swapping f and g , and the geometrically coherent case for \prec^{cor} does not arise. \square

It is now rather straightforward to check that the collection of relations $\{\dot{\succ}_p\}_{p \in M}$ induces a relation $\dot{\succ}$ on $\overline{\mathcal{U}}_\star$ which is coherent along intersections. This implies that $\dot{\succ}$ satisfies the axioms of Definition 5.8 since $\dot{\succ}$ does; the details are left to the reader. To summarize, we obtain:

Proposition 7.14. *The set $\overline{\mathcal{U}}$ of completed forward envelopes equipped with $\dot{\succ}$ is a weak prefoliation. It extends $(\mathcal{U}, \dot{\succ})$ and covers M .*

8 Proof of Proposition 5.11

Let $(\mathcal{A}, \dot{\succ}^{\mathcal{A}})$ be a (possibly empty) complete and backward weak prefoliation. In the previous sections, we constructed a complete and forward weak prefoliation $(\overline{\mathcal{U}}, \dot{\succ})$ which covers M . Our construction depends on auxiliary choices that are omitted from the notations. To construct an extension $\mathcal{A} \hookrightarrow \mathcal{B}$, we proceed in two steps.

1. First, we construct a weak prefoliation structure on $\mathcal{A} \cup \overline{\mathcal{U}}$ such that the inclusion $\mathcal{A} \hookrightarrow \mathcal{A} \cup \overline{\mathcal{U}}$ is an extension.
2. Then, we construct an extension $\mathcal{A} \cup \overline{\mathcal{U}} \hookrightarrow \mathcal{B}$ by gluing the edges and corners of tiles in \mathcal{A} to suitable completed forward envelopes (the *upper neighbors*), while keeping copies of completed forward envelopes.

8.1 First extension

We define a relation $\dot{\succ}^{\cup}$ on $\mathcal{A} \cup \overline{\mathcal{U}}$ by adapting [BI08, Section 6.13] and the proof of [BI08, Proposition 4.12]. It restricts to $\dot{\succ}^{\mathcal{A}}$ on \mathcal{A}_\star and to $\dot{\succ}$ on $\overline{\mathcal{U}}_\star$. We define $\dot{\succ}_p^{\cup}$ in two steps. The first one is of a geometric nature, while the second one is purely formal.

8.1.1 Step 1: geometric extension

Let $p \in M$, $f_\star \in \mathcal{A}_p$, and $\bar{u}_\star \in \overline{\mathcal{U}}_p$. Here, \bar{u} is the completion of a forward envelope $u \in \mathcal{U}$, $u : U \rightarrow M$ with shadow Σ .

We first use the shadow Σ and the geometric order to define a relation $\dot{\succ}_p^{\cup_0}$:

- If the marked point $a \in \bar{U}$ of \bar{u}_* belongs to U , we set $f_* \lesssim_p^{\cup_0} \bar{u}_*$ if $f_* \in \Sigma(a)$, and $\bar{u}_* \lesssim_p^{\cup_0} f_*$ otherwise.
- If $a \in \bar{U} \setminus U$ and one of f_* or \bar{u}_* is locally strictly above the other, their relation with respect to $\lesssim_p^{\cup_0}$ is defined as to match the geometric order.

We then extend \lesssim^{\cup_0} along intersections at certain boundary components of \bar{U} in a coherent way. More precisely, suppose that there exists a continuous path $\gamma : [0, 1] \rightarrow \bar{U}$ starting at $a \in \bar{U} \setminus U$ which lifts to f_* so that f and \bar{u} are comparable by \lesssim^{\cup_0} at $p' = f \circ \gamma(1)$ by Step 1, after sliding the marked points along γ and its lift. We define the relation between f_* and \bar{u}_* with respect to $\lesssim_p^{\cup_0}$ as to match the one with respect to $\lesssim_{p'}^{\cup_0}$ after sliding the marked points. Notice that this step applies if the marked point of \bar{u}_* belongs to an edge connected to the initial edge of u via a (double) corner, and this (double) corner lifts to f .

This defines a relation \lesssim^{\cup_0} on $\mathcal{A}_* \cup \overline{\mathcal{W}}_*$ that restricts to $\lesssim^{\mathcal{A}}$ on \mathcal{A}_* and to \lesssim on $\overline{\mathcal{W}}_*$. By definition, it is coherent along intersections and is compatible with the geometric order. Moreover, it satisfies the following ‘pseudo-transitivity’ property:

Lemma 8.1. *Let $a_*, b_*, c_* \in \mathcal{A}_* \cup \overline{\mathcal{W}}_*$. If $a_* \lesssim^{\cup_0} b_*$, $b_* \lesssim^{\cup_0} c_*$, and a_* and c_* are comparable by \lesssim^{\cup_0} , then $a_* \lesssim^{\cup_0} c_*$.*

Proof. Let $p \in M$ and consider $a_*, b_*, c_* \in \mathcal{A}_p \cup \overline{\mathcal{W}}_p$ such that $a_* \lesssim_p^{\cup_0} b_*$, $b_* \lesssim_p^{\cup_0} c_*$, and a_* and c_* are comparable by $\lesssim_p^{\cup_0}$. The case $p \in M^{\text{mm}}$ is immediate. We then assume that $p \in M^{\text{pure}}$ and we consider three cases, depending on the nature of the flow line γ of X passing through p .

1. γ is not connected to a singularity of X . Notice that if $f_* \in \mathcal{A}_p$ and $\bar{u}_* \in \overline{\mathcal{W}}_p$ are comparable by $\lesssim_p^{\cup_0}$, and if they only overlap along γ , then the marked point of \bar{u}_* necessarily belongs to the initial edge of u . Then, by considering all the possible cases depending on whether the three marked tiles belong to \mathcal{A}_p or $\overline{\mathcal{W}}_p$, it is easy to check that $a_* \lesssim_p^{\cup_0} c_*$.
2. γ is connected to a single singularity of X , which is not itself connected to a saddle singularity. This case is slightly more complicated because of the following: if $f_* \in \mathcal{A}_p$ and $\bar{u}_* \in \overline{\mathcal{W}}_p$ are comparable by $\lesssim_p^{\cup_0}$, and if they only overlap along a (concave or convex) corner c containing γ , then the marked point of \bar{u}_* belongs to one of the edges at c , but not necessarily to the initial edge of u .

Let us consider the following particular case: $a_* = \bar{u}_* \in \overline{\mathcal{W}}_p$, $b_* = f_* \in \mathcal{A}_p$, and $c_* = \bar{v}_* \in \overline{\mathcal{W}}_p$. Moreover, the marked point of f_* belongs to a concave corner on in the boundary of f , the marked point of \bar{u}_* belongs to the domain of u , but the marked point of \bar{v}_* does not belong to the domain of v . Arguing as in the proof of Lemma 8.4, we have that \bar{u}_* is locally geometrically below \bar{v}_* . If they locally coincide, we can slide the marked points inside the forward domain of overlap of u and v , and compare them there. They would be comparable by either \prec^{geo} , or by \prec^{cor} and would be geometrically noncoherent at their initial corner of overlap. Both situations yield $\bar{u}_* \lesssim \bar{v}_*$ as desired.

The other cases can be treated in a similar way.

3. γ is connected to a saddle singularity of X which is itself connected to another saddle singularity. This case is more tedious than the previous one, but can be treated in a similar way. The details are left to the reader.

We are now left with the case where p is a pure saddle or a quadratic-like singularity. This includes the case of a saddle connected to another saddle singularity.

Let us consider the following particular case: $p \in \Delta_{\text{sa}}^{\text{pure}}$ is not connected to another saddle singularity, $a_\star = \bar{u}_\star \in \overline{\mathcal{W}}_p$, $b_\star = f_\star \in \mathcal{A}_p$, and $c_\star = \bar{v}_\star \in \overline{\mathcal{W}}_p$. Moreover, the marked point of f_\star belongs to a concave corner on in the boundary of f , and \bar{u}_\star and \bar{v}_\star overlap with f_\star near p along two different edges. Then using the notations of Section 7.3.3, $f_\star \in \widehat{\Sigma}_v^{\text{L}} \setminus \widehat{\Sigma}_u^{\text{L}}$, hence $\widehat{\Sigma}_u^{\text{L}} \subsetneq \widehat{\Sigma}_v^{\text{L}}$ and $\bar{u}_\star \lesssim_p^{\text{U}} \bar{v}_\star$.

The remaining cases can be treated in a similar way, and the details are left to the reader. \square

8.1.2 Step 2: abstract extension

Even after the previous step, the relation $\lesssim_p^{\text{U}\circ}$ between f_\star and \bar{u}_\star might still remain undefined if the marked points of f_\star and \bar{u}_\star both belong to certain edges, or if they are singularities at certain corners intersecting along edges only. We proceed in three steps:

1. Let us first assume that p belongs to a pure flow line of X which is not connected to any singularity of X . We extend $\lesssim^{\text{U}\circ}$ at p by the following abstract procedure:

- If there exists $a_\star \in \mathcal{A}_p \cup \overline{\mathcal{W}}_p$ such that $f_\star \lesssim_p^{\text{U}\circ} a_\star$ and $a_\star \lesssim_p^{\text{U}\circ} \bar{u}_\star$, we set $f_\star \lesssim_p^{\text{U}} \bar{u}_\star$.
- Otherwise, we set $\bar{u}_\star \lesssim_p^{\text{U}} f_\star$.

By Lemma 8.1, this definition ensures that \lesssim_p^{U} is a total preorder on $\mathcal{A}_p \cup \overline{\mathcal{W}}_p$.

2. We now assume that p belongs to a connection between two saddle singularities $q_\pm \in \Delta_{\text{sa}}$. By sliding the marked points towards q_\pm along this connection, we obtain injections

$$\varsigma_\pm : \mathcal{A}_p \cup \overline{\mathcal{W}}_p \longrightarrow \mathcal{A}_{q_\pm} \cup \overline{\mathcal{W}}_{q_\pm}$$

which preserve $\lesssim^{\text{U}\circ}$. We modify the previous abstract procedure to extend $\lesssim^{\text{U}\circ}$ on $\mathcal{A}_p \cup \overline{\mathcal{W}}_p$. With the same notations as before, we set $f_\star \lesssim_p^{\text{U}} \bar{u}_\star$ if one of the following holds:

- There exists $a_\star \in \mathcal{A}_p \cup \overline{\mathcal{W}}_p$ such that $f_\star \lesssim_p^{\text{U}\circ} a_\star$ and $a_\star \lesssim_p^{\text{U}\circ} \bar{u}_\star$.
- There exists $a_\star^\pm \in \mathcal{A}_{q_\pm} \cup \overline{\mathcal{W}}_{q_\pm}$ such that $\varsigma_\pm(f_\star) \lesssim_{q_\pm}^{\text{U}\circ} a_\star^\pm$ and $a_\star^\pm \lesssim_{q_\pm}^{\text{U}\circ} \varsigma_\pm(\bar{u}_\star)$.

Otherwise, we set $\bar{u}_\star \lesssim_p^{\text{U}} f_\star$. We further coherently extend \lesssim^{U} along the flow line of X passing through p and at q_\pm by sliding the marked points along this flow line. As in the previous item, Lemma 8.1 ensures that \lesssim_p^{U} is a total preorder on $\mathcal{A}_p \cup \overline{\mathcal{W}}_p$.

3. Finally, we assume that $p \in \Delta_{\text{sa}} \cup Q$ is a saddle or quadratic singularity. We use the same abstract procedure as in the first item to extend \lesssim^{U} at p , taking into account the extension in step 2 if p is connected to another saddle singularity. As before, this yields a total preorder \lesssim_p^{U} on $\mathcal{A}_p \cup \overline{\mathcal{W}}_p$. We then extend \lesssim^{U} by coherence along the pure stable and unstable branches at p (no extension is needed along a connection to another saddle singularity).

It is now rather straightforward to prove:

Lemma 8.2. *The set $\mathcal{A} \cup \overline{\mathcal{W}}$ equipped with the relation \lesssim^{U} is a weak prefoliation which extends $(\mathcal{A}, \lesssim^{\mathcal{A}})$.*

Proof. Left to the reader. \square

8.2 Second extension

We now define an extension $\mathcal{A} \cup \overline{\mathcal{U}} \hookrightarrow \mathcal{B}$ by adapting the strategy of the proof of [BI08, Proposition 4.11]. To that extent, we define a similar notion of *upper neighbors* along the edges of tiles in \mathcal{A} (see [BI08, Definition 4.10]), and we extend every such tile by attaching its upper neighbors to its boundary components. We also keep copies of tiles in $\overline{\mathcal{U}}$ to ensure that \mathcal{B} covers M . We then define a weak prefoliation structure on \mathcal{B} in a purely formal way. As before, we will need to treat the corners with particular care.

8.2.1 Typology of backward corners

Let $f : U \rightarrow M$ be a complete backward tile. We denote by \mathcal{B} the set of boundary components of U , and by \mathcal{E} the set of edges of U . A boundary component of U contains between one and three edges. Two edges $e_0, e_1 \in \mathcal{E}$ are **adjacent** if $c = (f(e_0), f(e_1))$ is a (backward or forward) corner in M . Note the importance of the order. We further distinguish two cases:

- The singularity at c is a pure saddle singularity. If c is a backward (resp. forward) corner, we say that (e_0, e_1) is a **pure convex (resp. concave) corner** of U (or f).
- The singularity at c is a quadratic-like singularity. If c is a backward (resp. forward) corner, we say that (e_0, e_1) is an **unstable convex (resp. concave) corner** of U (or f).

These four types of backward corners are illustrated in Figure 19.

We say that (e_0, e_1) is an **adjoining pair of edges** if it is either a pure concave corner or an unstable (convex or concave) corner of f . If $e_2 \in \mathcal{E}$ and both (e_0, e_1) and (e_1, e_2) are adjoining pairs of edges, we call (e_0, e_1, e_2) an **adjoining triple of edges**. We define a **boundary row** of U (or f) as either

1. A single edge which is not part of an adjoining pair,
2. An adjoining pair of edges which is not part of an adjoining triple, or
3. An adjoining triple of edges.

We denote by \mathcal{R} the set of boundary rows of f . Since every edge is included in a row, and every row is included in a boundary component, we have natural surjections $\mathcal{E} \twoheadrightarrow \mathcal{R} \twoheadrightarrow \mathcal{B}$.

We also define a collection of **distinguished edges** as follows. Each boundary row r contains exactly one distinguished edge, and moreover,

- If r is an adjoining pair of edges forming a forward corner c , then the last edge of r is distinguished if $c \notin \mathfrak{c}$, and the first one is if $c \in \mathfrak{c}$. Recall that \mathfrak{c} denotes the chosen admissible collection of forward corners in the definition of the weak prefoliation structure on \mathcal{U} .
- If r is an adjoining triple of edges, the last edge of r is distinguished.

We denote by $\mathcal{E}^\bullet \subset \mathcal{E}$ the set of distinguished edges of f . A row made of a single edge will be called a **trivial row**, in which case this edge is automatically distinguished.

We now explain the relevance of these definitions. Any complete forward tile intersecting a distinguished edge of f will also intersect all the other edges of f in the same boundary row. Moreover, if it starts at such an edge, it will not intersect edges of f in different boundary rows. We leave it to the reader to draw the corresponding pictures. Therefore, we have to be careful to define upper neighbors at edges of f that are ‘coherent’ along corners at adjoining edges.

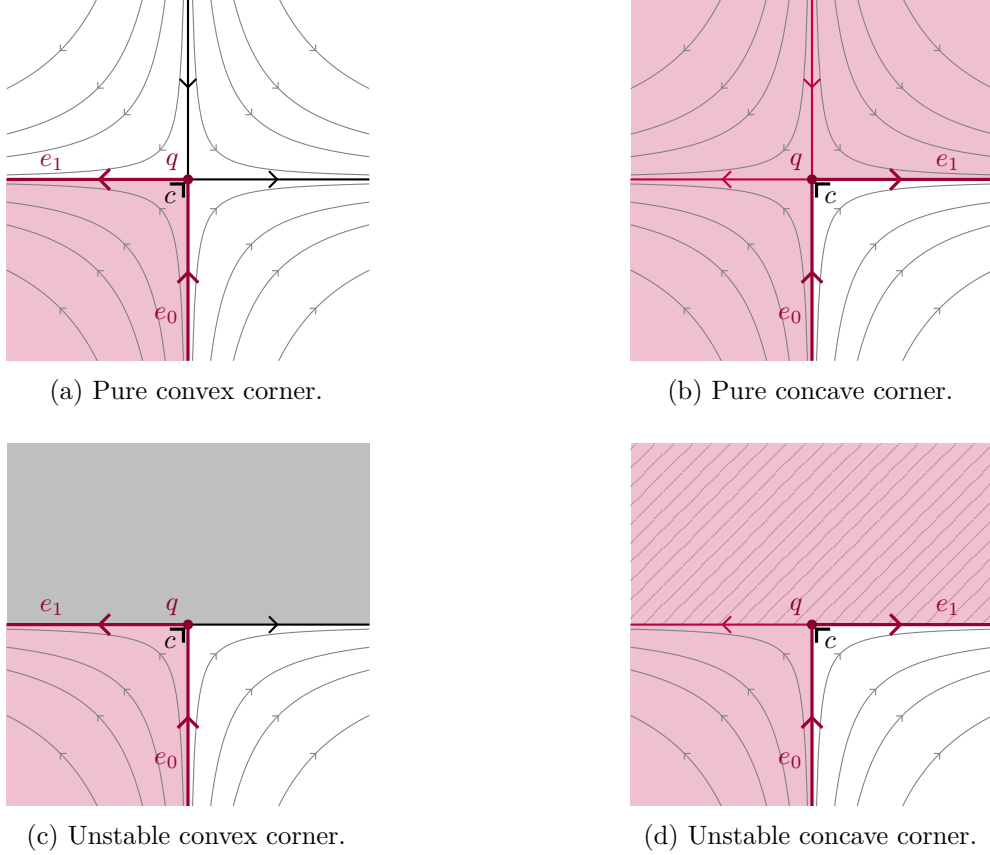

Figure 19: The four types of corners of backward tiles.

8.2.2 Upper neighbors

Let $p \in M^{\text{pure}}$, $f_\star \in \mathcal{A}_p$, $\bar{u}_\star \in \mathcal{U}_p$, and assume that the marked points of f_\star and \bar{u}_\star belong to edges of the respective domains for f and \bar{u} . Following [BI08, Definition 4.10], we say that \bar{u}_\star is an **upper neighbor** of f_\star in $(\mathcal{A} \cup \overline{\mathcal{U}}, \lesssim^\cup)$ if $f_\star \prec_p^\cup \bar{u}_\star$, and \bar{u}_\star is the lowest such element in $\mathcal{A}_p \cup \overline{\mathcal{U}}_p$, i.e.,

$$\forall g_\star \in \mathcal{A}_p \cup \overline{\mathcal{U}}_p, \quad f_\star \prec_p^\cup g_\star \implies \bar{u}_\star \lesssim_p^\cup g_\star. \quad (8.1)$$

Lemma 8.3. *With the previous notations, f_\star admits an upper neighbor which is unique up to order-equivalence.*

Proof. The uniqueness immediately follows from the definition. To show existence, we consider the section $\Sigma_0 \subset \mathcal{A}_p$ defined by

$$\Sigma_0 := \{g_\star \in \mathcal{A}_p \mid g_\star \lesssim_p^{\mathcal{A}} f_\star\}. \quad (8.2)$$

If p does not belong to the pure stable branch of a quadratic-like singularity, we define \bar{u}_\star as the forward envelope starting at (p, Σ_0) and with marked point corresponding to the initial basepoint of \bar{u} . We emphasize that this forward envelope might *not* be the upper neighbor of f_\star . However, we claim that if the marked point of f_\star belong to the *distinguished edge* of a boundary row r , then \bar{u}_\star is the upper neighbor of f_\star . To prove this, we consider three cases.

1. r is a trivial row. By definition of \lesssim^\cup in Step 1 of the previous section, $f_\star \lesssim^\cup \bar{u}_\star$. Then, let $g_\star \in \mathcal{A}_p \cup \overline{\mathcal{U}}_p$ such that $f_\star \prec_p^\cup g_\star$. We consider two cases:

- $g_\star \in \mathcal{A}_p$. Then $g_\star \notin \Sigma_0$, so $\bar{u}_\star \lesssim_p^\cup g_\star$ by definition.
- $g_\star = \bar{v}_\star \in \overline{\mathcal{W}}_p$. By definition, there exists $\bar{w}_\star \in \overline{\mathcal{W}}_p$ such that $f_\star \lesssim_p^\cup \bar{w}_\star \lesssim_p^\cup \bar{v}_\star$, and the marked point z of \bar{w} belongs to the domain of w . We must have $f_\star \in \Sigma_w(z)$, otherwise \bar{w}_\star would be locally geometrically below f_\star , so $\Sigma_0 \subset \Sigma_w(z)$. If this inclusion is strict, then $u_\star \prec_p^{\text{geo}} w_\star$ and $\bar{u}_\star \prec_p \bar{w}_\star$, hence $\bar{u}_\star \lesssim_p^\cup \bar{w}_\star \lesssim_p^\cup \bar{v}_\star$. If $\Sigma_0 = \Sigma_w(z)$, then $u_\star \prec_p^{\text{inc}} w_\star$, hence $\bar{u}_\star \lesssim_p^\cup \bar{v}_\star$ as well.

2. $r = (e_0, e_1)$ is an adjoining pair of edges. We first assume that the corresponding corner c is a pure forward corner. Let $g_\star \in \mathcal{A}_p \cup \overline{\mathcal{W}}_p$ such that $f_\star \prec^\cup g_\star$. As in the previous case, $g_\star \in \mathcal{A}_p$ implies $\bar{u}_\star \prec_p^\cup g_\star$. The case $g_\star \in \overline{\mathcal{W}}_p$ is slightly more complicated. As before, there exists $\bar{w}_\star \in \overline{\mathcal{W}}_p$ such that $f_\star \lesssim_p^\cup \bar{w}_\star \lesssim_p^\cup \bar{v}_\star$. However, the marked point if \bar{w}_\star might not belong to the domain of w . If it does, then the previous argument still implies $\bar{u}_\star \lesssim_p^\cup \bar{w}_\star$. Otherwise, we slide the marked point of \bar{w}_\star along c , and the new marked point z' now belongs to the domain of w . We also slide the marked point of f_\star along c to get a new tile f'_\star passing through $p' := w(z')$. We also define the corresponding section

$$\Sigma'_0 := \{g'_\star \in \mathcal{A}_{p'} \mid g'_\star \lesssim_{p'}^{\mathcal{A}} f'_\star\}$$

so that $\Sigma'_0 \subset \Sigma_w(z')$. If this inclusion is strict, then $\widehat{\Sigma}_u(c) \subsetneq \widehat{\Sigma}_w(c)$, implying $\bar{u}_\star \lesssim_p^\cup \bar{w}_\star$. If $\Sigma'_0 = \Sigma_w(z')$, then the definitions of \prec^{cor} and distinguished edges imply $\bar{u}_\star \lesssim_p^\cup \bar{w}_\star$ as well.

The cases where c is a (forward or backward) quadratic-like corner is simpler since no forward envelope starts at the pure stable branch of the corresponding singularity. The details are left to the reader.

3. $r = (e_0, e_1, e_2)$ is an adjoining triple of edges. There are multiple cases to consider depending on the nature of the corners corresponding to (e_0, e_1) and to (e_1, e_2) , but all of these cases can be treated as in case 2. The details are left to the reader.

If the marked point of f_\star does not belong to a distinguished edge, we consider the previously constructed upper neighbor at (a point on) the distinguished edge in r , and we slide the marked point along the corner(s) to obtain a marked tile at p . By the previous arguments, it is easy to check that the latter is the upper neighbor of f_\star . \square

We emphasize that by construction, the upper neighbors of $f \in \mathcal{A}$ satisfy the following coherence condition along boundary rows. Let (e_0, e_1) be an adjoining pair of edges for f forming a corner c in M , and $x_0 \in e_0, x_1 \in e_1$ be two boundary marked points. We denote by \bar{u}_\star^0 and \bar{u}_\star^1 the upper neighbors of (f, x_0) and (f, x_1) , respectively. Then:

Lemma 8.4. *Up to order-equivalence, \bar{u}_\star^0 and \bar{u}_\star^1 differ by sliding the marked point along c .*

Therefore, each boundary row $r \in \mathcal{R}$ of f determines a completed forward envelope $\bar{u}^r \in \overline{\mathcal{W}}$, unique up to forward-equivalence, such that the upper neighbor of f for a marked point on an edge of r is \bar{u}^r , with a suitable marked point on the boundary component of the initial edge of u^r . Importantly, gluing \bar{u}^r to f along r yields a tile.

Remark 8.5. *Assume that $p \in M^{\text{pure}}$ belongs to a closed orbit γ of X with period $T > 0$, and $\bar{u}_\star \in \overline{\mathcal{W}}_p$ is the upper neighbor of $f_\star \in \mathcal{A}_p$. In that case, p belongs to the initial edge of u . Assume that $\bar{u}_\star^T \simeq_p \bar{u}_\star$, where we use the notation from Section 6.1 for the T -translation. Then $u_\star^T \simeq_p u_\star$ and $\Phi^T(\Sigma_0) = \Sigma_0$, where Σ_0 is defined by (8.2). It immediately follows that $f_\star^T \simeq_p f_\star$. Reciprocally, if $f_\star^T \simeq_p f_\star$ then $\Phi^T(\Sigma_0) = \Sigma_0$ and $u_\star^T \simeq_p u_\star$ by the uniqueness of forward envelopes (see Proposition 6.16), hence $\bar{u}_\star^T \simeq_p \bar{u}_\star$.*

To summarize, the upper neighbor of a tile f_\star in \mathcal{A}_p is order-equivalent to its T -translation if and only if f_\star is. However, it is possible that $f_\star^T \approx_p f_\star$ without $f_\star^T \simeq_p f_\star$ (f is geometrically covering itself, but not from the viewpoint of the preorder), in which case we might not even have $\bar{u}_\star^T \approx_p \bar{u}_\star$. This is because our preorders contain strictly more information than the geometric order.

8.2.3 Gluing upper neighbors

We now define a complete and backward weak prefoliation \mathcal{B} extending $\mathcal{A} \cup \overline{\mathcal{U}}$ by gluing the upper neighbors to the backward edges of the tiles in \mathcal{A} , while keeping copies of the tiles in $\overline{\mathcal{U}}$. More precisely, to each tile $f \in \mathcal{A}$ we associate a new tile \tilde{f} defined as follows. If f has no edge, we set $\tilde{f} = f$. Otherwise, for each $e \in \mathcal{E}^\bullet$, we choose a point $x_e \in e$ and write $p_e := f(x_e)$. Then, we denote by $\bar{u}_e \in \overline{\mathcal{U}}_{p_e}$ the upper neighbor of (f, x_e) . It can be glued to f along the row of edges containing e . Recall that by Lemma 8.4 above, the upper neighbor of f at adjoining edges to e coincides with \bar{u}_e with a slid marked point. We then define \tilde{f} as the complete and forward tile obtained by gluing *all* such upper neighbors along the (rows of) edges of f , without repetitions. By construction, there is a natural embedding φ_f of the domain of f into the domain of \tilde{f} as in Definition 5.10.

We now define

$$\tilde{\mathcal{A}} := \{\tilde{f} \mid f \in \mathcal{A}\}, \quad \mathcal{B} := \tilde{\mathcal{A}} \cup \overline{\mathcal{U}}.$$

It comes with a natural map $i : \mathcal{A} \cup \overline{\mathcal{U}} \rightarrow \mathcal{B}$ which restricts to the identity on $\overline{\mathcal{U}}$. By construction, the tiles in \mathcal{B} are complete and forward, and they cover M . It remains to define a weak prefoliation structure $\lesssim^{\mathcal{B}}$ on \mathcal{B} making i an extension. To this end, we proceed as in the proof of [BI08, Proposition 4.11] in three steps.

1. We first define the restriction of $\lesssim^{\mathcal{B}}$ to $\tilde{\mathcal{A}}$. Let $\tilde{f}_\star \in \tilde{\mathcal{A}}_\star$, where $f \in \mathcal{A}$. We consider two cases:
 - (a) The marked point belongs to the domain of f . This induces a marked tile $f_\star \in \mathcal{A}_\star$.
 - (b) The marked point does not belong to the domain of f , but to the domain of a completed forward envelope $\bar{u} \in \overline{\mathcal{U}}$. This induces a marked tile $\bar{u}_\star \in \overline{\mathcal{U}}_\star$.

This allows us to define a ‘restriction’ map $\rho : \tilde{\mathcal{A}}_\star \rightarrow \mathcal{A}_\star \cup \overline{\mathcal{U}}_\star$ as

- $\rho(\tilde{f}_\star) = f_\star$ in case (a),
- $\rho(\tilde{f}_\star) = \bar{u}_\star$ in case (b).

Then, we define $\lesssim^{\mathcal{B}}$ on $\tilde{\mathcal{A}}$ as the pullback of \lesssim^{\cup} along ρ :

$$\forall \tilde{f}_\star, \tilde{g}_\star \in \tilde{\mathcal{A}}_\star, \quad \tilde{f}_\star \lesssim^{\mathcal{B}} \tilde{g}_\star \iff \rho(\tilde{f}_\star) \lesssim^{\cup} \rho(\tilde{g}_\star).$$

2. We now define $\lesssim^{\mathcal{B}}$ between elements $\tilde{f}_\star \in \tilde{\mathcal{A}}_\star$ and $\bar{v}_\star \in \overline{\mathcal{U}}_\star$. If $\rho(\tilde{f}_\star) = f_\star \in \mathcal{A}_\star$, we define the order between \tilde{f}_\star and \bar{v}_\star for $\lesssim^{\mathcal{B}}$ to match the one between f_\star and \bar{v}_\star for \lesssim^{\cup} . If $\rho(\tilde{f}_\star) = \bar{u}_\star \in \overline{\mathcal{U}}_\star$, we set

$$\begin{aligned} \tilde{f}_\star \lesssim^{\mathcal{B}} \bar{v}_\star &\iff \bar{u}_\star \dot{\lesssim} \bar{v}_\star, \\ \bar{v}_\star \lesssim^{\mathcal{B}} \tilde{f}_\star &\iff \bar{v}_\star \dot{\prec} \bar{u}_\star. \end{aligned}$$

That way, if $\bar{u}_\star \simeq \bar{v}_\star$, then $\tilde{f}_\star \prec^{\mathcal{B}} \bar{v}_\star$.

3. Finally, the restriction of $\lesssim^{\mathcal{B}}$ on $\overline{\mathcal{U}}_\star$ is defined to agree with $\dot{\lesssim}$.

By virtue of the properties of upper neighbors, it is rather mechanical exercise to check:

Lemma 8.6. *The set \mathcal{B} equipped with the relation $\preceq^{\mathcal{B}}$ is a weak prefoliation, and the map $i : \mathcal{A} \cup \overline{\mathcal{U}} \rightarrow \mathcal{B}$ is an extension.*

Proof. Left to the reader. □

8.3 Finishing the proof

We conclude the proof of Proposition 5.11. Starting from a complete and backward weak prefoliation \mathcal{A} , the desired forward extension $\mathcal{A} \hookrightarrow \mathcal{B}$ is obtained as the composition of the extensions $\mathcal{A} \hookrightarrow \mathcal{A} \cup \overline{\mathcal{U}}$ from Lemma 8.2 and $\mathcal{A} \cup \overline{\mathcal{U}} \hookrightarrow \mathcal{B}$ from Lemma 8.6. Finally, the case where \mathcal{A} is *forward* instead of backward is obtained by reversing the (co)orientation of η and applying the previous results. □

A Key ODE lemma

Let $D \subset \mathbb{R}^N$ be a compact subset of \mathbb{R}^N , for some integer N . We consider a smooth function

$$\begin{aligned} F : D \times \mathbb{R} \times \mathbb{R} &\longrightarrow \mathbb{R} \\ (x, y, t) &\longmapsto F(x, y, t) = F_x(y, t) \end{aligned}$$

satisfying

(C1) There exists $\epsilon > 0$ such that

$$\partial_y F_x \geq \epsilon,$$

(C2) There exists $C > 0$ such that for every $(x, y, t) \in D \times \mathbb{R} \times \mathbb{R}$,

$$|F_x(y, t) - F_x(y, 0)| \leq C.$$

We consider the following family of ODEs parametrized by $x \in D$:

$$(E_x) : \begin{cases} \dot{y}(t) = F_x(y(t), t), \\ y(0) = y_0. \end{cases}$$

In Part I, we repeatedly use of the following elementary lemma.

Lemma A.1. *For every $x \in D$, there exists a unique $y_0(x) \in \mathbb{R}$ such that the maximal solution to (E_x) with initial value $y_0(x)$ is defined on \mathbb{R} and is bounded. Moreover, the map*

$$\begin{aligned} y_0 : D &\longrightarrow \mathbb{R} \\ x &\longmapsto y_0(x) \end{aligned}$$

is continuous.

Proof. We first show the existence and uniqueness of $y_0 = y_0(x)$ for a fixed $x \in D$. We will write $F(y, t) = F_x(y, t)$ for simplicity. The solutions to (E_x) satisfy the two key properties:

(P1) If $y_0 < \tilde{y}_0$, and $y, \tilde{y} : [0, T] \rightarrow \mathbb{R}$ are solutions to (E_x) with initial values y_0 and \tilde{y}_0 , respectively, then

$$\forall t \in [0, T], \quad \tilde{y}(t) - y(t) \geq (\tilde{y}_0 - y_0) e^{ct}. \tag{A.1}$$

(P2) There exists $A > 0$ such that if $y : [-T, T] \rightarrow \mathbb{R}$ is a solution of (E_x) , then

$$\begin{aligned} y(t) > A &\implies \dot{y}(t) > 1, \\ y(t) < -A &\implies \dot{y}(t) < -1. \end{aligned}$$

Property (P1) easily follows from condition (C1). Under the hypothesis of (P1), we readily have

$$\forall t \in [0, T], \quad \tilde{y}(t) > y(t).$$

Then, writing $z(t) := \tilde{y}(t) - y(t)$, we have

$$\begin{aligned} \dot{z}(t) &= F(\tilde{y}(t), t) - F(y(t), t) \\ &= \int_{y(t)}^{\tilde{y}(t)} \partial_y F(y, t) dy \\ &\geq \epsilon(\tilde{y}(t) - y(t)) \\ &= \epsilon z(t), \end{aligned}$$

and (A.1) follows.

On the other hand, property (P2) easily follows from conditions (C1) and (C2). By condition (C1), $F(\cdot, 0) : \mathbb{R} \rightarrow \mathbb{R}$ is a strictly increasing diffeomorphism and there exists $A > 0$ such that

$$\begin{aligned} \forall y > A, \quad F(y, 0) &> C + 1, \\ \forall y < -A, \quad F(y, 0) &< -C - 1. \end{aligned}$$

Then, if $y(t) > A$,

$$\begin{aligned} \dot{y}(t) &= F(y, t) - F(y, 0) + F(y, 0) \\ &\geq -C + F(y, 0) \\ &> -C + C + 1 \\ &= 1. \end{aligned}$$

The other implication holds similarly. Here, we can further assume that A is independent of x by simply considering

$$A := \epsilon^{-1} \left(1 + C + \sup_{x \in D} |F_x(0, 0)| \right).$$

Notice that a solution y of (E_x) is defined for all negative times, and $|y|$ is bounded by $\max(A, |y_0|)$ on $\mathbb{R}_{\leq 0}$. However, such a solution might be unbounded on $\mathbb{R}_{\geq 0}$ and might blow up in finite time. We define

- $I_+ = I_+(x) \subset \mathbb{R}$ the set of $y_0 \in \mathbb{R}$ such that the solution y to (E_x) with initial value y_0 is *not* bounded from above on $\mathbb{R}_{\geq 0}$,
- $I_- = I_-(x) \subset \mathbb{R}$ the set of $y_0 \in \mathbb{R}$ such that the solution y to (E_x) with initial value y_0 is *not* bounded from below on $\mathbb{R}_{\geq 0}$.
- $I_0 = I_0(x) \subset \mathbb{R}$ the set of $y_0 \in \mathbb{R}$ such that the solution y to (E_x) with initial value y_0 is bounded on $\mathbb{R}_{\geq 0}$.

By definition, we have

$$\mathbb{R} = I_- \sqcup I_0 \sqcup I_+.$$

By property (P2), if $y_0 \in I_{\pm}$ then the corresponding solution y diverges to $\pm\infty$, possibly in finite time. Moreover, I_+ is of the form $[a_+, +\infty)$ or $(a_+, +\infty)$, I_- is of the form $(-\infty, a_-]$ or $(-\infty, a_-)$, and property (C1) implies that I_0 contains at most one point. It is therefore enough to show that I_{\pm} are open. Let $y_0 \in I_+$, and let y be the corresponding maximal solution, defined on $(-\infty, T)$ for some $0 < T \leq +\infty$. By definition of I_+ , there exists $0 < t_0 < T$ such that $y(t_0) > A$. By the continuous dependence of solutions to an ODE with respect to the initial value, there exists $\delta > 0$ such that for every $\tilde{y}_0 \in (y_0 - \delta, y_0 + \delta)$, the solution \tilde{y} to (E_x) with initial value \tilde{y}_0 also exists up to

time at least t_0 , and $\tilde{y}(t_0) > A$. Therefore, by property (P2), \tilde{y} diverges to $+\infty$ (possibly in finite time), and $\tilde{y}_0 \in I_+$. It follows that I_+ is open, and I_- is open for similar reasons.

We now have a well-defined map $x \in D \mapsto y_0(x)$, and we are left to show that it is continuous. Let $x \in D$. If $\tilde{y}_0 > y_0(x)$, then $\tilde{y}_0 \in I_+(x)$ and the maximal solution \tilde{y} to (E_x) with initial value \tilde{y}_0 diverges to $+\infty$, possibly in finite time. Hence, there exists $t_0 > 0$ such that $\tilde{y}(t_0)$ is defined and $\tilde{y}(t_0) > A + 1$. By the continuous dependence of solutions to a family of ODEs with respect to a parameter (the dependence on the parameter x is smooth), there exists an open neighborhood U of x in D such that for every $\tilde{x} \in U$, every maximal solution \tilde{y} to the ODE $(E_{\tilde{x}})$ with initial value \tilde{y}_0 is defined up to time at least t_0 and satisfies $\tilde{y}(t_0) > A$. Therefore, by property (P2), \tilde{y} diverges to $+\infty$ and $\tilde{y}_0 \in I_+(\tilde{x})$, so $\tilde{y}_0 > y_0(\tilde{x})$. To summarize, we have shown that for every $x \in D$ and every $\tilde{y}_0 > y_0(x)$, there exists an open neighborhood U of x in D such that for every $\tilde{x} \in U$, $\tilde{y}_0 > y_0(\tilde{x})$. This means that y_0 is upper semicontinuous, and it is lower semicontinuous for similar reasons. \square

The same methods also show that the map $y_0 : D \rightarrow \mathbb{R}$ depends continuously on F in the appropriate topology. More precisely, let F be as before, and let $(F_n)_{n \geq 1}$ be a sequence of smooth functions $F_n : D \times \mathbb{R} \times \mathbb{R} \rightarrow \mathbb{R}$ satisfying the following:

- For every $n \geq 1$, F_n satisfies conditions (C1) and (C2) for the same constants ϵ, C as F ,
- $(F_n)_{n \geq 1}$ converges to F in $\mathcal{C}_{\text{loc}}^\infty$.

We denote by (E_x^n) the family of ODEs corresponding to F_n .

Lemma A.2. *With the above notations, let $y_0^n : D \rightarrow \mathbb{R}$ denote the continuous map given by Lemma A.1 for F_n , $n \geq 1$. Then the sequence $(y_0^n)_{n \geq 1}$ converges uniformly to y_0 in the \mathcal{C}^0 topology.*

Proof. For $n \geq 1$, we denote by $y_n(x, t)$ the unique bounded maximal solution of (E_x^n) , so that $y_0^n(x) = y_n(x, 0)$. By the proof of Lemma A.1, there exists a constant $A > 0$, depending on ϵ and C but *not* on x nor n , such that

$$\forall n \geq 1, \forall t \in \mathbb{R}, \quad |y_n(x, t)| \leq A.$$

Let us assume by contradiction that $(y_0^n)_{n \geq 1}$ does not converge to y_0 . Up to passing to a subsequence, we can assume that there exists a sequence $(x_n)_{n \geq 1}$, $x_n \in D$, such that

- $(x_n)_{n \geq 1}$ converges to some $x_\infty \in D$,
- $(y_0^n(x_n))_{n \geq 1}$ converges to some $y_\infty \in \mathbb{R}$,
- $y_\infty \neq y_0(x_\infty)$.

Without loss of generality, we assume that $y_\infty > y_0(x_\infty)$. By the proof of Lemma A.1, the solution $\tilde{y} = \tilde{y}(t)$ of (E_{x_∞}) starting at y_∞ diverges to $+\infty$, possibly in finite time, so there exists $t_0 > 0$ such that $\tilde{y}(t_0) = A + 1$. Since F_n converges to F in $\mathcal{C}_{\text{loc}}^\infty$, the continuous dependence of solutions of a family of ODEs with respect to parameters implies that for $n \geq 1$ sufficiently large, $y_n(x_n, t_0) > A$, a contradiction. \square

B Taut plane fields

In this appendix, M still denotes a closed, oriented 3-manifold. We extend the definition of tautness to arbitrary continuous cooriented plane fields on M and show some equivalent characterizations. This generalization is motivated by the following two observations:

1. There exist several *non-equivalent* notions of tautness for \mathcal{C}^0 -foliations; see [CKR19]. The most robust one, *everywhere tautness*, can be phrased uniquely in terms of the tangent plane field of the foliation, i.e., it does not refer to the leaves.
2. For the purpose of translating properties of foliations into properties of contact structures and vice versa, it is convenient to work directly at the level of plane fields.

Definition B.1. A cooriented continuous plane field η on M is (*everywhere*) **taut** if for every $p \in M$, there exists a smooth closed curve transverse to η and passing through p .

Definition B.2. A **dead-end component** for η is a \mathcal{C}^1 , codimension-0 submanifold with boundary $N \subset M$ such that ∂N is tangent to η and the co-orientation of η points inwards along ∂N .

The next proposition is well-known if η is (uniquely) integrable, and most of the proof immediately extends to the general case.

Proposition B.3. Let η be a cooriented continuous plane field on M . The following are equivalent:

1. η is taut,
2. For all points $p, q \in M$, there exists a smooth curve from p to q positively transverse to η ,
3. There exists a (smooth, or \mathcal{C}^1) closed 2-form ω such that $\omega|_\eta > 0$,
4. There exists a (smooth, or \mathcal{C}^1) volume preserving vector field transverse to η ,
5. There exists a continuous Riemannian metric on M and a (smooth, or \mathcal{C}^1) closed 2-form ω which calibrates η ,
6. There are no dead-end components for η .

In particular, a surface tangent to η is a stable minimal surface for a Riemannian metric as in 5.

Proof. The implications

$$2 \implies 1 \implies 3 \iff 4 \iff 5 \implies 6$$

are standard and follow the same proofs as in the (uniquely) integrable case. We show $6 \implies 2$

Let $p_0 \in M$ and denote by $A_+ := A_+(p_0)$ the set of points $q \in M$ such that there exists a smooth curve from p_0 to q positively transverse to η . Let us assume that $A_+ \neq M$. We show that $N := \overline{A_+}$ is a dead-end component for η .

Since η is continuous, every point $q \in M$ has a neighborhood $U \cong D^2 \times (-1, 1)$ with smooth local coordinates (x, y, z) in which η is given by

$$\eta = \ker (dz + f dx + g dy),$$

for continuous functions $f, g : D^2 \times (-1, 1) \rightarrow \mathbb{R}$ with $f(0) = g(0) = 0$ and $|f|, |g| \leq 1/10$. We call such a neighborhood U a *standard neighborhood of q* . Moreover, if $q \in A_+$ and $\gamma : [0, 1] \rightarrow M$ is a smooth curve from p to q transverse to η , we can find a standard neighborhood of q in which γ is contained in $\{x = y = 0, z \leq 0\}$. It follows that the upper open cone in U centered at $(0, 0, -1/2)$ defined by

$$z > \sqrt{x^2 + y^2} - 1/2$$

is contained in A_+ and contains $q \cong (0, 0, 0)$. This shows that A_+ is open.

Since $A_+ \neq M$ by assumption and M is connected, $\partial N = \partial A_+ = \overline{A_+} \setminus A_+ \neq \emptyset$. Let $q \in \partial N$ and U be a standard neighborhood of q as above. Since ∂_z is positively transverse to η in this neighborhood, there exists a map $h : D^2 \rightarrow (-1, 1)$ such that

$$N \cap U = \{h(x, y) \leq z\}.$$

This map can be explicitly defined as

$$h(x, y) := \inf \{z \in (-1, 1) : (x, y, z) \in A_+ \cap U\}$$

and is lower semi-continuous. For $p \in U$, we consider the upper and lower half-cones

$$C_{\pm}(p) := p + \{\sqrt{x^2 + y^2} \leq \pm z\}.$$

We have the following elementary properties:

- If $p \in A_+ \cap U$ then $C_+(p) \subset A_+$,
- If $p \in U \setminus A_+$ then $C_-(p) \cap A_+ = \emptyset$.

These imply that if $p \in \partial N$ then $C_-(p) \cap N = \emptyset$ and $\text{int } C_+(p) \subset N$. Therefore, h is 1-Lipschitz, hence differentiable almost everywhere. We now show that h is \mathcal{C}^1 and tangent to η . Without loss of generality, we can assume that h is differentiable at $(0, 0)$. Note that $\eta(0, 0, 0) = \text{span}\{\partial_x, \partial_y\}$, $h(0, 0) = 0$, and $|\partial_x h(0, 0)|, |\partial_y h(0, 0)| \leq 1$. These properties are satisfied *in any standard neighborhood of q* , which allows us to change the z -direction (after possibly shrinking U). Therefore, $\partial_x h(0, 0) = \partial_y h(0, 0) = 0$ and (the graph of) h is tangent to η at $(0, 0)$. Similarly, h is tangent to η at every point where it is differentiable. Since η is continuous and h is Lipschitz, h is \mathcal{C}^1 and tangent to η everywhere.

As a result, N is a dead-end component for η . □

The fourth characterization of tautness immediately implies that it is an open condition in the \mathcal{C}^0 topology. Moreover, the sixth characterization generalizes the well-known fact that a \mathcal{C}^1 -foliation without spherical and toroidal leaves is taut:

Corollary B.4. *If η has no closed integral surfaces which are spheres or tori, then it is taut.*

Proof. Let us assume that η is not taut and let N be a dead-end component. We write

$$N = \bigsqcup_{1 \leq i \leq k} \Sigma_i,$$

where the Σ_i 's are closed connected orientable surfaces tangent to η . There exists a smooth vector field positively transverse to η , which restricts to a nowhere vanishing vector field on N transverse to ∂N and inward pointing. By [Pug68] (see also [Goo75, Proposition 1.2]),

$$\sum_{i=1}^k \chi(\Sigma_i) = 0,$$

which is impossible if the genera of all of the Σ_i 's are bigger or equal than 2. □

C Approximation lemma

In this appendix, we prove a technical lemma that is used in the proof of Proposition 4.7. This is a generalization of [Hoz22, Lemma 4.3] (see also [Mas23, Appendix A]) which might be of independent interest. We do not need to assume that M is 3-dimensional.

Lemma C.1. *Let X be a smooth vector field on a closed manifold M . Let $f : M \rightarrow \mathbb{R}$ be a continuous function which is continuously differentiable along X , i.e., $X \cdot f$ is defined on M and continuous. For every $\epsilon > 0$, there exists a smooth function $\tilde{f} : M \rightarrow \mathbb{R}$ such that*

$$|f - \tilde{f}|_{C^0} \leq \epsilon, \quad |X \cdot (f - \tilde{f})|_{C^0} \leq \epsilon.$$

Proof. Let

$$\Delta := \{x \in M : X(x) = 0\}$$

be the singular set of X , which is a compact subset of M . We proceed in 3 steps.

- *Step 1 : smoothing near Δ .* We fix some arbitrary metric g on M . For $\delta > 0$, let $U_\delta(\Delta)$ be the δ -neighborhood of Δ for this metric. Recall the following standard fact: there exists some constant $C_0 > 0$ such that for every sufficiently small $\delta > 0$, there exists a smooth cutoff function $\varphi_\delta : U_\delta(\Delta) \rightarrow [0, 1]$ such that

- $\varphi_\delta \equiv 1$ on $U_{\delta/10}(\Delta)$,
- $\varphi_\delta \equiv 0$ on $U_\delta(\Delta) \setminus U_{9\delta/10}(\Delta)$,
- $|d\varphi_\delta| \leq \frac{C_0}{\delta}$.³⁰

Moreover, there exists a constant $C_1 > 0$ such that for every $x \in M$,

$$|X(x)| \leq C_1 \text{dist}(x, \Delta).³¹$$

It follows that there exists a constant $C_2 > 0$ such that for every $\delta > 0$,

$$|X \cdot \varphi_\delta| \leq C_2.$$

Let $f_0 : M \rightarrow \mathbb{R}$ be a smooth function so that

$$|f - f_0|_{C^0} \leq \epsilon.$$

Since $X \cdot f = X \cdot f_0 = 0$ on Δ , there exists $\delta > 0$ such that

$$|X \cdot (f - f_0)|_{C^0(U_\delta(\Delta))} \leq \epsilon.$$

We now write $U_0 := U_\delta(\Delta)$, $V_0 := U_{\delta/10}(\Delta) \subset U_0$ and $\psi_0 = \varphi_\delta$ for such a $\delta > 0$. It follows from the previous paragraph that

$$|X \cdot (\psi_0 f - \psi_0 f_0)|_{C^0(U_0)} \leq |X \cdot \psi_0|_{C^0} |f - f_0|_{C^0} + |X \cdot (f - f_0)|_{C^0(U_0)} \lesssim \epsilon,$$

where the symbol \lesssim means “less or equal than up to a constant factor that only depends on M , X and g ”. We define $\tilde{f}_0 := \psi_0 f_0$.

³⁰To see this, first embed M in some \mathbb{R}^N and mollify a suitable Lipschitz cutoff function constructed from the distance function to the image of Δ .

³¹First show this on a sufficiently small neighborhood of Δ on which X is very close to its linearization, then enlarge C' so that it holds everywhere.

- *Step 2: smoothing away from Δ .* As a consequence of the proof of [Hoz22, Lemma 4.3] (see also [Mas23, Appendix A]), there exists

- A finite collection $\mathcal{U} = (U_i)_{1 \leq i \leq N}$ of open subsets of M covering $M \setminus V_0$ (made of flow boxes for X),
- A family of cutoff functions $(\varphi_i)_{1 \leq i \leq N}$ subordinate to \mathcal{U} such that on $M \setminus V_0$,

$$\sum_{i=1}^N \varphi_i = 1,$$

where $\varphi_i : M \rightarrow [0, 1]$,

- Smooth functions $f_i : M \rightarrow \mathbb{R}$, $1 \leq i \leq N$, such that

$$|\varphi_i f - f_i|_{C^0} \leq \frac{\epsilon}{N}, \quad |X \cdot (\varphi_i f - f_i)|_{C^0} \leq \frac{\epsilon}{N}.$$

For $1 \leq i \leq N$, we define $\psi_i := (1 - \psi_0)\varphi_i$, so that $(\psi_i)_{0 \leq i \leq N}$ is a partition of unity subordinate to the open cover $\mathcal{U}' := (U_i)_{0 \leq i \leq N}$ of M . We also write $\tilde{f}_i := (1 - \psi_0)f_i$ for $1 \leq i \leq N$, so that

$$|\psi_i f - \tilde{f}_i|_{C^0} \leq \frac{\epsilon}{N}, \quad |X \cdot (\psi_i f - \tilde{f}_i)|_{C^0} \lesssim \frac{\epsilon}{N}.$$

- *Step 3 : putting things together.* Finally, we define

$$\tilde{f} := \sum_{i=0}^N \tilde{f}_i,$$

and we readily obtain

$$\begin{aligned} |f - \tilde{f}|_{C^0} &\leq \sum_{i=0}^N |\psi_i f - \tilde{f}_i|_{C^0} \lesssim |\psi_0 f - \tilde{f}_0|_{C^0} + \epsilon \lesssim \epsilon, \\ |X \cdot (f - \tilde{f})|_{C^0} &\leq \sum_{i=0}^N |X \cdot (\psi_i f - \tilde{f}_i)|_{C^0} \lesssim |X \cdot (\psi_0 f - \tilde{f}_0)|_{C^0} + \epsilon \lesssim \epsilon. \end{aligned}$$

□

D Periodic solutions to ODEs on the cylinder

This appendix concerns the topology of periodic orbits of *continuous* vector fields on the cylinder. In particular, we give a necessary and sufficient condition for the existence of a foliation by circles tangent to (an approximation of) such a vector field. This serves as evidence for Conjecture 3.5, which would require a version of this result for continuous plane fields on a thickened 2-torus $\mathbb{T}^2 \times (-1, 1)$. Our result only applies to the intersection of such a plane field with an annulus transverse to the core torus $\mathbb{T}^2 \times \{0\}$.

Let

$$\begin{aligned} F : \mathbb{R} \times \mathbb{R} &\longrightarrow \mathbb{R} \\ (x, t) &\longmapsto F(x, t) \end{aligned}$$

be a *continuous*, bounded function satisfying

$$\forall x, t \in \mathbb{R}, \quad F(x, t + 1) = F(x, t),$$

so that F naturally induces a continuous function $\bar{F} : C \rightarrow \mathbb{R}$ on the cylinder $C := \mathbb{R} \times \mathbb{R}/\mathbb{Z}$. The corresponding vector field X on C is defined by

$$X(x, t) := \bar{F}(x, t) \partial_x + \partial_t$$

We are interested in the solutions to the ODE

$$(E) : \begin{cases} \dot{y}(t) = F(y(t), t), \\ y(t_0) = y_0, \end{cases}$$

where $(t_0, y_0) \in \mathbb{R} \times \mathbb{R}$, or equivalently, in the curves on C tangent to X .

Clearly, if there exists a smooth closed curve transverse to X , then X cannot be tangent to a foliation by circles on C , and the same is true for any vector field sufficiently \mathcal{C}^0 -close to X . Reciprocally,

Proposition D.1. *Assume that there exist no smooth closed curves transverse to X . Then X can be \mathcal{C}^0 -approximated by continuous vector fields tangent to foliations by circles on C .*

Proof. A simple closed curve γ on C tangent to X can be written as the graph of a (\mathcal{C}^1) function $f : S^1 \rightarrow \mathbb{R}$. Hence, we can naturally identify Γ with a subset of $\mathcal{C}^0(S^1, \mathbb{R})$. We endow Γ with the \mathcal{C}^0 topology and the natural partial order inherited from $\mathcal{C}^0(S^1, \mathbb{R})$. Notice that $\Gamma \subset \mathcal{C}^0(S^1, \mathbb{R})$ is closed, and the bounded subsets of Γ are relatively compact. This easily follows from the integral formulation of (E), the fact that the curves in Γ are K -Lipschitz, where $K := \sup |F|$, and Ascoli–Arzelà theorem.

We construct a subset $\Gamma_{\text{tot}} \subset \Gamma$ such that \leq restricts to a total order on Γ_{tot} , and

$$\bigcup_{\gamma \in \Gamma_{\text{tot}}} \gamma = C. \tag{D.1}$$

For that purpose, we will use following claim which will be proved later:

Claim. For every point $p \in C$, there exists $\gamma \in \Gamma$ passing through p .

One can easily deduce the following properties by suitably cutting a pasting curves in Γ :

- If $\gamma \in \Gamma$ and $p \in C \setminus \gamma$ lies above (resp. below) γ , there exists $\gamma' \in \Gamma$ passing through p such that $\gamma \leq \gamma'$ (resp. $\gamma' \leq \gamma$).
- If $\gamma_0, \gamma_1 \in \Gamma$, $\gamma_0 \leq \gamma_1$, and $p \in C$ is in the interior of the domain in C bounded by γ_0 and γ_1 , then there exists $\gamma \in \Gamma$ passing through p satisfying $\gamma_0 \leq \gamma \leq \gamma_1$.

Let $\mathcal{D} \subset \mathbb{R} \times S^1$ be a dense countable set. Using the above two bullet points, we can inductively construct a subset $\Gamma_{\mathcal{D}} \subset \Gamma$ on which \leq restricts to a total order, and such that

$$\mathcal{D} \subset \bigcup_{\gamma \in \Gamma_{\mathcal{D}}} \gamma.$$

We now define

$$\Gamma_{\text{tot}} := \overline{\Gamma_{\mathcal{D}}} \subset \Gamma,$$

the closure of $\Gamma_{\mathcal{D}}$ in Γ for the \mathcal{C}^0 topology. It is easy to check that \leq restricts to a total order on Γ_{tot} , and that (D.1) is satisfied. In the terminology of [BI08], Γ_{tot} is a *branching foliation* tangent to X . The methods of [BI08, Section 7] can easily be adapted to show the following modified statement of [BI08, Theorem 7.2]: for every $\epsilon > 0$, there exists a continuous vector field X_ϵ on C such that $|X_\epsilon - X|_{\mathcal{C}^0} \leq \epsilon$, and X_ϵ is tangent to a foliation by circles.

We are left to prove the Claim stated above. Let $p \in C = \mathbb{R} \times \mathbb{R}/\mathbb{Z}$. Without loss of generality, we can assume $p = (0, 0)$. We will slightly abuse notations and write X for the vector field $F(x, t)\partial_x + \partial_t$ on the strip $Z := \mathbb{R} \times [0, 1]$. Let $I \subset \mathbb{R}$ be the set of real numbers x such that there exists a curve in Z tangent to X from $(0, 0)$ to $(x, 1)$. By Kneser's theorem,³² I is a closed interval. It contains 0 if and only if there exists $\gamma \in \Gamma$ passing through $(0, 0)$. Otherwise, we can assume without loss of generality that $m := \min I > 0$, and we construct a closed transversal to X , contradicting our original hypothesis. Let γ_m be the curve in Γ from $(0, 0)$ to $(m, 1)$ which is minimal with respect to \leq .³³ For every $n \geq 0$, we let

$$X_n := (F - 2^{-n})\partial_x + \partial_t = X - 2^{-n}\partial_x,$$

and we denote by δ_n the minimal curve tangent to X_n starting at $(0, 0)$. Note that for every $n \geq 0$, δ_n is (negatively) transverse to X , and $\delta_n \leq \gamma_m$. Let $x_n \in \mathbb{R}$ be such that δ_n intersects $\mathbb{R} \times \{1\}$ at $\{x_n\} \times \{1\}$. It is easy to see that $\lim_n x_n = m$. Indeed, $x_n \leq m$ and $(\delta_n)_n$ converges uniformly to a curve starting at $(0, 0)$ and tangent to X . In particular, there exists $N \geq 0$ such that $x_N > 0$. It is then easy to modify δ_N near $\mathbb{R} \times \{1\}$ to obtain a smooth curve $\tilde{\delta}_N$ from $(0, 0)$ to $(0, 1)$ and which is (negatively) transverse to X . Therefore, we have constructed a closed transversal to X , a contradiction. \square

³²See [Har02], Chapter II, Theorem 4.1.

³³See [Har02], Chapter III, Theorem 2.1.

References

- [AB24] Antonio Alfieri and Fraser Binns. *Is the geography of Heegaard Floer homology restricted or the L-space conjecture false?* 2024. arXiv: [2404.00490](https://arxiv.org/abs/2404.00490).
- [BE13] John Baldwin and John Etnyre. “Transverse surgery does not preserve tightness”. In: *Mathematische Annalen* 357.2 (2013), pp. 441–468.
- [Bar17] Thomas Barthelmé. *Anosov flows in dimension 3. Preliminary version*. 2017. URL: http://www.crm.umontreal.ca/sms/2017/pdf/diapos/Anosov_flows_in_3_manifolds.pdf.
- [Ben83] Daniel Bennequin. “Entrelacements et équations de Pfaff. (French)”. In: *Third Schnepferried geometry conference*. Vol. 107. Astérisque. Société Mathématique de France, 1983, pp. 87–161.
- [BF03] Christian Bonatti and John Franks. *A Hölder continuous vector field tangent to many foliations*. 2003. arXiv: [0303291](https://arxiv.org/abs/0303291).
- [Bow16a] Jonathan Bowden. “Approximating C^0 -foliations by contact structures”. In: *Geometric and Functional Analysis* 26.5 (2016), pp. 1255–1296.
- [Bow16b] Jonathan Bowden. “Contact perturbations of Reebless foliations are universally tight”. In: *Journal of Differential Geometry* 104.2 (2016), pp. 219–237.
- [BC17] Steven Boyer and Adam Clay. “Foliations, orders, representations, L-spaces and graph manifolds”. In: *Advances in Mathematics* 310 (2017), pp. 159–234.
- [BGW13] Steven Boyer, Cameron McA Gordon, and Liam Watson. “On L-spaces and left-orderable fundamental groups”. In: *Mathematische Annalen* 356 (2013), pp. 1213–1245.
- [BBI01] Dimitri Burago, Yuri Burago, and Sergei Ivanov. *A Course in Metric Geometry*. Vol. 33. Graduate Studies in Mathematics. American Mathematical Society, 2001. ISBN: 978-1-4704-6853-8.
- [BI08] Dimitri Burago and Sergei Ivanov. “Partially hyperbolic diffeomorphisms of 3-manifolds with Abelian fundamental groups”. In: *Journal of Modern Dynamics* 2.4 (2008), pp. 541–580.
- [Cal01] Danny Calegari. “Leafwise smoothing laminations”. In: *Algebraic & Geometric Topology* 1 (2001), pp. 579–587.
- [Cal07] Danny Calegari. *Foliations and the Geometry of 3-Manifolds*. Oxford Mathematical Monographs. Oxford Science Publications, 2007. ISBN: 978-0-1985-7008-0.
- [CC00] Alberto Candeli and Lawrence Conlon. *Foliations I*. Vol. 23. Graduate Studies in Mathematics. American Mathematical Society, 2000. ISBN: 978-0-8218-0809-2.
- [CC03] Alberto Candeli and Lawrence Conlon. *Foliations II*. Vol. 60. Graduate Studies in Mathematics. American Mathematical Society, 2003. ISBN: 978-0-8218-0881-8.
- [Col02] Vincent Colin. “Structures de contact tendues sur les variétés toroidales et approximation de feuilletages sans composante de Reeb”. In: *Topology* 41.5 (2002), pp. 1017–1029.
- [CF11] Vincent Colin and Sebastião Firmo. “Paires de Structures de Contact Sur Les Variétés de Dimension Trois. (French)”. In: *Algebraic & Geometric Topology* 11.5 (2011), pp. 2627–53.

- [CGH09] Vincent Colin, Emmanuel Giroux, and Ko Honda. “Finitude homotopique et isotopique des structures de contact tendues. (French)”. In: *Publications Mathématiques de l’IHÉS* 109.1 (2009), pp. 245–93.
- [CH20] Vincent Colin and Ko Honda. “Foliations, contact structures and their interactions in dimension three.” In: *Surveys in 3-Manifold Topology and Geometry*. Vol. 25. Surveys in Differential Geometry. International Press, 2020, pp. 71–101.
- [CKR19] Vincent Colin, William Kazez, and Rachel Roberts. “Taut foliations”. In: *Communications in Analysis and Geometry* 27.2 (2019), pp. 357–375.
- [Doe87] Claus Doering. “Persistently transitive vector fields on three-dimensional manifolds”. In: *Procs. on Dynamical Systems and Bifurcation Theory* 160 (1987), pp. 59–89.
- [Dun20] Nathan Dunfield. “Floer homology, group orderability, and taut foliations of hyperbolic 3-manifolds.” In: *Geometry & Topology* 24.4 (2020), pp. 2075–2125.
- [Eli89] Yakov Eliashberg. “Classification of overtwisted contact structures on 3-manifolds”. In: *Inventiones mathematicae* 89.3 (1989), pp. 623–637.
- [Eli91] Yakov Eliashberg. “On symplectic manifolds with some contact properties”. In: *Journal of Differential Geometry* 33.1 (1991), pp. 233–238.
- [Eli92] Yakov Eliashberg. “Contact 3-manifolds twenty years since J. Martinet’s Work”. In: *Annales de l’Institut Fourier* 42.1-2 (1992), pp. 165–192.
- [Eli04] Yakov Eliashberg. “A few remarks about symplectic filling”. In: *Geometry & Topology* 8.1 (2004), pp. 277–293.
- [ET98] Yakov Eliashberg and William Thurston. *Confoliations*. Vol. 13. University Lecture Series. American Mathematical Society, 1998. ISBN: 978-0-8218-0776-7.
- [Etn07] John Etnyre. “Contact structures on 3-manifolds are deformations of foliations”. In: *Mathematical Research Letters* 14.5 (2007), pp. 775–779.
- [FH19] Todd Fisher and Boris Hasselblatt. *Hyperbolic Flows*. Zurich lectures in advanced mathematics. European Mathematical Society, 2019.
- [Gab83] David Gabai. “Foliations and the topology of 3-manifolds”. In: *Journal of Differential Geometry* 18.3 (1983), pp. 445–503.
- [Gab87] David Gabai. “Foliations and the topology of 3-manifolds. III”. In: *Journal of Differential Geometry* 26.3 (1987), pp. 479–536.
- [GO89] David Gabai and Ulrich Oertel. “Essential Laminations in 3-Manifolds”. In: *Annals of Mathematics* 130.1 (1989), pp. 41–73.
- [Gei09] Hansjörg Geiges. *An Introduction to Contact Topology*. Vol. 109. Cambridge studies in advanced mathematics. Cambridge University Press, 2009. ISBN: 978-0-5116-1143-8.
- [Goo75] Sue Goodman. “Closed leaves in foliations of codimension one”. In: *Commentarii Mathematici Helvetici* 50.1 (1975), pp. 383–388.
- [Han+20] Jonathan Hanselman, Jacob Rasmussen, Sarah Dean Rasmussen, and Liam Watson. “L-spaces, taut foliations, and graph manifolds”. In: *Compositio Mathematica* 156.3 (2020), pp. 604–612.
- [Har02] Philip Hartman. *Ordinary Differential Equations*. Second edition. Vol. 38. Classics in Applied Mathematics. SIAM, 2002. ISBN: 978-0-89871-510-1.

- [Hof93] Helmut Hofer. “Pseudoholomorphic curves in symplectizations with applications to the Weinstein conjecture in dimension three”. In: *Inventiones Mathematicae* 114 (1993), pp. 515–563.
- [Hoz22] Surena Hozoori. *Symplectic geometry of Anosov flows in dimension 3 and bi-contact topology*. 2022. arXiv: [2009.02768](https://arxiv.org/abs/2009.02768).
- [Jec03] Thomas Jech. *Set theory*. 3rd ed. Vol. 13. Springer Monographs in Mathematics. Springer, 2003. ISBN: 978-3-642-07899-6.
- [Juh15] András Juhász. “A survey of Heegaard Floer homology”. In: *New ideas in low dimensional topology*. Vol. 56. Series on Knots and Everything. World Scientific, 2015, pp. 237–295.
- [KR17] William Kazez and Rachel Roberts. “ C^0 approximations of foliations”. In: *Geometry & Topology* 21.6 (2017), pp. 3601–57.
- [KR19] William Kazez and Rachel Roberts. “ $C^{1,0}$ foliation theory”. In: *Algebraic & Geometric Topology* 19.6 (2019), pp. 2763–2794.
- [Kri20] Siddhi Krishna. “Taut foliations, positive 3-braids, and the L-space conjecture”. In: *Journal of Topology* 13.3 (2020), pp. 1003–1033.
- [Kri23] Siddhi Krishna. *Taut foliations, braid positivity, and unknot detection*. 2023. arXiv: [1809.03959](https://arxiv.org/abs/1809.03959).
- [Kro+07] Peter Kronheimer, Tomasz Mrowka, Peter Ozsváth, and Zoltan Szabó. “Monopoles and lens space surgeries”. In: *Annals of Mathematics* 165 (2007), pp. 457–546.
- [Ler01] Eugene Lerman. “Contact cuts”. In: *Israel Journal of Mathematics* 124.1 (2001), pp. 77–92.
- [Li02] Tao Li. “Laminar branched surfaces in 3-manifolds”. In: *Geometry & Topology* 6.1 (2002), pp. 153–194.
- [LR14] Tao Li and Rachel Roberts. “Taut foliations in knot complements”. In: *Pacific Journal of Mathematics* 269.1 (2014), pp. 149–168.
- [Lin23] Francesco Lin. *A remark on taut foliations and Floer homology*. 2023. arXiv: [2309.01222](https://arxiv.org/abs/2309.01222).
- [Mas23] Thomas Massoni. *Anosov flows and Liouville pairs in dimension three*. To appear in *Algebraic & Geometric Topology*. 2023. arXiv: [2211.11036](https://arxiv.org/abs/2211.11036).
- [Mit95] Yoshihiko Mitsumatsu. “Anosov flows and non-Stein symplectic manifolds”. In: *Annales de l’Institut Fourier* 45.5 (1995), pp. 1407–1421.
- [OS04] Peter Ozsváth and Zoltan Szabó. “Holomorphic disks and genus bounds”. In: *Geometry & Topology* 8.1 (2004), pp. 311–334.
- [Pug68] Charles Pugh. “A Generalized Poincaré index formula”. In: *Commentarii Mathematici Helvetici* 7.3 (1968), pp. 217–226.
- [RR17] Jacob Rasmussen and Sarah Dean Rasmussen. “Floer simple manifolds and L-space intervals”. In: *Advances in Mathematics* 322.5 (2017), pp. 738–805.
- [Ras17] Sarah Dean Rasmussen. “L-space intervals for graph manifolds and cables”. In: *Compositio Mathematica* 153.5 (2017), pp. 1008–1049.
- [Rob01a] Rachel Roberts. “Taut foliations in punctured surface bundles, I”. In: *Proceedings of the London Mathematical Society* 82.3 (2001), pp. 747–768.
- [Rob01b] Rachel Roberts. “Taut foliations in punctured surface bundles, II”. In: *Proceedings of the London Mathematical Society* 83.2 (2001), pp. 443–471.

- [San23a] Diego Santoro. *L-spaces, taut foliations and fibered hyperbolic two-bridge links*. 2023. arXiv: [2304.14914](#).
- [San23b] Diego Santoro. *L-spaces, taut foliations and the Whitehead link*. To appear in *Algebraic & Geometric Topology*. 2023. arXiv: [2201.01211](#).
- [San23c] Diego Santoro. *Taut foliations from knot diagrams*. 2023. arXiv: [2402.01225](#).
- [Spi99] Michael Spivak. *A Comprehensive Introduction to Differential Geometry*. 3rd ed. Vol. I. Publish or Perish, Inc, 1999. ISBN: 978-0-9140-9870-6.
- [Sul76] Dennis Sullivan. “Cycles for the dynamical study of foliated manifolds and complex manifolds”. In: *Inventiones Mathematicae* 36.1 (1976), pp. 225–255.
- [Tak74] Floris Takens. “Singularities of vector fields”. In: *Publications Mathématiques de l’IHÉS* 1.43 (1974), pp. 47–100.
- [Tes12] Gerald Teschl. *Ordinary Differential Equations and Dynamical Systems*. Vol. 140. Graduate Studies in Mathematics. American Mathematical Society, 2012. ISBN: 978-0-8218-8328-0.
- [Thu76] William Thurston. “Existence of codimension-one foliations”. In: *Annals of Mathematics* 104.2 (1976), pp. 249–268.
- [Vog16] Thomas Vogel. “On the uniqueness of the contact structure approximating a foliation”. In: *Geometry & Topology* 20.5 (2016), pp. 2439–2573.
- [Zha22] Boyu Zhang. “Monopoles and foliations without holonomy-invariant transverse measure”. In: *Journal of Symplectic Geometry* 20.1 (2022), pp. 191–258.
- [Zun24] Jonathan Zung. *Reeb flows transverse to foliations*. To appear in *Geometry & Topology*. 2024. arXiv: [2103.01325](#).