

CIRCULAR-ARC GRAPHS AND THE HELLY PROPERTY

JAN DERBISZ^{1†} AND TOMASZ KRAWCZYK²

ABSTRACT. One of the most common and best studied models for representing graphs is the intersection model. For a family \mathcal{R} of geometric objects, the \mathcal{R} -intersection model of a graph G in the family \mathcal{R} is a mapping $\phi : V(G) \rightarrow \mathcal{R}$ which assigns objects in \mathcal{R} to the vertices of G so that $\phi(u) \cap \phi(v) \neq \emptyset \iff uv \in E(G)$ for any two vertices u and v of G . Given a graph G , an \mathcal{R} -intersection model ϕ of G , and a clique C of G , we say C is *Helly* in ϕ if the set $\bigcap_{c \in C} \phi(c)$ is non-empty and we say the model ϕ satisfies the *Helly property* if every clique of G is Helly in ϕ .

In this paper we investigate some problems related to the Helly properties of *circular-arc graphs*, which are defined as intersection graphs of arcs of a fixed circle. As such, circular-arc graphs are among the simplest classes of intersection graphs whose models might not satisfy the Helly property. In particular, some cliques of a circular-arc graph might be Helly in some but not all arc intersection models of the graph. For these reasons, designing algorithms in the class of circular-arc graphs seems to be more challenging than in classes of graphs whose models naturally satisfy the Helly property, such as in the class of interval or chordal graphs.

Our first result is an alternative proof of a theorem by Lin and Szwarcfiter (*LNCS*, vol. 4112, 73–82) which asserts that for every circular-arc graph G either every normalized model of G satisfies the Helly property or no normalized model of G satisfies this property. Normalized models of a circular-arc graph G reflect the neighbourhood relation between the vertices of G ; in particular, every model of G can be made normalized by extending some of its arcs.

Further, we study the Helly properties of a single clique of a circular-arc graph G . We divide the cliques of G into three types: a clique C of G is *always-Helly/always-non-Helly/ambiguous* if C is Helly in every/no/(some but not all) normalized model of G . We provide a combinatorial description for the cliques of each type, and based on it, we devise a polynomial time algorithm which determines the type of a given clique.

Finally, we study the HELLY CLIQUES problem, in which we are given an n -vertex circular-arc graph G and some of its cliques C_1, \dots, C_k and we ask if there is an arc intersection model of G in which all the cliques C_1, \dots, C_k satisfy the Helly property. HELLY CLIQUES was introduced by Agaoglu Çagirici, Çagirici, Derbisz, Hartmann, Hlinený, Kratochvíl, Krawczyk, and Zeman in relation with their work on H -graphs recognition problems (*LIPICs*, vol. 272, 8:1–8:14) and was shown by Agaoglu Çagirici and Zeman to be NP-complete (*CoRR*, abs/2206.13372). We show that:

- HELLY CLIQUES admits a $2^{O(k \log k)} n^{O(1)}$ -time algorithm (that is, HELLY CLIQUES is FPT when parametrized by the number of cliques given in the input),
- assuming Exponential Time Hypothesis (ETH), HELLY CLIQUES cannot be solved in time $2^{o(k)} n^{O(1)}$,
- HELLY CLIQUES admits a polynomial kernel of size $O(k^6)$.

All our results use a data structure, called a *PQM-tree*, which maintains all normalized models of a circular-arc graph G .

[†]Research of this author was partially funded by Polish National Science Center (NCN) grant 2021/41/N/ST6/03671 and by the Priority Research Area SciMat under the program Excellence Initiative - Research University at the Jagiellonian University in Kraków.

1. INTRODUCTION

One of the most common and best studied models for representing graphs is the intersection model. For a family \mathcal{R} of geometric objects, the intersection model (or representation) of a graph G in the family \mathcal{R} is a mapping $\phi : V(G) \rightarrow \mathcal{R}$ which assigns objects in \mathcal{R} to the vertices of G so that $\phi(u) \cap \phi(v) \neq \emptyset \iff uv \in E(G)$ for any two vertices u and v of G . The graphs that have such a representation in \mathcal{R} form the class of \mathcal{R} -intersection graphs. By considering families \mathcal{R} of objects of some particular kind, for example, having a specific geometric shape, we obtain various classes of graphs. For instance:

- *interval graphs* are the intersection graphs of intervals on a line,
- *circular-arc graphs* are the intersection graphs of arcs of a fixed circle,
- *chordal graphs* are the intersection graphs of subtrees of a tree (or, equivalently, graphs with no induced cycles of length greater than 3).

Clearly, the class of interval graphs is contained in the class of chordal graphs and the class of circular-arc graphs. There are known linear time recognition algorithms for interval graphs [2] and chordal graphs [22]. The first polynomial time algorithm recognizing circular-arc graphs was given by Tucker [24]. Currently, two linear-time algorithms recognizing circular-arc graph are known [20, 15].

The subject of this paper are circular-arc graphs. Although circular-arc graphs seem to be closely related to interval graphs, they have significantly different algorithmic and combinatorial properties. In particular, quite number of problems that are solved or showed to admit polynomial time solutions in the class of interval graphs, in the class of circular-arc graphs are still open or are computationally hard. A good example illustrating our remark is the minimum coloring problem, which admits a simple linear algorithm in the class of interval graphs, but in the class of circular-arc graphs is **NP**-complete [12]. Another example is related to the problem of characterizing circular-arc graphs in terms of forbidden structures, in particular, by the list of all minimal induced graphs forbidden for this class of graphs. For interval graphs such a list was completed by Lekkerkerker and Boland [18] in the 1960's; for circular-arc graphs, despite a flurry of research [1, 9, 10, 16, 23, 6], it is still unknown.

One of the properties that seems to distinguish interval and chordal graphs from circular-arc graphs is the Helly property. In the context of intersection graphs, we use the following notation. Given a graph G , an intersection model ϕ of G , and a clique C of G , we say the *clique C satisfies the Helly property* (or *is Helly*) in ϕ if the set $\bigcap_{c \in C} \phi(c)$ is non-empty and we say the *model ϕ satisfies the Helly property* if every clique of G is Helly in ϕ .

Due to the properties of geometric objects defining the class of interval and chordal graphs, every intersection model of a graph from these classes satisfies the Helly property. Therefore, one can easily deduce that every interval/chordal graph contains linearly many, in the size of its vertex set, maximal cliques. The situation is different for circular-arc graphs; for example, a circular-arc graph G which arises from a complete graph by removing the edges of a perfect matching, contains exponentially many maximal cliques,

and in any model of G only linearly many of them may satisfy the Helly property. It is worth noting here that possessing linearly many maximal cliques is a property often used in algorithm design. For example, in the class of interval graphs, a vast number of algorithms use a data structure called *PQ-trees*. The PQ-tree of an interval graph G represents all possible orderings of all maximal cliques in the models of G . Thus, the PQ-tree of G also represents all possible interval models of G . For chordal graphs the structure describing all their intersection models is not known, however, the property of possessing linearly many cliques is used e.g. in polynomial-time algorithms for the recognition and the isomorphism testing of T -graphs, for every fixed tree T [7, 4]. Similarly, in the class of circular-arc graphs the structure of all their intersection models is not known. Nevertheless, quite recently the structure of so-called *normalized models* of circular-arc graphs was described [17]. Normalized models of a circular-arc graph reflect the neighbourhood relation in this graph and can be seen as its canonical representations – see Section 2 for their precise definition. In particular, every intersection model ψ of a circular-arc graph G can be easily transformed into a normalized model ϕ of G by possibly extending some of the arcs of ψ . In particular, if a clique C of G is Helly in ψ , it is also Helly in ϕ . Krawczyk [17], based on the approach proposed by Hsu [14], devised a linear-time algorithm computing a data structure, called a *PQM-tree*, which represents all normalized models of a circular-arc graph. Since the PQM-trees of circular-arc graphs are heavily exploited in our paper, we describe them precisely in Section 3.

An important subclass of circular-arc graphs, which inherits many properties of interval graphs, is formed by *Helly circular-arc graphs*. A circular-arc graph G is *Helly* if it admits a circular-arc model which satisfies the Helly property. In particular, like interval graphs, every Helly circular-arc graph has linearly many maximal cliques; on the other hand, the minimum coloring problem in this class of graphs remains NP-complete [13]. Heading towards a linear-time algorithm for the recognition of the Helly circular-arc graphs, Lin and Szwarcfiter proved the following theorem.

Theorem 1.1 ([19]). *Let G be a circular-arc graph. Either every normalized model of G satisfies the Helly property or no normalized model of G satisfies the Helly property.*

They prove the theorem by listing so-called obstacles, which have to be avoided by Helly circular-arc graphs.

1.1. Our results. The goal of this paper is to study the Helly properties in the class of circular-arc graphs.

First, in Section 4, we provide an alternative proof of Theorem 1.1, based on the properties of PQM-trees for circular-arc graphs.

In Section 5 we study the Helly properties of a single clique of a circular-arc graph G . We divide the cliques of G into three types: a clique C of G is *always-Helly/always-non-Helly/ambiguous* if C is Helly in every/no/(some but not all) normalized model of G . We provide a combinatorial description for the cliques of each type, and based on it, we prove the following:

Theorem 1.2. *There is a polynomial-time algorithm which, given a circular-arc graph G and its clique C , determines the type of C .*

Next, we turn our attention to the HELLY CLIQUES problem. In the HELLY CLIQUES problem we are given a circular-arc graph G and some of its cliques C_1, \dots, C_k and we ask if there is a model of G in which all the cliques C_1, \dots, C_k are Helly (if some model of G satisfies these properties, then the model obtained by its normalization satisfies these properties as well). HELLY CLIQUES was introduced by Agaoglu Çagirici, Çagirici, Derbisz, Hartmann, Hlinený, Kratochvíl, Krawczyk, and Zeman [3] as an intermediate problem in their study of H -graphs recognition problems (see next subsection for details) and was shown by Agaoglu Çagirici and Zeman to be NP-complete [5]. Regarding HELLY CLIQUES, we show the following theorems:

Theorem 1.3.

- (1) HELLY CLIQUES can be solved in time $2^{O(k \log k)} n^{O(1)}$.
- (2) Assuming ETH, HELLY CLIQUES cannot be solved in time $2^{o(k)} n^{O(1)}$.

Theorem 1.4. HELLY CLIQUES admits a kernel of size $O(k^6)$.

The proof of Theorem 1.3.(1) uses the PQM-tree of G to find a normalized model in which C_1, \dots, C_k are Helly. Besides, it also uses some purely geometric observations, such as so-called *Trapezoid Lemma*, which asserts that for a family T_1, \dots, T_n of pairwise intersecting trapezoids spanned between two parallel lines A and B one can draw inside each trapezoid T_i a segment s_i spanned between A and B so as s_1, \dots, s_n are pairwise intersecting. We also give an alternative proof of the fact that HELLY CLIQUES is NP-complete, which yields Theorem 1.3.(2) as a by-product.

Our kernelization procedure from Theorem 1.4 is done in two steps. In the first step we mark a set R of *important vertices* in G , where the size of R is $O(k^6)$. The important vertices in R encode all relevant information needed to conclude that we are dealing with **no**-instance; in particular, the instances G, C_1, \dots, C_k and G, C'_1, \dots, C'_k of HELLY CLIQUES are equivalent, where $C'_i = C_i \cap R$ for $i \in [k]$. In the second step we construct so-called *reduct* G' of G with respect to the set R . The vertex set of the reduct G' contains the set R as its subset and has size linear in $|R|$. The main property of the reduct G' of G with respect to R is that the configurations of the arcs representing R occurring in the models of G and in the models of G' coincide. In particular, we may return G', C'_1, \dots, C'_k as the kernel of G, C_1, \dots, C_k .

1.2. Applications. The results presented in the previous subsection have been used as tools in the resolution of some problems related to the recognition of so-called H -graphs [3]. For a fixed connected graph H , the class of H -graphs contains the intersection graphs of connected subgraphs of some subdivisions of H . Many known geometric intersection graph classes are H -graphs for an appropriately chosen graph H : K_2 -graphs coincide with interval graphs, K_3 -graphs coincide with circular-arc graphs, the class $\bigcup T$ -graph, where the union ranges over all trees T , coincides with the class of chordal graphs. Since H -graphs generalize many known geometric intersection graph classes, they form a good

background that allows to study basic computational problems in some systematic way. Recently, quite a lot of research has been devoted to determine the tractability border for various computational problems, such as recognition or isomorphism testing, in classes of H -graphs with respect to the combinatorial properties of graphs H . The research of Agaoglu Çagirici et al. [3] shows that HELLY CLIQUES is strongly related with the recognition problems of H -graphs for the cases of this problem which remain open. Let us briefly describe what we know about H -graphs recognition. Chaplick, Töpfer, Voborník, and Zeman [7] showed that, for every fixed tree T , the recognition of T -graphs can be solved in polynomial time. They also showed that H -graph recognition is NP-hard when H contains two cycles sharing an edge [7]. We already mentioned that K_3 -graphs (circular-arc graphs) can be recognized in linear-time [20, 15]. Agaoglu Çagirici et al. [3] strengthened the result of Chaplick et al. [7] and showed that the recognition of H -graphs is NP-hard when H contains two distinct cycles. They also showed that H -graph recognition is polynomial-time solvable when H is a graph consisting of a cycle and an edge attached to it, called a *lollipop*. In particular, their algorithm recognizing lollipop-graphs uses as a subroutine a polynomial-time algorithm testing whether there is a model of a circular-arc graph in which some particular clique is Helly. Such an algorithm is asserted by Theorem 1.2. The above result leave open H -graph recognition problems for the cases where H is a unicyclic graph different from a cycle and a lollipop. Following the arguments from [3], one can observe that the recognition of H -graphs, where H is a cycle with k disjoint edges adjacent to it, is as difficult as HELLY CLIQUES with the number of cliques equal to k . Finally, [3] shows that the recognition of $\bigcup H$ -graph, where H ranges over all unicyclic graphs, is polynomial time equivalent to HELLY CLIQUES.

1.3. The structure of the paper. Our paper is organized as follows:

- in Section 2 we define notation and basic concepts related to circular-arc graphs,
- in Section 3 we describe PQM-trees representing normalized models of circular-arc graphs,
- in Section 4 we provide an alternative proof of Theorem 1.1 by Lin and Szwarcfiter,
- in Section 5 we provide a polynomial-time algorithm testing the type of a clique in a circular-arc graph,
- in Section 6 we prove Theorem 1.3.(1).
- in Section 7 we prove Theorem 1.4.
- in Section 8 an alternative proof of NP-completeness of HELLY CLIQUES is contained, which shows Theorem 1.3.2 as a corollary.
- Section 9 (Appendix) contains the construction of the reduct of a circular arc graph and the proof of the Trapezoid Lemma.

2. PRELIMINARIES

2.1. Graphs. All graphs considered in this paper are *simple*, that is, they have no multi-edges and no loops. Let $G = (V, E)$ be a graph with the vertex set V and the edge set E . The *neighbourhood* of a vertex $u \in V$ in G is the set $N(u) = \{v \in V(G) \mid uv \in E(G)\}$, the *neighbourhood* of a set $U \subseteq V$ in G is the set $N(U) = \bigcup_{u \in U} N(u) \setminus U$. We also define

$N[u] = N(u) \cup \{u\}$ for a vertex $u \in V$ and we write $N[U] = \bigcup_{u \in U} N[u]$ for a set $U \subseteq V$. A vertex u of G is *universal* in G if $N[u] = V(G)$. Two distinct vertices u, v of G are *twins* in G if $N[u] = N[v]$. Note that twins are adjacent in G .

2.2. Circular-arc graphs. Let G be a circular-arc graph with no universal vertices and no twins and let ψ be a circular-arc model of G on the circle \mathcal{O} . Let (v, u) be a pair of distinct vertices in G . We say that:

- $\psi(v)$ and $\psi(u)$ are *disjoint* if $\psi(v) \cap \psi(u) = \emptyset$,
- $\psi(v)$ *contains* $\psi(u)$ if $\psi(v) \supsetneq \psi(u)$,
- $\psi(v)$ *is contained in* $\psi(u)$ if $\psi(v) \subsetneq \psi(u)$,
- $\psi(v)$ and $\psi(u)$ *cover the circle* if $\psi(v) \cup \psi(u) = \mathcal{O}$,
- $\psi(v)$ and $\psi(u)$ *overlap*, otherwise.

See Figure 2.1 for an illustration.

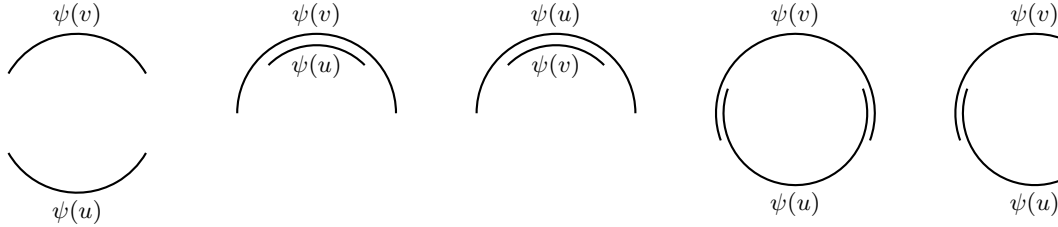

FIGURE 2.1. From left to right: $\psi(v)$ and $\psi(u)$ are disjoint, $\psi(v)$ contains $\psi(u)$, $\psi(v)$ is contained in $\psi(u)$, $\psi(v)$ and $\psi(u)$ cover the circle, and $\psi(v)$ and $\psi(u)$ overlap.

In so-called *normalized models*, introduced by Hsu in [14], the relative relation between the arcs reflects the neighbourhood relation between the vertices of G , as follows.

Definition 2.1. Let G be a circular-arc graph with no universal vertices and no twins. A circular-arc model ψ of G is *normalized* if for every pair (v, u) of distinct vertices of G the following conditions are satisfied:

- (1) if $uv \notin E(G)$, then $\psi(v)$ and $\psi(u)$ are disjoint,
- (2) if $N[u] \subsetneq N[v]$, then $\psi(v)$ contains $\psi(u)$,
- (3) if $N[v] \subsetneq N[u]$, then $\psi(v)$ is contained in $\psi(u)$,
- (4) if $uv \in E(G)$, $N[v] \cup N[u] = V(G)$, $N[w] \subsetneq N[v]$ for every $w \in N[v] \setminus N[u]$, and $N[w] \subsetneq N[u]$ for every $w \in N[u] \setminus N[v]$, then $\psi(v)$ and $\psi(u)$ cover the circle,
- (5) If none of the above condition holds, then $\psi(v)$ and $\psi(u)$ overlap.

Furthermore, for a pair (v, u) of vertices from G , we say that v contains u , v is contained in u , v and u cover the circle, and v and u overlap if the pair (v, u) satisfies the assumption of statement (2), (3), (4), and (5), respectively.

Hsu [14] showed that every circular-arc model ψ of G can be turned into a normalized model by possibly extending some arcs of ψ . We associate with every vertex $v \in V$ two

sets, $\text{left}(v)$ and $\text{right}(v)$, where:

$$\begin{aligned} \text{left}(v) &= \{u \in V(G) : v \text{ contains } u \text{ or } v \text{ and } u \text{ cover the circle}\}, \\ \text{right}(v) &= \{u \in V(G) : v \text{ and } u \text{ are disjoint or } v \text{ is contained in } u\}. \end{aligned}$$

Following [14, 17] we define the *overlap graph* $G_{ov} = (V, \sim)$ of G which joins with an edge $u \sim v$ every two vertices u, v of G that overlap in G . Given a normalized model ψ of G we obtain an intersection model ϕ of the overlap graph G_{ov} by transforming every arc $\psi(v)$ for $v \in V$ to the oriented chord $\phi(v)$ such that $\psi(v)$ and $\phi(v)$ have the same endpoints and the oriented chord $\phi(v)$ has the arc $\psi(v)$ on its left side. Note that the intersection model ϕ of G_{ov} satisfies the conditions:

- $u \in \text{left}(v)$ if and only if $\phi(u)$ lies on the left side of $\phi(v)$,
- $u \in \text{right}(v)$ if and only if $\phi(u)$ lies on the right side of $\phi(v)$.

See Figure 2.2 for an illustration. The intersection models of G_{ov} in the set of oriented chords satisfying the above two properties are called the *conformal models* of G . Clearly, there is one-to-one correspondence between the normalized models of G and the conformal models of G . See [14, 17] for more details.

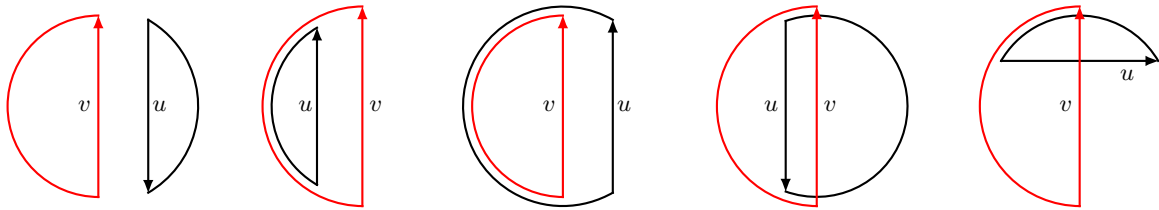

FIGURE 2.2. Mutual relation between the arcs $\psi(v)$ and $\psi(u)$ and between the corresponding oriented chords $\phi(v)$ and $\phi(u)$ for the cases: v and u are disjoint, v contains u , v is contained in u , v and u cover the circle, and v and u overlap, respectively.

Usually, the notion of normalized models is extended on all circular-arc graphs G by requiring $\psi(v) = \mathbf{O}$ for any universal vertex v in G and $\psi(u) = \psi(v)$ for any pair (u, v) of twin vertices in G .

2.3. Representing the oriented chords and points of the circle. Let \mathbf{O} be a fixed circle. Let S be a collection of oriented chords of the circle \mathbf{O} and P be a collection of points on the circle \mathbf{O} such that all the points from P and the endpoints of the chords from S are distinct. We represent the set $B = S \cup P$ by a circular word $cw(B)$ on the letter set $S^* \cup P$, where $S^* = \{s^0, s^1 : s \in S\}$, obtained as follows. We start at some point on the circle with the empty word $cw(B)$. Then we follow the circle in the clockwise order and we append to $cw(B)$:

- the letter p whenever we pass a point p from P ,
- the letter s^0 whenever we pass the tail of a chord s from S ,
- the letter s^1 whenever we pass the head of a chord s from S .

Usually we use the same symbol to denote the set B and its word representation $cw(B)$.

For a collection B of oriented chords and points on the circle we define the *reflection* B^R of B obtained by mirroring every object from B over some fixed line L and then by reorienting every chord in B^R (hence the arc to the left of an oriented chord s^0s^1 in B^R is obtained by mirroring the arc to the left of the oriented chord s^0s^1 in B) – see Figure 2.3 for an illustration. Note that the word $cw(B^R)$ representing B^R is obtained from $cw(B)$ by reversing the order of the letters in $cw(B)$ and by exchanging the superscripts 0 to 1 and 1 to 0; any word w^R (not only circular) obtained this way from a word w is called the *reflection* of w .

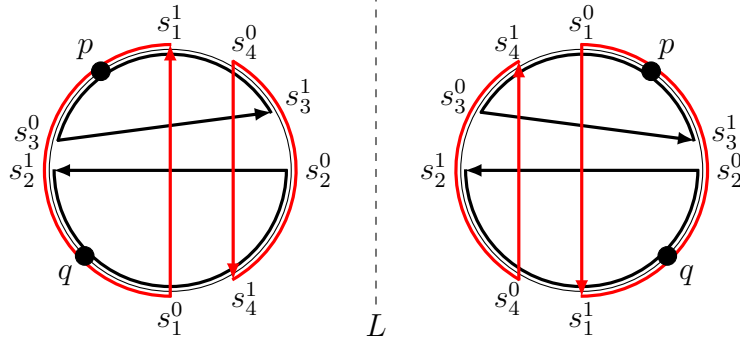

FIGURE 2.3. A collection B of oriented chords and points and its reflection B^R . The set B is represented by the circular word $cw(B) = s_4^0s_3^1s_2^0s_4^1s_1^0qs_2^1s_3^0ps_1^1$ and the set B^R is represented by $cw^R(B) = s_1^0ps_3^1s_2^0qs_1^1s_4^0s_2^1s_3^0s_4^1$.

We represent any conformal model ϕ of G by its word representation (note that ϕ is a circular word over $V^*(G)$); we treat two conformal models of G as *equivalent* if their word representations are equal. Given a conformal model ϕ of G , possibly extended by some points from the set P (usually witnessing the Helly property of some cliques of G), given a subset U of $V(G)$ and a subset Q of P , by $\phi|(U^* \cup Q)$ we denote the circular order ϕ restricted to the letters from the set $U^* \cup Q$, which represents the restriction of the model ϕ to the chords representing the vertices from U and to the points from Q . Finally, we use operator \equiv to stress that the equality holds between two circular words.

Before we describe the structure representing all non-equivalent conformal models of G , we need some preparation. In particular, we need to introduce the basic concepts related to the modular decomposition of the graph G_{ov} and its connection to the transitive orientations of some induced subgraphs of G_{ov} .

2.4. Modular decomposition of G_{ov} . Let $G = (V, E)$ be a circular-arc graph and let $G_{ov} = (V, \sim)$ be the overlap graph of G . By (V, \parallel) we denote the complement of (V, \sim) . For a set $U \subseteq V$, by (U, \sim) , and (U, \parallel) we denote the subgraphs of (V, \sim) and (V, \parallel) induced by the set U , respectively. For two sets $U_1, U_2 \subset V$, we write $U_1 \sim U_2$ ($U_1 \parallel U_2$) if $u_1 \sim u_2$ ($u_1 \parallel u_2$, respectively) for every $u_1 \in U_1$ and $u_2 \in U_2$. For a set $U \subseteq V$, by U^* we denote the set $\{u^0, u^1 : u \in U\}$.

The results presented below are due to Gallai [11], except of Theorem 2.2 by Dushnik and Miller [8].

A non-empty set $M \subseteq V$ is a *module* in G_{ov} if $x \sim M$ or $x \parallel M$ for every $x \in V \setminus M$. The singleton sets and the whole V are the *trivial modules* of G_{ov} . A module M of G_{ov} is *strong* if $M \subseteq N$, $N \subseteq M$, or $M \cap N = \emptyset$ for every other module N in G_{ov} . In particular, two strong modules of G_{ov} are either nested or disjoint. The *modular decomposition* of G_{ov} , denoted by $\mathcal{M}(G_{ov})$, consists of all strong modules of G_{ov} . Since every two modules from $\mathcal{M}(G_{ov})$ are either disjoint or nested, the modules from $\mathcal{M}(G_{ov})$ can be organized in a tree in which V is the root, the maximal proper subsets from of $M \in \mathcal{M}(G_{ov})$ from $\mathcal{M}(G_{ov})$ are the children of M (the children of M form a partition of M), and the singleton modules $\{x\}$ for $x \in V$ are the leaves.

A module $M \in \mathcal{M}(G_{ov})$ is *serial* if $M_1 \sim M_2$ for every two children M_1 and M_2 of M , *parallel* if $M_1 \parallel M_2$ for every two children M_1 and M_2 of M , and *prime* otherwise. Equivalently, $M \in \mathcal{M}$ is serial if (M, \parallel) is disconnected, parallel if (M, \sim) is disconnected, and prime if both (M, \sim) and (M, \parallel) are connected.

Suppose U is a module in G_{ov} . A graph (U, \sim) is a *permutation subgraph* of G_{ov} if there exists a pair (τ^0, τ^1) , where τ^0 and τ^1 are permutations of U , such that for every $x, y \in U$:

$$x \sim y \iff \begin{array}{l} x \text{ occurs before } y \text{ in both } \tau^0 \text{ and } \tau^1, \text{ or} \\ y \text{ occurs before } x \text{ in both } \tau^0 \text{ and } \tau^1. \end{array}$$

If this is the case, (τ^0, τ^1) is called a *permutation model* of (U, \sim) . See Figure 2.4 for an example of a permutation graph and its permutation model.

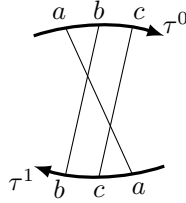

FIGURE 2.4. A permutation model $(\tau^0, \tau^1) = (abc, acb)$ of the permutation graph $(\{a, b, c\}, \{a \sim b, a \sim c\})$.

Let U be a module in G_{ov} such that (U, \sim) is a permutation subgraph in G_{ov} . The structure of the permutation models of (U, \sim) can be described by means of transitive orientations of the graphs (U, \sim) and (U, \parallel) . An *orientation* (U, \prec) of (U, \sim) arises by orienting every edge $u \sim v$ in (U, \sim) either from v to u , denoted $u \prec v$, or from u to v , denoted $v \prec u$. An orientation (U, \prec) of (U, \sim) is *transitive* if \prec is a transitive relation on U . We define transitive orientations of (U, \parallel) similarly. Since (U, \sim) is a permutation subgraph in G_{ov} , (U, \sim) has a permutation model $\tau = (\tau^0, \tau^1)$. Note that $\tau = (\tau^0, \tau^1)$ yields transitive orientations \prec^τ and $<^\tau$ of the graphs (U, \sim) and (U, \parallel) , respectively, given by:

$$(1) \quad \begin{array}{ll} x \prec^\tau y & \iff x \text{ occurs before } y \text{ in } \tau^0 \text{ and } x \sim y, \\ x <^\tau y & \iff x \text{ occurs before } y \text{ in } \tau^0 \text{ and } x \parallel y. \end{array}$$

On the other hand, given transitive orientations \prec^τ and $<^\tau$ of (U, \sim) and (U, \parallel) , respectively, one can construct a permutation model (τ^0, τ^1) of (U, \sim) such that

$$(2) \quad \begin{aligned} x \text{ occurs before } y \text{ in } \tau^0 &\iff x \prec^\tau y \text{ or } x <^\tau y, \\ x \text{ occurs before } y \text{ in } \tau^1 &\iff x \prec^\tau y \text{ or } y <^\tau x. \end{aligned}$$

Theorem 2.2 ([8]). *Let (U, \sim) be a permutation subgraph of G_{ov} . There is a one-to-one correspondence between permutation models $\tau = (\tau^0, \tau^1)$ of (U, \sim) and the pairs (\prec^τ, \prec^τ) of transitive orientations of (U, \parallel) and (U, \sim) , respectively, given by equations (1) and (2).*

The transitive orientations of (U, \sim) and (U, \parallel) can in turn be described by means of the modular decomposition trees of $\mathcal{M}(U, \sim)$ and $\mathcal{M}(U, \parallel)$. Note that $\mathcal{M}(U, \sim) = \mathcal{M}(U, \parallel)$ and since U is a module in (U, \sim) , we have $\mathcal{M}(U, \sim) = \{M \in \mathcal{M}(G_{ov}) : M \subseteq U\} \cup \{U\}$. The relations between the transitive orientations of (U, \sim) and the modular decomposition tree of (U, \sim) were described by Gallai [11].

Theorem 2.3 ([11]). *If $M_1, M_2 \in \mathcal{M}(U, \sim)$ are such that $M_1 \sim M_2$, then every transitive orientation (U, \prec) satisfies either $M_1 \prec M_2$ or $M_2 \prec M_1$ (that is, either $x \prec y$ for every $x \in M_1$ and $y \in M_2$ or $y \prec x$ for every $x \in M_1$ and $y \in M_2$).*

Let M be a strong module in $\mathcal{M}(U, \sim)$. The edge relation \sim in (M, \sim) restricted to the edges joining the vertices from two different children of M is denoted by \sim_M . If $x \sim y$, then $x \sim_M y$ for exactly one module $M \in \mathcal{M}(U, \sim)$. Hence, the set $\{\sim_M : M \in \mathcal{M}(U, \sim)\}$ forms a partition of the edge set \sim of the graph (U, \sim) .

Theorem 2.4 ([11]). *There is a one-to-one correspondence between the set of transitive orientations (U, \prec) of (U, \sim) and the families*

$$\{(M, \prec_M) : M \in \mathcal{M}(U, \sim) \text{ and } \prec_M \text{ is a transitive orientation of } (M, \sim_M)\}$$

given by $x \prec y \iff x \prec_M y$, where M is the module in $\mathcal{M}(U, \sim)$ such that $x \sim_M y$.

The above theorem asserts that for every $M \in \mathcal{M}(U, \sim)$ every transitive orientation of (U, \sim) restricted to the edges of the graph (M, \sim_M) induces a transitive orientation of (M, \sim_M) , and that every transitive orientation of (U, \sim) can be obtained by independent transitive orientation of (M, \sim_M) for $M \in \mathcal{M}(U, \sim)$. Gallai [11] characterized all possible transitive orientation of (M, \sim_M) , where M is a strong module of $\mathcal{M}(U, \sim)$.

Theorem 2.5 ([11]). *Let M be a prime module in $\mathcal{M}(U, \sim)$. Then, (M, \sim_M) has two transitive orientations, one being the reverse of the other.*

For a parallel module M the graph (M, \sim_M) has exactly one (empty) transitive orientation. For a parallel module M the transitive orientations of (M, \sim_M) correspond to the total orderings of its children, that is, every transitive orientation of (M, \sim_M) has the form $M_{i_1} \prec \dots \prec M_{i_k}$, where $i_1 \dots i_k$ is a permutation of $[k]$ and M_1, \dots, M_k are the children of M in $\mathcal{M}(U, \sim)$.

3. DATA STRUCTURE REPRESENTING THE CONFORMAL MODELS OF G

Let $G = (V, E)$ be a circular-arc graph with no twins and no universal vertices and let $G_{ov} = (V, \sim)$ be the overlap graph of G . In this section we describe a data structure, called a *PQM-tree* \mathcal{T} of G , which represents all conformal models of G . First, we describe the basic properties and the role played by each component of \mathcal{T} , then we show how to read out the components of \mathcal{T} from some fixed conformal model of G . For the combinatorial definition of \mathcal{T} and the formal proofs of its properties we refer the reader to [17].

3.1. Components of \mathcal{T} and their properties. The PQM-tree \mathcal{T} representing the conformal models of G consists of:

- the set $\mathcal{S} = \{S_1, \dots, S_t\}$ of *CA-modules* of G . The set \mathcal{S} is defined such that:
 - \mathcal{S} forms a partition of V ,
 - for every $i \in [t]$ the graph (S_i, \sim) is a permutation subgraph of G_{ov} contained in some connected component of G_{ov} .

Additionally, for every $i \in [t]$ a vertex $s_i \in S_i$, called the *representant* of S_i , is fixed.

- the set $\mathcal{MC} = \{\mathbb{S}_1, \dots, \mathbb{S}_t\}$ of *metachords* of G . Each metachord \mathbb{S}_i is a triple $(S_i^0, S_i^1, <_{S_i})$, where:
 - the set $\{S_i^0, S_i^1\}$ forms a partition of S_i^* such that $s_i^0 \in S_i^0$, $s_i^1 \in S_i^1$, and $|\{u_0, u_1\} \cap S_i^0| = |\{u^0, u^1\} \cap S_i^1| = 1$ for every $u \in S$.
 - $<_{S_i}$ is a fixed transitive orientation of (S_i, \parallel) .

The elements of the set $\mathcal{S}^* = \{S_1^0, S_1^1, \dots, S_t^0, S_t^1\}$ are called *the slots of G* .

- the set Π of *admissible orders of the slots* of G . Every member of Π is a circular word over \mathcal{S}^* (contains every slot of G exactly once).

The CA-modules and the slots of G are defined such that:

(P1): For every conformal model ϕ of G and every $i \in [t]$:

- for every $j \in \{0, 1\}$ the elements of the set S_i^j form a contiguous subword in ϕ , denoted by $\phi|S_i^j$,
- the pair $(\phi|S_i^0, \phi|S_i^1)$ is an oriented permutation model of (S_i, \sim) .

The above property allows us to treat any conformal model ϕ of G as a collection of t oriented permutation models $(\phi|S_i^0, \phi|S_i^1)$ of (S_i, \sim) spanned between the slots S_i^0, S_i^1 – see Figure 3.1.

The set of oriented permutation models that might be spanned between the slots S_i^0 and S_i^1 is represented by the metachord $\mathbb{S}_i = (S_i^0, S_i^1, <_{S_i})$, as follows.

Definition 3.1. *An oriented permutation model $\tau = (\tau^0, \tau^1)$ of (S_i, \sim) is admissible by the metachord \mathbb{S}_i if:*

- τ^j is a permutation of S_i^j for $j \in \{0, 1\}$,
- we have $<^\tau = <_{S_i}$ (\prec^τ is not restricted), where $<^\tau$ and \prec^τ are transitive orientations of (S_i, \parallel) and (S_i, \sim) , respectively, corresponding to τ .

Note that the admissible models for \mathbb{S}_i , regardless of the conformal model ϕ , keep the left/right relation between every two non-intersecting chords from $(\phi|S_i^0, \phi|S_i^1)$ in the same

relation (\prec_{S_i} is defined so as it asserts the consistency with the sets $\mathbf{left}(\cdot)$ and $\mathbf{right}(\cdot)$). The metachords $\mathbb{S}_1, \dots, \mathbb{S}_t$ are defined such that:

(P2): For every conformal model ϕ of G_{ov} and every $i \in [t]$ the oriented permutation model $(\phi|S_i^0, \phi|S_i^1)$ of (S_i, \sim) is admissible by the metachord \mathbb{S}_i .

Property (P1) allows us to denote by $\pi(\phi)$ the *circular order of the slots in ϕ* , that is, the word obtained from ϕ by substituting every contiguous subword $\phi|S_i^j$ of ϕ by the letter S_i^j , for $i \in [t]$ and $j \in \{0, 1\}$ – see Figure 3.1 for an illustration. Clearly, $\pi(\phi)$ is a circular word over \mathcal{S}^* . The last component Π maintains the set of circular orders of the slots in the conformal models of G . In particular, Π is defined such that:

(P3): For every conformal model ϕ of G the circular word $\pi(\phi)$ is a member of Π .

Eventually, all the components of \mathcal{T} are defined such that the following holds:

(P4): We can generate any conformal model of G by:

- picking a circular order of the slots π from the set Π ,
- replacing the slots S_i^0 and S_i^1 in π by words τ_i^0 and τ_i^1 , where (τ_i^0, τ_i^1) is an oriented permutation model of (S_i, \sim) admissible by the metachord \mathbb{S}_i .

The set Π might have exponentially many members, however, it has a linear-size representation in \mathcal{T} by means of a *PQ-tree* \mathcal{T}^{PQ} of G – see Subsection 3.3.

Figure 3.1 shows a conformal model ϕ of some circular-arc graph G (to the left). The circular-arc graph G is defined on the vertex set $V = \{a, b, c, d, e, f, g, h, i\}$; the edges of G can be read out from ϕ . The data structure \mathcal{T} representing the conformal models of G consists of:

- four CA-modules of G , $S_1 = \{a, b, c, d\}$, $S_2 = \{f\}$, $S_3 = \{g\}$, $S_4 = \{h, i\}$, represented by vertices a, f, g , and h , respectively.
- the slots $S_1^0 = \{a^0, b^0, c^1, d^0, e^1\}$, $S_1^1 = \{a^1, b^1, c^0, d^1, e^0\}$, $S_2^0 = \{f^0\}$, $S_2^1 = \{f^1\}$, $S_3^0 = \{g^0\}$, $S_3^1 = \{g^1\}$, $S_4^0 = \{h^0, i^1\}$, $S_4^1 = \{h^1, i^0\}$,
- the transitive orientations $\prec_{S_1}, \prec_{S_2}, \prec_{S_3}, \prec_{S_4}$, where \prec_{S_1} consists of the pairs $\{b \prec_{S_1} a, c \prec_{S_1} a, d \prec_{S_1} a, e \prec_{S_1} a, c \prec_{S_1} b, e \prec_{S_1} d\}$, \prec_{S_4} consists of the pair $\{i \prec_{S_4} h\}$, \prec_{S_2} and \prec_{S_3} are empty,
- the set $\Pi = \{\pi, \pi^R\}$ of circular order of the slots, where $\pi = S_1^1 S_2^1 S_4^1 S_1^0 S_3^0 S_4^0 S_3^1 S_2^0$ and π^R is the reflection of π .

3.2. CA-modules, slots, metachords and their admissible models. In this subsection we first describe the structure of the admissible models for a single metachord of G . Then, we show how we can read out CA-modules, slots, and metachords of G from some conformal model of G .

3.2.1. The structure of the admissible models. Let S be a CA-module of G and let $\mathbb{S} = (S^0, S^1, \prec_S)$ be the metachord associated with S . Due to Theorem 2.2, the models τ admissible by \mathbb{S} are in the correspondence with the transitive orientations \prec_τ of the permutation graph (S, \sim) . Transitive orientations of (S, \sim) are in turn represented by the modular decomposition tree $\mathcal{M}(S, \sim)$ of the graph (S, \sim) : Theorem 2.4 asserts that each transitive orientation \prec_τ of (S, \sim) is uniquely determined by transitive orientations

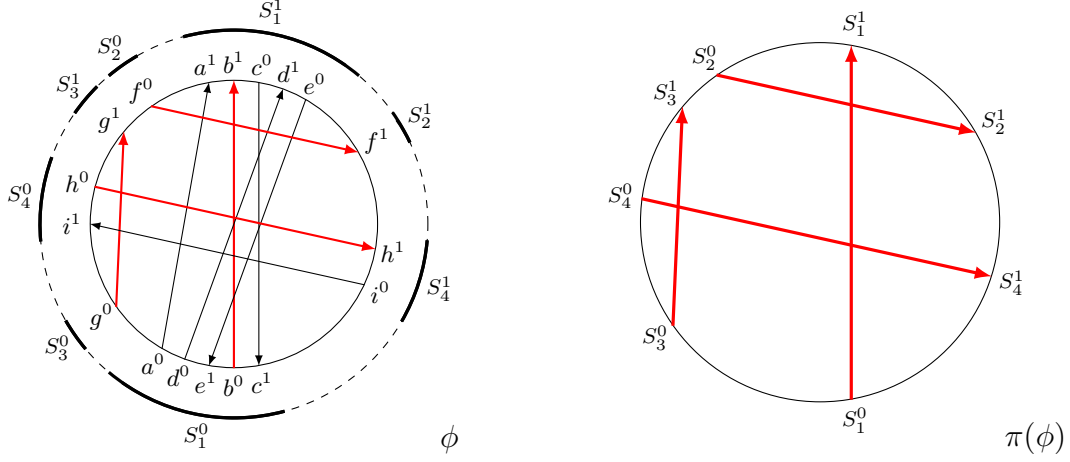

FIGURE 3.1. A conformal model ϕ of G and the circular order of the slots $\pi(\phi)$ in ϕ .

\prec_{τ}^M of the graphs (M, \sim_M) , where M runs over all inner nodes in $\mathcal{M}(S, \sim)$. The modular decomposition tree $\mathcal{M}(S, \sim)$ will be the part of \mathcal{T} , denoted by \mathcal{T}_S , and the inner nodes of \mathcal{T}_S for $S \in \mathcal{S}$ will be called M -nodes of \mathcal{T} .

Figure 3.2 shows a modular decomposition tree \mathcal{T}_S of (S, \sim) for some CA-module S and its admissible model $\tau = (\tau^0, \tau^1)$. M-node S is prime and hence (S, \sim_S) has two transitive orientations, M-node A_2 is serial with three children and hence (A_2, \sim_{A_2}) has $3!$ transitive orientations corresponding to the permutations of the children of A_2 . The remaining M-nodes A_3, B_2, B_3 are parallel and each graph $(A_3, \sim_{A_3}), (B_2, \sim_{B_2}), (B_3, \sim_{B_3})$ has one empty transitive orientation. Hence, the metachord \mathbb{S} has 12 different admissible models, corresponding to $12 = 2 \cdot 3!$ transitive orientations of (S, \sim) .

In this paper we represent the models admissible for \mathbb{S} the following way. Firstly, we extend the notion of the metachord on the set of all nodes in \mathcal{T}_S : for a node $M \in \mathcal{T}_S$ the *metachord* \mathbb{M} associated with M is the triple (M^0, M^1, \prec_M) , where $M^0 = M^* \cap S^0$, $M^1 = M^* \cap S^1$, and \prec_M equals to \prec_S restricted to M . Secondly, for every M-node M we define the set $\Pi(M)$ of *admissible orderings* of M , as follows: for every transitive orientation \prec_M of (M, \sim_M) we define an element $\pi_M = (\pi^0, \pi^1)$ in the set $\Pi(M)$, where for $j \in \{0, 1\}$ the word π^j is a permutation of the set $\{K^j : K \text{ is a child of } M\}$ such that for every two distinct children K, L of M we have:

$$(3) \quad \begin{aligned} K^0 \text{ occurs before } L^0 \text{ in } \pi^0 &\iff K \prec_M L \text{ or } K <_M L, \\ K^1 \text{ occurs before } L^1 \text{ in } \pi^1 &\iff K \prec_M L \text{ or } L <_M K. \end{aligned}$$

Note that, by Theorem 2.3, for every model $\tau = (\tau^0, \tau^1)$ admissible for \mathbb{S} and every node M in \mathcal{T}_S the sets M^0 and M^1 form contiguous subwords, say $\tau^0|_{M^0}$ and $\tau^1|_{M^1}$, in the words τ^0 and τ^1 , respectively. Now, for every M-node M in \mathcal{T}_S let $\tau|_M$ denote the pair $(\tau^0|_M, \tau^1|_M)$, where the word $\tau^j|_M$ is obtained from the word $\tau^j|_{M^j}$ by replacing its contiguous subword $\tau^j|_{K^j}$ by the letter K^j , for every child K of M in \mathcal{T}_S – see Figure 3.2

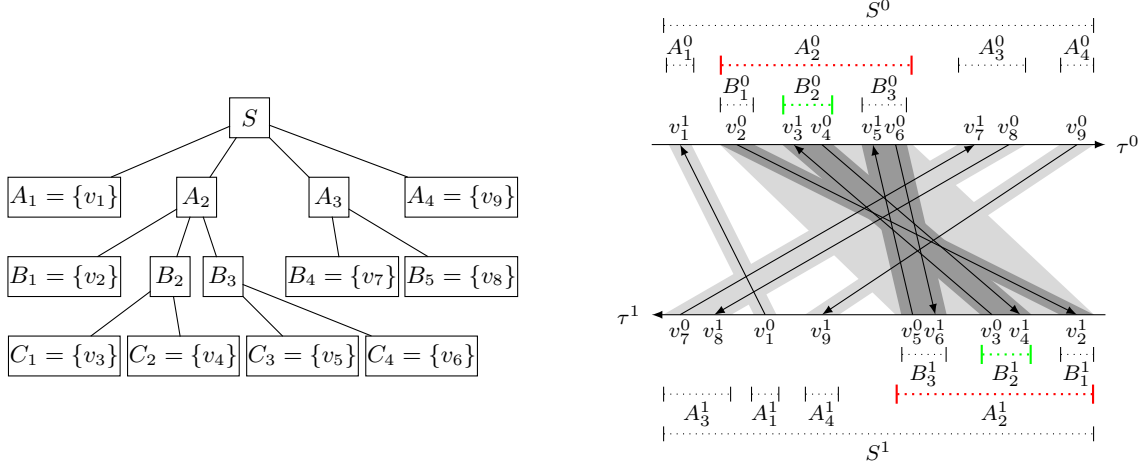

FIGURE 3.2. Modular decomposition tree \mathcal{T}_S of CA-module S (to the left) and its admissible model $\tau = (\tau^0, \tau^1)$. We have $\tau^0|A_2^0 = v_2^0 v_3^0 v_4^0 v_5^0 v_6^0$ and $\tau^1|A_2^1 = v_2^1 v_4^1 v_3^0 v_6^1 v_5^0$ (depicted by red intervals) and $\tau^0|B_2^0 = v_3^0 v_4^0$ and $\tau^1|B_2^1 = v_4^1 v_3^0$ (depicted by green intervals), $\tau|_S = (A_1^0 A_2^0 A_3^0 A_4^0, A_2^1 A_4^1 A_1^1 A_3^1)$ and $\tau|_{A_2} = (B_1^0 B_2^0 B_3^0, B_1^1 B_2^1 B_3^1)$.

for an illustration. Note that $\tau|_M$ is a member of $\Pi(M)$. Summing up, Theorems 2.2 and 2.4 yield the following:

Theorem 3.2. *There is a bijection between the set $\Phi^\mathbb{S}$ of admissible models for the metachord \mathbb{S} and the set $\Phi_\diamond^\mathbb{S}$, where*

$$\Phi_\diamond^\mathbb{S} = \left\{ \left\{ (M, \pi_M) : \begin{array}{l} M \text{ is an inner node in } \mathcal{T}_S \text{ and} \\ \pi_M \text{ is an admissible ordering from } \Pi(M) \end{array} \right\} \right\},$$

established by

$$\Phi^\mathbb{S} \ni \tau \longrightarrow \left\{ (M, \tau|_M) : M \text{ is an } M\text{-node in } \mathcal{T}_S \right\} \in \Phi_\diamond^\mathbb{S}.$$

Finally, suppose ϕ is a conformal model of G and $\tau = (\tau^0, \tau^1)$ is an admissible model for \mathbb{S} spanned between S^0 and S^1 (that is, $(\phi|S^0, \phi|S^1) = (\tau^0, \tau^1)$). Let ϕ^R be the reflection of ϕ and let $\mu = (\mu^0, \mu^1)$ be an admissible model for \mathbb{S} spanned between S^0 and S^1 (that is, $(\phi^R|S^0, \phi^R|S^1) = (\mu^0, \mu^1)$). Note that μ and τ are related: μ^0 is the reflection of τ^1 and μ^1 is the reflection of τ^0 , and hence we say μ is the *reflection of τ* – see Figure 3.3. Observe also that, if τ and μ correspond to transitive orientations \prec^τ and \prec^μ of (S, \sim) , then \prec^μ is the reverse of \prec^τ . In particular, for every prime M -node M in \mathcal{T}_S , the set $\Pi(M)$ has two admissible orderings, one being the reflection of the other – see Figure 3.3.

3.2.2. Determining CA-modules, slots, and metachords. In this section we show how to read out CA-modules, slots, and metachords of G from some conformal model ϕ of G . For a combinatorial definition we refer the reader to [17].

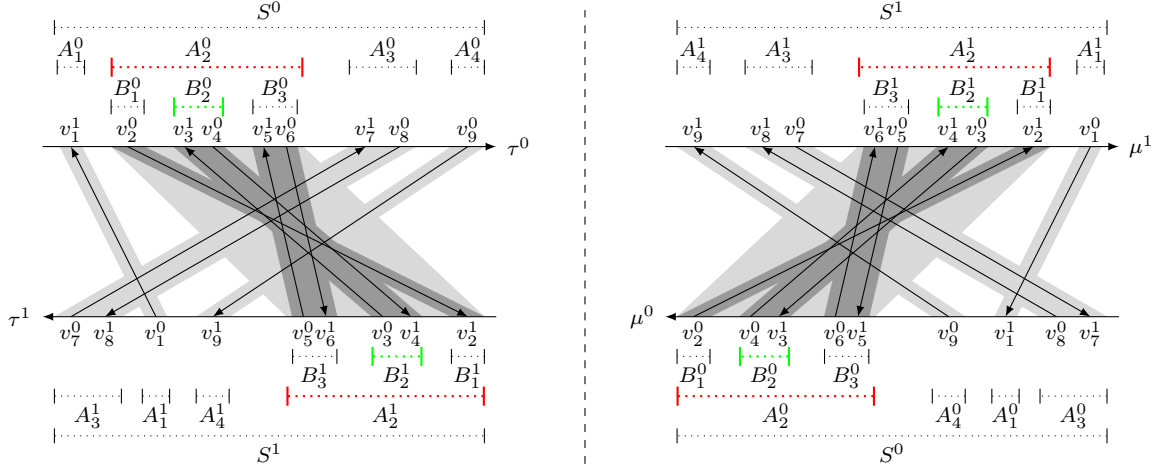

FIGURE 3.3. Admissible model $\tau = (\tau^0, \tau^1)$ (to the left) and its reflection $\mu = (\mu^0, \mu^1)$ (to the right). Prime M-node S has two admissible orderings: $(A_1^0 A_2^0 A_3^0 A_4^0, A_2^1 A_4^1 A_1^1 A_3^1)$ and its reflection $(A_3^0 A_1^0 A_4^0 A_2^0, A_4^1 A_3^1 A_2^1 A_1^1)$.

First, for every child M of the root node V of $\mathcal{M}(G_{ov})$, we define the set $\mathcal{S}(M)$ of *CA-modules of G contained in M* , as follows: S is a member of $\mathcal{S}(M)$ if S is a maximal submodule of M (not necessarily strong) such that the chords of $\phi(S)$ form a *valid oriented permutation model of (S, \sim)* in ϕ , which means that the letters of S^* form either two contiguous subwords $\tau^0(S)$ and $\tau^1(S)$ in ϕ or one contiguous subword of the form $\tau^0(S)\tau^1(S)$, where $(\tau^0(S), \tau^1(S))$ is an oriented permutation model of (S, \sim) . It is shown in [17] that for every child M of V in $\mathcal{M}(G_{ov})$ the set $\mathcal{S}(M)$ forms a partition of M . Finally, we set

$$\mathcal{S} = \bigcup \{ \mathcal{S}(M) : M \text{ is a child of } V \text{ in } \mathcal{M}(G_{ov}) \}.$$

Assume that $\mathcal{S} = \{S_1, \dots, S_t\}$. For every $S_i \in \mathcal{S}$ we pick a vertex $s_i \in S_i$ representing the set S_i . We assume $s_i^0 \in \tau^0(S_i)$ and $s_i^1 \in \tau^1(S_i)$ (we assert $s_i^0 \in \tau^0(S_i)$ by possibly swapping the superscripts in $\tau^0(S_i)$ and $\tau^1(S_i)$). We define the metachord $\mathbb{S}_i = (S_i^0, S_i^1, <_{S_i})$ for CA-module S_i such that:

- S_i^0 contains the letters from the word $\tau^0(S_i)$,
- S_i^1 contains the letters from the word $\tau^1(S_i)$,
- assuming $<^\tau$ and \prec^τ are the transitive orientations of (S_i, \parallel) and (S_i, \sim) corresponding to the oriented permutation model $(\tau^0(S_i), \tau^1(S_i))$ of (S_i, \sim) , we set $<_{S_i} = <^\tau$.

It is shown in [17] that the slots $S_1^0, S_1^1, \dots, S_t^0, S_t^1$ satisfy property (P1) and the metachords $\mathbb{S}_1, \dots, \mathbb{S}_t$ satisfy property (P2).

3.3. PQ-trees. As we mentioned, the set Π may contain exponentially many members, but it has a linear-size representation by means of the PQ-tree \mathcal{T}^{PQ} , which is the part of \mathcal{T} . To define \mathcal{T}^{PQ} we need some preparation. Let Q_0 and Q_1 be two components of G_{ov} . We say the components Q_0 and Q_1 are *separated* if there is $v \in V \setminus (Q_0 \cup Q_1)$

such that $Q_i \subseteq \text{left}(v)$ and $Q_{1-i} \subseteq \text{right}(v)$ for some $i \in \{0, 1\}$; otherwise, Q_0 and Q_1 are *neighbouring*. See Figure 3.4 for an illustration.

The PQ-tree \mathcal{T}^{PQ} is an unrooted tree. The leaf nodes of \mathcal{T}^{PQ} are in the correspondence with the slots of G . The non-leaf nodes of \mathcal{T}^{PQ} are labelled either by the letter P (*P-nodes*) or the letter Q (*Q-nodes*): Q-nodes are in the correspondence with the connected components of G_{ov} and P-nodes are in the correspondence with the maximal sets consisting of at least two pairwise neighbouring Q-nodes. We refer to non-leaf nodes of \mathcal{T}^{PQ} as *PQ-nodes* of \mathcal{T}^{PQ} . We add an edge between a Q-node Q and a P-node P if $Q \in P$ and we add an edge between a slot S_j^i and a Q-node Q if $S_i \subseteq Q$. See Figure 3.4 for an illustration.

Note that \mathcal{T}^{PQ} consist a single inner node V in the case when V is serial/prime in $\mathcal{M}(G_{ov})$.

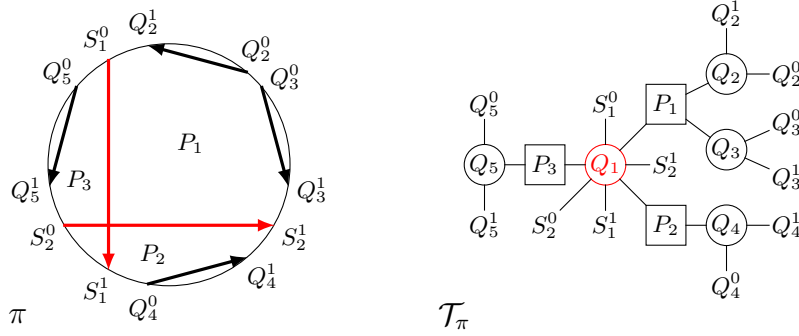

FIGURE 3.4. To the left: circular order of the slots π in some conformal model of a circular-arc graph G for the case when V is parallel in $\mathcal{M}(G_{ov})$, Q_1, Q_2, Q_3, Q_4, Q_5 are the connected components of G_{ov} , $\mathcal{S}(Q_1) = \{S_1, S_2\}$ and $\mathcal{S}(Q_i) = \{Q_i\}$ for $i \in [2, 5]$. Components Q_4 and Q_5 are separated by any vertex from Q_1 , components Q_2 and Q_5 are separated by any vertex from S_1 . P-nodes P_1, P_2 , and P_3 correspond to maximal sets consisting of ≥ 2 pairwise neighbouring modules: $\{Q_1, Q_2, Q_3\}$, $\{Q_1, Q_4\}$, and $\{Q_1, Q_5\}$, respectively. We have $\mathcal{S}^*(Q_1 \rightarrow P_1) = \{Q_2^0, Q_2^1, Q_3^0, Q_3^1\}$, $\mathcal{S}^*(P_1 \rightarrow Q_1) = \{S_1^0, S_1^1, S_2^0, S_2^1, Q_4^0, Q_4^1, Q_5^0, Q_5^1\}$. We have $\pi|_{Q_1} \equiv S_1^0 P_1 S_1^1 P_2 S_1^1 S_2^0 P_3$ and $\pi|_{P_1} \equiv Q_1 Q_2 Q_3$. To the right: PQ-tree \mathcal{T}_π^{PQ} representing π .

Before we describe the way in which the PQ-tree \mathcal{T}^{PQ} represents Π , we need to list some of its properties. Let Q be a Q-node and P be a P-node such that Q and P are adjacent in \mathcal{T}^{PQ} . When we delete the edge QP from \mathcal{T}^{PQ} , we obtain a forest consisting of two trees, $\mathcal{T}_{Q \rightarrow P}^{PQ}$ and $\mathcal{T}_{P \rightarrow Q}^{PQ}$, where the node P is in $\mathcal{T}_{Q \rightarrow P}^{PQ}$ and the node Q is in $\mathcal{T}_{P \rightarrow Q}^{PQ}$. Let $\mathcal{S}^*(Q \rightarrow P)$ and $\mathcal{S}^*(P \rightarrow Q)$ denote the sets of slots contained in the trees $\mathcal{T}_{Q \rightarrow P}^{PQ}$ and $\mathcal{T}_{P \rightarrow Q}^{PQ}$, respectively. In [17] the following property of every $\pi \in \Pi$ with respect to Q and P is shown:

- the slots from the set $\mathcal{S}^*(Q \rightarrow P)$ form a contiguous subword in π ,
- the slots from the set $\mathcal{S}^*(P \rightarrow Q)$ form a contiguous subword in π .

See Figure 3.4. The above properties allows us to denote:

- for every Q-node Q by $\pi|_Q$ the circular word obtained from π by substituting the contiguous subword $\mathcal{S}^*(Q \rightarrow P)$ by the letter P , for every P-node P adjacent to M ,
- for every P-node P by $\pi|_P$ the circular word obtained from π by substituting the contiguous subword $\mathcal{S}^*(P \rightarrow Q)$ by the letter Q , for every Q-node Q adjacent to P .

See Figure 3.4. Thus, we have defined the word $\pi|_N$ for every inner node N in \mathcal{T}^{PQ} ; note that $\pi|_N$ is a circular ordering of the nodes adjacent to N in \mathcal{T}^{PQ} .

The set Π is represented by means of the sets of *admissible orderings* $\Pi(N)$ of inner nodes N of \mathcal{T}^{PQ} , where each member of $\Pi(N)$ is a circular order of the nodes adjacent to N in \mathcal{T}^{PQ} . The sets $\Pi(N)$ are defined so as the following property holds:

(P4): There is a one-to-one correspondence between the set Π and the set Π_\diamond , where

$$\Pi_\diamond = \left\{ \left\{ (N, \pi_N) : \begin{array}{l} N \text{ is an inner node in } \mathcal{T}^{PQ} \text{ and} \\ \pi_N \text{ is an admissible ordering from } \Pi(N) \end{array} \right\} \right\},$$

established by

$$\Pi \ni \pi \quad \longrightarrow \quad \left\{ (N, \pi|_N) : N \text{ is an inner node in } \mathcal{T}^{PQ} \right\} \in \Pi_\diamond.$$

Let $\pi \in \Pi$. The set $\left\{ (N, \pi|_N) : N \text{ is a PQ-node in } \mathcal{T}^{PQ} \right\}$ from Π_\diamond corresponding to π induces a plane drawing \mathcal{T}_π^{PQ} of the tree \mathcal{T}^{PQ} in which for every PQ-node N the clockwise order of the neighbours of N is given by $\pi|_N$. Note that the circular word obtained by listing all the slots when walking the boundary of \mathcal{T}_π^{PQ} in the clockwise order coincides with π , and hence we say that \mathcal{T}_π^{PQ} *represents* π .

The sets $\Pi(\cdot)$ are defined differently depending on whether the module V is prime, serial, or parallel in $\mathcal{M}(G_{ov})$. In any case, however, the sets $\Pi(\cdot)$ can be read out easily from $\pi(\phi)$.

3.3.1. V is serial in $\mathcal{M}(G_{ov})$. It is shown in [17] that we have $\mathcal{S}(M) = \{M\}$ for any child M of V in $\mathcal{M}(G_{ov})$, and hence the set \mathcal{S} of CA-modules of G consists of the children of V in $\mathcal{M}(G_{ov})$. Assume that $\mathcal{S} = \{S_1, \dots, S_t\}$. Since V is serial, (S_i, \parallel) is connected for every $i \in [t]$ and $S_i \sim S_j$ for every two distinct $i, j \in [t]$. The set $\Pi(V)$ is defined such that

$$\Pi(V) = \left\{ \pi : \begin{array}{l} \pi \text{ is a circular order of } S_1^0, S_1^1, \dots, S_t^0, S_t^1 \text{ such that for every} \\ \text{distinct } i, j \in [t] \text{ the slots corresponding to } S_i \text{ and } S_j \text{ overlap} \end{array} \right\}.$$

The PQ-tree \mathcal{T}^{PQ} consists of the single *serial* Q-node V and the leaf nodes from \mathcal{S}^* adjacent to V . In particular, we have $\Pi = \Pi(V)$. See Figure 3.5 for an illustration.

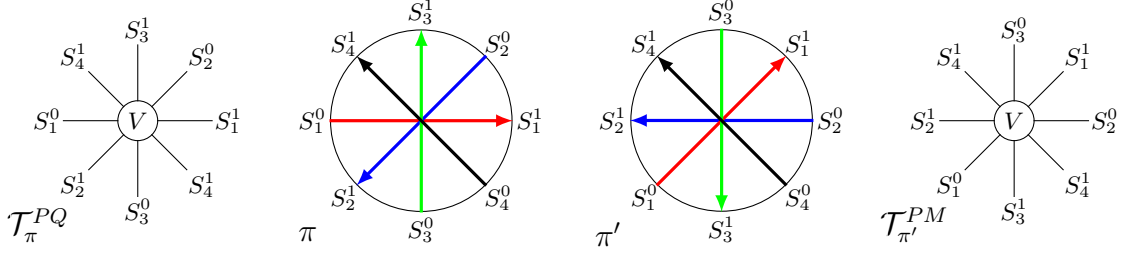

FIGURE 3.5. Two members π and π' of the set Π and the trees \mathcal{T}_π^{PQ} and $\mathcal{T}_{\pi'}^{PM}$ representing π and π' for the case when V is serial in $\mathcal{M}(G_{ov})$: π' is obtained from π by swapping the red and blue metachords and by flipping the orientation of the green metachord.

3.3.2. V is prime in $\mathcal{M}(G_{ov})$. Let M be a child of V in $\mathcal{M}(G_{ov})$. It is shown in [17] that if M is prime, then $\mathcal{S}(M) = \{M\}$ and if M is serial/parallel, then every module from $\mathcal{S}(M)$ is the union of some children of M in $\mathcal{M}(G_{ov})$. Assume that $\mathcal{S} = \{S_1, \dots, S_t\}$ and $\pi = \pi(\phi)$. We set

$$\Pi(V) = \{\pi, \pi^R\},$$

where π^R is the reflection of π . The PQ-tree \mathcal{T}^{PQ} consists of the single *prime* Q-node V and the leaf nodes from \mathcal{S}^* adjacent to V . We have $\Pi = \Pi(V)$. See Figure 3.6 for an illustration.

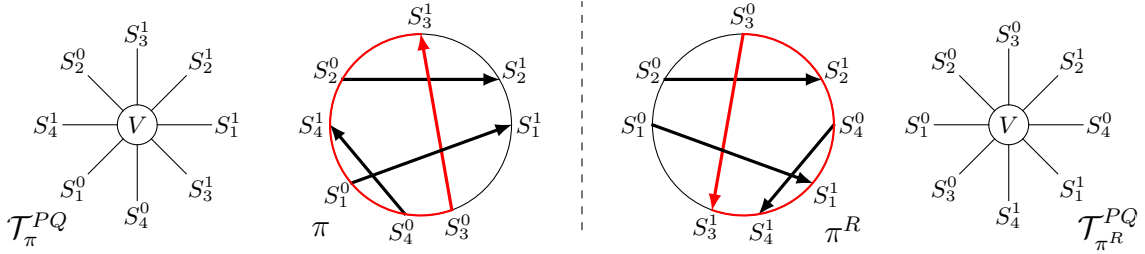

FIGURE 3.6. Two members π and π^R of the set Π and the trees \mathcal{T}_π^{PQ} and $\mathcal{T}_{\pi^R}^{PQ}$ representing π and π^R for the case when V is prime in $\mathcal{M}(G_{ov})$: $\pi^R \equiv S_2^1 S_4^0 S_1^1 S_4^1 S_3^1 S_1^0 S_2^0 S_3^0$ is the reflection of $\pi \equiv S_3^1 S_2^1 S_1^1 S_3^0 S_4^0 S_1^0 S_4^1 S_2^0$.

3.3.3. V is parallel in $\mathcal{M}(G_{ov})$. In this case the children of V in $\mathcal{M}(G_{ov})$ correspond to the connected components of G_{ov} , which in turn correspond to Q-nodes in \mathcal{T}^{PQ} . Also, we recall that $\mathcal{S}(Q)$ forms a partition of Q , for every Q-node Q of \mathcal{T}^{PQ} .

Let $\pi = \pi(\phi)$ be the circular order of the slots in ϕ . For every PQ-node N in \mathcal{T}^{PQ} we define the set $\Pi(N)$, where:

- for a P-node P the set $\Pi(P)$ contains all circular orders of the M-nodes adjacent to P ,
- for a Q-node Q the set $\Pi(Q)$ contains two members: $\pi|_Q$ and its reflection $(\pi|_Q)^R$.

We note that when $\mathcal{S}(Q) = \{Q\}$ then we have $\pi|_Q \equiv (\pi|_Q)^R$. Also, note that any circular order of the slots in Π can be obtained by performing a sequence of the operations on the tree \mathcal{T}_π^{PQ} , where each of them either

- *reflects a Q-node*, or
- *permutes arbitrarily the neighbours of a P-node*.

The reflection of a Q-node Q transforms π into π' , where the only difference between the trees \mathcal{T}_π^{PQ} and $\mathcal{T}_{\pi'}^{PQ}$ is on the node M : \mathcal{T}_π^{PQ} orders the neighbours of Q consistently with $\pi|_Q$ and $\mathcal{T}_{\pi'}^{PQ}$ orders the neighbours of Q consistently with the reflection of $\pi|_Q$ (that is, we have $\pi'|_Q \equiv (\pi|_Q)^R$). See Figure 3.7 for an illustration.

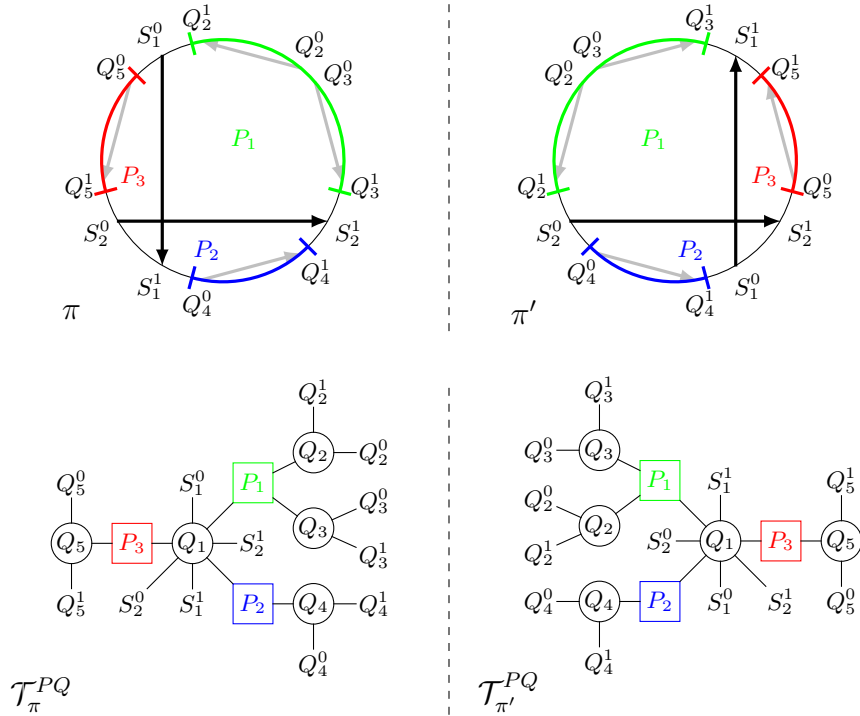

FIGURE 3.7. Reflection of Q_1 . Circular orders of the slots π and π' and the trees \mathcal{T}_π^{PQ} and $\mathcal{T}_{\pi'}^{PQ}$ representing π and π' . The tree $\mathcal{T}_{\pi'}^{PQ}$ is obtained from \mathcal{T}_π^{PQ} by reflecting the node Q_1 : we have $\pi|_{Q_1} \equiv S_1^0 P_1 S_2^1 P_2 S_1^1 S_2^0 P_3$ and $\pi'|_{Q_1} \equiv (\pi|_{Q_1})^R \equiv P_3 S_2^1 S_1^0 P_2 S_2^0 P_1 S_1^1$.

A permutation of a P-node P transforms π into π' , where the only difference between the trees \mathcal{T}_π^{PQ} and $\mathcal{T}_{\pi'}^{PQ}$ is on the node P : \mathcal{T}_π^{PQ} orders the neighbours of Q consistently with $\pi|_P$ and $\mathcal{T}_{\pi'}^{PQ}$ orders the neighbours of Q consistently with $\pi'|_P$, where $\pi'|_P$ is any circular ordering of the neighbours of P . See Figure 3.8 for an illustration.

3.4. The structure of the conformal models of G . In order to describe the structure of conformal models of G in the way we will use it in this paper, we extend the tree

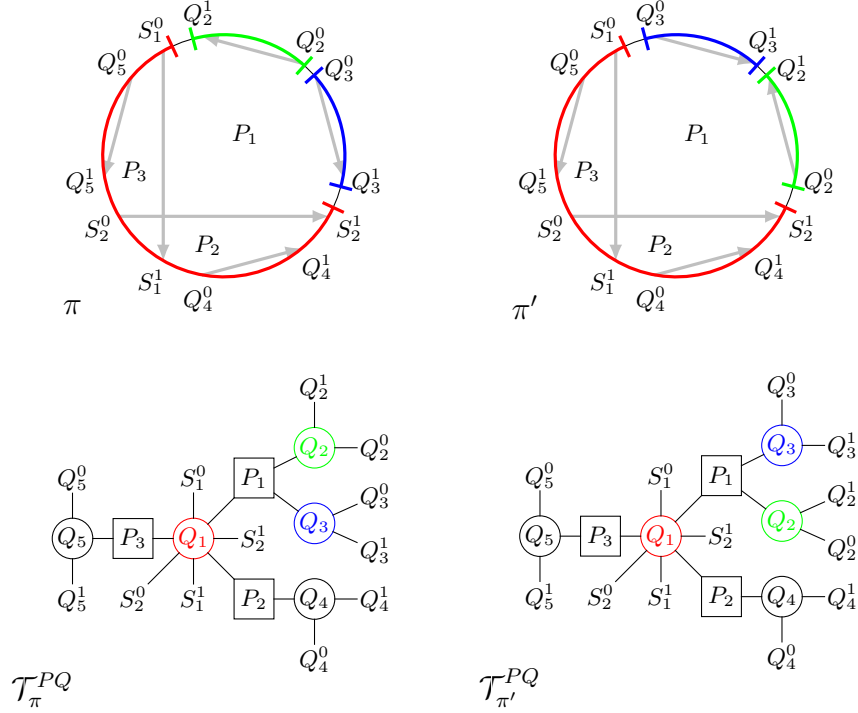

FIGURE 3.8. Permuting the neighbours of P_1 . Circular orders of the slots π and π' and the trees \mathcal{T}_π^{PQ} and $\mathcal{T}_{\pi'}^{PQ}$ representing π and π' . The tree $\mathcal{T}_{\pi'}^{PQ}$ is obtained from \mathcal{T}_π^{PQ} by permuting the neighbours of P_1 : we have $\pi|_{P_1} \equiv Q_1Q_2Q_3$ and $\pi'|_{P_1} \equiv Q_1Q_3Q_2$, where $\mathcal{S}(Q_1) = \{S_1, S_2\}$.

\mathcal{T}^{PQ} by attaching, for every Q-node Q and every $S \in \mathcal{S}(Q)$, the root S of the modular decomposition tree \mathcal{T}_S to the node Q . This way we obtain the PQM-tree \mathcal{T} . Finally, to simplify our notation, for every Q-node Q we denote by \mathcal{T}_Q the subtree of \mathcal{T} rooted in Q restricted to the node Q and the nodes in the trees \mathcal{T}_S for $S \in \mathcal{S}(Q)$.

Let ϕ be any conformal model of G . Now, for every PQM-node N (that is, for N which is either P-node, Q-node, or M-node in \mathcal{T}) by $\phi|_N$ we denote an *admissible ordering* of N induced by the model ϕ , defined such that:

- $\phi|_N = \pi(\phi)|_N$ if N is a PQ-node in \mathcal{T} ,
- $\phi|_N = (\phi|_{S^0}, \phi|_{S^1})|_N$ if N is an M-node in \mathcal{T} .

Finally, we can summarize this section with the following theorem.

Theorem 3.3. *There is a bijection between the set Φ of conformal models of G and the set Φ_\diamond , where*

$$\Phi_\diamond = \left\{ \left\{ (N, \pi_N) : \begin{array}{l} N \text{ is an PQM-node in } \mathcal{T} \text{ and} \\ \pi_N \text{ is an admissible ordering from } \Pi(N) \end{array} \right\} \right\},$$

established by

$$\Phi \ni \phi \quad \longrightarrow \quad \left\{ (N, \phi|_N) : N \text{ is a PQM-node in } \mathcal{T} \right\} \in \Phi_\diamond.$$

3.5. Conformal models and the Helly property: notation and basic properties.

Let $G = (V, E)$ be a circular-arc graph and let \mathcal{T} be the PQM-tree of G .

Let M be an M-node in \mathcal{T} . We say a vertex $a \in M$ is (M^j, M^{1-j}) -oriented in the metachord \mathbb{M} if $a^0 \in M^j$ and $a^1 \in M^{1-j}$. Clearly, if a is (M^j, M^{1-j}) -oriented in \mathbb{M} , then a is (S^j, S^{1-j}) -oriented in \mathbb{S} , where S is a CA-module containing M .

Let C_1, \dots, C_k be some fixed cliques of G . A circular word ϕ over the letters $V^* \cup \{C_1, \dots, C_k\}$ is a $\{C_1, \dots, C_k\}$ -conformal model of G if:

(H1): $\phi|_{V^*}$ is a conformal model of G .

(H2): For every $i \in [k]$ and every $a \in C_i$ the point $\phi(C_i)$ lies on the left side of the chord $\phi(a)$.

Clearly, every conformal model of G in which the cliques C_1, \dots, C_k satisfy the Helly property might be extended to a $\{C_1, \dots, C_k\}$ -conformal model. We abuse slightly our notation, and for a $\{C_1, \dots, C_k\}$ -conformal model of G , an M-node M , and $j \in \{0, 1\}$, by $\phi|M^j$ we denote the shortest contiguous subword of ϕ containing all the letters from M^j and no letter from the set M^{1-j} .

Let M be an M-node in \mathcal{T} and let C_i be a clique from $\{C_1, \dots, C_k\}$. We say C_i is *private* for M (or M is an *owner* of C_i) if there are two distinct vertices in $C_i \cap M$ with different orientations in \mathbb{M} . We say C_i is *private* if C_i is private for some M-node in \mathcal{T} ; otherwise we say C_i is *public*.

Lemma 3.4. *Let M be an M-node in \mathcal{T} and let $C_i \in \{C_1, \dots, C_k\}$ be such that C_i is private for M . Then:*

- (1) *For every $\{C_1, \dots, C_k\}$ -conformal model ϕ of G the letter C_i occurs either in $\phi|M^0$ or in $\phi|M^1$.*
- (2) *Suppose $M \subseteq S$ for some CA-module S . Then the clique C_i is private for every M-node M' lying on the path from M to S in \mathcal{T}_S . In particular, the letter C_i occurs either in the slot $\phi|S^0$ or in the slot $\phi|S^1$ in any $\{C_1, \dots, C_k\}$ -conformal model ϕ of G .*

Proof. First we prove (1). Since C_i is private for M , there are $a, b \in C_i \cap M$ such that a is (M^0, M^1) -oriented and b is (M^1, M^0) -oriented in \mathbb{M} . It means that $a^0, b^1 \in M^0$ and $a^1, b^0 \in M^1$. Since $\phi(C_i)$ is to the left of $\phi(a)$ and $\phi(b)$, C_i must be contained either between a^0 and b^1 or between b^0 and a^1 in ϕ . In the first case C_i is contained in $\phi|M^0$ and in the second case C_i is contained in $\phi|M^1$. Statement (2) follows from the fact that $M \subseteq M' \subseteq S$. \square

Clearly, every $\{C_1, \dots, C_k\}$ -conformal model of G can be turned into $\{C_1, \dots, C_k\}$ -conformal model ϕ of G such that:

(H3): For every $i \in [k]$ and every M-node M of \mathcal{T} such that C_i is not private for M the letter C_i does not occur in the words $\phi|M^0$ and $\phi|M^1$.

Indeed, if C_i is not private for M , then all the vertices from $C_i \cap M$ have the same orientation in M , and we can simply push out the clique letter C_i from $\phi|M^j$ whenever C_i is contained in $\phi|M^j$, for any $j \in \{0, 1\}$. In particular, if C_i is public and (H3) holds, then C_i occurs outside the slot $\phi|S^j$ for every $j \in \{0, 1\}$ and every $S \in \mathcal{S}$. In the rest of the paper we assume $\{C_1, \dots, C_k\}$ -conformal models of G satisfy additionally the property (H3).

4. AN ALTERNATIVE PROOF OF THE LIN-SZWARCFITER THEOREM

In [19] Lin and Szwarcfiter have proved the following:

Theorem 4.1. *Let G be a circular-arc graph. Either every normalized model of G satisfies the Helly property or every normalized model of G does not satisfy the Helly property.*

Let G be a circular-arc graph, $G_{ov} = (V, \sim)$ be the overlap graph of G , and \mathcal{T} be the PQM-tree representing the conformal models of G .

Definition 4.2. *Let C be a clique in G of size $k \geq 3$ and let ϕ be a conformal model of G . We say C forms a non-Helly structure in ϕ if*

$$\phi|C \equiv v_0^0 v_2^1 v_1^0 v_3^1 \dots v_{k-2}^0 v_0^1 v_{k-1}^0 v_1^1$$

for some circular order v_0, \dots, v_{k-1} of the vertices of C .

See Figure 4.1 for an illustration. Note that whenever C forms a non-Helly clique in ϕ and $\phi|C \equiv v_0^0 v_2^1 v_1^0 v_3^1 \dots v_{k-2}^0 v_0^1 v_{k-1}^0 v_1^1$ for a circular order v_0, \dots, v_{k-1} of the vertices of C , then for every two distinct $i, j \in [0, k-1]$:

- $v_i \sim v_j$ if $(i-j)_{\text{mod } k} \in \{1, k-1\}$,
- v_i, v_j cover the circle if $(i-j)_{\text{mod } k} \notin \{1, k-1\}$.

In particular, C induces a cycle in G_{ov} with the consecutive vertices v_0, \dots, v_{k-1} .

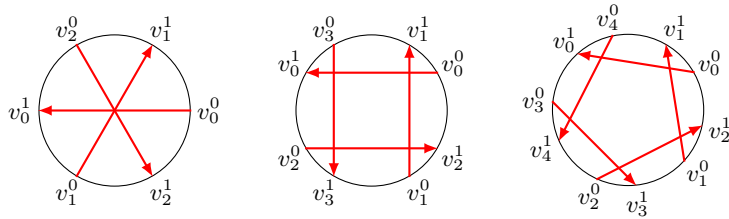

FIGURE 4.1. Non-Helly structures for $k = 3, 4, 5$

The proof of Theorem 4.1 by Lin and Szwarcfiter is based on the following:

Lemma 4.3 ([19]). *Let ϕ be a conformal model of G and let C be a clique in G . Then C is minimal with respect to inclusion non-Helly clique in ϕ if and only if C forms a non-Helly structure in ϕ .*

In particular, if ϕ does not satisfy the Helly property, there is a clique C in G which is non-Helly in ϕ , and then every minimal non-Helly subclique of C forms a non-Helly structure in G .

Definition 4.4. Let C be a clique in G of size $k \geq 3$. We say C is a rigid non-Helly clique in G if C forms a non-Helly structure in every conformal model of G .

In the next two claims we describe the cliques in G that form rigid non-Helly cliques in G . In the course of the proof of Theorem 4.1 we will show that G contains no other rigid non-Helly cliques.

Claim 4.5. Let C be a clique of G that forms a non-Helly structure in a conformal model ϕ of G . If $|C| \geq 4$ then C is a rigid non-Helly clique in G .

Proof. Since C forms a non-Helly structure in ϕ , C induces a cycle in G_{ov} . Since there are two possibilities to represent a cycle of size ≥ 4 as an intersection graph of chords (one is the reflection of the other), we easily deduce that either the circular word $\phi|C$ or its reflection must occur in any conformal model of G . \square

Claim 4.6. Let C be a clique of G which forms a non-Helly structure in a conformal model ϕ of G . Let Q be a component of G_{ov} such that $C \subseteq Q$. If $|C| = 3$, $C \subseteq N$ for a prime node $N \in \mathcal{T}_Q$, and the elements of C are contained in three distinct children of N in \mathcal{T}_Q , then C is a rigid non-Helly clique in G .

Proof. Let ϕ be a conformal model of G . Suppose $C = \{v_0, v_1, v_2\}$ and $\phi|C \equiv v_0^0 v_1^1 v_2^0 v_0^1 v_1^0 v_2^1$. Let $\pi = \phi|_N \in \Pi(N)$ be an ordering of N in ϕ and let $\gamma \in \Pi(N)$ be the reflection of π . Since $\Pi(N) = \{\pi, \gamma\}$ and C has a non-empty intersection with three children of N , for every conformal model ϕ' of G we have:

- $\phi'|C \equiv v_0^0 v_1^1 v_2^0 v_0^1 v_1^0 v_2^1$ if $\phi'|_N = \pi$,
- $\phi'|C \equiv v_2^0 v_1^1 v_0^0 v_2^1 v_0^1 v_1^0$ if $\phi'|_N = \gamma$.

\square

If $C = \{v_0, v_1, v_2\}$, N , and $\pi, \gamma \in \Pi(N)$ are as in the previous claim, then π and γ are said to *force non-Helly structures* $v_0^0 v_1^1 v_2^0 v_0^1 v_1^0 v_2^1$ and $v_2^0 v_1^1 v_0^0 v_2^1 v_0^1 v_1^0$, respectively. See Figure 4.2 for an illustration.

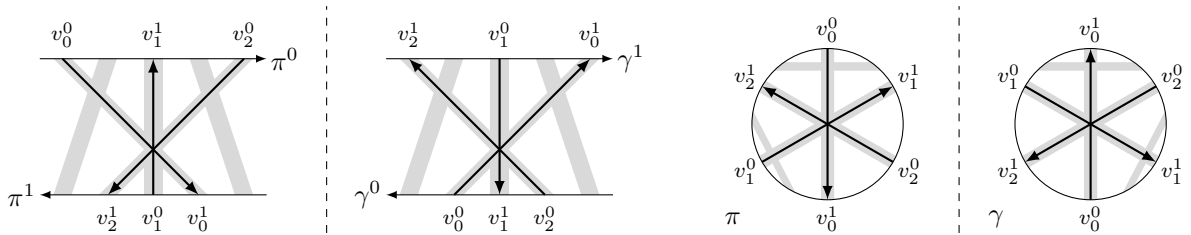

FIGURE 4.2. Orderings π and γ forcing non-Helly structures $v_0^0 v_1^1 v_2^0 v_0^1 v_1^0 v_2^1$ and $v_2^0 v_1^1 v_0^0 v_2^1 v_0^1 v_1^0$, respectively, for the cases N is a prime M-node (to the left) and N is a prime Q-node (to the right).

Our proof of Theorem 4.1 will use the following technical lemma.

Lemma 4.7. Let ϕ be a conformal model of G and let M be an M-node in \mathcal{T} .

- (1) If there are $a, b \in M$ such that $a \sim b$ and $a^0 b^0$ is a subword of $\phi|M^j$ for some $j \in \{0, 1\}$, then there are $c, d \in M$ such that $c \sim d$ and $c^1 a^0 d^1 b^0$ is a subword of $\phi|M^j$ and $a^1 c^0 b^1 d^0$ is a subword of $\phi|M^{1-j}$ (see Figure 4.3 to the left).
- (2) If there are $a, b \in M$ such that $a \sim b$ and $a^1 b^0$ is a subword of $\phi|M^j$ for some $j \in \{0, 1\}$, then there are $c, d \in M$ such that $c \sim d$ and $a^1 c^0 d^1 b^0$ is a subword of $\phi|M^j$ and $c^1 a^0 b^1 d^0$ is a subword of $\phi|M^{1-j}$ (see Figure 4.3 to the right).

Proof. First we prove (1). Since $a \sim b$, b is not contained in a , there exists $c \in V$ such that $ac \notin E(G)$ and $bc \in E(G)$. Therefore, $a^1 c^0 b^1$ is a subword of $\phi|M^{1-j}$. This implies $c \in M$. Therefore, $c^1 a^0 b^0$ is a subword of $\phi|M^j$. Similarly, since $a \sim b$ there exists d such that $ad \in E(G)$ and $bd \notin E(G)$. Therefore, $a^0 d^1 b^0$ is a subword of $\phi|M^j$. This implies $d \in M$ and $a^1 b^1 d^0$ is a subword of $\phi|M^{1-j}$. Combining the above conclusions we have that $c^1 a^0 d^1 b^0$ is a subword of $\phi|M^j$ and $a^1 c^0 b^1 d^0$ is a subword of $\phi|M^{1-j}$, as desired. In particular, this implies $c \sim d$.

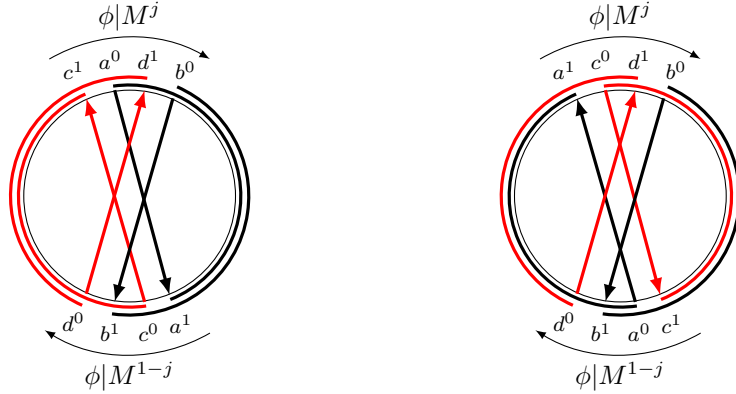

FIGURE 4.3. Illustration of statements (1) (to the left) and (2) (to the right) of Lemma 2.1.

Now we prove (2). Since $a \sim b$, a and b do not cover the circle, and $|M^j \cap \{x^0, x^1\}| = 1$ for every $x \in M$, there exists $c \in V$ such that $ac \notin E(G)$ and $b \sim c$ or there exists $c' \in V$ such that $a \sim c'$ and $bc' \notin E(G)$. Suppose the first case holds (the other case is analogous). Therefore, $a^1 c^0 b^0$ is a subword of $\phi|M^j$. This implies that $c \in M$. Therefore $c^1 a^0 b^1$ is a subword of $\phi|M^{1-j}$. Now, applying Lemma 4.7.(1) to b and c , we get that there is d such that $c^0 d^1 b^0$ is a subword of $\phi|M^j$ and $c^1 b^1 d^0$ is a subword of $\phi|M^{1-j}$. Combining the above conclusions we have that $a^1 c^0 d^1 b^0$ is a subword of $\phi|M^j$ and $c^1 a^0 b^1 d^0$ is a subword of $\phi|M^{1-j}$, as desired. In particular, this implies $c \sim d$. \square

We proceed to the proof of Theorem 4.1. In the course of the proof we also show that G contains no other rigid non-Helly cliques than those defined by Claims 4.5 and 4.6. In the result, we show Theorem 4.8 as a by-product.

Proof of Theorem 4.1. Let ϕ be a non-Helly conformal model of G . We show that any other conformal model ϕ' of G is also non-Helly. Since ϕ is non-Helly, G contains a

minimal non-Helly clique C in ϕ . By Lemma 4.3, C forms a non-Helly structure in ϕ . If C satisfies the assumptions of Claim 4.5 or Claim 4.6, C is non-Helly in ϕ' , and ϕ' is non-Helly. Suppose the other case, that is, suppose $C = \{a, b, c\}$, $C \subseteq Q$ for a component Q of G_{ov} , and suppose N is the deepest node in \mathcal{T}_Q such that $C \subseteq Q$ (that is, $C \subseteq N$ and either C intersects with three children of N and N is serial, or C intersects two children of N).

Let N be a serial node in \mathcal{T}_Q and let $a \in N_a$, $b \in N_b$, and $c \in N_c$ for three distinct children of N . Clearly, N is an M-node or $N = V$ and N is the only inner node in \mathcal{T} . Observe that, since N is serial, $\Pi(N)$ admits an order π such that C is Helly in ϕ whenever $\phi|_N = \pi$. Now, suppose $a^0c^0b^1a^1c^1b^0$ is a circular subword of ϕ' . If N is an M-node, we use Lemma 4.7 to deduce there is $d \in N$ such that $d^1a^0c^0b^1a^1d^0c^1b^0$ is a circular subword of ϕ' . Otherwise, if $N = V$ and V is serial, there is $d \in N_a$ such that $d^1a^0c^0b^1a^1d^0c^1b^0$ is a circular subword of ϕ' as otherwise a would be a universal vertex in G . In any case we deduce $\{b, c, d\}$ forms a non-Helly structure in ϕ' . The other cases are proven analogously.

Assume C intersects exactly two children of N . Assume first that $\{a, b\} \in N_{a,b}$ and $c \in N_c$, where $N_{a,b}$ and N_c are two distinct children of N . Note that $N_{a,b}$ is an M-node in \mathcal{T}_Q . Assume a^0b^1 is a subword of $\phi|_{N_{a,b}^0}$ and a^1b^0 is a subword of $\phi|_{N_{a,b}^1}$. We use Lemma 4.7.(2) to show there are $d, e \in N_{a,b}$ such that $d^1a^0b^1e^0$ is a subword of $\phi|_{N_{a,b}^0}$ and $a^1d^0e^1b^0$ is a subword of $\phi|_{N_{a,b}^1}$. Now, we refer to Figure 4.4 which shows all possible configurations of the oriented chords representing the elements in the set $\{a, b, c, d, e\}$ in conformal models of G .

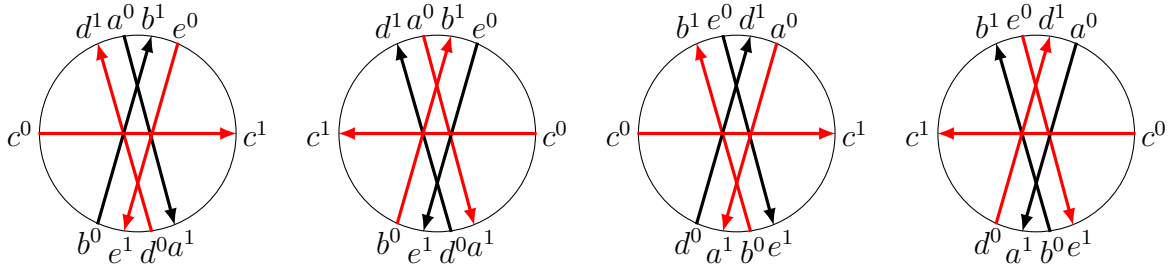

FIGURE 4.4. Forbidden structure (in red) in all possible configurations between oriented chords for a, b, c, d, e .

In any case, note that there is a triple in $\{a, b, c, d, e\}$ which forms a non-Helly structure in G . Also, since each of these configurations occurs in some conformal model of G , $\{a, b, c\}$ satisfies the Helly condition in some conformal model of G . The remaining case $\{a, c\} \in N_{a,c}$ and $b \in N_b$, where $N_{a,c}$ and N_b are two distinct children of N is proven analogously (in this case we use Lemma 4.7.(1) to obtain two additional chords d, e). \square

As a by-product we obtain the theorem that characterizes rigid non-Helly cliques in G .

Theorem 4.8. *A clique C of size ≥ 3 is rigid in G if and only if there is an order v_0, \dots, v_k of the vertices of G such that for every $i \neq j$ from $[0, k]$:*

- $v_i \sim v_j$ if $(i - j)_{\text{mod } k} \in \{1, k - 1\}$,

- v_i, v_j cover the circle if $(i - j)_{\text{mod } k} \notin \{1, k - 1\}$,

and exactly one of the following statements hold:

- $|C| \geq 4$.
- $|C| = 3$, C is contained in a component Q of G_{ov} , there is a prime node $N \in \mathcal{T}_Q$ such that $C \subseteq N$, C intersects with three children of N , and any ordering of $\Pi(N)$ forces either non-Helly structure $v_0^0 v_1^1 v_2^0 v_0^1 v_1^0 v_2^1$ or non-Helly structure $v_2^0 v_1^1 v_0^0 v_2^1 v_1^0 v_0^1$.

5. TYPES OF CLIQUES OF CIRCULAR-ARC GRAPHS

Let G be a circular-arc graph.

Definition 5.1. A clique C in G is said to be:

- always-Helly if C is Helly in every conformal model of G ,
- always-non-Helly if C is not Helly in every conformal model of G ,
- ambiguous, otherwise.

Of course, each clique of G is exactly one of the types listed above. The goal of this section is to present a polynomial time algorithm for the following problem:

Problem: CLIQUE TYPE

Input: A circular-arc graph G and a clique C in G ,

Output: The type of C .

The next observation allows us to restrict our attention to so-called clean cliques in circular-arc graphs.

Definition 5.2. A clique C in G is clean if C contains no two vertices such that one is contained in the other.

Consider the following “cleaning” procedure performed on a clique C of G :

- as long as there exist $u, v \in C$ such that u is contained in v , remove v from C .

Since the containment relation is transitive, the above procedure always (regardless of the order in which the vertices are removed from C) pulls out the same subset of vertices from C , and leaves the type of C unchanged.

Suppose G, C is an instance of the Clique Type problem. Let \mathcal{T} be the PM-tree for G . The remarks of the previous paragraph allow us to assume that:

(C1): C is a clean clique of G .

Observation 5.3. Suppose C satisfies (C1). If $C \cap Q_1 \neq \emptyset$ and $C \cap Q_2 \neq \emptyset$ for two distinct Q -nodes Q_1 and Q_2 in \mathcal{T} , then C is always-Helly.

Proof. Suppose for the sake of contradiction that there is a subclique $C' \subseteq C$ which forms a forbidden structure in some conformal model ϕ of G . Since (C', \sim) is connected, C' is contained in some connected component of G_{ov} . Without loss of generality assume $C' \subseteq Q_1$. Therefore, there exists a vertex $v \in C \setminus C'$ such that $v \in Q_2$. However, such a vertex cannot exist because C is clean. \square

The above observation allows us to assume that:

(C2): $C \subseteq Q$ for some Q -node Q of \mathcal{T} .

Clearly, if C contains a rigid non-Helly subclique, then C is always-non-Helly. So, we further assume that:

(C3): C contains no rigid non-Helly subclique.

We now classify the type of C depending on whether C is public or private. The next theorem establishes the type of C when C is public.

Theorem 5.4. *Suppose C is a public clique in G which satisfies conditions (C1)-(C3).*

(1) *If Q is prime, then C is always-Helly.*

(2) *Suppose Q is serial (which implies $Q = V$). If C intersects at most two CA -modules from \mathcal{S} , then C is always-Helly, otherwise C is ambiguous.*

Proof. To show statement (1) suppose, for the sake of contradiction, that there is a conformal model ϕ of G and vertices $a, b, c \in C$ such that ϕ contains $a^0b^1c^0a^1b^0c^1$ as a circular subword. Since C satisfies (C3), we have that a, b, c are not contained in three distinct children of Q . Without loss of generality, suppose a and b are contained in M where M is a child of Q in \mathcal{T}_Q . Since C is public, a and b have the same orientation. Without loss of generality assume $\phi|M^j$ contains b^0a^0 as a subword for some $j \in \{0, 1\}$. However, this implies that $\phi|M^j$ contains $b^0c^1a^0$ as a subword, which cannot be the case as C is public.

To show statement (2) suppose there are $a, b, c \in C$ contained in three different CA -modules from \mathcal{S} . Let ϕ be a conformal model of G . Since $Q = V$ is serial, to obtain other conformal models, we can permute the slots of ϕ arbitrarily as long as the slots corresponding to different CA -modules overlap. Thus, we can obtain a conformal model ϕ' of G such that ϕ' contains $a^0b^1c^0a^1b^0c^1$ as a circular subword. Since C is public, we can permute the slots of ϕ to get a conformal model of G in which C is Helly.

One can easily check that C is Helly in any conformal model of G when C is public and C is contained in at most two CA -modules from \mathcal{S} . \square

Assume now that C is private. Denote by \mathcal{P} the set of all M -nodes of \mathcal{T} which are the owners of C . Clearly, $\mathcal{P} \neq \emptyset$ as C is private. We start with a simple claim.

Claim 5.5. *For every $M \in \mathcal{P}$ and every $c \in C \setminus M$, we have $c \sim M$.*

Proof. The claim follows easily by the fact that C is clean and $M \cap C$ contains two vertices with different orientation in \mathbb{M} . \square

Observation 5.6. *Suppose C is a private clique which satisfies conditions (C1)-(C3). Then:*

- *If there are $M_1, M_2 \in \mathcal{P}$ which are incomparable in \mathcal{T}_Q , then C is always-non-Helly.*
- *If there are $M \in \mathcal{P}$ and $c_1, c_2 \in C \setminus M$ such that $c_1 \parallel c_2$, then C is always-non-Helly.*

Proof. The first statement follows from Lemma 3.4.(1).

For the second statement suppose for the sake of contradiction that there is a C -conformal model ϕ of G . Due to Lemma 3.4.(1) the clique letter C occurs in either $\phi|M^0$ or $\phi|M^1$. Observe that c_1 and c_2 cover the circle since C is clean. By Claim 5.5 we have

$c_1 \sim M$ and $c_2 \sim M$. Therefore, the intersection of the arcs $\phi(c_1)$ and $\phi(c_2)$ is disjoint with the slots $\phi|M^0$ and $\phi|M^1$, and hence ϕ is not a C -conformal model of G . \square

The above observation allows us to assume that:

(C4): The set \mathcal{P} induces a path in \mathcal{T}_Q starting at some CA-module $S \in \mathcal{S}(Q)$ and ending at some M-node D in \mathcal{T}_S .

(C5): For every $M \in \mathcal{P}$ and every $c \in C \setminus M$ we have $c \sim M$ and for every two distinct $c_1, c_2 \in C \setminus M$ we have $c_1 \sim c_2$.

The M-nodes S and D , determined by property (C4), are called the *lowest owner* and the *deepest owner* of C in \mathcal{T}_Q , respectively.

Now we describe the properties of the modules from the set $\mathcal{P} \cup \{Q\}$. For this purpose, for every $N \in \mathcal{P} \cup \{Q\}$ we set

$$\mathcal{I}(N) = \left\{ K : \begin{array}{l} K \text{ is a child of } N \text{ in } \mathcal{T}_Q \text{ such that} \\ (C \cap K) \neq \emptyset \text{ and } K \notin \mathcal{P} \end{array} \right\}.$$

Claim 5.7. *The following statements hold:*

- (1) *For every $c \in C$ there is $N \in \mathcal{P} \cup \{Q\}$ such that $c \in K$ for some $K \in \mathcal{I}(N)$.*
- (2) *For every $N \in \mathcal{P} \cup \{Q\}$ and every $K \in \mathcal{I}(N)$ the edges from $(C \cap K)$ have the same orientation in \mathbb{K} .*

Proof. The statements of the claim follow from Condition (C4) and Claim 5.5. \square

Let $N \in \mathcal{P} \cup \{Q\}$ be such that $\mathcal{I}(N) \neq \emptyset$. Claim 5.7.(2) allows us to partition $\mathcal{I}(N)$ into the sets $\mathcal{L}(N)$ and $\mathcal{R}(N)$, as follows:

$$\begin{aligned} \mathcal{L}(N) &= \{K \in \mathcal{I}(N) : \text{the elements from } (C \cap K) \text{ are } (K^0, K^1)\text{-oriented in } \mathbb{K}\}, \\ \mathcal{R}(N) &= \{K \in \mathcal{I}(N) : \text{the elements from } (C \cap K) \text{ are } (K^1, K^0)\text{-oriented in } \mathbb{K}\}. \end{aligned}$$

Claim 5.8. *The following statements hold:*

- (1) *For every $N \in \mathcal{P} \cup \{Q\}$ and distinct $L_1, L_2 \in \mathcal{L}(N)$ we have $L_1 \sim L_2$,*
- (2) *For every $N \in \mathcal{P} \cup \{Q\}$ and distinct $R_1, R_2 \in \mathcal{R}(N)$ we have $R_1 \sim R_2$,*
- (3) *For every $N \in (\mathcal{P} \cup \{Q\}) \setminus \{D\}$, $L \in \mathcal{L}(N)$, and $R \in \mathcal{R}(N)$, we have $L \sim K$, $K \sim R$, and $L \sim R$, where K is a child of N from \mathcal{P} .*

In the next lemmas we describe the properties of the modules from the set $\mathcal{P} \cup \{Q\}$. We start with the deepest owner D of C .

Lemma 5.9. *Let D be the deepest owner of C in \mathcal{T}_Q . Then:*

- (1) *We have $\mathcal{L}(D) \neq \emptyset$, $\mathcal{R}(D) \neq \emptyset$. Moreover,*
 - (a) *If D is parallel, then $\mathcal{L}(D) \parallel \mathcal{R}(D)$ and $|\mathcal{L}(D)| = |\mathcal{R}(D)| = 1$.*
 - (b) *If D is serial, then $\mathcal{L}(D) \sim \mathcal{R}(D)$.*
 - (c) *If D is prime, then either $\mathcal{L}(D) \parallel \mathcal{R}(D)$ or $L \sim R$ for some $L \in \mathcal{L}(D)$ and some $R \in \mathcal{R}(D)$.*
- (2) *Let ϕ be a C -conformal model ϕ of G and let $\phi|_D = (\pi^0, \pi^1)$ be an ordering of N in ϕ :*
 - (a) *If C is contained in $\phi|_{D^0}$, then π^0 orders $\mathcal{L}^0(D)$ before $\mathcal{R}^0(D)$.*
 - (b) *If C is contained in $\phi|_{D^1}$, then π^1 orders $\mathcal{R}^1(D)$ before $\mathcal{L}^1(D)$.*

- (3) Let D be prime and let $L \in \mathcal{L}(D)$ and $R \in \mathcal{R}(D)$ be such that $L \sim R$. Then:
- (a) There is a unique admissible ordering $\gamma = (\gamma^0, \gamma^1)$ in $\Pi(D)$ which orders $\mathcal{L}^0(D)$ before $\mathcal{R}^0(D)$ in γ^0 .
 - (b) There is a unique admissible ordering $\delta = (\delta^0, \delta^1)$ in $\Pi(D)$ which orders $\mathcal{R}^1(D)$ before $\mathcal{L}^1(D)$ in δ^1 .
- Moreover, we have $\Pi(D) = \{\gamma, \delta\}$, which means that δ is the reflection of γ .

Proof. We have $\mathcal{L}(D) \neq \emptyset$ and $\mathcal{R}(D) \neq \emptyset$ by Claim 5.7.(2) and by the fact that we have two vertices from $C \cap D$ with different orientations in \mathbb{D} . Statement (1a) follows by the fact that C is clean. Statements (1b)-(1c) are obvious.

Statement (2) follows from the fact that the letter C is on the left side of the chords of ϕ representing the vertices from the set $C \cap (\bigcup \mathcal{L}(D))$ and from the set $C \cap (\bigcup \mathcal{R}(D))$.

Now we proceed to the proof of statement (3).

Since C is a clique, for every (π^0, π^1) in $\Pi(D)$ and every $L \in \mathcal{L}(D)$ and $R \in \mathcal{R}(D)$ such that $L \parallel R$ we have that L^0 occurs before R^0 in π^0 and R^1 occurs before L^1 in π^1 .

Suppose now that there exist $L \in \mathcal{L}(D)$ and $R \in \mathcal{R}(D)$ such that $L \sim R$. Let \prec_D be a transitive orientation of (D, \sim_D) satisfying $L \prec_D R$ (note that in the other transitive orientation \prec_D^R of (D, \sim_D) we have $R \prec_D^R L$). To prove statement (3) it is enough to show $L' \prec_D R'$ for every $L' \in \mathcal{L}(D)$ and $R' \in \mathcal{R}(D)$ such that $L' \sim R'$. Then we have $R' \prec_D^R L'$ for every $L' \in \mathcal{L}(D)$ and $R' \in \mathcal{R}(D)$ such that $L' \sim R'$, and the admissible orderings γ and δ from $\Pi(D)$ corresponding to \prec_D and \prec_D^R satisfy statements (3a) and (3b), respectively. Suppose for the sake of contradiction that there exist $L' \in \mathcal{L}(D)$ and $R' \in \mathcal{R}(D)$ such that $L' \sim R'$ and $R' \prec_D L'$. First, suppose $L \sim R'$. If $L \prec_D R'$, then $L \prec_D R' \prec_D L'$ which contradicts that C satisfies property (C3). But if $R' \prec_D L$ then $R' \prec_D L \prec_D R$ which again contradicts that C satisfies property (C3). Therefore, we must have $L \parallel R'$. In particular, we have $L <_S R'$. Due to symmetrical arguments, we have $L' \parallel R$. In particular, we have $L' <_S R$. Recall that $L \sim L'$ and $R \sim R'$ because C is clean. However, this implies that C contains a rigid non-Helly clique of size 4 which cannot be the case since C satisfies property (C3). \square

Lemma 5.9 allows us to introduce the following terminology for admissible orders of the deepest owner D of C :

- If D is prime and there are $L \in \mathcal{L}(D)$ and $R \in \mathcal{R}(D)$ such that $L \sim R$, then we say admissible ordering $\gamma = (\gamma^0, \gamma^1)$ which orders $\mathcal{L}^0(D)$ before $\mathcal{R}^0(D)$ in γ^0 binds C in the slot S^0 , and admissible ordering $\delta = (\delta^0, \delta^1)$ of $\Pi(D)$ which orders $\mathcal{R}^1(D)$ before $\mathcal{L}^1(D)$ in δ^1 binds C in the slot S^1 . See Figure 5.1 to the left for an illustration.
- If D is serial, then any admissible ordering $\gamma = (\gamma^0, \gamma^1)$ which orders $\mathcal{L}^0(D)$ before $\mathcal{R}^0(D)$ in γ^0 binds C in the slot S^0 , any admissible ordering $\delta = (\delta^0, \delta^1)$ of $\Pi(D)$ which orders $\mathcal{R}^1(D)$ before $\mathcal{L}^1(D)$ in δ^1 binds C in the slot S^1 , and any other ordering $\sigma = (\sigma^0, \sigma^1)$ makes C non-Helly. Note that D admits an ordering which makes C non-Helly iff $|\mathcal{I}(D)| \geq 3$. See Figure 5.1 (in the middle) for an illustration.

Note that when D is prime and $\mathcal{L}(D) \parallel \mathcal{R}(D)$ or when D is parallel, then the choice of the admissible ordering of D has no impact on the slot in which C occurs. See Figure 5.1

to the right for an illustration. Also, if D is prime and $L \sim D$ for some $L \in \mathcal{L}(D)$ and $R \in \mathcal{R}(D)$ or when D is serial and $|\mathcal{I}(D)| = 2$, then any ordering of D binds C is S^j for some $j \in \{0, 1\}$.

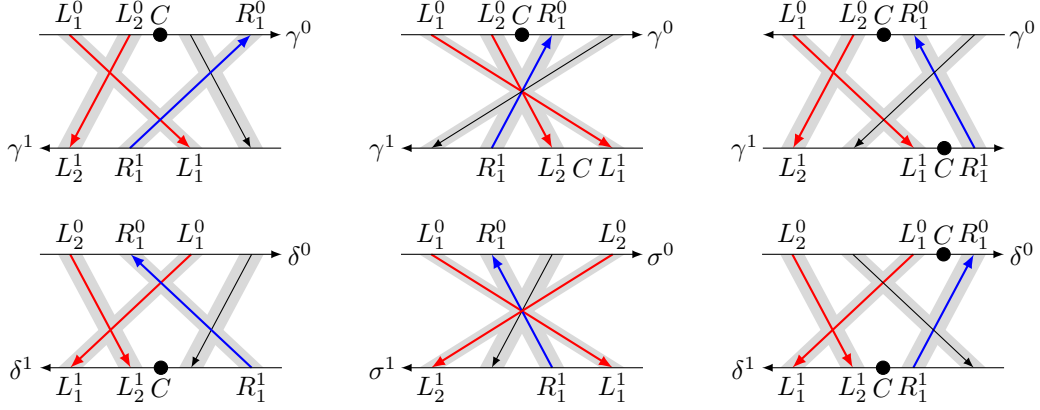

FIGURE 5.1. To the left: prime deepest owner D with $L_1 \sim R_1$: ordering $\gamma = (\gamma^0, \gamma^1)$ binds C in S^0 and ordering $\delta = (\delta^0, \delta^1)$ binds C in S^1 . In the middle: ordering $\gamma = (\gamma^0, \gamma^1)$ of serial deepest owner D binds C in S^0 , ordering $\sigma = (\sigma^0, \sigma^1)$ makes C non-Helly. To the right: prime deepest owner D satisfies $\mathcal{L}(D) \parallel \mathcal{R}(D)$ and hence C is not bound by D .

Lemma 5.10. *Let $M \in \mathcal{P} \setminus \{D\}$ be such that $\mathcal{I}(M) \neq \emptyset$ and let K be the child of M in the set \mathcal{P} . Then M is either prime or serial and:*

- (1) *We have $\mathcal{L}(M) \sim K$, $\mathcal{R}(M) \sim K$, and $\mathcal{L}(M) \sim \mathcal{R}(M)$.*
- (2) *Let ϕ be a C -conformal model ϕ of G and let $\phi|_M = (\pi^0, \pi^1)$ be an ordering of M in ϕ :*
 - (a) *If C is contained in $\phi|D^0$ then π^0 orders $\mathcal{L}^0(M)$ before K^0 and K^0 before $\mathcal{R}^0(M)$,*
 - (b) *If C is contained in $\phi|D^1$ then π^1 orders $\mathcal{R}^1(M)$ before K^1 and K^1 before $\mathcal{L}^1(M)$.*
- (3) *Suppose M is prime. Then:*
 - (a) *There is a unique admissible ordering $\gamma = (\gamma^0, \gamma^1)$ in $\Pi(M)$ which orders $\mathcal{L}^0(M)$ before K^0 and K^0 before $\mathcal{R}^0(M)$ in γ^0 .*
 - (b) *There is a unique admissible ordering $\delta = (\delta^0, \delta^1)$ in $\Pi(M)$ which orders $\mathcal{R}^1(M)$ before K^1 and K^1 before $\mathcal{L}^1(M)$ in δ^1 .*

Moreover, we have $\Pi(M) = \{\gamma, \delta\}$, which means that δ is the reflection of γ .

Proof. Since C is clean, $\mathcal{I}(M) \neq \emptyset$, and $K \cap C$ contains two vertices with different orientation in \mathbb{K} , M needs to be either prime or serial.

Statement (1) follows from the fact that $D \subseteq K$ and C satisfies condition (C5).

Statement (2) follows from the fact that $D \subseteq K$ and the letter C is on the left side of the chords of ϕ representing the vertices from the set $C \cap (\bigcup \mathcal{L}(M))$ and from the set $C \cap (\bigcup \mathcal{R}(M))$.

Statement (3) follows from Claim 5.7.(2) and the fact that C contains no rigid non-Helly subclique. \square

Similarly, the above lemma allows us to introduce the following terminology for admissible orderings of $\Pi(M)$ for M-nodes $M \in \mathcal{P} \setminus \{D\}$ such that $\mathcal{I}(M) \neq \emptyset$:

- If M is prime, then admissible ordering $\gamma = (\gamma^0, \gamma^1)$ which orders $\mathcal{L}^0(M)$ before K^0 and K^0 before $\mathcal{R}^0(M)$ in γ^0 binds C in the slot S^0 , and admissible ordering $\delta = (\delta^0, \delta^1)$ of $\Pi(M)$ which orders $\mathcal{R}^1(M)$ before K^1 and K^1 before $\mathcal{L}^1(M)$ in δ^1 binds C in the slot S^1 . See Figure 5.2 (to the left) for an illustration.
- If M is serial, then any admissible ordering $\gamma = (\gamma^0, \gamma^1)$ which orders $\mathcal{L}^0(M)$ before K^0 and K^0 before $\mathcal{R}^0(M)$ in γ^0 binds C in the slot S^0 , any admissible ordering $\delta = (\delta^0, \delta^1)$ of $\Pi(M)$ which orders $\mathcal{R}^1(M)$ before K^1 and K^1 before $\mathcal{L}^1(M)$ in δ^1 binds C in the slot S^1 , and any other ordering $\sigma = (\sigma^0, \sigma^1)$ makes C non-Helly. Note that M admits an ordering which makes C non-Helly iff $|\mathcal{I}(M)| \geq 2$. See Figure 5.2 (to the right) for an illustration.

Note that when M is prime or when M is serial and $|\mathcal{I}(M)| = 1$, then any ordering of M binds C in S^j for some $j \in \{0, 1\}$.

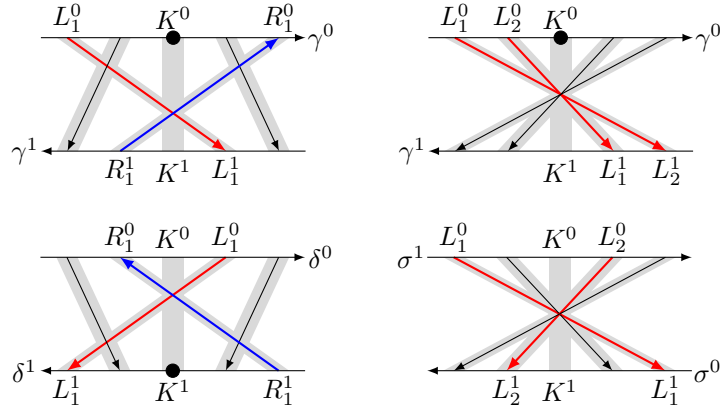

FIGURE 5.2. To the left: ordering $\gamma = (\gamma^0, \gamma^1)$ of prime owner M binds C in S^0 and ordering $\delta = (\delta^0, \delta^1)$ binds C in S^1 . To the right: ordering $\gamma = (\gamma^0, \gamma^1)$ of serial owner M (we have $\mathcal{R}(N) = \emptyset$) binds C in S^0 , ordering $\sigma = (\sigma^0, \sigma^1)$ makes C non-Helly.

Finally, we describe the properties of the Q-node Q which contains C .

Lemma 5.11. *Let Q be the Q-node containing C and let S be the lowest owner of C in \mathcal{T}_Q . Then:*

- (1) *We have $\mathcal{L}(Q) \sim S$, $\mathcal{R}(Q) \sim S$, and $\mathcal{L}(Q) \sim \mathcal{R}(Q)$.*
- (2) *Let ϕ be a conformal model of G and let $\phi|_Q \equiv \pi_Q$ be an admissible ordering of Q in ϕ . Then:*
 - *If C is in $\phi|S^0$, then π_Q orders the slot S^0 between $\mathcal{L}^0(Q)$ and $\mathcal{L}^1(Q)$ and between $\mathcal{R}^1(Q)$ and $\mathcal{R}^0(Q)$.*
 - *If C is in $\phi|S^1$, then π_Q orders the slot S^1 between $\mathcal{L}^0(Q)$ and $\mathcal{L}^1(Q)$ and between $\mathcal{R}^1(Q)$ and $\mathcal{R}^0(Q)$.*

(3) Suppose M is prime. Then:

- (a) There is a unique admissible ordering $\gamma \in \Pi(Q)$ which orders the slot S^0 between $\mathcal{L}^0(Q)$ and $\mathcal{L}^1(Q)$ and between $\mathcal{R}^1(Q)$ and $\mathcal{R}^0(Q)$.
- (b) There is a unique admissible ordering $\delta \in \Pi(Q)$ which orders the slot S^1 between $\mathcal{L}^0(Q)$ and $\mathcal{R}^1(Q)$ and between $\mathcal{R}^1(Q)$ and $\mathcal{R}^0(Q)$.

Moreover, we have $\Pi(Q) = \{\gamma, \delta\}$, which means that δ is the reflection of γ .

Proof. Statement (1) follows from the fact that $D \subseteq S$ and C satisfies condition (C5).

Statement (2) follows from the fact that $D \subseteq S$ and the letter C is on the left side of chords of ϕ representing the vertices from the set $C \cap (\bigcup \mathcal{L}(Q))$ and from the set $C \cap (\bigcup \mathcal{R}(Q))$.

Statement (3) follows from Claim 5.7.(2) and the fact that C contains no rigid non-Helly subclique. \square

Following our convention, we introduce the following terminology for admissible orderings of $\Pi(Q)$ for Q -node Q such that $C \subseteq Q$ and $\mathcal{I}(Q) \neq \emptyset$:

- If Q is prime, then admissible ordering $\gamma \in \Pi(Q)$ which orders the slot S^0 between $\mathcal{L}^0(Q)$ and $\mathcal{L}^1(Q)$ and between $\mathcal{R}^1(Q)$ and $\mathcal{R}^0(Q)$ binds C in the slot S^0 , and admissible ordering δ which orders the slot S^1 between $\mathcal{L}^0(Q)$ and $\mathcal{L}^1(Q)$ and between $\mathcal{R}^1(Q)$ and $\mathcal{R}^0(Q)$ binds C in the slot S^1 . See Figure 5.3 (to the left) for an illustration.
- If Q is serial, then any admissible ordering $\gamma \in \Pi(Q)$ which orders the slot S^0 between $\mathcal{L}^0(Q)$ and $\mathcal{L}^1(Q)$ and between $\mathcal{R}^1(Q)$ and $\mathcal{R}^0(Q)$ binds C in the slot S^0 , any admissible ordering δ of $\Pi(Q)$ which orders the slot S^1 between $\mathcal{L}^0(Q)$ and $\mathcal{L}^1(Q)$ and between $\mathcal{R}^1(Q)$ and $\mathcal{R}^0(Q)$ binds C in the slot S^1 , and any other ordering $\sigma \in \Pi(Q)$ makes C non-Helly. Note that Q admits an ordering which makes C non-Helly iff $|\mathcal{I}(Q)| \geq 2$. See Figure 5.3 (to the right) for an illustration.

Note that when Q is prime or when Q is serial and $|\mathcal{I}(Q)| = 1$, then any ordering of Q binds C in S^j for some $j \in \{0, 1\}$.

Now, we are ready to characterize conformal models of G in which C satisfies the Helly property. For this purpose, we say a node N of \mathcal{T} affects (the slot of) C if N admits an ordering which binds C in some slot of S .

Lemma 5.12. *Suppose C is a private clique which satisfies conditions (C1)-(C5) and let $j \in \{0, 1\}$. A conformal model ϕ of G can be extended to a C -conformal model with the clique C in the slot S^j if and only if for every node N affecting C the ordering $\phi|_N$ binds C in S^j .*

Proof. Suppose ϕ is a C -conformal model of G with C in the slot S^j . Lemmas 5.9.(2), 5.10.(2), and 5.11.(2) assert that for every node N affecting C the ordering $\phi|_N$ binds C in S^j .

Suppose ϕ is a conformal model of G such that $\phi|_N$ binds C in S^j for every node N affecting C . Since, by Claim 5.7.(1), every element from C is a member of some node $K \in \mathcal{I}(N)$ for some $N \in \mathcal{P} \cup \{Q\}$, the properties of admissible orderings from $\Pi(N)$ binding C in S^j assert ϕ can be easily extended to a C -conformal model with C in S^j (we can choose any ordering for the nodes of \mathcal{T} which do not affect C). \square

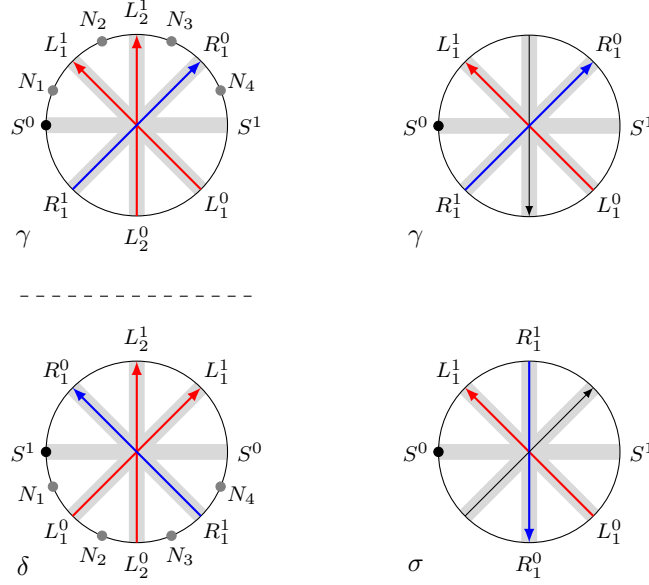

FIGURE 5.3. To the left: ordering γ of prime Q-node Q binds C in S^0 and ordering δ binds C in S^1 . To the right: ordering γ of serial Q-node Q binds C in S^0 , ordering σ makes C non-Helly.

Finally we determine the type of C .

Theorem 5.13. *Suppose C is a private clique which satisfies conditions (C1)-(C5). If there is a node with an ordering which makes C non-Helly or there are at least two nodes with orderings binding C , then C is ambiguous. Otherwise, C is always Helly.*

Proof. Lemmas 5.9.(3), 5.10.(3), and 5.11.(3) assert every node N affecting C admits an ordering which binds C in the slot S^j , for any $j \in \{0, 1\}$. Lemma 5.12 guarantees G admits a conformal model in which C satisfies the Helly property.

By Lemma 5.12, if there is a serial node N affecting C with an ordering making C non-Helly, the conformal models of G which use this ordering on N make C non-Helly. By the same reason, if we have two distinct nodes N_0, N_1 which bind C , the conformal models ϕ of G in which $\phi|_{N_0}$ binds C in S^0 and $\phi|_{N_1}$ binds C in S^1 , make C non-Helly. Otherwise, if there is exactly one node N whose orderings binds C either in S^0 or in S^1 , then any conformal model ϕ of G can be extended to a C -conformal model with C in the slot S^j for some unique $j \in \{0, 1\}$ (that is, in S^0 if $\phi|_N$ binds C in S^0 or in S^1 if $\phi|_N$ binds C in S^1). Finally, if there are no nodes affecting C , every conformal model of G can be extended to a C -conformal model with C in S^j for both $j \in \{0, 1\}$. This concludes the proof. \square

Finally, we can observe that we can test the type of C in polynomial time, thus proving Theorem 1.2. For this purpose we check whether C satisfies properties (C1)-(C5). All those properties are easy to test except of checking whether C contains a rigid non-Helly

clique of size ≥ 4 . For this we can use the fact that C contains a rigid non-Helly clique of size ≥ 4 iff the vertices of C induce a non-chordal graph in the overlap graph G_{ov} .

6. FPT ALGORITHM FOR HELLY CLIQUES

The HELLY CLIQUES problem (**HCP**) is defined as follows.

Problem: HELLY CLIQUES

Input: A circular-arc graph G and some of its cliques C_1, \dots, C_k

Question: Is there a normalized circular-arc model of G in which all the cliques C_1, \dots, C_k satisfy the Helly property?

Equivalently, in HELLY CLIQUES, for a given circular arc graph G and its cliques C_1, \dots, C_k we need to decide whether G admits a $\{C_1, \dots, C_k\}$ -conformal model.

Let (G, C_1, \dots, C_k) be an instance of HELLY CLIQUES. If C_i is an inclusion-wise maximal clique in G , then the instance (G, C_1, \dots, C_k) is equivalent to the instance $(G', C_1, \dots, C_{i-1}, C_{i+1}, \dots, C_k)$, where G' is obtained by extending G by a vertex v with $N(v) = C_i$. Hence, if all the cliques on the input are maximal in G , HELLY CLIQUES can be solved by a linear time algorithm as it can be reduced to the recognition problem of circular-arc graphs.

In the rest of this section we will prove Theorem 6.1, which extends Theorem 1.3.(1) as follows:

Theorem 6.1. HELLY CLIQUES *can be solved:*

- (1) *in time $2^k n^{O(1)}$ if we restrict to the instances (G, C_1, \dots, C_k) in which $V(G)$ is prime or parallel in $\mathcal{M}(G_{ov})$.*
- (2) *in time $2^{O(k \log k)} n^{O(1)}$ if we restrict to the instances (G, C_1, \dots, C_k) in which $V(G)$ is serial in $\mathcal{M}(G_{ov})$.*

In particular, HELLY CLIQUES can be solved in time $2^{O(k \log k)} n^{O(1)}$.

Suppose (G, C_1, \dots, C_k) is an instance of HELLY CLIQUES. If some clique C_i is always-non-Helly, we immediately conclude that we are dealing with **no**-instance. Also, if C_i is always-Helly, then (G, C_1, \dots, C_k) is equivalent to $(G, C_1, \dots, C_{i-1}, C_{i+1}, \dots, C_k)$. So, we assume all the cliques C_1, \dots, C_k are ambiguous.

Suppose \mathcal{T} is the PQM-tree of $G = (V, E)$ and $G_{ov} = (V, \sim)$ is the overlap graph of G . Since C_1, \dots, C_k are ambiguous, C_1, \dots, C_k satisfy properties (C1)–(C3). So, we assume C_i is clean, we have $C_i \subseteq Q_i$ for a component Q_i of G_{ov} , and C_i contains no rigid non-Helly subclique, for every $i \in [k]$.

We consider two cases depending on the type of the module V in $\mathcal{M}(G_{ov})$.

6.1. V is prime or parallel in $\mathcal{M}(G_{ov})$. Since V is prime/parallel, every Q -node in \mathcal{T} is prime. Since C_1, \dots, C_k are ambiguous and V is prime, Theorem 5.4 asserts that all the cliques C_1, \dots, C_k are private, and since they are ambiguous, all of them satisfy properties (C1)–(C5). We assume C_i is private for a CA-module S_i , for $i \in [k]$.

Our algorithm iterates over all tuples in the set $\{0, 1\}^{[k]}$ and for every tuple $(j_1, \dots, j_k) \in \{0, 1\}^{[k]}$ it verifies whether there exists a $\{C_1, \dots, C_k\}$ -conformal model ϕ of G such that the clique letter C_i is contained in the slot $S_i^{j_i}$ for $i \in [k]$.

Let (j_1, \dots, j_k) be a tuple in $\{0, 1\}^{[k]}$. By Lemma 5.12 there is a $\{C_1, \dots, C_k\}$ -conformal model of G with C_i in S^{j_i} if and only if for every $i \in [k]$ and for every node N affecting C_i the ordering $\phi|_N$ binds C in S^{j_i} . Hence, our task is to check whether for every prime/serial node N in \mathcal{T} there is an ordering $\pi \in \Pi(N)$ such that for every $i \in [k]$ the ordering π binds C_i in S^{j_i} whenever N affects C_i .

This is easy when N is prime: ordering π does not exist if and only if there are two cliques $C_{i_1}, C_{i_2} \in \{C_1, \dots, C_k\}$ affected by N and there is no ordering in $\Pi(N)$ which binds C_{i_1} in $S^{j_{i_1}}$ and C_{i_2} in $S^{j_{i_2}}$.

If N is serial, then N is an M-node as we are in the case when V is prime or parallel. Suppose $N \subseteq S$ for a CA-module $S \in \mathcal{S}$. Recall that the orderings π in $\Pi(N)$ are in the correspondence with the linear orderings \prec_N of the children of N in \mathcal{T}_S . Now, note that each constraint of the form π binds C_i in the slot S^i enforces \prec_N -relation between some children of N (see Lemmas 5.9–5.10). Eventually, the question of whether there exists $\pi \in \Pi(N)$ which binds C_i in S^{j_i} for every C_i affected by N is equivalent to testing whether a digraph (N, \prec_N) consisting of the \prec_N -edges enforced by the binding constraints, is acyclic. Clearly, this condition can be tested in polynomial-time.

This completes the proof of Theorem 6.1.(1).

6.2. V is serial in $\mathcal{M}(G_{ov})$. First observe that, contrary to the previous case, we can not assume that all the input cliques C_1, \dots, C_k are private; indeed, Theorem 5.4 asserts that a public clique C_i intersecting at least three CA-modules of G is ambiguous. So, in this case we construct an algorithm which exploits PQM-tree of G and the Trapezoid Lemma.

First, for every $S \in \mathcal{S}$ we let

$$\begin{aligned} \text{Cl}(S) &= \{C_i : C_i \cap S \neq \emptyset\}, \\ \text{Priv}(S) &= \{C_i : C_i \text{ is private for } S\}. \end{aligned}$$

Clearly, C_i is public if and only if C_i is contained in no set $\text{Priv}(S)$ for every $S \in \mathcal{S}$ and C_i is private if and only if C_i is contained in exactly one set $\text{Priv}(S)$ for some $S \in \mathcal{S}$.

A circular ordering $C_{i_1} \dots C_{i_k}$ of the clique set $\{C_1, \dots, C_k\}$ is *good* if there exists a $\{C_1, \dots, C_k\}$ -conformal model ϕ of G such that

$$\phi|\{C_1, \dots, C_k\} \equiv C_{i_1} \dots C_{i_k}.$$

Model ϕ satisfying the above property is called $C_{i_1} \dots C_{i_k}$ -conformal.

Let ϕ be a $C_{i_1} \dots C_{i_k}$ -conformal model of G . Note that we can always extend the model ϕ by an oriented chord $s^0 s^1$, called a *stabilizer*, which satisfies the property:

- For every $S \in \mathcal{S}$ the chord $s^0 s^1$ has the slots $\phi|S^0$ and $\phi|S^1$ on its different sides.

Clearly, such an extension of ϕ is always possible: for example, we may pick any $S \in \mathcal{S}$ and add the chord $s^0 s^1$ such that s^0 is just before the slot $\phi|S^0$ and s^1 is just before the slot $\phi|S^1$. Usually we draw the extended models ϕ on two parallel lines A and B , with A

above B , putting the points of ϕ strictly between s^0 and s^1 on the line A , and the points of ϕ strictly between s^1 and s^0 on the line B , and drawing the chord s^0s^1 in parallel and in between A and B . See Figure 6.1 for an illustration.

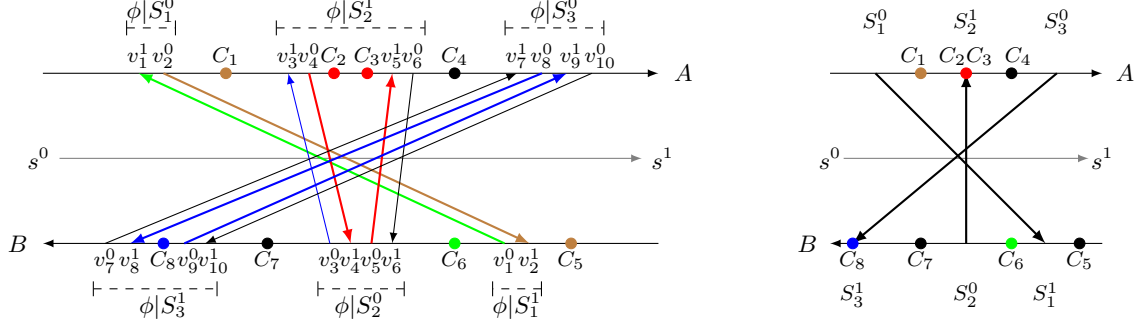

FIGURE 6.1. An extended model ϕ and its skeleton ϕ^R . We have $v_1 \in C_6$, $v_2 \in C_1 \cap C_5$, $v_3 \in C_8$, $v_4, v_5 \in C_2 \cap C_3$. We have $\tau^A = C_1 C_2 C_3 C_4$ and $\tau^B = C_5 C_6 C_7 C_8$, $\tau^A(S_2) = C_2 C_3$, $\tau^B(S_2) = \emptyset$, where \emptyset denotes an empty word, $\text{Priv}^A(S_2) = \{C_2, C_3\}$ and $\text{Priv}^B(S_2) = \emptyset$. The model $(\phi|S_2^0, \phi|S_2^1) = (v_6^1 v_5^0 v_4^1 v_3^0, v_3^1 v_4^0 C_2 C_3 v_5^1 v_6^0)$ is $(\emptyset, C_2 C_3)$ -admissible for \mathbb{S}_2 . We have $\mu^A = C_1 \{C_2, C_3\} C_4$ and $\mu^B = C_5 C_6 C_7 C_8$, red dot is the clique-point of C_2 and C_3 , green dot is the clique-point of C_6 .

Let ϕ be a $C_{i_1} \dots C_{i_k}$ -conformal model of G extended by a stabilizer $s^0 s^1$. Let ϕ^A and ϕ^B be the contiguous subwords of ϕ containing the letters of ϕ strictly between s^0 and s^1 and strictly between s^1 and s^0 , respectively. Let $\tau(\phi)$, τ^A , τ^B be the restriction of ϕ , ϕ^A , ϕ^B to the set $\{C_1, \dots, C_k\} \cup \{s^0, s^1\}$, respectively. Also, for $S \in \mathcal{S}$ let $\tau^A(S)$ and $\tau^B(S)$ be the subwords of τ^A and τ^B containing the cliques from $\text{Priv}(S)$. Note that $\tau^A(S)$ and $\tau^B(S)$, if non-empty, are contiguous in τ^A and τ^B , respectively. Next, let $\text{Priv}^A(S)$ and $\text{Priv}^B(S)$ be the cliques occurring in the words $\tau^A(S)$ and $\tau^B(S)$, respectively. Note that $\text{Priv}(S) = \text{Priv}^A(S) \cup \text{Priv}^B(S)$. Finally, let μ^A (μ^B) be a word obtained from τ^A (τ^B , respectively) by replacing every non-empty word $\tau^A(S)$ ($\tau^B(S)$, respectively) by the set $\text{Priv}^A(S)$ ($\text{Priv}^B(S)$, respectively), for $S \in \mathcal{S}$. See Figure 6.1 for an illustration.

Now, since ϕ is $\{C_1, \dots, C_k\}$ -conformal, the following property holds:

(P1): For every $S \in \mathcal{S}$:

- If $\phi|S^0$ is above $s^0 s^1$, then $(\phi|S^0, \phi|S^1)$ is an $(\tau^A(S), \tau^B(S))$ -admissible model for \mathbb{S} , which means that $(\phi|S^0, \phi|S^1)$ restricted to S^* is admissible for \mathbb{S} , restricted to $\text{Priv}(S)$ coincides with $(\tau^A(S), \tau^B(S))$, and for every $C \in \text{Priv}(S)$ and $v \in C \cap S$ the clique C is on the left side of the chord $\phi(v)$,
- If $\phi|S^1$ is above $s^0 s^1$, then $(\phi|S^0, \phi|S^1)$ is an $(\tau^B(S), \tau^A(S))$ -admissible model for \mathbb{S} .

Next, let ϕ_R denote a circular word that arises from ϕ by replacing, for every $S \in \mathcal{S}$, the subwords $\phi|S^0$ and $\phi|S^1$ by the letters S^0 and S^1 , respectively. The circular word ϕ_R obtained this way is called the *skeleton* of ϕ . Clearly,

(P2): The chords $\phi_R(S)$ for $S \in \mathcal{S}$ are pairwise intersecting and all of them intersect the stabilizer s^0s^1 .

See Figure 6.1 to the right for an illustration.

Now, we are going to describe some geometric properties of the skeleton ϕ_R . For this purpose, by slightly abusing our notation we represent every clique C_i from $\{C_1, \dots, C_k\}$ as the *clique-point* C_i on the line A or B , as follows. We represent the letters from μ^A as points on the line A and the letters from μ^B as points on the line B . Then, the clique-point C_i coincides with:

- the point $\text{Priv}^A(S)$ if $C_i \in \text{Priv}^A(S)$ for some $S \in \mathcal{S}$,
- the point $\text{Priv}^B(S)$ if $C_i \in \text{Priv}^B(S)$ for some $S \in \mathcal{S}$,
- the point C_i , otherwise.

See Figure 6.1 to the right for an illustration.

Now, note that we can easily assert the following properties of the oriented chord $\phi_R(S)$ for every $S \in \mathcal{S}$:

- (T1):** For every $C_i \in (\text{Cl}(S) \setminus \text{Priv}(S))$, if the chords from $S \cap C$ are (S^0, S^1) -oriented ((S^1, S^0) -oriented), then the oriented chord $\phi_R(S)$ has the clique-point C_i on its left side (right side, respectively).
- (T2):** If $\text{Priv}^A(S) \neq \emptyset$, then the upper tip of $\phi_R(S)$ coincides with the point $\text{Priv}^A(S)$. If $\text{Priv}^B(S) \neq \emptyset$, then the lower tip of $\phi_R(S)$ coincides with the point $\text{Priv}^B(S)$.

Now let us consider the region where the oriented chord $\phi_R(S)$ can be placed in order to satisfy properties (T1)–(T2). Clearly, such region depends solely on the orientation of $\phi_R(S)$ but in both cases it forms a trapezoid (possibly empty) with one base (forming a possibly degenerated interval, open or closed on each side) in A and the second one in B ; we call such a trapezoid as *spanned between A and B* . Let T_{S^0} (T_{S^1}) denote the largest trapezoid spanned between A and B such that whenever $\phi_R(S)$ is downward oriented chord contained in T_{S^0} (upward oriented chord contained in T_{S^1} , respectively), then $\phi_R(S)$ satisfies properties (T1)–(T2). So, since $\phi_R(S)$ satisfies properties (T1)–(T2), the following holds:

- (P3):** For every $S \in \mathcal{S}$:
- If $\phi|S^0$ is above s^0s^1 , then $\phi_R(S) \subseteq T_{S^0}$.
 - If $\phi|S^0$ is below s^0s^1 , then $\phi_R(S) \subseteq T_{S^1}$.

See Figure 6.2 which shows trapezoids for slots shown in Figure 6.1.

Our algorithm iterates over all circular orders of the clique set $\{C_1, \dots, C_k\}$ and for every circular order $C_{i_1} \dots C_{i_k}$ it decides, in polynomial time, whether $C_{i_1} \dots C_{i_k}$ is good. Clearly, we accept (G, C_1, \dots, C_k) if at least one of the circular orders is good. To test whether $C_{i_1} \dots C_{i_k}$ is good, we iterate over all extensions of the circular word C_{i_1}, \dots, C_{i_k} by the letters $\{s^0, s^1\}$ and for each such extension τ we check whether there is an extended conformal model ϕ of G such that $\tau = \tau(\phi)$. Given τ , the algorithm computes the word μ , which defines the clique-point C_i for every $C_i \in \{C_1, \dots, C_k\}$, and the trapezoids T_{S^0} and T_{S^1} for every $S \in \mathcal{S}$, exactly as we have computed μ and T_{S^0} and T_{S^1} from the word $\tau(\phi)$. Also, given τ , we compute the sets $\text{Priv}^A(S)$, $\text{Priv}^B(S)$, and the words $\tau^A(S)$

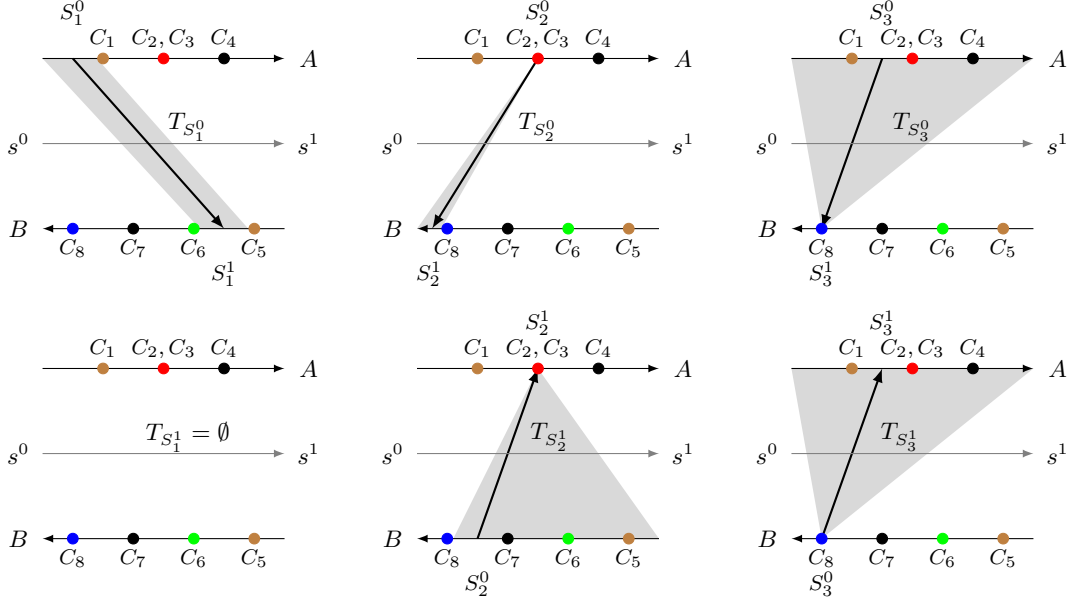

FIGURE 6.2. Trapezoids $T_{S_1^0}$, $T_{S_1^1}$, $T_{S_2^0}$, $T_{S_2^1}$, $T_{S_3^0}$, $T_{S_3^1}$ for the instance shown in Figure 6.1: $\phi_R(S_1)$ must have C_1 and C_5 to the left and C_6 to the right (and hence $T_{S_1^1} = \emptyset$ as we can not have $\phi_R(S_1)$ upward oriented and having C_5 to the left and C_6 to the right), $\phi_R(S_2)$ must have one end at C_2, C_3 and must have C_8 to the left, $\phi_R(S_3)$ must have one end at C_8 .

and $\tau^B(S)$ for $S \in \mathcal{S}$. Clearly, we reject τ if for some $S \in \mathcal{S}$ the cliques from $\text{Priv}^A(S)$ or from $\text{Priv}^B(S)$ are not consecutive in τ .

Our main task is to check whether there exists an extended $C_{i_1} \dots C_{i_k}$ -conformal model ϕ of G such that $\tau(\phi) = \tau$. The most important question that arises when trying to construct such a model is whether we should place the slot S^0 above or below the stabilizer, for every $S \in \mathcal{S}$. Clearly, we cannot check all possibilities as there can be exponentially many of them. To avoid this problem, we construct a 2-SAT formula Φ , with variable x_{S^0} for every CA-module $S \in \mathcal{S}$, which has the property that the sets of true variables in the assignments satisfying Φ correspond to the sets of CA-modules S with the slot S^0 above the stabilizer in the conformal models ϕ of G extending τ . Formally, we will construct Φ such that the following lemma is satisfied.

Lemma 6.2.

(1) For every $C_{i_1} \dots C_{i_k}$ -conformal model ϕ of G extending τ an assignment α_ϕ given by

$$\alpha_\phi(x_{S^0}) = \begin{cases} T & \text{if } \phi|_{S^0} \text{ is above } s^0 s^1 \\ F & \text{if } \phi|_{S^0} \text{ is below } s^0 s^1 \end{cases} \quad \text{for } S \in \mathcal{S},$$

makes the formula Φ true.

(2) For every assignment α satisfying Φ there exists an extended $C_{i_1} \dots C_{i_k}$ -model ϕ of G such that $\tau(\phi) = \tau$ and $\alpha_\phi = \alpha$.

We first we define the clauses of Φ and then we prove that Φ satisfies the properties of Lemma 6.2.

The clauses of Φ are defined as follows:

- For every $S \in \mathcal{S}$:
 - If there exists no $(\tau^A(S), \tau^B(S))$ -admissible model for \mathbb{S} , we add the clause $\neg x_{S^0}$ to Φ .
 - If there exists no $(\tau^B(S), \tau^A(S))$ -admissible model for \mathbb{S} , we add the clause x_{S^0} to Φ .
 We discuss how to test whether there is an $(\tau^A(S), \tau^B(S))$ -admissible model ($(\tau^B(S), \tau^A(S))$ -admissible) for \mathbb{S} in the last paragraph of this section.
- For every two distinct $S_1, S_2 \in \mathcal{S}$:
 - If $T_{S_1^0} \cap T_{S_2^0} = \emptyset$, we add the clause $\neg(x_{S_1^0} \wedge x_{S_2^0})$ to Φ .
 - If $T_{S_1^0} \cap T_{S_2^1} = \emptyset$, we add the clause $\neg(x_{S_1^0} \wedge \neg x_{S_2^0})$ to Φ .
 - If $T_{S_1^1} \cap T_{S_2^0} = \emptyset$, we add the clause $\neg(\neg x_{S_1^0} \wedge x_{S_2^0})$ to Φ .
 - If $T_{S_1^1} \cap T_{S_2^1} = \emptyset$, we add the clause $\neg(\neg x_{S_1^0} \wedge \neg x_{S_2^0})$ to Φ .

In the proof of Lemma 6.2 we use so-called *Trapezoid Lemma*, whose proof (purely geometrical) can be found in the Appendix. To state Trapezoid Lemma, we need a short definition. We say that two trapezoids T_1 and T_2 spanned between A and B *nicely intersect* if there is a segment t_1 spanned between A and B and contained in T_1 and a segment t_2 spanned between A and B and contained in T_2 such that t_1 and t_2 are intersecting strictly between the lines A and B . The Trapezoid Lemma asserts that for every family of pairwise nicely intersecting trapezoids one can pick a segment spanned between A and B from each trapezoid such that all the picked segments have different endpoints and are pairwise intersecting.

Proof of Lemma 6.2. Suppose ϕ is an extended $(C_{i_1}, \dots, C_{i_k})$ -conformal model of G such that $\tau(\phi) = \tau$ and suppose ϕ_R is the skeleton of ϕ satisfying properties (P1)–(P3). We will show that the assignment α_ϕ satisfies formula Φ .

Let $S \in \mathcal{S}$. Suppose $x_{S^0} = T$ in α_ϕ , which means $\phi|S^0$ is above s^0s^1 . Then, property (P1) asserts $(\phi|S^0, \phi|S^1)$ is an $(\tau^A(S), \tau^B(S))$ -admissible model of \mathbb{S} , and hence we do not have the clause $\neg x_{S^0}$ in Φ . If $x_{S^0} = F$ in α_ϕ , which means $\phi|S^0$ is below s^0s^1 , then $(\phi|S^0, \phi|S^1)$ is an $(\tau^B(S), \tau^A(S))$ -admissible model of \mathbb{S} , and hence we do not have the clause x_{S^0} in Φ . This proves α_ϕ satisfies all one-literal clauses in Φ .

Let S_1, S_2 be two distinct CA-modules from \mathcal{S} . Suppose $x_{S_1^0} = x_{S_2^0} = T$ in α_ϕ , which means $\phi|S_1^0$ and $\phi|S_2^0$ are above s^0s^1 in ϕ . Clearly, we have $\phi_R(S_1) \subseteq T_{S_1^0}$ and $\phi_R(S_2) \subseteq T_{S_2^0}$ by property (P3), and hence $T_{S_1^0} \cap T_{S_2^0} \neq \emptyset$ as $\phi_R(S_1)$ and $\phi_R(S_2)$ are intersecting by property (P2). In particular, we do not have the clause $\neg(x_{S_1^0} \wedge x_{S_2^0})$ in Φ . The remaining cases are proven analogously. This shows α_ϕ satisfies all two-literal clauses in Φ and hence satisfies Φ . This completes the proof of statement (1).

Now, suppose α is an assignment that satisfies Φ . For every $S \in \mathcal{S}$ let

$$S^A = \begin{cases} S^0 & \text{if } x_{S^0} = T, \\ S^1 & \text{if } x_{S^0} = F. \end{cases}$$

and let S^B be such that $\{S^A, S^B\} = \{S^0, S^1\}$. We will show that there is a $C_{i_1} \dots C_{i_k}$ -admissible model ϕ of G extending τ such that $\phi|_{S^A}$ is above $s^0 s^1$ for every $S \in \mathcal{S}$.

Let $S \in \mathcal{S}$. The one-literal clauses of Φ assert there exists a model (ϕ_S^0, ϕ_S^1) of \mathbb{S} which is admissible for $(\tau^A(S), \tau^B(S))$ if $S^A = S^0$ and admissible for $(\tau^B(S), \tau^A(S))$ if $S^A = S^1$. Indeed, if $S^A = S^0$, then $x_{S^0} = T$ in α , we do not have the clause $\neg x_{S^0}$ in Φ , and hence there is $(\tau^A(S), \tau^B(S))$ -admissible model (ϕ_S^0, ϕ_S^1) for \mathbb{S} . If $S^A = S^1$, then we have $x_{S^0} = F$ in α , we do not have the clause x_{S^0} in Φ , and hence there is $(\tau^B(S), \tau^A(S))$ -admissible model (ϕ_S^0, ϕ_S^1) for \mathbb{S} .

The two-literal clauses of Φ assert that for $S \in \mathcal{S}$ the trapezoids T_{S^A} are pairwise intersecting. Suppose S_1 and S_2 are two distinct CA-modules from \mathcal{S} . Indeed, if $S_1^A = S_1^0$, $S_2^A = S_2^0$, then we have $x_{S_1^0} = x_{S_2^0} = T$ in α , we do not have the clause $\neg(x_{S_1^0} \wedge x_{S_2^0})$ in Φ , and hence we have $T_{S_1^0} \cap T_{S_2^0} \neq \emptyset$. The other cases are proven analogously.

Now, properties (P2)–(P3) assert that the trapezoids T_{S^A} for $S \in \mathcal{S}$ are pairwise intersecting. We can easily observe that they are also pairwise nicely intersecting. Hence, Trapezoid Lemma asserts that for every $S \in \mathcal{S}$ we can draw a segment $\phi_R(S)$ spanned between A and B in every trapezoid T_{S^A} such that the drawn segments have different endpoints and are pairwise intersecting. We orient $\phi_R(S)$ such that S^A is above $s^0 s^1$, for every $S \in \mathcal{S}$. Now, for $S \in \mathcal{S}$ we replace the letters S^0 and S^1 in ϕ_R by the words ϕ_S^0 and ϕ_S^1 , respectively, obtaining the circular word ϕ . One can easily check that ϕ is an extended C_{i_1}, \dots, C_{i_k} -admissible model for G such that $\tau(\phi) = \tau$ and $\alpha_\phi = \alpha$. \square

We end this section by sketching a poly-time algorithm testing whether there is a $(\tau^A(S), \tau^B(S))$ -admissible model for \mathbb{S} , for $S \in \mathcal{S}$. Suppose we search for a $(\tau^A(S), \tau^B(S))$ -admissible model for \mathbb{S} (the other case is similar). Recall that $\tau^A(S)$ and $\tau^B(S)$ are permutations of $\text{Priv}^A(S)$ and $\text{Priv}^B(S)$, respectively, and $\text{Priv}^A(S) \cup \text{Priv}^B(S) = \text{Priv}(S)$. Using the same ideas as in Subsection 6.1 we add a set of restrictions on admissible orderings of some M-nodes of \mathcal{T}_S which assert that every admissible model for \mathbb{S} admitting those restrictions can be extended to $(\mu^A(S), \mu^B(S))$ -admissible model of \mathbb{S} , where $\mu^X(S)$ is a permutation of $\text{Priv}^X(S)$ for $X \in \{A, B\}$. We want to test whether any of those models can be turned into $(\tau^A(S), \tau^B(S))$ -admissible model for \mathbb{S} . Clearly, there is no such model if for some two cliques $C, C' \in \text{Priv}^A(S)$ with C' occurring before C in $\tau^A(S)$ there are $a, b \in S$ such that $b <_S a$, $b^1 \in S^0$, $a^0 \in S^0$, $b \in C$, and $a \in C'$ (see Figure 6.3 to the left). So, suppose that such configurations do not exist for cliques in $\tau^A(S)$ and analogously for cliques in $\tau^B(S)$. Now, we add additional restrictions on the set of admissible orderings (ϕ_S^0, ϕ_S^1) of \mathbb{S} which assert that for every two cliques $C, C' \in \text{Priv}^A(S)$ with C' occurring before C in $\tau^A(S)$ we do not have $b, a \in S$ such that $b \sim a$, $b^1 \in S^0$, $a^0 \in S^0$, $b \in C$, $a \in C'$, and b^1 is before a^0 in ϕ_S^0 (see Figure 6.3 to the right). We add analogous restrictions for every two cliques from $\tau^B(S)$. Clearly, there is no $(\tau^A(S), \tau^B(S))$ -admissible model for \mathbb{S} if the set of models satisfying all restrictions is empty. Otherwise, we start with any $(\mu^A(S), \mu^B(S))$ -admissible model (ϕ_S^0, ϕ_S^1) for \mathbb{S} , where $\mu^X(S)$ is a permutation of $\text{Priv}^X(S)$ for $X \in \{A, B\}$. One can easily observe that whenever the order of two neighbouring cliques C and C' in ϕ_S^0 is inconsistent with its order in $\tau^A(S)$, we can shift and swap C and C' inside ϕ_S^0 as we have excluded all the configurations which could forbid such a

swap. We proceed analogously with the cliques in $\tau^B(S)$. Clearly, the above ideas allow us to design a poly-time algorithm testing existence of a $(\tau^A(S), \tau^B(S))$ -admissible model for \mathbb{S} with S^0 above the stabilizer.

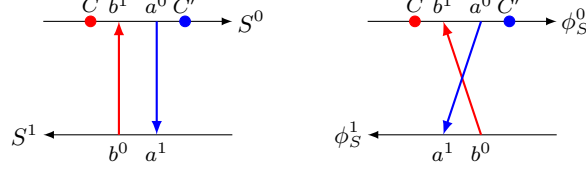

FIGURE 6.3. Forbidden configurations for the existence of $(\tau^A(S), \tau^B(S))$ -admissible model for \mathbb{S} , where C, C' are two cliques from $\text{Priv}^A(S)$ with C' before C in $\tau^A(S)$.

7. POLYNOMIAL KERNEL FOR THE HELLY CLIQUE PROBLEM

In this section we prove the following.

Theorem 7.1. *HELLY CLIQUES admits a kernel of size $O(k^6)$.*

Suppose G, C_1, \dots, C_k is an input to the Helly Clique problem. As in the previous section, we can assume C_1, \dots, C_k are ambiguous and satisfy properties (C1)–(C3). For every private clique $C_i \in \{C_1, \dots, C_k\}$ by S_{C_i} we denote the CA-module of G such that $C_i \in \text{Priv}(S_{C_i})$. We note that S_{C_i} is not defined when C_i is public, which might only happen when $V(G)$ is serial in $\mathcal{M}(G_{ov})$. For convenience, we slightly abuse our convention and we assume $\text{Priv}(V(G)) = \{C_1, \dots, C_k\}$ if $V(G)$ is serial in $\mathcal{M}(G_{ov})$, and $\text{Priv}(Q) = \bigcup \{\text{Priv}(S) : S \in \mathcal{S}(Q)\}$ for every prime Q-node Q . Also, we extend the notation from the previous section and for every M-node M we let

$$\begin{aligned} \text{Cl}(M) &= \{C_i : C_i \cap M \neq \emptyset\}, \\ \text{Priv}(M) &= \{C_i : C_i \text{ is private for } M\}. \end{aligned}$$

Suppose N is a prime node (M-node or Q-node) in \mathcal{T} and C, C' are two distinct cliques from $\{C_1, \dots, C_k\}$ such that $C, C' \in \text{Priv}(N)$. Note that $S_C = S_{C'}$ if N is an M-node. We say that:

- N binds C and C' on the same side if any order from $\Pi(N)$ binds C in S_C^j and binds C' in $S_{C'}^j$ for some $j \in \{0, 1\}$,
- N binds C and C' on different sides if any order from $\Pi(N)$ binds C in S_C^j and C' in $S_{C'}^{1-j}$ for some $j \in \{0, 1\}$.
- N binds C and C' if N binds C and C' on the same side or on different sides.

Lemmas 5.9.(3), 5.10.(3) and 5.11.(3) assert that N binds C and C' if and only if N binds C and C' either on the same or on different sides.

Suppose N is a serial node (M-node or Q-node) in \mathcal{T} and C, C' are two distinct cliques from $\{C_1, \dots, C_k\}$ such that $C, C' \in \text{Priv}(N)$. We say that:

- N binds C and C' on the same side if there are two distinct children K, L of N such that $C, C' \in \text{Priv}(K)$, $C, C' \in \text{Cl}(L)$, and the vertices from $C \cap L$ and $C' \cap L$ have the same orientation in \mathbb{L} ,
- N binds C and C' on different sides if there are two distinct children K, L of N in \mathcal{T}_Q such that $C, C' \in \text{Priv}(K)$, $C, C' \in \text{Cl}(L)$, and the vertices from $C \cap L$ and $C' \cap L$ have different orientation in \mathbb{L} ,
- N binds C and C' if N binds C and C' either on the same or on different sides.

Note that, since $C \in \text{Priv}(K)$ ($C' \in \text{Priv}(K)$), the vertices from $C \cap L$ ($C' \cap L$, respectively) have the same orientation in \mathbb{L} .

Lemma 5.12 yields the following:

Observation 7.2. *Let C, C' be two cliques bound by a node N from \mathcal{T} and let ϕ be a $\{C, C'\}$ -conformal model of G . Then:*

- If C and C' are bound on the same side, then there is $j \in \{0, 1\}$ such that C is contained in $\phi|S_C^j$ and C' is contained in $\phi|S_{C'}^j$.
- If C and C' are bound on different sides, then there is $j \in \{0, 1\}$ such that C is contained in $\phi|S_C^j$ and C' is contained in $\phi|S_{C'}^{1-j}$.

Our kernelization algorithm traverses the trees \mathcal{T}_Q in the bottom-up order and marks every inner node of \mathcal{T}_Q either as *important* or *irrelevant*. Also, when the algorithm marks some node as important, it also marks some of its vertices as *important* (the vertices which remain unmarked can be considered as irrelevant). Roughly speaking, the important vertices form a subset of $V(G)$ of size $O(k^6)$ which preserves all relevant information allowing to conclude that we are dealing with **no**-instance in the case where there is no $\{C_1, \dots, C_k\}$ -conformal model of G . Formally, the algorithm returns as a kernel a reduct of G with respect to the set of important vertices and the cliques C_1, \dots, C_k restricted to the set of important vertices. We will show that the restricted instance is equivalent to the input instance.

Now we show how we process a single Q-node Q in \mathcal{T} . We traverse the tree \mathcal{T}_Q in the bottom-up order and for every inner node $N \in \mathcal{T}$ such that $\text{Priv}(N) \neq \emptyset$ we compute a partition $\text{blocks}(N)$ of the set $\text{Priv}(N)$ into so-called *blocks* of N . Additionally, for every block $B \in \text{blocks}(N)$ we maintain a partition $\text{sides}(B)$ of the set B into so-called *sides* of B .

Suppose the sets $\text{blocks}(K)$ and their sides are already computed for every child K of N in \mathcal{T}_Q . Note that the sets $\text{Priv}(K)$ are pairwise disjoint. We compute the set $\text{blocks}(N)$ as follows. We first initialize the set $\text{blocks}(N)$ such that it contains all the sets $\text{blocks}(K)$ of the children K of N and blocks $\{C\}$ with one side empty for every C such that N is the deepest owner of C (if this holds then we say that C is introduced by N). Next, we iterate over all the pairs $C', C'' \in \text{Priv}(N)$ and we do the following:

- if C' and C'' are bound by N on the same side, then:
 - if C' and C'' are in the same block $B \in \text{blocks}(N)$ but in different sides of B , then we reject the instance G, C_1, \dots, C_k ,

- if C' and C'' are in different blocks, say $B' \in \text{blocks}(N)$ and $B'' \in \text{blocks}(N)$ respectively, then we form a new block $B = B' \cup B''$ with two sides, one obtained by merging the side of B' containing C' and the side of B'' containing C'' , and the second by merging the two remaining blocks of B' and B'' . If the above holds, then we say N merges two blocks through the cliques C' and C'' .
- if C' and C'' are bound by N on different sides, then:
 - if C' and C'' are in the same block $B \in \text{blocks}(N)$ and the same side of B , then we reject the instance G, C_1, \dots, C_k ,
 - if C' and C'' are in different blocks, say $B' \in \text{blocks}(N)$ and $B'' \in \text{blocks}(N)$ respectively, then we form a new block $B = B' \cup B''$ with two sides, one obtained by merging the side of B' containing C' and the side of B'' containing no C'' , and the second by merging the two remaining blocks in B' and B'' . If the above holds, then we say N merges two blocks through the cliques C' and C'' .

Observation 7.2 asserts there is no $\{C_1, \dots, C_k\}$ -conformal model of G in the case we reject the input instance. Otherwise (the set $\text{blocks}(N)$ is computed),

(N): We mark N as irrelevant if $\text{blocks}(N) = \text{blocks}(K)$ for some child K of N ; otherwise, we mark N as important.

When we mark N as important, we mark some vertices of N as *important*, according to the following rules.

If N is prime or parallel and N was marked as important, then:

- (V1):** If C is introduced by N , we mark two vertices a, b from $C \cap N$ with different orientations in \mathbb{N} . Moreover, if N affects C , we choose a and b such that $a \sim b$.
- (V2):** If N merges two blocks through C' and C'' , then:
- if C' is not introduced by N , we mark any vertex $c' \in C' \cap N$ from any child N' of N such that $C' \notin \text{Priv}(N')$.
 - if C'' is not introduced by N , we mark any vertex $c'' \in C'' \cap N$ from any child N'' of N such that $C'' \notin \text{Priv}(N)$.

If N is serial and N was marked as important, the marking procedure of important vertices in N is performed in two phases. First, we first mark some children of N as *weakly important*.

(W1): If K is a child of N such that $\text{Priv}(K) \neq \emptyset$, we mark K as weakly important.

Also, we might mark as weakly important some children K of N such that $\text{Priv}(K) = \emptyset$. The marking procedure for this case requires some preparation. First, we define the set $\text{sgn}(N)$ of *signatures* of N :

$$\text{sgn}(N) = \{(A, B) : A, B \subseteq \text{Priv}(N), A \cap B = \emptyset, |A \cup B| \leq 4\}.$$

Next, for every child K of N such that $\text{Priv}(K) = \emptyset$ and $\text{Cl}(K) \cap \text{Priv}(N) \neq \emptyset$ we define a partition of the set $\text{Cl}(K) \cap \text{Priv}(N)$ into two sets $\text{Cl}_{01}(K)$ and $\text{Cl}_{10}(K)$:

$$\begin{aligned} \text{Cl}_{01}(K) &= \{C \in \text{Cl}(K) \cap \text{Priv}(N) : \text{the chords from } C \cap K \text{ are } (K^0, K^1)\text{-oriented in } \mathbb{K}\}, \\ \text{Cl}_{10}(K) &= \{C \in \text{Cl}(K) \cap \text{Priv}(N) : \text{the chords from } C \cap K \text{ are } (K^1, K^0)\text{-oriented in } \mathbb{K}\}, \end{aligned}$$

and the set $\text{sgn}_K(N)$ of signatures of N occurring in the node K :

$$\text{sgn}_K(N) = \{(A, B) \in \text{sgn}(N) : A \subseteq \text{Cl}_{01}(K), B \subseteq \text{Cl}_{10}(K)\}.$$

See Figure 7.1 for an illustration. Now, we can describe the procedure which marks as weakly important some children K of N with $\text{Priv}(K) \neq \emptyset$. First, we denote all the signatures in the set $\text{sgn}(N)$ as not visited. Next, we iterate over the children K of N such that $\text{Priv}(K) \neq \emptyset$ (in any order) and we do the following:

(W2): For every signature (A, B) occurring in the set $\text{sgn}_K(N)$ which is not yet visited, we mark (A, B) as visited and we mark the node K as weakly important.

Note that child K of N is not marked as weakly important if and only if $\text{Priv}(K) = \emptyset$ and all signatures from $\text{sgn}_K(N)$ have been visited by some weakly important children of N . Finally, we mark some vertices in the children of N marked as weakly important:

(V3): For every weakly important child K of N and every $C \in \text{Cl}(K) \cap \text{Priv}(N)$ mark a vertex from $C \cap K$.

This completes the description of the marking procedure.

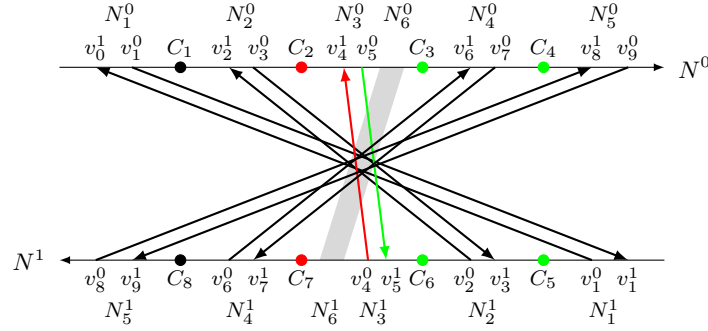

FIGURE 7.1. Serial M-node N and its six children N_1, \dots, N_5, N_6 with $\text{Cl}_{01}(N_1) = \text{Cl}_{10}(N_5) = \{C_1, C_2, C_3, C_4\}$, $\text{Cl}_{10}(N_1) = \text{Cl}_{01}(N_5) = \{C_5, C_6, C_7, C_8\}$, $\text{Cl}_{01}(N_2) = \{C_2\}$ and $\text{Cl}_{10}(N_2) = \{C_1\}$, $\text{Cl}_{01}(N_3) = \{C_3, C_4, C_5, C_6\}$ and $\text{Cl}_{10}(N_3) = \{C_2, C_7\}$ (asserted by $v_4 \in C_2, C_7$ and $v_5 \in C_3, C_4, C_5, C_6$), $\text{Cl}_{01}(N_4) = \{C_4\}$ and $\text{Cl}_{10}(N_4) = \{C_3\}$, $\text{Cl}_{01}(N_6) = \{C_3, C_4, C_6\}$ and $\text{Cl}_{10}(N_6) = \{C_2, C_7\}$. So we have $\text{Priv}(N) = \{C_1, \dots, C_8\}$ and $\text{Priv}(N_i) = \emptyset$ for $i \in [6]$. The set $\text{sgn}_{N_3}(N)$ contains the pairs (A, B) , where A is a subset of $\{C_3, C_4, C_5, C_6\}$ of size at most 2 and B is a subset of $\{C_2, C_7\}$. Suppose the children of N are processed in the order N_1, \dots, N_6 . Then N_1, N_2, N_3, N_4, N_5 are marked as weakly important as they mark as visited signatures $(\{C_1\}, \{C_5\})$, $(\{C_2\}, \{C_1\})$, $(\{C_3\}, \{C_2\})$, $(\{C_4\}, \{C_3\})$, and $(\{C_8, C_4\})$, respectively, N_6 is not weakly important as $\text{sgn}_{N_6}(N) \subseteq \text{sgn}_{N_3}(N)$. Since $\tau^0 = C_2C_3C_4$ and $\tau^1 = C_7C_6$, we have $C_L^0 = C_2$, $C_L^1 = C_7$, $C_R^0 = C_3$, $C_R^1 = C_6$. Since $(\{C_3, C_6\}, \{C_2, C_7\})$ is in the set $\text{sgn}_{N_3}(N)$, we can place the chords from $\phi(N_6)$ next to N_2 (inside the gray trapezoid).

Observation 7.3. *The algorithm marks $O(k)$ nodes of \mathcal{T} as important, $O(k^5)$ nodes as weakly important, and $O(k^6)$ vertices of G as important.*

Proof. We mark at most $O(k)$ nodes as important as the algorithm introduces k singleton blocks and merges blocks at most $k-1$ times. We mark $O(k^5)$ nodes as weakly important as the set $\text{sgn}(N)$ has size $O(k^4)$. Consequently, we mark $O(k^6)$ vertices as important. \square

Let R denote the set of important vertices in G . We now formally define the *reduct* of G with respect to R .

Definition 7.4. *We say that a circular-arc graph $G' = (V', E')$ is a reduct of G with respect to R if:*

- (1) $R \subseteq V'$.
- (2) For every conformal model ϕ of G there is a conformal model ϕ' of G' such that $\phi|_{R^*} \equiv \phi'|_{R^*}$.
- (3) For every conformal model ϕ' of G' there is a conformal model ϕ of G such that $\phi|_{R^*} \equiv \phi'|_{R^*}$.

As we show in the Appendix in Section 9.1, there is a polynomial-time algorithm computing a reduct $G' = (V', E')$ of G with respect to R such that $|V'| \leq 12 \cdot |R|$. To finish the kernelization, we let G^* be a reduct of G respecting R and let C_i^* be C_i restricted to R . Note that C_i^* is non-empty for every $i \in [k]$.

Lemma 7.5. *$(G^*, C_1^*, \dots, C_k^*)$ is a kernel of size $O(k^6)$ for the instance (G, C_1, \dots, C_k) of HELLY CLIQUES.*

Proof. Since the reduct G^* of G respecting R has size linear in $|R|$, we deduce the instance $(G^*, C_1^*, \dots, C_k^*)$ has size $O(k^6)$.

We need to show that (G, C_1, \dots, C_k) is a **yes**-instance if and only if $(G^*, C_1^*, \dots, C_k^*)$ is a **yes**-instance.

Suppose (G, C_1, \dots, C_k) is a **yes**-instance of HELLY CLIQUES. Let ϕ be a $\{C_1, \dots, C_k\}$ -conformal model of G . Let ϕ^* be a conformal model of G^* such that $\phi^*|_R \equiv \phi|_R$; such a model exists as G^* is the reduct of G respecting R . One can easily observe that ϕ^* can be easily extended to the $\{C_1^*, \dots, C_k^*\}$ -conformal model of G^* as we can insert the clique letters $\{C_1^*, \dots, C_k^*\}$ into ϕ^* so as its position relative to the chords $\phi^*(R)$ is the same as the relative position of the clique letters $\{C_1, \dots, C_k\}$ to the chords $\phi(R)$ in the model ϕ .

Suppose $(G^*, C_1^*, \dots, C_k^*)$ is a **yes**-instance of HELLY CLIQUES. Let ϕ^* be a $\{C_1^*, \dots, C_k^*\}$ -conformal model of G^* . Let ϕ be an admissible model of G such that $\phi|_R \equiv \phi^*|_R$ – such a model exists as G^* is a reduct of G . Next, we extend ϕ by the letters $\{C_1^*, \dots, C_k^*\}$ so as ϕ is a $\{C_1^*, \dots, C_k^*\}$ -conformal model for G , and finally we replace the letter C_i^* by C_i in ϕ for $i \in [k]$. As far we know that C_i is on the left side of $\phi(v)$ for every $v \in C_i^*$ and every $i \in [k]$.

Now, for every Q-node Q we proceed the trees \mathcal{T}_Q bottom up (in any order) and we show we can modify ϕ so as for every node $N \in \mathcal{T}_Q$ with $\text{Priv}(N) \neq \emptyset$ the following properties hold:

- (M1):** For every block $B \in \mathbf{blocks}(N)$ with $\mathbf{sides}(B) = \{B', B''\}$ there is $j \in \{0, 1\}$ such that for every $C' \in B'$ the clique C' occurs in $\phi|S_C^j$ and for every $C'' \in B''$ the clique C'' occurs in $\phi|S_{C''}^{1-j}$.
- (M2):** For every $C \in \mathbf{Priv}(N)$ and every $c \in C \cap N$ the point C is on the left side of the chord $\phi(c)$.

Suppose N is a prime M-node which was marked as irrelevant by rule (N). In particular, it means there is a child K of N such that $\mathbf{blocks}(N) = \mathbf{blocks}(K)$. So, we have also $\mathbf{Priv}(N) = \mathbf{Priv}(K)$. Suppose $N \subseteq S$ for CA-module S of G and suppose $\{A', A''\}$ is a partition of the cliques affected by N such that any order $\pi \in \Pi(N)$ binds the cliques from A' in S^j and binds the cliques from A'' in S^{1-j} , for some $j \in \{0, 1\}$. Since $\mathbf{blocks}(N) = \mathbf{blocks}(K)$ and since N did not result in rejection of the input instance and in merging two blocks of N , we deduce that there is a block B in $\mathbf{blocks}(K)$ which contains A' and A'' in different sides. Since the model ϕ satisfies (M1) for the node K , there is $j \in \{0, 1\}$ such that B' is contained in $\phi|K^j$ and B'' is contained in $\phi|K^{1-j}$ for some $j \in \{0, 1\}$. Now, Lemma 5.10.(3) asserts we can adjust the ordering of N in ϕ to obtain a model which satisfies conditions (M1)–(M2) for N .

We can use an analogous argument (basing on Lemma 5.11.(3)) to assert properties (M1) and (M2) of ϕ for the case when N is a prime irrelevant Q-node.

Suppose N is a prime M-node which was marked as important by rule (N). Suppose $N \subseteq S$ for CA-module S of G . Suppose $\{A', A''\}$ is a partition of the cliques affected by N such that any order $\pi \in \Pi(N)$ binds the cliques from A' in S^j and the cliques from A'' in S^{1-j} , for some $j \in \{0, 1\}$. We claim that ϕ already satisfies condition (M1) for N . Clearly, ϕ satisfies condition (M1) for every child K of N . Consider the case when N merges two blocks B_1 and B_2 from $\mathbf{blocks}(N)$ through cliques C' and C'' . Suppose C' and C'' are bound on the same side by N . Note that rules (V1) and (V2) assert there are important vertices $a, b \in C' \cap N$ and $c, d \in C'' \cap N$ such that $a \sim b$, $c \sim d$, a and b are in distinct children of N , and c and d are in distinct children of N . Since $\phi(a)$ and $\phi(b)$ have C' on the left side, $\phi(c)$ and $\phi(d)$ have C'' on the left side, and since $\phi|_N$ binds C and C' in the same slot, we deduce C and C' occur in $\phi|S^j$ for some $j \in \{0, 1\}$. Since ϕ was consistent with the blocks of N before the merge, we deduce ϕ is also consistent after the merge. Finally, since N did not result in rejection, we deduce there is a block of N which contains A' and A'' in different sides. This shows ϕ satisfies (M1) for M . Note that, by Lemma 5.10.(3), property (M2) is satisfied for every clique C not introduced by N as there are important vertices $a, b \in C \cap N$ contained in different children of N . Also, by Lemma 5.9.(3), we can easily assert property (M2) for every clique C introduced by N , by possibly shifting the clique C inside the slot $\phi|N^j$ in which C occurs.

We can use an analogous argument (basing on Lemma 5.11.(3)) to assert property (M2) of ϕ for the case when N is a prime important Q-node.

Suppose N is a serial M-node and suppose N was marked as irrelevant by rule (N). In particular, there is a child K of N such that $\mathbf{blocks}(N) = \mathbf{blocks}(K)$. Suppose $N \subseteq S$ for CA-module S of G . Clearly, since N did not result in rejection and ϕ satisfies property (M1) for K , we deduce ϕ satisfies property (M1) for N . Now, we show we can modify ϕ

in order to satisfy (M2) for N . Let L be a child of N different than K . Claim 5.7.(2) asserts that for every clique $C \in \text{Cl}(L) \cap \text{Priv}(N)$ the chords from $C \cap L$ have the same orientation in \mathbb{L} . Clearly, if $\text{Cl}(L) \cap \text{Priv}(N) = \{C\}$, we can shift the chords $\phi(L)$ in ϕ to fulfil property (M2) for vertices $c \in C \cap L$. Suppose now that $|\text{Cl}(L) \cap \text{Priv}(N)| \geq 2$ and suppose A' and A'' is the partition of the set $\text{Cl}(L) \cap \text{Priv}(N)$ such that the elements from $C \cap L$ are (L^0, L^1) -oriented for $C \in A'$ and the elements from $C \cap L$ are (L^1, L^0) -oriented for $C \in A''$. In particular, N binds the cliques from A' (or from A'') on the same side and the cliques from A' and the cliques from A'' on the opposite sides. Again, since $\text{blocks}(N) = \text{blocks}(K)$ and since N did not result in rejection, we deduce A' and A'' are contained in different sides of a block B from $\text{blocks}(N)$. Since $\text{blocks}(N) = \text{blocks}(K)$, we deduce there is $j \in \{0, 1\}$ such that A' is contained in $\phi|K^j$ and A'' is contained in $\phi|K^{1-j}$. In particular, we can place the chords of $\phi(L)$ to satisfy condition (M2) for every vertex $c \in C \cap L$ and every clique $C \in \text{Cl}(L) \cap \text{Priv}(N)$. This shows we can modify ϕ so as it satisfies property (M2) for N .

We can use an analogous argument to assert properties (M1) and (M2) for the case when N is a serial irrelevant Q-node. Note that in this case $N = V$, V is serial in $\mathcal{M}(G_{ov})$, and $\text{Priv}(S) = \{C_1, \dots, C_k\}$ for some CA-module S of G .

Suppose N is a serial M-node and suppose N was marked as important. Suppose that $N \subseteq S$ for CA-module S of G . First note that ϕ satisfies the following properties with respect to every weakly important child K :

- ϕ is $\text{Priv}(K)$ -conformal model of G ,
- for every $C \in \text{Cl}(K) \cap \text{Priv}(N)$ the clique C is to the left of every chord from $\phi(C \cap K)$.

Suppose K was not marked as weakly important. In particular, we have $\text{Priv}(K) = \emptyset$. Let τ^0 be the sequence of all cliques from $\text{Cl}(K)$ occurring in $\phi|N^0$ and let τ^1 be the reverse of the sequence of all cliques from $\text{Cl}(K)$ occurring in $\phi|N^1$ – see Figure 7.1 for an illustration.

Suppose that the word τ^0 (τ^1) contains a clique from the set $\text{Cl}_{01}(K)$; let C_R^0 (C_R^1 , respectively) be the leftmost clique from τ^0 (in τ^1 , respectively) with this property. Suppose that the word τ^0 (τ^1) contains a clique from the set $\text{Cl}_{10}(K)$; let C_L^0 (C_L^1 , respectively) be the rightmost clique from τ^0 (from τ^1 , respectively) with this property. See Figure 7.1 and the node $K = N_6$ for an illustration. We claim that C_L^0 is before C_R^0 in the word τ^0 and C_L^1 is before C_R^1 in τ^1 . Indeed, note that $(\{C_R^0, C_R^1\}, \{C_L^0, C_L^1\})$ is a signature in the set $\text{sgn}_K(N)$. Since K was not marked as weakly important, there is a weakly important child L of N which has the signature $(\{C_R^0, C_R^1\}, \{C_L^0, C_L^1\})$ in the set $\text{sgn}_L(N)$. Now, we can place the chords from $\phi(K)$ just next to the chords $\phi(L)$ so as ϕ is a valid conformal model of G – see Figure 7.1. We proceed analogously in the case when some of the cliques $C_L^0, C_L^1, C_R^0, C_R^1$ is not defined. Indeed, using similar arguments as above we can prove that the cliques from $\text{Cl}_{10}(K)$ occur before the cliques from $\text{Cl}_{01}(K)$ in τ^0 and τ^1 and there are chords $\phi(L)$ for some weakly important child L of N which separate those two sets. Clearly, we can place the chords from $\phi(K)$ next to the chords from $\phi(L)$. After performing the above procedure for every not weakly important child of N , we get a model ϕ which satisfies properties (M1)-(M2) with respect to N .

Finally, assume N is a serial Q -node which was marked as important. It means that $N = V$ and V is serial in $\mathcal{M}(G_{ov})$. In this case we proceed similarly as for important serial M -nodes. Clearly, we need to take care about children of V which are not weakly important. Let K be one of such child.

First, suppose $\text{Cl}_{01}(K) \neq \emptyset$ and $\text{Cl}_{10}(K) \neq \emptyset$. Let τ be the sequence of all cliques from $\text{Cl}(K)$ occurring in ϕ . We need to show that the cliques from $\text{Cl}_{01}(K)$ form a contiguous subword in τ and the cliques from $\text{Cl}_{10}(K)$ form a contiguous subword in τ . Suppose this is not the case. It means that there are $C_1, C_3 \in \text{Cl}_{01}(K)$ and $C_2, C_4 \in \text{Cl}_{10}(K)$ such that $C_1C_2C_3C_4$ is a subword of τ . However, $(\{C_1, C_3\}, \{C_2, C_4\})$ is a signature in $\text{sgn}(V)$, which was marked as visited by some weakly important child L of V such that $\text{Priv}(L) = \emptyset$. Since $\phi|L^0$ and $\phi|L^1$ do not contain cliques and since for every $C \in \{C_1, \dots, C_k\}$ the chords from $\phi(C \cap L)$ are to the left of C , we deduce $C_1C_2C_3C_4$ can not be a subword of ϕ . We use similar arguments to show there is a child L of V with $\text{Priv}(L) = \emptyset$ which separates the cliques from $\text{Cl}_{01}(K)$ and from $\text{Cl}_{10}(K)$. Clearly, we can place the chords $\phi(K)$ next to $\phi(L)$ to assert condition (M2) for K .

Suppose now that $\text{Cl}_{01}(K) = \emptyset$ (the case $\text{Cl}_{10}(K) = \emptyset$ is analogous). Note that this implies $\text{Cl}(K) = \text{Cl}_{10}(K)$. Let L be any weakly important child of V such that $\text{Priv}(L) = \emptyset$. Let τ_L and τ_R be the sequences of all cliques from $\text{Cl}(K)$ lying on different sides of $\phi(L)$, respectively. If τ_L or τ_R is empty, we can clearly place the chords $\phi(K)$ next to $\phi(L)$ to assert condition (M2) for K . So, suppose both τ_L and τ_R are non-empty. Let C_1, C_2 be the first and last elements of τ_L and let C_3, C_4 be the first and last elements of τ_R , respectively. Since $(\emptyset, \{C_1, C_2, C_3, C_4\})$ is a signature in $\text{sgn}(V)$, it was marked as visited by some weakly important child L' of V such that $\text{Priv}(L') = \emptyset$. Since $\phi(L')$ must also intersect $\phi(L)$, we can clearly place the chords $\phi(K)$ next to $\phi(L')$ to assert condition (M2) for K .

Proceeding this way for every not weakly important child of V , we obtain a model ϕ which satisfies property (M2) for V . □

8. HELLY CLIQUES IS NP-COMPLETE

In this section we show that HELLY CLIQUES is NP-complete. Moreover, it remains NP-complete even if we fix the type of module formed by the vertex set in the modular decomposition of the overlap graph. This is an improvement over the NP-completeness proof of Agaoglu Çagirici and Zeman [5], as it required that the type of module was serial.

We are reducing from the TOTAL ORDERING problem. In TOTAL ORDERING we are given a universe S of size n and a set \mathbb{T} consisting of m triples (x, y, z) in S^3 . We want to determine whether there exists a linear ordering $(S, <)$ of S such that for every $(x, y, z) \in \mathbb{T}$ we have either $x < y < z$ or $x > y > z$ in $(S, <)$. Opatrny proved that the Total Ordering problem is NP-complete [21]. Also, the proof given in [21] asserts that, assuming Exponential Time Hypothesis (ETH), the Total Ordering problem cannot be solved in time $2^{o(m)}n^{O(1)}$.

Proof. Let $S = [n]$ and \mathbb{T} be an instance of the Total Ordering problem. Now, let G be any circular arc graph such that the PQM-tree of G contains a serial M -node M with the children M_1, \dots, M_n , where for every $i \in [n]$ we have $M_i = \{u_i, v_i\}$ for some two non-adjacent vertices u_i, v_i in G , u_i is (M^0, M^1) -oriented and v_i is (M^1, M^0) -oriented in \mathbb{M} . In particular, for every $i \in [n]$ we have that M_i is a parallel child of M and for every two distinct i, j from $[n]$ we have that $M_i \sim M_j$.

Now, for every triple (x, y, z) in \mathbb{T} we define two cliques $C_{(x,y,z)}$ and $C'_{(x,y,z)}$ in G , where

$$C_{(x,y,z)} = \{v_x, u_y, u_z\} \quad \text{and} \quad C'_{(x,y,z)} = \{v_z, u_x, u_y\}.$$

See Figure 8.1.

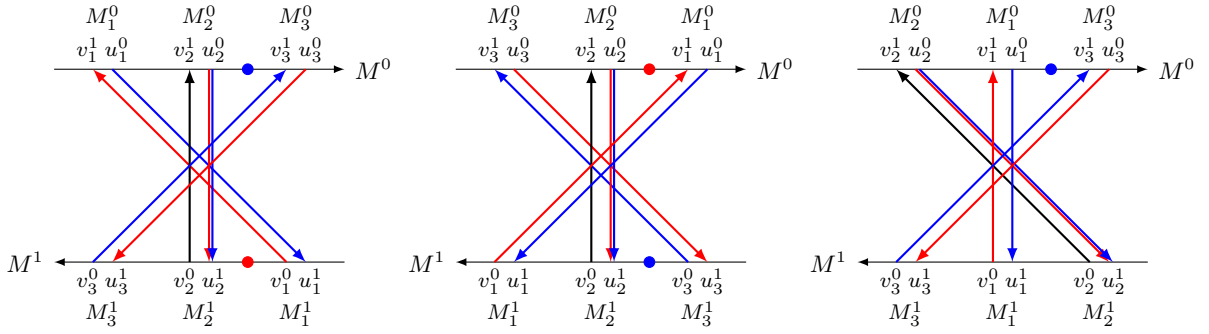

FIGURE 8.1. For a triple $(1, 2, 3)$ in \mathbb{T} we have two cliques: $C_{(1,2,3)}$ depicted in red and $C'_{(1,2,3)}$ depicted in blue. If $\phi|_M$ has M_2^0 between M_1^0 and M_3^0 (to the left) or between M_3^0 and M_1^0 (in the center), then both $C_{(1,2,3)}$ and $C'_{(1,2,3)}$ are Helly (witnessed by a red and blue point, respectively); otherwise, either $C_{(1,2,3)}$ or $C'_{(1,2,3)}$ is non Helly (to the right).

Let ϕ be a conformal model of G and let $\phi|_M = (\pi_M^0, \pi_M^1)$ be an admissible ordering of M in ϕ . Note that both $C_{(x,y,z)}$ and $C'_{(x,y,z)}$ satisfy the Helly property in ϕ if and only if M_y^0 occurs between M_x^0 and M_z^0 or between M_z^0 and M_x^0 in π_M^0 – see Figure 8.1. Finally, let

$$\mathbb{C} = \{C_{(x,y,z)}, C'_{(x,y,z)} : (x, y, z) \in \mathbb{T}\}.$$

Clearly, \mathbb{C} contains $2m$ cliques in G . The observation made above asserts that G, \mathbb{C} is a **yes**-instance of HELLY CLIQUES if and only if S, \mathbb{T} is a **yes**-instance of the Total Ordering problem. \square

Due to the above construction we obtain the following theorem.

Theorem 8.1. *Assuming ETH, HELLY CLIQUES cannot be solved in time $O(2^{\alpha(k)}|V(G)|^{O(1)})$ even if we fix the type of the module formed by the vertex set V in the modular decomposition of the overlap graph G_{ov} of the input graph $G = (V, E)$.*

Proof. Assuming ETH, the Total Ordering problem cannot be solved in time $O(2^{\alpha(m)}n^{O(1)})$.

Suppose for the sake of contradiction that we can solve HELLY CLIQUES in time $O(2^{\alpha(k)}|V(G)|^{O(1)})$. Since in the construction given above we create $2m$ cliques, we can

obtain an algorithm solving the Total Ordering problem in time $O(2^{o(m)}n^{O(1)})$, which is not possible if ETH holds. \square

9. APPENDIX

9.1. Reducts of circular-arc graphs.

Definition 9.1. *Let $G = (V, E)$ be a circular-arc graph and let $U \subseteq V$ be a subset of vertices of G . We say that a circular-arc graph $G' = (V', E')$ is a reduct of G with respect to U if:*

- (1) $U \subseteq V'$.
- (2) For every conformal model ϕ of G there is a conformal model ϕ' of G' such that $\phi|_{U^*} \equiv \phi'|_{U^*}$.
- (3) For every conformal model ϕ' of G' there is a conformal model ϕ of G such that $\phi|_{U^*} \equiv \phi'|_{U^*}$.

In this section we prove the following lemma.

Lemma 9.2. *Let $G = (V, E)$ be a circular-arc graph and let $U \subseteq V$ be a subset of vertices of G . Then, there is a polynomial-time algorithm computing a reduct $G' = (V', E')$ of G with respect to U such that $|V'| \leq 12 \cdot |U|$.*

To prove the lemma, we introduce some definitions.

First, for every CA-module $S \in \mathcal{S}$ we extend the notion of admissible models $\Phi(N)$ on every node N in \mathcal{T}_S . When $N = \{u\}$ (N is a leaf in \mathcal{T}_S), then $\Phi(N)$ contains a single oriented permutation model: (u^0, u^1) if u is (S^0, S^1) -oriented and (u^1, u^0) if u is (S^1, S^0) -oriented in \mathcal{S} . If N is an M-node, then the admissible models in $\Phi(N)$ are obtained by first picking any admissible ordering (π^0, π^1) in $\Pi(N)$ and then by replacing L^0 in π^0 by τ_L^0 and L^1 in π^1 by τ_L^1 , where L is any child L of N and (τ_L^0, τ_L^1) is any admissible model from $\Phi(L)$. Note that $\Phi(S)$ defined this way contains all the admissible models for CA-module S .

Next, we root \mathcal{T} in some Q-node R ; we denote \mathcal{T} rooted in R by $\hat{\mathcal{T}}_R$. Note that for any Q-node Q and any $S \in \mathcal{S}(Q)$, CA-module S and the slots S^0, S^1 are the children of Q in \mathcal{T}_R . For any PQ-node N in $\hat{\mathcal{T}}_R$, by $V(N)$ we denote the vertices contained in the components (Q-nodes) descending N in $\hat{\mathcal{T}}_R$ (including N) and by $U(N)$ we denote the set $V(N) \cap U$. Similarly, we set $V(N) = N$ if N is a node in \mathcal{T}_S for some $S \in \mathcal{S}$ and we set $U(N) = V(N) \cap U$. We say a node N in $\hat{\mathcal{T}}_R$ distinct than a slot is *important* if $U(N) \neq \emptyset$; slots S^0, S^1 are *important* if S is important.

We now extend the notion of admissible models $\Phi(N)$ on every PQ-node N in $\hat{\mathcal{T}}_R$. If N is a Q-node, then the admissible models in $\Phi(N)$ are obtained by first picking any admissible ordering π_N in $\Pi(N)$ and then by replacing in π_N :

- S^0 by τ_S^0 and S^1 by τ_S^1 , where S is any CA-module from $\mathcal{S}(N)$ and (τ_S^0, τ_S^1) is any admissible model from $\Phi(S)$,
- P by τ_P , where P is any P-node child of N and τ_P is any admissible model from $\Phi(P)$.

Similarly, if P is a P-node, then the admissible models in $\Phi(N)$ are obtained by picking first an admissible ordering π_N in $\Pi(N)$ and then by replacing in π_N the letter Q by τ_Q , where Q is any Q-node child Q and τ_Q is any admissible model from $\Phi(Q)$.

Note that for every PQ-node N with the parent N' in $\hat{\mathcal{T}}_R$, an admissible model from $\Phi(N)$ is a circular word over $V^*(N) \cup \{N'\}$. In this case, for some technical reasons we replace in every member of $\Phi(N)$ the letter N' by R . Note that $\Phi(R)$ coincides with the set of all conformal models of G .

The general idea behind the construction of the reduct of G is as follows. We traverse the tree $\hat{\mathcal{T}}_R$ bottom-up and we compress the tree $\hat{\mathcal{T}}_R$ to a new tree PQM-tree $\hat{\mathcal{T}}'_{R'}$ representing the conformal models of the reduct G' of G . In particular, with every important node N in $\hat{\mathcal{T}}_R$ a node N' in $\hat{\mathcal{T}}'_{R'}$ is associated, called the *reduct* of N . Roughly speaking, the reduct N' of N contains $U(N)$, has size linear in the size of $U(N)$, and satisfies the property that the set of chord configurations representing the vertices of $U(N)$ occurring in the admissible models in $\Phi(N)$ and in the admissible models in $\Phi(N')$ coincide (as in the definition of the reduct of G).

Now we proceed to the construction of the reduct G' of G and its PQM-tree $\hat{\mathcal{T}}'_{R'}$.

First, for every important CA-module S of G we process the tree \mathcal{T}_S bottom-up and we construct \mathcal{T}'_S . When processing an important node N in \mathcal{T}_S , we construct also the reduct N' of N in \mathcal{T}'_S , which is required to satisfy the following properties:

- $U(N) \subseteq N'$ and $|N'| \leq 12 \cdot |U(N)| - 10$,
- for every admissible model (τ^0, τ^1) in $\Phi(N)$ there is an admissible model (λ^0, λ^1) in $\Phi(N')$ such that $\tau^j|U^*(N) = \lambda^j|U^*(N)$ for $j \in \{0, 1\}$,
- for every admissible model (λ^0, λ^1) in $\Phi(N')$ there is an admissible model (τ^0, τ^1) in $\Phi(N)$ such that $\lambda^j|U^*(N) = \tau^j|U^*(N)$ for $j \in \{0, 1\}$.

Suppose we process an important node N in \mathcal{T}_S . If N is a leaf in \mathcal{T}_S , then we set $N' = N \cup \{v\}$, where v is a vertex of G' non-adjacent to N . Note that N' has two children, which are leaves in $\hat{\mathcal{T}}'_{R'}$. Clearly, N' satisfies the properties of the reduct of N . Suppose now that N is an important node in \mathcal{T}_S . If N has exactly one important child N_1 in \mathcal{T}_S , we set $N' = K_1$, where K_1 is the reduct of N_1 . Clearly, N' satisfies the properties of the reduct of N . Now, suppose N has at least two important children. Suppose N_1, \dots, N_k are the important children of N and K_1, \dots, K_k are their reducts, respectively.

If N is serial or parallel, we define the reduct N' of N by first setting $K = \bigcup_{i=1}^k K_i$ with the set $\Pi(K)$ obtained from $\Pi(N)$ by restricting the members of $\Pi(N)$ to the letters $\{N_1^0, N_1^1, \dots, N_k^0, N_k^1\}$ and by replacing N_i^j by K_i^j . Then, we create the reduct N' of N by extending K by the sets E_1, E_2, E_3 , where E_i contains two non-adjacent vertices of G' , and we set $\lambda = (E_1^0 E_2^0 E_3^0 K^0, E_3^1 E_1^1 K^1 E_2^1)$ as an admissible order of N' – see Figure 9.1.(a)

When N is prime, we proceed as follows. Let $\pi = (\pi^0, \pi^1)$ be an admissible ordering from $\Pi(N)$. Suppose N_1, N_2, \dots, N_k are enumerated such that N_i^0 occurs before N_j^0 in π^0 for every $i < j$ in $[k]$. We define N' such that $N' = (\bigcup_{i=1}^k (K_i \cup L_i \cup M_i)) \cup M$, where

each of the sets $L_1, M_1, \dots, L_k, M_k, M$ contains two non-adjacent vertices of G' , and we define an admissible ordering $\lambda = (\lambda^0, \lambda^1)$ of $\Pi(N')$ such that:

- $\lambda^0 = L_1^0 K_1^0 \dots L_k^0 K_k^0 M^0 M_1^0 \dots M_k^0$,
- the suffix of λ^1 contains the letters K_1^1, \dots, K_k^1 which occur in the same order as the letters N_1^1, \dots, N_k^1 in π^1 , the prefix of λ^1 equals to $M^1 L_k^1 M_k^1 \dots L_1^1 M_1^1$.

See Figure 9.1.(b) for an illustration. One can easily check that the module N' in the graph (N', \sim) is prime and has $K_1, L_1, M_1, \dots, K_k, L_k, M_k$ and M as its children. We can also easily verify that N' satisfies the properties of the reduct of N .

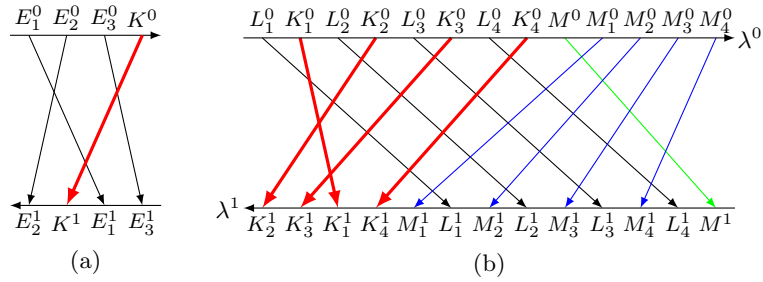

FIGURE 9.1. Figures (a) shows the extended reduct of N for the case when N is serial. Figure (b) shows the reduct of N for the case when N is prime: N has 4 important children N_1, \dots, N_4 with the reducts K_1, \dots, K_4 .

Next, we process the tree $\hat{\mathcal{T}}_R$ bottom up and we construct the tree $\hat{\mathcal{T}}'_{R'}$. When we process an important node N in $\hat{\mathcal{T}}_R$, we construct also the reduct N' of N in $\hat{\mathcal{T}}'_{R'}$, which is required to satisfy the following properties:

- for every admissible model τ in $\Phi(N)$ there is an admissible model λ in $\Phi(N')$ such that $\tau|(U^*(N) \cup \{R\}) = \lambda|(U^*(N) \cup \{R\})$,
- for every admissible model λ in $\Phi(N')$ there is an admissible model τ in $\Phi(N)$ such that $\lambda|(U^*(N) \cup \{R\}) = \tau|(U^*(N) \cup \{R\})$,
- $|V(N')| \leq 12 \cdot |U(N)| - 10$, where $V(N')$ is the set of the vertices from the components descending N' in $\hat{\mathcal{T}}'_{R'}$.

Then, the reduct of the root R is simply the reduct G' of G satisfying $|V(G')| \leq 12 \cdot |U| - 10$.

Suppose we process an important Q-node Q in $\hat{\mathcal{T}}_R$ which is not the root of $\hat{\mathcal{T}}_R$. If Q has exactly one important P-node child P with exactly one important Q-node child Q_1 , then we set $Q' = Q_1$ (that is, we set the reduct of Q_1 as the reduct of Q). Otherwise (Q has at least two important children in $\hat{\mathcal{T}}_R$ or Q has one important P-node child with at least two important Q-node children), we proceed as follows. We choose an admissible ordering π in $\pi(Q)$. Let $Rr_1r_2 \dots r_k$ be the circular word that arises from π by replacing the letter representing the parent of Q in $\hat{\mathcal{T}}_R$ by R and then by restricting π to important children of Q and to the letter R . Note that each r_i is either an important P-node child of Q or a

slot of an important CA-module contained in Q – see Figure 9.2. We define Q' such that

$$Q' = \bigcup \left\{ K : K \text{ is a reduct of an important CA-module in } \mathcal{S}(Q) \right\} \cup \left(\bigcup_{i=1}^k (L_i \cup M_i) \right) \cup M,$$

where each of the sets $L_1, M_1, \dots, L_k, M_k, M$ contains two non-adjacent vertices of G' , and we define an admissible ordering λ of $\Pi(N')$ such that

$$\lambda \equiv RL_1^0 r_1 L_2^0 r_2 \dots L_k^0 r_k L_k^1 M_1^1 L_{k-1}^1 M_2^0 \dots L_1^1 M_k^0 M^0 M_k^1 \dots M_1^1 M^1.$$

See Figure 9.2 for an illustration. Again, we can easily check that $L_1, M_1, \dots, L_k, M_k, M$ as well as the reducts of important CA-modules from $\mathcal{S}(Q)$ are the CA-modules of the component Q' of the overlap graph G'_{ov} of G' . Also, we can easily verify that Q' defined this way satisfies all the conditions of the reduct of Q .

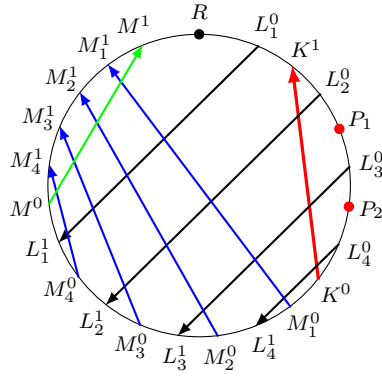

FIGURE 9.2. An admissible ordering of the reduct Q' of Q -node Q . Q has 4 important children P_1, P_2, S^0, S^1 in \mathcal{T}_R^{PQ} , K with the slots K^0, K^1 is the reduct of the CA-module S .

Now, suppose we process an important P-node P in $\hat{\mathcal{T}}_R$. If P has exactly one important Q-node child Q and Q has exactly one important P-node child P_1 , then we set $P' = P_1$ (that is, we set the reduct of P_1 as the reduct of Q). Otherwise (P has at least two important Q-node children in $\hat{\mathcal{T}}_R$ or P has one important Q-node child with at least two important children), we define the reduct P' of P by restricting P and $\Pi(P)$ to important Q-node children of P .

Finally, we define the reduct of R , which completes the definition of G' . If R has exactly one important child N , then we set $R' = K$, where K is the reduct of N . Otherwise, R has at least two important children and we proceed as follows. Suppose R is a serial Q-node (that is, R is the only inner node in $\hat{\mathcal{T}}_R$). Then, we set the reduct R' by restricting R and $\Pi(R)$ to important CA-modules of G . Finally, when R is prime, we proceed similarly as for an important prime node different than R .

9.2. Trapezoid Lemma. We say that trapezoids T_1 and T_2 are *nicely intersecting* if there exist a segment s_1 spanned between the bases of T_1 and a segment s_2 spanned between the bases of T_2 such that s_1 intersects s_2 and the endpoints of s_1 and s_2 are pairwise distinct. We now prove the following lemma.

Lemma 9.3. *Let A and B be two distinct horizontal lines on the plane, A above B . Let $\mathcal{T} = \{T_1, \dots, T_t\}$ be a set of t (possibly degenerated) trapezoids with one base contained in A (might be infinite and might be open/closed on each side) and one base contained in B (might be infinite and might be open/closed on each side). Then there exists a set of t pairwise intersecting segments $\{s_1, \dots, s_t\}$ with pairwise distinct endpoints spanned between A and B such that for each $i \in [t]$ the segment s_i is contained in T_i if and only if the trapezoids from \mathcal{T} pairwise nicely intersect.*

Proof. We assume that the bases of T_1, \dots, T_t are closed intervals. We leave to the reader to verify that the proof given below can be easily modified to handle all the cases.

One direction of the proof is trivial: if there is such a set of pairwise intersecting segments, then naturally the trapezoids from \mathcal{T} have to pairwise nicely intersect.

For the other direction suppose the trapezoids from $\{T_1, \dots, T_t\}$ pairwise nicely intersect. We now argue that there exists a desired choice of segments $\{s_1, \dots, s_t\}$.

First, we define relations $<_A$ and $<_B$ on the set of trapezoids \mathcal{T} . For trapezoids $T_i, T_j \in \mathcal{T}$ we say $T_i <_A T_j$ when the top-right corner of T_i is on the left or equal to the top-left corner of T_j (see Figure 9.3). Since T_i and T_j are nicely intersecting, if $T_i <_A T_j$ then the top-left corner of T_i is on the left of the top-right corner of T_j . In particular, this implies that there are no T_i, T_j such that $T_i <_A T_j$ and $T_j <_A T_i$. For trapezoids $T_i, T_j \in \mathcal{T}$ we say $T_i <_B T_j$ when the bottom-left corner of T_i is on the right of equal to the bottom-right corner of T_j (see Figure 9.3). Again, observe that there are no T_i, T_j such that $T_i <_B T_j$ and $T_j <_B T_i$. Observe that since T_i and T_j are nicely intersecting, if $T_i <_B T_j$ then the top-left corner of T_i is on the left of the top-right corner of T_j .

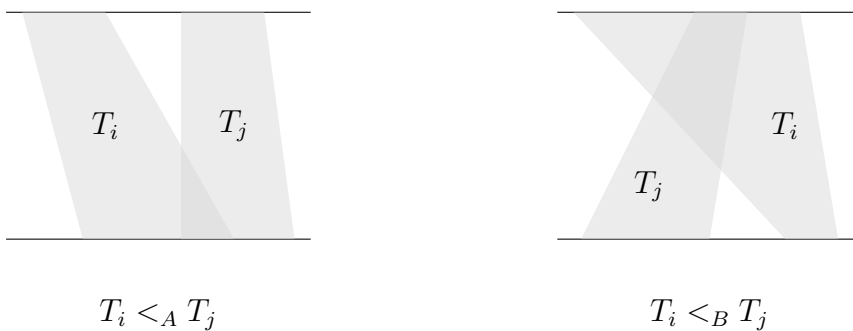

FIGURE 9.3. Examples of trapezoids in the relations $<_A$ and $<_B$.

We now claim that the union $<_A \cup <_B$ is acyclic on \mathcal{T} . Suppose for the sake of contradiction there is a cycle in $<_A \cup <_B$ and consider the shortest one. Since $<_A$ and $<_B$

are transitive, the cycle has to have even length and alternate between $<_A$ and $<_B$. Due to the observations above, an even cycle containing a trapezoid T_i would imply that the top-right corner of T_i is on the left of itself, which is a contradiction.

Since $<_A \cup <_B$ is acyclic, there is a topological order of $<_A \cup <_B$. Let $<$ be any such order.

Suppose the trapezoids T_1, \dots, T_t are enumerated consistently with $<$. We now inductively prove that there exists a valid choice of segments s_1, \dots, s_i for every $i \in [t]$ such that the top endpoint of s_j is on the left of the top endpoint of s_{j+1} for every $j \in [i-1]$.

The base case of $i = 1$ is trivial, as any choice of s_1 inside T_1 is valid.

Suppose $i > 1$. From the induction hypothesis there is a valid choice of segments s_1, \dots, s_{i-1} for T_1, \dots, T_{i-1} . Consider the trapezoid T_i . Observe that if for any $j < i$ the top endpoint of s_j is on the right or equal to the top-right corner of T_i , then T_j must contain the top-right corner of T_i since $T_j < T_i$. Moreover, the top-right corner of T_i is not equal to the top-left corner of T_j . Similarly, if the bottom endpoint of s_j is on the left of the bottom side of T_i , then T_j must contain the bottom-left corner of T_i . Moreover, the bottom-left corner of T_i is not equal to the bottom-right corner of T_j .

For every $j < i$ denote the top endpoint of s_j by a_j and the bottom endpoint by b_j . Let P be the top-right corner of T_i and Q be the bottom-left corner of T_i .

We create the valid set of segments for T_1, \dots, T_i the following way. Let $j \in [i-1]$ be the smallest number such that a_j is on the right of P . We move the top endpoints a_j, \dots, a_{i-1} to the left side of P but very close to it. Similarly, let $j' \in [i-1]$ be the smallest number such that $b_{j'}$ is on the left of Q . We move the bottom endpoints $b_{j'}, \dots, b_{i-1}$ to the right side of Q but very close to it.

Finally, we define s_i as the segment with endpoints P and Q . Note that a_{i-1} is on the left of P and b_{i-1} is on the right side of Q . This completes the induction (see Figure 9.4).

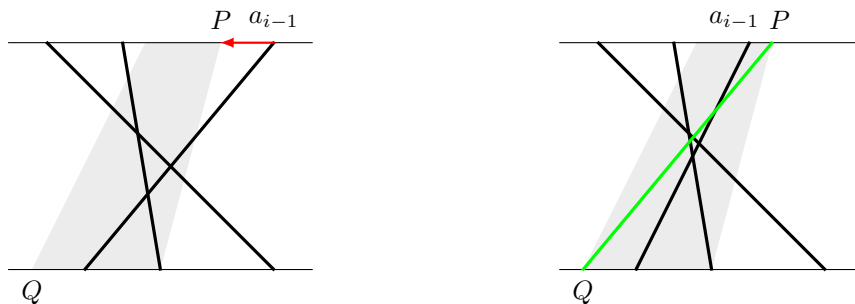

FIGURE 9.4. Example of the induction step. The trapezoid T_i is shaded. The endpoint a_{i-1} is moved slightly to the left of P , which allows to insert a segment s_i (depicted in green) inside T_i with endpoints P and Q .

□

REFERENCES

- [1] F. Bonomo, G. Durán, L. Grippo, and M. D. Safe. Partial characterizations of circular-arc graphs. *J. Graph Theory*, 61(4):289–306, 2009.
- [2] Kellogg S. Booth and George S. Lueker. Testing for the consecutive ones property, interval graphs, and graph planarity using PQ -tree algorithms. *J. Comput. System Sci.*, 13(3):335–379, 1976. Working Papers presented at the ACM-SIGACT Symposium on the Theory of Computing (Albuquerque, N. M., 1975).
- [3] Deniz Agaoglu Çagirici, Onur Çagirici, Jan Derbisz, Tim A. Hartmann, Petr Hlinený, Jan Kratochvíl, Tomasz Krawczyk, and Peter Zeman. Recognizing H-graphs - beyond circular-arc graphs. In Jérôme Leroux, Sylvain Lombardy, and David Peleg, editors, *48th International Symposium on Mathematical Foundations of Computer Science, MFCS 2023, August 28 to September 1, 2023, Bordeaux, France*, volume 272 of *LIPICs*, pages 8:1–8:14. Schloss Dagstuhl - Leibniz-Zentrum für Informatik, 2023.
- [4] Deniz Agaoglu Çagirici and Petr Hlinený. Isomorphism testing for t-graphs in FPT. In Petra Mutzel, Md. Saidur Rahman, and Slamin, editors, *WALCOM: Algorithms and Computation - 16th International Conference and Workshops, WALCOM 2022, Jember, Indonesia, March 24-26, 2022, Proceedings*, volume 13174 of *Lecture Notes in Computer Science*, pages 239–250. Springer, 2022.
- [5] Deniz Agaoglu Çagirici and Peter Zeman. Recognition and isomorphism of proper U-graphs in FPT-time. *CoRR*, abs/2206.13372, 2022.
- [6] Yixin Cao, Jan Derbisz, and Tomasz Krawczyk. Characterization of chordal circular-arc graphs: I. split graphs. <https://arxiv.org/abs/2403.01947>, 2024.
- [7] Steven Chaplick, Martin Töpfer, Jan Voborník, and Peter Zeman. On H-topological intersection graphs. *Algorithmica*, 83(11):3281–3318, 2021.
- [8] Ben Dushnik and E.W. Miller. Partially ordered sets. *Amer. J. Math.*, 63:600–610, 1941.
- [9] T. Feder, P. Hell, and J. Huang. List homomorphisms and circular arc graphs. *Combinatorica*, 19(4):487–505, 1999.
- [10] M. Francis, P. Hell, and J. Stacho. Forbidden structure characterization of circular-arc graphs and a certifying recognition algorithm. In *Proceedings of the Twenty-Sixth Annual ACM-SIAM Symposium on Discrete Algorithms*, pages 1708–1727. SIAM, Philadelphia, PA, 2015.
- [11] T. Gallai. Transitiv orientierbare Graphen. *Acta Math. Acad. Sci. Hung.*, 18(1–2):25–66, 1967.
- [12] M. R. Garey, David S. Johnson, Gerald L. Miller, and Christos H. Papadimitriou. The complexity of coloring circular arcs and chords. *SIAM J. Algebraic Discret. Methods*, 1(2):216–227, 1980.
- [13] Fănică Gavril. Intersection graphs of helly families of subtrees. *Discrete Applied Mathematics*, 66(1):45–56, 1996.
- [14] Wen-Lian Hsu. $O(M \cdot N)$ algorithms for the recognition and isomorphism problems on circular-arc graphs. *SIAM J. Comput.*, 24(3):411–439, 1995.
- [15] Haim Kaplan and Yahav Nussbaum. A simpler linear-time recognition of circular-arc graphs. *Algorithmica*, 61(3):694–737, 2011.
- [16] V. Klee. Research Problems: What Are the Intersection Graphs of Arcs in a Circle? *Amer. Math. Monthly*, 76(7):810–813, 1969.
- [17] Tomasz Krawczyk. Testing isomorphism of circular-arc graphs in linear time – Hsu’s approach revisited. https://www.researchgate.net/publication/340504417_TESTING_ISOMORPHISM_OF_CIRCULAR-ARC_GRAPHES_IN_LINEAR_TIME_-HSU'S_APPROACH_REVISITED, 2020.
- [18] C. Lekkerkerker and J. Boland. Representation of a finite graph by a set of intervals on the real line. *Fund. Math.*, 51:45–64, 1962/1963.
- [19] Min Chih Lin and Jayme L. Szwarcfiter. Characterizations and linear time recognition of Helly circular-arc graphs. In *Computing and combinatorics*, volume 4112 of *Lecture Notes in Comput. Sci.*, pages 73–82. Springer, Berlin, 2006.
- [20] Ross M. McConnell. Linear-time recognition of circular-arc graphs. *Algorithmica*, 37(2):93–147, 2003.

- [21] J. Opatrny. Total ordering problem. *SIAM Journal on Computing*, 8(1):111–114, 1979.
- [22] Donald J. Rose, Robert Endre Tarjan, and George S. Lueker. Algorithmic aspects of vertex elimination on graphs. *SIAM J. Comput.*, 5(2):266–283, 1976.
- [23] W.T. Trotter and J. Moore. Characterization problems for graphs, partially ordered sets, lattices, and families of sets. *Discrete Math.*, 16(4):361–381, 1976.
- [24] Alan Tucker. An efficient test for circular-arc graphs. *SIAM J. Comput.*, 9(1):1–24, 1980.

¹THEORETICAL COMPUTER SCIENCE DEPARTMENT, FACULTY OF MATHEMATICS AND COMPUTER SCIENCE, JAGIELLONIAN UNIVERSITY IN KRAKÓW, POLAND

DOCTORAL SCHOOL OF EXACT AND NATURAL SCIENCES, JAGIELLONIAN UNIVERSITY, POLAND
Email address: jan.derbisz@doctoral.uj.edu.pl

²FACULTY OF MATHEMATICS AND INFORMATION SCIENCE, WARSAW UNIVERSITY OF TECHNOLOGY, POLAND

Email address: tomasz.krawczyk@pw.edu.pl