

BACKWARD-FORWARD CHARACTERIZATION OF ATTAINABLE SET FOR CONSERVATION LAWS WITH SPATIALLY DISCONTINUOUS FLUX

FABIO ANCONA AND LUCA TALAMINI

ABSTRACT. Consider a scalar conservation law with a spatially discontinuous flux at a single point $x = 0$, and assume that the flux is uniformly convex when $x \neq 0$. Given an interface connection (A, B) , we define a backward solution operator consistent with the concept of AB -entropy solution [4, 13, 16]. We then analyze the family $\mathcal{A}^{[AB]}(T)$ of profiles that can be attained at time $T > 0$ by AB -entropy solutions with L^∞ -initial data. We provide a characterization of $\mathcal{A}^{[AB]}(T)$ as fixed points of the backward-forward solution operator. As an intermediate step we establish a full characterization of $\mathcal{A}^{[AB]}(T)$ in terms of unilateral constraints and Oleinik-type estimates, valid for all connections. Building on such a characterization we derive uniform BV bounds on the flux of AB -entropy solutions, which in turn yield the \mathbf{L}_{loc}^1 -Lipschitz continuity in time of these solutions.

CONTENTS

| | |
|---|----|
| 1. Introduction | 2 |
| 2. Basic definitions and general setting | 4 |
| 2.1. Connections and AB -entropy solutions | 4 |
| 2.2. Backward solution operator | 8 |
| 3. Technical tools for characterization of the near-interface wave structure | 11 |
| 3.1. Left backward shock (Figure 4, left) | 12 |
| 3.2. Right backward shock (Figure 5, right) | 13 |
| 3.3. Duality of forward and backward shocks | 14 |
| 3.4. Right forward shock-rarefaction wave pattern (Figure 4, right) | 17 |
| 3.5. Left forward rarefaction-shock wave pattern (Figure 5, left) | 18 |
| 4. Statement of the main results | 20 |
| 5. Proof of Theorem 4.11 | 28 |
| 5.1. Proof roadmap | 28 |
| 5.2. Part 1.a - (1) \Rightarrow (3) for non critical connections assuming (H) | 30 |
| 5.3. Part 1.b - (1) \Rightarrow (3) for non critical connections without assuming (H) | 41 |
| 5.4. Part 2.a - (3) \Rightarrow (1) for non critical connections. | 43 |
| 5.5. Part 2.b - (3) \Rightarrow (2) for non critical connections. | 49 |
| 5.6. Part 3.a - (1) \Leftrightarrow (2) for critical connections | 51 |
| 5.7. Part 3.b - (1) \Rightarrow (3) for critical connections | 52 |
| 5.8. Part 3.c - (3) \Rightarrow (1) for critical connections | 56 |
| Appendix A. Stability of solutions with respect to connections and BV bounds | 60 |
| Appendix B. Preclusion of rarefactions emanating from the interface | 65 |
| Appendix C. Semicontinuous properties of solutions to convex conservation laws | 67 |
| References | 68 |

1. INTRODUCTION

Consider the initial value problem for the scalar conservation law in one space dimension

$$u_t + f(x, u)_x = 0, \quad x \in \mathbb{R}, \quad t \geq 0, \quad (1.1)$$

$$u(x, 0) = u_0(x), \quad x \in \mathbb{R}, \quad (1.2)$$

where $u = u(x, t)$ is the state variable and the flux f is a space discontinuous function given by

$$f(x, u) = \begin{cases} f_l(u), & x < 0, \\ f_r(u), & x > 0. \end{cases} \quad (1.3)$$

We assume that $f_l, f_r : \mathbb{R} \rightarrow \mathbb{R}$ are twice continuously differentiable, uniformly convex maps that satisfy

$$f_l''(u), f_r''(u) \geq a > 0, \quad (1.4)$$

and (up to a reparametrization)

$$f_l(0) = f_r(0), \quad f_l(1) = f_r(1). \quad (1.5)$$

We assume also that the unique critical points θ_l, θ_r of f_l, f_r , respectively, satisfy

$$\theta_l \geq 0, \quad \theta_r \leq 1. \quad (1.6)$$

Conservation laws with discontinuous flux serve as mathematical models for: oil reservoir simulation [26, 27]; traffic flow dynamics with roads of varying amplitudes or surface conditions [33]; radar shape-from-shading problems [34]; blood flow in endovascular treatments [24, 17]; and for many other different applications (see [6] and references therein).

We recall that problems of this type do not possess classical solutions globally defined in time (even in the continuous flux case when $f_l = f_r$), since, regardless of how smooth the initial data are, they can develop discontinuities (shocks) in finite time because of the nonlinearity of the equation. To achieve existence results, one has to look for weak distributional solution that, for sake of uniqueness, satisfy the classical Kruřkov entropy inequalities away from the point of flux discontinuity, and a further interface entropy condition at the flux-discontinuity interface $x = 0$.

Various type of interface-entropy conditions have been introduced in the literature according with the different physical phenomena modelled by (1.1) (see [11, 12]). Here, as in [6], for modelization and control treatment reasons we employ an admissibility criterion involving the so-called *interface connection* (A, B) , which yields the Definition 2.2 of *AB-entropy solution* (cfr.[4, 16]). A connection (A, B) is a pair of states connected by a stationary weak solution of (1.1), taking values A for $x < 0$, and B for $x > 0$, which has characteristics diverging from (or parallel to) the flux-discontinuity interface $x = 0$ (see Definition 2.1). The admissibility criterion for an *AB-entropy solution* can be equivalently formulated in terms of an interface entropy condition or of Kruřkov-type entropy inequalities adapted to the particular connection (A, B) taken into account (cfr. [4, 13, 16]). Relying on this extended entropy inequalities and using an adapted version of the Kruřkov doubling of variables argument, one can establish \mathbf{L}^1 -stability and uniqueness of *AB-entropy solutions* to the Cauchy problem (1.1)-(1.2) (see [16, 25]). We shall adopt the semigroup notation $u(x, t) \doteq \mathcal{S}_t^{[AB]^+} u_0(x)$ for the unique solution of (1.1)-(1.2).

In this paper we are concerned as in [2, 6] with a controllability problem for (1.1) where one regards the initial data as controls and study the corresponding *attainable set* at a fixed time $T > 0$:

$$\mathcal{A}^{[AB]}(T) \doteq \{ \mathcal{S}_T^{[AB]^+} u_0 : u_0 \in \mathbf{L}^\infty(\mathbb{R}) \}. \quad (1.7)$$

In the same spirit of [22, 23, 28, 32] we introduce a *backward solution operator* (see Definition 2.13)

$$\mathcal{S}_T^{[AB]^-} : \mathbf{L}^\infty(\mathbb{R}) \rightarrow \mathbf{L}^\infty(\mathbb{R}), \quad \omega \mapsto \mathcal{S}_T^{[AB]^-} \omega, \quad (1.8)$$

and we characterize the attainable targets for (1.1) at a time horizon $T > 0$ as fixed-points of the composition *backward-forward operator* $\mathcal{S}_T^{[AB]^+} \circ \mathcal{S}_T^{[AB]^-}$, as stated in our first main result:

Theorem 1.1. *Let f be a flux as in (1.3) satisfying the assumptions (1.4)-(1.6), and let (A, B) be a connection. Then, for every $T > 0$, and for any $\omega \in \mathbf{L}^\infty(\mathbb{R})$, the following conditions are equivalent.*

- (1) $\omega \in \mathcal{A}^{[AB]}(T)$,
- (2) $\omega = \mathcal{S}_T^{[AB]^+} \circ \mathcal{S}_T^{[AB]^-} \omega$.

Moreover, if (A, B) is a non critical connection, i.e. if $A \neq \theta_l, B \neq \theta_r$, then the condition (2) is equivalent to

- (1)' $\omega \in \mathcal{A}_{bv}^{[AB]}(T)$, where

$$\mathcal{A}_{bv}^{[AB]}(T) \doteq \{ \mathcal{S}_T^{[AB]^+} u_0 : u_0 \in BV_{loc}(\mathbb{R}) \}, \quad (1.9)$$

and there holds

$$\mathcal{A}^{[AB]}(T) = \mathcal{A}_{bv}^{[AB]}(T). \quad (1.10)$$

Clearly the main content of Theorem 1.1 are the implication (1) \implies (2) and (1)' \implies (2), since the reverse implications are straightforward once we define the backward operator $\mathcal{S}_T^{[AB]^-}$ and verify that, in the case of a non critical connection, one has $\mathcal{S}_T^{[AB]^-} u_0 \in BV_{loc}(\mathbb{R})$ for all $u_0 \in \mathbf{L}^\infty(\mathbb{R})$. The proof of (1) \implies (2) and (1)' \implies (2) are obtained in two steps:

- (I) First, we show that any attainable profile $\omega \in \mathcal{A}^{[AB]}(T)$ belongs to a class of functions $\mathcal{A} \subset BV_{loc}(\mathbb{R} \setminus \{0\})$ which satisfy suitable Oleinik-type inequalities and pointwise constraints related to the (A, B) -connection in intervals containing the origin (see Theorem 4.2, 4.7, 4.9).
- (II) Next, we prove that any element of \mathcal{A} is a fixed point of the composition backward-forward operator $\mathcal{S}_T^{[AB]^+} \circ \mathcal{S}_T^{[AB]^-}$. Namely, for any given $\omega \in \mathcal{A}$ we construct an initial datum $u_0 \in \mathbf{L}^\infty(\mathbb{R})$ such that $\omega = \mathcal{S}_T^{[AB]^+} u_0$, and then we show that indeed $u_0 = \mathcal{S}_T^{[AB]^-} \omega$.

These two steps are firstly carried out in the case of a non critical connection (A, B) and of attainable profiles $\omega \in \mathcal{A}^{[AB]}(T) \cap BV_{loc}(\mathbb{R})$. The proofs are obtained exploiting as in [6] the theory of generalized characteristics by Dafermos [20], applied to the setting of discontinuous flux, and relying on the duality property of the backward and forward solution operators. Next, we address the case of a critical connection and of attainable profiles $\omega \in \mathcal{A}^{[AB]}(T)$ relying on the \mathbf{L}^1 -stability of the map $(A, B, u_0) \mapsto \mathcal{S}_t^{[AB]^+} u_0$ (see Theorem 2.7).

Some remarks are here in order.

- The results of Theorem 1.1 extend to the present setting of space discontinuous fluxes the similar *characterization of attainable profiles in terms of the backward solution operator* obtained in [19, Theorem 3.1, Corollary 3.2] and [28, Corollary 1] for conservation laws with strictly convex flux independent on the space variable.
- The characterization of $\mathcal{A}^{[AB]}(T)$ obtained in this paper unveils the presence of a *class of attainable states for not critical connections* that were *not detected* in [2, 6], see Remark 4.12.
- The characterization of attainable profiles for (1.1), (1.3) in terms of unilateral constraints and Oleinik-type estimates provides a powerful tool to investigate regularity properties of the solutions to (1.1), (1.3). In particular, we build on such a characterization to derive *uniform BV bounds* on *AB-entropy solutions* with initial datum in \mathbf{L}^∞ (in the case of non critical connections), and *on the flux of AB-entropy solutions* (for general connections). This is a fairly non-trivial result since it is well known [1] that the total variation of *AB-entropy solutions* may well blow

up in a neighborhood of the flux-discontinuity interface $x = 0$. Thanks to these uniform BV bounds, we can then establish the $\mathbf{L}_{\text{loc}}^1$ -Lipschitz continuity in time of AB -entropy solutions.

- The proof that Theorem 1.1 holds for critical connections once we know that Theorem 1.1 is verified by non critical connections relies on a perturbation argument for attainable profiles. This construction yields an *approximate controllability* result since it provides a general explicit procedure to approximate an attainable profile for a critical connection by attainable profiles for non critical connections.

Note furthermore that, by the non-backward uniqueness of (1.1) (due to the possible presence of shocks in its solutions), there may exist in general multiple initial data u_0 that are stirred by (1.1) to $\omega \in \mathcal{A}^{[AB]}(T)$. In fact, an important control problem related to the one considered in this paper is the inverse design, which has the goal to reconstruct the set of initial data u_0 evolving to a given attainable target ω (see [19, 28, 32] for conservation laws with convex flux independent on the space variable, and [23] for Hamilton-Jacobi equations with convex Hamiltonian). On the other hand, when a target state ω is not attainable at time $T > 0$, the image of ω through the backward-forward operator $\mathcal{S}_T^{[AB]^+} \circ \mathcal{S}_T^{[AB]^-}$ represents a natural candidate to construct a reachable function which is “as close as possible” (in an appropriate sense) to the the observed state ω (see [22] in the case of Hamilton-Jacobi and Burgers equations).

The results of the present paper provide a key building block to address both of these problems, namely the characterization of the aforementioned set of initial data leading to a given attainable target ω for (1.1), and the analysis of the properties of the backward-forward operator $\mathcal{S}_T^{[AB]^+} \circ \mathcal{S}_T^{[AB]^-}$ related to optimization problems for unattainable target profiles, which are pursued in the forthcoming paper [10].

The paper is organized as follows. In § 2 we recall the definitions of interface connection (A, B) , of AB -entropy solution and of AB -backward solution operator. We also collect the stability properties of the \mathbf{L}^1 -contractive semigroup of AB -entropy solutions. In § 3 we establish the duality property of the backward and forward solution operators, which constitutes a fundamental ingredient of the proof of Theorem 1.1. § 4 collects the precise statements of the results on the characterization of the attainable set $\mathcal{A}^{[AB]}(T)$ via Oleinik-type inequalities and state constraints. In § 5 we carry out the rather technical and involved proof of Theorem 1.1. At the beginning of the section, for reader’s convenience, we provide a roadmap of the proof of Theorem 1.1, where we also highlight the key innovative parts of the paper. In Appendix A we establish the \mathbf{L}^1 -stability properties of the semigroup of AB -entropy solutions with respect to time and with respect to the connections. We also derive uniform BV bounds on AB -entropy solutions in the case of non critical connections, and on the flux of AB -entropy solutions for general connections. In Appendix B we provide, for sake of completeness, a simple proof of the non existence of rarefactions emanating from the interface $x = 0$, which is a distinctive feature of AB -entropy solutions. Finally, in Appendix C we derive some lower/upper \mathbf{L}^1 -semicontinuity property for solutions to conservation laws, used to recover the proof of Theorem 1.1 in the case of critical connections once we know the validity of Theorem 1.1 for non critical connections.

2. BASIC DEFINITIONS AND GENERAL SETTING

2.1. Connections and AB -entropy solutions. We recall here the definitions and properties of interface connection and of entropy admissible solution introduced in [4].

Definition 2.1 (Interface Connection). Let f be a flux as in (1.3) satisfying the assumptions (1.4)-(1.6). A pair of values $(A, B) \in \mathbb{R}^2$ is called a *connection* if

- (1) $f_l(A) = f_r(B)$,
- (2) $A \leq \theta_l$ and $B \geq \theta_r$.

We will say that connection (A, B) is *critical* if $A = \theta_l$ or $B = \theta_r$.

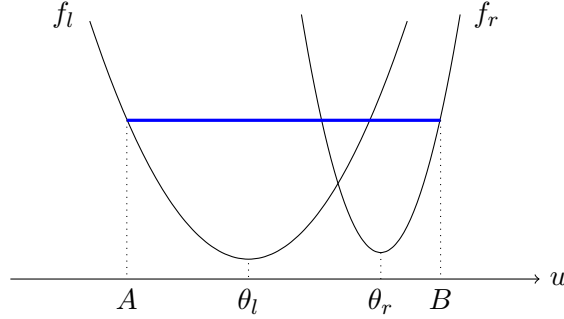
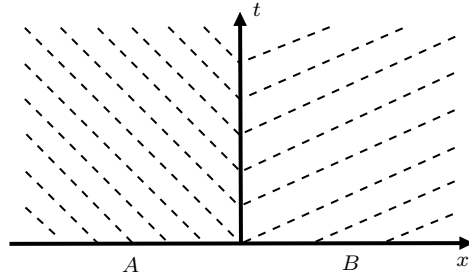
 FIGURE 1. An example of connection (A, B) with f_l, f_r strictly convex fluxes

 FIGURE 2. The stationary undercompressive solution c^{AB} .

Observe that condition (2) is equivalent to: $f'_l(A) \leq 0$, $f'_r(B) \geq 0$. Therefore, if (A, B) is a connection, then the function

$$c^{AB}(x) \doteq \begin{cases} A, & x \leq 0, \\ B, & x \geq 0 \end{cases} \quad (2.1)$$

is a weak stationary undercompressive (or marginally undercompressive) solution of (1.1), since the characteristics diverge from, or are parallel to, the flux-discontinuity interface (see Figure 2). In relation to the function c^{AB} it is introduced in [16] the *adapted entropy* $\eta_{AB}(x, u) = |u - c^{AB}(x)|$. Then, in the spirit of [14], it is employed in [16] the entropy η_{AB} to select a unique solution of the Cauchy problem (1.1)-(1.2) that satisfies the interface entropy inequality

$$|u - c^{AB}|_t + [\text{sgn}(u - c^{AB})(f(x, u) - f(x, c^{AB}))]_x \leq 0, \quad \text{in } \mathcal{D}', \quad (2.2)$$

in the sense of distributions, which leads to the following definition.

Definition 2.2 (*AB-entropy solution*). Let (A, B) be a connection and let c^{AB} be the function defined in (2.1). A function $u \in \mathbf{L}^\infty(\mathbb{R} \times]0, +\infty[)$ is said to be an *AB-entropy solution* of the problem (1.1),(1.2) if the following holds:

- (1) u is a distributional solution of (1.1) on $\mathbb{R} \times]0, +\infty[$, that is, for all test functions $\phi \in \mathcal{C}_c^1$ with compact support contained in $\mathbb{R} \times]0, +\infty[$, there holds

$$\int_{-\infty}^{\infty} \int_0^{\infty} \{u\phi_t + f(x, u)\phi_x\} dx dt = 0. \quad (2.3)$$

- (2) u is a Kruřkov entropy weak solution of (1.1),(1.2) on $(\mathbb{R} \setminus \{0\}) \times]0, +\infty[$, that is, $t \mapsto u(\cdot, t)$ is a continuous map from $]0, +\infty[$ to $\mathbf{L}_{\text{loc}}^1(\mathbb{R})$, the initial condition (1.2) is satisfied almost everywhere, and:

(2.a) for any non-negative test function $\phi \in \mathcal{C}_c^1$ with compact support contained in $] - \infty, 0[\times]0, +\infty[$, there holds

$$\int_0^\infty \int_{-\infty}^0 \{ |u - k| \phi_t + \operatorname{sgn}(u - k) (f_l(u) - f_l(k)) \phi_x \} dx dt \geq 0, \quad \forall k \in \mathbb{R}; \quad (2.4)$$

(2.b) for any non-negative test function $\phi \in \mathcal{C}_c^1$ with compact support contained in $]0, +\infty[\times]0, +\infty[$, there holds

$$\int_0^\infty \int_0^\infty \{ |u - k| \phi_t + \operatorname{sgn}(u - k) (f_r(u) - f_r(k)) \phi_x \} dx dt \geq 0, \quad \forall k \in \mathbb{R}. \quad (2.5)$$

(3) u satisfies a Kruřkov-type entropy inequality relative to the connection (A, B) , that is, for any non-negative test function $\phi \in \mathcal{C}_c^1$ with compact support contained in $\mathbb{R} \times]0, +\infty[$, there holds

$$\int_{-\infty}^\infty \int_0^\infty \{ |u - c^{AB}| \phi_t + \operatorname{sgn}(u - c^{AB}) (f(x, u) - f(x, c^{AB})) \phi_x \} dx dt \geq 0. \quad (2.6)$$

Remark 2.3. Since an AB -entropy solution u is in particular an entropy weak solution of a scalar conservation law with uniformly convex flux, on $] - \infty, 0[\times]0, +\infty[$, and on $]0, +\infty[\times]0, +\infty[$ (by property (2) of Definition 2.2 and assumption (1.4)), it follows that $u(\cdot, t) \in BV_{\text{loc}}(\mathbb{R} \setminus \{0\})$ for any $t > 0$. Here $BV_{\text{loc}}(\mathbb{R} \setminus \{0\})$ denotes the set of functions that have finite total variation on bounded subsets of \mathbb{R} bounded away from the origin. On the other hand, relying on a result in [35] (see also [36]), and because of the $\mathbf{L}_{\text{loc}}^1$ -continuity of the map $t \mapsto u(\cdot, t)$, we deduce that u admits left and right strong traces at $x = 0$ for all $t > 0$, i.e. that there exist the one-sided limits

$$u_l(t) \doteq u(0-, t), \quad u_r(t) \doteq u(0+, t), \quad \forall t > 0. \quad (2.7)$$

Moreover, since u is also a distributional solution of (1.1) on $\mathbb{R} \times]0, +\infty[$ (by property (1) of Definition 2.2), we deduce that u must satisfy the Rankine-Hugoniot condition at the interface $x = 0$:

$$f_l(u_l(t)) = f_r(u_r(t)), \quad \text{for a.e. } t > 0. \quad (2.8)$$

In (2.7) and throughout the paper, for the one-sided limits of a function $u(x)$ we use the notation

$$u(x \pm) \doteq \lim_{y \rightarrow x \pm} u(y). \quad (2.9)$$

Remark 2.4. In view of (2.8), we can extend the classical concept of genuine characteristic for solutions to conservation laws with continuous fluxes (see [20]) by considering also characteristics that are refracted by the discontinuity interface $x = 0$. Thus, we will say that a polygonal line $\vartheta : [0, T] \rightarrow \mathbb{R}$ is a *genuine characteristic for an AB -entropy solution u* if one of the following cases occurs:

- (i) $\vartheta(t) < 0$ for all $t \in]0, T[$, and ϑ is a characteristic for the restriction of u on $] - \infty, 0[\times]0, T[$;
- (ii) $\vartheta(t) > 0$ for all $t \in]0, T[$, and ϑ is a characteristic for the restriction of u on $]0, +\infty[\times]0, T[$;
- (iii) there exists $\tau \in]0, T[$, such that:
 - $\vartheta(t) < 0$ for all $t \in]0, \tau[$, and ϑ is a characteristic for the restriction of u on $] - \infty, 0[\times]0, \tau[$,
 - $\vartheta(t) > 0$ for all $t \in]\tau, T[$, and ϑ is a characteristic for the restriction of u on $]0, +\infty[\times]\tau, T[$,
 - or viceversa.
 - $f_l(u_l(\tau)) = f_r(u_r(\tau))$,

where we are using the term ‘‘characteristic’’ for a classical genuine characteristic of a solution to the conservation law $u_t + f_l(u)_x = 0$ on $\{x < 0\}$, or to the conservation law $u_t + f_r(u)_x = 0$ on $\{x > 0\}$.

In relation to a connection (A, B) consider the function

$$I^{AB}(u_l, u_r) \doteq \operatorname{sgn}(u_r - B) (f_r(u_r) - f_r(B)) - \operatorname{sgn}(u_l - A) (f_l(u_l) - f_l(A)), \quad u_l, u_r \in \mathbb{R}, \quad (2.10)$$

which is useful to characterize the interface entropy admissibility criterium. In fact, by the analysis in [16, Lemma 3.2] and [13, Section 4.8], it follows that, because of condition (1) of Definition 2.2 and assumption (1.4), the following holds.

Lemma 2.5. *Let $u \in \mathbf{L}^\infty(\mathbb{R} \times [0, +\infty))$ be a function satisfying conditions (1)-(2) of Definition 2.2. Then, condition (3) is equivalent to the AB interface entropy condition*

$$(3)' \quad I^{AB}(u_l(t), u_r(t)) \leq 0 \quad \text{for a.e. } t > 0. \quad (2.11)$$

Lemma 2.6. *Let (A, B) be a connection. Then, for any pair $(u_l, u_r) \in \mathbb{R}^2$, the conditions*

$$f_l(u_l) = f_r(u_r), \quad I^{AB}(u_l, u_r) \leq 0, \quad (2.12)$$

are equivalent to the conditions

$$\begin{aligned} f_l(u_l) = f_r(u_r) &\geq f_l(A) = f_r(B), \\ (u_l \leq \theta_l, \quad u_r \geq \theta_r) &\implies u_l = A, \quad u_r = B. \end{aligned} \quad (2.13)$$

The first condition in (2.13) tells us that, when we choose a connection (A, B) and we employ the concept of AB -entropy solution, we are imposing a constraint (from below) on the flux at the interface $x = 0$. In order to achieve existence, we need to compensate for this constraint with an additional freedom in the admissibility criteria. In fact, the second condition in (2.13) prescribes the admissibility of exactly one undercompressive wave at the interface, given by c^{AB} in (2.1). This rule corresponds to the (A, B) characteristic condition in [16, Definition 1.4].

It was proved in [4, 16] (see also [13, 25]) that AB -entropy solutions of (1.1),(1.2) with bounded initial data are unique and form an \mathbf{L}^1 -contractive semigroup. Moreover, we will show that they are \mathbf{L}^1 -stable also with respect to the values A, B of the connection. This type of stability, beside being used to extend our main results from the case of non-critical connections to the critical one, has an interest in its own. We will also prove that AB -entropy solutions of (1.1),(1.2) are \mathbf{L}^1 -Lipschitz continuous in time. This property is an immediate consequence of the BV regularity of such solutions in the case of non critical connections. Instead, in the case of critical connections where $A = \theta_l$ or $B = \theta_r$, and $f_l(\theta_l) \neq f_r(\theta_r)$, the total variation of an AB -entropy solution may well blow up in a neighborhood of the flux-discontinuity interface $x = 0$, as shown in [1]. However, we recover the \mathbf{L}^1 -Lipschitz continuity in time also in this case exploiting the BV regularity of the flux of an AB -entropy solution, which is established relying on the analysis pursued in this paper. We collect all these (old and new) results in the following:

Theorem 2.7. (Semigroup of AB -Entropy Solutions) *Let f be a flux as in (1.3) satisfying the assumptions (1.4)-(1.6), and let (A, B) be a connection. Then there exists a map*

$$\mathcal{S}^{[AB]^+} : [0, +\infty[\times \mathbf{L}^\infty(\mathbb{R}) \rightarrow \mathbf{L}^\infty(\mathbb{R}), \quad (t, u_0) \mapsto \mathcal{S}_t^{[AB]^+} u_0, \quad (2.14)$$

enjoying the following properties:

- (i) *For each $u_0 \in \mathbf{L}^\infty(\mathbb{R})$, the function $u(x, t) \doteq \mathcal{S}_t^{[AB]^+} u_0(x)$ provides the unique bounded, AB -entropy solution of the Cauchy problem (1.1), (1.2).*
- (ii) *$\mathcal{S}_0^{[AB]^+} u_0 = u_0$, $\mathcal{S}_s^{[AB]^+} \circ \mathcal{S}_t^{[AB]^+} u_0 = \mathcal{S}_{s+t}^{[AB]^+} u_0$, for all $t, s \geq 0$, $u_0 \in \mathbf{L}^\infty(\mathbb{R})$.*
- (iii) *$\|\mathcal{S}_t^{[AB]^+} u_0 - \mathcal{S}_t^{[AB]^+} v_0\|_{\mathbf{L}^1(\mathbb{R})} \leq \|u_0 - v_0\|_{\mathbf{L}^1(\mathbb{R})}$, for all $t \geq 0$, $u_0, v_0 \in \mathbf{L}^\infty(\mathbb{R})$.*
- (iv) *$\|\mathcal{S}_t^{[AB]^+} u_0 - \mathcal{S}_t^{[A'B']^+} v_0\|_{\mathbf{L}^1(\mathbb{R})} \leq 2t |f_r(B) - f_r(B')| + \|u_0 - v_0\|_{\mathbf{L}^1(\mathbb{R})}$, for all connections (A, B) , (A', B') , and for every $t \geq 0$, $u_0, v_0 \in \mathbf{L}^\infty(\mathbb{R})$.*

(v) For each $u_0 \in \mathbf{L}^\infty(\mathbb{R})$ and for any bounded set K , there exists a constant $C_K > 0$ depending only on the flux f , on the connection (A, B) , on $\|u_0\|_{\mathbf{L}^1}$, and on K , such that:

$$\|\mathcal{S}_t^{[AB]^+} u_0 - \mathcal{S}_s^{[AB]^+} u_0\|_{\mathbf{L}^1(K)} \leq \frac{C_K}{t} |s - t| \text{ for all } s > t > 0.$$

The proof of the new properties (iv)-(v) is given in Appendix A.

Remark 2.8. By the analysis in [25, §3.1] (see also [6, Remark 4.1]) it follows that, for every $M > 0$, there exists $C_M > 0$ such that, if $\|u_0\|_{\mathbf{L}^\infty} \leq M$, and $A, B \leq M$, then $\|\mathcal{S}_t^{[AB]^+} u_0\|_{\mathbf{L}^\infty} \leq C_M$, for all $t > 0$.

Corollary 2.9. Let $\{(A_n, B_n)\}_n$ be a sequence of connections that converge in \mathbb{R}^2 to a connection (A, B) , and let $\{u_{n,0}\}_n$ be a sequence of functions in $\mathbf{L}^\infty(\mathbb{R})$ that converge in \mathbf{L}^1 to $u_0 \in \mathbf{L}^\infty(\mathbb{R})$. Let $u_{n,l}, u_{n,r}$ denote, respectively, the left and right traces at $x = 0$ of $u_n(x, t) \doteq \mathcal{S}_t^{[A_n B_n]^+} u_{n,0}(x)$, defined as in (2.7). Similarly, let u_l, u_r denote the left and right traces at $x = 0$ of $u(x, t) \doteq \mathcal{S}_t^{[AB]^+} u_0(x)$. Then, there hold:

$$f_l(u_{n,l}) \rightarrow f_l(u_l), \quad f_r(u_{n,r}) \rightarrow f_r(u_r) \text{ in } \mathbf{L}^1([0, T]), \quad (2.15)$$

for all $T > 0$.

The proof of the Corollary is given in Appendix A.

Remark 2.10. We point out that, differently from (2.15), in general the \mathbf{L}^1 -convergence $u_{n,l} \rightarrow u_l$ and $u_{n,r} \rightarrow u_r$ fails due to the possible formation of stationary boundary layers at the interface $x = 0$, as one can see in the following

Example 2.11. Consider a noncritical connection (A, B) and the sequence of initial data

$$u_{n,0}(x) = \begin{cases} \bar{A}, & \text{if } x \leq -n^{-1}, \\ A, & \text{if } x \in]-n^{-1}, 0[, \\ \bar{B}, & \text{if } x \geq 0, \end{cases}$$

with

$$\bar{A} \doteq (f_l|_{[\theta_l, +\infty[})^{-1} \circ f_l(A), \quad \bar{B} \doteq (f_r|_{]-\infty, \theta_r]})^{-1} \circ f_r(B), \quad (2.16)$$

where $f|_I$ denotes the restriction of the function f to the interval I . One can immediately check that the AB -entropy solution of (1.1), (1.2), with initial datum $u_{n,0}$ is the stationary solution $u_n(t, x) = \mathcal{S}_t^{[AB]^+} u_{n,0}(x) = u_{n,0}(x)$ and that u_n converges in \mathbf{L}^1 to

$$u(x, t) = \begin{cases} \bar{A} & \text{if } x < 0, \\ \bar{B} & \text{if } x > 0. \end{cases}$$

Moreover, one has $u_{n,l}(t) = A$ and $u_l(t) = \bar{A}$ for every $t > 0$.

2.2. Backward solution operator. In this section we shall first review quickly the concept of backward solution operator for conservation laws with flux depending only on the state variable, and then we will introduce the definition of backward solution operator associated to a connection (A, B) , for spatially discontinuous flux as in (1.3).

2.2.1. *Backward solution operator for conservation laws with space independent flux.* The use of the backward-forward method to characterize the attainable set for conservation laws was first proposed in [28, 32] (see also [22] in the framework of Hamilton-Jacobi equations). Because of the regularizing effect of the nonlinear dynamics of a conservation law

$$u_t + f(u)_x = 0, \quad x \in \mathbb{R}, \quad (2.17)$$

with uniformly convex flux $f(u)$, the only restriction to controllability of (2.17) at a fixed time $T > 0$, when one regards as controls the initial data

$$u(x, 0) = u_0(x), \quad x \in \mathbb{R}, \quad (2.18)$$

is the decay of positive waves. Therefore it is by now well known the characterization of the attainable set

$$\mathcal{A}(T) = \{\omega : \omega = u(\cdot, T), u \text{ entropy weak solution of (2.17)-(2.18) with } u_0 \in \mathbf{L}^\infty\}, \quad (2.19)$$

in terms of the Oleĭnik-type inequality

$$D^+\omega(x) \leq \frac{1}{Tf''(\omega(x))}, \quad \forall x \in \mathbb{R}, \quad (2.20)$$

where $D^+\omega$ denotes the upper Dini derivative of ω (see (4.10)). Similar results in the case of boundary controllability were obtained in [3, 8, 9, 29].

A different perspective to address this controllability problem was introduced in [28, 32], and consists in constructing initial data leading to attainable targets ω at a time horizon $T > 0$, through the definition of an appropriate concept of backward solution to (2.17). Namely, letting $\mathcal{S}_t^+ u_0(x)$ denote the (forward) entropy weak solution of the Cauchy problem (2.17)-(2.18) evaluated at (x, t) , it was defined in [32] an appropriate *backward operator* $\mathcal{S}_T^- : \mathbf{L}^\infty \rightarrow \mathbf{L}^\infty$, and proved that a profile $\omega \in \mathcal{A}(T)$ if and only if $\omega = \mathcal{S}_T^+ \circ \mathcal{S}_T^- \omega$, i.e. if and only if it is a fixed point of the backward-forward operator $\mathcal{S}_T^+ \circ \mathcal{S}_T^-$ (see [28, Corollary 1]). Moreover, for $\omega \in \mathcal{A}(T)$, the solution defined as

$$u^*(x, t) \doteq \mathcal{S}_t^+(\mathcal{S}_T^-\omega)(x), \quad x \in \mathbb{R}, \quad t \in [0, T], \quad (2.21)$$

is the unique solution to (2.17) that is locally Lipschitz on $]0, T[$, and yields ω at time T . Equivalently,

$$u_0^* \doteq \mathcal{S}_T^- \omega \quad (2.22)$$

is the unique initial datum that produces a solution to (2.17) locally Lipschitz on $]0, T[$, yielding ω at time T . The operator \mathcal{S}_t^- , for $t \geq 0$, is defined as follows

$$\mathcal{S}_t^-\omega(x) \doteq \mathcal{S}_t^+(\omega(-\cdot))(-x) \quad x \in \mathbb{R}, \quad t \geq 0. \quad (2.23)$$

In words, we use $\omega(-\cdot)$ as initial datum for the forward operator \mathcal{S}_t^+ , we compute the (forward) solution to (2.17), and then we reverse the space variable.

Remark 2.12. One can easily verify that the function $w(x, t) \doteq \mathcal{S}_t^-\omega(x)$ is the entropy weak solution of the Cauchy problem

$$\begin{cases} w_t - f(w)_x = 0, & x \in \mathbb{R}, \quad t \geq 0, \\ w(x, 0) = \omega(x), & x \in \mathbb{R}. \end{cases} \quad (2.24)$$

In fact, by definition (2.23) it follows that $w(x, t)$ is a distributional solution of (2.24), since it is obtained from the distributional solution $\mathcal{S}_t^+(\omega(-\cdot))(x)$ of (2.17) by the change of variable $x \mapsto -x$. On the other hand, since every shock discontinuity of $\mathcal{S}_t^+(\omega(-\cdot))(x)$, connecting a left state u^- with a right state u^+ , must satisfy the Lax condition $u^- > u^+$ (equivalent to the entropy admissibility criterium since the flux $f(u)$ in (2.17) is convex, e.g. see [21, 30]), it follows that the left and right states u^-, u^+ of every shock discontinuity in $w(x, t)$ must satisfy the reverse condition $u^- < u^+$, which is the Lax admissibility condition for (2.24), since the flux $-f(w)$ is

concave. Finally, we can observe that $w(x, 0) = \mathcal{S}_0^+(\omega(-\cdot))(-x) = \omega(x)$, for all $x \in \mathbb{R}$, which completes the proof of our claim.

This procedure to characterize the attainable profiles is motivated by the following observation. Given a target profile ω , if we know that for any $t \in]0, T[$, the map $x \mapsto v(x, t) \doteq \mathcal{S}_t^+(\omega(-\cdot))(x)$ is locally Lipschitz on \mathbb{R} , it would follow that $u(x, t) \doteq v(-x, T-t) = \mathcal{S}_{T-t}^-\omega(x)$ is a classical solution of (2.17) which attains the target profile ω at time $t = T$, and starts with the initial datum u_0^* in (2.22). Since classical solutions of (2.17) are entropy admissible, by uniqueness of entropy weak solutions of the Cauchy problem for (2.17) it would follow that $u(x, t) = \mathcal{S}_t^+u_0^*(x) = u^*(x, t)$. However, if v admits shock discontinuities, the function $v(-x, T-t)$ fails to be an entropy admissible solution of (2.17), despite still being a weak distributional solution of (2.17). The one-sided Lipschitz condition (2.20) is precisely equivalent to the property that the map $x \mapsto v(x, t) \doteq \mathcal{S}_t^+(\omega(-\cdot))(x)$ is locally Lipschitz on \mathbb{R} , for all $t \in]0, T[$ (e.g. see [7, 8]), and thus one obtains the characterization of the elements of $\mathcal{A}(T)$ as fixed points of the backward-forward operator.

2.2.2. Backward solution operator in the spatially-discontinuous flux setting. Given a flux f as in (1.3) satisfying the assumptions (1.4)-(1.6), and a connection (A, B) , let $\mathcal{S}^{[AB]^+}$ be the *forward semigroup operator* associated to the connection (A, B) , as in Theorem 2.7. Observe that, letting $\overline{A}, \overline{B}$ be as in (2.16), the pair $(\overline{B}, \overline{A})$ turns out to be a connection for the symmetric flux

$$\overline{f}(x, u) = \begin{cases} f_r(u), & x \leq 0, \\ f_l(u), & x \geq 0, \end{cases} \quad (2.25)$$

(see Figure 3).

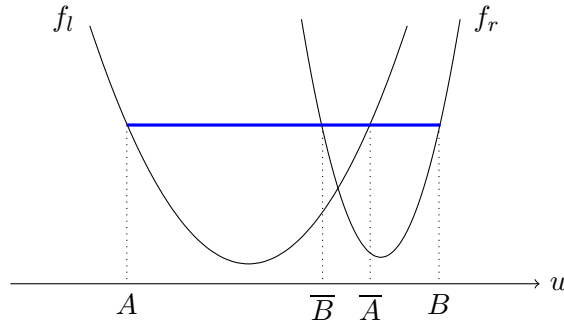

FIGURE 3. The connection $(\overline{B}, \overline{A})$ of the symmetric flux $\overline{f}(x, u)$ defined in (2.25).

Then, letting $\overline{\mathcal{S}}_t^{[\overline{B}\overline{A}]^+}u_0(x)$ denote the unique $\overline{B}\overline{A}$ -entropy solution of

$$\begin{cases} u_t + \overline{f}(x, u)_x = 0 & x \in \mathbb{R}, \quad t \geq 0, \\ u(x, 0) = u_0(x) & x \in \mathbb{R}, \end{cases} \quad (2.26)$$

evaluated at (x, t) , we shall define the backward solution operator associated to the connection (A, B) in terms of the operator $\overline{\mathcal{S}}_t^{[\overline{B}\overline{A}]^+}$ as follows.

Definition 2.13 (AB-Backward solution operator). Given a connection (A, B) , the *backward solution operator* associated to (A, B) is the map $\mathcal{S}_{(\cdot)}^{[AB]^-} : [0, +\infty) \times \mathbf{L}^\infty(\mathbb{R}) \rightarrow \mathbf{L}^\infty(\mathbb{R})$, defined by

$$\mathcal{S}_t^{[AB]^-}\omega(x) \doteq \overline{\mathcal{S}}_t^{[\overline{B}\overline{A}]^+}(\omega(-\cdot))(-x) \quad x \in \mathbb{R}, \quad t \geq 0. \quad (2.27)$$

Remark 2.14. One can show that the function $w(x, t) \doteq \mathcal{S}_t^{[AB]-} \omega(x)$ is the $\overline{A\overline{B}}$ -entropy solution of the Cauchy problem

$$\begin{cases} w_t - f(x, w)_x = 0, & x \in \mathbb{R}, \quad t \geq 0, \\ w(x, 0) = \omega(x), & x \in \mathbb{R}. \end{cases} \quad (2.28)$$

Notice that in (2.28) the flux is $-f(x, w)$, which is a discontinuous function that coincides with the uniformly strictly concave maps $-f_l(w)$, $-f_r(w)$, on the left and on the right, respectively, of $x = 0$. As observed in [6, §7], in the case of a two-concave flux as $-f(x, w)$, one replaces the \leq sign with the \geq sign, and viceversa, in the Definition 2.1 of interface connection. Thus, $(\overline{A}, \overline{B})$ is indeed a connection for the flux $-f(x, w)$. The $\overline{A\overline{B}}$ interface entropy admissibility condition for $w(x, t)$ is formulated as in (2.11). In order to verify the claim that $w(x, t)$ is the $\overline{A\overline{B}}$ -entropy solution of the Cauchy problem (2.28) we proceed as in Remark 2.12. We first observe that $w(x, t)$ is a distributional solution of (2.28), and that it is entropy admissible in the regions $\{x < 0\}$, $\{x > 0\}$.

In fact, by definition (2.27), $w(x, t)$ is obtained from $\overline{\mathcal{S}}_t^{[\overline{B\overline{A}}]+}(\omega(-\cdot))(x)$ with the change of variable $x \mapsto -x$, and there holds $w(x, 0) = \overline{\mathcal{S}}_0^{[\overline{B\overline{A}}]+}(\omega(-\cdot))(-x) = \omega(x)$, for all $x \in \mathbb{R}$. Next, we check that $w(x, t)$ satisfies the $\overline{A\overline{B}}$ entropy condition (2.11) for the two-concave flux $-f(x, w)$, i.e. that, letting $w_l(t), w_r(t)$ denote the left and right traces of $w(x, t)$ at $x = 0$, there holds

$$\operatorname{sgn}(w_r(t) - \overline{B}) (-f_r(w_r(t)) + f_r(\overline{B})) - \operatorname{sgn}(w_l(t) - \overline{A}) (-f_l(w_l(t)) + f_l(\overline{A})) \leq 0 \quad \text{for a.e. } t > 0. \quad (2.29)$$

Observe that the left and right traces $u_l(t), u_r(t)$ of $\overline{\mathcal{S}}_t^{[\overline{B\overline{A}}]+}(\omega(-\cdot))(x)$ at $x = 0$, satisfy the $\overline{B\overline{A}}$ entropy condition (2.11) for the flux \overline{f} in (2.25), that reads

$$\operatorname{sgn}(u_r(t) - \overline{A}) (f_l(u_r(t)) - f_l(\overline{A})) - \operatorname{sgn}(u_l(t) - \overline{B}) (f_r(u_l(t)) - f_r(\overline{B})) \leq 0 \quad \text{for a.e. } t > 0. \quad (2.30)$$

On the other hand, since one obtains $w(x, t)$ from $\overline{\mathcal{S}}_t^{[\overline{B\overline{A}}]+}(\omega(-\cdot))(x)$ reversing the space variables, we have $u_l(t) = w_r(t)$, $u_r(t) = w_l(t)$ for all $t > 0$. Hence, we recover (2.29) from (2.30), thus completing the proof of the claim.

Remark 2.15. We observe that if ω is an attainable state in $\mathcal{A}^{[AB]}(T)$, it will follow from our results that the solution $v(x, t) \doteq \overline{\mathcal{S}}_t^{[\overline{B\overline{A}}]+}(\omega(-\cdot))(x)$ related to the backward solution operator may well contain a shock discontinuity exiting from the interface $x = 0$ at a time $\tau < T$. As a consequence here, differently from the space-independent flux setting, the map $x \mapsto v(x, t)$ is in general not locally Lipschitz outside the interface $\{x = 0\}$. In turn, this implies that, for $\omega \in \mathcal{A}^{[AB]}(T)$, the (forward) AB -entropy solution defined by

$$u^*(x, t) \doteq \mathcal{S}_t^{[AB]+}(\mathcal{S}_T^{[AB]-}\omega)(x), \quad x \in \mathbb{R}, \quad t \in [0, T], \quad (2.31)$$

will be in general different from $v(-x, T - t)$ on $\mathbb{R} \times [0, T[$. However, exploiting the duality property enjoyed by the forward and backward solution operators (see § 3), one can still prove that $u^*(x, T) = v(-x, 0) = \omega(x)$ for all $x \in \mathbb{R}$, which shows that ω is a fixed point of the backward-forward operator $\mathcal{S}_T^{[AB]+} \circ \mathcal{S}_T^{[AB]-}$ as stated in Theorem 1.1.

3. TECHNICAL TOOLS FOR CHARACTERIZATION OF THE NEAR-INTERFACE WAVE STRUCTURE

In this section we introduce some technical tools needed to characterize the pointwise constraints satisfied by the attainable profiles of (1.1) in intervals containing the origin. Throughout the section, $f : \mathbb{R} \rightarrow \mathbb{R}$ will be a twice continuously differentiable, uniformly convex map, and we let θ be its unique critical point, $f'(\theta) = 0$. Set

$$\lambda(u, v) \doteq \frac{f(v) - f(u)}{v - u}, \quad u, v \in \mathbb{R}, \quad u \neq v, \quad (3.1)$$

and observe that, by the convexity of f one has

$$f'(u) < \lambda(u, v) < f'(v) \quad \forall u < v \in \mathbb{R}. \quad (3.2)$$

3.1. Left backward shock (Figure 4, left). For every $B > \theta$, $0 < R < T \cdot f'(B)$, we define here:

- two constants $\mathbf{t}[R, B, f]$, $\mathbf{u}[R, B, f]$;
- a function $t \mapsto \mathbf{y}[R, B, f](t)$, $t \in [\mathbf{t}[R, B, f], T]$;

with the following properties. When $f = f_r$, the map $t \mapsto \mathbf{y}[R, B, f_r](t)$ identifies the location of a shock curve in a solution

$$v(x, t) \doteq \overline{\mathcal{S}}_t^{[\overline{B}A]^+}(\omega(-\cdot))(x), \quad x \leq 0, t \geq 0,$$

associated to the operator $\overline{\mathcal{S}}_t^{[\overline{B}A]^+}$, as defined in §2.2.2, with $f = f_r$, for some $\omega \in \mathbf{L}^\infty(\mathbb{R})$. This curve starts from the interface $\{x = 0\}$ at time $t = \mathbf{t}[R, B, f_r]$, and reaches the point $x = \mathbf{y}[R, B, f_r](T)$ at time $t = T$. Such a shock discontinuity has left state $v = \mathbf{u}[R, B, f_r]$ and right state $v = \overline{B}$ at time $t = T$. The point $(-R, 0)$ is the center of a rarefaction fan of $v(x, t)$ located on the left of $\mathbf{y}[R, B, f_r](t)$.

We proceed to introduce these definitions as follows. Set

$$\mathbf{t}[R, B, f] \doteq \frac{R}{f'(B)}, \quad \overline{B} \doteq (f_{|\cdot|-\infty, \theta})^{-1} \circ f(B). \quad (3.3)$$

Then, consider the Cauchy problem

$$\begin{cases} y'(t) = \lambda\left((f')^{-1}\left(\frac{y(t)+R}{t}\right), \overline{B}\right), & t \geq \mathbf{t}[R, B, f], \\ y(\mathbf{t}[R, B, f]) = 0, \end{cases} \quad (3.4)$$

and observe that, since $g(t, y) \doteq \lambda\left((f')^{-1}\left(\frac{y+R}{t}\right), \overline{B}\right)$ is locally Lipschitz continuous in y , by classical arguments it admits a unique solution $\mathbf{y}(t)$ defined on some maximal interval $[\mathbf{t}[R, B, f], \tau[$. On the other hand, because of (3.2) we have

$$g(t, y) > f'(\overline{B}) \quad \forall t \in [\mathbf{t}[R, B, f], \min\{\tau, T\}[, y > -R + T \cdot f'(\overline{B}), \quad (3.5)$$

and hence, since $f'(\overline{B}) < 0$, it follows that

$$\begin{aligned} \mathbf{y}(t) &> (\min\{\tau, T\} - \mathbf{t}[R, B, f]) \cdot f'(\overline{B}) \\ &\geq \min\{\tau, T\} \cdot f'(\overline{B}) \end{aligned} \quad \forall t \in [\mathbf{t}[R, B, f], \min\{\tau, T\}[. \quad (3.6)$$

In turn, (3.6) implies that $\tau > T$. Then, we will denote by

$$\mathbf{y}[R, B, f] : [\mathbf{t}[R, B, f], T] \rightarrow]-\infty, 0[, \quad t \mapsto \mathbf{y}[R, B, f](t),$$

the unique solution to (3.4) defined on the interval $[\mathbf{t}[R, B, f], T]$, and we call $\mathbf{y}[R, B, f]$ a *left backward shock*. Notice that $t \mapsto \frac{d}{dt}\mathbf{y}[R, B, f](t)$ is strictly decreasing, and $\frac{d}{dt}\mathbf{y}[R, B, f](t) \leq 0$ for all $t \in [\mathbf{t}[R, B, f], T]$. Hence, by (3.6) with $\min\{\tau, T\} = T$, the terminal point satisfies $\mathbf{y}[R, B, f](T) \in]T \cdot f'(\overline{B}), 0[$. Next, we set

$$\mathbf{u}[R, B, f] \doteq (f')^{-1}\left(\frac{R + \mathbf{y}[R, B, f](T)}{T}\right). \quad (3.7)$$

Observe that, by construction, $\mathbf{u}[R, B, f]$ depends continuously on the parameters R and B , and that there holds

$$\mathbf{u}[R, B, f] < B. \quad (3.8)$$

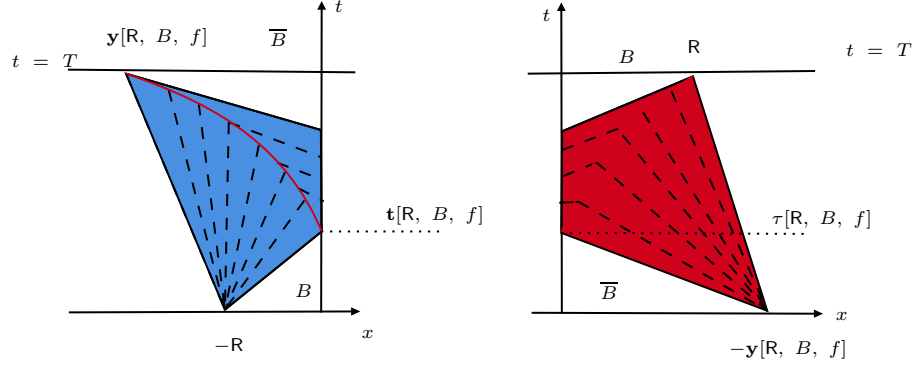

FIGURE 4. The dual solutions $\mathbf{y}[\mathbf{R}, B, f](\cdot)$ (left) and $\mathbf{x}[\mathbf{y}[\mathbf{R}, B, f](T), \bar{B}, f](\cdot)$ (right) of the Cauchy problems (3.4), (3.10). This represents the statement of Lemma 3.1

3.2. Right backward shock (Figure 5, right). Symmetrically to § 3.1, for every $A < \theta$, $T \cdot f'(A) < L < 0$, we define here:

- two constants $\mathbf{s}[\mathbf{L}, A, f]$, $\mathbf{v}[\mathbf{L}, A, f]$;
- a function $t \mapsto \mathbf{x}[\mathbf{L}, A, f](t)$, $t \in [\mathbf{s}[\mathbf{L}, A, f], T]$;

with the following properties. When $f = f_l$, the map $t \mapsto \mathbf{y}[\mathbf{R}, B, f_r](t)$ identifies the location of a shock curve in a solution

$$v(x, t) \doteq \bar{\mathcal{S}}_t^{[\bar{B}\bar{A}]^+}(\omega(-\cdot))(x), \quad x \leq 0, t \geq 0,$$

associated to the operator $\bar{\mathcal{S}}_t^{[\bar{B}\bar{A}]^+}$, as defined in §2.2.2, with $f = f_l$, for some $\omega \in \mathbf{L}^\infty(\mathbb{R})$. This curves starts from the interface $\{x = 0\}$ at time $t = \mathbf{s}[\mathbf{L}, A, f_l]$, and reaches the point $x = \mathbf{x}[\mathbf{L}, A, f_l](T)$ at time $t = T$. Such a shock discontinuity has left state $v = \bar{A}$ and right state $v = \mathbf{v}[\mathbf{L}, A, f_l]$ at time $t = T$. The point $(-L, 0)$ is the center of a rarefaction fan of $v(x, t)$ located on the right of $\mathbf{x}[\mathbf{L}, A, f_l](t)$.

We proceed to introduce these definitions as follows. Set

$$\mathbf{s}[\mathbf{L}, A, f] \doteq \frac{L}{f'(A)}, \quad \bar{A} \doteq (f|_{[\theta, +\infty[})^{-1} \circ f(A). \quad (3.9)$$

Then, let $\mathbf{x}[\mathbf{L}, A, f] : [\mathbf{s}[\mathbf{L}, A, f], T] \rightarrow]0, +\infty[$ denote the unique solution to the Cauchy problem

$$\begin{cases} x'(t) = \lambda \left((f')^{-1} \left(\frac{x(t)+L}{t} \right), \bar{A} \right), & t \in [\mathbf{s}[\mathbf{L}, A, f], T], \\ x(\mathbf{s}[\mathbf{L}, A, f]) = 0. \end{cases} \quad (3.10)$$

We call $\mathbf{x}[\mathbf{L}, A, f]$ a *right backward shock*. Its terminal point satisfies $\mathbf{x}[\mathbf{L}, A, f](T) \in]0, T \cdot f'(\bar{A})[$, and the map $t \mapsto \frac{d}{dt} \mathbf{x}[\mathbf{L}, A, f](t)$ is strictly increasing. Next, we define the quantity

$$\mathbf{v}[\mathbf{L}, A, f] \doteq (f')^{-1} \left(\frac{L + \mathbf{x}[\mathbf{L}, A, f](T)}{T} \right), \quad (3.11)$$

which depends continuously on L and A , and satisfies

$$\mathbf{v}[\mathbf{L}, A, f] > A. \quad (3.12)$$

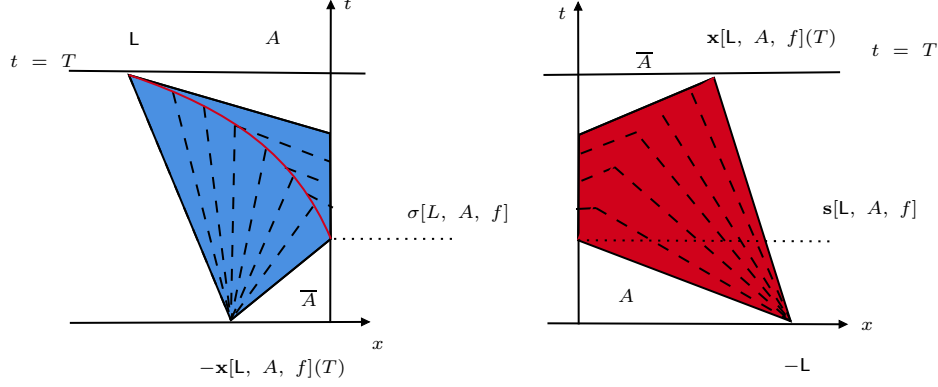

FIGURE 5. The dual solutions $\mathbf{x}[L, A, f](\cdot)$ (right) and $\mathbf{y}[\mathbf{x}[L, A, f](T), \bar{A}, f](\cdot)$ (left) of the Cauchy problems (3.4), (3.10). This represents the statement of Lemma 3.1

3.3. Duality of forward and backward shocks. The definitions of backward shocks given in § 3.1-3.2 turn out to be dual one of the other, as clarified by the following:

Lemma 3.1. *With the notations introduced in § 3.1-3.2, for every $B > \theta$, the following holds. The maps*

$$\begin{aligned} \mathbf{y}[\cdot, B, f](T) :]0, T \cdot f'(B)[&\rightarrow]T \cdot f'(\bar{B}), 0[, & \mathbf{R} &\mapsto \mathbf{y}[\mathbf{R}, B, f](T), \\ \mathbf{x}[\cdot, \bar{B}, f](T) :]T \cdot f'(\bar{B}), 0[&\rightarrow]0, T \cdot f'(B)[, & \mathbf{L} &\mapsto \mathbf{x}[\mathbf{L}, \bar{B}, f](T) \end{aligned} \quad (3.13)$$

are strictly increasing, and one is the inverse of the other, i.e. there holds

$$\begin{aligned} \mathbf{R} &= \mathbf{x}[\mathbf{y}[\mathbf{R}, B, f](T), \bar{B}, f](T), & \forall \mathbf{R} \in]0, T \cdot f'(B)[, \\ \mathbf{L} &= \mathbf{y}[\mathbf{x}[\mathbf{L}, \bar{B}, f](T), B, f](T), & \forall \mathbf{L} \in]T \cdot f'(\bar{B}), 0[. \end{aligned} \quad (3.14)$$

Moreover, one has

$$\begin{aligned} \lim_{\mathbf{R} \rightarrow 0^+} \mathbf{y}[\mathbf{R}, B, f](T) &= T \cdot f'(\bar{B}), & \lim_{\mathbf{R} \rightarrow T \cdot f'(B)^-} \mathbf{y}[\mathbf{R}, B, f](T) &= 0, \\ \lim_{\mathbf{L} \rightarrow 0^-} \mathbf{x}[\mathbf{L}, \bar{B}, f](T) &= T \cdot f'(B), & \lim_{\mathbf{L} \rightarrow T \cdot f'(\bar{B})^+} \mathbf{x}[\mathbf{L}, \bar{B}, f](T) &= 0. \end{aligned} \quad (3.15)$$

Proof.

1. We will prove only the first equality in (3.14), the proof of the second one being entirely similar. Fix $\mathbf{R} \in]0, T \cdot f'(B)[$, and consider the polygonal region (the blue set in Figure 4) defined by

$$\Delta \doteq \Delta_1 \cup \Delta_2,$$

$$\Delta_1 \doteq \left\{ (x, t) \in]-\infty, 0[\times]0, T[: \mathbf{L} - (T - t) \cdot f'(\mathbf{u}) < x < \mathbf{L} - (T - t) \cdot f'(\bar{B}), \mathbf{t} < t < T \right\}, \quad (3.16)$$

$$\Delta_2 \doteq \left\{ (x, t) \in]-\infty, 0[\times]0, T[: \mathbf{L} - (T - t) \cdot f'(\mathbf{u}) < x < (t - t) \cdot f'(B), 0 \leq t \leq \mathbf{t} \right\},$$

where $\mathbf{u} \doteq \mathbf{u}[\mathbf{R}, B, f]$ is the constant in (3.7), $\mathbf{t} \doteq \mathbf{t}[\mathbf{R}, B, f]$ is defined as in (3.9) and $\mathbf{L} \doteq \mathbf{y}[\mathbf{R}, B, f](T)$. Observe that the function $v : \Delta \rightarrow \mathbb{R}$ defined by

$$v(x, t) \doteq \begin{cases} \bar{B} & \text{if } \gamma(t) < x < 0, \\ (f')^{-1}\left(\frac{x + \mathbf{R}}{t}\right) & \text{otherwise,} \end{cases} \quad (3.17)$$

is locally Lipschitz continuous and satisfies the equation (2.17) at every point $(x, t) \in \Delta$ outside the curve $\gamma(\cdot) \doteq \mathbf{y}[\mathbf{R}, B, f](\cdot)$. Moreover, because of the construction of $\mathbf{y}[\mathbf{R}, B, f](\cdot)$, v satisfies

the Rankine-Hugoniot conditions along the curve γ . Therefore $v(x, t)$ is a distributional solution of (2.17) on Δ . Hence, applying the divergence theorem to the piecewise smooth vector field $(v, f(v))$ on Δ , and setting $\tau_1 \doteq T - \mathbf{y}[\mathbf{R}, B, f]/f'(\bar{B})$, we find

$$\begin{aligned} 0 &= (f(\bar{B}) - \bar{B}f'(\bar{B}))(T - \tau_1) + (\mathbf{u}f'(\mathbf{u}) - f(\mathbf{u}))T + \\ &\quad (f(B) - Bf'(B))\mathbf{t} + f(B)(\tau_1 - \mathbf{t}). \end{aligned}$$

Then, observing that $f(B) = f(\bar{B})$ and that $f'(B)\mathbf{t} = \mathbf{R}$, we find

$$\bar{B}\mathbf{y}[\mathbf{R}, B, f](T) + B\mathbf{R} - (\mathbf{u}f'(\mathbf{u}) - f(\mathbf{u}))T - f(B)T = 0. \quad (3.18)$$

Since $f'(\mathbf{u}) = (\mathbf{y}[\mathbf{R}, B, f](T) + \mathbf{R})/T$, and because the Legendre transform f^* of f satisfies the identity

$$f^*(f'(u)) = uf'(u) - f(u) \quad \forall u,$$

(e.g. see [§A.2][18]), we derive from (3.18) the identity

$$\bar{B}\mathbf{y}[\mathbf{R}, B, f](T) + B\mathbf{R} - f^*\left(\frac{\mathbf{y}[\mathbf{R}, B, f](T) + \mathbf{R}}{T}\right)T - f(B)T = 0 \quad \forall \mathbf{R} \in]0, T \cdot f'(B)[. \quad (3.19)$$

2. Next, consider the polygonal region (the red set in Figure 5 with $A = \bar{B}$ and $\bar{A} = B$) defined by

$$\Gamma \doteq \Gamma_1 \cup \Gamma_2,$$

$$\begin{aligned} \Gamma_1 \doteq \left\{ (x, t) \in]0, +\infty[\times]0, T[: \mathbf{x}[\mathbf{y}[\mathbf{R}, B, f](T), \bar{B}, f](T) - (T - t) \cdot f'(B) < x < \right. \\ \left. < \mathbf{x}[\mathbf{y}[\mathbf{R}, B, f](T), \bar{B}, f](T) - (T - t) \cdot f'(v), \mathbf{s} < t < T \right\}, \end{aligned}$$

$$\begin{aligned} \Gamma_2 \doteq \left\{ (x, t) \in]0, +\infty[\times]0, T[: (t - \mathbf{s}) \cdot f'(\bar{B}) < x < \right. \\ \left. < \mathbf{x}[\mathbf{y}[\mathbf{R}, B, f](T), \bar{B}, f](T) - (T - t) \cdot f'(v), 0 \leq t \leq \mathbf{s} \right\}, \end{aligned} \quad (3.20)$$

where $v \doteq v[\mathbf{y}[\mathbf{R}, B, f](T), \bar{B}, f]$ is the constant defined as in (3.11), with $\mathbf{L} = \mathbf{y}[\mathbf{R}, B, f](T)$, $A = \bar{B}$ and $\mathbf{s} = \mathbf{s}[\mathbf{L}, A, f]$. Observe that the function $u : \Gamma \rightarrow \mathbb{R}$ defined by

$$u(x, t) \doteq \begin{cases} B & \text{if } 0 < x < \gamma(t), \\ (f')^{-1}\left(\frac{x + \mathbf{y}[\mathbf{R}, B, f](T)}{t}\right) & \text{otherwise,} \end{cases} \quad (3.21)$$

with $\gamma(t) \doteq \mathbf{x}[\mathbf{y}[\mathbf{R}, B, f](T), \bar{B}, f](t)$, is a distributional solution of (2.17) on Γ for the symmetric arguments of the previous point. Then, repeating the same type of analysis of above for the piecewise smooth vector field $(u, f(u))$ on Γ , one finds the identity

$$\begin{aligned} B\mathbf{x}[\mathbf{y}[\mathbf{R}, B, f](T), \bar{B}, f](T) + \bar{B}\mathbf{y}[\mathbf{R}, B, f](T) + \\ - f^*\left(\frac{\mathbf{x}[\mathbf{y}[\mathbf{R}, B, f](T), \bar{B}, f](T) + \mathbf{y}[\mathbf{R}, B, f](T)}{T}\right)T - f(B)T = 0 \quad \forall \mathbf{R} \in]0, T \cdot f'(B)[. \end{aligned} \quad (3.22)$$

Notice that, by definition of the function $\mathbf{y}[\mathbf{R}, B, f](\cdot)$ in § 3.1, the terminal value satisfies $\mathbf{y}[\mathbf{R}, B, f](T) \in]T \cdot f'(\bar{B}), 0[$, for all $\mathbf{R} \in]0, T \cdot f'(B)[$. In turn, from the definition of $\mathbf{x}[\mathbf{L}, A, f]$ in §3.2, with $A = \bar{B}$, and $\mathbf{L} = \mathbf{y}[\mathbf{R}, B, f](T)$, it follows that

$$\mathbf{x}[\mathbf{y}[\mathbf{R}, B, f](T), \bar{B}, f](T) \in]0, T \cdot f'(B)[, \quad \forall \mathbf{R} \in]0, T \cdot f'(B)[. \quad (3.23)$$

3. We fix now $R \in]0, T \cdot f'(B)[$, and we consider the map $\Upsilon :]0, T \cdot f'(B)[\rightarrow \mathbb{R}$, defined by

$$\Upsilon(x) \doteq \overline{B} \mathbf{y}[R, B, f](T) + Bx - f^* \left(\frac{\mathbf{y}[R, B, f](T) + x}{T} \right) T - f(B)T. \quad (3.24)$$

Observe that, by (3.19), (3.22), (3.23), one has

$$\Upsilon(R) = \Upsilon \left(\mathbf{x}[\mathbf{y}[R, B, f](T), \overline{B}, f](T) \right) = 0. \quad (3.25)$$

Hence, it is sufficient to show that Υ admits only one zero in the interval $]0, T \cdot f'(B)[$ to conclude the proof of the first equality in (3.14). To this end, differentiating Υ and recalling the well known property of the Legendre transform (e.g. see [§A.2][18])

$$(f^*)'(p) = (f')^{-1}(p) \quad \forall p,$$

we find

$$\begin{aligned} \Upsilon'(x) &= B - (f')^{-1} \left(\frac{\mathbf{y}[R, B, f](T) + x}{T} \right) \\ &= (f')^{-1} \left(\frac{0 + T f'(B)}{T} \right) - (f')^{-1} \left(\frac{\mathbf{y}[R, B, f](T) + x}{T} \right). \end{aligned} \quad (3.26)$$

Since $\mathbf{y}[R, B, f](T) < 0$, $x < T \cdot f'(B)$, and because f' is strictly increasing as f' , we deduce from (3.26) that $\Upsilon'(x) > 0$ for all $x \in]0, T \cdot f'(B)[$. Therefore Υ is strictly increasing in the interval $]0, T \cdot f'(B)[$, completing the proof of the first equality in (3.14).

4. We show now that the map $R \mapsto \mathbf{y}(R) \doteq \mathbf{y}[R, B, f](T)$ is strictly increasing in the interval $]0, T \cdot f'(B)[$. Differentiating (3.19) with respect to R , we obtain

$$\left[\overline{B} - (f')^{-1} \left(\frac{\mathbf{y}(R) + R}{T} \right) \right] y'(R) = (f')^{-1} \left(\frac{\mathbf{y}(R) + R}{T} \right) - B \quad \forall R \in]0, T \cdot f'(B)[. \quad (3.27)$$

Since $T \cdot f'(\overline{B}) < \mathbf{y}(R) < 0$ and $0 < R < T \cdot f'(B)$, because f' is strictly increasing we deduce

$$\overline{B} < (f')^{-1} \left(\frac{\mathbf{y}(R)}{T} \right) < (f')^{-1} \left(\frac{\mathbf{y}(R) + R}{T} \right) < (f')^{-1} \left(\frac{R}{T} \right) < B,$$

which, together with (3.27), implies that $y'(R) > 0$ for all $R \in]0, T \cdot f'(B)[$, as wanted. In turn, since $L \mapsto x[L, \overline{B}, f](T)$ is the inverse of $R \mapsto \mathbf{y}[R, B, f](T)$, this implies that $L \mapsto x[L, \overline{B}, f](T)$ is strictly increasing as well in its domain, and that the image of the maps $\mathbf{y}[\cdot, B, f](T)$, $\mathbf{x}[\cdot, \overline{B}, f](T)$, in (3.13) are the sets $]0, T \cdot f'(B)[$ and $]0, T \cdot f'(B)[$, respectively. This, together with the monotonicity of the maps $\mathbf{y}[\cdot, B, f](T)$, $\mathbf{x}[\cdot, \overline{B}, f](T)$, in particular implies the one-sided limits in (3.15), thus concluding the proof of the Lemma. \square

Remark 3.2. As a consequence of Lemma 3.1 and of the monotonicity of f' , we find that the maps

$$R \mapsto \mathbf{u}[R, B, f], \quad L \mapsto \mathbf{v}[L, A, f], \quad (3.28)$$

defined as in (3.7) and (3.11), are strictly increasing, and that there holds

$$\begin{aligned} \lim_{R \rightarrow 0^+} \mathbf{u}[R, B, f] &= \overline{B}, & \lim_{R \rightarrow T \cdot f'(B)^-} \mathbf{u}[R, B, f] &= B, \\ \lim_{L \rightarrow 0^-} \mathbf{v}[L, A, f] &= \overline{A}, & \lim_{L \rightarrow T \cdot f'(A)^+} \mathbf{v}[L, A, f] &= A. \end{aligned} \quad (3.29)$$

This implies that the functions

$$\begin{aligned} \mathbf{u}[\cdot, \cdot, f] &:]0, T \cdot f'(B)[\times]\theta, +\infty[\rightarrow \mathbb{R}, \\ \mathbf{v}[\cdot, \cdot, f] &:]T \cdot f'(A), 0[\times]\theta, +\infty[\rightarrow \mathbb{R} \end{aligned}$$

can be extended to continuous function on $[0, T \cdot f'(B)] \times]\theta, +\infty[$ and $[T \cdot f'(A), 0] \times]\theta, +\infty[$, setting

$$\begin{aligned} \mathbf{u}[0, B, f] &= \overline{B}, & \mathbf{u}[T \cdot f'(B), B, f] &= B, \\ \mathbf{v}[0, A, f] &= \overline{A}, & \mathbf{v}[T \cdot f'(A), A, f] &= A. \end{aligned} \quad (3.30)$$

Moreover, one has

$$\begin{aligned} \mathbf{u}[\mathbf{R}, B, f] &< B & \forall \mathbf{R} \in]0, T \cdot f'(B)[, \\ \mathbf{v}[\mathbf{L}, A, f] &> A & \forall \mathbf{L} \in]T \cdot f'(A), 0[. \end{aligned} \quad (3.31)$$

3.4. Right forward shock-rarefaction wave pattern (Figure 4, right). For every $B > \theta$, $0 < \mathbf{R} < T \cdot f'(B)$, we define now:

- a constant $\tau[\mathbf{R}, B, f]$;
- a function $(x, t) \mapsto u[\mathbf{R}, B, f](x, t)$, $(x, t) \in \Gamma[\mathbf{R}, B, f]$;

with the following properties. When $f = f_r$, the function $u[\mathbf{R}, B, f](x, t)$ defines a (forward) solution associated to the operator $\mathcal{S}^{[AB]^+}$, which contains a shock starting from the interface $\{x = 0\}$ at time $t = \tau[\mathbf{R}, B, f_r]$. The location of such a shock is given by the map $t \mapsto \mathbf{x}[\mathbf{y}[\mathbf{R}, B, f_r](T), \overline{B}, f_r](t)$, where $\mathbf{y}[\mathbf{R}, B, f_r]$ and $\mathbf{x}[\mathbf{L}, \overline{B}, f_r]$ with $\mathbf{L} = \mathbf{y}[\mathbf{R}, B, f_r](T)$, are the backward shocks of a backward solution associated to the operator $\mathcal{S}^{[AB]^-}$ introduced in § 3.1-3.2. Because of Lemma 3.1, the shock $t \mapsto \mathbf{x}[\mathbf{y}[\mathbf{R}, B, f_r](T), \overline{B}, f_r](t)$ reaches the point $x = \mathbf{R}$ at time $t = T$. We can regard $\mathbf{x}[\mathbf{y}[\mathbf{R}, B, f_r](T), \overline{B}, f_r]$ as the “dual shock” of the backward shock $\mathbf{y}[\mathbf{R}, B, f_r]$.

We proceed to introduce these definitions as follows. With the same notations of § 3.1-3.2, for every $B > \theta$, $0 < \mathbf{R} < T \cdot f'(B)$, we set

$$\tau[\mathbf{R}, B, f] \doteq s[\mathbf{y}[\mathbf{R}, B, f](T), \overline{B}, f] = \frac{\mathbf{y}[\mathbf{R}, B, f](T)}{f'(\overline{B})}, \quad (3.32)$$

and we denote by $\Gamma[\mathbf{R}, B, f] \subset (0, T) \times \mathbb{R}$ the polygonal set (the pink set in Figure 4)

$$\Gamma[\mathbf{R}, B, f] \doteq \Gamma_1[\mathbf{R}, B, f] \cup \Gamma_2[\mathbf{R}, B, f], \quad (3.33)$$

with

$$\Gamma_1[\mathbf{R}, B, f] \doteq \left\{ (x, t) \in]0, +\infty[\times]0, T[: \mathbf{R} - (T - t) \cdot f'(B) < x < \mathbf{R} - (T - t) \cdot f'(\mathbf{u}[\mathbf{R}, B, f]), \right. \\ \left. \tau[\mathbf{R}, B, f] < t < T \right\},$$

$$\Gamma_2[\mathbf{R}, B, f] \doteq \left\{ (x, t) \in]0, +\infty[\times]0, T[: -(\tau[\mathbf{R}, B, f] - t) \cdot f'(\overline{B}) < x < \mathbf{R} - (T - t) \cdot f'(\mathbf{u}[\mathbf{R}, B, f]), \right. \\ \left. 0 \leq t \leq \tau[\mathbf{R}, B, f] \right\}. \quad (3.34)$$

Then, set $\gamma(t) \doteq \mathbf{x}[\mathbf{y}[\mathbf{R}, B, f](T), \overline{B}, f](t)$, and denote by $\mathbf{u}[\mathbf{R}, B, f] : \Gamma[\mathbf{R}, B, f] \rightarrow \mathbb{R}$ the function defined by

$$\mathbf{u}[\mathbf{R}, B, f](x, t) \doteq \begin{cases} B & \text{if } 0 < x < \gamma(t), \\ (f')^{-1} \left(\frac{x - \mathbf{R} + T \cdot f'(\mathbf{u}[\mathbf{R}, B, f])}{t} \right) & \text{otherwise.} \end{cases} \quad (3.35)$$

Notice that, by (3.10) and (3.14), one has $\gamma(\tau[\mathbf{R}, B, f]) = 0$, $\gamma(T) = \mathbf{R}$. Moreover, by the same arguments of the proof of Lemma 3.1 it follows that $u[\mathbf{R}, B, f](x, t)$ is a distributional solution of (2.17) on $\Gamma[\mathbf{R}, B, f]$. Furthermore, since $t \mapsto \gamma'(t)$ is strictly increasing as observed in § 3.2, it follows that also the map

$$t \mapsto \frac{\gamma(t) - \mathbf{R} + T \cdot f'(\mathbf{u}[\mathbf{R}, B, f])}{t}$$

is strictly increasing. Therefore, by virtue of (3.14), and relying on (3.31), we find

$$\begin{aligned}
\lim_{x \rightarrow \gamma(t)^+} u[\mathbf{R}, B, f](x, t) &\leq \lim_{x \rightarrow \gamma(T)^+} u[\mathbf{R}, B, f](x, T) \\
&= \lim_{x \rightarrow \mathbf{R}^+} u[\mathbf{R}, B, f](x, T) \\
&= \mathbf{u}[\mathbf{R}, B, f] < B \\
&= \lim_{x \rightarrow \gamma(t)^-} u[\mathbf{R}, B, f](x, t) \quad \forall t \in [\tau[\mathbf{R}, B, f], T],
\end{aligned} \tag{3.36}$$

which shows that the Lax entropy condition is satisfied along the curve $(t, \gamma(t))$, $t \in [\tau[\mathbf{R}, B, f], T]$. Since the flux in (2.17) is strictly convex, this proves that $u[\mathbf{R}, B, f](x, t)$ provides an entropy weak solution of (2.17) on the region $\Gamma[\mathbf{R}, B, f]$. Notice that, by (3.2), from (3.36) we deduce in particular that $f'(B) > \lambda(\mathbf{u}[\mathbf{R}, B, f], B) = \gamma'(T)$, which in turn, by the strict monotonicity of $\dot{\gamma}(t)$, yields

$$f'(B) > \gamma'(t) \quad \forall t \in [\tau[\mathbf{R}, B, f], T]. \tag{3.37}$$

Hence, relying on (3.37), we find

$$f'(B) > \frac{\gamma(T) - \gamma(\tau[\mathbf{R}, B, f])}{T - \tau[\mathbf{R}, B, f]} = \frac{\mathbf{R}}{T - \tau[\mathbf{R}, B, f]}. \tag{3.38}$$

3.5. Left forward rarefaction-shock wave pattern (Figure 5, left). Symmetrically to § 3.4, for every $A < \theta$, $T \cdot f'(A) < \mathbf{L} < 0$, we define here:

- a constant $\sigma[\mathbf{L}, A, f]$;
- a function $(x, t) \mapsto v[\mathbf{L}, A, f](x, t)$, $(x, t) \in \Delta[\mathbf{L}, A, f]$;

with the following properties. When $f = f_l$, the function $v[\mathbf{L}, A, f](x, t)$ defines a (forward) solution associated to the operator $\mathcal{S}^{[AB]^+}$, which contains a shock starting from the interface $\{x = 0\}$ at time $t = \sigma[\mathbf{L}, A, f]$. The location of such a shock is given by the map $t \mapsto \mathbf{y}[\mathbf{x}[\mathbf{L}, A, f_l](T), \bar{A}, f_l](t)$, where $\mathbf{x}[\mathbf{L}, A, f_l]$ and $\mathbf{y}[\mathbf{R}, \bar{A}, f_l]$ with $\mathbf{R} = \mathbf{x}[\mathbf{L}, A, f_l](T)$, are the backward shocks of a backward solution associated to the operator $\mathcal{S}^{[AB]^-}$ introduced in § 3.1-3.2. Because of Lemma 3.1, the shock $t \mapsto \mathbf{y}[\mathbf{x}[\mathbf{L}, A, f_l](T), \bar{A}, f_l](t)$ reaches the point $x = L$ at time $t = T$. We can regard $\mathbf{y}[\mathbf{x}[\mathbf{L}, A, f_l](T), \bar{A}, f_l]$ as the “dual shock” of the backward shock $\mathbf{x}[\mathbf{L}, A, f_l]$.

We proceed to introduce these definitions as follows. With the same notations of § 3.1-3.2, for every $A < \theta$, $T \cdot f'(A) < \mathbf{L} < 0$ we set

$$\sigma[\mathbf{L}, A, f] \doteq t[\mathbf{x}[\mathbf{L}, A, f](T), \bar{A}, f] = \frac{\mathbf{x}[\mathbf{L}, A, f](T)}{f'(\bar{A})}, \tag{3.39}$$

and we denote by $\Delta[\mathbf{L}, A, f] \subset (0, T) \times \mathbb{R}$ the polygonal set (the blue set in Figure 5)

$$\Delta[\mathbf{L}, A, f] \doteq \Delta_1[\mathbf{L}, A, f] \cup \Delta_2[\mathbf{L}, A, f], \tag{3.40}$$

with

$$\begin{aligned}
\Delta_1[\mathbf{L}, A, f] \doteq \left\{ (x, t) \in]-\infty, 0[\times]0, T[: \mathbf{L} - (T - t) \cdot f'(v[\mathbf{L}, A, f]) < x < \mathbf{L} - (T - t) \cdot f'(A), \right. \\
\left. \sigma[\mathbf{L}, A, f] < t < T \right\},
\end{aligned}$$

$$\begin{aligned}
\Delta_2[\mathbf{L}, A, f] \doteq \left\{ (x, t) \in]-\infty, 0[\times]0, T[: \mathbf{L} - (T - t) \cdot f'(v[\mathbf{L}, A, f]) < x < -(\sigma[\mathbf{L}, A, f] - t) \cdot f'(\bar{A}), \right. \\
\left. 0 \leq t \leq \sigma[\mathbf{L}, A, f] \right\}.
\end{aligned} \tag{3.41}$$

Then, set $\gamma(t) \doteq \mathbf{y}[\mathbf{x}[\mathbf{L}, A, f](T), \overline{A}, f](t)$, and denote by $v[\mathbf{L}, A, f] : \Delta[\mathbf{L}, A, f] \rightarrow \mathbb{R}$ the function defined by

$$v[\mathbf{L}, A, f](x, t) \doteq \begin{cases} A & \text{if } \gamma(t) < x < 0, \\ (f')^{-1}\left(\frac{x - \mathbf{L} + T \cdot f'(v[\mathbf{L}, A, f])}{t}\right) & \text{otherwise.} \end{cases} \quad (3.42)$$

Observe that, by (3.4) and (3.14), one has $\gamma(\sigma[\mathbf{L}, A, f]) = 0$, $\gamma(T) = \mathbf{L}$. With the same arguments of § 3.4, it follows that $v[\mathbf{L}, A, f](x, t)$ provides an entropy weak solution of (2.17) on the region $\Delta[\mathbf{L}, A, f]$, and that there holds

$$f'(A) < \frac{\gamma(T) - \gamma(\sigma[\mathbf{L}, A, f])}{T - \sigma[\mathbf{L}, A, f]} = \frac{\mathbf{L}}{T - \sigma[\mathbf{L}, A, f]}. \quad (3.43)$$

Remark 3.3. The constant $\mathbf{u}[\mathbf{R}, B, f]$ defined in § 3.1 is crucial to characterize the jump of an attainable profile $\omega \in \mathcal{A}^{[AB]}(T)$ at the point

$$\mathbf{R} \doteq \inf \{ R > 0 : x - T \cdot f'_r(\omega(x+)) \geq 0 \quad \forall x \geq R \},$$

when $\mathbf{R} \in]0, T \cdot f'_r(B)$. The state $\mathbf{u}[\mathbf{R}, B, f]$ is constructed so to be the largest right state that one can achieve at (\mathbf{R}, T) with a shock that *isolates* the interface $\{x = 0\}$ from the semiaxis $\{x > 0\}$. In fact, the constant $\mathbf{u}[\mathbf{R}, B, f]$ with $f = f_r$, identifies a unique state $\mathbf{u} < B$ that has the property:

- If $\omega = \mathcal{S}_T^{[AB]+} u_0$, and $u(t, x) = \mathcal{S}_t^{[AB]+} u_0(x)$ admits a shock generated in $\{x \geq 0\}$ at some time $t = \tau$, and reaching the point (\mathbf{R}, T) , then letting $\gamma(t)$, $t \in [\tau, T]$, denote the location of such a shock, one has

$$u_\gamma \doteq \lim_{t \rightarrow T^-} u(t, \gamma(t)+) \leq (f'_r)^{-1}(\mathbf{R}/T) \implies u_\gamma \leq \mathbf{u}. \quad (3.44)$$

In particular, one has $u_\gamma = \mathbf{u}$ in (3.44) only in the case where $\mathcal{S}_t^{[AB]+} u_0$ coincides in the polygonal region $\Gamma[\mathbf{R}, B, f]$ with the right forward shock-rarefaction pattern described in section 3.4. By definition of u_γ it follows that either $\omega(\mathbf{R}+) = u_\gamma$, or else there is another jump connecting u_γ with $\omega(\mathbf{R}+)$ which must satisfy the Lax entropy condition $\omega(\mathbf{R}+) < u_\gamma$. Therefore, as a consequence of (3.44) we find a necessary condition for the attainability of ω at time T given by

$$\omega(\mathbf{R}+) \leq \mathbf{u}[\mathbf{R}, B, f_r], \quad (3.45)$$

(see (4.14) of Theorem 4.2 and the proof in § 5.2.3). The interesting fact is that, in the case $\mathbf{R} \in]0, T \cdot f'_r(B)$, condition (3.45), together with the condition

$$\omega(x) \geq B \quad \forall x \in]0, \mathbf{R}], \quad (3.46)$$

(see (4.15), (4.16), of Theorem 4.2), is also sufficient to guarantee the existence of an AB -entropy solution $u(x, t)$ that satisfies

$$u(x, T) = \omega(x) \quad \forall x \in]0, \mathbf{R}], \quad u(\mathbf{R}, T) = \omega(\mathbf{R}+). \quad (3.47)$$

To see this, assuming (3.45)-(3.46), in view of the definitions introduced in the previous sections one can proceed as follows.

- By solving (3.4) one determines the end point $\mathbf{y}[\mathbf{R}, B, f_r](T)$ of a “left backward shock” (Figure 4, left). The map $t \mapsto \mathbf{y}[\mathbf{R}, B, f_r](t)$ represents the position of a shock in a solution associated to the backward operator $\mathcal{S}_t^{[AB]-}$ (see § 3.1);
- given the final position $\mathbf{y}[\mathbf{R}, B, f_r]$ of the “backward shock”, one considers the solution $t \mapsto \gamma(t) \doteq \mathbf{x}[\mathbf{y}[\mathbf{R}, B, f_r], \overline{B}, f_r](t)$ to (3.10), when $\mathbf{L} = \mathbf{y}[\mathbf{R}, B, f_r]$, $A = \overline{B}$, $f = f_r$ (see Figure 4, right). This map represents the position of a shock in a “forward solution”, i.e. in an AB -entropy solution associated to the operator $\mathcal{S}_t^{[AB]+}$. Actually, it can be shown that $(t, \gamma(t))$ is the location of a shock of $\mathcal{S}_t^{[AB]+} u_0$, with $u_0 = \mathcal{S}_t^{[AB]-} \omega$.

- once determined the point $\mathbf{y}[\mathbf{R}, B, f_r](T)$, one defines $\mathbf{u}[\mathbf{R}, B, f_r]$ as the state realizing the slope $(\mathbf{y}[\mathbf{R}, B, f_r](T) + \mathbf{R})/T$ (see (3.7)):

$$f'_r(\mathbf{u}[\mathbf{R}, B, f_r]) = \frac{\mathbf{y}[\mathbf{R}, B, f_r](T) + \mathbf{R}}{T};$$

- thanks to Lemma 3.1, we know that the final position at time T of the shock $\gamma(t)$ satisfies

$$\gamma(T) = \mathbf{R}.$$

Using this procedure, if a profile ω satisfies the conditions(3.45)-(3.46), one can construct admissible AB -shocks that produce at time T the given jump in the profile ω at position \mathbf{R} .

Entirely symmetric considerations hold for the state $\mathbf{v}[\mathbf{L}, A, f]$ defined in § 3.2. As a byproduct of this analysis we will obtain that attainable profiles are fixed points of the backward forward solution operator, as stated in Theorem 1.1.

4. STATEMENT OF THE MAIN RESULTS

Conditions (1), (2) of Theorem 1.1 will be shown to be equivalent by proving that they are both equivalent to a characterization of the attainable set $\mathcal{A}^{[AB]}(T)$ in (1.7) via Oleĭnik-type inequalities and state constraints. To present these results we need to introduce some further notations.

Given a flux $f(x, u)$ as in (1.3), we will use the notations $f_{l,-}^{-1} \doteq (f_l|_{(-\infty, \theta_l]})^{-1}$, $f_{r,-}^{-1} \doteq (f_r|_{(-\infty, \theta_r]})^{-1}$, for the inverse of the restriction of f_l, f_r to their decreasing part, respectively, and $f_{l,+}^{-1} \doteq (f_l|_{[\theta_l, +\infty)})^{-1}$, $f_{r,+}^{-1} \doteq (f_r|_{[\theta_r, +\infty)})^{-1}$, for the inverse of the restriction of f_l, f_r to their increasing part, respectively. Then, we set

$$\pi_{l,\pm} \doteq f_{l,\pm}^{-1} \circ f_l, \quad \pi_{r,\pm} \doteq f_{r,\pm}^{-1} \circ f_r, \quad \pi_{l,\pm}^r \doteq f_{l,\pm}^{-1} \circ f_r, \quad \pi_{r,\pm}^l \doteq f_{r,\pm}^{-1} \circ f_l, \quad (4.1)$$

where $\pi_{l,\pm}^r$ are defined on

$$I_l^r \doteq f_{r,-}^{-1}([f_l(\theta_l), +\infty[) \cup f_{r,+}^{-1}([f_l(\theta_l), +\infty[), \quad (4.2)$$

and $\pi_{r,\pm}^l$ are defined on

$$I_r^l \doteq f_{l,-}^{-1}([f_r(\theta_r), +\infty[) \cup f_{l,+}^{-1}([f_r(\theta_r), +\infty[). \quad (4.3)$$

Moreover, in connection with a function $\omega : \mathbb{R} \rightarrow \mathbb{R}$ we define the quantities

$$\begin{aligned} \mathbf{R}[\omega, f_r] &\doteq \inf \{ R > 0 : x - T \cdot f'_r(\omega(x)) \geq 0 \quad \forall x \geq R \}, \\ \mathbf{L}[\omega, f_l] &\doteq \sup \{ L < 0 : x - T \cdot f'_l(\omega(x)) \leq 0 \quad \forall x \leq L \}, \end{aligned} \quad (4.4)$$

and, if $\mathbf{L}[\omega, f_l] \in]T \cdot f'_l(A), 0[$, we set

$$\tilde{\mathbf{R}}[\omega, f_l, f_r, A, B] \doteq (T - \boldsymbol{\sigma}[\mathbf{L}[\omega, f_l], A, f_l]) \cdot f'_r(B), \quad (4.5)$$

while, if $\mathbf{R}[\omega, f_r] \in]0, T \cdot f'_r(B)[$, we set

$$\tilde{\mathbf{L}}[\omega, f_l, f_r, A, B] \doteq (T - \boldsymbol{\tau}[\mathbf{R}[\omega, f_r], B, f_r]) \cdot f'_l(A). \quad (4.6)$$

where $\boldsymbol{\sigma}[\mathbf{L}, A, f_l]$, $\boldsymbol{\tau}[\mathbf{R}, B, f_r]$, denote the shock starting times introduced in § 3.4-3.5. Such quantities are used to express the pointwise constraints satisfied by ω in intervals containing the origin whenever ω is attainable. Instead, to express the Oleĭnik-type inequalities satisfied by the attainable

profiles it is useful to define the functions

$$\begin{aligned} g[\omega, f_l, f_r](x) &\doteq \frac{f'_l(\omega(x)) [f'_r \circ \pi_{r,-}^l(\omega(x))]^2}{[f''_r \circ \pi_{r,-}^l(\omega(x))] [f'_l(\omega(x))]^2 (T \cdot f'_l(\omega(x)) - x) + x [f'_r \circ \pi_{r,-}^l(\omega(x))]^2 f''_l(\omega(x))}, \\ h[\omega, f_l, f_r](x) &\doteq \frac{f'_r(\omega(x)) [f'_l \circ \pi_{l,+}^r(\omega(x))]^2}{[f''_l \circ \pi_{l,+}^r(\omega(x))] [f'_r(\omega(x))]^2 (T \cdot f'_r(\omega(x)) - x) + x [f'_l \circ \pi_{l,+}^r(\omega(x))]^2 f''_r(\omega(x))}. \end{aligned} \quad (4.7)$$

Since by Remark 2.3 we know that $\mathcal{A}^{[AB]}(T) \subset BV_{\text{loc}}(\mathbb{R} \setminus \{0\})$, we can partition the attainable set as

$$\mathcal{A}^{[AB]}(T) = \bigcup_{L \leq 0, R \geq 0} (\mathcal{A}^{[AB]}(T) \cap \mathcal{A}^{L,R}), \quad (4.8)$$

where

$$\mathcal{A}^{L,R} \doteq \{\omega \in (\mathbf{L}^\infty \cap BV_{\text{loc}})(\mathbb{R} \setminus \{0\}) : \exists \omega(0\pm), \quad \omega(0-) \in I_r^l, \quad \omega(0+) \in I_l^r, \quad L[\omega, f_l] = L, \quad R[\omega, f_r] = R\}. \quad (4.9)$$

The characterization of the attainable profiles in $\mathcal{A}^{L,R}$ will be given in:

- Theorem 4.2, if $L < 0, R > 0$;
- Theorem 4.7, if $L < 0, R = 0$ or $L = 0, R > 0$;
- Theorem 4.9, if $L = 0, R = 0$.

Remark 4.1. Any element of $\mathcal{A}^{L,R}$ is an equivalence class of functions that admit one-sided limit at any point $x \in \mathbb{R}$, and that have at most countably many discontinuities. Therefore, for any element of $\mathcal{A}^{L,R}$, we can always choose a representative which is left or right continuous. For sake of uniqueness, throughout the paper we will consider a representative of ω that is right continuous.

Throughout the following

$$D^- \omega(x) = \liminf_{h \rightarrow 0} \frac{\omega(x+h) - \omega(x)}{h}, \quad D^+ \omega(x) = \limsup_{h \rightarrow 0} \frac{\omega(x+h) - \omega(x)}{h}, \quad (4.10)$$

will denote, respectively, the lower and the upper Dini derivative of a function ω at x .

Theorem 4.2. *In the same setting of Theorem 1.1, let (A, B) be a connection, let $\mathcal{A}^{[AB]}(T)$, $T > 0$, be the set in (1.7), and let ω be an element of the set $\mathcal{A}^{L,R}$ in (4.9), with $L < 0, R > 0$. Then, $\omega \in \mathcal{A}^{[AB]}(T)$ if and only if the connection (A, B) is not critical and there hold:*

(i) *the following Oleřnik-type inequalities are satisfied*

$$\begin{aligned} D^+ \omega(x) &\leq \frac{1}{T \cdot f''_l(\omega(x))} \quad \forall x \in]-\infty, L[, \\ D^+ \omega(x) &\leq \frac{1}{T \cdot f''_r(\omega(x))} \quad \forall x \in]R, +\infty[. \end{aligned} \quad (4.11)$$

Moreover, letting g, h be the functions in (4.7), and letting $\tilde{L} \doteq \tilde{L}[\omega, f_l, f_r, A, B]$, $\tilde{R} \doteq \tilde{R}[\omega, f_l, f_r, A, B]$, be the constants in (4.5), (4.6), if $R \in]0, T \cdot f'_r(B)[$, and if $\tilde{L} > L$, then one has

$$D^+ \omega(x) \leq g[\omega, f_l, f_r](x) \quad \forall x \in]L, \tilde{L}[, \quad (4.12)$$

while, if $L \in]T \cdot f'_l(A), 0[$, and if $\tilde{R} < R$, then one has

$$D^+ \omega(x) \leq h[\omega, f_l, f_r](x) \quad \forall x \in]\tilde{R}, R[. \quad (4.13)$$

(ii) letting $\mathbf{u}[R, B, f_r]$, $\mathbf{v}[L, A, f_l]$, be constants defined as in (3.7), (3.11), the following pointwise state constraints are satisfied

$$\begin{aligned} L \in]T \cdot f'_l(A), 0[&\implies \omega(L-) \geq \mathbf{v}[L, A, f_l] \geq \omega(L+), \\ R \in]0, T \cdot f'_r(B)[&\implies \omega(R+) \leq \mathbf{u}[R, B, f_r] \leq \omega(R-). \end{aligned} \quad (4.14)$$

$$\begin{aligned} [L \in]T \cdot f'_l(A), 0[\text{ and } R \leq \tilde{R}] \text{ or } L \leq T \cdot f'_l(A) &\implies \omega(x) = B \quad \forall x \in]0, R[, \\ [R \in]0, T \cdot f'_r(B)[\text{ and } \tilde{L} \leq L] \text{ or } R \geq T \cdot f'_r(B) &\implies \omega(x) = A \quad \forall x \in]L, 0[, \end{aligned} \quad (4.15)$$

$$L \in]T \cdot f'_l(A), 0[\text{ and } \tilde{R} < R \implies \begin{cases} \omega(x) = B & \forall x \in]0, \tilde{R}], \\ \omega(\tilde{R}+) = B, \\ \omega(x) \geq B & \forall x \in]\tilde{R}, R[, \end{cases} \quad (4.16)$$

$$R \in]0, T \cdot f'_r(B)[\text{ and } L < \tilde{L} \implies \begin{cases} \omega(x) = A & \forall x \in [\tilde{L}, 0[, \\ \omega(\tilde{L}-) = A, \\ \omega(x) \leq A & \forall x \in]L, \tilde{L}[, \end{cases} \quad (4.17)$$

$$\begin{aligned} L \leq T \cdot f'_l(A) &\implies \omega(L-) \geq \omega(L+), \\ R \geq T \cdot f'_r(B) &\implies \omega(R-) \geq \omega(R+). \end{aligned} \quad (4.18)$$

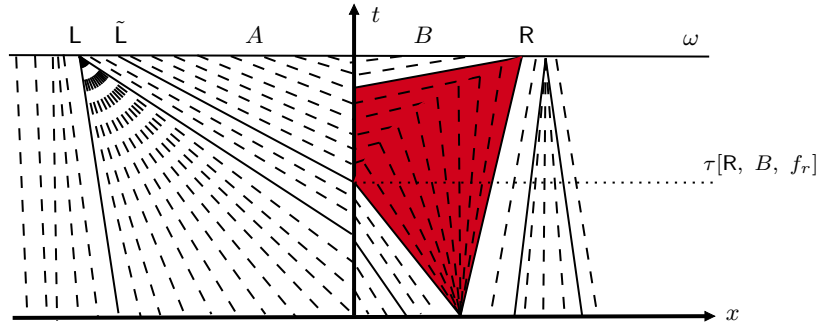

FIGURE 6. Case 1.

Remark 4.3. By Theorem 4.2, if the connection is critical, then the set $\mathcal{A}^{[AB]}(T)$ does not contain profiles ω with $L[\omega, f_l] < 0$ and $R[\omega, f_r] > 0$. Notice that conditions (4.15), (4.16) imply $\omega(R-) \geq B$. On the other hand, if $R < T \cdot f'_r(B)$, by virtue of (4.14), and because of (3.31), we have $\omega(R+) \leq B$. Hence, because of (4.18), it follows that the inequality $\omega(R-) \geq \omega(R+)$ is always satisfied. With similar arguments we deduce that also the inequality $\omega(L-) \geq \omega(L+)$ is always verified.

Remark 4.4. If $R[\omega, f_r] \in]0, T \cdot f'_r(B)[$, applying (3.38) with f_r in place of f and $R = R[\omega, f_r]$, and recalling (4.5), we derive

$$\frac{R[\omega, f_r]}{f'_r(B)} < T - \tau[R[\omega, f_r], B, f_r] = \frac{\tilde{L}[\omega, f_l, f_r, A, B]}{f'_l(A)}. \quad (4.19)$$

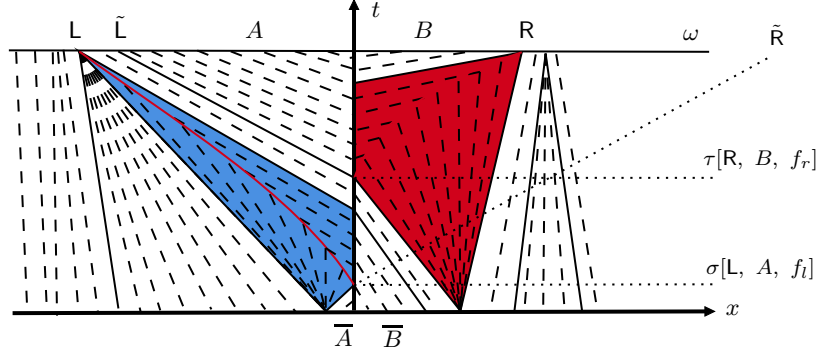

FIGURE 7. Case 2.

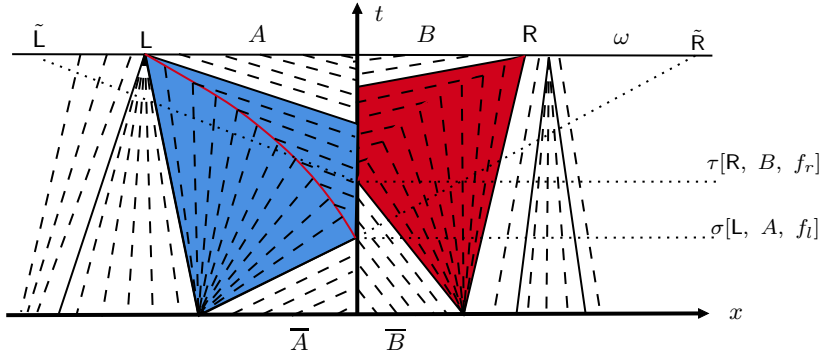

FIGURE 8. Case 3.

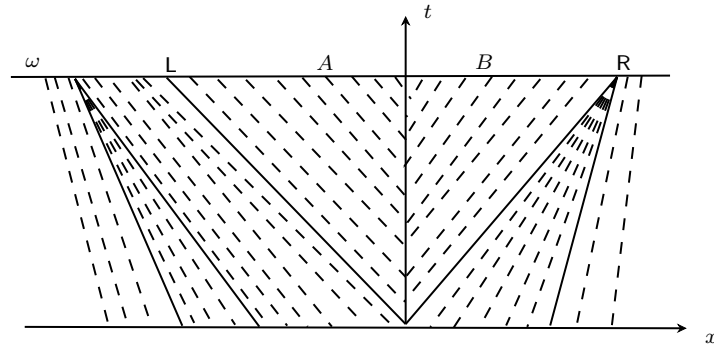

FIGURE 9. Case 4.

Similarly, if $L[\omega, f_l] \in]T \cdot f'_l(A), 0[$, applying (3.43) with f_l in place of f and $L = L[\omega, f_l]$, and recalling that $f'_l(A) < 0$ we find

$$\frac{L[\omega, f_l]}{f'_l(A)} < T - \sigma[L[\omega, f_l], A, f_l]. \quad (4.20)$$

Hence, if $\tilde{L}[\omega, f_l, f_r, A, B] \geq L[\omega, f_l]$, combining (4.19), (4.20), we deduce

$$\frac{R[\omega, f_r]}{f'_r(B)} < T - \sigma[L[\omega, f_l], A, f_l], \quad (4.21)$$

which, in turn, by (4.5) yields

$$R[\omega, f_r] < \tilde{R}[\omega, f_l, f_r, A, B]. \quad (4.22)$$

With entirely similar arguments one can show that, if $\tilde{\mathbf{R}}[\omega, f_l, f_r, A, B] \leq \mathbf{R}[\omega, f_r]$, then one has

$$\mathbf{L}[\omega, f_l] > \tilde{\mathbf{L}}[\omega, f_l, f_r, A, B]. \quad (4.23)$$

Therefore, when $\mathbf{L}[\omega, f_l] \in]T \cdot f'_l(A), 0[$, and $\mathbf{R}[\omega, f_r] \in]0, T \cdot f'_r(B)[$, there hold

$$\begin{aligned} \tilde{\mathbf{L}}[\omega, f_l, f_r, A, B] \geq \mathbf{L}[\omega, f_l] &\implies \tilde{\mathbf{R}}[\omega, f_l, f_r, A, B] > \mathbf{R}[\omega, f_r], \\ \tilde{\mathbf{R}}[\omega, f_l, f_r, A, B] \leq \mathbf{R}[\omega, f_r] &\implies \tilde{\mathbf{L}}[\omega, f_l, f_r, A, B] < \mathbf{L}[\omega, f_l]. \end{aligned} \quad (4.24)$$

These implications, in particular, show that it can never occur the case where

$$\tilde{\mathbf{L}}[\omega, f_l, f_r, A, B] \geq \mathbf{L}[\omega, f_l] \quad \text{and} \quad \tilde{\mathbf{R}}[\omega, f_l, f_r, A, B] \leq \mathbf{R}[\omega, f_r]. \quad (4.25)$$

Remark 4.5. Notice that by condition (4.15) in Theorem 4.2, and because of (4.5), it follows that if $\mathbf{L}[\omega, f_l] \in]T \cdot f'_l(A), 0[$, and $\mathbf{R}[\omega, f_r] \leq \tilde{\mathbf{R}}[\omega, f_l, f_r, A, B]$, then one has $\mathbf{R}[\omega, f_r] < T \cdot f'_r(B)$. Therefore, we have

$$\left[\mathbf{L}[\omega, f_l] \in]T \cdot f'_l(A), 0[\quad \text{and} \quad \mathbf{R}[\omega, f_r] \geq T \cdot f'_r(B) \right] \implies \mathbf{R}[\omega, f_r] > \tilde{\mathbf{R}}[\omega, f_l, f_r, A, B]. \quad (4.26)$$

Similarly, one can show that, by (4.5), (4.15), there holds

$$\left[\mathbf{R}[\omega, f_r] \in]0, T \cdot f'_r(B)[\quad \text{and} \quad \mathbf{L}[\omega, f_l] \leq T \cdot f'_l(A) \right] \implies \mathbf{L}[\omega, f_l] < \tilde{\mathbf{L}}[\omega, f_l, f_r, A, B]. \quad (4.27)$$

Then, relying on (4.24), (4.26), (4.27), we deduce that we can distinguish six cases of pointwise constraints prescribed by condition (ii) of Theorem 4.2, which depend on the reciprocal positions of the points $\mathbf{L} = \mathbf{L}[\omega, f_l]$, $\mathbf{R} = \mathbf{R}[\omega, f_r]$, and $\tilde{\mathbf{L}}$, $\tilde{\mathbf{R}}$:

CASE 1: If $\mathbf{L} \leq T \cdot f'_l(A) < 0$, $0 < \mathbf{R} < T \cdot f'_r(B)$ (Figure 6), then $\tilde{\mathbf{L}} > \mathbf{L}$, and there holds

$$\omega(x) \leq A \quad \forall x \in]\mathbf{L}, \tilde{\mathbf{L}}[, \quad \omega(\tilde{\mathbf{L}}-) = A, \quad \omega(x) = A \quad \forall x \in]\tilde{\mathbf{L}}, 0[, \quad (4.28)$$

$$\omega(x) = B \quad \forall x \in]0, \mathbf{R}[, \quad \omega(\mathbf{R}+) \leq \mathbf{u}[\mathbf{R}, B, f_r] \leq B; \quad (4.29)$$

CASE 2: If $T \cdot f'_l(A) < \mathbf{L} < 0$, $0 < \mathbf{R} < T \cdot f'_r(B)$, and $\tilde{\mathbf{L}} > \mathbf{L}$, $\tilde{\mathbf{R}} > \mathbf{R}$ (Figure 7), then there hold (4.29) and

$$\omega(\mathbf{L}-) \geq \mathbf{v}[\mathbf{L}, A, f_l] \geq A, \quad \omega(x) \leq A \quad \forall x \in]\mathbf{L}, \tilde{\mathbf{L}}[, \quad \omega(\tilde{\mathbf{L}}-) = A, \quad \omega(x) = A \quad \forall x \in]\tilde{\mathbf{L}}, 0[; \quad (4.30)$$

the symmetric ones:

CASE 1B: If $T \cdot f'_l(A) < \mathbf{L} < 0$, $0 < T \cdot f'_r(B) \leq \mathbf{R}$, then $\tilde{\mathbf{R}} < \mathbf{R}$ and there holds

$$\omega(x) = A \quad \forall x \in]\mathbf{L}, 0[, \quad \omega(\mathbf{L}-) \geq \mathbf{v}[\mathbf{L}, A, f_l] \geq A, \quad (4.31)$$

$$\omega(x) = B \quad \forall x \in]0, \tilde{\mathbf{R}}[, \quad \omega(\tilde{\mathbf{R}}+) = B, \quad \omega(x) \geq B \quad \forall x \in]\tilde{\mathbf{R}}, \mathbf{R}]; \quad (4.32)$$

CASE 2B: If $T \cdot f'_l(A) < \mathbf{L} < 0$, $0 < \mathbf{R} < T \cdot f'_r(B)$, and $\tilde{\mathbf{L}} < \mathbf{L}$, $\tilde{\mathbf{R}} < \mathbf{R}$, then there hold (4.31), and

$$\omega(x) = B \quad \forall x \in]0, \tilde{\mathbf{R}}[, \quad \omega(\tilde{\mathbf{R}}+) = B, \quad \omega(x) \geq B \quad \forall x \in]\tilde{\mathbf{R}}, \mathbf{R}[\quad \omega(\mathbf{R}+) \leq \mathbf{u}[\mathbf{R}, B, f_r] \leq B; \quad (4.33)$$

and the remaining ones:

CASE 3: If $T \cdot f'_l(A) < \mathbf{L} < 0$, $0 < \mathbf{R} < T \cdot f'_r(B)$, and $\tilde{\mathbf{L}} \leq \mathbf{L}$, $\tilde{\mathbf{R}} \geq \mathbf{R}$ (Figure 8), then there hold (4.29), (4.31);

CASE 4: If $\mathbf{L} \leq T \cdot f'_l(A) < 0$ and $\mathbf{R} \geq T \cdot f'_r(B) > 0$ (Figure 9), then there holds

$$\omega(x) = A \quad \forall x \in]\mathbf{L}, 0[, \quad \omega(x) = B \quad \forall x \in]0, \mathbf{R}]. \quad (4.34)$$

The six cases are depicted in Figure 10. One can regard the intervals $]T \cdot f'_l(A), 0[$ and $]0, T \cdot f'_r(B)[$ as “active zones” for the presence of shocks in an AB -entropy solution that attains ω at time T : as

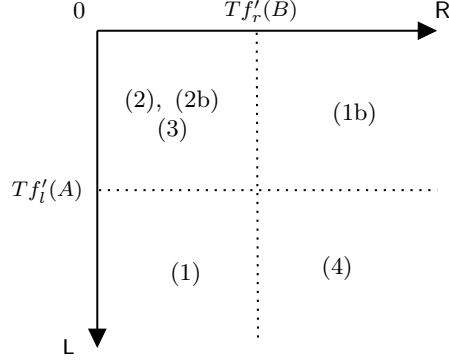

FIGURE 10. The different cases of Remark 4.4.

soon as L belongs to $]T \cdot f'_l(A), 0[$ or R belongs to $]0, T \cdot f'_r(B)[$, it is needed a shock emerging from the interface in order to produce the discontinuity occurring in ω at L or R .

Remark 4.6. When the connection is not critical and $L \doteq L[\omega, f_l] < 0$, $R \doteq R[\omega, f_r] > 0$, the analysis of attainable profiles $\omega \in \mathcal{A}^{AB}(T)$ pursued in [2] catches only the profiles described in Cases 3 and 4 of Remark 4.5. In fact, the characterization of $\mathcal{A}^{AB}(T)$ established in [2, Theorem 6.1] requires that all profiles $\omega \in \mathcal{A}^{AB}(T)$ satisfy the equalities

$$\omega(x) = A \quad \forall x \in]L, 0[, \quad \omega(x) = B \quad \forall x \in]0, R[.$$

Therefore, such a characterization in particular excludes all attainable profiles ω that either satisfy conditions (4.28) or (4.30), of Cases 1 and 2, with

$$\omega(x) \leq A \quad \forall x \in]L, \tilde{L}[,$$

or satisfy conditions (4.32), (4.33), of Cases 1B and 2B, with

$$\omega(x) \geq B \quad \forall x \in]\tilde{R}, R[.$$

Whenever $L = 0$ or $R = 0$, the characterization of the profiles $\omega \in \mathcal{A}^{AB}(T) \cap \mathcal{A}^{L,R}$ does not involve the constants \tilde{L} , \tilde{R} , as we see in the following

Theorem 4.7. *In the same setting of Theorem 4.2, let ω be an element of the set $\mathcal{A}^{L,R}$ in (4.9), let g, h be the functions in (4.7), and let $\mathbf{u}[R, B, f_r]$, $\mathbf{v}[L, A, f_l]$, be constants defined as in (3.7), (3.11). Then, if $L < 0$, $R = 0$, $\omega \in \mathcal{A}^{[AB]}(T)$ if and only if there hold:*

(i) *the following Oleřnik-type inequalities are satisfied*

$$D^+\omega(x) \leq \frac{1}{T \cdot f'_l(\omega(x))} \quad \forall x \in]-\infty, L[, \tag{4.35}$$

$$D^+\omega(x) \leq \frac{1}{T \cdot f'_r(\omega(x))} \quad \forall x \in]0, +\infty[,$$

$$D^+\omega(x) \leq g[\omega, f_l, f_r](x) \quad \forall x \in]L, 0[. \tag{4.36}$$

(ii) *the following pointwise state constraints are satisfied:*

$$\omega(0+) \leq \pi_{r,-}^l(\omega(0-)), \tag{4.37}$$

$$\omega(x) \leq A \quad \forall x \in]L, 0[, \tag{4.38}$$

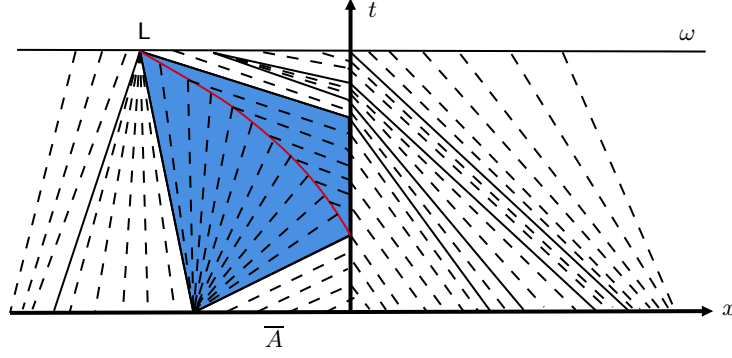
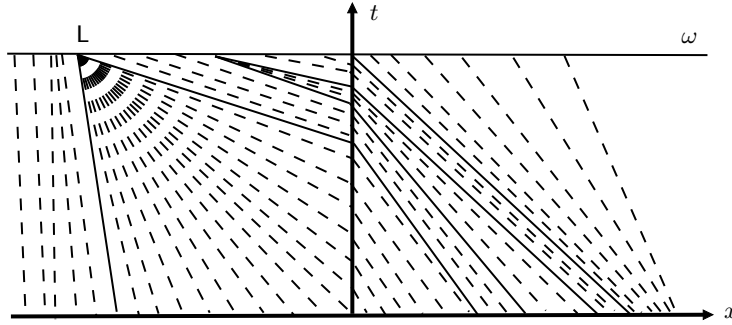
FIGURE 11. Theorem 4.7 when $L < 0$, $R = 0$ and $L \in]T \cdot f'_l(A), 0[$.FIGURE 12. Theorem 4.7 when $L < 0$, $R = 0$ and $L \leq T \cdot f'_l(A)$.

and

$$L \in]T \cdot f'_l(A), 0[\quad \implies \quad \omega(L-) \geq \mathbf{v}[L, A, f_l] \geq \omega(L+), \quad (4.39)$$

$$L \leq T \cdot f'_l(A) \quad \implies \quad \omega(L-) \geq \omega(L+). \quad (4.40)$$

Symmetrically, if $L = 0$, $R > 0$, then $\omega \in \mathcal{A}^{[AB]}(T)$ if and only if there hold:

(i)' the following Oleĭnik-type inequalities are satisfied

$$D^+ \omega(x) \leq \frac{1}{T \cdot f''_l(\omega(x))} \quad \forall x \in]-\infty, 0[, \quad (4.41)$$

$$D^+ \omega(x) \leq \frac{1}{T \cdot f''_r(\omega(x))} \quad \forall x \in]R, +\infty[,$$

$$D^+ \omega(x) \leq h[\omega, f_l, f_r](x) \quad \forall x \in]0, R[. \quad (4.42)$$

(ii)' the following pointwise state constraints are satisfied:

$$\omega(0-) \geq \pi_{l,+}^r(\omega(0+)), \quad (4.43)$$

$$\omega(x) \geq B \quad \forall x \in]0, R[, \quad (4.44)$$

and

$$R \in]0, T \cdot f'_r(B)[\quad \implies \quad \omega(R+) \leq \mathbf{u}[R, B, f_r] \leq \omega(R-), \quad (4.45)$$

$$R \geq T \cdot f'_r(B) \quad \implies \quad \omega(R+) \leq \omega(R-). \quad (4.46)$$

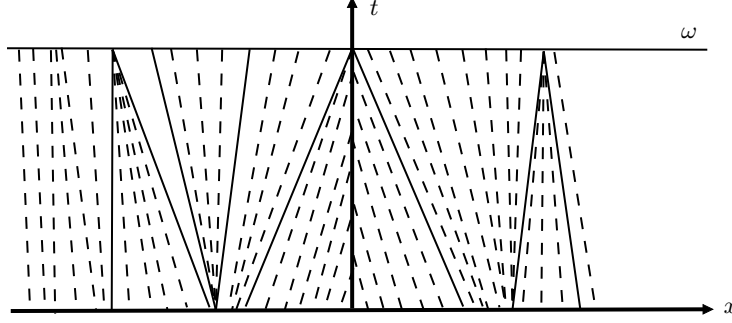

FIGURE 13. Structure of profiles described by Theorem 4.9.

Remark 4.8. Notice that the implications (4.39)-(4.40), (4.45)-(4.46) can be extended to $L = T \cdot f'_l(A)$ and to $R = T \cdot f'_r(B)$, respectively. In fact, by definition (4.4) of $L = L[\omega, f_l]$, one has $f'_l(\omega(L-)) \geq L/T$. Hence, if $L = T \cdot f'_l(A)$ it follows that $f'_l(\omega(L-)) \geq f'_l(A)$ which yields $\omega(L-) \geq A$ by the monotonicity of f'_l . Thus, recalling that by (3.30) we have $\mathbf{v}[T \cdot f'_l(A), A, f] = A$, we derive

$$\omega(T \cdot f'_l(A)-) \geq \mathbf{v}[T \cdot f'_l(A), A, f_l]. \quad (4.47)$$

On the other hand, since (4.38) implies $\omega(T \cdot f'_l(A+)) \leq A$, we deduce from (4.47) that

$$\omega(T \cdot f'_l(A)-) \geq \omega(T \cdot f'_l(A+)). \quad (4.48)$$

With entirely similar arguments one can show that there hold

$$\omega(T \cdot f'_l(B)+) \leq \mathbf{u}[T \cdot f'_l(B), B, f_r], \quad (4.49)$$

$$\omega(T \cdot f'_r(B)+) \leq \omega(T \cdot f'_r(B)-). \quad (4.50)$$

Hence, relying on (4.38), (4.39), (4.40), (4.44), (4.45), (4.46), and on (4.48), (4.50), with the same arguments of Remark 4.3 we deduce that the inequalities $\omega(L-) \geq \omega(L+)$, $\omega(R-) \geq \omega(R+)$ are always satisfied.

Theorem 4.9. *In the same setting of Theorem 4.2, let ω be an element of the set $\mathcal{A}^{L,R}$ in (4.9), with $L = 0$, $R = 0$. Then $\omega \in \mathcal{A}^{[A,B]}(T)$ if and only if there hold:*

(i) *the following Oleĭnik-type inequalities are satisfied*

$$D^+\omega(x) \leq \frac{1}{T \cdot f''_l(\omega(x))} \quad \forall x \in]-\infty, 0[, \quad (4.51)$$

$$D^+\omega(x) \leq \frac{1}{T \cdot f''_r(\omega(x))} \quad \forall x \in]0, +\infty[.$$

(ii) *the following pointwise state constraints are satisfied:*

$$\omega(0-) \geq \pi_{l,+}^r(\omega(0+)), \quad (4.52)$$

$$\omega(0-) \geq \bar{A}, \quad \omega(0+) \leq \bar{B}. \quad (4.53)$$

Remark 4.10. Recalling that by (3.30) we have $\mathbf{v}[0, A, f_l] = \bar{A}$, $\mathbf{u}[0, B, f_r] = \bar{B}$, we can rephrase the constraint (4.53) as

$$\omega(0-) \geq \mathbf{v}[0, A, f_l], \quad \omega(0+) \leq \mathbf{u}[0, B, f_r]. \quad (4.54)$$

Combining Theorems 4.2, 4.7, 4.9, with Theorem 1.1, we obtain:

Theorem 4.11. *In the same setting of Theorem 1.1, let (A, B) be a connection. Then, for every $T > 0$, and for any $\omega \in \mathbf{L}^\infty(\mathbb{R})$, the following conditions are equivalent.*

- (1) $\omega \in \mathcal{A}^{AB}(T)$.
- (2) $\mathcal{S}_T^{[AB]^+} \circ \mathcal{S}_T^{[AB]^-} \omega = \omega$.
- (3) ω is an element of the set $\mathcal{A}^{L,R}$ in (4.9), with $L \leq 0, R \geq 0$, that satisfies the conditions of Theorem 4.2, 4.7, or 4.9.

Moreover, if (A, B) is a non critical connection, i.e. if $A \neq \theta_l, B \neq \theta_r$, then the conditions (2) and (3) are equivalent to

- (1)' $\omega \in \mathcal{A}_{bv}^{[AB]}(T)$, where

$$\mathcal{A}_{bv}^{[AB]}(T) \doteq \{ \mathcal{S}_T^{[AB]^+} u_0 : u_0 \in BV_{loc}(\mathbb{R}) \}, \quad (4.55)$$

and there holds

$$\mathcal{A}^{[AB]}(T) = \mathcal{A}_{bv}^{[AB]}(T). \quad (4.56)$$

Remark 4.12 (Comparison with previous results). Theorem 4.2, 4.7, 4.9 yield the first *complete characterization of the attainable set at time $T > 0$ in terms of Oleinik-type inequalities and unilateral constraints*, for critical and non critical connections. Partial results in this direction have been recently obtained for *strict subsets* of $\mathcal{A}^{AB}(T)$. In particular, we refer to:

- the work [6], where it is characterized only the subset $\mathcal{A}_L^{AB}(T) \subset \mathcal{A}^{AB}(T)$ given by

$$\mathcal{A}_L^{[AB]}(T) = \{ \omega \in \mathcal{A}^{[AB]}(T) \mid \exists AB \text{ entropy solution } u \in \text{Lip}_{loc}((0, T) \times \mathbb{R} \setminus \{0\}) : u(T, x) = \omega \}.$$

- the work [2], in which, for critical connections (A, B) , the set $\mathcal{A}^{[AB]}(T)$ is fully characterized in terms of triples (a monotone function and a pair of points) related to the Lax-Oleinik representation formula of solutions (obtained in [5] via the Hamilton-Jacobi dual formulation). Instead, for non critical connections (A, B) , when $L < 0$ and $R > 0$, [2] provides a characterization of only a subset of the attainable profiles. Namely, in [2] only the profiles of CASES 3, 4, discussed in Remark 4.4, are characterized, missing the ones of CASES 1, 2, 1B, 2B. In fact, the profiles constructed in [2] with $L < 0, R > 0$, satisfy always the condition $\omega(x) = A$ for all $x \in (L, 0)$, and $\omega(x) = B$ for all $x \in (0, R)$, which is in general not fulfilled by profiles of CASES 1, 2, 1B, 2B (cfr. Remark 4.6).

We point out that, as a byproduct of the characterization of $\mathcal{A}^{AB}(T)$ via Oleinik-type estimates, one can establish uniform BV bounds on solutions to (1.1), (1.3) in the case of non critical connections, and on the flux of solutions to (1.1), (1.3) for general connections (see. Proposition A.3 in Appendix A). In turn such bounds yield the \mathbf{L}_{loc}^1 -Lipschitz continuity in time of AB -entropy solutions (see the proof of Theorem 2.7-(v)) in Appendix A).

5. PROOF OF THEOREM 4.11

5.1. Proof roadmap. Observe that if (A, B) is a non critical connection, then recalling Definition 2.13, and relying on Proposition A.3 in Appendix A, we deduce that $\mathcal{S}_T^{[AB]^-} \omega \in BV_{loc}(\mathbb{R})$ for all $\omega \in \mathbf{L}^\infty(\mathbb{R})$. Hence setting $u_0 \doteq \mathcal{S}_T^{[AB]^-} \omega$, we deduce immediately the implication (2) \Rightarrow (1)'. On the other hand, since $\mathcal{A}_{bv}^{[AB]}(T) \subset \mathcal{A}^{[AB]}(T)$, from the implication (1) \Rightarrow (3), one deduces that (1)' \Rightarrow (3) holds as well.

Therefore, in order to establish Theorem 4.11 it will be sufficient to prove the equivalence of the conditions (1), (2), (3). We provide here a road map of the proof of (1) \Leftrightarrow (2) \Leftrightarrow (3). There are three main parts, which are somewhat independent one from the other.

Part 1. The case of a non critical connection (1) \Rightarrow (3). In Sections 5.2-5.3 we prove the implication (1) \Rightarrow (3) of Theorem 4.11 when (A, B) is a *non critical* connection. The proof has a bootstrap-like structure, and it is divided in two steps.

- *Part 1.a - (1) \Rightarrow (3) for non critical connections assuming (H).* This is the first fundamental block of our proof. We prove in § 5.2 the implication (1) \Rightarrow (3) for profiles $\omega \in \mathcal{A}^{[AB]}(T)$ that satisfy the BV condition:

$$\exists u_0 \in \mathbf{L}^\infty(\mathbb{R}) : \omega = \mathcal{S}_T^{[AB]+} u_0, \quad \text{and} \quad \mathcal{S}_t^{[AB]+} u_0 \in BV_{\text{loc}}(\mathbb{R}) \quad \forall t > 0. \quad (\text{H})$$

The derivation of the conditions of Theorem 4.2, 4.7, and 4.9 is obtained exploiting as in [6] the non crossing property of genuine characteristics in the domains $\{x > 0, t > 0\}$, $\{x < 0, t > 0\}$, together with the non existence of rarefactions emanating from the interface (cfr. Appendix B and [2]). Two key novel points of the analysis here are:

- a blowup argument, possible thanks to assumption (H), to derive the Oleĭnik-type inequalities satisfied by ω in regions comprising points with characteristics reflected by the interface $x = 0$, and points with characteristics refracted by $x = 0$.
- a comparison arguments (based on the duality of forward and backward shocks of § 3.3, and on the property of the states $\mathbf{u}[\mathbf{R}, B, f_r]$, $\mathbf{v}[\mathbf{L}, A, f_l]$, defined in § 3.1, 3.2) to establish the unilateral inequalities satisfied by ω at points of discontinuity generated by shocks that *isolate* the interface $\{x = 0\}$ from the semiaxes $\{x < 0\}$, $\{x > 0\}$ (cfr. Remark 3.3).
- *Part 1.b - (1) \Rightarrow (3) for non critical connections without assuming (H).* We prove in § 5.3 the implication (1) \Rightarrow (3) for every $\omega \in \mathcal{A}^{AB}(T)$ by showing that every $\omega \in \mathcal{A}^{AB}(T)$ actually satisfy condition (H), and then the conclusion follows by Part 1.a. This is achieved: considering a sequence of functions $u_{n,0} \in BV(\mathbb{R})$ that \mathbf{L}^1 -converge to $u_0 \in \mathbf{L}^\infty(\mathbb{R})$; observing that $\mathcal{S}_t^{[AB]+} u_{n,0} \in BV(\mathbb{R})$ (see [1, 25]); deriving uniform BV bounds on $\mathcal{S}_T^{[AB]+} u_{n,0}$ based on the Oleĭnik-type inequalities enjoyed by $\mathcal{S}_T^{[AB]+} u_{n,0}$ because of Part 1.a; relying on the \mathbf{L}^1 -stability of the semigroup map $u_0 \mapsto \mathcal{S}_T^{[AB]+} u_0$ (see Theorem 2.7-(iii)) and on the lower semicontinuity of the total variation with respect to \mathbf{L}^1 -convergence.

Part 2. The case of a non critical connection (3) \Rightarrow (2) \Rightarrow (1). The implication (2) \Rightarrow (1) of Theorem 4.11 immediately follows observing that, by virtue of (2), one has $\omega = \mathcal{S}_T^{[AB]+} u_0 \in \mathcal{A}^{[AB]}(T)$, with $u_0 \doteq \mathcal{S}_T^{[AB]-} \omega$. Hence, in Sections 5.4-5.5 we prove only the implication (3) \Rightarrow (2) of Theorem 4.11, in the case of a non critical connection (A, B) . This is the second fundamental block of our proof, which consists in first showing as an intermediate step that (3) \Rightarrow (1), and next in proving that (3) \Rightarrow (2).

- *Part 2.a - (3) \Rightarrow (1) for non critical connections.* Given $\omega \in \mathcal{A}^{\mathbf{L},\mathbf{R}}$ satisfying the condition of Theorem 4.2, we construct explicitly in § 5.4 an AB -entropy admissible solution $u(x, t) \doteq \mathcal{S}_t^{[AB]+} u_0(x)$, $u_0 \in \mathbf{L}^\infty(\mathbb{R})$, such that $u(\cdot, T) = \omega$. The case where $\omega \in \mathcal{A}^{\mathbf{L},\mathbf{R}}$ satisfies the condition of Theorem 4.7, or 4.9 is entirely similar or simpler. The construction of u_0 and u follows a by now standard procedure (see [6], [8]) in regions of $\{x < 0\}$ or of $\{x > 0\}$ that are not influenced by waves reflected or refracted by the interface $x = 0$. Namely, in these regions, one construct the solution u along two type of lines that correspond to its characteristics: genuine characteristics ϑ_y ending at points (y, T) , where $u = \omega(y)$, in the case ω is continuous at y ; compression fronts $\eta_{y,z}$ connecting points $(z, 0)$ and (y, T) , where $u = (f_l')^{-1}(\frac{y-x}{T})$, if $y < 0$, and $u = (f_r')^{-1}(\frac{y-x}{T})$, if $y > 0$, in the case ω is discontinuous at y . A key novel point of the analysis here is the construction of u in two polygonal regions around the interface $x = 0$, which relies on the properties of the *shock-rarefaction/rarefaction-shock wave patterns* established in § 3.4-3.5, which in turn are based on the the duality properties of forward/backward shocks derived in 3.3. Thanks to this construction, one can in particular explicitly produce AB -entropy solutions that attain at time T the profiles of CASES 1, 2, 1B, 2B discussed in Remark 4.4, that are not present in [2] (cfr. Remark 4.12).

- *Part 2.b - (3) \Rightarrow (2) for non critical connections.* Given $\omega \in \mathcal{A}^{\mathbf{L},\mathbf{R}}$ satisfying the conditions of Theorem 4.2, we show in § 5.5 that ω is a fixed point of the backward-forward operator $\mathcal{S}_T^{[AB]^+} \circ \mathcal{S}_T^{[AB]^-}$. The case where $\omega \in \mathcal{A}^{\mathbf{L},\mathbf{R}}$ satisfies the condition of Theorem 4.7, or 4.9 is entirely similar. Building on the analysis pursued in the previous part, in order to prove that $\omega = \mathcal{S}_T^{[AB]^+} \circ \mathcal{S}_T^{[AB]^-} \omega$ it is sufficient to show that, if u_0 is the initial datum of the AB -entropy solution $u(x, t)$ constructed in Part 2.a, then one has $u_0 = \mathcal{S}_T^{[AB]^-} \omega$. This is again achieved exploiting the duality properties of forward/backward shocks derived in 3.3, and the structural properties of the *shock-rarefaction/rarefaction-shock wave patterns* established in § 3.4-3.5.

Part 3. The case of a critical connection (1) \Leftrightarrow (2) \Leftrightarrow (3). In Sections 5.6, 5.7, 5.8 we recover the equivalence of the conditions (1), (2), (3) of Theorem 4.11 in the case of critical connections, invoking the truth of this equivalence for non critical connections established in Parts 1-2. The proof is divided in three steps.

- *Part 3.a - (1) \Leftrightarrow (2) for critical connections.* In § 5.6 we prove the implication (1) \Rightarrow (2), relying on the \mathbf{L}^1 -stability of the maps $(A, B, u_0) \mapsto \mathcal{S}_T^{[AB]^+} u_0$, $(A, B, u_0) \mapsto \mathcal{S}_T^{[AB]^-} u_0$ (see Theorem 2.7-(iv) and Definition 2.13). The reverse implication is immediate as observed in Part 2.
- *Part 3.b - (1) \Rightarrow (3) for critical connections.* In § 5.7 we prove the implication (1) \Rightarrow (3), relying on the \mathbf{L}^1 -stability of the maps $(A, B) \mapsto f_l(u_l)$, $(A, B) \mapsto f_r(u_r)$, where u_l, u_r denote, respectively the left and right states of $u(x, t) \doteq \mathcal{S}_t^{[AB]^+} u_0(x)$ at $x = 0$ (see Corollary 2.9), and on the lower/upper \mathbf{L}^1 -semicontinuity property of solutions to conservation laws with uniformly convex flux (see Lemma C.1 in Appendix C).
- *Part 3.c - (3) \Rightarrow (1) for critical connections.* In § 5.8 we prove the implication (3) \Rightarrow (1) exploiting again the \mathbf{L}^1 -stability of the semigroup map of Theorem 2.7-(iv), and using a perturbation argument. Namely, given $\omega \in \mathcal{A}^{\mathbf{L},\mathbf{R}}$ satisfying the conditions of Theorem 4.7, or 4.9, we construct a sequence $\{\omega_n\}_n$ of perturbations of ω with the property that $\omega_n \xrightarrow{\mathbf{L}^1} \omega$, and $\omega_n \in \mathcal{A}^{[A_n B_n]}(T)$, for a sequence of non critical connections $\{(A_n, B_n)\}_n$. This is another key point of our analysis, since it provides a general explicit procedure to approximate an attainable profile for a critical connection by attainable profiles for non critical connections.

5.2. Part 1.a - (1) \Rightarrow (3) for non critical connections assuming (H). In this Subsection, given an element ω of the set $\mathcal{A}^{[AB]}(T)$ for a noncritical connection (A, B) , assuming that ω satisfies (H), we will show that ω fulfills condition (3) of Theorem 4.11. Recalling (4.8), this is equivalent to show that, letting

$$\mathbf{L} \doteq \mathbf{L}[\omega, f_l], \quad \mathbf{R} \doteq \mathbf{R}[\omega, f_r], \quad (5.1)$$

be quantities defined as in (4.4), there hold:

- 2a-i) If $\mathbf{L} < 0$, $\mathbf{R} > 0$, and if ω satisfies (H), then ω satisfies the conditions of Theorem 4.2;
- 2a-ii) If $\mathbf{L} = 0$, $\mathbf{R} > 0$ or viceversa, and if ω satisfies (H), then ω satisfies the conditions of Theorem 4.7;
- 2a-iii) If $\mathbf{L} = 0$, $\mathbf{R} = 0$, then ω satisfies the conditions of Theorem 4.9.

We will prove 2a-i) in § 5.2.1-5.2.6, while 2a-ii) is proven in § 5.2.7, and 2a-iii) is discussed in § 5.2.8. The further assumption that ω satisfies (H) is needed only to show that ω satisfies (4.12)-(4.13) in case 2a-i), and (4.36), (4.42) in case 2a-ii).

Throughout the subsection we will assume that

$$\omega = \mathcal{S}_T^{[AB]^+} u_0, \quad u_0 \in \mathbf{L}^\infty(\mathbb{R}), \quad (5.2)$$

and we set $u(x, t) \doteq S_t^{[AB]^+} u_0(x)$, $x \in \mathbb{R}$, $t \geq 0$. Moreover, we let $u_l(t), u_r(t)$ denote the left and right traces at $x = 0$ of $u(x, t)$.

5.2.1. ($L < 0$, $R > 0$, proof of (4.18)). The inequalities $\omega(L-) \geq \omega(L+)$, $\omega(R-) \geq \omega(R+)$ are the Lax conditions which are satisfied since u is an entropy admissible solution of the conservation law $u_t + f_l(u)_x = 0$, on $x < 0$, and of $u_t + f_r(u)_x = 0$, on $x > 0$, and the fluxes f_l, f_r are convex.

5.2.2. ($L < 0$, $R > 0$, proof of (4.11)). By definition (4.4), (5.1) of L, R , it follows that backward characteristics for u starting at (x, T) , with $x \in]-\infty, 0[\cup]R, +\infty[$, never crosses the interface $x = 0$. Thus, we recover the Oleinik estimates (4.11) as a classical property of solutions to conservation laws with strictly convex flux, which follows from the fact that genuine characteristics never intersect in the interior of the domain (e.g. see [6, Lemma 3.2]).

5.2.3. ($L < 0$, $R > 0$, first part of the proof of (4.14)). Letting $\mathbf{u}[R, B, f_r]$ be the constant defined as in (3.7) with $f = f_r$, we will prove the implication

$$R \in]0, T \cdot f'(B)[\implies \omega(R+) \leq \mathbf{u}[R, B, f_r], \quad (5.3)$$

assuming

$$R \in]0, T \cdot f'(B)[, \quad \omega(R+) > \mathbf{u}[R, B, f_r], \quad (5.4)$$

and showing that (5.4) leads to a contradiction. To complete the proof of (4.14) we will show in § 5.2.5 that

$$R \in]0, T \cdot f'(B)[\implies \mathbf{u}[R, B, f_r] \leq \omega(R-). \quad (5.5)$$

The proof of the first implication in (4.14) is obtained in entirely similar way.

We divide the proof of (5.3) in two steps. In the first step we construct the leftmost characteristic curve ξ_R that starts on the interface $x = 0$ and reaches the point (R, T) , remaining in the region $\{x > 0\}$, with the property that all maximal backward characteristics starting on ξ_R don't cross the interface $x = 0$. In the second step, thanks to the assumption (5.4) we show that ξ_R is located on the left of the shock curve \mathbf{x} constructed as in § 3.4 that emanates from the interface $x = 0$ and reaches the point (R, T) . This leads to a contradiction in accordance with the characterizing property of $\mathbf{u}[R, B, f_r]$ discussed in Remark 3.3.

Step 1 Consider the map $\xi_R : [\tau_R, T] \rightarrow [0, +\infty[$ defined by setting

$$\begin{aligned} \xi_R(t) &\doteq \inf \{ R > 0 : x - t \cdot f'_r(u(t, x)) \geq 0 \quad \forall x \geq R \}, \quad t \geq 0, \\ \tau_R &\doteq \inf \{ t \in [0, T] : \xi_R(s) > 0 \quad \forall s \in [t, T] \}. \end{aligned} \quad (5.6)$$

Notice that by definition (5.6) we have

$$\xi_R(\tau_R) = 0, \quad \xi_R(T) = R, \quad \xi_R(t) > 0 \quad \forall t \in]\tau_R, T], \quad (5.7)$$

and that ξ_R is a backward characteristic for u starting at (R, T) , so that there holds (e.g. see [20])

$$\xi'_R(t) = \begin{cases} f'_r(u(\xi_R(t) \pm, t)) & \text{if } u(\xi_R(t)-, t) = u(\xi_R(t)+, t), \\ \lambda_r(u(\xi_R(t)-, t), u(\xi_R(t)+, t)) & \text{if } u(\xi_R(t)-, t) \neq u(\xi_R(t)+, t), \end{cases} \quad (5.8)$$

where

$$\lambda_r(u, v) \doteq \frac{f_r(v) - f_r(u)}{v - u}, \quad u, v \in \mathbb{R}, \quad u \neq v. \quad (5.9)$$

We shall provide now a lower bound on the slope of $\xi_{\mathbf{R}}$. Let $t_0 \in]\tau_{\mathbf{R}}, T]$, and observe that by definition (5.6) it follows that the minimal backward characteristic starting at $(\xi_{\mathbf{R}}(t_0), t_0)$ must cross the interface $x = 0$ at some non-negative time. Since such a characteristic is genuine and has slope $f'_r(u(\xi_{\mathbf{R}}(t_0)-, t_0)) \geq 0$, and because of the AB -entropy condition (2.13), it follows that $f_r(u(\xi_{\mathbf{R}}(t_0)-, t_0)) \geq f_r(B)$ and $u(\xi_{\mathbf{R}}(t_0)-, t_0) \geq \theta_r$. Hence, there holds

$$u(\xi_{\mathbf{R}}(t_0)-, t_0) \geq B. \quad (5.10)$$

On the other hand, by definition (5.6) we have

$$f'_r(u(\xi_{\mathbf{R}}(t_0)+, t_0)) \leq \xi_{\mathbf{R}}(t_0)/t_0. \quad (5.11)$$

Thus, letting $\vartheta_{\xi_{\mathbf{R}}(t_0),+}$ denote the maximal backward characteristic starting at $(\xi_{\mathbf{R}}(t_0), t_0)$, because of (5.11) there holds

$$\vartheta_{\xi_{\mathbf{R}}(t_0),+}(0) = \xi_{\mathbf{R}}(t_0) - t_0 \cdot f'_r(u(\xi_{\mathbf{R}}(t_0)+, t_0)) \geq 0, \quad (5.12)$$

and (5.7) implies

$$\vartheta_{\xi_{\mathbf{R}}(t_0),+}(t) > 0 \quad \forall t \in]0, t_0]. \quad (5.13)$$

Moreover, observe that by the properties of backward characteristics, and by definition (5.6), the maximal backward characteristics $\vartheta_{\mathbf{R},+}$ starting at (\mathbf{R}, T) satisfies

$$\xi_{\mathbf{R}}(t) \leq \vartheta_{\mathbf{R},+}(t) \quad \forall t \in [\tau_{\mathbf{R}}, T],$$

and, in particular, one has

$$\xi_{\mathbf{R}}(t_0) \leq \vartheta_{\mathbf{R},+}(t_0). \quad (5.14)$$

Since maximal [genuine?](#) backward characteristics cannot intersect in the interior of the domain, it follows from (5.14) that

$$\xi_{\mathbf{R}}(t_0) - t_0 \cdot f'_r(u(\xi_{\mathbf{R}}(t_0)+, t_0)) = \vartheta_{\xi_{\mathbf{R}}(t_0),+}(0) \leq \vartheta_{\mathbf{R},+}(0) = \mathbf{R} - T \cdot f'_r(\omega(\mathbf{R}+)). \quad (5.15)$$

In turn, (5.15) yields

$$\xi_{\mathbf{R}}(t) - \mathbf{R} + T \cdot f'_r(\omega(\mathbf{R}+)) \leq t_0 \cdot f'_r(u(\xi_{\mathbf{R}}(t_0)+, t_0)). \quad (5.16)$$

Moreover, one has

$$\frac{\xi_{\mathbf{R}}(t_0) - \vartheta_{\mathbf{R},+}(0)}{t_0} \leq \vartheta'_{\mathbf{R},+} = f'_r(\omega(\mathbf{R}+)). \quad (5.17)$$

Since the definition (4.4) of \mathbf{R} and (5.4) imply $f'_r(\omega(\mathbf{R}+)) \leq \mathbf{R}/T < f'_r(B)$, we deduce from (5.17) that

$$\frac{\xi_{\mathbf{R}}(t_0) - \mathbf{R} + T \cdot f'_r(\omega(\mathbf{R}+))}{t_0} < f'_r(B). \quad (5.18)$$

By the monotonicity of f'_r , in turn the estimates (5.16), (5.18) yield

$$\begin{aligned} (f'_r)^{-1} \left(\frac{\xi_{\mathbf{R}}(t_0) - \mathbf{R} + T \cdot f'_r(\omega(\mathbf{R}+))}{t_0} \right) &\leq u(\xi_{\mathbf{R}}(t_0)+, t_0), \\ (f'_r)^{-1} \left(\frac{\xi_{\mathbf{R}}(t_0) - \mathbf{R} + T \cdot f'_r(\omega(\mathbf{R}+))}{t_0} \right) &< B. \end{aligned} \quad (5.19)$$

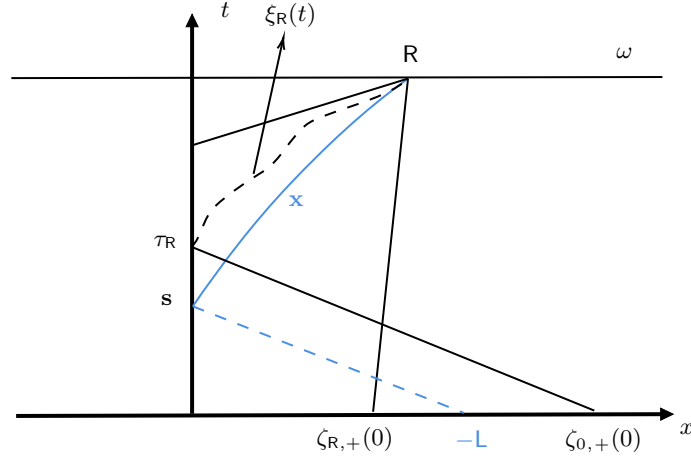

FIGURE 14. Illustration of the proof in § 5.2.3. The black lines are characteristics of the solution u , that cross inside the domain and therefore lead to a contradiction. The blue lines are the comparison curves.

Therefore, recalling (5.8), (5.9), and because of the convexity of f_r , we derive from (5.4), (5.10), (5.19), that

$$\xi'_R(t_0) > \lambda_r \left((f'_r)^{-1} \left(\frac{\xi_R(t_0) - R + T \cdot f'_r(\mathbf{u}[R, B, f_r])}{t_0} \right), B \right) \quad \forall t_0 \in]\tau_R, T]. \quad (5.20)$$

Step 2 (Comparison with an extremal shock). Let $\mathbf{y}[R, B, f_r](\cdot)$ be the function defined in § 3.1 with $f = f_r$, set

$$L \doteq \mathbf{y}[R, B, f_r](T), \quad (5.21)$$

and consider the function

$$\mathbf{x}[L, \bar{B}, f_r](t), \quad t \in [s[L, \bar{B}, f_r], T], \quad (5.22)$$

defined as in § 3.2, with $A = \bar{B}$ (\bar{B} as in (2.16)), and $f = f_r$. By definition (3.10), and applying Lemma 3.1, there holds

$$\mathbf{x}[L, \bar{B}, f_r](s[L, \bar{B}, f_r]) = 0, \quad \mathbf{x}[L, \bar{B}, f_r](T) = R, \quad (5.23)$$

and

$$\frac{d}{dt} \mathbf{x}[L, \bar{B}, f_r](t) = \lambda_r \left((f'_r)^{-1} \left(\frac{\mathbf{x}[L, \bar{B}, f_r](t) + L}{t} \right), B \right), \quad t \in [s[L, \bar{B}, f_r], T]. \quad (5.24)$$

Moreover, because of (3.7), (5.21), we have

$$L = T \cdot f'_r(\mathbf{u}[R, B, f_r]) - R. \quad (5.25)$$

Then, by virtue of (5.20), (5.24), a comparison argument yields

$$\xi_R(t) < \mathbf{x}[L, \bar{B}, f_r](t), \quad \forall t \in [\max\{\tau_R, s[L, \bar{B}, f_r]\}, T]. \quad (5.26)$$

Notice that, if $s[L, \bar{B}, f_r] \geq \tau_R$, then because of (5.23), (5.26), and since $\xi_R(t) \geq 0$, we find the contradiction $0 \leq \xi_R(s[L, \bar{B}, f_r]) < 0$. Hence it must be

$$s[L, \bar{B}, f_r] < \tau_R. \quad (5.27)$$

Next, observe that by definition (5.6) and because of (5.7), we have $u(0+, \tau_R) \leq \theta_r$. Thus, by virtue of the AB -entropy condition (2.13), it follows that $u(0+, \tau_R) \leq \bar{B}$. Then, letting $\zeta_{0,+} : [0, \tau_R] \rightarrow [0, +\infty[$ denote the maximal backward characteristic starting at $(0, \tau_R)$, one has

$$\zeta_{0,+}(0) = -\tau_R \cdot f'_r(u(0+, \tau_R)) \geq -\tau_R \cdot f'_r(\bar{B}). \quad (5.28)$$

On the other hand, by virtue of (5.4), (5.21), (5.27), and recalling the definitions (3.7), (3.9) of $\mathbf{u}[R, B, f_r]$, $\mathbf{s}[L, \bar{B}, f_r]$, we find that the maximal backward characteristic $\vartheta_{R,+} : [0, T] \rightarrow [0, +\infty[$ from (R, T) satisfies

$$\begin{aligned} \vartheta_{R,+}(0) &= R - T \cdot f'_r(\omega(R+)) < R - T \cdot f'_r(\mathbf{u}[R, B, f_r]) \\ &= -\mathbf{y}[R, B, f_r](T) \\ &= -\mathbf{s}[L, \bar{B}, f_r] \cdot f'_r(\bar{B}) \\ &< -\tau_R \cdot f'_r(\bar{B}). \end{aligned} \quad (5.29)$$

Thus, we deduce from (5.28)-(5.29) that

$$\vartheta_{R,+}(0) < \zeta_{0,+}(0), \quad (5.30)$$

while (5.14) yield

$$\vartheta_{R,+}(\tau_R) > 0 = \zeta_{0,+}(\tau_R). \quad (5.31)$$

The inequalities (5.30)-(5.31) imply that the genuine characteristics $\zeta_{0,+}, \vartheta_{R,+}$ intersect each other in the interior of the domain, which gives a contradiction and thus completes the proof of the implication (5.3).

5.2.4. ($L < 0, R > 0$, proof of (4.16)-(4.17)). We will prove only the implication (4.17), the proof of (4.16) being entirely similar. Let $\tilde{L} \doteq \tilde{L}[\omega, f_l, f_r, A, B]$ be the constant in (4.6), and assume that

$$R \in]0, T \cdot f'_r(B)[, \quad L < \tilde{L}. \quad (5.32)$$

Step 1. (proof of: $\omega(x) \leq A$ in $]L, 0[$).

By definition (4.4), (5.1) of L , it follows that backward genuine characteristics starting at points (x, T) , with $x \in]L, 0[$ of continuity for ω , must cross the interface $x = 0$ at some non-negative time. Since such characteristics have slope $f'_l(\omega(x)) \leq 0$, and because of the AB -entropy condition (2.13), it follows that $f_l(\omega(x)) \geq f_l(A)$ and $\omega(x) \leq \theta_l$ at any point $x \in]L, 0[$ of continuity for ω . Hence, there holds $\omega(\pm x) \leq A$ for all $x \in]L, 0[$.

Step 2. (proof of: $\omega(x) = A$ in $]L, 0[$).

In a similar way to (5.6), consider the map $\xi_L : [\tau_L, T] \rightarrow]-\infty, 0[$ defined symmetrically by setting

$$\begin{aligned} \xi_L(t) &\doteq \sup \{L < 0 : x - t \cdot f'_l(u(t, x)) \leq 0 \quad \forall x \leq L\}, \quad t \geq 0, \\ \tau_L &\doteq \inf \{t \in [0, T] : \xi_L(s) < 0 \quad \forall s \in [t, T]\}. \end{aligned} \quad (5.33)$$

Notice that by definition (5.33) we have

$$\xi_L(\tau_L) = 0, \quad \xi_L(T) = L, \quad \xi_L(t) < 0 \quad \forall t \in]\tau_L, T].$$

We claim that

$$\tau_L \leq \tau_R \quad \implies \quad \tau_R \leq \tau[R, B, f_r], \quad (5.34)$$

where $\tau[\mathbf{R}, B, f_r]$ is the constant defined as in (3.32), with $f = f_r$. We will prove the implication (5.34) with similar arguments to the proof of (4.14) in § 5.2.3, assuming

$$\tau_{\mathbf{L}} \leq \tau_{\mathbf{R}}, \quad \tau_{\mathbf{R}} > \tau[\mathbf{R}, B, f_r], \quad (5.35)$$

and showing that (5.35) lead to a contradiction.

Since $\tau_{\mathbf{L}} \leq \tau_{\mathbf{R}}$, by definitions (5.6), (5.33), and by virtue of the AB -entropy condition (2.13), it follows

$$(u_l(t), u_r(t)) = (A, B) \quad \forall t \in]\tau_{\mathbf{R}}, T], \quad (5.36)$$

which in turn implies

$$u(\xi_{\mathbf{R}}(t)-, t) = B \quad \forall t \in]\tau_{\mathbf{R}}, T]. \quad (5.37)$$

Let $\zeta_{0,+}$, $\vartheta_{\xi_{\mathbf{R}}(t),+}$, be the maximal backward characteristics starting at $(0, \tau_{\mathbf{R}})$, and at $(\xi_{\mathbf{R}}(t), t)$, $t \in]\tau_{\mathbf{R}}, T]$, respectively. Relying on (5.12), (5.28), and since maximal backward characteristics cannot intersect in the interior of the domain, we find

$$-\tau_{\mathbf{R}} \cdot f'_r(\overline{B}) \leq \zeta_{0,+}(0) \leq \vartheta_{\xi_{\mathbf{R}}(t),+}(0) = \xi_{\mathbf{R}}(t) - t \cdot f'_r(u(\xi_{\mathbf{R}}(t)+, t)). \quad (5.38)$$

In turn, (5.38) together with (5.35), yields

$$t \cdot f'_r(u(\xi_{\mathbf{R}}(t)+, t)) \leq \xi_{\mathbf{R}}(t) + \tau[\mathbf{R}, B, f_r] \cdot f'_r(\overline{B}) \quad \forall t \in]\tau_{\mathbf{R}}, T], \quad (5.39)$$

since $f'_r(\overline{B}) < 0$. By the monotonicity of f'_r we deduce from (5.39) that

$$u(\xi_{\mathbf{R}}(t)+, t) \leq (f'_r)^{-1} \left(\frac{\xi_{\mathbf{R}}(t) + \tau[\mathbf{R}, B, f_r] \cdot f'_r(\overline{B})}{t} \right). \quad (5.40)$$

Therefore, recalling (5.8), (5.9), and because of the convexity of f_r , we derive from (5.37), (5.40) that

$$\xi'_{\mathbf{R}}(t) \leq \lambda_r \left((f'_r)^{-1} \left(\frac{\xi_{\mathbf{R}}(t) + \tau[\mathbf{R}, B, f_r] \cdot f'_r(\overline{B})}{t} \right), B \right) \quad \forall t \in]\tau_{\mathbf{R}}, T]. \quad (5.41)$$

On the other hand, letting $\mathbf{x}[\mathbf{L}, \overline{B}, f_r](\cdot)$ be the function defined in § 3.2, with \mathbf{L} as in (5.21), $A = \overline{B}$, and $f = f_r$, there hold (5.23), (5.24). Moreover, because of (3.32), (5.21), we have

$$\mathbf{L} = \tau[\mathbf{R}, B, f_r] \cdot f'_r(\overline{B}), \quad \mathbf{s}[\mathbf{L}, \overline{B}, f_r] = \tau[\mathbf{R}, B, f_r]. \quad (5.42)$$

Then, by virtue of (5.7), (5.41), and because of (5.23), (5.24), (5.35), (5.42), with a comparison argument we deduce

$$\xi_{\mathbf{R}}(t) \geq \mathbf{x}[\mathbf{L}, \overline{B}, f_r](t) \quad \forall t \in [\tau_{\mathbf{R}}, T]. \quad (5.43)$$

But (5.43), together with (5.7), (5.35), (5.42), and recalling (3.10), implies

$$0 = \xi_{\mathbf{R}}(\tau_{\mathbf{R}}) \geq \mathbf{x}[\mathbf{L}, \overline{B}, f_r](\tau_{\mathbf{R}}) > \mathbf{x}[\mathbf{L}, \overline{B}, f_r](\tau[\mathbf{R}, B, f_r]) = 0, \quad (5.44)$$

which gives a contradiction, proving the claim (5.34).

Relying on the implication (5.34), we show now that $\omega(x) = A$ in $]\tilde{\mathbf{L}}, 0[$, considering two cases:
 CASE 1: $\tau_{\mathbf{R}} < \tau_{\mathbf{L}}$. Then, by definitions (5.6), (5.33), and by virtue of the AB -entropy condition (2.13), it follows

$$(u_l(t), u_r(t)) = (A, B) \quad \forall t \in]\tau_{\mathbf{L}}, T]. \quad (5.45)$$

Observe that the maximal backward characteristic $\vartheta_{L,+}$ starting at (L, T) crosses the interface $x = 0$ at time $T - L/f'_l(\omega(L+))$. Since ξ_L is a backward characteristic starting at the same point (L, T) and crossing the interface $x = 0$ at time τ_L , one has $\tau_L \leq T - L/f'_l(\omega(L+))$. This implies that the backward genuine characteristics from points (x, T) , $x \in]L, 0[$, impact the interface $x = 0$ at times $t_x \geq T - L/f'_l(\omega(L+)) \geq \tau_L$. Since the value of the solution u is constant along genuine characteristics, we deduce from (5.45) that $\omega(x) = A$ for all $x \in]L, 0[$. Hence, by (5.32) in particular it follows that $\omega(x) = A$ for all $x \in]\tilde{L}, 0[$.

CASE 2: $\tau_L \leq \tau_R$. Then, because of (5.34) we have $\tau_R \leq \tau[R, B, f_r]$. Observe that by Step 1 we have $\omega(x) \leq A$ for all $x \in]L, 0[$. Relying on the monotonicity of f'_l , this implies that the backward genuine characteristics starting from points (x, T) , $x \in]L, 0[$, impacts the interface $x = 0$ at times

$$\tau(x) \doteq T - \frac{x}{f'_l(\omega(x))} \geq T - \frac{x}{f'_l(A)}. \quad (5.46)$$

On the other hand, recalling definitions (4.6), (5.1), we have

$$T - \frac{x}{f'_l(A)} \geq T - \frac{(T - \tau[R, B, f_r]) \cdot f'_l(A)}{f'_l(A)} = \tau[R, B, f_r] \geq \tau_R, \quad (5.47)$$

for all $x \in]\tilde{L}, 0[$. Combining (5.46), (5.47), we deduce that the backward genuine characteristics starting from points (x, T) , $x \in]\tilde{L}, 0[$, cross the interface $x = 0$ at times $\tau(x) \geq \tau_R$. Hence, relying again on the property that the solution u is constant along genuine characteristics, we infer from (5.36) that $\omega(x) = A$ for all $x \in]\tilde{L}, 0[$ also in this case, thus completing the proof of Step 2.

Step 3. (proof of: $\omega(\tilde{L}-) = A$).

We know by Step 1 and Step 2 that $\omega(\tilde{L}-) \leq A$ and $\omega(\tilde{L}+) = A$. On the other hand the Lax entropy condition (see § 5.2.1) implies $\omega(\tilde{L}-) \geq \omega(\tilde{L}+) = A$. Therefore one has $A \geq \omega(\tilde{L}-) \geq \omega(\tilde{L}+) = A$ which yields $\omega(\tilde{L}-) = A$. This concludes the proof of (4.17).

5.2.5. ($L < 0$, $R > 0$, proof of (4.15) and completion of the proof of (4.14)). We will prove only the second implication in (4.15), the proof of the first one being entirely symmetric. Assume that

$$[R \in]0, T \cdot f'_r(B)[\text{ and } \tilde{L} \leq L] \quad \text{or} \quad R \geq T \cdot f'_r(B), \quad (5.48)$$

and let τ_L, τ_R be the constants defined in (5.6), (5.33), in connection with the characteristics ξ_L, ξ_R . As observed in Step 2 of § 5.2.4, the fact that ξ_L is a backward characteristic starting at (L, T) and crossing the interface $x = 0$ at time τ_L implies

$$\tau_L \leq \tau_+(L) \doteq T - \frac{L}{f'_l(\omega(L+))}. \quad (5.49)$$

We claim that (5.48) implies

$$\tau_R \leq \tau_+(L). \quad (5.50)$$

Since (5.49) clearly implies (5.50) when $\tau_R \leq \tau_L$, it will be sufficient to prove the claim under the assumption $\tau_L < \tau_R$. Let's consider first the case that

$$R \in]0, T \cdot f'_r(B)[\text{ and } \tilde{L} \leq L. \quad (5.51)$$

Observe that, because of (5.34), $\tau_L < \tau_R$ implies

$$\tau_R \leq \tau[R, B, f_r]. \quad (5.52)$$

Moreover, by Step 1 of § 5.2.4, one has $\omega(L+) \leq A$. Therefore, recalling the definition (4.6), and because of the monotonicity of f'_l , we deduce from $\tilde{L} \leq L$ that

$$(T - \tau[R, B, f_r]) \cdot f'_l(\omega(L+)) \leq L, \quad (5.53)$$

which, together with (5.52), yields (5.50), under the assumption (5.51). Next, consider the case that

$$R \geq T \cdot f'_r(B). \quad (5.54)$$

Observe that by the analogous argument of Step 1 of § 5.2.4 for (4.16), one has $\omega(R-) \geq B$. Moreover, if $\omega(R-) = B$, by definition (4.4) of R it follows that $f'_r(B) \geq R/T$, which together with (5.54), implies $f'_r(B) = R/T$. In turn, $f'_r(B) = R/T$ implies that the minimal characteristics starting at (R, T) reaches the interface $x = 0$ at time $t = 0$, and by definition (5.6), it coincides with ξ_R . Therefore, one has $\tau_R = 0$, which proves (5.50). Hence, it remains to consider the case (5.54) when $\omega(R-) > B$. Notice that, if

$$\frac{L}{f'_l(\omega(L+))} > \frac{R}{f'_r(\omega(R-))}, \quad (5.55)$$

it follows that the minimal backward characteristic $\vartheta_{R,-}$ from (R, T) crosses the interface $x = 0$ at a time

$$\tau_-(R) \doteq T - \frac{R}{f'_r(\omega(R-))} \quad (5.56)$$

strictly greater than the time $\tau_+(L)$ at which the maximal backward characteristic $\vartheta_{L,+}$ from (L, T) crosses the interface $x = 0$. On the other hand, since $\vartheta_{R,-}$ is a genuine characteristic, it follows that $u_r(\tau_-(R)) = \omega(R-) > B$. Because of the AB -entropy condition (2.13) this implies that $u_l(\tau_-(R)) > \theta_l$. Thus we can trace the minimal backward characteristic starting at $(0, \tau_-(R))$ and lying in $\{x < 0\}$, which has slope $f'_l(u_l(\tau_-(R))) > 0$, and hence it will intersect the characteristic $\vartheta_{L,+}$ at a positive time $t^* \geq \tau_+(L)$, giving a contradiction. Therefore, $\omega(R-) > B$ implies

$$\frac{L}{f'_l(\omega(L+))} \leq \frac{R}{f'_r(\omega(R-))}. \quad (5.57)$$

On the other hand, since ξ_R is a backward characteristic starting at (R, T) and crossing the interface $x = 0$ at time τ_R , there holds

$$\tau_R \leq \tau_-(R). \quad (5.58)$$

Hence, (5.56), (5.57), (5.58) together yield (5.50). This completes the proof of the Claim that (5.48) implies (5.50). Then, by definitions (5.6), (5.33), relying on (5.49), (5.50), and by virtue of the AB -entropy condition (2.13), we find that

$$(u_l(t), u_r(t)) = (A, B) \quad \forall t \in]\tau_+(L), T]. \quad (5.59)$$

Since backward genuine characteristics starting from points (x, T) , $x \in]L, 0[$, cross the interface $x = 0$ at times $t_x \geq \tau_+(L)$, we infer from (5.59) that $\omega(x) = A$ for all $x \in]L, 0[$. This concludes the proof of the second implication in (4.15).

Concerning (4.14), we prove now the implication (5.5). To this end observe that, because of (4.15) and (4.16) (established in § 5.2.4), we have

$$R \in]0, T \cdot f'(B)[\implies \omega(x) \geq B \quad \forall x \in]0, R[,$$

and hence

$$R \in]0, T \cdot f'(B)[\implies \omega(R-) \geq B. \quad (5.60)$$

Thus, relying on (3.8) with $f = f_r$, we deduce (5.5) from (5.60), which completes the proof of the second implication in (4.14).

5.2.6. ($L < 0$, $R > 0$, proof of (4.12)-(4.13)). We will prove only (4.12), the proof of (4.13) being entirely similar. Then, assume that (5.32) holds as in § 5.2.4.

Step 1. For every point $x \in]L, \tilde{L}[$ where ω is continuous, consider the map

$$\vartheta_x(t) \doteq \begin{cases} x - (T - t) \cdot f'_l(\omega(x)), & \text{if } \tau(x) \leq t \leq T, \\ (t - \tau(x)) \cdot f'_r \circ \pi_{r,-}^l(\omega(x)), & \text{if } 0 \leq t < \tau(x), \end{cases} \quad (5.61)$$

with

$$\tau(x) \doteq T - \frac{x}{f'_l(\omega(x))}, \quad (5.62)$$

and set

$$\phi(x) \doteq \vartheta_x(0) = -\tau(x) \cdot f'_r \circ \pi_{r,-}^l(\omega(x)). \quad (5.63)$$

Observe that

$$\begin{aligned} \vartheta_x|_{] \tau(x), T]} & \text{ is a genuine characteristic for } u \text{ in the halfplane } \{x < 0\}, \\ \vartheta_x|_{] 0, \tau(x)[} & \text{ is a genuine characteristic for } u \text{ in the halfplane } \{x > 0\} \text{ if } u_r(\tau(x)) \leq \bar{B}, \end{aligned} \quad (5.64)$$

and thus ϑ_x is a genuine characteristic for u as AB -solution (see Remark 2.4) only in the case where $u_r(\tau(x)) \leq \bar{B}$. Note also that $\tau(x)$ is the impact time of ϑ_x with the interface $x = 0$, and that the function τ has at most countably many discontinuity points as ω . Since genuine characteristics cannot intersect in the interior of the domain, it follows that the right continuous extension of τ is a nondecreasing map. On the other hand, because we are assuming that ω satisfies (H) and that (A, B) is a non critical connection, we know by Proposition B.3 in Appendix B that no pair of genuine characteristics can meet together on the interface $x = 0$. Hence, we deduce that the right continuous extension of the map τ is actually increasing on $]L, \tilde{L}[$.

We will next show that the right continuous extension of the map ϕ is nondecreasing on $]L, \tilde{L}[$.

Step 2. Consider two points $L < x_1 < x_2 < \tilde{L}$ of continuity for ω . By Step 1 we know that $\tau(x_1) < \tau(x_2)$. Moreover, by (4.17) (established in § 5.2.4) we have $\omega(x) \leq A$ for all $x \in]L, \tilde{L}[$. Then, we shall provide a proof of

$$\phi(x_1) \leq \phi(x_2) \quad (5.65)$$

considering different cases according to the fact that $\omega(x_i) = A$ or $\omega(x_i) < A$, $i = 1, 2$.

CASE 1: $\omega(x_i) < A$, $i = 1, 2$. Since u is constant along genuine characteristics, and because of the AB -entropy condition (2.13), it follows that $u_r(\tau(x_i)) = \pi_{r,-}^l(\omega(x_i)) < \bar{B}$, $i = 1, 2$. Therefore, by (5.64) $\vartheta_{x_i}|_{] 0, \tau(x_i)[}$, $i = 1, 2$, are genuine characteristics in the half plane $\{x > 0\}$ starting at $(0, \tau(x_i))$, which cannot intersect at positive times. This implies $\phi(x_1) = \vartheta_{x_1}(0) \leq \vartheta_{x_2}(0) = \phi(x_2)$.

CASE 2: $\omega(x_i) = A$, $i = 1, 2$. By definition (5.61) we know that $\vartheta_{x_i}|_{] 0, \tau(x_i)[}$, $i = 1, 2$, are parallel lines (possibly not characteristics for u) with slope $f'_r(\pi_{r,-}^l(A)) = f'_r(\bar{B})$, starting at $(0, \tau(x_i))$. Hence, $\tau(x_1) < \tau(x_2)$ implies $\phi(x_1) = \vartheta_{x_1}(0) < \vartheta_{x_2}(0) = \phi(x_2)$.

CASE 3: $\omega(x_1) = A$, $\omega(x_2) < A$. Notice that, by the monotonicity of f'_l, f'_r , the map

$$] - \infty, (f'_l)^{-1}(x_1/T)] \ni u \mapsto - \left(T - \frac{x_1}{f'_l(u)} \right) \cdot f'_r \circ \pi_{r,-}^l(u)$$

is decreasing. Then we have

$$\begin{aligned} \phi(x_1) & \leq - \left(T - \frac{x_1}{f'_l(\omega(x_2))} \right) \cdot f'_r \circ \pi_{r,-}^l(\omega(x_2)) \\ & \leq - \left(T - \frac{x_2}{f'_l(\omega(x_2))} \right) \cdot f'_r \circ \pi_{r,-}^l(\omega(x_2)) = \phi(x_2). \end{aligned} \quad (5.66)$$

CASE 4: $\omega(x_2) = A$, $\omega(x_1) < A$. Since $\omega(x_2) = A$, it follows with the same arguments as above that $u_l(\tau(x_2)) = A$ and that either $u_r(\tau(x_2)) = \overline{B}$ or $u_r(\tau(x_2)) = B$. In the first case, because of (5.64) one can proceed as in Case 1 to deduce that $\phi(x_1) \leq \phi(x_2)$. Then, assume $u_r(\tau(x_2)) = B$, and set (see Figure 15)

$$\bar{t} \doteq \inf \left\{ t \leq \tau(x_2) \mid (u_l(s), u_r(s)) = (A, B) \quad \forall s \in [t, \tau(x_2)] \right\}. \quad (5.67)$$

Notice that since $\tau(x_1) < \tau(x_2)$ and because $u_l(\tau(x_1)) < A$ implies $u_r(\tau(x_1)) < \overline{B}$, it follows that $\bar{t} \in]\tau(x_1), \tau(x_2)[$. We claim that it must hold

$$u_r(\bar{t}) = \overline{B}. \quad (5.68)$$

Towards a proof of (5.68), notice first that, since $\omega(x) \leq A$ for all $x \in]\mathbf{L}, \tilde{\mathbf{L}}[$, it follows that $u_l(t) \leq A$ for all $t \in [\tau(x_1), \tau(x_2)]$. Because of the AB -entropy condition (2.13) this implies that $u_r(t) \leq \overline{B}$ for all $t \in [\tau(x_1), \tau(x_2)]$. Hence, in particular we have

$$u_r(\bar{t}) \leq \overline{B}. \quad (5.69)$$

Then, consider the blow ups

$$u_\rho(x, t) \doteq u(\rho x, \bar{t} + \rho(t - \bar{t})) \quad x \in \mathbb{R}, \quad t \geq 0, \quad (5.70)$$

of u at the point $(0, \bar{t})$, as in the proof of Proposition B.3. When $\rho \downarrow 0$, the blow-ups $u_\rho(\cdot, t)$ converge in \mathbf{L}^1_{loc} , up to a subsequence, to a limiting AB entropy solution $v(\cdot, t)$, for all $t > 0$. Moreover, there holds

$$v(x, \bar{t}) = \begin{cases} u_l(\bar{t}), & \text{if } x < 0, \\ u_r(\bar{t}), & \text{if } x > 0. \end{cases} \quad (5.71)$$

By definitions (5.67), (5.70), letting $u_{p,l}(t), u_{p,r}(t)$ denote the left and right traces at $x = 0$ of $u_p(x, t)$, we have

$$(u_{\rho,l}(t), u_{\rho,r}(t)) = (A, B) \quad \forall t \in]\bar{t}, \bar{t} + \frac{\tau(x_2) - \bar{t}}{\rho}[, \quad (5.72)$$

where $u_{\rho,l}(t), u_{\rho,r}(t)$ denote the left and right traces of $u_\rho(\cdot, t)$ at $x = 0$. Taking the limit as $\rho \downarrow 0$ in (5.72), we deduce that

$$v(0-, t) = A, \quad v(0+, t) = B, \quad \forall t > \bar{t}, \quad (5.73)$$

while (5.69), (5.71) imply

$$v(x, \bar{t}) = u_r(\bar{t}) \leq \overline{B}, \quad \forall x > 0. \quad (5.74)$$

By a direct inspection we find that, if an AB entropy solution of a Riemann problem for (1.1) with initial datum (5.71) at time \bar{t} , enjoys the properties (5.73)-(5.74), then the initial datum on $\{(x, \bar{t}), x > 0\}$ must be $v(x, \bar{t}) = u_r(\bar{t}) = \overline{B}$, thus proving (5.68).

Relying on (5.68) we can now complete the proof of (5.65). Since $u_r(\tau(x_1)) < \overline{B}$, we know by (5.64) that ϑ_{x_1} is a genuine characteristic in the halfplane $\{x > 0\}$ starting at $(0, \tau(x_1))$. On the other hand, because of (5.68), we can trace the maximal backward characteristic from $(0, \bar{t})$ in $\{x > 0\}$, which has slope $f'_r(\overline{B})$ and reaches the x -axis at the point $-\bar{t} \cdot f'_r(\overline{B})$. Such a (genuine) characteristic cannot intersect at a positive time the genuine characteristic ϑ_{x_1} . Therefore, one has

$$\phi(x_1) = \vartheta_{x_1}(0) \leq -\bar{t} \cdot f'_r(\overline{B}). \quad (5.75)$$

Moreover, since $\bar{t} \leq \tau(x_2)$, and because $\pi_{r,-}^l(\omega(x_2)) = \pi_{r,-}^l(A) = \overline{B}$, we deduce

$$-\bar{t} \cdot f'_r(\overline{B}) \leq -\tau(x_2) \cdot f'_r(\overline{B}) = \phi(x_2),$$

which together with (5.75), yields (5.65). This concludes the proof of the nondecreasing monotonicity of ϕ on $]\mathbf{L}, \tilde{\mathbf{L}}[$. Invoking Lemma 4.4 in [6], this is equivalent to the inequality

$$D^+ \omega(x) \leq g[\omega, f_l, f_r](x), \quad \forall x \in]\mathbf{L}, \tilde{\mathbf{L}}[,$$

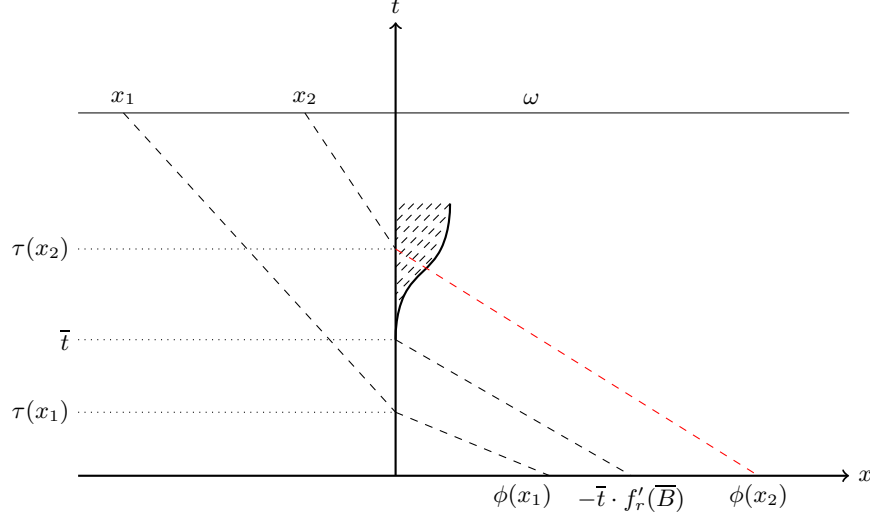

FIGURE 15. The situation described in Case 4.

where g is the function in (4.7). This concludes the proof of (4.12), and thus the proof that ω satisfies conditions (i)-(ii) of Theorem 4.2 is completed.

5.2.7. ($L < 0$, $R = 0$ or viceversa, proof of conditions (i)-(ii), or (i)'-(ii)', of Theorem 4.7). We consider only the case $L < 0$, $R = 0$, the other case $L = 0$, $R > 0$ being symmetrical. The proofs of (4.35), (4.36), (4.38), (4.39), (4.40) in this case, are entirely similar to the proofs of (4.11), (4.12), (4.17), (4.14), (4.18), respectively, in the case $L < 0$, $R > 0$. We provide here only the proof of (4.37), which is the only new constraint arising in the case $L < 0$, $R = 0$, that was not present in the case $L < 0$, $R > 0$. Notice first that by (4.17) (established in § 5.2.4) we know that $\omega(x) \leq A$ for all $x \in]L, 0[$. Hence, since the connection (A, B) is non critical, tracing the backward characteristics (with negative slope) in the half plane $\{x < 0\}$ from any sequence of points (x_n, T) , $x_n \in]L, 0[$, $x_n \uparrow 0$, we deduce that there exists the one-sided limit $u_l(T-)$ and there holds

$$u_l(T-) = \omega(0-) \leq A. \quad (5.76)$$

Then, we will distinguish two cases.

CASE 1: Assume that $u_r(t) \geq B$ for all $t \in]\tau, T[$, for some $\tau < T$. Then, by the AB -entropy condition (2.13), and because of (5.76), we deduce that $\omega(0-) = u_l(T-) = A$. On the other hand, since (A, B) is a non critical connection, by definition (4.4) it follows that $R = 0$ implies $f'_r(\omega(0+)) < 0$. Therefore we have $\omega(0+) \leq \bar{B} = \pi_{r,-}^l(A) = \pi_{r,-}^l(\omega(0-))$, proving (4.37).

CASE 2: Assume that there exist a sequence of times $t_n \uparrow T$ such that $u_r(t_n) \leq \bar{B}$ for all n , and such that $\lim_n u_r(t_n) = u^*$, for some $u^* \leq \bar{B}$. By the AB -entropy condition (2.13) this implies that $u_r(t_n) = \pi_{r,-}^l(u_l(t_n))$ for all n . Therefore, relying on (5.76), we find $u^* = \lim_n \pi_{r,-}^l(u_l(t_n)) = \pi_{r,-}^l(\omega(0-))$. On the other hand we have $\omega(0+) \leq u^*$, since otherwise backward genuine characteristics issuing from points (x_n, T) , $x_n \downarrow 0$, would eventually cross backward genuine characteristics in the half plane $\{x > 0\}$ starting from points $(0, t_n)$. In fact, if $\omega(0+) > u^*$ then we can find points (x_n, T) , $x_n > 0$ (x_n of continuity for ω), and $(0, t_n)$, $t_n < T$ (t_n of continuity for u_r), such that $\omega(x_n) > u_r(t_n)$, which would imply that the backward characteristic starting from (x_n, T) with negative slope $f'_r(\omega(x_n, T))$ intersect the backward characteristic starting from $(0, t_n)$ with slope $f'_r(u_r(t_n)) < f'_r(\omega(x_n, T))$. Therefore it must be $\omega(0+) \leq u^*$, which together with $u^* = \pi_{r,-}^l(\omega(0-))$, yields (4.37).

This concludes the proof of (4.37), and thus the proof that ω satisfies conditions (i)-(ii) (or (i)'-(ii)') of Theorem 4.7 is completed.

5.2.8. ($L = 0, R = 0$, proof of conditions (i)-(ii) of Theorem 4.9). The proofs of (4.51), (4.54), (4.52), are entirely similar to the proofs of (4.11), (4.14), in the case $L < 0, R > 0$, and of (4.37), in the case $L = R = 0$, respectively. Instead, (4.53) can be established with the same arguments of the proof of (4.14) in the case $L < 0, R > 0$, recalling Remark 4.10. This completes the proof that ω satisfies conditions (i)-(ii) of Theorem 4.9.

5.3. **Part 1.b - (1) \Rightarrow (3) for non critical connections without assuming (H).** In this Subsection, given an element ω of the set $\mathcal{A}^{[AB]}(T)$ for a noncritical connection (A, B) , we will show that ω satisfies (H). In view of the analysis in § 5.2, this will imply that ω fulfills condition (3) of Theorem 4.11, thus completing the proof of the implication (1) \Rightarrow (3) of Theorem 4.11.

Then, given $\omega \in \mathcal{A}^{[AB]}(T)$ with

$$\omega = \mathcal{S}_T^{[AB]^+} u_0, \quad u_0 \in \mathbf{L}^\infty(\mathbb{R}), \quad (5.77)$$

set $u(x, t) \doteq \mathcal{S}_t^{[AB]^+} u_0(x)$, $x \in \mathbb{R}$, $t \geq 0$. Next, let $\{u_{n,0}\}_n$ be a sequence of functions in $BV(\mathbb{R})$ such that

$$u_{n,0} \rightarrow u_0 \quad \text{in } \mathbf{L}^1(\mathbb{R}),$$

and define $u_n(x, t) \doteq \mathcal{S}_t^{[AB]^+} u_{n,0}(x)$. Then, by Theorem 2.7-(iii) it follows

$$u_n(\cdot, t) \rightarrow u(\cdot, t) \quad \text{in } \mathbf{L}^1(\mathbb{R}) \quad \forall t \geq 0. \quad (5.78)$$

Since (A, B) is a non critical connection and because the initial data $u_{n,0}$ are in BV , invoking the BV bounds on AB -entropy solutions provided in [25, Lemma 8] (see also [1, Theorem 2.13-(iii)]), we deduce that $u_n(\cdot, t) \in BV(\mathbb{R})$ for all $t > 0$, and for all n . Therefore,

$$u_n(\cdot, t) \in \mathcal{A}^{[AB]}(t), \quad \text{and satisfies (H)} \quad \forall t > 0, \quad \forall n.$$

Hence, relying on the analysis in § 5.2, and recalling (4.8), we know that, setting

$$\mathbf{L}_n(t) \doteq \mathbf{L}[u_n(\cdot, t), f_l], \quad \mathbf{R}_n(t) \doteq \mathbf{R}[u_n(\cdot, t), f_r], \quad (5.79)$$

each $u_n(\cdot, t)$ satisfies the conditions stated in:

- Theorem 4.2 if $\mathbf{L}_n(t) < 0, \mathbf{R}_n(t) > 0$;
- Theorem 4.7 if $\mathbf{L}_n(t) < 0, \mathbf{R}_n(t) = 0$ or viceversa;
- Theorem 4.9 if $\mathbf{L}_n(t) = 0, \mathbf{R}_n(t) = 0$.

Thus, in particular, $u_n(\cdot, t)$ satisfies the Oleinik-type inequalities

$$\begin{aligned} D^+ u_n(x, t) &\leq \frac{1}{t \cdot f_l''(u_n(x, t))} && \text{in }]-\infty, \mathbf{L}_n(t)[, \\ D^+ u_n(x, t) &\leq g[u_n(\cdot, t), f_l, f_r](x) && \text{in }]\mathbf{L}_n(t), 0[, \quad \text{if } \mathbf{L}_n(t) < 0, \\ D^+ u_n(x, t) &\leq h[u_n(\cdot, t), f_l, f_r](x) && \text{in }]0, \mathbf{R}_n(t)[, \quad \text{if } \mathbf{R}_n(t) > 0, \\ D^+ u_n(x, t) &\leq \frac{1}{t \cdot f_r''(u_n(x, t))} && \text{in }]\mathbf{R}_n(t), +\infty[, \end{aligned} \quad (5.80)$$

and the constraints

$$\begin{aligned} u_n(x, t) &\leq A && \forall x \in]\mathbf{L}_n(t), 0[, \\ u_n(x, t) &\geq B && \forall x \in]0, \mathbf{R}_n(t)[, \end{aligned} \quad (5.81)$$

for all $t > 0$. Since (5.81) implies $f'_r(u_n(x, t)) \geq f'_r(B)$ for all $x \in]0, R_n(t)[$, by the monotonicity of f'_r , we find

$$t \cdot f'_r(u_n(x, t)) - x \geq \frac{t \cdot f'_r(B)}{2} \quad \forall x \in \left[0, \min \left\{ R_n(t), \frac{t \cdot f'_r(B)}{2} \right\} \right]. \quad (5.82)$$

Therefore, recalling definition (4.7), setting $\bar{\Lambda} \doteq \sup_{|z| \leq M} \max\{|f'_l(z)|, |f'_r(z)|\}$, with M being a uniform \mathbf{L}^∞ bound for u_n , and letting a be the lower bound on f'_l, f'_r given in (1.4), we deduce from (5.82), that, if

$$R_n(t) \leq \frac{t \cdot f'_r(B)}{2},$$

then for all n there hold

$$h[u_n(\cdot, t), f_l, f_r](x) \leq \frac{\bar{\Lambda}^2}{a f'_r(B)(t \cdot f'_r(u_n(x, t)) - x)} \leq \frac{2}{at} \cdot \left(\frac{\bar{\Lambda}}{f'_r(B)} \right)^2 \quad \forall x \in [0, R_n(t)[, \quad (5.83)$$

while if

$$R_n(t) > \frac{t \cdot f'_r(B)}{2},$$

then for all n there hold

$$h[u_n(\cdot, t), f_l, f_r](x) \leq \begin{cases} \frac{\bar{\Lambda}^2}{a f'_r(B)(t \cdot f'_r(u_n(x, t)) - x)} \leq \frac{2}{at} \cdot \left(\frac{\bar{\Lambda}}{f'_r(B)} \right)^2 & \forall x \in \left[0, \frac{t \cdot f'_r(B)}{2} \right], \\ \frac{\bar{\Lambda}}{x a} \leq \frac{2\bar{\Lambda}}{at \cdot f'_r(B)} & \forall x \in \left[\frac{t \cdot f'_r(B)}{2}, R_n(t) \right]. \end{cases} \quad (5.84)$$

Hence, we derive from (5.80), (5.83), (5.84), the uniform bounds

$$\begin{aligned} D^+ u_n(x, t) &\leq \frac{2\bar{\Lambda}}{at \cdot f'_r(B)} \cdot \max \left\{ 1, \frac{\bar{\Lambda}}{f'_r(B)} \right\} \quad \text{in }]0, R_n(t)[, \quad \text{if } R_n(t) > 0, \\ D^+ u_n(x, t) &\leq \frac{1}{t \cdot a} \quad \text{in }]R_n(t), +\infty[, \end{aligned} \quad (5.85)$$

for all n . Since (A, B) is a non critical connection, the one-sided uniform upper bounds provided by (5.85) yield uniform bounds on the total increasing variation (and hence on the total variation as well) of $u_n(t)$ on bounded subsets of $[0, +\infty[$. In turn, this uniform bounds together with (5.78), by the lower-semicontinuity of the total variation with respect to the \mathbf{L}^1 convergence imply that

$$u(\cdot, t) \in BV_{\text{loc}}([0, +\infty[). \quad (5.86)$$

With the same type of arguments, relying on (5.80), (5.81), we can show that

$$u(\cdot, t) \in BV_{\text{loc}}(]-\infty, 0]). \quad (5.87)$$

Therefore, we deduce from (5.86), (5.87), that

$$u(\cdot, t) \in BV_{\text{loc}}(\mathbb{R}) \quad \forall t > 0, \quad (5.88)$$

which shows that the function ω in (5.77) satisfies condition (H), thus completing the proof of the implication (1) \Rightarrow (3) of Theorem 4.11 in the case of a non critical connection.

5.4. **Part 2.a** - (3) \Rightarrow (1) **for non critical connections.** In this Subsection, given

$$\omega \in \mathcal{A}^{L,R}, \quad L \doteq L[\omega, f_l] < 0, \quad R \doteq R[\omega, f_r] > 0, \quad (5.89)$$

($\mathcal{A}^{L,R}$ being the set in (4.9)), assuming that

$$\omega \text{ satisfies conditions (i)-(ii) of Theorem 4.2,} \quad (5.90)$$

we will show that $\omega \in \mathcal{A}^{AB}(T)$ by explicitly constructing an AB -entropy solution attaining ω at time T . With entirely similar arguments one can show that the same conclusion hold assuming that $\omega \in \mathcal{A}^{L,R}$:

- satisfies the conditions of Theorem 4.7, if $L = 0$, $R > 0$ or viceversa;
- satisfies the conditions of Theorem 4.9, if $L = 0$, $R = 0$.

Then, consider ω satisfying (5.89), (5.90). By Remark 4.4 we can distinguish six cases of pointwise constraints on ω , prescribed by condition (ii) of Theorem 4.2, which depend on the reciprocal positions of the points L , R , and \tilde{L} , \tilde{R} , defined in (4.4)-(4.6). We shall consider here only the CASES 1 and 2 discussed in Remark 4.4. The CASES 1B, 2B are symmetrical to CASES 1, 2, up to a change of variables $x \mapsto -x$, while the CASES 3, 4 are entirely similar or simpler.

Notice that, by Remark 4.4, in CASE 1 there hold (4.28), (4.29), and in particular we shall assume that

$$\omega(R+) < \mathbf{u}[R, B, f_r], \quad (5.91)$$

while in CASE 2 there hold (4.29), (4.30), and we shall assume that (5.91) is verified together with

$$\omega(L-) > \mathbf{v}[L, A, f_l]. \quad (5.92)$$

The cases in which $\omega(R+) = \mathbf{u}[R, B, f_r]$ or $\omega(L-) = \mathbf{v}[L, A, f_l]$ can be treated with entirely similar or simpler arguments. Moreover, in both CASES 1 and 2 we have

$$\tilde{L} > L, \quad \omega(\tilde{L}-) = \omega(\tilde{L}+). \quad (5.93)$$

The construction of the initial datum u_0 so that the corresponding AB -entropy solution solution $u(x, t) \doteq \mathcal{S}_t^{[AB]^+} u_0(x)$ attains the value ω at time T follows a by now standard procedure (see [6], [8]), that we describe in § 5.4.4-5.4.5 below. To this end we first introduce some technical notations in § 5.4.1-5.4.3.

5.4.1. *Characteristics of compression waves.* We introduce a class of curves connecting two points $(z, 0)$, (y, T) , that will be treated as characteristics of compression waves generating a shock at the point (y, T) . In particular, in the case $y < 0 < z$, such curves will be characteristics of a compression wave that starts at time $t = 0$ on the half plane $\{z \geq 0\}$, and generates a shock at time $t = T$ after being refracted at the discontinuity interface. Given any $y < 0$, consider the continuous function

$$]-\infty, (f_l')^{-1}(y/T)] \ni u \mapsto h_y(u) \doteq -\left(T - \frac{y}{f_l'(u)}\right) \cdot f_r' \circ \pi_{r,-}^l(u).$$

Notice that, by definition (4.1) and since f_l', f_r' are increasing functions, it follows that $u \mapsto -(T - y/f_l'(u))$, $u \mapsto f_r' \circ \pi_{r,-}^l(u)$ are decreasing maps, and hence the map h_y is decreasing as well. On the other hand we have $\lim_{u \rightarrow -\infty} h_y(u) = +\infty$, $h_y((f_l')^{-1}(y/T)-) = 0$. Therefore by a continuity and monotonicity argument, it follows that, for every $z > 0$, there exists a unique state $u_{y,z} \leq (f_l')^{-1}(y/T)$, such that

$$h_y(u_{y,z}) = z. \quad (5.94)$$

Moreover, the map $z \mapsto u_{y,z}$, $z > 0$ is continuous. Then, for every pair $y < 0 < z$, we denote by $\eta_{y,z} : [0, T] \mapsto \mathbb{R}$ the polygonal line given by

$$\eta_{y,z}(t) \doteq \begin{cases} y - (T-t) \cdot f'_l(u_{y,z}), & \text{if } \tau(y,z) < t \leq T, \\ (t - \tau(y,z)) \cdot f'_r \circ \pi_{r,-}^l(u_{y,z}), & \text{if } 0 \leq t \leq \tau(y,z), \end{cases} \quad (5.95)$$

where

$$\tau(y,z) \doteq T - \frac{y}{f'_l(u_{y,z})}. \quad (5.96)$$

Instead, for every pair $y, z < 0$, or $y, z > 0$, we denote by $\eta_{y,z} : [0, T] \rightarrow \mathbb{R}$ the segment

$$\eta_{y,z}(t) \doteq y - (T-t) \cdot \frac{(y-z)}{T} \quad \forall 0 \leq t \leq T. \quad (5.97)$$

Notice that, in the case $y < 0 < z$, if we consider a function $u(x, t)$ that assumes the values

$$\begin{aligned} u &= u_{y,z} && \text{on the segment } \eta_{y,z}(t), \tau(y,z) < t \leq T, \\ u &= \pi_{r,-}^l(u_{y,z}) && \text{on the segment } \eta_{y,z}(t), 0 \leq t \leq \tau(y,z), \end{aligned}$$

then the states $u_l = u_{y,z}$, $u_r = \pi_{r,-}^l(u_{y,z})$ satisfy the interface entropy condition (2.13) at time $t = \tau(y, z)$, and $\eta_{y,z}$ enjoys the properties of a (genuine) characteristic for u as an AB -entropy solution (see Remark 2.4). Similar observations hold for $\eta_{y,z}$ in the case $y, z < 0$, considering a function $u(x, t)$ that assumes the value $(f'_l)^{-1}((y-z)/T) = u_{y,z}$ along the segment $\eta_{y,z}$, and in the case $y, z > 0$, considering a function $u(x, t)$ that assumes the value $(f'_r)^{-1}((y-z)/T) = u_{y,z}$ along the segment $\eta_{y,z}$.

5.4.2. Maximal/minimal backward characteristics. We introduce a class of curves with end point (y, T) that will be treated as maximal and minimal backward characteristics starting at (y, T) . For every $y \in]-\infty, \tilde{L}] \cup]\mathbb{R}, +\infty[$, we denote by $\vartheta_{y,\pm} : [0, T] \rightarrow \mathbb{R}$ the segments or polygonal lines

$$\vartheta_{y,\pm}(t) \doteq \begin{cases} y - (T-t) \cdot f'_l(\omega(y\pm)), & \text{if } y < \mathbb{L}, \quad 0 \leq t \leq T, \\ y - (T-t) \cdot f'_l(\omega(y\pm)), & \text{if } \mathbb{L} \leq y \leq \tilde{L}, \quad \tau_{\pm}(y) \leq t \leq T, \\ (t - \tau_{\pm}(y)) \cdot f'_r \circ \pi_{r,-}^l(\omega(y\pm)), & \text{if } \mathbb{L} \leq y \leq \tilde{L}, \quad 0 \leq t < \tau_{\pm}(y), \\ y - (T-t) \cdot f'_r(\omega(y\pm)), & \text{if } y > \mathbb{R}, \quad 0 \leq t \leq T, \end{cases} \quad (5.98)$$

where

$$\tau_{\pm}(y) \doteq T - \frac{y}{f'_l(\omega(y\pm))}. \quad (5.99)$$

We will write $\vartheta_y(t) \doteq \vartheta_{y,\pm}(t)$ for all $t \in [0, T]$, whenever $\omega(y-) = \omega(y+)$. In particular, because of (5.93), we have $\vartheta_{\tilde{L}}(t) \doteq \vartheta_{\tilde{L},\pm}(t)$. Instead, for $y = \mathbb{R}$, we denote by $\vartheta_{\mathbb{R},+} : [0, T] \rightarrow \mathbb{R}$ the segment

$$\vartheta_{\mathbb{R},+}(t) \doteq \mathbb{R} - (T-t) \cdot f'_r(\omega(\mathbb{R}+)) \quad \forall 0 \leq t \leq T. \quad (5.100)$$

Notice that, because of definition (4.4), (5.89), whenever $y \in]-\infty, \mathbb{L}[\cup]\mathbb{R}, +\infty[$, the curves $\vartheta_{y,\pm}$ are segments that never cross the interface $\{x = 0\}$, instead for all $y \in]\mathbb{L}, \tilde{L}[$, $\vartheta_{y,\pm}$ are polygonal lines that are refracted at $\{x = 0\}$. Moreover, at every point of discontinuity $y \in]-\infty, \mathbb{L}[\cup]\mathbb{R}, +\infty[$ of ω , conditions (4.11), (4.12) imply the Lax condition $\omega(y-) > \omega(y+)$, which in turn, by the monotonicity of f'_l, f'_r , implies

$$\vartheta_{y,-}(0) < \vartheta_{y,+}(0) \quad \forall y \in]-\infty, \mathbb{L}[\cup]\mathbb{R}, +\infty[. \quad (5.101)$$

As in § 5.4.1, observe that in the case $\mathbb{L} < y \leq \tilde{L}$, if we consider a function $u(x, t)$ that assumes the values

$$\begin{aligned} u &= \omega(y\pm) && \text{on the segment } \vartheta_{y,\pm}(t), \tau_{\pm}(y) < t \leq T, \\ u &= \pi_{r,-}^l(\omega(y\pm)) && \text{on the segment } \vartheta_{y,\pm}(t), 0 \leq t \leq \tau_{\pm}(y), \end{aligned}$$

consist of the starting points of compression waves with center at the point (L, T) . In the complementary sets of \mathcal{I}_L : $] - \sigma[L, A, f_l] \cdot f_l'(\bar{A}), 0[$ and $]0, (L/f_l'(A) - T) \cdot f_r'(\bar{B})[$, the initial datum will assume the constant values \bar{A} and \bar{B} , respectively. Here $\sigma[L, A, f_l]$ is the constant defined as in § 3.5, with $f = f_l$.

- The set \mathcal{I}_R consists of the starting points of a compression wave that generates a shock at the point (R, T) .
- The set \mathcal{I}_C consists of the starting points of compression waves that generate a shock at points (y, T) , $y \in] - \infty, L[\cup]L, \tilde{L}[\cup]R, +\infty[$. The set \mathcal{I}_C is a disjoint union of at most countably many open intervals of the form

$$\begin{aligned} \mathcal{I}_L^n &=]x_n^-, x_n^+[, & x_n^\pm &= \vartheta_{y_n, \pm}(0), & y_n &\in] - \infty, L[, \\ \mathcal{I}_R^n &=]x_n^-, x_n^+[, & x_n^\pm &= \vartheta_{y_n, \pm}(0), & y_n &\in]R, +\infty[, \\ \tilde{\mathcal{I}}_L^n &=]x_n^-, x_n^+[, & x_n^\pm &= \vartheta_{y_n, \pm}(0), & y_n &\in]L, \tilde{L}[, \end{aligned} \quad (5.103)$$

which are non empty because of (5.101).

- The set $\mathcal{I}_{\mathcal{R}a}$ consists of at most countably many points that are the centers of rarefaction waves originated at time $t = 0$.
- The set $\mathcal{I}_{\mathcal{W}}$ consists of the starting points of all genuine characteristics reaching points (y, T) , $y \in] - \infty, L[\cup]L, \tilde{L}[\cup]R, +\infty[$.

5.4.4. *Construction of AB-entropy solution on two regions with vertexes at (L, T) and at (R, T) .* Consider the two polygonal regions

$$\begin{aligned} \Delta_L &\doteq \left\{ (x, t) \in \mathbb{R} \times [0, T] : \vartheta_{L, -}(t) < x < \vartheta_{L, +}(t) \right\}, \\ \Gamma_R &\doteq \left\{ (x, t) \in \mathbb{R} \times [0, T] : \vartheta_{\tilde{L}}(t) < x < \vartheta_{R, +}(t) \right\}. \end{aligned} \quad (5.104)$$

In the CASE 2 (see Figure 7), letting $\Delta[L, A, f_l]$ be the region defined as in § 3.5, with $f = f_l$, we can express Δ_L as

$$\Delta_L = \Delta[L, A, f_l] \cup \bigcup_{i=1}^4 \Delta_{L,i}, \quad (5.105)$$

where

$$\begin{aligned} \Delta_{L,1} &\doteq \left\{ (x, t) \in] - \infty, 0[\times [0, T] : \vartheta_{L, -}(t) < x \leq L - (T - t) \cdot f_l'(\mathbf{v}[L, A, f_l]) \right\}, \\ \Delta_{L,2} &\doteq \left\{ (x, t) \in] - \infty, 0[\times [0, T] : x \geq (t - \sigma[L, A, f_l]) \cdot f_l'(\bar{A}) \right\}, \\ \Delta_{L,3} &\doteq \left\{ (x, t) \in]0, +\infty[\times [0, T] : x < \eta_{L, x(A, \bar{B})}(t) \right\}, \\ \Delta_{L,4} &\doteq \left\{ (x, t) \in \mathbb{R} \times [0, T] : \eta_{L, x(A, \bar{B})}(t) \leq x < \vartheta_{L, +}(t) \right\}, \end{aligned} \quad (5.106)$$

with $\mathbf{v}[L, A, f_l]$ as in (3.11) taking $f = f_l$, and

$$x(A, \bar{B}) \doteq (L/f_l'(A) - T) \cdot f_r'(\bar{B}) > 0. \quad (5.107)$$

Similarly, in both CASES 1, 2 (see Figures 6-7), letting $\Gamma[R, B, f_r]$, be the region defined as in § 3.4, with $f = f_r$, we can express Γ_R as

$$\Gamma_R = \Gamma[R, B, f_r] \cup \bigcup_{i=1}^3 \Gamma_{R,i}, \quad (5.108)$$

where

$$\begin{aligned}
 \Gamma_{R,1} &\doteq \left\{ (x, t) \in]-\infty, 0] \times [0, T] : \vartheta_{\tilde{\Gamma}}(t) < x \right\}, \\
 \Gamma_{R,2} &\doteq \left\{ (x, t) \in]0, +\infty[\times [0, T] : x \leq R - (T - t) \cdot f'_r(B) \right\}, \\
 \Gamma_{R,3} &\doteq \left\{ (x, t) \in]0, +\infty[\times [0, T] : R - (T - t) \cdot f'_r(\mathbf{u}[R, B, f_r]) \leq x < \vartheta_{R,+}(t) \right\},
 \end{aligned} \tag{5.109}$$

with $\mathbf{u}[R, B, f_l]$ as in (3.7), taking $f = f_r$.

Now, consider the function $u_L : \Delta_L \rightarrow \mathbb{R}$ defined by setting for every $(x, t) \in \Delta_L$:
in CASE 1:

$$u_L(x, t) = \begin{cases} (f'_l)^{-1}\left(\frac{L-x}{T-t}\right), & \text{if } x \leq 0, \\ \pi_{r,-}^L(u_{L,z}), & \text{if } x = \eta_{L,z}(t), \text{ for some } z > 0, \end{cases} \tag{5.110}$$

where $u_{L,z}$ is defined as in § 5.4.1, with $y = L$;

in CASE 2:

$$u_L(x, t) = \begin{cases} (f'_l)^{-1}\left(\frac{L-x}{T-t}\right), & \text{if } (x, t) \in \Delta_{L,1} \cup \Delta_{L,4}, \quad x \leq 0, \\ \pi_{r,-}^L(u_{L,z}), & \text{if } (x, t) \in \Delta_{L,4}, \quad x = \eta_{L,z}(t), \text{ for some } z > 0 \\ v[L, A, f_l](x, t), & \text{if } (x, t) \in \Delta[L, A, f_l], \\ \overline{A}, & \text{if } (x, t) \in \Delta_{L,2}, \\ \overline{B}, & \text{if } (x, t) \in \Delta_{L,3}. \end{cases} \tag{5.111}$$

where $v[L, A, f_l]$ denotes the function defined in (3.42), with $f = f_l$.

By construction, because of (1.4), and relying on the analysis in 3.5, it follows that in both CASES 1, 2, the function $u_L(x, t)$:

- is locally Lipschitz continuous on $(\Delta_L \setminus \overline{\Delta[L, A, f_l]}) \cap ((\mathbb{R} \setminus \{0\}) \times]0, T[)$, and it is continuous on the boundary $\partial\Delta[L, A, f_l] \setminus (\{0\} \times]0, T[)$;
- is a classical solution of $u_t + f_l(u)_x = 0$ on $(\Delta_L \setminus \overline{\Delta[L, A, f_l]}) \cap (]-\infty, 0[\times]0, T[)$, and of $u_t + f_r(u)_x = 0$ on $\Delta_L \cap (]0, +\infty[\times]0, T[)$;
- is an entropy weak solution of $u_t + f_l(u)_x = 0$ on $\Delta[L, A, f_l]$;
- satisfies the interface entropy condition (2.13) at any point $(0, t)$, $t \leq \tau_+(L)$.

Therefore, by Definition 2.2, we deduce that u_L is an AB -entropy solution of (1.1) on Δ_L .

Next, consider (for both CASES 1, 2) the function $u_R : \Gamma_R \rightarrow \mathbb{R}$ defined by setting for every $(x, t) \in \Gamma_R$:

$$u_R(x, t) = \begin{cases} A, & \text{if } (x, t) \in \Gamma_{R,1}, \\ B, & \text{if } (x, t) \in \Gamma_{R,2}, \\ u[R, A, f_r](x, t), & \text{if } (x, t) \in \Gamma[R, B, f_r], \\ (f'_r)^{-1}\left(\frac{R-x}{T-t}\right), & \text{if } (x, t) \in \Gamma_{R,3}, \end{cases} \tag{5.112}$$

where $u[R, A, f_r]$ denotes the function defined in (3.35), with $f = f_r$. By construction and relying on the analysis in § 3.4, we deduce as above that u_R provides an AB -entropy solution of (1.1) on Γ_R . Moreover, because of (4.28), (4.29), (4.30), we have

$$u_R(x, T) = \omega(x) \quad \forall x \in]\tilde{L}, R[. \tag{5.113}$$

5.4.5. *Construction of AB-entropy solution on whole $\mathbb{R} \times [0, T]$.* Observing that, because of (5.102), (5.104), we have $\Delta_L \cap \{x = 0\} = \mathcal{I}_L$, $\Gamma_R \cap \{x = 0\} = \mathcal{I}_R$, we define the initial datum on $\mathcal{I}_L \cup \mathcal{I}_R$ as

$$u_0(x) = \begin{cases} u_L(x, 0) & \text{if } x \in \mathcal{I}_L, \\ u_R(x, 0) & \text{if } x \in \mathcal{I}_R. \end{cases} \quad (5.114)$$

where, in CASE 1,

$$u_L(x, 0) = \begin{cases} (f_l')^{-1}\left(\frac{L-x}{T}\right), & \text{if } x \in \mathcal{I}_L, \ x \leq 0, \\ \pi_{r,-}^l(u_{L,z}), & \text{if } x \in \mathcal{I}_L, \ x = \eta_{L,z}(0), \text{ for some } z > 0, \end{cases} \quad (5.115)$$

while, in CASE 2,

$$u_L(x, 0) = \begin{cases} (f_l')^{-1}\left(\frac{L-x}{T}\right), & \text{if } x \in]\vartheta_{L,-}(0), L - T \cdot f_l'(\mathbf{v}[L, A, f_l])[, \\ \bar{A}, & \text{if } x \in]L - T \cdot f_l'(\mathbf{v}[L, A, f_l]), 0[, \\ \bar{B}, & \text{if } x \in]0, \eta_{L,x(A,\bar{B})}(0)[, \\ \pi_{r,-}^l(u_{L,z}), & \text{if } x \in [\eta_{L,x(A,\bar{B})}(0), \vartheta_{L,+}(0)[, \ x = \eta_{L,z}(t), \text{ for some } z > 0, \end{cases} \quad (5.116)$$

and, in both CASES 1, 2,

$$u_R(x, 0) = (f_r')^{-1}\left(\frac{R-x}{T}\right), \quad \text{if } x \in \mathcal{I}_R. \quad (5.117)$$

In view of the observations in § 5.4.1-5.4.2, the construction of the AB entropy solution on $(\mathbb{R} \times [0, T]) \setminus (\Delta_L \cup \Gamma_R)$, and the corresponding definition of the initial datum on $\mathbb{R} \setminus (\mathcal{I}_L \cup \mathcal{I}_R)$, proceed as follows:

- For any $y \in]-\infty, L[\cup]L, \tilde{L}[\cup]R, +\infty[$, we trace the lines $\vartheta_{y,\pm}$ starting at (y, T) until they reach the x -axis at the point $\phi_{\pm}(y) \doteq \vartheta_{y,\pm}(0)$. Since conditions (4.11), (4.12) of Theorem 4.2 is equivalent to the monotonicity of the map $\phi(y) \doteq \vartheta_y(0)$ (see [6, Lemma 4.4]), it follows that $\vartheta_{y,\pm}$ never intersect each other in the region $\mathbb{R} \times]0, T[$. Then, if $y \in]-\infty, L[\cup]R, +\infty[$, we define a function $u(x, t)$ that is equal to $\omega(y_{\pm})$ along the segment $\vartheta_{y,\pm}$. Instead if $y \in]L, \tilde{L}[$ we define u to be equal to $\omega(y_{\pm})$ along the segment $\vartheta_{y,\pm}(t)$, $\tau_{\pm}(y) \leq t \leq T$, and to be equal to $\pi_{r,-}^l(\omega(y_{\pm}))$ along the segment $\vartheta_{y,\pm}(t)$, $0 \leq t \leq \tau_{\pm}(y)$.
- For any $z \in \mathcal{I}_L^n \cup \mathcal{I}_R^n$, we trace the line $\eta_{y_n,z}$, $y_n \in]-\infty, L[\cup]R, +\infty[$. By construction the lines $\eta_{y_n,z}$ never cross each other in the region $\mathbb{R} \times]0, T[$. Then, if $y_n \in]-\infty, L[$, we define $u(x, t)$ to be equal to $(f_l')^{-1}((y-z)/T) = u_{y,z}$ along the segment $\eta_{y_n,z}$, instead if $y_n \in]R, +\infty[$, we define $u(x, t)$ to be equal to $(f_r')^{-1}((y-z)/T) = u_{y,z}$ along the segment $\eta_{y_n,z}$.
- For any $z \in \tilde{\mathcal{I}}_L^n$, we trace the polygonal line $\eta_{y_n,z}$, $y_n \in]L, \tilde{L}[$. By construction the lines $\eta_{y_n,z}$ never cross each other in the region $\mathbb{R} \times]0, T[$. Then, we define $u(x, t)$ to be equal to $(f_l')^{-1}((y_n-x)/(T-t)) = u_{y,z}$ along the segment $\eta_{y_n,z}$, $\tau(y, z) < t \leq T$, and to be equal to $\pi_{r,-}^l(u_{y,z})$ along the segment $\eta_{y_n,z}$, $0 \leq t \leq \tau(y, z)$.

Therefore, we define the the function

$$u(x, t) \doteq \begin{cases} \omega(y_{\pm}), & \text{if } x = \vartheta_{y, \pm}(t) \text{ for some } y \in]-\infty, \mathbf{L}[\cup]\mathbf{R}, +\infty[, \\ \omega(y_{\pm}), & \text{if } x = \vartheta_{y, \pm}(t) < 0 \text{ for some } y \in]\mathbf{L}, \tilde{\mathbf{L}}[, \\ \pi_{r, -}^l(\omega(y_{\pm})), & \text{if } x = \vartheta_{y, \pm}(t) > 0 \text{ for some } y \in]\mathbf{L}, \tilde{\mathbf{L}}[, \\ (f_l')^{-1}\left(\frac{y_n - z}{T}\right), & \text{if } x = \eta_{y_n, z}(t) \text{ for some } z \in \mathcal{I}_L^n, \\ (f_r')^{-1}\left(\frac{y_n - z}{T}\right), & \text{if } x = \eta_{y_n, z}(t) \text{ for some } z \in \mathcal{I}_R^n, \\ (f_l')^{-1}\left(\frac{\mathbf{L} - x}{T - t}\right), & \text{if } x = \eta_{y_n, z}(t) < 0 \text{ for some } z \in \tilde{\mathcal{I}}_L^n, \\ \pi_{r, -}^l(u_{y_n, z}), & \text{if } x = \eta_{y_n, z}(t) > 0 \text{ for some } z \in \tilde{\mathcal{I}}_L^n, \\ u_L(x, t), & \text{if } (t, x) \in \Delta_L, \\ u_R(x, t), & \text{if } (t, x) \in \Gamma_R, \end{cases} \quad (5.118)$$

and the initial datum

$$u_0(x) \doteq \begin{cases} \omega(y_{\pm}), & \text{if } x \in \mathcal{I}_{\mathcal{W}}, x = \theta_{y, \pm}(0) \text{ for some } y \in]-\infty, \mathbf{L}[\cup]\mathbf{R}, +\infty[, \\ \pi_{r, -}^l(\omega(y_{\pm})), & \text{if } x \in \mathcal{I}_{\mathcal{W}}, x = \theta_{y, \pm}(0), y \in]\mathbf{L}, \tilde{\mathbf{L}}[, \\ (f_l')^{-1}\left(\frac{y_n - x}{T}\right), & \text{if } x \in \mathcal{I}_L^n, \\ (f_r')^{-1}\left(\frac{y_n - x}{T}\right), & \text{if } x \in \mathcal{I}_R^n, \\ \pi_{r, -}^l(u_{y_n, x}), & \text{if } x \in \tilde{\mathcal{I}}_L^n, \\ u_L(x, 0), & \text{if } x \in \mathcal{I}_L, \\ u_R(x, 0), & \text{if } x \in \mathcal{I}_R. \end{cases} \quad (5.119)$$

Notice that u_0 is not defined on the countable set $\mathcal{I}_{\mathcal{R}a}$ which is of measure zero, and clearly $u_0 \in \mathbf{L}^\infty(\mathbb{R})$. By construction, the function $u(x, t)$:

- is locally Lipschitz continuous on $(\mathbb{R} \times]0, T[) \setminus (\overline{\Delta_L \cup \Gamma_R} \cup (\{0\} \times]0, T[))$, and it is continuous on the boundary $\partial(\Delta_L \cup \Gamma_R) \setminus (\{0\} \times]0, T[)$;
- is a classical solution of $u_t + f_l(u)_x = 0$ on $(]-\infty, 0[\times]0, T[) \setminus \overline{\Delta_L \cup \Gamma_R}$;
- is a classical solution of $u_t + f_r(u)_x = 0$ on $(]0, +\infty[\times]0, T[) \setminus \overline{\Delta_L \cup \Gamma_R}$;
- is an AB -entropy solution of (1.1) on $\Delta_L \cup \Gamma_R$;
- satisfies the interface entropy condition (2.13) at any point $(0, t)$, $t \in]0, T[$.

Thus, by Definition 2.2, it follows that the function $u(x, t)$ in (5.118) provides an AB -entropy solution to (1.1) on $\mathbb{R} \times [0, T]$. Moreover, because of (5.113), (5.118), (5.119), we have

$$u(x, 0) = u_0(x), \quad u(x, T) = \omega(x) \quad \text{for a.e. } x \in \mathbb{R}. \quad (5.120)$$

This proves that

$$\omega = \mathcal{S}_T^{[AB]^+} u_0, \quad (5.121)$$

and thus $\omega \in \mathcal{A}^{AB}(T)$, which completes the proof of the implication (3) \Rightarrow (1) of Theorem 4.11 in the case of a non critical connection.

5.5. Part 2.b - (3) \Rightarrow (2) for non critical connections. As a byproduct of the construction described in § 5.4, we show in this Subsection that, if ω satisfies (5.89), (5.90), then ω verifies condition (2) of Theorem 4.11, i.e. ω is a fixed point of the map $\omega \mapsto \mathcal{S}_T^{[AB]^+} \circ \mathcal{S}_T^{[AB]^-} \omega$. We shall assume that ω satisfies the pointwise constraints of CASE 1 discussed in Remark 4.4, the other cases being symmetric, or entirely similar, or simpler.

In order to verify that $\mathcal{S}_T^{[AB]^+} \circ \mathcal{S}_T^{[AB]^-} \omega = \omega$, because of (5.121) it is sufficient to prove that, letting u_0 be the function defined by (5.115), (5.117), (5.119), there hold

$$u_0 = \mathcal{S}_T^{[AB]^-} \omega. \quad (5.122)$$

In turn, recalling the definition (2.27) of AB backward solution operator, the equality (5.122) is equivalent to the equality

$$u_0(-x) = \overline{\mathcal{S}}_T^{[\overline{B}\overline{A}]^+} (\omega(-\cdot))(x) \quad x \in \mathbb{R}, \quad (5.123)$$

where

$$(x, t) \mapsto \overline{\mathcal{S}}_t^{[\overline{B}\overline{A}]^+} (\omega(-\cdot))(x) \quad (5.124)$$

denotes the unique $\overline{B}\overline{A}$ -entropy solution of

$$\begin{cases} v_t + \overline{f}(x, v)_x = 0 & x \in \mathbb{R}, \quad t \geq 0, \\ v(x, 0) = \omega(-x) & x \in \mathbb{R}, \end{cases} \quad (5.125)$$

$\overline{f}(x, v)$ being the symmetric flux in (2.25).

Towards a proof of (5.123), we will determine the solution of (5.125) on $\mathbb{R} \times [0, T]$ relying on the construction in § 5.4 and on the properties of the left forward rarefaction-shock wave pattern derived in § 3.5. Observe that the function $u(x, t)$ defined by (5.118) for CASE 1, with u_L, u_R defined by (5.110), (5.112), respectively, is:

- locally Lipschitz continuous in the region

$$\mathcal{L} \doteq (\mathbb{R} \times]0, T[) \setminus ((\{0\} \times]0, T[) \cup \Gamma[\mathbb{R}, B, f_r])$$

where $\Gamma[\mathbb{R}, B, f_r]$, is defined as in § 3.4, with $f = f_r$ (the region \mathcal{L} is the complement of the pink region and of the axis $\{x = 0\}$ in Figure 6);

- a classical solution of $u_t + f_l(u)_x = 0$ on $] - \infty, 0[\times]0, T[$;
- a classical solution of $u_t + f_r(u)_x = 0$ on $(]0, +\infty[\times]0, T[) \setminus \overline{\Gamma[\mathbb{R}, B, f_r]}$;
- satisfies the interface entropy condition (2.13) at any point $(0, t)$, $t \in]0, T[$.

Therefore, if we define the transformation $(x, t) \mapsto \alpha(x, t) \doteq (-x, T - t)$, the function

$$v(x, t) \doteq u(-x, T - t), \quad (x, t) \in \alpha(\overline{\mathcal{L}}) \setminus (\{0\} \times]0, T[), \quad (5.126)$$

is:

- an entropy weak solution of $v_t + f_r(v)_x = 0$ in the open set $\alpha(\overline{\mathcal{L}}) \cap \{x < 0\}$;
- an entropy weak solution of $v_t + f_l(v)_x = 0$ in the open set $\alpha(\overline{\mathcal{L}}) \cap \{x > 0\}$.

On the other hand, letting $\Delta[\mathbf{y}[\mathbb{R}, B, f_r], \overline{B}, f_r]$ denote the region defined in (3.40) with $\mathbf{L} = \mathbf{y}[\mathbb{R}, B, f_r]$, $A = \overline{B}$, and $f = f_r$. one can directly verify that

$$\alpha(\Gamma[\mathbb{R}, B, f_r]) = \Delta[\mathbf{y}[\mathbb{R}, B, f_r], \overline{B}, f_r] \subset] - \infty, 0[\times]0, T[. \quad (5.127)$$

Notice that $(\mathbb{R} \times [0, T]) \setminus (\{0\} \times]0, T[)$ is the disjoint union of $\alpha(\overline{\mathcal{L}}) \setminus (\{0\} \times]0, T[)$ and of $\alpha(\Gamma[\mathbb{R}, B, f_r])$. Then, letting $\mathbf{v}[\mathbf{y}[\mathbb{R}, B, f_r], \overline{B}, f_r](x, t)$ denote the function defined in (3.42), with $\mathbf{L} = \mathbf{y}[\mathbb{R}, B, f_r]$, $A = \overline{B}$, and $f = f_r$, consider the function $v : \mathbb{R} \times [0, T] \rightarrow \mathbb{R}$ defined by setting

$$v(x, t) \doteq \begin{cases} u(-x, T - t), & \text{if } (x, t) \in \alpha(\overline{\mathcal{L}}) \setminus (\{0\} \times]0, T[), \\ \mathbf{v}[\mathbf{y}[\mathbb{R}, B, f_r], \overline{B}, f_r](x, t), & \text{if } (x, t) \in \Delta[\mathbf{y}[\mathbb{R}, B, f_r], \overline{B}, f_r]. \end{cases} \quad (5.128)$$

By construction and because of the analysis in § 3.5, the function $v(x, t)$:

- is locally Lipschitz continuous on $(\mathbb{R} \times]0, T[) \setminus (\overline{\Delta[\mathbf{y}[\mathbb{R}, B, f_r], \overline{B}, f_r]} \cup (\{0\} \times]0, T[))$, and it is continuous on the boundary $\partial(\Delta[\mathbf{y}[\mathbb{R}, B, f_r], \overline{B}, f_r]) \setminus (\{0\} \times]0, T[)$;
- is a classical solution of $v_t + f_r(v)_x = 0$ on $(] - \infty, 0[\times]0, T[) \setminus \overline{\Delta[\mathbf{y}[\mathbb{R}, B, f_r], \overline{B}, f_r]}$;

- is an entropy weak solution of $v_t + f_r(v)_x = 0$ on $\Delta[\mathbf{y}[\mathbb{R}, B, f_r], \overline{B}, f_r]$;
- is a classical solution of $v_t + f_l(v)_x = 0$ on $]0, +\infty[\times]0, T[$;
- satisfies the $\overline{B}\overline{A}$ interface entropy condition, namely, setting $v_l(t) \doteq v(0-, t)$, $v_r(t) \doteq v(0+, t)$, and considering the function

$$I^{\overline{B}\overline{A}}(v_l, v_r) \doteq \operatorname{sgn}(v_r - \overline{A}) (f_l(v_r) - f_l(\overline{A})) - \operatorname{sgn}(v_l - \overline{B}) (f_r(v_l) - f_r(\overline{B})),$$

there hold

$$f_r(v_l(t)) = f_l(v_r(t)), \quad I^{\overline{B}\overline{A}}(v_l(t), v_r(t)) \leq 0, \quad \text{for a.e. } t \in]0, T[. \quad (5.129)$$

Notice also that, because of (5.120), (5.127), (5.128), it follows

$$v(x, 0) = u(-x, T) = \omega(-x) \quad \text{for a.e. } x \in \mathbb{R}. \quad (5.130)$$

Therefore, by Definition 2.2, we deduce that the function $v(x, t)$ in (5.128) provides the $\overline{B}\overline{A}$ -entropy solution to (5.125) on $\mathbb{R} \times [0, T]$, and hence we have

$$v(x, t) = \overline{\mathcal{S}}_t^{\overline{B}\overline{A}+}(\omega(-\cdot))(x) \quad x \in \mathbb{R}, \quad t \in [0, T]. \quad (5.131)$$

Moreover, by (5.120), (5.128), there hold

$$\overline{\mathcal{S}}_T^{\overline{B}\overline{A}+}(\omega(-\cdot))(x) = u(-x, 0) = u_0(-x) \quad x \in \mathbb{R},$$

which proves (5.123), and thus concludes the proof of the implication (3) \Rightarrow (2) of Theorem 4.11 in the case of a non critical connection.

5.6. Part 3.a - (1) \Leftrightarrow (2) for critical connections. In this Subsection we assume that the equivalence of conditions (1), (2) of Theorem 4.11 holds for connections which are non critical, and we will show that it remains true also for critical connections (A, B) . To fix the ideas, throughout this and the following subsections we shall assume that the connection (A, B) is critical at the left, i.e. that

$$A = \theta_l, \quad (5.132)$$

the case where one assumes that $B = \theta_r$ being symmetric. Notice that the assumption $A = \theta_l$ does not prevent the connection to be critical also at the right, i.e. $B = \theta_r$: it might or might not happen. We shall consider a sequence $\{A_n, B_n\}_n$ of non critical connections that satisfy

$$\lim_n(A_n, B_n) = (A, B). \quad (5.133)$$

We will show only that (1) \Rightarrow (2), since the reverse implication is clear (see § 5.1). Then, given $\omega \in \mathcal{A}^{[AB]}(T)$ with

$$\omega = \mathcal{S}_T^{[AB]+} u_0, \quad u_0 \in \mathbf{L}^\infty(\mathbb{R}), \quad (5.134)$$

set

$$\omega_n \doteq \mathcal{S}_T^{[A_n B_n]+} u_0. \quad (5.135)$$

Hence, since $\omega_n \in \mathcal{A}^{[A_n B_n]}(T)$, by the validity of Theorem 4.11 in the non critical case it holds

$$\omega_n = \mathcal{S}_T^{[A_n B_n]+} \circ \mathcal{S}_T^{[A_n B_n]-} \omega_n \quad \forall n. \quad (5.136)$$

Notice that by definition (2.27) it follows that the \mathbf{L}^1 stability property (iv) of Theorem 2.7 holds also for the AB -backward solution operator $\mathcal{S}_T^{[AB]-}$, so that we have

$$\mathcal{S}_T^{[A_n B_n]-} \omega_n \rightarrow \mathcal{S}_T^{[AB]-} \omega \quad \text{in } \mathbf{L}^1(\mathbb{R}). \quad (5.137)$$

Hence, we deduce that

$$\omega \stackrel{[\text{Thm 2.7-(iv)}]}{=} \lim_n \omega_n \stackrel{[(5.136)]}{=} \lim_n \mathcal{S}_T^{[A_n B_n]+} \circ \mathcal{S}_T^{[A_n B_n]-} \omega_n \stackrel{[\text{Thm 2.7-(iv) and (5.137)}]}{=} \mathcal{S}_T^{[AB]+} \circ \mathcal{S}_T^{[AB]-} \omega,$$

which proves (1) \Rightarrow (2). \square

5.7. Part 3.b - (1) \Rightarrow (3) for critical connections. In this Subsection we assume that the implication (1) \Rightarrow (3) of Theorem 4.11 holds for connections which are non critical, and in particular we assume that Theorems 4.2, 4.7, 4.9, are verified for non critical connections. We will prove that any element $\omega \in \mathcal{A}^{AB}(T)$ satisfies the conditions of Theorem 4.7, or of Theorem 4.9, also for a critical connection (A, B) . We divide the proof in eight steps.

Step 1. Let $\{A_n, B_n\}_n$ be a sequence of non critical connections as in Part 3.a. Given $\omega \in \mathcal{A}^{AB}(T)$ as in (5.134), and ω_n , as in (5.135), set

$$u(x, t) \doteq \mathcal{S}_t^{[AB]^+} u_0(x), \quad t \geq 0, \quad x \in \mathbb{R}, \quad (5.138)$$

and consider the sequence u_n of $A_n B_n$ -entropy weak solutions defined by

$$u_n(x, t) \doteq \mathcal{S}_t^{[A_n B_n]^+} u_0(x), \quad t \geq 0, \quad x \in \mathbb{R}. \quad (5.139)$$

Let $u_{n,l}, u_{n,r}$ denote, respectively, the left and right traces of u_n at $x = 0$ defined as in (2.7), and let u_l, u_r be the left and right traces of u at $x = 0$. Then, by Theorem 2.7 and Corollary 2.9, and because of (5.133), it follows

$$u_n(\cdot, t) \rightarrow u(\cdot, t) \quad \text{in } \mathbf{L}^1(\mathbb{R}) \quad \forall t \in [0, T], \quad (5.140)$$

$$f_l(u_{n,l}) \rightarrow f_l(u_l) \quad \text{in } \mathbf{L}^1([0, T]), \quad (5.141)$$

$$f_r(u_{n,r}) \rightarrow f_r(u_r) \quad \text{in } \mathbf{L}^1([0, T]), \quad (5.142)$$

and hence, in particular, we have

$$\omega_n \rightarrow \omega \quad \text{in } \mathbf{L}^1(\mathbb{R}). \quad (5.143)$$

In order to prove that ω satisfies condition (3) of Theorem 4.11, letting

$$\mathbf{L} \doteq \mathbf{L}[\omega, f_l], \quad \mathbf{R} \doteq \mathbf{R}[\omega, f_r], \quad (5.144)$$

be quantities defined as in (4.4), we need to show that:

- If $\mathbf{L} = 0, \mathbf{R} > 0$ or viceversa, then ω satisfies the conditions of Theorem 4.7;
- If $\mathbf{L} = 0, \mathbf{R} = 0$, then ω satisfies the conditions of Theorem 4.9.

Notice that, since we are assuming the validity of Theorem 4.2, we know that the case $\mathbf{L} < 0, \mathbf{R} > 0$ is excluded because the connection (A, B) is critical.

Throughout the subsection we let $\mathbf{L}_n, \mathbf{R}_n$, denote the objects defined as in (5.144) for ω_n :

$$\mathbf{L}_n \doteq \mathbf{L}[\omega_n, f_l], \quad \mathbf{R}_n \doteq \mathbf{R}[\omega_n, f_r]. \quad (5.145)$$

Observe that by Remark 2.8, and because of (5.143), the functions ω_n have a uniform bound

$$\|\omega_n\|_{\mathbf{L}^\infty} \leq \bar{C} \quad \forall n, \quad (5.146)$$

for constant $\bar{C} > 0$. Hence, by definition (4.4), the constant $|\mathbf{L}_n|$ are bounded by $T \cdot \sup_{|u| \leq \bar{C}} |f'_l(u)|$, and the constant \mathbf{R}_n are bounded by $T \cdot \sup_{|u| \leq \bar{C}} |f'_r(u)|$. Thus, up to a subsequence, we can define the limits

$$\widehat{\mathbf{L}} \doteq \lim_{n \rightarrow \infty} \mathbf{L}_n, \quad \widehat{\mathbf{R}} \doteq \lim_{n \rightarrow \infty} \mathbf{R}_n. \quad (5.147)$$

We claim that

$$\widehat{\mathbf{L}} \leq \mathbf{L}, \quad \widehat{\mathbf{R}} \geq \mathbf{R}. \quad (5.148)$$

By definition (4.4), (5.144) of \mathbf{R} , in order to prove the second inequality in (5.148), it is sufficient to show that

$$\widehat{\mathbf{R}} - T \cdot f'_r(\omega(\widehat{\mathbf{R}}+)) \geq 0. \quad (5.149)$$

Observe that by Definition 2.2 u_n and u are entropy weak solutions of

$$u_t + f_r(u)_x = 0 \quad x > 0, \quad t \in [0, T], \quad (5.150)$$

that, because of (5.140), (5.142), satisfy the assumptions (C.2), (C.3) of Lemma C.1 in Appendix C. Thus, applying (C.4), and recalling (5.134), (5.135), we find

$$\omega(\widehat{R}+) \leq \liminf_{\substack{n \rightarrow \infty \\ y \rightarrow \widehat{R}}} \omega_n(y+). \quad (5.151)$$

Since (5.147) and the liminf property imply

$$\liminf_{\substack{n \rightarrow \infty \\ y \rightarrow \widehat{R}}} \omega_n(y+) \leq \liminf_n \omega_n(R_n+), \quad (5.152)$$

we derive from (5.151) that

$$\omega(\widehat{R}+) \leq \liminf_n \omega_n(R_n+). \quad (5.153)$$

On the other hand, by definition (4.4), (5.145) of R_n , it holds

$$\omega_n(R_n+) \leq (f'_r)^{-1} \left(\frac{R_n}{T} \right). \quad (5.154)$$

Hence, from (5.153), (5.154) and (5.147) we deduce

$$\omega(\widehat{R}+) \leq \lim_{n \rightarrow \infty} (f'_r)^{-1} \left(\frac{R_n}{T} \right) = (f'_r)^{-1} \left(\frac{\widehat{R}}{T} \right), \quad (5.155)$$

which yields (5.149). This completes the proof of the second inequality in (5.148), while the proof of the first one is entirely similar.

Relying on (5.148), we will show in Steps 2-7 that ω satisfies the conditions (i)', (ii)' of Theorem 4.7 in the case $L = 0$, $R > 0$. Namely, in Step 2 we prove (4.44), in Step 3 we prove (4.45), in Step 4 we prove (4.46), in Step 5 we prove (4.42), while in Step 6 we prove (4.43). Finally, in Step 7 we prove (4.41), concluding the proof of conditions (i)', (ii)' of Theorem 4.7. The proof that ω satisfies conditions (i), (ii) of Theorem 4.7 in the case $L < 0$, $R = 0$ is entirely similar. Next, in Step 8 we will show that ω satisfies conditions (i), (ii) of Theorem 4.9 in the case $L = 0$, $R = 0$.

Step 2. ($L = 0$, $R > 0$, proof of (4.44): $\omega(x) \geq B$ in $]0, R[$).

Applying (4.15), (4.16) of Theorem 4.2-(ii) or (4.44) of Theorem 4.7-(ii)' for ω_n , in the case of the non critical connections (A_n, B_n) , we deduce that

$$\omega_n(x) \geq B_n \quad \forall x \in]0, R^n[, \quad \forall n. \quad (5.156)$$

On the other hand, by virtue of (5.143), (5.148), we can extract a subsequence of $\{\omega_n\}$ that converges to ω for almost every $x \in]0, R[$. Then, taking the limit in (5.156), and relying on (5.133), we derive (4.44).

Step 3. ($L = 0$, $R > 0$, proof of (4.45): $R \in]0, T \cdot f'_r(B)[\Rightarrow \omega(R+) \leq \mathbf{u}[R, B, f_r] \leq \omega(R-)$).

Observe first that, in the case $\widehat{R} = R$, by the continuity of the function $\mathbf{u}[R, B, f_r]$ with respect to R, B (see § 3.1), and because of (5.133), we find

$$\lim_{n \rightarrow \infty} \mathbf{u}[R_n, B_n, f_r] = \mathbf{u}[R, B, f_r]. \quad (5.157)$$

On the other hand, if $R = \widehat{R} \in]0, T \cdot f'_r(B)[$, we may assume that $R_n \in]0, T \cdot f'_r(B_n)[$, for n sufficiently large. Hence, applying either (4.14) of Theorem 4.2-(ii), or (4.45) of Theorem 4.7-(ii)' for such n , in the case of the non critical connections (A_n, B_n) , we deduce

$$\liminf_{n \rightarrow \infty} \omega_n(R_n+) \leq \lim_{n \rightarrow \infty} \mathbf{u}[R_n, B_n, f_r]. \quad (5.158)$$

Then, combining (5.157), (5.158), with (5.153), and recalling (3.8) with $f = f_r$, we derive

$$\omega(R+) \leq \mathbf{u}[R, B, f_r] < B, \quad (5.159)$$

which, together with (4.44) (established in Step 2), proves (4.45) in the case $\widehat{R} = R$.

Thus, because of (5.148), it remains to analyze the case $\widehat{R} > R$. Let ϑ_n^- denote the minimal backward characteristic for u_n starting from (R_n, T) and lying in the domain $x > 0$. Recalling the definition (4.4), (5.145) of R_n this is a map $\vartheta_n^- :]\tau_n, T] \rightarrow]0, +\infty[$, $\tau_n \geq 0$, with the property that $\lim_{t \rightarrow \tau_n} \vartheta_n^-(t) = 0$. By possibly taking a subsequence, we may assume that $\{\tau_n\}_n$ converges to some $\bar{\tau} \geq 0$. Observe that ϑ_n^- are genuine characteristics which, up to a subsequence, converge to a genuine characteristic $\vartheta^- :]\bar{\tau}, T] \rightarrow]0, +\infty[$ for u , starting from $(\vartheta^-(T), T) = (\widehat{R}, T)$ (see proof of Lemma C.1 in Appendix C). The trajectory of ϑ^- is a segment with slope $f'_r(u(\widehat{R}-, T)) = f'_r(\omega(\widehat{R}-))$. Therefore, if $\bar{\tau} > 0$, it follows that $f'_r(\omega(\widehat{R}-)) > \widehat{R}/T$, which by definition of R implies $R \geq \widehat{R}$, contradicting the assumption $\widehat{R} > R$. Hence, it must be $\bar{\tau} = 0$, $\lim_{t \rightarrow 0} \vartheta^-(t) = 0$, and the trajectory of ϑ^- is a segment joining the point (\widehat{R}, T) with the origin $(0, 0)$. Since $R < \widehat{R}$ and because backward characteristics cannot intersect in the domain $x > 0, t > 0$, this in turn implies that the slope $f'_r(\omega(R+))$ of the maximal backward characteristic for u starting at (R, T) must be greater or equal than R/T . On the other hand, by definition (4.4), (5.144) of R , we have $f'_r(\omega(R+)) \leq R/T$, and hence it follows that

$$f'_r(\omega(R+)) = R/T. \quad (5.160)$$

Observe now that, applying Theorem 4.2-(ii) or Theorem 4.7-(ii)' for ω_n , in the case of the non critical connections (A_n, B_n) , we know that (5.156) is verified. Moreover, because of $R < \widehat{R} = \lim_n R_n$ we may assume that $R < R_n$ for n sufficiently large. Hence, by virtue of (5.143), we can extract a subsequence of $\{\omega_n\}$ that converges to ω for almost every $x \in]0, R[$, and thus we derive from (5.133), (5.156) that $\omega(R+) \geq B$. This inequality, together with (5.160), yields

$$R \geq T \cdot f'_r(B), \quad (5.161)$$

proving the implication (4.45) also in the case $\widehat{R} > R$.

Step 4. ($L = 0, R > 0$, proof of (4.46): $R > T \cdot f'_r(B) \Rightarrow \omega(R+) \leq \omega(R-)$).

By virtue of (5.133), (5.148), we may assume that

$$R_n > T \cdot f'_r(B_n) \quad \forall n. \quad (5.162)$$

Then, applying (4.18) of Theorem 4.2-(ii) or (4.46) of Theorem 4.7-(ii)' for ω_n and the non critical connections (A_n, B_n) , we derive

$$\omega_n(R_n-) \geq \omega_n(R_n+) \quad \forall n. \quad (5.163)$$

On the other hand, if $\widehat{R} = R$, invoking (C.4), (C.5) of Lemma C.1 in Appendix C, we deduce as in Step 3 that

$$\omega(R-) \geq \limsup_n \omega_n(R_n-), \quad \omega(R+) \leq \liminf_n \omega_n(R_n+). \quad (5.164)$$

Then, (5.163)-(5.164) together yield $\omega(R-) \geq \omega(R+)$, proving (4.46) in the case $\widehat{R} = R$. Instead, if $\widehat{R} > R$, we can assume that $R_n > R$ for all n sufficiently large. Then, observe that applying (4.13), (4.15), (4.16), of Theorem 4.2, or (4.42) of Theorem 4.7, for ω_n and the non critical connections (A_n, B_n) , we deduce

$$\omega_n(R-) \geq \omega_n(R+) \quad \forall n. \quad (5.165)$$

Hence, with the same arguments of above we find that

$$\omega(R-) \geq \limsup_n \omega_n(R-), \quad \omega(R+) \leq \liminf_n \omega_n(R+), \quad (5.166)$$

which, together with (5.165), yields $\omega(R-) \geq \omega(R+)$, completing the proof of (4.46).

Step 5. ($L = 0, R > 0$, proof of (4.42): $D^+\omega(x) \leq h[\omega, f_l, f_r](x)$ in $]0, R[$).

Applying Theorem 4.2-(i) or Theorem 4.7-(i)' for ω_n in the case of the non critical connections (A_n, B_n) , we know that

$$D^+\omega_n(x) \leq h[\omega_n, f_l, f_r](x) \quad \forall x \in]0, R_n[. \quad (5.167)$$

As shown in [6, Lemma 4.4], the inequality (5.167) is equivalent to the fact that the maps

$$\phi_n(x) \doteq -\tau_n(x) \cdot f'_l \circ \pi_{l,+}^r(\omega_n(x)), \quad \tau_n(x) \doteq T - \frac{x}{f'_r(\omega_n(x))}, \quad x \in]0, R_n[, \quad (5.168)$$

are, respectively, nondecreasing and decreasing. Since by (5.148) it holds $\lim_n R_n \geq R$, relying on (5.143) we deduce that, up to a subsequence, $\{\omega_n\}_n$ converges to ω for almost every $x \in]0, R[$. In turn, this implies that the sequences $\{\phi_n\}_n$, $\{\tau_n\}_n$, converges for almost every $x \in]0, R[$ to the maps

$$\phi(x) \doteq -\tau(x) \cdot f'_l \circ \pi_{l,+}^r(\omega(x)), \quad \tau(x) \doteq T - \frac{x}{f'_r(\omega(x))}, \quad x \in]0, R[. \quad (5.169)$$

Then, the monotonicity of each map $\phi_n(x)$ and $\tau_n(x)$, imply the same monotonicity of the maps $\phi(x), \tau(x)$ defined in (5.169). But this is equivalent to the inequality (4.42), relying again on [6, Lemma 4.4].

Step 6. ($L = 0, R > 0$, proof of (4.43): $\omega(0-) \geq \pi_{l,+}^r(\omega(0+))$).

Let $x \in]0, R[$ be a point of continuity for ω , and consider the backward genuine characteristics for u starting at (x, T) , defined by

$$\vartheta_x(t) \doteq x - (T - t) \cdot f'_r(\omega(x)) \quad t \in]\tau(x), T[, \quad (5.170)$$

with

$$\tau(x) \doteq T - \frac{x}{f'_r(\omega(x))}, \quad (5.171)$$

so that one has $\lim_{t \rightarrow \tau(x)} \vartheta_x(t) = 0$. Observe that the inequality (4.42) (established at **Step 3**) implies that the function $\tau(x)$ is decreasing. On the other hand, because of (5.146), the slopes of ϑ_x are uniformly bounded by $\sup_{|u| \leq \bar{C}} |f'_r(u)|$. Therefore, letting $\{x_n\}_n \subset]0, R[$ be a sequence of points of continuity for ω , such that $x_n \rightarrow 0$, it follows that

$$\lim_n \tau(x_n) = T. \quad (5.172)$$

Notice that, since ϑ_{x_n} are genuine characteristics, we have

$$\omega(x_n) = u_r(\tau(x_n)) \quad \forall n. \quad (5.173)$$

Since, by definition (4.1) one has $\pi_{l,+}^r(u) \geq \theta_l$ for any u , we may assume that, up to a subsequence, either

$$\pi_{l,+}^r(\omega(x_n)) = \theta_l \quad \forall n, \quad (5.174)$$

or

$$\pi_{l,+}^r(\omega(x_n)) > \theta_l \quad \forall n. \quad (5.175)$$

In the first case (5.174) we deduce that

$$\pi_{l,+}^r(\omega(0+)) = \lim_n \pi_{l,+}^r(\omega(x_n)) = \theta_l, \quad (5.176)$$

which yields (4.43) observing that, by definition (4.4), (5.144), $L = 0$ implies $f'_l(\omega(0-)) \geq 0$, which is equivalent to $\omega(0-) \geq \theta_l$. Instead, in the second case (5.175), observe that, since the map τ in (5.171) is decreasing, and because x_n are points of continuity for ω , then $\tau(x_n)$ are points of continuity for u_r and u_l . Then, we can trace the backward genuine characteristics for u starting at $(0, \tau(x_n))$, that, because of (5.173), are defined by

$$\vartheta_n(t) \doteq (t - \tau(x_n)) \cdot f'_l \circ \pi_{l,+}^r(\omega(x_n)), \quad t \in [0, \tau(x_n)[. \quad (5.177)$$

With the same arguments of the proof of Lemma C.1 in Appendix C, and because of (5.172), we can extract a subsequence of $\{\vartheta_n\}_n$ that converges uniformly to a backward genuine characteristic starting at $(0, T)$, that has slope $f'_l \circ \pi_{l,+}^r(\omega(0+))$. On the other hand the minimal backward characteristic starting at $(0, T)$ has slope $f'_l(\omega(0-))$. Since the slope of the minimal backward characteristic is larger than the slope of any other backward characteristic passing through the

same point, it follows that $f'_l(\omega(0-)) \geq f'_l \circ \pi_{l,+}^r(\omega(0+))$, which implies (4.43). This concludes the proof of this step.

Step 7. ($L = 0, R > 0$, proof of (4.41): $D^+\omega(x) \leq \frac{1}{T \cdot f'_l(\omega(x))}$ in $] -\infty, 0[$, and $D^+\omega(x) \leq \frac{1}{T \cdot f'_r(\omega(x))}$ in $]R, +\infty[$).

Observe that, by definition (4.4), (5.144) of L, R , and since $L = 0$, backward characteristics starting at points (x, T) , with $x \in] -\infty, 0[\cup]R, +\infty[$ do not intersect the interface $x = 0$. Hence, we recover the Oleinik estimates (4.41) as a classical property of solutions to conservation laws with strictly convex flux, which follows from the fact that genuine characteristics never intersect at positive times. This completes the proof that ω satisfies conditions (i)'-(ii)' of Theorem 4.7.

Step 8. ($L = 0, R = 0$, proof of (4.51): $D^+\omega(x) \leq \frac{1}{T \cdot f'_l(\omega(x))}$ in $] -\infty, 0[$, and $D^+\omega(x) \leq \frac{1}{T \cdot f'_r(\omega(x))}$ in $]0, +\infty[$, of (4.52): $\omega(0-) \geq \pi_{l,+}^r(\omega(0+))$, and of (4.53): $\omega(0-) \geq \bar{A}, \omega(0+) \leq \bar{B}$).

Since $L = 0, R = 0$, by definition (4.4) it follows that backward characteristics starting at (x, T) , $x \in] -\infty, 0[\cup]0, +\infty[$, never intersect the interface $x = 0$. Thus, as observed in Step 7, the Oleinik estimates in (4.51) are a classical property of solutions. Instead the inequality $\omega(0-) \geq \pi_{l,+}^r(\omega(0+))$ can be established with the same proof of (4.43) in Step 6. Finally, the inequality $\omega(0+) \leq \bar{B}$ is obtained with the same arguments of the proof of (4.45) in Step 3, observing that by Remark 3.2 we have $\mathbf{u}[0, B, f_r] = \mathbf{u}[0+, B, f_r] = \bar{B}$. The other inequality $\omega(0-) \geq \bar{A}$ can be derived in an entirely similar way. Therefore the proof that ω satisfies the conditions (i)-(ii) of Theorem 4.9 is completed, and this concludes the proof of the implication (1) \Rightarrow (3) for critical connections.

5.8. Part 3.c - (3) \Rightarrow (1) for critical connections. In this Subsection we assume that Theorem 4.11 holds for connections which are non critical, and in particular we assume that Theorems 4.2, 4.7, 4.9, are verified for non critical connections. We will prove that if $\omega \in \mathcal{A}^{L,R}$ satisfies the conditions of Theorem 4.7, or of Theorem 4.9, then $\omega \in \mathcal{A}^{[AB]}(T)$ also for a critical connection (A, B) . We divide the proof in eight steps.

Step 1. Given an element ω of the set $\mathcal{A}^{L,R}$ in (4.9), assuming that:

- if $L = 0, R > 0$ or viceversa, ω satisfies the conditions of Theorem 4.7;
- if $L = 0, R = 0$, ω satisfies the conditions of Theorem 4.9;

we will construct a sequence $\{\omega_n\}_n$ of suitable perturbations of ω with the property that:

$$\omega_n \in \mathcal{A}^{[A_n B_n]}(T) \quad \forall n, \quad \omega_n \rightarrow \omega \quad \text{in } \mathbf{L}_{\text{loc}}^1(\mathbb{R}), \quad (5.178)$$

for a sequence of non critical connections $\{(A_n, B_n)\}_n$ satisfying (5.133) and

$$A_n < A, \quad B_n > B \quad \forall n. \quad (5.179)$$

The conditions in (5.178) in turn will imply that $\omega \in \mathcal{A}^{[AB]}(T)$. In fact, by the validity of Theorem 4.11 in the noncritical case, and because of (5.178), it holds

$$\omega_n = \mathcal{S}_T^{[A_n B_n]^+} \circ \mathcal{S}_T^{[A_n B_n]^-} \omega_n \quad \forall n. \quad (5.180)$$

On the other hand, relying on the stability property (iv) of Theorem 2.7, and thanks to (5.178), one finds as in § 5.6 that

$$\mathcal{S}_T^{[A_n B_n]^+} \circ \mathcal{S}_T^{[A_n B_n]^-} \omega_n \rightarrow \mathcal{S}_T^{[AB]^+} \circ \mathcal{S}_T^{[AB]^-} \omega \quad \text{in } \mathbf{L}_{\text{loc}}^1(\mathbb{R}). \quad (5.181)$$

Hence, combining together (5.178), (5.180), (5.181), we derive

$$\omega = \mathcal{S}_T^{[AB]^+} \circ \mathcal{S}_T^{[AB]^-} \omega,$$

which clearly yields $\omega \in \mathcal{A}^{[AB]}(T)$. Therefore, to establish the implication (3) \Rightarrow (1) of Theorem 4.11 for non critical connections, it remains to produce a family $\{\omega_n\}_n$ that satisfies (5.178). We shall construct such perturbations of $\omega \in \mathcal{A}^{L,R}$ as suitable “ (A_n, B_n) admissible envelopes” of ω .

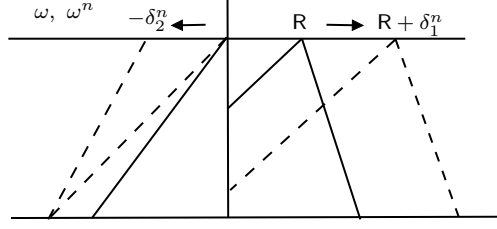

FIGURE 18. The “candidate” characteristics of ω and of its admissible $A^n B^n$ envelopes ω^n (dashed).

We will consider only the case $L = 0, R \geq 0$. The remaining case $L < 0, R = 0$ is entirely similar. Thus, throughout the following in this subsection we shall assume that

$$L = L[\omega, f_l] = 0, \quad R = R[\omega, f_r] \geq 0. \quad (5.182)$$

Step 2. We will perturb ω to obtain an attainable profile ω_n for the (A_n, B_n) connection by:

- shifting ω on the right of $x = 0$ by a size $\delta_{1,n}$, and on the left of $x = 0$ by a size $\delta_{2,n}$;
- choosing $\delta_{1,n}$ so to satisfy the admissibility condition (4.45) at $x = R + \delta_{1,n}$;
- lifting ω above the value B_n of the connection in the interval $]0, R + \delta_{1,n}[$ so to satisfy the admissibility condition (4.44);
- inserting a profile of a rarefaction in the interval $] - \delta_{2,n}, 0[$, so to satisfy the Lax-type admissibility condition (4.43) at $x = 0$.

Namely, consider the function

$$\omega_n(x) \doteq \begin{cases} \omega(x - \delta_{1,n}), & \text{if } x \geq R + \delta_{1,n}, \\ \max\{\omega(R+), B_n\}, & \text{if } x \in]R, R + \delta_{1,n}[, \\ \max\{\omega(x), B_n\}, & \text{if } x \in]0, R[, \\ (f_l')^{-1} \left(\frac{x + T \cdot f_l'(\max\{\omega(0-), \bar{A}_n\})}{T} \right), & \text{if } x \in] - \delta_{2,n}, 0[, \\ \omega(x + \delta_{2,n}), & \text{if } x \leq -\delta_{2,n}. \end{cases} \quad (5.183)$$

with

$$\delta_{1,n} \doteq \inf \left\{ \delta \geq 0 : \text{either } R + \delta \geq T \cdot f_r'(B_n) \text{ or } \omega(R+) \leq \mathbf{u}[R + \delta, B_n, f_r] \right\}, \quad (5.184)$$

$$\delta_{2,n} \doteq T \cdot f_l'(\max\{\omega(0-), \bar{A}_n\}) - T \cdot f_l'(\omega(0-)),$$

where \bar{A}_n is defined as in (2.16). Recalling the definitions (4.4), and because of (5.182), we deduce that

$$L_n \doteq L[\omega_n, f_l] = 0, \quad R_n \doteq R[\omega_n, f_r] = R + \delta_{1,n} \quad \forall n. \quad (5.185)$$

Notice that the assumption that ω satisfies conditions (ii)' of of Theorem 4.7 or conditions (ii) of Theorem 4.9, together with (5.133), imply that

$$\lim_{n \rightarrow \infty} \delta_{1,n} = \lim_{n \rightarrow \infty} \delta_{2,n} = 0. \quad (5.186)$$

In fact, if $R \leq T \cdot f_r'(B)$, relying on conditions (4.45), (4.49) of Theorem 4.7 or on condition (4.54) of Theorem 4.9 we deduce that $\omega(R+) \leq \mathbf{u}[R, B, f_r]$. Moreover, we know by Remark 3.2 that $\mathbf{u}[\cdot, \cdot, f_r]$ is continuous in the first two entries. Therefore, because of (5.133), we derive from definition (5.184) that, if $R \leq T \cdot f_r'(B)$, then $\lim_n \delta_{1,n} = 0$. On the other hand, if $R > T \cdot f_r'(B)$, then it follows from definition (5.184) and (5.133), that $\delta_{1,n} = 0$ for sufficiently large n . Next, observe that, since $L = 0$, by definition (4.4) one has $\omega(0-) \geq \theta_l$. On the other hand by assumptions (5.132), (5.133) it follows that $\lim_n \bar{A}_n = \theta_l$. Therefore, by definition (5.184) we deduce that $\lim_n \delta_{2,n} = 0$.

By definition (5.183), and because of (5.133), the limit (5.186) implies that ω_n converges to ω in $\mathbf{L}_{\text{loc}}^1$ as $n \rightarrow \infty$. Hence, in order to show that ω_n satisfy (5.178) it remains to prove that $\omega_n \in \mathcal{A}^{[A_n B_n]}(T)$ for all n . Since we are assuming in particular the validity of the implication (2) \Rightarrow (1) of Theorem 4.11 for non critical connections, in order to establish $\omega_n \in \mathcal{A}^{[A_n B_n]}(T)$ it will be sufficient to show that: if $\mathbf{L}_n = 0$ then ω_n satisfies conditions (i)-(ii) of Theorem 4.9; if $\mathbf{L}_n > 0$ then ω_n satisfies conditions (i)'-(ii)' of Theorem 4.7. Namely, we will show in Steps below that:

Step 3. ($\mathbf{R}_n > 0$, $\mathbf{R} = 0$, proof that ω_n satisfies condition (ii)' of Theorem 4.7).

By definition (5.183) one has

$$\omega_n(0-) = \max\{\omega(0-), \bar{A}_n\}, \quad \omega_n(0+) = \max\{\omega(0+), B_n\}, \quad \omega_n(\mathbf{R}_n+) = \omega(0+), \quad (5.187)$$

and

$$\omega_n(x) \geq B_n \quad \forall x \in]0, \mathbf{R}_n[, \quad (5.188)$$

while definition (5.184), together with (5.185), (5.187), (5.188), and (3.8) with $f = f_r$, yield

$$\mathbf{R}_n \in]0, T \cdot f'_r(B_n)[\quad \Longrightarrow \quad \omega_n(\mathbf{R}_n+) \leq \mathbf{u}[\mathbf{R}_n, B_n, f_r] \leq \omega_n(\mathbf{R}_n-). \quad (5.189)$$

Since $\pi_{l,+}^r(B_n) = \bar{A}_n$, from (5.187) we deduce

$$\pi_{l,+}^r(\omega_n(0+)) = \max\{\pi_{l,+}^r(\omega(0+)), \bar{A}_n\}. \quad (5.190)$$

Hence, the assumption that ω satisfies condition (4.52) of Theorem 4.9, together with (5.187), (5.190), imply

$$\omega_n(0-) \geq \pi_{l,+}^r(\omega_n(0+)). \quad (5.191)$$

Therefore, if $\mathbf{R}_n > 0$ and $\mathbf{R} = 0$, then conditions (5.188), (5.189), (5.191) show that ω_n satisfies condition (ii)' of Theorem 4.7.

Step 4. ($\mathbf{R}_n > 0$, $\mathbf{R} > 0$, proof that ω_n satisfies condition (ii)' of Theorem 4.7).

By definition (5.183) one has

$$\omega_n(0-) = \max\{\omega(0-), \bar{A}_n\}, \quad \omega_n(0+) = \max\{\omega(0+), B_n\}, \quad \omega_n(\mathbf{R}_n+) = \omega(\mathbf{R}+), \quad (5.192)$$

and

$$\omega_n(x) \geq B_n \quad \forall x \in]0, \mathbf{R}_n[, \quad (5.193)$$

while definition (5.184), together with (5.185), (5.192), (5.193), and (3.8) with $f = f_r$, yield the implication (5.189). Since we are assuming that ω satisfies condition (4.43) of Theorem 4.7, relying on (5.192) we deduce as in Step 4 that (5.190), (5.191) hold. Therefore, if $\mathbf{R}_n > 0$ and $\mathbf{R} = 0$, then (5.189), (5.191), (5.193) show that ω_n satisfies condition (ii)' of Theorem 4.7.

Step 5. ($\mathbf{R}_n = \mathbf{R} = 0$, proof that ω_n satisfies condition (ii) of Theorem 4.9).

By definition (5.183), we have

$$\omega_n(0-) = \max\{\omega(0-), \bar{A}_n\} \geq \bar{A}_n, \quad \omega_n(0+) = \omega(0+), \quad (5.194)$$

while definition (5.184) yields $\omega(0+) \leq \mathbf{u}[0, B_n, f_r]$. Since by Remark 3.2 we have $\mathbf{u}[0, B_n, f_r] = \bar{B}_n$ (\bar{B}_n as in (2.16)), it follows that

$$\omega_n(0+) \leq \bar{B}_n. \quad (5.195)$$

Moreover, the assumption that ω satisfies condition (4.52) of Theorem 4.9, by virtue of (5.194) implies (5.191). Hence, if $\mathbf{R}_n = 0$ and $\mathbf{R} = 0$, then conditions (5.191), (5.194), (5.195) show that ω_n satisfies condition (ii) of Theorem 4.9.

Step 6. ($\mathbf{R}_n > 0$, $\mathbf{R} \geq 0$, proof that ω_n satisfies (4.41) of Theorem 4.7).

Since we are assuming that ω satisfies either the Oleïnik estimates (4.51) of Theorem 4.9 (in case $\mathbf{R} = 0$), or the Oleïnik estimates (4.41) of Theorem 4.7 (in case $\mathbf{R} > 0$), computing the Dini derivative of ω_n in (5.183), we find

$$\begin{aligned}
 D^+\omega_n(x) &= D^+\omega(x - \delta_{1,n}) \leq \frac{1}{T \cdot f_r''(\omega(x - \delta_{1,n}))} = \frac{1}{T \cdot f_r''(\omega_n(x))} \quad \forall x > R_n, \\
 D^+\omega_n(x) &= D^+\omega(x + \delta_{2,n}) \leq \frac{1}{T \cdot f_l''(\omega(x + \delta_{2,n}))} = \frac{1}{T \cdot f_l''(\omega_n(x))} \quad \forall x < -\delta_{2,n}, \\
 D^+\omega_n(x) &= \frac{1}{T \cdot f_l''(\omega_n(x))} \quad \forall x \in [-\delta_{2,n}, 0[.
 \end{aligned} \tag{5.196}$$

Observing that ω_n is continuous at $x = -\delta_{2,n}$, we deduce from (5.196) that ω_n satisfies the Oleinik estimates (4.41) of Theorem 4.7.

Step 7. ($R_n > 0, R \geq 0$, proof that ω_n satisfies (4.42) of Theorem 4.7).

Observe that by definition (5.183) ω_n is constant in $]R, R_n[$ and that, because of Remark 4.8, one has $\omega_n(R-) \geq \omega_n(R+)$. Therefore, in order to show that ω_n satisfies the estimate (4.42) on $]0, R_n[$ it will be sufficient to show that (4.42) is verified on $]0, R[$, assuming that $R > 0$.

As observed in Step 5 of § 5.7, the assumption that ω satisfies condition (4.42) of Theorem 4.7 is equivalent to the fact that the maps

$$\phi(x) \doteq -\tau(x) \cdot f_l' \circ \pi_{l,+}^r(\omega(x)), \quad \tau(x) \doteq T - \frac{x}{f_r'(\omega(x))}, \quad x \in]0, R[. \tag{5.197}$$

are, respectively, nondecreasing and decreasing. Then consider the corresponding maps for ω_n

$$\phi_n(x) \doteq -\tau_n(x) \cdot f_l' \circ \pi_{l,+}^r(\omega_n(x)), \quad \tau_n(x) \doteq T - \frac{x}{f_r'(\omega_n(x))}, \quad x \in]0, R[, \tag{5.198}$$

and compare their values in two points $0 < x_1 < x_2 < R$, of continuity for ω and ω_n :

- if $\omega_n(x_i) = \omega(x_i)$ for $i = 1, 2$, then one clearly has that $\phi_n(x_1) = \phi(x_1) \leq \phi(x_2) = \phi_n(x_2)$, $\tau_n(x_1) = \tau(x_1) > \tau(x_2) = \tau_n(x_2)$;

- if $\omega_n(x_i) \neq \omega(x_i)$ for $i = 1, 2$, then by definition (5.183) we have $\omega_n(x_i) = B_n$ for $i = 1, 2$ and therefore one has $\phi_n(x_1) < \phi_n(x_2)$, $\tau_n(x_1) > \tau_n(x_2)$;

- if $\omega_n(x_1) = \omega(x_1)$ and $\omega_n(x_2) \neq \omega(x_2)$, then by definition (5.183) we have $\omega_n(x_1) \geq B_n$, $\omega_n(x_2) = B_n$, which implies $f_r'(\omega_n(x_2)) \leq f_r'(\omega_n(x_1))$. Moreover, since $\omega(x) \geq \theta_r$, $\omega_n(x) \geq \theta_r$, it follows that $f_l' \circ \pi_{l,+}^r(\omega_n(x_1)) \geq f_l' \circ \pi_{l,+}^r(\omega_n(x_2))$. Hence, we derive that $\phi_n(x_1) \leq \phi_n(x_2)$ $\tau_n(x_1) > \tau_n(x_2)$;

- if $\omega_n(x_1) \neq \omega(x_1)$ and $\omega_n(x_2) = \omega(x_2)$, then by definition (5.183) we have $\omega_n(x_1) = B_n > \omega(x_1)$, which implies $f_r'(\omega_n(x_1)) > f_r'(\omega(x_1))$. Notice that by definition (4.4) of R it follows that $\omega(x_1) \geq \theta_r$. Since also $\omega_n(x_1) \geq \theta_r$, we deduce that $f_l' \circ \pi_{l,+}^r(\omega_n(x_1)) > f_l' \circ \pi_{l,+}^r(\omega(x_1))$. Thus, it follows that $\phi_n(x_1) < \phi(x_1) \leq \phi(x_2) = \phi_n(x_2)$, $\tau_n(x_1) > \tau(x_1) > \tau(x_2) = \tau_n(x_2)$.

Hence, extending the above estimates to the right limits of ω_n in its points of discontinuity, we have shown that there holds

$$\phi_n(x_1) \leq \phi_n(x_2), \quad \tau_n(x_1) > \tau_n(x_2) \quad \forall 0 < x_1 < x_2 < R. \tag{5.199}$$

In turn, the monotonicity (5.199) of ϕ_n, τ_n is equivalent to the fact that ω_n satisfies (4.42), by the same arguments of Step 5 of § 5.7.

Step 8. ($R_n = R = 0$, proof that ω_n satisfies (4.51) of Theorem 4.9).

The proof is entirely similar to the one of Step 6, under the assumption that ω satisfies the Oleinik estimates (4.51) of Theorem 4.9. This concludes the proof of the implication (3) \Rightarrow (1) for critical connections.

APPENDIX A. STABILITY OF SOLUTIONS WITH RESPECT TO CONNECTIONS AND BV BOUNDS

We provide here a proof of Properties (iv)-(v) of Theorem 2.7, which seems to be absent in the literature. To this end we first recall a by now classical technical lemma, useful for the analysis of stability of discontinuous conservation laws (e.g. see [14], [25, Proposition 1]). For sake of completeness we provide a proof below.

Lemma A.1. *Fix a connection (A, B) and let I^{AB} be the map in (2.10). Then, for any couple of pairs $(u_l, u_r), (v_l, v_r) \in \mathbb{R}^2$ that verify*

$$I^{AB}(u_l, u_r) \leq 0, \quad I^{AB}(v_l, v_r) \leq 0, \quad (\text{A.1})$$

and

$$f_l(u_l) = f_r(u_r), \quad f_l(v_l) = f_r(v_r), \quad (\text{A.2})$$

setting

$$\alpha(u_l, u_r, v_l, v_r) \doteq \text{sgn}(u_r - v_r) \cdot (f_r(u_r) - f_r(v_r)) - \text{sgn}(u_l - v_l) \cdot (f_l(u_l) - f_l(v_l)), \quad (\text{A.3})$$

there holds

$$\alpha(u_l, u_r, v_l, v_r) \leq 0. \quad (\text{A.4})$$

Proof. Observe that, if $u_r = v_r$ or $u_l = v_l$, then the left hand side of (A.4) is zero and (A.4) is verified. Hence, without loss of generality, we may assume that $u_r > v_r$ and $u_l \neq v_l$. If $u_l > v_l$, the left hand side of (A.4) is again zero, because of (A.2). Thus, assuming that $u_l < v_l$, we have

$$\alpha(u_l, u_r, v_l, v_r) = 2(f_r(u_r) - f_r(v_r)). \quad (\text{A.5})$$

If we suppose, by contradiction, that (A.4) is not verified, it would follow by (A.5), that $f_r(u_r) > f_r(v_r)$. Moreover, because of assumptions (A.1)-(A.2), and applying Lemma-2.6, we know that $f_r(u_r), f_r(v_r) \geq f_r(B)$. Since $u_r > v_r$, these inequalities together imply that $u_r \geq B$. On the other hand, by (A.2), it also holds $f_l(u_l) > f_l(v_l)$. Relying again on (A.1)-(A.2) and Lemma-2.6, we deduce that $f_l(u_l), f_l(v_l) \geq f_l(A)$, which, coupled with $u_l < v_l$, $f_l(u_l) > f_l(v_l)$, implies $u_l \leq A$. Hence, by Lemma 2.6 it follows that $u_r = B$ and $u_l = A$, and then we would have

$$\begin{aligned} \alpha(u_l, u_r, v_l, v_r) &= \alpha(A, B, v_l, v_r) \\ &= \text{sgn}(B - v_r) \cdot (f_r(B) - f_r(v_r)) - \text{sgn}(A - v_l) \cdot (f_l(A) - f_l(v_l)) \\ &= I^{AB}(v_l, v_r) \leq 0 \end{aligned} \quad (\text{A.6})$$

that is a contradiction. Therefore (A.4) is satisfied, and the proof is concluded. \square

In order to obtain stability with respect to perturbations of the connection, it will be useful the following quantitative version of Lemma A.1.

Lemma A.2. *Let $(A, B), (A', B')$ be two connections. Then, for any couple of pairs $(u_l, u_r), (v_l, v_r) \in \mathbb{R}^2$ that verify*

$$I^{AB}(u_l, u_r) \leq 0, \quad I^{A'B'}(v_l, v_r) \leq 0, \quad (\text{A.7})$$

and (A.2), there holds

$$\alpha(u_l, u_r, v_l, v_r) \leq 2|f_r(B') - f_r(B)|. \quad (\text{A.8})$$

Proof. With no loss of generality assume that $B' > B$. Then, applying Lemma 2.6, one deduces that $B' > B$, together with (A.2) and $I^{A'B'}(v_l, v_r) \leq 0$, implies that one of the following two holds:

- (1) $I^{AB}(v_l, v_r) \leq 0$,
- (2) $(v_l, v_r) = (A', B')$.

If (1) holds, then by Lemma A.1 we have $\alpha(u_l, u_r, v_l, v_r) \leq 0$, and therefore (A.8) is verified. Otherwise, (2) holds. In this case, we can add and subtract the non positive quantity $I^{AB}(u_l, u_r)$, and rewrite α as

$$\alpha(u_l, u_r, A', B') = \alpha_r(u_r) - \alpha_l(u_l) + I^{AB}(u_l, u_r) \leq \alpha_r(u_r) - \alpha_l(u_l), \quad (\text{A.9})$$

where

$$\begin{aligned} \alpha_r(u_r) &\doteq \operatorname{sgn}(u_r - B') \cdot (f_r(u_r) - f_r(B')) - \operatorname{sgn}(u_r - B) \cdot (f_r(u_r) - f_r(B)), \\ \alpha_l(u_l) &\doteq \operatorname{sgn}(u_l - A') \cdot (f_l(u_l) - f_l(A')) - \operatorname{sgn}(u_l - A) \cdot (f_l(u_l) - f_l(A)). \end{aligned}$$

We provide separately an estimate on $\alpha_r(u_r)$ and on $\alpha_l(u_l)$. We consider first the term α_r , and we distinguish three cases.

(1) $u_r > B'$. Then one has

$$\alpha_r(u_r) = f_r(u_r) - f_r(B') - f_r(u_r) + f_r(B) = f_r(B) - f_r(B').$$

(2) $u_r \in [B, B']$. Observe that, applying Lemma 2.6 and relying on (A.2) and $I^{AB}(u_l, u_r) \leq 0$, we deduce $f_r(u_r) \geq f_r(B)$. Then one has

$$\begin{aligned} \alpha_r(u_r) &= -f_r(u_r) + f_r(B') - f_r(u_r) + f_r(B) \\ &= (f_r(B) + f_r(B') - 2f_r(u_r)) \leq (f_r(B') - f_r(B)). \end{aligned}$$

(3) $u_r < B$. Then one has

$$\alpha_r(u_r) = -f_r(u_r) + f_r(B') + f_r(u_r) - f_r(B) \leq f_r(B') - f_r(B).$$

In every case, we obtain

$$\alpha_r(u_r) \leq |f_r(B') - f_r(B)|. \quad (\text{A.10})$$

Analogously, and thanks to (A.2), we can prove that

$$\alpha_l(u_l) \geq -|f_l(A') - f_l(A)| = -|f_r(B') - f_r(B)| \quad (\text{A.11})$$

which in turn, together with (A.10), implies

$$\alpha(u_l, u_r, A', B') \leq 2|f_r(B') - f_r(B)|, \quad (\text{A.12})$$

and this concludes the proof of the lemma. \square

Proposition A.3. *In the same setting of Theorem 2.7, for every $u_0 \in \mathbf{L}^\infty(\mathbb{R})$, and for any bounded set $K \subset \mathbb{R}$, the following properties are verified.*

(i) *For any non critical connection (A, B) , there exists a constant $C_1 = C_1(A, B, \|u_0\|_{\mathbf{L}^\infty}, K) > 0$ such that there holds*

$$\operatorname{Tot.Var.}(\mathcal{S}_t^{[AB]^+} u_0, K) \leq \frac{C_1}{t} \quad \forall t > 0. \quad (\text{A.13})$$

(ii) *There exists a constant $C_2 = C_2(\|u_0\|_{\mathbf{L}^\infty}, K) > 0$ such that, for any connection (A, B) , there holds*

$$\begin{aligned} \operatorname{Tot.Var.}(f_l \circ \mathcal{S}_t^{[AB]^+} u_0, K \cap] - \infty, 0]) &\leq \frac{C_2}{t}, \\ \operatorname{Tot.Var.}(f_r \circ \mathcal{S}_t^{[AB]^+} u_0, K \cap [0, +\infty[) &\leq \frac{C_2}{t}, \end{aligned} \quad \forall t > 0, \quad (\text{A.14})$$

where the inequalities are understood to be verified whenever $K \cap] - \infty, 0] \neq \emptyset$, or $K \cap [0, +\infty[\neq \emptyset$, respectively.

Proof. Since $\mathcal{S}_t^{[AB]^+} u_0 \in \mathcal{A}^{[AB]}(t)$ and thanks to the implication (1) \Rightarrow (2) of Theorem 4.11, we know that $\mathcal{S}_t^{[AB]^+} u_0$ satisfies the conditions stated in Theorem 4.2, 4.7, or 4.9. We divide the proof in four steps.

Step 1. (*proof of (i)*).

In the case of a non critical connection (A, B) , it is well known that for initial data $u_0 \in BV(\mathbb{R})$, one has $\mathcal{S}_t^{[AB]^+} u_0 \in BV(\mathbb{R})$ for all $t > 0$ (see [25, Lemma 8] and [1, Theorem 2.13-(iii)]). Instead, for initial data $u_0 \in \mathbf{L}^\infty(\mathbb{R})$, we know that $\mathcal{S}_t^{[AB]^+} u_0$ satisfies the Oleinik-type inequalities stated in Theorem 4.2, 4.7, or 4.9. Thus, since (A, B) is a non critical connection, by the analysis in § 5.3 we deduce that $D^+(\mathcal{S}_t^{[AB]^+} u_0)$ satisfies one-sided uniform upper bounds as the ones provided by (5.85). In turn, such bounds yield the existence of uniform bounds on the total increasing variation (and hence on the total variation as well) of $\mathcal{S}_t^{[AB]^+} u_0$ on bounded subsets K of $[0, +\infty[$, which depend on the connection (A, B) , on the set K , and on $\|u_0\|_{\mathbf{L}^\infty}$. By similar arguments we derive bounds on the total variation of $\mathcal{S}_t^{[AB]^+} u_0$ on bounded subsets of $] -\infty, 0]$, which yields (A.13), completing the proof of (i).

Step 2. (*proof of (ii) when $\mathcal{S}_t^{[AB]^+} u_0$ satisfies the conditions of Theorem 4.9*).

Since $\mathcal{S}_t^{[AB]^+} u_0$ satisfies the Oleinik-type inequalities (4.51) of Theorem 4.9, we immediately deduce a uniform bound on the total increasing variation of $\mathcal{S}_t^{[AB]^+} u_0$ on bounded sets, which does not depend on the values $f'_l(A), f'_r(B)$. In turn, such bounds yield the existence of uniform bounds on the total increasing variation (and hence on the total variation as well) of $\mathcal{S}_t^{[AB]^+} u_0$ on bounded subsets K of $[0, +\infty[$, which depend on the set K and on $\|u_0\|_{\mathbf{L}^\infty}$. By similar arguments we derive bounds on the total variation of $\mathcal{S}_t^{[AB]^+} u_0$ on bounded subsets of $] -\infty, 0]$, which yields (A.13), with a constant C_1 that depends only on the set K and on $\|u_0\|_{\mathbf{L}^\infty}$. In turn, (A.13) yields (A.14) relying on the Lipschitzianity of f_l, f_r on the set $[-M, M]$, with $M \doteq \|u_0\|_{\mathbf{L}^\infty}$. This completes the proof of (ii) in the case where $\mathcal{S}_t^{[AB]^+} u_0$ satisfies the conditions stated in Theorem 4.9.

Step 3. (*proof of (ii) when $\mathcal{S}_t^{[AB]^+} u_0$ satisfies the conditions of Theorem 4.7*).

To fix the ideas, we assume that $\omega \doteq \mathcal{S}_t^{[AB]^+} u_0$ satisfies the inequalities (i)' and the pointwise constraints-(ii)' stated in Theorem 4.7. Notice that, by the same arguments of above, (4.41) yields the estimate (A.13) (and hence also (A.14)) for bounded set $K \subset] -\infty, 0]$ or $K \subset [\mathbf{R}, +\infty[$. Then consider a set $K \subset [0, \mathbf{R}]$, with $\mathbf{R} = \mathbf{R}[\omega, f_r]$ defined as in (4.4), and assume that the inequalities (4.42), (4.44), are satisfied. Observe that, by the uniform convexity (1.4) of f_l, f_r , we have

$$\frac{f_l'' \circ \pi_{l,+}^r(u)}{[f_l' \circ \pi_{l,+}^r(u)]^2} \geq c_1, \quad f_r''(u) \geq c_1, \quad \forall |u| \leq \|\omega\|_{\mathbf{L}^\infty}, \quad (\text{A.15})$$

for some constant $c_1 > 0$ depending on $\|\omega\|_{\mathbf{L}^\infty}$. Moreover, by definition (4.4) of \mathbf{R} there holds

$$t \cdot f_r'(\omega(x)) > x \quad \forall x \in [0, \mathbf{R}[, \quad t > 0. \quad (\text{A.16})$$

Hence, recalling the definition (4.7) of the function h , and relying on (4.42), (4.44), (A.15), (A.16), we derive

$$\begin{aligned} D^+(f_r \circ \omega)(x) &= f_r'(\omega(x)) D^+ \omega(x) \\ &\leq f_r'(\omega(x)) h[\omega, f_l, f_r](x) \\ &\leq \frac{[f_r'(\omega(x))]^2}{c_1 [f_r'(\omega(x))]^2 (t \cdot f_r'(\omega(x)) - x) + c_1 x} \quad \forall x \in [0, \mathbf{R}[, \quad t > 0. \end{aligned} \quad (\text{A.17})$$

Towards an estimate of (A.17), consider the map

$$\Phi(x, t, u) \doteq \begin{cases} \frac{[f'_r(u)]^2}{[f'_r(u)]^2(t \cdot f'_r(u) - x) + x}, & \text{if } u > \theta_r, \\ 0, & \text{if } u = \theta_r, \end{cases} \quad x \in [0, \mathbf{R}[, \quad t > 0. \quad (\text{A.18})$$

By direct computations one finds

$$\Phi_u(x, t, u) = \frac{f'_r(u) f''_r(u) (2x - t [f'_r(u)]^3)}{\left([f'_r(u)]^2(t \cdot f'_r(u) - x) + x\right)^2}.$$

Hence, since $f'_r(u) \geq 0$ for all $u \geq \theta_r$, and because $f''_r(u) > 0$ for all u , we deduce that, setting

$$u_{x,t} \doteq (f'_r)^{-1} \left(\sqrt[3]{\frac{2x}{t}} \right), \quad (\text{A.19})$$

for all $x, t > 0$ there holds

$$u_{x,t} > \theta_r, \quad \Phi_u(x, t, u) \begin{cases} \geq 0 & \text{if } u \in [\theta_r, u_{x,t}], \\ \leq 0 & \text{if } u \geq u_{x,t}. \end{cases} \quad (\text{A.20})$$

In turn, (A.19), (A.20) imply that $u_{x,t}$ is a point of global maximum for the map $u \mapsto \Phi(x, t, u)$, $u \geq \theta_r$. On the other hand, because of (A.20) we have

$$t \cdot f'_r(u_{x,t}) > x \quad \implies \quad x < \sqrt{2} t. \quad (\text{A.21})$$

Thus we find

$$\Phi(x, t, u) \leq \Phi(x, t, u_{x,t}) = \frac{1}{\sqrt[3]{x} \left(3 \left(\frac{t}{2} \right)^{\frac{2}{3}} - x^{\frac{2}{3}} \right)} < \frac{1}{\sqrt[3]{x}} \left(\frac{2}{t} \right)^{\frac{2}{3}}, \quad \forall x < \sqrt{2} t, \quad u \geq \theta_r, \quad (\text{A.22})$$

and

$$\Phi(x, t, u) \leq \frac{[f'_r(u)]^2}{x} \leq \frac{c_2}{t}, \quad \forall x \geq \sqrt{2} t, \quad \theta_r \leq u \leq \|\omega\|_{\mathbf{L}^\infty}, \quad (\text{A.23})$$

for some constant c_2 depending on $\|\omega\|_{\mathbf{L}^\infty}$. Then, relying on (A.16), (A.17), (A.18), (A.21), (A.22), (A.23), we derive

$$D^+(f_r \circ \omega)(x) \leq \begin{cases} \frac{c_3}{\sqrt[3]{x} t^{\frac{2}{3}}} & \text{if } x < \sqrt{2} t, \quad x \in [0, \mathbf{R}[, \\ \frac{c_3}{t} & \text{if } x \geq \sqrt{2} t, \quad x \in [0, \mathbf{R}[, \end{cases} \quad (\text{A.24})$$

for some other constant c_3 depending on $\|\omega\|_{\mathbf{L}^\infty}$. Hence, recalling Remark 2.8, we deduce that, given a bounded set $K \subset [0, \mathbf{R}]$, there holds

$$\int_K D^+(f_r \circ \mathcal{S}_t^{[AB]^+} u_0)(x) dx \leq \frac{C}{t},$$

for some constant C depending only on $\|u_0\|_{\mathbf{L}^\infty}, K$, which yields (A.14). This completes the proof of (ii) in the case where $\mathcal{S}_t^{[AB]^+} u_0$ satisfies the conditions stated in Theorem 4.7.

Step 4. (proof of (ii) when $\mathcal{S}_t^{[AB]^+} u_0$ satisfies the conditions of Theorem 4.2).

Since $\mathcal{S}_t^{[AB]^+} u_0$ satisfies the Oleinik-type inequalities (4.11) of Theorem 4.2, with the same analysis of Step 2 we deduce the uniform bound in (A.14) for bounded subset K of $] - \infty, \mathbf{L}]$ or of $[\mathbf{R}, +\infty[$. Instead, for sets $K \subset [0, \mathbf{R}]$ or $K \subset [\mathbf{L}, 0]$, relying on the Oleinik-type inequalities (4.12), (4.13), of Theorem 4.2, we recover the bound in (A.14) performing the same analysis of Step 3. This completes

the proof of (ii) in the case where $S_t^{[AB]^+}u_0$ satisfies the conditions stated in Theorem 4.2, and concludes the proof of the proposition. \square

Proof of Theorem 2.7-(iv)-(v). Set

$$u(x, t) \doteq \mathcal{S}_t^{[AB]^+}u_0(x), \quad v(x, t) \doteq \mathcal{S}_t^{[A'B']^+}v_0(x). \quad (\text{A.25})$$

Relying on property (2) of Definition 2.2, with standard doubling of variable arguments (e.g. see [15, §6.3]) one obtains that, for every non-negative test function $\phi \in \mathcal{C}_c^1$ with compact support contained in $] -\infty, 0[\times]0, +\infty[$, there holds

$$\int_{-\infty}^0 \int_0^{\infty} \{ |u - v| \phi_t + \operatorname{sgn}(u - v) (f_l(u) - f_l(v)) \phi_x \} dx dt \geq 0, \quad (\text{A.26})$$

and, for every non-negative test function $\phi \in \mathcal{C}_c^1$ with compact support contained in $]0, +\infty[\times]0, +\infty[$, there holds

$$\int_0^{\infty} \int_0^{\infty} \{ |u - v| \phi_t + \operatorname{sgn}(u - v) (f_r(u) - f_r(v)) \phi_x \} dx dt \geq 0. \quad (\text{A.27})$$

Hence, with the same arguments, one deduces that, for every non-negative test function $\phi \in \mathcal{C}_c^1$ with compact support contained in $\mathbb{R} \times]0, +\infty[$, there holds

$$\int_0^{+\infty} \int_{-\infty}^{+\infty} \{ |u - v| \phi_t + \operatorname{sgn}(u - v) (f(x, u) - f(x, v)) \phi_x \} dx dt \geq -E, \quad (\text{A.28})$$

where E is the extra boundary term at $x = 0$ (due to the fact that, differently from (A.26)-(A.27), ϕ will not vanish in general at $x = 0$) given by

$$E = \int_0^{+\infty} [\operatorname{sgn}(u(x, t) - v(x, t)) (f(x, u(x, t)) - f(x, v(x, t)))]_{x=0-}^{x=0+} \phi(0, t) dt,$$

with $[\cdot]_{x=0-}^{x=0+}$ denoting the limit from the right minus the limit from the left at $x = 0$. Observe that, letting u_l, u_r denote the one-sided limit of u in $x = 0$ as in (2.7), and denoting v_l, v_r , the corresponding ones for v , recalling (A.3) we can rewrite the quantity E as

$$E = \int_0^{+\infty} \alpha(u_l(t), u_r(t), v_l(t), v_r(t)) \phi(0, t) dt. \quad (\text{A.29})$$

On the other hand, since u_l, u_r , and v_l, v_r satisfy the Rankine-Hugoniot condition (2.8), together with the inequality (2.11) related to the (A, B) , and (A', B') connection, respectively, applying Lemma A.2 we deduce that there holds

$$\alpha(u_l(t), u_r(t), v_l(t), v_r(t)) \leq 2 |f_r(B') - f_r(B)| \quad \text{for a.e. } t > 0. \quad (\text{A.30})$$

Thus, combining (A.28) with (A.29), (A.8), we find

$$\int_0^{+\infty} \int_{-\infty}^{+\infty} \{ |u - v| \phi_t + \operatorname{sgn}(u - v) (f(x, u) - f(x, v)) \phi_x \} dx dt \geq -2 |f_r(B) - f_r(B')| \int_0^{+\infty} \phi(0, t) dt. \quad (\text{A.31})$$

Now fix $\tau > \tau_0 > 0$, $R > 0$, and consider the trapezoid $\Omega \doteq \{(x, t) : \tau_0 \leq t \leq \tau, |x| \leq R + L(\tau - t)\}$, where $L \doteq \sup_{|z| \leq M} \max\{|f_l'(z)|, |f_r'(z)|\}$, with M being a uniform \mathbf{L}^∞ bound for u and v . Then, by a standard technique (e.g. see [15, §6.3]), one can construct a sequence of test functions $\phi_n \in \mathcal{C}_c^1$, with compact support contained in $\mathbb{R} \times]0, +\infty[$, that approximate the characteristic function of Ω when $n \rightarrow \infty$. Employing (A.31) with ϕ_n , and letting $n \rightarrow \infty$ we obtain

$$\int_{|x| \leq R} |u(x, \tau) - v(x, \tau)| dx \leq \int_{|x| \leq R + L(\tau - \tau_0)} |u(x, \tau_0) - v(x, \tau_0)| dx + 2(\tau - \tau_0) |f_r(B) - f_r(B')|. \quad (\text{A.32})$$

Relying on the \mathbf{L}^1 -continuity of u and v at $\tau_0 = 0$ (property (2) of Definition 2.2), and letting $R \rightarrow \infty$ in (A.32), we obtain the estimate of Theorem 2.7-(iv) for $t = \tau$.

To establish property (v) of Theorem 2.7 observe that, if (A, B) is a non critical connection, then by Lemma A.3-(i) one has $\mathcal{S}_t^{AB} u_0 \in BV_{loc}(\mathbb{R})$ for all $t > 0$, and for any $u_0 \in \mathbf{L}^\infty(\mathbb{R})$. Therefore, in this case, relying on this property we immediately recover the \mathbf{L}_{loc}^1 -Lipschitz continuity of $t \mapsto \mathcal{S}_t^{AB} u_0$ by standard arguments (e.g. see [15, proof of Theorem 9.4]). Instead, in the case of a critical connection (A, B) , we derive the \mathbf{L}_{loc}^1 -Lipschitz continuity of $t \mapsto \mathcal{S}_t^{AB} u_0$ applying Lemma A.3-(ii) and following the same arguments in [21, proof of Theorem 4.3.1]. \square

Proof of Corollary 2.9. Relying on Theorem 2.7-(iv) we deduce that

$$u_n(\cdot, t) \rightarrow u(\cdot, t) \quad \text{in } \mathbf{L}^1(\mathbb{R}) \quad \forall t \geq 0, \quad (\text{A.33})$$

which in turn implies that there exists $\bar{x} > 0$ such that

$$f_r(u_n(\bar{x}, \cdot)) \rightarrow f_r(u(\bar{x}, \cdot)) \quad \text{in } \mathbf{L}_{loc}^1([0, +\infty[), \quad (\text{A.34})$$

for every fixed $T > 0$. Then, observe that by Definition 2.2 u_n and u are entropy weak solutions of $u_t + f_r(u)_x = 0$ on $]0, +\infty[\times]0, +\infty[$. Hence, by a general property of weak solutions (e.g. see [15, Remark 4.2]) one has

$$\begin{aligned} \int_0^T f_r(u_r(s)) ds &= \int_0^T f_r(u(\bar{x}, \cdot)) ds + \int_0^{\bar{x}} u(z, T) dz - \int_0^{\bar{x}} u(z, 0) dz, \\ \int_0^T f_r(u_{n,r}(s)) ds &= \int_0^T f_r(u_n(\bar{x}, \cdot)) ds + \int_0^{\bar{x}} u_n(z, T) dz - \int_0^{\bar{x}} u_n(z, 0) dz \quad \forall n. \end{aligned} \quad (\text{A.35})$$

Since we are assuming that $\{u_n(\cdot, 0)\}_n$ converges to $u(\cdot, 0)$ in \mathbf{L}^1 , taking the limit as $n \rightarrow \infty$ in (A.35) we deduce from (A.33)-(A.34) that

$$f_r(u_{n,r}) \rightarrow f_r(u_r) \quad \text{in } \mathbf{L}^1([0, T]) \quad (\text{A.36})$$

for all $T > 0$, and with entirely similar arguments one derives also the other convergence in (2.15). \square

APPENDIX B. PRECLUSION OF RAREFACTIONS EMANATING FROM THE INTERFACE

A distinctive feature of the structure of AB -entropy solutions is the fact that no rarefaction wave can emerge at positive times from the interface $x = 0$. This property was established in [2] exploiting an explicit representation formula for AB -entropy solutions a la Lax-Oleřnik. A different, rather technical proof, based on a detailed analysis of the structure of AB -entropy solutions was derived in [6], under the additional assumption that the traces of the solution at $x = 0$ admit one sided limits. Here, we provide a much simpler proof that establishes this fact in the case of a non critical connection (A, B) , and for a BV_{loc} AB -entropy solution. The proof relies on the properties of solutions of Riemann problems and on a blow-up argument.

Definition B.1. We say that an AB -entropy solution to (1.1) has a *rarefaction wave emerging at the left (at the right) from the interface $x = 0$* at time \bar{t} , if there exists an outgoing rarefaction fan centered at $(0, \bar{t})$, and located in the halfplane $\{x \leq 0\}$ ($\{x \geq 0\}$).

Proposition B.2. *Let (A, B) be a connection, consider a Riemann data*

$$\bar{u} = \begin{cases} u^-, & x < 0, \\ u^+, & x > 0, \end{cases} \quad (\text{B.1})$$

and assume that the solution $\mathcal{S}_t^{[AB]^+} \bar{u}(x)$ contains a rarefaction wave located in the left halfplane $\{x \leq 0\}$, or in the right one $\{x \geq 0\}$. Then for every $T > 0$ it holds $\bar{u} \notin \mathcal{A}^{[AB]}(T)$.

Proof. By contradiction, suppose that $\mathcal{S}_t^{[AB]^+}\bar{u}(x)$ contains a rarefaction wave located in $\{x \geq 0\}$, and assume that $\bar{u} \in \mathcal{A}^{[AB]}(T)$, i.e. that there exists an AB -entropy solution $u(x, t)$ of (1.1),(1.2), such that $u(\cdot, T) = \bar{u}$. Then, by uniqueness, one has $u(x, T+t) = \mathcal{S}_t^{[AB]^+}\bar{u}(x)$ for all $x \in \mathbb{R}$, $t \geq 0$. Since $\mathcal{S}_t^{[AB]^+}\bar{u}(x)$ is a solution of a Riemann problem containing a rarefaction with nonnegative characteristic speeds, and because of the admissibility conditions (2.13), it then follows that the right trace u_r of u at $x = 0$ satisfies $B \leq u_r(t) < u(T, x) = u^+$ for every $t > T$, $x > 0$. Tracing the backward characteristics from points (T, x) , $x > 0$, we find that $u_r(t) = u^+ > B$ for every $t \in]0, T[$. Therefore, because of the admissibility conditions (2.13), one has $u_l(t) = \pi_{l,+}^r(u^+)$ (with $\pi_{l,+}^r$ defined as in (4.1)), for every $t \in]0, T[$. Then, letting ξ_-, ξ_+ denote the minimal and maximal backward characteristics starting at $(0, T)$, we deduce that $f_l'(u^-) = \dot{\xi}_-(T) > \dot{\xi}_+(T) = f_l'(\pi_{r,+}^l(u^+))$, which in turn implies $u^- > \pi_{l,+}^r(u^+)$, $\pi_{r,+}^l(u^-) > u^+$. Observe now that the AB -entropy solution of a Riemann problem with initial data (B.1) satisfying $u^- > \pi_{r,+}^l(u^+)$, and $u^+ > B$, consists of a single shock located in the halfplane $\{x \geq 0\}$, and connecting the left state $\pi_{r,+}^l(u^-)$ with the right state u^+ . This is in contrast with the assumption made on $\mathcal{S}_t^{[AB]^+}\bar{u}(x)$, thus completing the proof. \square

Proposition B.3. *Let (A, B) be a noncritical connection, and let u be an AB -entropy solution to (1.1) that satisfies $u(\cdot, t) \in BV_{\text{loc}}(\mathbb{R})$, for all $t > 0$. Then u does not contain rarefaction waves emerging from the interface $x = 0$ at times $\bar{t} > 0$.*

Proof. Assume by contradiction that the solution u has a rarefaction wave, say located in $\{x \geq 0\}$, which emerges from the interface at some time $\bar{t} > 0$. Let $0 < \bar{\rho} < \bar{t}/3$, and for any $\rho > 0$, set

$$I_\rho \doteq \{x \in \mathbb{R} : |x| \leq \rho\}. \quad (\text{B.2})$$

Observe that the domain of dependence of $u(x, t)$, for $(x, t) \in I_{\bar{\rho}} \times [\bar{t} - \bar{\rho}, \bar{t} + \bar{\rho}]$, is the trapezoid $\Omega \doteq \{(x, t) : |x| \leq \bar{\rho} + \Lambda \cdot (\bar{t} + \bar{\rho} - t), t \in [\bar{t} - 2\bar{\rho}, \bar{t} + \bar{\rho}]\}$, where $\Lambda \doteq \sup_{|z| \leq M} \max\{|f_l'(z)|, |f_r'(z)|\}$, with M being a uniform \mathbf{L}^∞ bound for u . Therefore, since the total variation of $u(t, \cdot)$ on I_{l_t} , $l_t \doteq |x| \leq \bar{\rho} + \Lambda \cdot (\bar{t} + \bar{\rho} - t)$, is bounded, and because (A, B) is a noncritical connection, we can invoke the uniform BV bounds on AB -entropy solutions established in [25, Lemma 8] (see also [1, Theorem 2.13-(iii)]) to deduce that

$$\text{Tot.Var.}(u(\cdot, t), I_{\bar{\rho}}) \leq \bar{C}(M + \text{Tot.Var.}(u(\cdot, \bar{t} - 2\bar{\rho}), I_{(1+2\Lambda)\bar{\rho}})) \quad \forall t \in \bar{t} + I_{\bar{\rho}}, \quad (\text{B.3})$$

for some constant $\bar{C} > 0$. Next, consider the blow-up of u at the point $(0, \bar{t})$:

$$u_\rho(x, t) \doteq u(\rho x, \bar{t} + \rho(t - \bar{t})) \quad x \in \mathbb{R}, t \geq 0, \quad (\text{B.4})$$

with $0 < \rho < \bar{\rho}/\bar{t}$, and observe that there holds

$$\text{Tot.Var.}(u_\rho(\cdot, t), I_{\bar{\rho}/\rho}) \leq \sup_{\tau \in \bar{t} + I_{\bar{\rho}}} \text{Tot.Var.}(u(\cdot, \tau), I_{\bar{\rho}}) \quad \forall 0 \leq t < \bar{t} + \frac{\bar{\rho}}{\rho}. \quad (\text{B.5})$$

Combining (B.3), (B.5), we find a uniform bound on the total variation of $u_r(\cdot, t)$ on the interval $I_{\bar{\rho}/\rho}$, for all $t < \bar{t} + \bar{\rho}/\rho$, and $0 < \rho < \bar{\rho}/\bar{t}$. Moreover, observe that because of the finite speed of propagation Λ , by standard arguments (e.g. see [15, §7.4]) one deduces that

$$\|u_\rho(\cdot, t) - u_\rho(\cdot, s)\|_{\mathbf{L}^1(I_{\bar{\rho}/\rho})} \leq \bar{\Lambda} \cdot (t - s) \quad \forall 0 \leq s < t < \bar{t} + \frac{\bar{\rho}}{\rho}, \quad (\text{B.6})$$

for all $0 < \rho < \bar{\rho}/\bar{t}$, and for some constant $\bar{\Lambda}$. Notice that the sets $I_{\bar{\rho}/\rho} \times [0, \bar{t} + \bar{\rho}/\rho[$ invade $\mathbb{R} \times [0, +\infty[$ as $\rho \rightarrow 0$. Therefore we can apply Helly's compactness theorem [15, Theorem 2.4] to the sequence $\{u_\rho\}_{0 < \rho < \bar{\rho}/\bar{t}}$, and deduce the existence of a function $v \in \mathbf{L}^\infty(\mathbb{R} \times [0, +\infty[)$, so that, up

to a subsequence, $u_\rho(\cdot, t)$ converges to $v(\cdot, t)$ in $\mathbf{L}^1_{\text{loc}}$, as $\rho \rightarrow 0$, for all $t > 0$. By Definition 2.2 it follows that also v is an AB -entropy solution of (1.1)-(1.2), with $u_0 \doteq v(\cdot, 0)$. Notice that

$$\lim_{\rho \rightarrow 0} u_\rho(x, \bar{t}) = \bar{u}(x) \doteq \begin{cases} u(0+, \bar{t}) & \text{if } x > 0, \\ u(0-, \bar{t}) & \text{if } x < 0, \end{cases} \quad (\text{B.7})$$

and thus we find

$$v(\cdot, \bar{t}) = \bar{u},$$

which implies

$$\bar{u} \in \mathcal{A}^{[AB]}(\bar{t}). \quad (\text{B.8})$$

On the other hand, observe that the rarefaction wave which emerges in the solution u at time \bar{t} is preserved by the blow-ups u_ρ in (B.4), because it is self similar for the scaling $(x, t) \mapsto (\rho x, \bar{t} + \rho(t - \bar{t}))$. Therefore there will be a rarefaction wave emerging at time \bar{t} , and located in $\{x \geq 0\}$, also in the solution v . This in turn implies that the solution $\mathcal{S}_t^{AB}\bar{u}(x)$ to the Riemann problem with initial datum \bar{u} contains a rarefaction emerging at $t = 0$ and located in $\{x \geq 0\}$, since $\mathcal{S}_t^{AB}\bar{u}(x) = v(\bar{t} + t, x)$ for all $x \in \mathbb{R}$, $t \geq 0$. This, together with (B.8), is in contradiction with Proposition B.2, thus completing the proof. \square

APPENDIX C. SEMICONTINUOUS PROPERTIES OF SOLUTIONS TO CONVEX CONSERVATION LAWS

Solutions to conservation laws with convex flux enjoy a lower and upper semicontinuity property with respect to the \mathbf{L}^1 convergence as stated in the following

Lemma C.1. *Given a uniformly convex map f , and $T > 0$, let $\{u_n\}_n$ be a sequence of entropy weak solutions of*

$$u_t + f(u)_x = 0 \quad x > 0, \quad t \in [0, T], \quad (\text{C.1})$$

that admit a strong trace $u_n(0+, t) = \lim_{x \rightarrow 0+} u_n(x, t)$ at $x = 0$, for all $t \in [0, T]$, and let u be an entropy weak solution of (C.1) that admits a strong trace $u(0+, t) = \lim_{x \rightarrow 0+} u(x, t)$ at $x = 0$, for all $t \in [0, T]$. Assume that $\{u_n\}_n$ are uniformly bounded in \mathbf{L}^∞ , that

$$u_n(\cdot, t) \rightarrow u(\cdot, t) \quad \text{in } \mathbf{L}^1(]0, +\infty[), \quad \forall t \in [0, T], \quad (\text{C.2})$$

and that

$$f(u_n(0+, \cdot)) \rightarrow f(u(0+, \cdot)) \quad \text{in } \mathbf{L}^1([0, T]). \quad (\text{C.3})$$

Then, for every $x \geq 0$, there holds

$$u(x+, T) \leq \liminf_{\substack{n \rightarrow \infty \\ y \rightarrow x}} u_n(y+, T). \quad (\text{C.4})$$

If we assume that u_n, u , are entropy weak solutions of $u_t + f'(u)_x = 0$ on $x < 0$, $t \in [0, T]$, and that the convergence (C.2), (C.3), hold in $\mathbf{L}^1(]-\infty, 0])$, and for the left traces in $x = 0$, respectively, then for every $x \leq 0$, there holds

$$u(x-, T) \geq \limsup_{\substack{n \rightarrow \infty \\ y \rightarrow x}} u_n(y-, T). \quad (\text{C.5})$$

Proof. We will establish only the inequality (C.4), the proof of (C.5) being entirely similar. Given $x \geq 0$, $T > 0$, consider a sequence $\{y_n\}_n$, $y_n > 0$, converging to x , and such that

$$\lim_n u_n(y_n+, T) = \liminf_{\substack{n \rightarrow \infty \\ y \rightarrow x}} u_n(y+, T). \quad (\text{C.6})$$

Let $\vartheta_n^+ :]\tau_n, T] \rightarrow]0, +\infty[$, $\tau_n \geq 0$, denote the the maximal backward characteristic for u_n starting from (y_n, T) , with the property that either $\tau_n = 0$, or $\lim_{t \rightarrow \tau_n} \vartheta_n^+(t) = 0$. By possibly taking a subsequence, we can assume that either $\tau_n = 0$ for all n , or that $\lim_{t \rightarrow \tau_n} \vartheta_n^+(t) = 0$ for all n . We recall that a maximal backward characteristic for u_n passing through (y_n, T) , $y > 0$, is a genuine

(shock free) characteristics whose trajectory is a segment with constant slope $f'(u_n(y_n+, T))$ (e.g. see [21]). Notice that $\{\vartheta_n^+\}_n$ is a sequence of Lipschitz continuous functions with a uniform Lipschitz constant $\sup_{|u| \leq M} f'(u)$ (M being a uniform \mathbf{L}^∞ bound on u_n), defined on uniformly bounded intervals $]\tau_n, T]$. Hence, by Ascoli Arzelà Theorem we can assume that, up to a subsequence, $\{\vartheta_n^+\}_n$ converges uniformly to some Lipschitz continuous function $\vartheta :]\tau, T] \rightarrow]0, +\infty[$, such that

$$\begin{aligned} \tau = 0, & \quad \text{if} \quad \tau_n = 0 \quad \forall n, \\ \tau = \lim_{n \rightarrow \infty} \tau_n, & \quad \lim_{t \rightarrow \tau} \vartheta(t) = 0, \quad \text{if} \quad \lim_{t \rightarrow \tau_n} \vartheta_n^+(t) = 0 \quad \forall n, \end{aligned} \tag{C.7}$$

and such that $\vartheta(T) = x$. By a general property of characteristics, the uniform limit of genuine characteristics is also a genuine characteristic. This can be easily verified in this context observing that the trajectory of a genuine characteristic passing through a point (y, t) , $y > 0$, is a segment connecting (y, t) with the point $(0, \tau(y, t))$ or with the point $(z(y, t), 0)$, where $\tau(y, t)$ and $z(y, t)$ denotes the points of minimum for the functionals involved in the Lax-Oleïnik representation formula of solutions for the boundary value problem (see [31]), and that such functionals are \mathbf{L}^1 continuous with respect to the initial datum and with respect to the flux-trace of the solution at $x = 0$. Therefore it follows that ϑ is a genuine characteristic with constant slope ϑ' satisfying

$$\vartheta' = \lim_{n \rightarrow \infty} (\vartheta_n^+)' = \lim_{n \rightarrow \infty} f'(u_n(y_n+, T)), \quad \vartheta' \geq f'(u(x+, T)). \tag{C.8}$$

Since f' is increasing, we deduce from (C.8) that

$$\lim_n u_n(y_n+, T) \geq u(x+, T), \tag{C.9}$$

which, together with (C.6), yields (C.4). □

REFERENCES

- [1] Adimurthi, R. Dutta, S. S. Ghoshal, and G. D. Veerappa Gowda. Existence and nonexistence of TV bounds for scalar conservation laws with discontinuous flux. *Comm. Pure Appl. Math.*, 64(1):84–115, 2011.
- [2] Adimurthi and S. S. Ghoshal. Exact and optimal controllability for scalar conservation laws with discontinuous flux. *Commun. Contemp. Math.*, pages 1–54, 2022. (<https://doi.org/10.1142/S0219199722500249>).
- [3] Adimurthi, S. S. Ghoshal, and G. D. Veerappa Gowda. Exact controllability of scalar conservation laws with strict convex flux. *Math. Control Relat. Fields*, 4(4):401–449, 2014.
- [4] Adimurthi, S. Mishra, and G. D. Veerappa Gowda. Optimal entropy solutions for conservation laws with discontinuous flux-functions. *J. Hyperbolic Differ. Equ.*, 2(4):783–837, 2005.
- [5] Adimurthi and G. D. Veerappa Gowda. Conservation law with discontinuous flux. *J. Math. Kyoto Univ.*, 43(1):27–70, 2003.
- [6] F. Ancona and M.T. Chiri. Attainable profiles for conservation laws with flux function spatially discontinuous at a single point. *ESAIM Control Optim. Calc. Var.*, 26:Paper No. 124, 33, 2020.
- [7] F. Ancona, O. Glass, and K.T. Nguyen. Lower compactness estimates for scalar balance laws. *Comm. Pure Appl. Math.*, 65(9):1303–1329, 2012.
- [8] F. Ancona and A. Marson. On the attainable set for scalar nonlinear conservation laws with boundary control. *SIAM J. Control Optim.*, 36(1):290–312, 1998.
- [9] F. Ancona and A. Marson. Scalar non-linear conservation laws with integrable boundary data. *Nonlinear Anal.*, 35(6, Ser. A: Theory Methods):687–710, 1999.
- [10] F. Ancona and L. Talamini. Initial data identification for conservation laws with spatially discontinuous flux. In preparation, 2023.
- [11] B. Andreianov. New approaches to describing admissibility of solutions of scalar conservation laws with discontinuous flux. In *CANUM 2014–42e Congrès National d’Analyse Numérique*, volume 50 of *ESAIM Proc. Surveys*, pages 40–65. EDP Sci., Les Ulis, 2015.
- [12] B. Andreianov and C. Cancès. On interface transmission conditions for conservation laws with discontinuous flux of general shape. *J. Hyperbolic Differ. Equ.*, 12(2):343–384, 2015.
- [13] B. Andreianov, K. H. Karlsen, and N. H. Risebro. A theory of L^1 -dissipative solvers for scalar conservation laws with discontinuous flux. *Arch. Ration. Mech. Anal.*, 201(1):27–86, 2011.

- [14] E. Audusse and B. Perthame. Uniqueness for scalar conservation laws with discontinuous flux via adapted entropies. *Proc. Roy. Soc. Edinburgh Sect. A*, 135(2):253–265, 2005.
- [15] A. Bressan. *Hyperbolic systems of conservation laws*, volume 20 of *Oxford Lecture Series in Mathematics and its Applications*. Oxford University Press, Oxford, 2000. The one-dimensional Cauchy problem.
- [16] R. Bürger, K. H. Karlsen, and J. D. Towers. An Engquist-Osher-type scheme for conservation laws with discontinuous flux adapted to flux connections. *SIAM J. Numer. Anal.*, 47(3):1684–1712, 2009.
- [17] S. Čanić. Blood flow through compliant vessels after endovascular repair: wall deformations induced by the discontinuous wall properties. *Computing and Visualization in Science*, 4(3):147–155, 2002.
- [18] Piermarco Cannarsa and Carlo Sinestrari. *Semiconcave functions, Hamilton-Jacobi equations, and optimal control*, volume 58 of *Progress in Nonlinear Differential Equations and their Applications*. Birkhäuser Boston, Inc., Boston, MA, 2004.
- [19] R. M. Colombo and V. Perrollaz. Initial data identification in conservation laws and Hamilton-Jacobi equations. *J. Math. Pures Appl. (9)*, 138:1–27, 2020.
- [20] C. M. Dafermos. Generalized characteristics and the structure of solutions of hyperbolic conservation laws. *Indiana Univ. Math. J.*, 26(6):1097–1119, 1977.
- [21] C. M. Dafermos. *Hyperbolic conservation laws in continuum physics*, volume 325 of *Grundlehren der Mathematischen Wissenschaften [Fundamental Principles of Mathematical Sciences]*, pages xxxviii+826. Springer-Verlag, Berlin, fourth edition, 2016.
- [22] C. Esteve and E. Zuazua. The inverse problem for Hamilton-Jacobi equations and semiconcave envelopes. *SIAM J. Math. Anal.*, 52(6):5627–5657, 2020.
- [23] C. Esteve-Yagiie and E. Zuazua. Reachable set for Hamilton-Jacobi equations with non-smooth Hamiltonian and scalar conservation laws. *Nonlinear Anal.*, 227:Paper No. 113167, 18, 2023.
- [24] L. Formaggia, F. Nobile, and A. Quarteroni. A one dimensional model for blood flow: application to vascular prosthesis. In *Mathematical modeling and numerical simulation in continuum mechanics (Yamaguchi, 2000)*, volume 19 of *Lect. Notes Comput. Sci. Eng.*, pages 137–153. Springer, Berlin, 2002.
- [25] M. Garavello, R. Natalini, B. Piccoli, and A. Terracina. Conservation laws with discontinuous flux. *Netw. Heterog. Media*, 2(1):159–179, 2007.
- [26] T. Gimse and N. H. Risebro. Solution of the Cauchy problem for a conservation law with a discontinuous flux function. *SIAM J. Math. Anal.*, 23(3):635–648, 1992.
- [27] T. Gimse and N. H. Risebro. A note on reservoir simulation for heterogeneous porous media. *Transport Porous Media*, 10:257–6270, 1993.
- [28] L. Gosse and E. Zuazua. Filtered gradient algorithms for inverse design problems of one-dimensional Burgers equation. In *Innovative algorithms and analysis*, volume 16 of *Springer INdAM Ser.*, pages 197–227. Springer, Cham, 2017.
- [29] T. Horsin. On the controllability of the Burgers equation. *ESAIM Control Optim. Calc. Var.*, 3:83–95, 1998.
- [30] S. N. Kruzhkov. First order quasilinear equations with several independent variables. *Mat. Sb. (N.S.)*, 81 (123):228–255, 1970.
- [31] P.G. LeFloch. Explicit formula for scalar non-linear conservation laws with boundary condition. *Math. Methods in Appl. Sci.*, 10(1):265–287, 1988.
- [32] T. Liard and E. Zuazua. Initial data identification for the one-dimensional Burgers equation. *IEEE Trans. Automat. Control*, 67(6):3098–3104, 2022.
- [33] S. Mochon. An analysis of the traffic on highways with changing surface conditions. *Math. Modelling*, 9(1):1–11, 1987.
- [34] D. N. Ostrov. Solutions of Hamilton-Jacobi equations and scalar conservation laws with discontinuous space-time dependence. *J. Differential Equations*, 182(1):51–77, 2002.
- [35] E. Y. Panov. Existence of strong traces for quasi-solutions of multidimensional conservation laws. *J. Hyperbolic Differ. Equ.*, 4(4):729–770, 2007.
- [36] Alexis Vasseur. Strong traces for solutions of multidimensional scalar conservation laws. *Arch. Ration. Mech. Anal.*, 160(3):181–193, 2001.