

# HIGHER SPIN REPRESENTATIONS OF THE YANGIAN OF $\mathfrak{sl}_2$ AND R-MATRICES

YAPING YANG AND PAUL ZINN-JUSTIN

**ABSTRACT.** We study higher spin (pure and mixed spin) representations of the Yangian of  $\mathfrak{sl}_2$ . We provide a geometric realization in terms of the critical cohomology of representations of the quiver with potential of Bykov and Zinn-Justin [BZJ20]. When the framing dimension is 1, it recovers the evaluation pullback of the  $\ell + 1$ -dimensional irreducible representation of  $\mathfrak{sl}_2$ . We introduce the lattice model and prove that its partition function coincides with the weight function constructed using the framed shuffle formula. The latter follows the approach of Rimányi, Tarasov and Varchenko [RTV15].

## CONTENTS

1. Introduction	1
2. Dimension reductions and torus fixed points	6
3. Proof of Theorem A and Proposition 1.1	10
4. Framed shuffle formula	19
5. The weight functions	21
6. Computation of $R$ -matrices	25
7. The lattice model	29
8. Relation to the stable envelope	33
Appendix A. Proof of Lemma 7.3	34
References	42

## 1. INTRODUCTION

In the paper, we consider the following triple quiver  $\tilde{Q}$ : with a gauge vertex  $\bullet$  and with  $w$  framing vertices  $\square_1, \dots, \square_w$ , where  $w \in \mathbb{N}$ . The set of arrows of  $\tilde{Q}$  is  $\{\epsilon, a_1, \dots, a_w, a_1^*, \dots, a_w^*\}$ , where  $\epsilon$  is a loop on  $\bullet$ ,  $a_i$  is

---

*Date:* March 27, 2024.

*2010 Mathematics Subject Classification.* Primary 17B37; Secondary 55N22, 16G20.

*Key words and phrases.* Yangian, quiver with potential, quiver with symmetrizer,  $R$ -matrix, stable envelope, lattice model, weight function.

an arrow from  $\bullet$  to  $\square_i$ , and  $a_i^*$  is the reversed arrow from  $\square_i$  to  $\bullet$ , for  $i = 1, \dots, w$ .

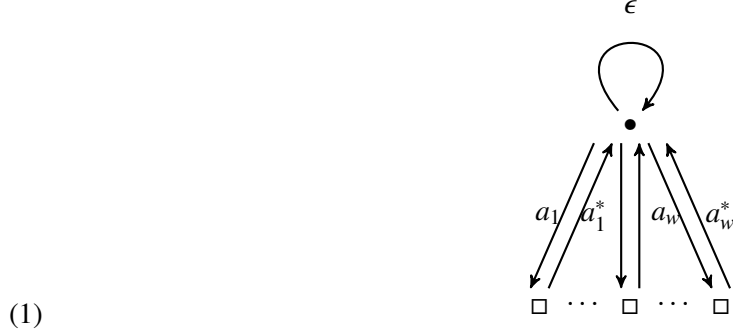

For  $w$ -tuple of positive integers  $(\ell_1, \ell_2, \dots, \ell_w) \in \mathbb{N}^w$ , let

(2)

$$\mathbf{w} = \epsilon^{\ell_1} a_1^* a_1 + \epsilon^{\ell_2} a_2^* a_2 + \dots + \epsilon^{\ell_w} a_w^* a_w$$

be the potential of the quiver  $\tilde{Q}$ . We are interested in this particular quiver with potential for a few reasons.

- (1) The critical cohomology, also known as the compact supported cohomology with valued in a perverse sheaf, of the stable representation variety of  $\tilde{Q}$  is a generalization of the cohomology of the cotangent bundle of Grassmannian. The latter corresponds to the case when  $\ell_1 = \dots = \ell_w = 1$ .
- (2) This quiver with potential gives the high spin representations of the Yangian of  $\mathfrak{sl}_2$ . When  $w = 1$ , one obtains the evaluation pullback of the  $\ell + 1$ -dimensional irreducible representation of  $\mathfrak{sl}_2$  or the Kirillov-Reshetikhin module of the Yangian of  $\mathfrak{sl}_2$ .
- (3) For quantum loop algebras of non-simply laced type, their representations and Kirillov-Reshetikhin modules have been constructed geometrically by Varagnolo and Vasserot [VV23]. Our quiver  $\tilde{Q}$  and potential  $\mathbf{w}$  are related to the rank 1 reduction of the quiver with potential from [VV23, Section 4.2]. See also [YZ22] for the geometric realization of the Yangian of non-simply laced type in terms of quiver with potentials.
- (4) The stable envelope constructed by Maulik and Okounkov in [MO19] requires a symplectic variety together with a torus action preserving the symplectic form. However, the stable representation variety for  $(\tilde{Q}, \mathbf{w})$  is not symplectic. See [RSYZ18, RSYZ20] for the 3-dimensional Calabi-Yau perspective. In this paper, we introduce the lattice model and its partition function. From the diagrammatic calculus point of view, the R-matrix can be straightforwardly obtained from the partition functions. We show that the partition functions coincide with the weight functions defined using the framed shuffle formula [B23, YZ17]. The approach of weight functions has been exploited in the symplectic case: see [RTV15] for the cotangent bundle of partial flag varieties, and [B23] for Nakajima quiver varieties.
- (5) The setup in [BZJ20] concerns the pure spin representations, while the present paper deals with mixed spins as well. For a general  $w$ -tuple of positive integers  $(\ell_1, \dots, \ell_w) \in \mathbb{N}^w$ , we refer to the setup of the quiver  $\tilde{Q}$  (1) with potential  $\mathbf{w}$  (2) as mixed spin. In this case, we take the framing vector to be  $\vec{1}_w = (1, 1, \dots, 1) \in \mathbb{N}^w$ . When  $\ell_1 = \ell_2 = \dots = \ell_w = \ell \in \mathbb{N}$ , the potential becomes  $\mathbf{w} = w\epsilon^\ell (\sum_{i=1}^w a_i^* a_i)$  and we obtain the pure spin case. Alternatively, for the pure spin, we could

consider the following quiver with potential, where the framing dimension is  $w \in \mathbb{N}$ .

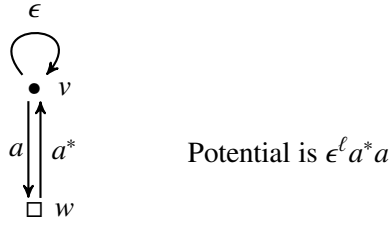

The latter is the setup in [BZJ20].

1.1. In the paper, we use the following grading on the arrows of the quiver  $\tilde{Q}$  (1):

$$(3) \quad \deg(\epsilon) = 2, \deg(a_i) = \deg(a_i^*) = -\ell_i, i = 1, \dots, w.$$

It is clear that the potential  $\mathbf{w}$  has grading zero. This grading is compatible with the grading used in [VV23] after rank 1-reduction.

Let  $V$  be a vector space with dimension  $v \in \mathbb{N}$ . Let  $W_i$  be the 1-dimensional vector space at vertex  $\square_i$ ,  $i = 1, \dots, w$ . Denote by  $(v, \vec{1}_w) \in \mathbb{N} \times \mathbb{N}^w$  the corresponding dimension vector of  $\tilde{Q}$ . Let  $\tilde{X}(v, \vec{1}_w)$  be the representations of  $\tilde{Q}$  with dimension vector  $(v, \vec{1}_w)$ . That is,

$$\tilde{X}(v, \vec{1}_w) = \{(\epsilon, a_1, \dots, a_w, a_1^*, \dots, a_w^*) \mid \epsilon \in \text{Hom}(V, V), a_i \in \text{Hom}(V, W_i), a_i^* \in \text{Hom}(W_i, V), i = 1, \dots, w\}.$$

We impose the cyclic stability condition that:  $(\epsilon, a_1, \dots, a_w, a_1^*, \dots, a_w^*) \in \tilde{X}(v, \vec{1}_w)$  is stable if  $V$  is spanned by the image  $\text{Im}(a_i^*)$  of  $a_i^*$ ,  $i \in [1, w]$ , together with the operator  $\epsilon$ . Denote the stable locus of  $\tilde{X}(v, \vec{1}_w)$  by  $\tilde{X}^{st}(v, \vec{1}_w)$ .

The group  $G_v := \text{GL}(V)$  acts on  $\tilde{X}(v, \vec{1}_w)$  by changing of basis of  $V$ , and the grading (3) gives a commuting  $\mathbb{C}^*$ -action on  $\tilde{X}(v, \vec{1}_w)$  with  $\mathbb{C}^*$ -weight given by the degree. Denote by  $T_w$  the framing torus  $(\mathbb{C}^*)^w$ , which also acts on  $\tilde{X}(v, \vec{1}_w)$ .

The trace of the potential  $\mathbf{w}$  is a  $G_v \times T_w \times \mathbb{C}^*$ -equivariant function on  $\tilde{X}(v, \vec{1}_w)$ . Denote by  $\varphi_{\mathbf{w}} := \varphi_{\mathbf{w}}(\mathbb{C})$  the sheaf of vanishing cycles of this function, which is a perverse constructible sheaf on  $\tilde{X}(v, \vec{1}_w)$ .

Let  $Y$  be a complex variety. Let  $D_c^b(Y)$  be the bounded derived category of  $\mathbb{C}$ -vector spaces on  $Y$  with constructible cohomology. For any morphism  $f : Y \rightarrow X$ , denote by  $f_! : D_c^b(Y) \rightarrow D_c^b(X)$  the direct image with compact support. For a smooth variety  $Y$  together with a function  $\mathbf{w} : Y \rightarrow \mathbb{C}$  on it, denote by  $\varphi_{\mathbf{w}} \in D_c^b(Y)$  the vanishing cycle complex of  $\mathbf{w}$ . Let  $\pi : Y \rightarrow \text{pt}$  be the structure map. We consider the vector space dual of the compactly supported cohomology with coefficient in  $\varphi_{\mathbf{w}}$ , that is,

$$H_c^*(Y, \varphi_{\mathbf{w}})^\vee = \pi_* \varphi_{\mathbf{w}} D_Y(\mathbb{C}) = D_{\text{pt}} \pi_! \varphi_{\mathbf{w}}(\mathbb{C}),$$

where  $D_Y$  is the Verdier dualizing sheaf on  $Y$ . See [KS11, D17, RSYZ20] for details.

Let  $Y_{\hbar}(\mathfrak{sl}_2)$  be the Yangian associated to the Lie algebra  $\mathfrak{sl}_2$ . Let  $R := H_{\mathbb{C}^*}(\text{pt}) = \mathbb{C}[\hbar]$  be the base ring and let  $K = \mathbb{C}(\hbar)$  be its field of fractions.

**Theorem A.** For any  $w \in \mathbb{N}$  and any  $(\ell_1, \dots, \ell_w) \in \mathbb{N}^w$ , the Yangian  $Y_{\hbar}(\mathfrak{sl}_2)$  acts on the cohomology

$$\bigoplus_{v \in \mathbb{N}} H_{c, \mathbb{C}^* \times T_w}^*(\tilde{X}(v, \vec{1}_w)^{st} / G_v, \varphi_{\mathbf{w}})^\vee \otimes_R K.$$

The proof of Theorem A is in Section 3.1. The main ingredients of the proof are the dimension reduction of the critical cohomology (recalled in Proposition 2.1) and the computation of the Kac-Moody generators of  $Y_{\hbar}(\mathfrak{sl}_2)$  on the torus fixed points basis. This approach has been used in [RSYZ20] in the setup of the

generalized Yangian action on the cohomology of the moduli spaces of certain perverse coherent systems on a toric Calabi Yau 3-fold.

Denote by  $\text{ev}_z : Y_{\hbar}(\mathfrak{sl}_2) \rightarrow U(\mathfrak{sl}_2)$  the evaluation homomorphism (see [CP94, Proposition 12.1.15]) of  $Y_{\hbar}(\mathfrak{sl}_2)$ . Recall that  $\text{ev}_z$  is the unique algebra homomorphism from  $Y_{\hbar}(\mathfrak{sl}_2)$  to  $U(\mathfrak{sl}_2)$  such that

$$\text{ev}_z(x) = x, \quad \text{ev}_z(J(x)) = zx, \text{ for all } x \in \mathfrak{sl}_2.$$

Here  $x, J(x)$  are the Drinfeld generators of  $Y_{\hbar}(\mathfrak{sl}_2)$ . See [CP94, Theorem 12.1.1] for the relations among  $x$  and  $J(x)$ ,  $x \in \mathfrak{sl}_2$  and see [CP94, Theorem 12.1.3] for the isomorphism between the Drinfeld presentation and the Kac-Moody presentation (see §3.1) of the Yangian.

**Proposition 1.1.** *When  $w = 1$ , we have the following isomorphism of representations of  $Y_{\hbar}(\mathfrak{sl}_2)$ :*

$$\bigoplus_{\nu \in \mathbb{N}} H_{c, \mathbb{C}^* \times \mathbb{C}_{fr}^*}^* (\tilde{X}(\nu, 1)^{st} / G_V, \varphi_w)^\vee \cong \text{ev}_z^*(L(\ell)),$$

where  $L(\ell) \cong \mathbb{C}^{\ell+1}$  is the  $(\ell + 1)$ -dimensional irreducible representation of  $\mathfrak{sl}_2$  and the variable  $z$  comes from the framing torus  $\mathbb{C}_{fr}^* = T_1$ .

The proof of Proposition 1.1 is in Section 3.2.

As a consequence, the representation in Theorem A has the following decomposition. We have the isomorphism as representations of  $Y_{\hbar}(\mathfrak{sl}_2)$  (Corollary 3.5)

$$\bigoplus_{\nu \in \mathbb{N}} H_{c, \mathbb{C}^* \times T_w}^* (\tilde{X}(\nu, \vec{1}_w)^{st} / G_\nu, \varphi_w)^\vee \otimes_R K \cong \text{ev}_{z_1}^*(L(\ell_1)) \otimes \cdots \otimes \text{ev}_{z_w}^*(L(\ell_w)),$$

where the isomorphism is given by identifying the torus fixed point basis on both sides. The tensor product is the fusion tensor product which comes from the Drinfeld coproduct of  $Y_{\hbar}(\mathfrak{sl}_2)$ . In the case of quantum affine algebras, the action of  $U_q(\widehat{\mathfrak{sl}_2})$  on the fusion tensor of Kirillov–Reshetikhin modules can be found in [H07, §3.4].

1.2. In §4.1, we introduce the framed shuffle algebra associated to the quiver  $\tilde{Q}$ . Denote by  $\text{SH}_{fr}$  the framed shuffle algebra. It is double graded by the dimension vectors  $(\nu, \vec{n}) \in \mathbb{N} \times \mathbb{N}^w$ , where  $\vec{n} = (n_1, n_2, \dots, n_w) \in \mathbb{N}^w$  is  $w$ -tuple of integers. Explicitly, as a  $\mathbb{C}[\hbar]$ -module, we have

$$\text{SH}_{fr} = \bigoplus_{\nu \in \mathbb{N}, \vec{n} \in \mathbb{N}^w} \text{SH}_{\nu, \vec{n}}, \text{ where } \text{SH}_{\nu, \vec{n}} := \mathbb{C}[\hbar] \otimes \mathbb{C}[y_1, \dots, y_\nu]^{\mathcal{S}_\nu} \otimes \mathbb{C}[z_j^i]_{j=1, \dots, w, i=1, \dots, n_j},$$

here  $\mathcal{S}_\nu$  is the symmetric group of  $\nu$  letters and permutes the  $\nu$  variables  $y_1, \dots, y_\nu$ . There is an algebra structure  $\star$  on  $\text{SH}_{fr}$  compatible with the two gradings. Componentwise, the multiplication

$$\star : \text{SH}_{\nu_1, \vec{n}_1} \otimes_{\mathbb{C}[\hbar]} \text{SH}_{\nu_2, \vec{n}_2} \rightarrow \text{SH}_{\nu_1 + \nu_2, \vec{n}_1 + \vec{n}_2}$$

is defined by (20). The shuffle algebra structure  $\star$  has a geometric interpretation. For each component, we identify  $\text{SH}_{\nu, \vec{n}}$  with the cohomology group  $H_{c, G_\nu \times T_w \times \mathbb{C}^*}^* (\tilde{X}(\nu, \vec{n}))^\vee$ . Then it follows from Proposition 4.1 that the shuffle multiplication  $\star$  on  $\text{SH}_{fr}$  can be identified with the Hall multiplication of  $\bigoplus_{(\nu, \vec{n}) \in \mathbb{N} \times \mathbb{N}^w} H_{c, G_\nu \times T_w \times \mathbb{C}^*}^* (\tilde{X}(\nu, \vec{n}))^\vee$  defined geometrically via pullback and pushforward along correspondences.

Note that when  $\vec{n} = 0$ , denote the unframed shuffle algebra by

$$\text{SH} = \bigoplus_{\nu \in \mathbb{N}} \text{SH}_\nu = \bigoplus_{\nu \in \mathbb{N}} \mathbb{C}[\hbar; y_1, \dots, y_\nu]^{\mathcal{S}_\nu}.$$

Then, there is an algebra isomorphism between  $\text{SH}$  and the positive part  $Y_{\hbar}^+(\mathfrak{sl}_2)$  (see for example [YZ14, Section 7]).

Fix the  $w$ -tuple  $(\ell_1, \dots, \ell_w) \in \mathbb{N}^w$  and fix the framing dimension to be  $\vec{1}_w = (1, \dots, 1) \in \mathbb{N}^w$ . By the equivariant localization theorem, the module

$$\bigoplus_{v \in \mathbb{N}} H_{c, \mathbb{C}^* \times T_w}^* (\tilde{X}(v, \vec{1}_w)^{st} / G_v, \varphi_w)^\vee \otimes_R K$$

is a free module over  $H_{\mathbb{C}^* \times T_w}(\text{pt}) \otimes_R K$ . Each graded piece  $H_{c, \mathbb{C}^* \times T_w}^* (\tilde{X}(v, \vec{1}_w)^{st} / G_v, \varphi_w)^\vee \otimes_R K$  has fixed point basis labelled by elements in the set (Lemma 2.2)

$$S(\ell_1, \dots, \ell_w) = \{(v_1, v_2, \dots, v_w) \in \mathbb{N}^w \mid 0 \leq v_i \leq \ell_i, \forall i \in [1, w], \text{ and } \sum_{i=1}^w v_i = v\}.$$

For any fixed point  $\lambda = (v_1, v_2, \dots, v_w) \in S(\ell_1, \dots, \ell_w)$ , we define the following element, referred to as weight functions (see (21) and (27))

$$W_\lambda^{\text{id}}(\hbar; y_1, \dots, y_v; z_1, \dots, z_w) := 1 \star_\lambda 1 \star_\lambda \dots \star_\lambda 1$$

in  $\text{SH}_{v, \vec{1}_w} = \mathbb{C}[\hbar] \otimes \mathbb{C}[y_1, \dots, y_v]^{\mathcal{S}_v} \otimes \mathbb{C}[z_1, \dots, z_w]$ . Here  $1 \star_\lambda 1 \star_\lambda \dots \star_\lambda 1$  is the image of  $1 \otimes 1 \otimes \dots \otimes 1$  of the following multiplication

$$\star_\lambda : \text{SH}_{v_1, e_1} \otimes \text{SH}_{v_2, e_2} \otimes \dots \otimes \text{SH}_{v_w, e_w} \rightarrow \text{SH}_{v, \vec{1}_w}$$

depending on  $\lambda = (v_1, v_2, \dots, v_w)$ , where  $e_i = (0, \dots, 0, 1, 0, \dots, 0)$ . The explicit formula of the weight function is given by (23).

For any element  $\sigma$  in the symmetric group  $\mathcal{S}_w$ , we define the weight function associated to  $\sigma$  to be

$$W_\lambda^\sigma(\hbar; y_1, \dots, y_v; z_1, \dots, z_w) := W_{\sigma^{-1}\lambda}^{\text{id}}(\hbar; y_1, \dots, y_v; z_{\sigma^{-1}(1)}, \dots, z_{\sigma^{-1}(w)}).$$

Let  $\lambda, \mu$  be two fixed points in  $S(\ell_{\sigma(1)}, \dots, \ell_{\sigma(w)})$ . Denote by  $W_\lambda^\sigma|_\mu$  the restriction of  $W_\lambda^\sigma$  to the fixed point  $\mu$ . By definition,  $W_\lambda^\sigma|_\mu$  is obtained from  $W_\lambda^\sigma(\hbar; y_1, \dots, y_v; z_1, \dots, z_w)$  by substituting the variables  $y_1, \dots, y_v$  according to the equivariant Chern roots of  $V$  at the fixed point  $\mu$  (25). In particular,  $W_\lambda^\sigma|_\mu \in \mathbb{C}[\hbar, z_1, z_2, \dots, z_w]$ .

For a general element  $\sigma \in \mathcal{S}_w$ , we define the total order on the set  $S(\ell_{\sigma(1)}, \dots, \ell_{\sigma(w)})$  depending on  $\sigma$  by

$$\lambda \leq_\sigma \mu \iff \sigma^{-1}(\lambda) \leq \sigma^{-1}(\mu),$$

where  $\leq$  is the lexicographical order on  $\mathbb{N}^w$ .

The weight functions have the following properties, which are proved in Lemma 5.1 and Lemma 5.2.

- (1) **Triangularity:** If  $\lambda <_\sigma \mu$ , we have  $W_\lambda^\sigma|_\mu = 0$ .
- (2) **The degree condition:** For any  $\lambda \geq_\sigma \mu$ , then,

$$\deg(W_\lambda^\sigma|_\lambda) \geq \deg(W_\lambda^\sigma|_\mu).$$

The normalization of  $W_\lambda^\sigma|_\lambda$  can be found in Lemma 5.1 (2).

1.3. Let  $\mathfrak{t}_w := \text{Lie}(T_w)$  be the Lie algebra of  $T_w$  and let  $(\mathfrak{t}_w)_\mathbb{R} = \text{Cochar}(T_w) \otimes_{\mathbb{Z}} \mathbb{R}$  be the real vector space. Denote by  $z_1, \dots, z_w$  the standard basis of the dual space  $\mathfrak{t}_w^\vee$ . We have the root hyperplanes  $z_i - z_j = 0$  of  $(\mathfrak{t}_w)_\mathbb{R}$ , for any  $1 \leq i \neq j \leq w$ . This gives the open chambers  $\mathfrak{C}_\sigma = \{x \in (\mathfrak{t}_w)_\mathbb{R} \mid z_{\sigma(1)}(x) > \dots > z_{\sigma(w)}(x)\}$ , such that

$$(\mathfrak{t}_w)_\mathbb{R} \setminus \bigcup_{1 \leq i \neq j \leq w} \{z_i - z_j = 0\} = \bigsqcup_{\sigma \in \mathcal{S}_w} \mathfrak{C}_\sigma.$$

The chambers  $\{\mathfrak{C}_\sigma\}$  are the usual Weyl chambers, which are labeled by elements in  $\mathcal{S}_w$ . Denote by  $[W_\lambda^\sigma|_\mu]$  the matrix whose  $(\lambda, \mu)$ -entry is the restriction of  $W_\lambda^\sigma$  to the fixed point  $\mu$ . Note that, after inverting  $\{z_i - z_j - a\hbar \mid$

$1 \leq i, j \leq w, a \in \mathbb{Z}$ ,  $[W_\lambda^\sigma |_\mu]$  is an invertible matrix. Let  $\mathbf{R} := H_{\mathbb{C}^* \times T_w}(\text{pt})$  be the base ring, and let  $\mathbf{K}$  be the fraction field of  $\mathbf{R}$ . We define the  $R$ -matrix, as an operator in

$$\bigoplus_{v \in \mathbb{N}} \text{End}(H_{c, \mathbb{C}^* \times T_w}^*(\tilde{X}(v, \vec{1}_w)^{st}/G_v, \varphi_w)^\vee \otimes_{\mathbf{R}} \mathbf{K})$$

to be

$$(4) \quad R_{\sigma', \sigma} := [W_\lambda^{\sigma'} |_\mu]^{-1} [W_\lambda^\sigma |_\mu].$$

For  $w = 2$ , there are only two chambers  $\mathfrak{C}_{\text{id}}$ , and  $\mathfrak{C}_{(21)}$ , where  $(21) \in \mathcal{S}_2$  is the non-trivial element. Set  $z := z_1 - z_2$ . In this case, we denote the  $R$ -matrix  $R_{\text{id}, (21)}$  by

$$(5) \quad R(z) := [W_\lambda^{\text{id}} |_\mu]^{-1} [W_\lambda^{(21)} |_\mu] \in \text{End}(H_{c, \mathbb{C}^* \times T_w}^*(\tilde{X}(v, \vec{1}_w)^{st}/G_v, \varphi_w)^\vee \otimes_{\mathbf{R}} \mathbf{K}).$$

The dimension of  $H_{c, \mathbb{C}^* \times T_w}^*(\tilde{X}(v, \vec{1}_w)^{st}/G_v, \varphi_w)^\vee \otimes_{\mathbf{R}} \mathbf{K}$  over  $\mathbf{K}$  is the cardinality  $|\mathcal{S}(\ell_1, \dots, \ell_w; v)|$ . In particular,  $R(z)$  is a matrix of size  $(\sum_v |\mathcal{S}(\ell_1, \dots, \ell_w; v)|)^2$ , with entries in  $\mathbb{C}[\hbar, z][\frac{1}{z-a\hbar} \mid a \in \mathbb{Z}]$ .

The explicit computations of  $R$ -matrices are in Section 6.

**1.4. Lattice model formulation.** It is well-known that weight functions are closely related to off-shell Bethe Ansatz [AO17], and we therefore expect a *lattice model* formula for our weight functions. In §7, we introduce such a model: it consists of lattice paths on a  $v \times w$  rectangular grid where the occupancy of vertical line  $j$  is bounded by  $\ell_j$ , and the occupancy of horizontal lines is at most 1, with some specific boundary conditions depending of  $(v_1, \dots, v_w)$ . We assign to each lattice path configuration  $c$  in the set  $\mathcal{C}_{(v_1, \dots, v_w)}$  of allowed configurations, a weight  $F(c) = \prod_{i=1}^v \prod_{j=1}^w (\text{weight of } c(i, j))$ , where the weight of  $c(i, j)$  is a degree 1 polynomial in  $y_i$  and  $z_j$  depending on the configuration around vertex  $(i, j)$ .

**Theorem B.** (Theorem 7.2) We have the following equality

$$\tilde{W}_{(v_1, \dots, v_w)} := \sum_{c \in \mathcal{C}_{(v_1, \dots, v_w)}} F(c) = \prod_{j=1}^w (-1)^{v_j(v+w-j-\sum_{s=1}^j v_s)} (2\hbar)^{v_j} \frac{\ell_j!}{(\ell_j - v_j)!} W_{(v_1, \dots, v_w)}^{\text{id}}.$$

One important step in the proof of the Theorem B is the  $F$ -basis in Lemma 7.3, which is constructed in Appendix A. The proof of Lemma 7.3 uses the 6-vertex R-matrix and diagrammatic calculus.

**Acknowledgments.** We thank Gufang Zhao and Ryo Fujita for very helpful discussions. Many computations in the paper are under the help of Gufang Zhao. Y.Y. was supported by the Australian Research Council (ARC) via the award DE190101231 and DP210103081.

## 2. DIMENSION REDUCTIONS AND TORUS FIXED POINTS

**2.1. The dimension reduction.** The ‘‘dimensional reduction’’ for critical cohomology of representations of quiver is proposed in [KS11, Section 4.8] and detailed discussed in [D17]. The dimensional reduction allows one to replace the critical cohomology associated with a 3-dimensional Calabi-Yau category by an ordinary cohomology associated with a 2-dimensional Calabi-Yau category.

Consider the setup of  $\tilde{Q}$  with the potential given by  $\mathbf{w} = \sum_{i=1}^w \epsilon^{\ell_i} a_i^* a_i$ . Fix vector spaces  $V$  with dimension  $v$ . Let  $W_i$  be the one dimensional vector space at the framing vertex  $i \in [1, w]$ . The dimension reduction along the arrows  $\{a_1, \dots, a_w\}$  amounts to replacing the critical cohomology of  $\tilde{X}(v, \vec{1}_w)$  by the ordinary cohomology of the following subvariety of  $X^+(v, \vec{1}_w)$ :

$$\begin{aligned} & \{(\epsilon, a_1^*, \dots, a_w^*) \in X^+(v, \vec{1}_w) \mid \text{tr}(\epsilon^{\ell_i} a_i^* a_i) = 0, \forall a_i \in \text{Hom}(V, W_i), i \in [1, w]\} \\ & = \{(\epsilon, a_1^*, \dots, a_w^*) \in X^+(v, \vec{1}_w) \mid \epsilon^{\ell_i} a_i^* = 0, i \in [1, w]\}. \end{aligned}$$

Clearly, the above subvariety contains the critical locus  $\frac{\partial \mathbf{w}}{\partial a_i} = 0, i \in [1, w]$ .

More explicitly, let  $C$  be the set consisting the arrow  $\{a_1, a_2, \dots, a_w\}$  of  $\tilde{Q}$ . We call  $C$  the cut of  $\tilde{Q}$ . We have the following derivatives of the potential  $\mathbf{w}$  with respect to arrows in  $C$ .

$$\frac{\partial \mathbf{w}}{\partial a_1} = \epsilon^{\ell_1} a_1^*, \quad \frac{\partial \mathbf{w}}{\partial a_2} = \epsilon^{\ell_2} a_2^*, \quad \dots, \quad \frac{\partial \mathbf{w}}{\partial a_w} = \epsilon^{\ell_w} a_w^*.$$

Denote by  $Q^+$  the following quiver, which is obtained from the quiver  $\tilde{Q}$  (1) by removing the arrows in the cut  $C$ . That is,  $Q^+$  has vertices  $\bullet$  and  $\square_1, \dots, \square_w$  and the set of arrows is  $\{\epsilon, a_1^*, \dots, a_w^*\}$ , where  $\epsilon$  is a loop on  $\bullet$ ,  $a_i^*$  is an arrow from  $\square_i$  to  $\bullet$ ,  $i = 1, \dots, w$ .

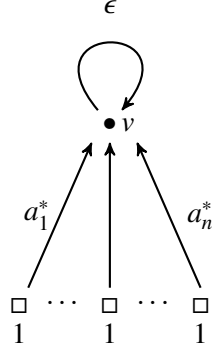

(6)

Set  $W = \prod_{i=1}^w W_i$ . Let  $\vec{1}_w = (1, 1, \dots, 1)$  be the framing vector with  $w$ -components. Denote by  $X^+(v, \vec{1}_w)$  the representations of  $Q^+$ :

$$X^+(v, \vec{1}_w) = \{(\epsilon, a_1^*, \dots, a_w^*) \mid \epsilon \in \text{Hom}(V, V), a_i^* \in \text{Hom}(W_i, V), i = 1, \dots, w\}.$$

We impose the cyclic stability condition that:  $(\epsilon, a_1^*, \dots, a_w^*) \in X^+(v, \vec{1}_w)$  is stable if  $V$  is spanned by the image  $\text{Im}(a_1^*, \dots, a_w^*)$  of  $a_1^*, \dots, a_w^*$ , together with the operator  $\epsilon$ . Denote the stable locus of  $X^+(v, \vec{1}_w)$  by  $X^{+,st}(v, \vec{1}_w)$ . The group  $G_v \times \mathbb{C}^* \times T_w$  acts on  $X^+(v, \vec{1}_w)$ , where the action of  $\mathbb{C}^*$  is given by the grading

$$\deg(\epsilon) = 2, \quad \deg(a_i^*) = -\ell_i, \quad i = 1, \dots, w.$$

Consider the following  $G_v$ -equivariant map

$$\mu_{v,w} : X^+(v, \vec{1}_w) = \text{Hom}(V, V) \times \text{Hom}(W, V) \rightarrow \text{Hom}(W, V), (\epsilon, a_1^*, \dots, a_w^*) \mapsto (\epsilon^{\ell_1} a_1^*, \epsilon^{\ell_2} a_2^*, \dots, \epsilon^{\ell_w} a_w^*).$$

Denote by  $\mu_{v,w}^{-1}(0)$  the kernel of  $\mu$ . Consider the variety

$$\begin{aligned} \mathfrak{M}^+(v, \vec{1}_w) &:= \mu_{v,w}^{-1}(0)^{st}/G_v \\ &= \{(\epsilon, a_1^*, \dots, a_w^*) \mid \epsilon^{\ell_i} a_i^* = 0, i \in [1, w] \mid \mathbb{C}[\epsilon](\text{Im}(a_1^*, \dots, a_w^*)) = V\}/G_v \subset X^{+,st}(v, \vec{1}_w)/G_v. \end{aligned}$$

The general framework from [D17, Theorem A.1 and Corollary A.9] gives the following.

**Proposition 2.1.** *Dimension reduction along the cut  $C$  gives the isomorphism of abelian groups.*

$$H_{c, \mathbb{C}^* \times T_w}^*(\tilde{X}(v, \vec{1}_w)^{st}/G_v, \varphi_w) \cong H_{c, \mathbb{C}^* \times T_w}^*(\mu_{v,w}^{-1}(0)^{st} \times_{G_v} \mathbb{C}^{wv}, \mathbb{C}) \cong H_{c, \mathbb{C}^* \times T_w}^{*-wv}(\mathfrak{M}^+(v, \vec{1}_w), \mathbb{C}),$$

where the affine space  $\mathbb{C}^{wv}$  is  $\text{Hom}(V, W)$ , and the right hand side is the compactly supported cohomology of  $\mathfrak{M}^+(v, \vec{1}_w)$ .

The right hand side can be defined the using the right derived functor of the compactly supported global section functor  $\Gamma_c$ , see [I86] for example.

**2.2. Torus fixed points.** The  $\mathbb{C}^*$ -action on  $X^+(v, \vec{I}_w)$  induces a  $\mathbb{C}^*$ -action on  $\mathfrak{M}^+(v, \vec{I}_w)$ . The fixed points of  $\mathfrak{M}^+(v, \vec{I}_w)$  under the action of  $\mathbb{C}^*$  are given as follows.

**Lemma 2.2.** *The set of torus fixed points  $\mathfrak{M}^+(v, \vec{I}_w)^{\mathbb{C}^*}$  is given by*

$$(7) \quad S(\ell_1, \dots, \ell_w) := \{(v_1, v_2, \dots, v_w) \mid 0 \leq v_i \leq \ell_i, \forall i \in [1, w], \text{ and } \sum_{i=1}^w v_i = v\}.$$

*Proof.* For any  $(\epsilon, a_1^*, \dots, a_w^*) \in \mathfrak{M}^+(v, \vec{I}_w)$  and  $t \in \mathbb{C}^*$ , then

$$t \cdot (\epsilon, a_1^*, \dots, a_w^*) = (t^2 \epsilon, t^{-\ell_1} a_1^*, \dots, t^{-\ell_w} a_w^*).$$

If  $(\epsilon, a_1^*, \dots, a_w^*)$  is fixed by the  $\mathbb{C}^*$ -action, then there exists an element  $g \in G_v$ , such that

$$(g \epsilon g^{-1}, g a_1^*, g a_2^*, \dots, g a_w^*) = (t^2 \epsilon, t^{-\ell_1} a_1^*, \dots, t^{-\ell_w} a_w^*).$$

We decompose  $V$  into eigenspaces of  $g$ :

$$V = \bigoplus V(\lambda), \text{ where } V(\lambda) = \{v \in V \mid g \cdot v = \lambda(t)v\}.$$

Now for the linear maps  $a_i^* : W_i \rightarrow V$ , we have

$$g(a_i^*(x)) = t^{-\ell_i} a_i^*(x), x \in \mathbb{C}.$$

Therefore,  $\text{im}(a_i^*) \subset V(t^{-\ell_i})$ . For any  $v \in V(\lambda)$ , we have

$$g \epsilon(v) = t^2 \epsilon g(v) = t^2 \epsilon(\lambda v) = t^2 \lambda \epsilon(v).$$

Therefore,  $\epsilon(V(\lambda)) \subset V(t^2 \lambda)$ . By the stability condition,  $V$  is generated by the image of  $a_i^*$  and the operator  $\epsilon$ . Therefore, for each  $i = 1, \dots, w$ , we have the following chain

$$W_i \xrightarrow{a_i^*} V(t^{-\ell_i}) \xrightarrow{\epsilon} V(t^{-\ell_i+2}) \xrightarrow{\epsilon} V(t^{-\ell_i+4}) \xrightarrow{\epsilon} \dots$$

The above chain terminates at  $V(t^{-\ell_i+(2v_i-2)})$ , for some  $v_i$  such that  $0 \leq v_i \leq \ell_i$ , because of the relation  $\epsilon^{\ell_i} a_i^* = 0$ .

This gives the fixed point  $(v_1, v_2, \dots, v_w)$  with the property that  $\sum_{i=1}^w v_i = v$ , and  $0 \leq v_i \leq \ell_i, \forall i \in [1, w]$ .  $\square$

The torus fixed point  $\lambda = (v_1, \dots, v_w)$  can be illustrated by the picture as follows.

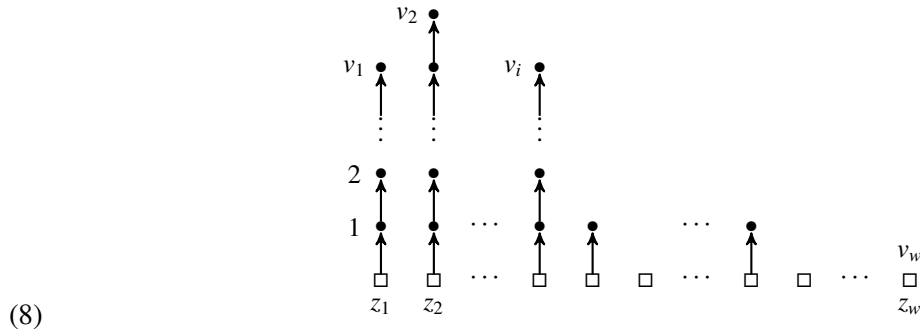

where the height of column  $i$  is at most  $\ell_i$ ,  $i \in [1, w]$ . The square box  $\square$  in column  $i$  stands for the basis of the vector space  $W_i$  at the framing vertex  $\square_i$ , and the  $\bullet$ 's are the eigenbasis of  $V$ . The arrows from the square box in column  $i$  to the  $\bullet$  are the maps  $a_i^* : W_i \rightarrow V$ , and other arrows are the maps  $\epsilon : V \rightarrow V$ . For each column  $i$ , there are  $v_i$  number of  $\bullet$ 's on top of  $\square$ . Therefore, there are  $w$  number of  $\square$ 's and we have  $\sum_i v_i = v$ . The height is bounded above by  $\ell_i$  because of the relation  $\epsilon^{\ell_i} a_i^* = 0$ ,  $i = 1, \dots, w$ .



Let  $z_1, \dots, z_w$  be the  $\mathbb{C}^* \times T_w$ -equivariant Chern roots of  $W$ . Using the grading (3), the  $\mathbb{C}^* \times T_w$ -equivariant Chern roots of  $V$  is given by

$$(9) \quad z_j - \ell_j \hbar, z_j - (\ell_j - 2)\hbar, z_j - (\ell_j - 4)\hbar, \dots, z_j - (\ell_j - 2v_j + 2)\hbar.$$

where  $\ell_j \geq v_j \geq 1$  for  $j = 1, 2, \dots, w$ .

**2.3. The case when  $w = 1$ .** In this section, we consider the special case when  $w = 1$ .

**Lemma 2.3.** *When  $w = 1$ , we have*

$$\mathfrak{M}^+(v, 1) = \begin{cases} \text{pt}, & \text{for } 0 \leq v \leq \ell, \\ \emptyset, & \text{otherwise.} \end{cases}$$

*Proof.* For any pair  $(\epsilon, a^*) \in X^{+,st}(v, 1)$ , by stability conditions, we have  $\text{im}(a^*)$  is a non-zero vector in  $V$ , and  $\mathbb{C}[\epsilon](\text{im}(a^*)) = V$ . Furthermore, the relation  $\epsilon^\ell a^* = 0$  implies that the dimension of  $\mathbb{C}[\epsilon](\text{im}(a^*))$  is at most  $\ell$ . Therefore, if  $v = \dim(V) > \ell$ , we have  $\mathfrak{M}^+(v, 1) = \emptyset$ .

We now assume the dimension of  $V$  is in the range  $0 \leq v \leq \ell$ , we first show the action of  $G_v$  on the set

$$\{(\epsilon, a^*) \in X^{+,st}(v, 1) \mid \epsilon^\ell a^* = 0\}$$

is transitive.

For any element  $(\epsilon, a^*)$  in the above set, by the stability condition  $\mathbb{C}[\epsilon](\text{im}(a^*)) = V$ , there exists a basis of  $V$  given by

$$\mathcal{B} = \{\epsilon^{v-1} \text{im}(a^*), \epsilon^{v-2} \text{im}(a^*), \dots, \epsilon \text{im}(a^*), \text{im}(a^*)\}.$$

Consider the  $\ell$ -th power  $\epsilon^\ell \in \text{End}(V)$ . The condition  $\epsilon^\ell a^* = 0$  implies that the operator  $\epsilon^\ell$  is the zero matrix under the basis  $\mathcal{B}$ . Let  $\lambda$  be an eigenvalue of  $\epsilon$ , then  $\lambda^\ell$  is an eigenvalue of  $\epsilon^\ell$ . Therefore,  $\lambda = 0$ . This forces  $\epsilon^v = 0$ .

Choose  $g \in G_v$  to be the matrix whose column vectors are the above basis elements in  $\mathcal{B}$ . Then  $g$  is the transition matrix from  $\mathcal{B}$  to the standard basis  $\{e_1, e_2, \dots, e_v\}$ . We have

$$g(e_v) = \text{im}(a^*), g(e_{v-1}) = \epsilon \text{im}(a^*), \dots, g(e_1) = \epsilon^{v-1} \text{im}(a^*).$$

This implies that

$$g^{-1} \epsilon g(e_s) = e_{s-1}, (s = v, v-1, \dots, 2), \text{ and } g^{-1} \epsilon g(e_1) = 0.$$

Therefore,  $g^{-1} \epsilon g$  is the Jordan block of the form

$$J_v = \begin{bmatrix} 0 & 1 & 0 & \dots & 0 \\ 0 & 0 & 1 & \dots & 0 \\ & & & \ddots & \\ 0 & 0 & 0 & \dots & 1 \\ 0 & 0 & 0 & \dots & 0 \end{bmatrix}$$

and  $g^{-1} a^*$  is the cyclic vector  $e_v$ . Therefore, the action of  $G_v$  is transitive.

We then check the stabilizer of the pair  $(J_v, e_v) \in X^{+,st}(v, 1)$  is trivial. For  $g$  lies in the stabilizer, clearly,  $gJ_v = J_v g$  and  $ge_v = e_v$ . Then,

$$ge_{v-1} = gJ_v e_v = J_v g e_v = J_v e_v = e_{v-1}.$$

Inductively, this shows that  $g(e_k) = e_k$  for all  $k = 1, \dots, v$ . As  $g$  fixes each basis vector, we have  $g = \text{id}$ . Thus,  $\mathfrak{M}^+(v, 1) = \text{pt}$ , if  $0 \leq v \leq \ell$ .  $\square$

## 3. PROOF OF THEOREM A AND PROPOSITION 1.1

**3.1. Proof of Theorem A.** In this subsection, we prove Theorem A. It uses a similar approach as in [RSYZ20, Proof of Proposition 5.2.1].

3.1.1. *The Yangian of  $\mathfrak{sl}_2$ .* Recall that  $Y_{\hbar}(\mathfrak{sl}_2)$  is an associative algebra over  $\mathbb{C}[\hbar]$ , generated by the variables

$$e_r, f_r, \psi_r, (r \in \mathbb{N}),$$

subject to relations described below.

**(Y1):** For any  $r, s \in \mathbb{N}$

$$[\psi_r, \psi_s] = 0.$$

**(Y2):** For any  $s \in \mathbb{N}$

$$[\psi_0, e_s] = 2e_s, \quad [\psi_0, f_s] = -2f_s.$$

**(Y3):** For any  $r, s \in \mathbb{N}$

$$[\psi_{r+1}, e_s] - [\psi_r, e_{s+1}] = \hbar(\psi_r e_s + e_s \psi_r), \quad [\psi_{r+1}, f_s] - [\psi_r, f_{s+1}] = -\hbar(\psi_r f_s + f_s \psi_r).$$

**(Y4):** For  $r, s \in \mathbb{N}$ ,

$$[e_{r+1}, e_s] = [e_r, e_{s+1}] = \hbar(e_r e_s + e_s e_r), \quad [f_{r+1}, f_s] = [f_r, f_{s+1}] = -\hbar(f_r f_s + f_s f_r).$$

**(Y5):** For  $r, s \in \mathbb{N}$ ,

$$[e_r, f_s] = \psi_{r+s}.$$

3.1.2. *The tangent complexes.* Recall we have the following  $G_v$ -equivariant map

$$(10) \quad \mu_{v,w} : X^+(v, \vec{1}_w) = \text{Hom}(V, V) \times \text{Hom}(W, V) \rightarrow \text{Hom}(W, V), (\epsilon, a_1^*, \dots, a_w^*) \mapsto (\epsilon^{\ell_1} a_1^*, \epsilon^{\ell_2} a_2^*, \dots, \epsilon^{\ell_w} a_w^*).$$

Denote by  $\mu_{v,w}^{-1}(0)$  the kernel of  $\mu$ . For a  $\mathbb{C}^*$ -fixed point  $\lambda \in S(\ell_1, \dots, \ell_w)$ , the tangent complex  $T_\lambda(\mu_{v,w}^{-1}(0)/G_v)$  of  $\mu_{v,w}^{-1}(0)/G_v$  at  $\lambda$  is given as follows.

$$(11) \quad [T_\lambda(\mu_{v,w}^{-1}(0)/G_v)] = [\mathfrak{gl}_v \rightarrow T_\lambda(X^+(v, \vec{1}_w)) \xrightarrow{D_\lambda(\mu)} T_\lambda(\text{Hom}(W, V))],$$

where  $D_\lambda(\mu)$  is the induced map from  $\mu_{v,w}$  on the tangent spaces.

Recall that

$$\mathfrak{M}^+(v, \vec{1}_w) := \mu_{v,w}^{-1}(0)^{st}/G_v \subset X^{+,st}(v, \vec{1}_w)/G_v.$$

For simplicity, for any vector bundle  $X$ , we write the dual bundle as  $X^\vee$ . Hence, for two vector bundles  $X, Y$  we have  $\text{Hom}(X, Y) = X^\vee \otimes Y$ .

Denote by  $\mathcal{V}$  be the tautological bundle  $\mu_{v,w}^{-1}(0)^{st} \times_{G_v} V$  on  $\mathfrak{M}^+(v, \vec{1}_w)$  of rank  $v$ . Denote by  $\mathcal{W} = \bigoplus_{i=1}^w \mathcal{W}_i$  the trivial bundle on  $\mathfrak{M}^+(v, \vec{1}_w)$  of rank  $w$ , where  $\mathcal{W}_i$  is the trivial line bundle at framing vertex  $\square_i$ . Then, by (11) and taking into account of the  $\mathbb{C}^*$ -action, the tangent complex of  $\mathfrak{M}^+(v, \vec{1}_w)$  in the Grothendieck group of  $\mathfrak{M}^+(v, \vec{1}_w)$  is given by

$$(12) \quad [T(\mathfrak{M}^+(v, \vec{1}_w))] = [-\text{End}(\mathcal{V}) + (\mathcal{V}^\vee \otimes \mathcal{V} \otimes \mathbb{C}_\epsilon^\vee + \sum_i \mathcal{W}_i^\vee \otimes \mathcal{V} \otimes \mathbb{C}_{a_i^*}^\vee) - \sum_i \mathcal{W}_i^\vee \otimes V \otimes \mathbb{C}_{\epsilon^{\ell_i} a_i^*}^\vee],$$

where we keep track of  $\mathbb{C}^*$ -weight on  $\mathbb{C}_h^\vee$  by labelling the arrow  $h$ . In other words,  $\mathbb{C}_h$  is a standard representation of  $\mathbb{C}^*$  with weight given by the weight of  $h$ .

3.1.3. *The action.* In this section, we construct an action of  $Y_{\hbar}(\mathfrak{sl}_2)$  on the cohomology group

$$\bigoplus_{v \in \mathbb{N}} H_{c, \mathbb{C}^* \times T_w}^* (\mathfrak{M}^+(v, \vec{1}_w))^\vee \otimes_R K.$$

By abuse of notation we denote by  $V$  in this section the vector space of dimension  $v + 1$ . Fix  $\xi \subset V$ , a one dimensional subspace and let  $V_2 := V/\xi$  be the quotient which has dimension  $v$ . Consider the following correspondence

$$\begin{array}{ccc} & X^{+,st}(v, v+1, \vec{1}_w) & \\ p \swarrow & & \searrow q \\ X^{+,st}(v, \vec{1}_w) & & X^{+,st}(v+1, \vec{1}_w) \end{array}$$

where

$$X^{+,st}(v, v+1, \vec{1}_w) = \{(\epsilon, a_1^*, \dots, a_w^*) \in X^+(v+1, \vec{1}_w)^{st} \mid \epsilon(\xi) \subset \xi\}.$$

The parabolic subgroup  $P := \{x \in G_{v+1} = \mathrm{GL}(V) \mid x(\xi) \subset \xi\}$  acts on  $X^{+,st}(v, v+1, \vec{1}_w)$ . The map  $p$  is given by  $(\epsilon, a_1^*, \dots, a_w^*) \mapsto (\epsilon, a_1^*, \dots, a_w^*) \bmod \xi$ , where  $\epsilon \bmod \xi$  is the induced map  $V/\xi \rightarrow V/\xi$ , and  $a_i^* \bmod \xi$  is the composition of  $a_i^* : W_i \rightarrow V$  with the projection  $V \twoheadrightarrow V_2 = V/\xi$ . The map  $q$  is the natural inclusion.

Restricting on the relation that  $\epsilon^{\ell_i} a_i^* = 0, i \in [1, w]$ , it induces a correspondence

$$\begin{array}{ccc} & \mathfrak{M}^+(v, v+1, \vec{1}_w) & \\ p \swarrow & & \searrow q \\ \mathfrak{M}^+(v, \vec{1}_w) & & \mathfrak{M}^+(v+1, \vec{1}_w) \end{array}$$

where  $\mathfrak{M}^+(v, v+1, \vec{1}_w)$  is defined to be the quotient  $(X^{+,st}(v, v+1, \vec{1}_w) \cap \mu_{v+1, w}^{-1}(0))/P$ .

The subspace  $\xi \subset V$  gives a tautological line bundle on the correspondence  $\mathfrak{M}^+(v, v+1, \vec{1}_w)$ , which will be denoted by  $\mathcal{L}$ . Recall that the Levi subgroup of  $P$  is  $\mathbb{C}^* \times G_v$  where  $\xi$  above is the standard weight 1 representation of the  $\mathbb{C}^*$ -factor. Hence,  $c_1(\mathcal{L})$  coincides with the equivariant variable of the  $\mathbb{C}^*$ -factor.

For any rational function  $g(x)$  in one variable with coefficients in  $H_T(\mathrm{pt})$  we define the class  $g(c_1(\mathcal{L}))$  in a localization of  $H_{c, P \times T}^* (\mathfrak{M}^+(v, v+1, \vec{1}_w))^\vee$ . Here the localization is taken with respect to  $H_{T \times \mathbb{C}^*}(\mathrm{pt}) \cong H_T(\mathrm{pt})[x]$ .

Define the actions of the operators

$$(13) \quad e(g) : H_{c, \mathbb{C}^* \times T_w}^* (\mathfrak{M}^+(v, \vec{1}_w))^\vee \otimes_R K \rightarrow H_{c, \mathbb{C}^* \times T_w}^* (\mathfrak{M}^+(v+1, \vec{1}_w))^\vee \otimes_R K$$

$$(14) \quad f(g) : H_{c, \mathbb{C}^* \times T_w}^* (\mathfrak{M}^+(v+1, \vec{1}_w))^\vee \otimes_R K \rightarrow H_{c, \mathbb{C}^* \times T_w}^* (\mathfrak{M}^+(v, \vec{1}_w))^\vee \otimes_R K$$

by the following convolutions:

$$e(g) := q_*(g(c_1(\mathcal{L})) \cup p^*), \quad f(g) := p_*(g(c_1(\mathcal{L})) \cup q^*).$$

Note that the fixed point loci with respect to the  $\mathbb{C}^*$ -actions are finite for all three spaces above. Hence the push-forward  $p_*$  is well-defined after passing to the localization despite of the fact that  $p$  is not a proper map.

By the equivariant localization, a basis of  $H_{c, \mathbb{C}^* \times T_w}^* (\mathfrak{M}^+(v, \vec{1}_w))^\vee \otimes_R K$  is given by  $\{\lambda \mid \lambda \in S(\ell_1, \dots, \ell_w)\}$ . Let  $(\lambda + \blacksquare)$  be the fixed point obtained by adding "a box"  $\blacksquare$  to  $\lambda$ . We use the notation  $\langle \lambda | (e(g)) | \lambda + \blacksquare \rangle$  for the coefficient of  $\lambda + \blacksquare$  in the expansion of  $e(g)(\lambda)$ . Similar convention is used for  $\langle \lambda + \blacksquare | (f(g)) | \lambda \rangle$ .

For a box  $\square$  or  $\blacksquare$ , denote by  $x_\square$  or  $x_\blacksquare$  the  $\mathbb{C}^* \times T_w$ -weight of the corresponding box, which is an element in  $H_{\mathbb{C}^* \times T_w}(\mathrm{pt})$ . Recall that the  $T_w \times \mathbb{C}^*$ -equivariant Chern roots of  $\mathcal{W}$  are  $z_1, z_2, \dots, z_w$ . Therefore,  $x_\blacksquare$  is determined by the formula (9).

**Proposition 3.1.** *The matrix coefficients of the operators  $e(g)$ ,  $f(g)$  in the basis of fixed points are as follows:*

$$\begin{aligned} \langle \lambda | (e(g)) | \lambda + \blacksquare \rangle &= \text{Res}_{z=x_\blacksquare} \left( g(z) \prod_{\square \in \lambda} \frac{z - x_\square}{z - x_\square - 2\hbar} \prod_{j=1}^w \frac{z - z_j - \ell_j \hbar}{z - z_j + \ell_j \hbar} \right), \\ \langle \lambda + \blacksquare | (f(g)) | \lambda \rangle &= \left( g(z) \prod_{\square \in \lambda} \frac{z - x_\square + 2\hbar}{z - x_\square} \right) \Big|_{z=x_\blacksquare}. \end{aligned}$$

*Proof.* Both formulas can be derived from [RSYZ20, Appendix (62) and (65)]. Recall the Levi subgroup of  $P$  is  $\mathbb{C}_L^* \times G_v$ . At the point  $(\lambda, \lambda + \blacksquare) \in \mathfrak{M}^+(v, v+1, \vec{1}_w)$  the tautological bundle  $\mathcal{L}$  has an action of  $\mathbb{C}_L^*$  as well. So we consider the  $\mathbb{C}_L^* \times \mathbb{C}^* \times T_w$ -equivariance. Now [RSYZ20, Appendix (65)] gives

$$\langle \lambda | (e(g)) | \lambda + \blacksquare \rangle = \text{Res}_{z=x_\blacksquare} g(z) \frac{e(T_\lambda(\mathfrak{M}^+(v, \vec{1}_w)))}{e(T_{\lambda, \lambda + \blacksquare}(\mathfrak{M}^+(v, v+1, \vec{1}_w)))}$$

Here  $e$  denotes the  $\mathbb{C}_L^* \times \mathbb{C}^* \times T_w$ -equivariant Euler class.

Next we calculate all the tangent spaces at the fixed points. Recall that we have short exact sequence of vector spaces

$$0 \rightarrow \xi \rightarrow V \rightarrow V_2 \rightarrow 0,$$

where  $V$  has dimension  $v+1$  and  $V_2$  has dimension  $v$ .

By (12), the tangent complex of  $\mathfrak{M}^+(v, \vec{1}_w)$  as a class in the Grothendieck group of  $\mathfrak{M}^+(v, \vec{1}_w)$  is given by

$$-\text{End}(\mathcal{V}_2) + (\mathcal{V}_2^\vee \otimes \mathcal{V}_2 \otimes \mathbb{C}_\epsilon^\vee + \sum_{i=1}^w \mathcal{W}_i^\vee \otimes \mathcal{V}_2 \otimes \mathbb{C}_{a_i^\vee}^\vee) - \sum_{i=1}^w \mathcal{W}_i^\vee \otimes \mathcal{V}_2 \otimes \mathbb{C}_{\epsilon^\vee a_i^\vee}^\vee$$

The tangent complex of the correspondence  $\mathfrak{M}^+(v, v+1, \vec{1}_w)$  has the following class in the Grothendieck group,

$$[T(\mathfrak{M}^+(v, v+1, \vec{1}_w))] = [-P + (P \otimes \mathbb{C}_\epsilon^\vee + \sum_{i=1}^w \mathcal{W}_i^\vee \otimes \mathcal{V} \otimes \mathbb{C}_{a_i^\vee}^\vee) - \sum_{i=1}^w \mathcal{W}_i^\vee \otimes \mathcal{V} \otimes \mathbb{C}_{\epsilon^\vee a_i^\vee}^\vee],$$

where  $P = \text{Hom}(\xi, \xi) \oplus \text{Hom}(V_2, V_2) \oplus (V_2, \xi) = (\xi^\vee \otimes \xi) \oplus (V_2^\vee \otimes V_2) \oplus (V_2^\vee \otimes \xi)$ .

Now by [RSYZ20, Appendix (65)], we have the following

$$\begin{aligned} &\langle \lambda | e_k | \lambda + \blacksquare \rangle \\ &= \text{Res}_{z=x_\blacksquare} c_1(\mathcal{L})^k \frac{e(T_\lambda(\mathfrak{M}^+(v, \vec{1}_w)))}{e(T_{\lambda, \lambda + \blacksquare}(\mathfrak{M}^+(v, v+1, \vec{1}_w)))} \Big|_{(\lambda, \lambda + \blacksquare)} \\ &= \text{Res}_{z=x_\blacksquare} c_1(\mathcal{L})^k \frac{e(-\mathcal{V}_2^\vee \otimes \mathcal{V}_2 + (\mathcal{V}_2^\vee \otimes \mathcal{V}_2 \otimes \mathbb{C}_\epsilon^\vee + \sum_{i=1}^w \mathcal{W}_i^\vee \otimes \mathcal{V}_2 \otimes \mathbb{C}_{a_i^\vee}^\vee) - \sum_{i=1}^w \mathcal{W}_i^\vee \otimes \mathcal{V}_2 \otimes \mathbb{C}_{\epsilon^\vee a_i^\vee}^\vee)}{e(-P + (P \otimes \mathbb{C}_\epsilon^\vee + \sum_{i=1}^w \mathcal{W}_i \otimes \mathcal{V} \otimes \mathbb{C}_{a_i^\vee}^\vee) - \sum_{i=1}^w \mathcal{W}_i \otimes \mathcal{V} \otimes \mathbb{C}_{\epsilon^\vee a_i^\vee}^\vee)} \Big|_{(\lambda, \lambda + \blacksquare)} \\ &= \text{Res}_{z=x_\blacksquare} c_1(\mathcal{L})^k \frac{e(P + (\mathcal{V}_2^\vee \otimes \mathcal{V}_2 \otimes \mathbb{C}_\epsilon^\vee + \sum_{i=1}^w \mathcal{W}_i^\vee \otimes \mathcal{V}_2 \otimes \mathbb{C}_{a_i^\vee}^\vee) + \sum_{i=1}^w \mathcal{W}_i^\vee \otimes \mathcal{V} \otimes \mathbb{C}_{\epsilon^\vee a_i^\vee}^\vee)}{e(\mathcal{V}_2^\vee \otimes \mathcal{V}_2 + (P \otimes \mathbb{C}_\epsilon^\vee + \sum_{i=1}^w \mathcal{W}_i^\vee \otimes \mathcal{V} \otimes \mathbb{C}_{a_i^\vee}^\vee) + \sum_{i=1}^w \mathcal{W}_i^\vee \otimes \mathcal{V}_2 \otimes \mathbb{C}_{\epsilon^\vee a_i^\vee}^\vee)} \Big|_{(\lambda, \lambda + \blacksquare)} \\ &= \text{Res}_{z=x_\blacksquare} c_1(\mathcal{L})^k \frac{e(\mathcal{V}_2^\vee \otimes \xi + \sum_{i=1}^w \mathcal{W}_i^\vee \otimes \xi \otimes \mathbb{C}_{\epsilon^\vee a_i^\vee}^\vee)}{e(\mathcal{V}_2^* \otimes \xi \otimes \mathbb{C}_\epsilon^\vee + \sum_{i=1}^w \mathcal{W}_i^\vee \otimes \xi \otimes \mathbb{C}_{a_i^\vee}^\vee)} \Big|_{(\lambda, \lambda + \blacksquare)} \end{aligned}$$

Here as before  $z$  is the equivariant Chern root of  $\xi$  and recall that  $V_2 = V/\xi$ . We take the basis of  $V_2$  to be  $\{\square \mid \square \in \lambda\}$ . Then the equivariant Chern root of the line spanned by  $\square$  is the  $\mathbb{C}_L^* \times \mathbb{C}^* \times T_w$ -weight of  $\square$ , which is  $x_\square$  in our notation. Therefore, the raising operator is given by

$$(15) \quad \begin{aligned} \langle \lambda | e_k | \lambda + \blacksquare \rangle &= \text{Res}_{z=x_\blacksquare} c_1(\mathcal{L})^k \frac{e(V_2^\vee \otimes \xi + \sum_{i=1}^w W_i^\vee \otimes \xi \otimes \mathbb{C}_{\epsilon^\ell a_i^*}^\vee)}{e(V_2^* \otimes \xi \otimes \mathbb{C}_\epsilon^\vee + \sum_{i=1}^w W_i^\vee \otimes \xi \otimes \mathbb{C}_{a_i^*}^\vee)} |_{(\lambda, \lambda + \blacksquare)} \\ &= \text{Res}_{z=x_\blacksquare} \left( z^k \prod_{\square \in \lambda} \frac{z - x_\square}{z - x_\square - 2\hbar} \prod_{j=1}^w \frac{z - z_j - \ell_j \hbar}{z - z_j + \ell_j \hbar} \right). \end{aligned}$$

Similarly, [RSYZ20, Appendix (62)] gives

$$\langle \lambda + \blacksquare | (f(g)) | \lambda \rangle = g(c_1(\mathcal{L})) |_{(\lambda, \lambda + \blacksquare)} \frac{e(T_{\lambda + \blacksquare}(\mathfrak{M}^+(v+1, \vec{1}_w)))}{e(T_{\lambda, \lambda + \blacksquare}(\mathfrak{M}^+(v, v+1, \vec{1}_w)))} |_{(\lambda, \lambda + \blacksquare)}.$$

Here  $e$  stands for the  $\mathbb{C}^* \times T_w$ -equivariant Euler class.

Therefore, we have

$$\begin{aligned} \langle \lambda + \blacksquare | f_m | \lambda \rangle &= c_1(\mathcal{L})^m |_{(\lambda, \lambda + \blacksquare)} \frac{e(T_{\lambda + \blacksquare}(\mathfrak{M}^+(v+1, \vec{1}_w)))}{e(T_{\lambda, \lambda + \blacksquare}(\mathfrak{M}^+(v, v+1, \vec{1}_w)))} |_{(\lambda, \lambda + \blacksquare)} \\ &= c_1(\mathcal{L})^m \frac{e(-\text{End}(\mathcal{V}) + (\mathcal{V}^\vee \otimes \mathcal{V} \otimes \mathbb{C}_\epsilon^\vee + \sum_{i=1}^w \mathcal{W}_i^\vee \otimes \mathcal{V} \otimes \mathbb{C}_{a_i^*}^\vee) - \sum_{i=1}^w \mathcal{W}_i^\vee \otimes \mathcal{V} \otimes \mathbb{C}_{\epsilon^\ell a_i^*}^\vee)}{e(-P + (P \otimes \mathbb{C}_\epsilon^\vee + \sum_{i=1}^w \mathcal{W}_i^\vee \otimes \mathcal{V} \otimes \mathbb{C}_{a_i^*}^\vee) - \sum_{i=1}^w \mathcal{W}_i^\vee \otimes \mathcal{V} \otimes \mathbb{C}_{\epsilon^\ell a_i^*}^\vee)} \\ &= c_1(\mathcal{L})^m \frac{e(P + (\mathcal{V}^\vee \otimes \mathcal{V} \otimes \mathbb{C}_\epsilon^\vee + \sum_{i=1}^w \mathcal{W}_i^\vee \otimes \mathcal{V} \otimes \mathbb{C}_{a_i^*}^\vee) + \sum_{i=1}^w \mathcal{W}_i^\vee \otimes \mathcal{V} \otimes \mathbb{C}_{\epsilon^\ell a_i^*}^\vee)}{e(\mathcal{V}^\vee \otimes \mathcal{V} + (P \otimes \mathbb{C}_\epsilon^\vee + \sum_{i=1}^w \mathcal{W}_i^\vee \otimes \mathcal{V} \otimes \mathbb{C}_{a_i^*}^\vee) + \sum_{i=1}^w \mathcal{W}_i^\vee \otimes \mathcal{V} \otimes \mathbb{C}_{\epsilon^\ell a_i^*}^\vee)} \\ &= c_1(\mathcal{L})^m \frac{e(\xi^\vee \otimes \mathcal{V}_2 \otimes \mathbb{C}_\epsilon^\vee)}{e(\xi^\vee \otimes \mathcal{V}_2)} = (x_\blacksquare)^m \prod_{\square \in \lambda} \frac{-x_\blacksquare + x_\square - 2\hbar}{-x_\blacksquare + x_\square} \\ &= (x_\blacksquare)^m \prod_{\square \in \lambda} \frac{x_\blacksquare - x_\square + 2\hbar}{x_\blacksquare - x_\square}. \end{aligned}$$

Recall the line bundle  $\mathcal{L}$  is defined using the subspace  $\xi \subset V$ , with the quotient  $V/\xi = V_2$ . Therefore, the  $\mathbb{C}^* \times T_w$ -weight of  $\xi$  at the fixed point  $(\lambda, \lambda + \blacksquare)$  is given by  $x_\blacksquare$ .

This completes the proof.  $\square$

Let us introduce the operator  $\psi_{i+j} := [e_i, f_j]$ . Define the generating series

$$\psi(z) := 1 - \sum_{i \geq 0} \psi_i z^{-i-1}.$$

We define the action of  $\psi(z)$  on  $\bigoplus_{v \in \mathbb{N}} H_{c, \mathbb{C}^* \times T_w}^*(\mathfrak{M}^+(v, \vec{1}_w))^\vee$  via the Chern polynomial of the following class in the Grothendieck group

$$(q^{-2})\mathcal{V} + \sum_{i=1}^w (q^{\ell_i})\mathcal{W}_i - (q^2)\mathcal{V} + \sum_{i=1}^w (q^{-\ell_i})\mathcal{W}_i.$$

Here  $q$  is the coordinate line considered as a  $\mathbb{C}^*$ -representation. It is straightforward to show the following. See [RSYZ18, § 4.1] for example.

**Proposition 3.2.** *Let  $\lambda$  be a  $\mathbb{C}^*$ -fixed point. The eigenvalue of  $\psi(z)$  on  $[\lambda]$  equals*

$$(16) \quad \tilde{\psi}(z) := \prod_{\square \in \lambda} \frac{z - x_{\square} + 2\hbar}{z - x_{\square} - 2\hbar} \prod_{j=1}^w \frac{z - z_j - \ell_j \hbar}{z - z_j + \ell_j \hbar}.$$

3.1.4. *Check the relations.* In this section, we only verify the relation (Y5). The verification of the other relations are standard: (Y4) follows from the fact that the shuffle algebra SH is isomorphic to the positive part of the Yangian  $Y_{\hbar}^+(\mathfrak{sl}_2)$ , and the computations in [YZ14, Theorem 7.1]. The relation (Y3) follows from a similar discussion in [YZ14, Proposition 5.12] or [RSYZ18, Proposition 6.2.2].

We say  $\blacksquare$  is an *addible box*, if  $\lambda$  is a fixed point, and  $\lambda + \blacksquare$  is still a fixed point. We say  $\blacksquare$  is a *removable box*, if  $\lambda$  is a fixed point, and  $\lambda - \blacksquare$  is still a fixed point.

**Lemma 3.3.** *Let  $z_1, z_2, \dots, z_w$  be generic parameters. All the poles of the rational function of  $z$*

$$E(z) := z^k \prod_{\square \in \lambda} \frac{z - x_{\square}}{z - x_{\square} - 2\hbar} \prod_{j=1}^w \frac{z - z_j - \ell_j \hbar}{z - z_j + \ell_j \hbar}$$

*are simple poles at the addible boxes.*

*Proof.* As  $z_1, z_2, \dots, z_w$  are generic parameters, we have  $z_i \neq z_j + a\hbar$ , for any  $a \in \mathbb{Z}$ . it suffices to show the claim for  $w = 1$ . In this case, the fixed point  $\lambda$  contains only one column illustrated as in the following picture.



Let  $v = \dim(V)$ . Denote the equivariant variable by  $z_i$ . Assume  $1 \leq v \leq \ell_i$ , then by (9), the weights of  $\lambda$  is given by

$$z_i - \ell_i \hbar, z_i - \ell_i \hbar + 2\hbar, z_i - \ell_i \hbar + 4\hbar, \dots, z_i - \ell_i \hbar + 2v\hbar - 2\hbar.$$

Then, the function  $E(z)$  is given as

$$(17) \quad \begin{aligned} & z^k \frac{z - z_i + \ell_i \hbar}{z - z_i + \ell_i \hbar - 2\hbar} \frac{z - z_i + \ell_i \hbar - 2\hbar}{z - z_i + \ell_i \hbar - 4\hbar} \frac{z - z_i + \ell_i \hbar - 4\hbar}{z - z_i + \ell_i \hbar - 6\hbar} \dots \frac{z - z_i + \ell_i \hbar - 2v\hbar + 2\hbar}{z - z_i + \ell_i \hbar - 2v\hbar} \frac{z - z_i - \ell_i \hbar}{z - z_i + \ell_i \hbar} \\ & = z^k \frac{z - z_i - \ell_i \hbar}{z - z_i + \ell_i \hbar - 2v\hbar} \end{aligned}$$

If  $v = \ell_i$ , then there is no addible boxes as the height of the fixed points is at most  $\ell_i$ . The function  $E(z) = z^k$  is a regular function, and it has no poles.

If  $0 \leq v < \ell_i$ , then  $E(z)$  has one simple pole at  $z = z_i - \ell_i \hbar + 2v\hbar$ , which is the unique addible box.

This shows the assertion.  $\square$

**Lemma 3.4.** *The poles of the function  $\tilde{\psi}(z)$  (16)*

$$\tilde{\psi}(z) = \prod_{\square \in \lambda} \frac{z - x_{\square} + 2\hbar}{z - x_{\square} - 2\hbar} \prod_{j=1}^w \frac{z - z_j - \ell_j \hbar}{z - z_j + \ell_j \hbar}$$

*are at the addible and removable boxes of  $\lambda$ .*

*Proof.* Similar as in the proof of Lemma 3.3, it suffices to show the claim for  $w = 1$ . Denote the dimension of  $V$  by  $\nu$ .

Denote the equivariant variable by  $z_i$ . Assume  $1 \leq \nu \leq \ell_i$ , the weights of  $\lambda$  are given by

$$x_{\square} : z_i - \ell_i \hbar, z_i - \ell_i \hbar + 2\hbar, z_i - \ell_i \hbar + 4\hbar, \dots, z_i - \ell_i \hbar + 2\nu \hbar - 2\hbar.$$

We have the following cases.

**Case 1:** If  $\nu = 0$  with  $w = 1$ , then,

$$\tilde{\psi}(z) = \frac{z - z_i - \ell_i \hbar}{z - z_i + \ell_i \hbar}$$

Clearly,  $\tilde{\psi}(z)$  in this case has only one simple pole at  $z = z_i - \ell_i \hbar$ , which is the unique addible box. There is no removable box in this case.

**Case 2:** If  $1 \leq \nu \leq \ell_i$  with  $w = 1$ , we have the following detailed computation

$$\begin{aligned} \tilde{\psi}(z) &= \frac{z - z_i + \ell_i \hbar + 2\hbar}{z - z_i + \ell_i \hbar - 2\hbar} \frac{z - z_i + \ell_i \hbar}{z - z_i + \ell_i \hbar - 4\hbar} \frac{z - z_i + \ell_i \hbar - 2\hbar}{z - z_i + \ell_i \hbar - 6\hbar} \dots \frac{z - z_i + \ell_i \hbar - 2\nu \hbar + 4\hbar}{z - z_i + \ell_i \hbar - 2\nu \hbar} \frac{z - z_i - \ell_i \hbar}{z - z_i + \ell_i \hbar} \\ &= \frac{(z - z_i + \ell_i \hbar + 2\hbar)(z - z_i + \ell_i \hbar)}{(z - z_i + \ell_i \hbar - 2\nu \hbar + 2\hbar)(z - z_i + \ell_i \hbar - 2\nu \hbar)} \frac{z - z_i - \ell_i \hbar}{z - z_i + \ell_i \hbar} \\ &= \frac{(z - z_i + \ell_i \hbar + 2\hbar)(z - z_i - \ell_i \hbar)}{(z - z_i + \ell_i \hbar - 2\nu \hbar + 2\hbar)(z - z_i + \ell_i \hbar - 2\nu \hbar)}. \end{aligned}$$

**Case 2 (a):** When  $1 \leq \nu < \ell_i$ , the function  $\tilde{\psi}(z)$  has two simple poles. One pole is at  $z = z_i - \ell_i \hbar + 2\nu \hbar - 2\hbar$ , which is the unique removable box, and the other pole is at  $z = z_i - \ell_i \hbar + 2\nu \hbar$  which is the unique addible box.

**Case 2 (b):** When  $\nu = \ell_i$ , we have

$$\tilde{\psi}(z) = \frac{z - z_i + \ell_i \hbar + 2\hbar}{z - z_i - \ell_i \hbar + 2\hbar}.$$

Then  $\tilde{\psi}(z)$  in this case has one simple pole at  $z = z_i + \ell_i \hbar - 2\hbar$ , which is the unique removable box. There is no addible box in this case.

This completes the proof.  $\square$

We now check the relation (Y5):

Notations as before. Let  $\lambda$  be a  $\mathbb{C}^*$ -fixed point. By Proposition 3.1, for the composition  $f_j \circ e_i$ , we have

$$\begin{aligned} &\langle \lambda + \blacksquare | (f_j) | \lambda \rangle \langle \lambda | (e_i) | \lambda + \blacksquare \rangle \\ &= (x_{\blacksquare})^j \prod_{\square \in \lambda} \frac{x_{\blacksquare} - x_{\square} + 2\hbar}{x_{\blacksquare} - x_{\square}} \operatorname{Res}_{z=x_{\blacksquare}} \left( z^i \prod_{\square \in \lambda} \frac{z - x_{\square}}{z - x_{\square} - 2\hbar} \prod_{j=1}^w \frac{z - z_j - \ell_j \hbar}{z - z_j + \ell_j \hbar} \right) \\ &= \operatorname{Res}_{z=x_{\blacksquare}} \left( z^{i+j} \prod_{\square \in \lambda} \frac{(z - x_{\square} + 2\hbar)(z - x_{\square})}{(z - x_{\square})(z - x_{\square} - 2\hbar)} \prod_{j=1}^w \frac{z - z_j - \ell_j \hbar}{z - z_j + \ell_j \hbar} \right) \\ &= \operatorname{Res}_{z=x_{\blacksquare}} \left( z^{i+j} \prod_{\square \in \lambda} \frac{z - x_{\square} + 2\hbar}{z - x_{\square} - 2\hbar} \prod_{j=1}^w \frac{z - z_j - \ell_j \hbar}{z - z_j + \ell_j \hbar} \right). \end{aligned}$$

On the other hand, by Proposition 3.1, for the composition  $e_i \circ f_j$ , we have

$$\begin{aligned}
& \langle \lambda - \blacksquare | (e_i) | \lambda \rangle \langle \lambda | (f_j) | \lambda - \blacksquare \rangle \\
&= \text{Res}_{z=x_\blacksquare} \left( z^i \prod_{\square \in \lambda - \blacksquare} \frac{z - x_\square}{z - x_\square - 2\hbar} \prod_{j=1}^w \frac{z - z_j - \ell_j \hbar}{z - z_j + \ell_j \hbar} \right) (x_\blacksquare)^j \prod_{\square \in \lambda} \frac{x_\blacksquare - x_\square + 2\hbar}{x_\blacksquare - x_\square} \\
&= \text{Res}_{z=x_\blacksquare} \left( z^{i+j} \prod_{\square \in \lambda - \blacksquare} \frac{(z - x_\square)(z - x_\square + 2\hbar)}{(z - x_\square - 2\hbar)(z - x_\square)} \prod_{j=1}^w \frac{z - z_j - \ell_j \hbar}{z - z_j + \ell_j \hbar} \right) \\
&= \text{Res}_{z=x_\blacksquare} \left( z^{i+j} \prod_{\square \in \lambda - \blacksquare} \frac{z - x_\square + 2\hbar}{z - x_\square - 2\hbar} \prod_{j=1}^w \frac{z - z_j - \ell_j \hbar}{z - z_j + \ell_j \hbar} \right) \\
&= - \text{Res}_{z=x_\blacksquare} \left( z^{i+j} \prod_{\square \in \lambda} \frac{z - x_\square + 2\hbar}{z - x_\square - 2\hbar} \prod_{j=1}^w \frac{z - z_j - \ell_j \hbar}{z - z_j + \ell_j \hbar} \right).
\end{aligned}$$

This implies that, for the commutator  $[e_i, f_j]$ , we have

$$\begin{aligned}
& [e_i, f_j] \lambda = (e_i \circ f_j) \lambda - (f_j \circ e_i) \lambda \\
&= - \sum_{\text{removable boxes}} \text{Res}_{z=x_\blacksquare} \left( z^{i+j} \prod_{\square \in \lambda} \frac{z - x_\square + 2\hbar}{z - x_\square - 2\hbar} \prod_{j=1}^w \frac{z - z_j - \ell_j \hbar}{z - z_j + \ell_j \hbar} \right) \\
&\quad - \sum_{\text{addible boxes}} \text{Res}_{z=x_\blacksquare} \left( z^{i+j} \prod_{\square \in \lambda} \frac{z - x_\square + 2\hbar}{z - x_\square - 2\hbar} \prod_{j=1}^w \frac{z - z_j - \ell_j \hbar}{z - z_j + \ell_j \hbar} \right) \\
&= - \sum_{\text{addible boxes} \cup \text{removable boxes}} \text{Res}_{z=x_\blacksquare} \left( z^{i+j} \prod_{\square \in \lambda} \frac{z - x_\square + 2\hbar}{z - x_\square - 2\hbar} \prod_{j=1}^w \frac{z - z_j - \ell_j \hbar}{z - z_j + \ell_j \hbar} \right) \\
(18) \quad &= \text{Res}_{z=\infty} \left( z^{i+j} \prod_{\square \in \lambda} \frac{z - x_\square + 2\hbar}{z - x_\square - 2\hbar} \prod_{j=1}^w \frac{z - z_j - \ell_j \hbar}{z - z_j + \ell_j \hbar} \right) \\
&= \text{Res}_{z=\infty} z^{i+j} \psi(z) | \lambda.
\end{aligned}$$

where the equality (18) follows from the residue theorem and Lemma 3.4.

As the expansion of  $\psi(z)$  is given by  $1 - \sum_{i \geq 0} \psi_i z^{-i-1}$ . We have

$$\text{Res}_{z=\infty} z^{i+j} \psi(z) | \lambda = \psi_{i+j} | \lambda.$$

Therefore,  $[e_i, f_j] = \psi_{i+j}$ . This implies the relation (Y5).

**3.2. The proof of Proposition 1.1.** When  $w = 1$ , denote the maximal torus  $T_w$  at the framing vertex by  $\mathbb{C}_{fr}^*$ . By the Proposition 2.1 and Lemma 2.3, we have the isomorphisms as graded vector spaces

$$\begin{aligned}
\bigoplus_{v=0}^{\infty} H_{c, \mathbb{C}^* \times \mathbb{C}_{fr}^*}^* (\tilde{X}(v, 1)^{st} / G_V, \varphi_w)^\vee &\cong \bigoplus_{v=0}^{\infty} H_{\mathbb{C}^* \times \mathbb{C}_{fr}^*}^* (\mathfrak{M}^+(v, 1), \mathbb{C}) && \text{by Proposition 2.1} \\
&= \bigoplus_{v=0}^{\ell} H_{c, \mathbb{C}^* \times \mathbb{C}_{fr}^*}^* (\text{pt}, \mathbb{C})^\vee && \text{by Lemma 2.3} \\
&= \mathbb{C}[\hbar, z] \otimes \mathbb{C}^{\ell+1}
\end{aligned}$$

We now analyze the action of  $Y_\hbar(\mathfrak{sl}_2)$  on  $\mathbb{C}[\hbar, z] \otimes \mathbb{C}^{\ell+1}$ .



By Proposition 3.1 and the computation in (17), we have

$$\begin{aligned} \langle \lambda | e_k | \lambda + \blacksquare \rangle &= \text{Res}_{u=x_{\blacksquare}} u^k \frac{u - z_1 - \ell \hbar}{u - z_1 + \ell \hbar - 2v\hbar} \\ &= (z_1 - \ell \hbar + 2v\hbar)^k ((z_1 - \ell \hbar + 2v\hbar) - z_1 - \ell \hbar) \\ &= (z_1 - \ell \hbar + 2v\hbar)^k (2(v - \ell)\hbar). \end{aligned}$$

Choose a basis  $\{b_v \mid v = 0, 1, 2, \dots, \ell\}$  of  $\mathbb{C}^{\ell+1}$  such that  $b_v$  comes from the component  $\mathfrak{M}^+(v, 1)$ . In other words,  $b_v$  is represented by the following picture with  $v$  many  $\bullet$ 's.



Then, for  $\lambda = b_v$ , we have  $\lambda + \blacksquare = b_{v+1}$ . Therefore, we have for  $0 \leq v \leq \ell$ ,

$$\begin{aligned} e_k(b_0) &= -2\ell\hbar b_1, \dots \\ e_k(b_v) &= (z_1 - \ell\hbar + 2v\hbar)^k (2(v - \ell)\hbar) b_{v+1}, \dots, \\ e_k(b_\ell) &= 0. \end{aligned}$$

By Proposition 3.1, the action of  $f_m$  is given by

$$\langle \lambda + \blacksquare | f_m | \lambda \rangle = (x_{\blacksquare})^m \prod_{\square \in \lambda} \frac{x_{\blacksquare} - x_{\square} + 2\hbar}{x_{\blacksquare} - x_{\square}}.$$

Similar as before, for  $\lambda = b_v$ , we have  $\lambda + \blacksquare = b_{v+1}$ . Therefore, we have

$$\begin{aligned} f_m(b_0) &= 0, \\ f_m(b_1) &= (z_1 - \ell\hbar)^m b_0, \dots, \\ f_m(b_{v+1}) &= (z_1 - \ell\hbar + 2v\hbar)^m (v + 1) b_v, v \leq \ell. \end{aligned}$$

Clearly, the module  $\mathbb{C}[\hbar, z] \otimes \mathbb{C}^{\ell+1}$  of  $Y_{\hbar}(\mathfrak{sl}_2)$  is an irreducible  $\ell + 1$ -dimensional representation. Therefore, it is isomorphic to  $ev^*(L(\ell))$ .

Comparing with the convention in [CP94, Chapter 12.1, section E], we have  $\hbar = -\frac{1}{2}$ , and the basis  $\{v_0, v_1, \dots, v_\ell\}$  in [CP94, Chapter 12.1, section E] is given by

$$v_s := \binom{\ell}{s} b_{\ell-s}, s = 0, 1, 2, \dots, \ell.$$

The element  $X_1^-$  is  $f_0$  and  $X_1^+$  is  $e_0$ . Therefore, setting  $\hbar = -\frac{1}{2}$ , as a representation of  $\mathfrak{sl}_2$ , we have

$$e_0(v_s) = (\ell - s + 1)v_{s-1}, \quad f_0(v_s) = (s + 1)v_{s+1}, \quad s = 0, 1, 2, \dots, \ell.$$

Furthermore, the equality

$$e_k(b_{\ell-s}) = (z_1 + \ell\hbar - 2s\hbar)^k (2(-s)\hbar) b_{\ell-s+1} = (z_1 - \frac{\ell}{2} + s)^k s b_{\ell-s+1}$$

implies that

$$(19) \quad e_k(v_s) = (z_1 - \frac{\ell}{2} + s)^k (\ell - s + 1) v_{s-1}.$$

The Drinfeld polynomial in the current paper is given by (see Lemma 3.4)

$$P(z) = \prod_{s=0}^{\ell-1} (z - z_1 + (\ell - 2s)\hbar).$$

so that, by the computation in Lemma 3.4, we have

$$\psi(z)|_{b_\ell} = \frac{P(z - 2\hbar)}{P(z)} b_\ell.$$

The convention of the Drinfeld polynomial in [CP94, Chapter 12.1] is given by  $P_1(u) = \prod_{s=0}^{\ell-1} (u - a - \frac{1}{2}l + \frac{1}{2} + s)\hbar$ . Therefore, the formula (19) and the formula [CP94, Chapter 12.1 (27)] are slightly different.

**Corollary 3.5.** *We have the following isomorphism as representations of  $Y_{\hbar}(\mathfrak{sl}_2)$*

$$\bigoplus_{v \in \mathbb{N}} H_{c, \mathbb{C}^* \times T_w}^* (\tilde{X}(v, \vec{1}_w)^{st} / G_v, \varphi_w)^\vee \otimes_R K \cong \text{ev}_{z_1}^* (L(\ell_1)) \otimes \cdots \otimes \text{ev}_{z_w}^* (L(\ell_w)),$$

where the tensor product is the fusion tensor product which comes from the Drinfeld coproduct of  $Y_{\hbar}(\mathfrak{sl}_2)$ .

*Proof.* Let  $\lambda = (v_1, \dots, v_w) \in S(\ell_1, \dots, \ell_w)$  be the torus fixed point. Denote by  $\lambda_j = (v_j)$  the  $j$ -th column of the picture (8). In particular,  $\lambda_j \in S(\ell_j)$  is a torus fixed point of  $\mathfrak{M}^+(v_j, 1)$ .

Define the vector space isomorphism

$$\begin{aligned} \bigoplus_{v \in \mathbb{N}} H_{c, \mathbb{C}^* \times T_w}^* (\tilde{X}(v, \vec{1}_w)^{st} / G_v, \varphi_w)^\vee \otimes_R K &\rightarrow \text{ev}_{z_1}^* (L(\ell_1)) \otimes \cdots \otimes \text{ev}_{z_w}^* (L(\ell_w)), \\ \lambda &\mapsto \lambda_1 \otimes \cdots \otimes \lambda_w. \end{aligned}$$

We now rewrite the formulas in Proposition 3.1 and Proposition 3.2. Let  $\blacksquare_j$  be the addible box at column  $j$ . Note that the weights  $x_\square$  are given by the formula (9). We have

$$\begin{aligned} &\langle \lambda | (e(g)) | \lambda + \blacksquare_j \rangle \\ &= \text{Res}_{z=x_{\blacksquare_j}} \left( g(z) \prod_{\square \in \lambda} \frac{z - x_\square}{z - x_\square - 2\hbar} \prod_{j=1}^w \frac{z - z_j - \ell_j \hbar}{z - z_j + \ell_j \hbar} \right), \\ &= \text{Res}_{z=x_{\blacksquare_j}} \left( g(z) \prod_{\square \in \lambda_j} \frac{z - x_\square}{z - x_\square - 2\hbar} \frac{z - z_j - \ell_j \hbar}{z - z_j + \ell_j \hbar} \prod_{\square \in \lambda \setminus \lambda_j} \frac{z - x_\square}{z - x_\square - 2\hbar} \prod_{i \in [1, w] \setminus j} \frac{z - z_i - \ell_i \hbar}{z - z_i + \ell_i \hbar} \right) \\ &= \left( \prod_{\square \in \lambda \setminus \lambda_j} \frac{x_{\blacksquare_j} - x_\square}{x_{\blacksquare_j} - x_\square - 2\hbar} \prod_{i \in [1, w] \setminus j} \frac{x_{\blacksquare_j} - z_i - \ell_i \hbar}{x_{\blacksquare_j} - z_i + \ell_i \hbar} \right) \langle \lambda_j | (e(g)) | \lambda_j + \blacksquare_j \rangle \end{aligned}$$

Therefore, the action of  $e(g)$  on the tensor  $\lambda_1 \otimes \cdots \otimes \lambda_w$  is given by

$$e(g)(\lambda_1 \otimes \cdots \otimes \lambda_w) = \sum_{j=1}^w \left( \prod_{\square \in \lambda \setminus \lambda_j} \frac{x_{\blacksquare_j} - x_\square}{x_{\blacksquare_j} - x_\square - 2\hbar} \prod_{i \in [1, w] \setminus j} \frac{x_{\blacksquare_j} - z_i - \ell_i \hbar}{x_{\blacksquare_j} - z_i + \ell_i \hbar} \right) (\lambda_1 \otimes \cdots \otimes \lambda_{j-1} \otimes e(g)(\lambda_j) \otimes \lambda_{j+1} \otimes \cdots \otimes \lambda_w).$$

Similarly, we have

$$\langle \lambda + \blacksquare_j | (f(g)) | \lambda \rangle = \prod_{\square \in \lambda \setminus \lambda_j} \frac{x_{\blacksquare_j} - x_\square + 2\hbar}{x_{\blacksquare_j} - x_\square} \left( g(z) \langle \lambda_j + \blacksquare_j | (f(g)) | \lambda_j \rangle \right).$$

Thus, the action of  $f(g)$  on the tensor  $\lambda_1 \otimes \cdots \otimes \lambda_w$  is given by

$$f(g)(\lambda_1 \otimes \cdots \otimes \lambda_w) = \sum_{j=1}^w \prod_{\square \in \lambda \setminus \lambda_j} \frac{x_{\blacksquare_j} - x_\square + 2\hbar}{x_{\blacksquare_j} - x_\square} (\lambda_1 \otimes \cdots \otimes \lambda_{j-1} \otimes f(g)(\lambda_j) \otimes \lambda_{j+1} \otimes \cdots \otimes \lambda_w).$$

By Proposition 3.2, the action of  $\psi(z)$  on the tensor  $\lambda_1 \otimes \cdots \otimes \lambda_w$  is given by

$$\psi(z)(\lambda_1 \otimes \cdots \otimes \lambda_w) = \psi(z)(\lambda_1) \otimes \cdots \otimes \psi(z)(\lambda_w).$$

Comparing with the formulas in [H07, §3.4, example] (the case of quantum affine algebra) and [YZ16] (the case of Yangian), the action of Yangian on the tensor product  $\text{ev}_{z_1}^*(L(\ell_1)) \otimes \cdots \otimes \text{ev}_{z_w}^*(L(\ell_w))$  comes from the Drinfeld coproduct of  $Y_{\hbar}(\mathfrak{sl}_2)$ .  $\square$

#### 4. FRAMED SHUFFLE FORMULA

**4.1. Framed shuffle algebra.** Fix  $w \in \mathbb{N}$ . We write an element in  $\mathbb{N}^w$  as the vector form  $\vec{n} = (n_1, \dots, n_w)$ . Let  $\text{SH}_{fr}$  be an  $\mathbb{N} \times \mathbb{N}^w$ -graded  $\mathbb{C}[\hbar]$ -algebra. As a  $\mathbb{C}[\hbar]$ -module, we have

$$\text{SH}_{fr} = \bigoplus_{v \in \mathbb{N}, \vec{n} \in \mathbb{N}^w} \text{SH}_{v, \vec{n}}, \text{ where } \text{SH}_{v, \vec{n}} := \mathbb{C}[\hbar] \otimes \mathbb{C}[y_s]_{s=1, \dots, v}^{\mathcal{S}_v} \otimes \mathbb{C}[z_j^i]_{j=1, \dots, w, i=1, \dots, n_j},$$

where  $\mathcal{S}_v$  is the symmetric group of  $v$  letters, and  $\mathcal{S}_v$  naturally acts on the variables  $\{y_s\}_{s=1, \dots, v}$  by permutation. For any  $(v_1, \vec{n}_1)$  and  $(v_2, \vec{n}_2) \in \mathbb{N} \times \mathbb{N}^w$ , write  $v = v_1 + v_2$  and  $\vec{n} = \vec{n}_1 + \vec{n}_2$ . We consider  $\text{SH}_{v_1, \vec{n}_1} \otimes_{\mathbb{C}[\hbar]} \text{SH}_{v_2, \vec{n}_2}$  as a subalgebra of  $\mathbb{C}[\hbar][y_s, z_j^i]_{\{s=1, \dots, v, j=1, \dots, w, i=1, \dots, n_j\}}$  by sending  $(y'_s, z'_j) \in \text{SH}_{v_1, \vec{n}_1}$  to  $(y_s, z_j^i)$ , and  $(y''_s, z''_j) \in \text{SH}_{v_2, \vec{n}_2}$  to  $(y_{s+v_1}, z_j^{i+n_j})$ .

We define the shuffle product  $\text{SH}_{v_1, \vec{n}_1} \otimes_{\mathbb{C}[\hbar]} \text{SH}_{v_2, \vec{n}_2} \rightarrow \text{SH}_{v, \vec{n}}$ ,

$$(20) \quad f(y_{v_1}, z_{\vec{n}_1}) \otimes g(y_{v_2}, z_{\vec{n}_2}) \mapsto \sum_{\sigma \in \text{Sh}(v_1, v_2)} \sigma(f(y'_{v_1}, z'_{\vec{n}_1}) \cdot g(y''_{v_2}, z''_{\vec{n}_2}) \cdot \text{fac}_{v_1+v_2, \vec{n}_1+\vec{n}_2}),$$

where the factor is given by

$$\text{fac}_{(v_1, \vec{n}_1), (v_2, \vec{n}_2)} := \prod_{s=1}^{v_2} \prod_{t=1}^{v_1} \frac{y''_s - y'_t - 2\hbar}{y'_t - y''_s} \prod_{j=1}^w \left( \prod_{a \in [1, v_1], b \in [1, n_{2j}]} (z_j^{''b} - y'_a + \ell_j \hbar) \prod_{a \in [1, n_{1j}], b \in [1, v_2]} (y''_b - z_j^{''a} + \ell_j \hbar) \right),$$

here  $2\hbar$  comes from the weight of  $\epsilon$ , and  $-\ell_j \hbar$  comes from the weight of  $a_j$  and  $a_j^*$ ,  $j = 1, \dots, w$ .

The graded vector space  $\text{SH}_{fr}$  together with the shuffle product gives an algebra structure.

**4.2. The geometric construction of the framed shuffle algebra.** The geometric interpretations of the framed shuffle algebra  $\text{SH}_{fr}$  can be obtained from [YZ14, §3.2 and Proposition 3.2]. For the convenience of the readers, we recall the results here.

For any pair of dimension vectors  $(v_1, \vec{n}_1), (v_2, \vec{n}_2) \in \mathbb{N} \times \mathbb{N}^w$ , let  $v = v_1 + v_2$ , and  $\vec{n} = \vec{n}_1 + \vec{n}_2$ . We consider a map

$$m_{(v_1, \vec{n}_1), (v_2, \vec{n}_2)}^S : H_{c, G_{v_1} \times T_{n_1} \times \mathbb{C}^*}(\tilde{X}(v_1, \vec{n}_1))^\vee \otimes_{\mathbb{C}[\hbar]} H_{c, G_{v_2} \times T_{n_2} \times \mathbb{C}^*}(\tilde{X}(v_2, \vec{n}_2))^\vee \rightarrow H_{c, G_v \times T_n \times \mathbb{C}^*}(\tilde{X}(v, \vec{n}))^\vee,$$

defined as follows. For a vector space  $V$  of dimension  $v$ , let  $V_1$  be a subspace of  $V$  with dimension  $v_1$ . Denote by  $N$  a  $w$ -tuple of vector spaces of dimension vector  $\vec{n}$ . Let  $N_1 \subset N$  be  $w$ -tuple of subvector spaces of dimension vector  $\vec{n}_1$ . Define

$$\tilde{X}_{(v_1, \vec{n}_1), (v_2, \vec{n}_2)} := \{(\epsilon, a_1, a_1^*, \dots, a_w, a_w^*) \in \tilde{X}(v, \vec{n}) \mid \epsilon(V_1) \subset V_1, a_i(V_1) \subset N_1, a_i^*(N_1) \subset V_1, i \in [1, w]\} \subset \tilde{X}(v, \vec{n}).$$

An element  $(\epsilon, a_i, a_i^*) \in \tilde{X}_{(v_1, \vec{n}_1), (v_2, \vec{n}_2)}$  induces the following linear maps:

$$\begin{array}{ccccc}
V_1 & \xrightarrow{\epsilon|_{V_1}} & V_1 & & V_1 & \xrightarrow{(a_1, \dots, a_n)|_{V_1}} & N_1 & & N_1 & \xrightarrow{(a_1^*, \dots, a_n^*)|_{N_1}} & V_1 \\
\downarrow & & \downarrow & & \downarrow & & \downarrow & & \downarrow & & \downarrow \\
V & \xrightarrow{\epsilon} & V & & V & \xrightarrow{(a_1, \dots, a_n)} & N & & N & \xrightarrow{(a_1^*, \dots, a_n^*)} & V \\
\downarrow & & \downarrow & & \downarrow & & \downarrow & & \downarrow & & \downarrow \\
V/V_1 & \xrightarrow{\bar{\epsilon}} & V/V_1 & & V/V_1 & \xrightarrow{(\bar{a}_1, \dots, \bar{a}_n)} & N/N_1 & & N/N_1 & \xrightarrow{(\bar{a}_1^*, \dots, \bar{a}_n^*)} & V/V_1
\end{array}$$

We write  $G := G_v$ , and  $P \subset G_v$ , the parabolic subgroup preserving the subspace  $V_1$ . Let  $L := G_{v_1} \times G_{v_2}$  be the Levi subgroup of  $P$ . We have the following correspondence of  $G \times T_w \times \mathbb{C}^*$ -varieties:

$$G \times_P (\tilde{X}(v_1, \vec{n}_1) \times \tilde{X}(v_2, \vec{n}_2)) \xleftarrow{\phi} G \times_P \tilde{X}_{(v_1, \vec{n}_1), (v_2, \vec{n}_2)} \xrightarrow{\psi} G \times_P \tilde{X}(v, \vec{n}) \xrightarrow{\pi} \tilde{X}(v, \vec{n}).$$

Here  $\phi$  is induced by the map

$$\tilde{X}_{(v_1, \vec{n}_1), (v_2, \vec{n}_2)} \rightarrow \tilde{X}(v_1, \vec{n}_1) \times \tilde{X}(v_2, \vec{n}_2), (\epsilon, a_i, a_i^*) \mapsto ((\epsilon|_{V_1}, a_i|_{V_1}, a_i^*|_{N_1}), (\bar{\epsilon}, \bar{a}_i, \bar{a}_i^*))$$

the map  $\psi$  is induced by the embedding  $\tilde{X}_{(v_1, \vec{n}_1), (v_2, \vec{n}_2)} \subset \tilde{X}(v, \vec{n})$  and  $\pi$  is the action map

$$G \times_P \tilde{X}(v, \vec{n}) \rightarrow \tilde{X}(v, \vec{n}), (g, (\epsilon, a_i, a_i^*)) \mapsto g \cdot (\epsilon, a_i, a_i^*).$$

We now define the multiplication map  $m_{(v_1, \vec{n}_1), (v_2, \vec{n}_2)}^S$ . We first have the Künneth isomorphism.

$$\otimes : H_{c, G_{v_1} \times T_{n_1} \times \mathbb{C}^*}^*(\tilde{X}(v_1, \vec{n}_1))^\vee \otimes_{\mathbb{C}[\hbar]} H_{c, G_{v_2} \times T_{n_2} \times \mathbb{C}^*}^*(\tilde{X}(v_2, \vec{n}_2))^\vee \cong H_{c, L \times T_n \times \mathbb{C}^*}^*(\tilde{X}(v_1, \vec{n}_1) \times \tilde{X}(v_2, \vec{n}_2))^\vee.$$

Consider the following sequence of morphisms:

- (1) The isomorphism:  $H_{c, L \times T_n \times \mathbb{C}^*}^*(\tilde{X}(v_1, \vec{n}_1) \times \tilde{X}(v_2, \vec{n}_2))^\vee \cong H_{c, G \times T_n \times \mathbb{C}^*}^*(G \times_P (\tilde{X}(v_1, \vec{n}_1) \times \tilde{X}(v_2, \vec{n}_2)))^\vee$ .
- (2) The pullback map:

$$\phi^* : H_{c, G \times T_n \times \mathbb{C}^*}^*(G \times_P (\tilde{X}(v_1, \vec{n}_1) \times \tilde{X}(v_2, \vec{n}_2)))^\vee \rightarrow H_{c, G \times T_n \times \mathbb{C}^*}^*(G \times_P \tilde{X}_{(v_1, \vec{n}_1), (v_2, \vec{n}_2)})^\vee.$$

- (3) The pushforward  $\psi_*$

$$H_{c, G \times T_n \times \mathbb{C}^*}^*(G \times_P \tilde{X}_{(v_1, \vec{n}_1), (v_2, \vec{n}_2)})^\vee \rightarrow H_{c, G \times T_n \times \mathbb{C}^*}^*(G \times_P \tilde{X}(v, \vec{1}_w))^\vee$$

- (4) The pushforward  $\pi_*$

$$H_{c, G \times T_n \times \mathbb{C}^*}^*(G \times_P \tilde{X}(v, \vec{1}_w))^\vee \rightarrow H_{c, G \times T_n \times \mathbb{C}^*}^*(\tilde{X}(v, \vec{1}_w))^\vee$$

We define map  $m_{(v_1, \vec{n}_1), (v_2, \vec{n}_2)}^S$  to be the composition of the Künneth isomorphism with the above sequence of morphisms.

Now for any  $(v, \vec{n}) \in \mathbb{N} \times \mathbb{N}^w$ , we identify

$$\text{SH}_{v, \vec{n}} = \mathbb{C}[\hbar] \otimes \mathbb{C}[y_s]_{s=1, \dots, v}^{S_v} \otimes \mathbb{C}[z_j^i]_{j=1, \dots, w, i=1, \dots, n_j}$$

with the  $H_{\mathbb{C}^*}(\text{pt})$ -module  $H_{c, G_v \times T_n \times \mathbb{C}^*}^*(\tilde{X}(v, \vec{n}))^\vee$ , as  $\tilde{X}(v, \vec{n})$  is an affine space.

We identify the algebraically defined formal shuffle algebra multiplication in (20) with the geometrically defined  $m_{v_1, v_2}^S$  as follows.

**Proposition 4.1.** [YZ14, Proposition 3.2] *Under the identification*

$$\text{SH}_{v, \vec{n}} = \mathbb{C}[\hbar] \otimes \mathbb{C}[y_s]_{s=1, \dots, v}^{S_v} \otimes \mathbb{C}[z_j^i]_{j=1, \dots, w, i=1, \dots, n_j} \cong H_{c, G_v \times T_n \times \mathbb{C}^*}^*(\tilde{X}(v, \vec{n}))^\vee,$$

the map  $m_{(v_1, \vec{n}_1), (v_2, \vec{n}_2)}^S$  is equal to the multiplication map (20) of the shuffle algebra.

*Proof.* The map  $\psi : G \times_P \tilde{X}_{(v_1, \vec{n}_1), (v_2, \vec{n}_2)} \rightarrow G \times_P \tilde{X}(v, \vec{n})$  is an embedding of vector bundles on  $G/P$ . The pushforward  $\psi_*$  is the multiplication by the equivariant Euler class  $e_{G \times T_n \times \mathbb{C}^*}^\psi$  of the normal bundle of the embedding  $\psi$ . The normal bundle to  $\psi$  can be identified with

$$\mathcal{H}om_{\bar{\mathcal{O}}}(\mathcal{V}_1, \mathcal{V}_2) \oplus \mathcal{H}om_{\bar{\mathcal{O}}}(\mathcal{V}_1, \mathcal{N}_2) \oplus \mathcal{H}om_{\bar{\mathcal{O}}}(\mathcal{N}_1, \mathcal{V}_2)$$

where  $\mathcal{V}, \mathcal{N}$  are the tautological bundles on  $\tilde{X}(v, \vec{n})$ .

Taking into account of the  $\mathbb{C}^*$ -weights of  $\epsilon, a_i, a_i^*$ , we have the equivariant Euler class of the normal bundle to  $\psi$  is

$$e_{G \times T_n \times \mathbb{C}^*}^\psi = \prod_{s=1}^{v_2} \prod_{t=1}^{v_1} (y_s'' - y_t' - 2\hbar) \prod_{j=1}^w \left( \prod_{a \in [1, v_1], b \in [1, n_{2j}]} (z_j''^b - y_a' + \ell_j \hbar) \prod_{a \in [1, n_{1j}], b \in [1, v_2]} (y_b'' - z_j'^a + \ell_j \hbar) \right).$$

The map  $\pi : G \times_P \tilde{X}(v, \vec{n}) \rightarrow \tilde{X}(v, \vec{n})$  is a Grassmannian bundle. So the pushforward  $\pi_*$  can be computed, see for example [YZ14, Proposition 1.2]. Putting all the above together, the map  $m_{v_1, v_2}^S$  is given by exactly the same formula as (20).  $\square$

## 5. THE WEIGHT FUNCTIONS

In this section, we define the weight functions using the framed shuffle formula (20) and study their properties.

5.1. Let  $v \in \mathbb{N}$ . For any  $\vec{n} = (n_1, n_2, \dots, n_w) \in \mathbb{N}^w$  such that  $n_i \in \{0, 1\}$ , write

$$z_{\vec{n}} = \{z_i \mid \text{for the index } i \text{ such that } n_i = 1\}.$$

Set

$$\text{SH}_{v, \vec{n}} := \mathbb{C}[\hbar] \otimes \mathbb{C}[y_1, y_2, \dots, y_v]^{S_v} \otimes \mathbb{C}[z_{\vec{n}}].$$

The variable  $z_i$  is the equivariant parameter coming from the the framing vertex  $i$ , such that  $n_i = 1$ . In particular, for the vector  $\vec{1}_w = (1, 1, \dots, 1) \in \mathbb{N}^w$ . We have  $\text{SH}_{v, \vec{1}_w} = \mathbb{C}[\hbar] \otimes \mathbb{C}[y_1, y_2, \dots, y_v]^{S_v} \otimes \mathbb{C}[z_1, z_2, \dots, z_w]$ .

Let  $\lambda = (v_1, \dots, v_w) \in S(\ell_1, \dots, \ell_w)$  be a torus fixed point. Let  $e_i := (0, \dots, 0, 1, 0, \dots, 0) \in \mathbb{N}^w$ , where  $i$  is at the  $i$ -th place. Consider the multiplication

$$(21) \quad \star_\lambda : \text{SH}_{v_1, e_1} \otimes \text{SH}_{v_1, e_2} \otimes \dots \otimes \text{SH}_{v_w, e_w} \rightarrow \text{SH}_{v, \vec{1}_w}$$

We consider the image of  $1 \otimes 1 \otimes \dots \otimes 1$  under  $\star_\lambda$ .

Define the weight function associated to  $\text{id} \in \mathcal{S}_w$  at  $\lambda$  to be

$$(22) \quad W_\lambda^{\text{id}} := 1 \star_\lambda 1 \star_\lambda \dots \star_\lambda 1 \in \mathbb{C}[\hbar] \otimes \mathbb{C}[y_s]_{s=1, \dots, v}^{S_v} \otimes \mathbb{C}[z_t]_{t=1, \dots, w}$$

The permutation group  $\mathcal{S}_w$  permutes the variables  $\{z_1, \dots, z_w\}$  in  $\text{SH}_{v, w}$ .

We introduce the following notations.

- We say  $I = (I_1, I_2, \dots, I_w)$  is a partition of  $[1, v]$ , denoted by  $(I_1, I_2, \dots, I_w) \vdash [1, v]$ , if  $I_1, I_2, \dots, I_w$  are subsets of  $[1, v]$  such that  $I_1 \sqcup I_2 \sqcup \dots \sqcup I_w = [1, v]$  and  $|I_1| = v_1, \dots, |I_w| = v_w$ .
- For two sets  $I, J$ , we write  $y_I - y_J$  means the product  $\prod_{i \in I, j \in J} (y_i - y_j)$ . In particular, we have

$$y_I - y_J - 2\hbar = \prod_{i \in I, j \in J} (y_i - y_j - 2\hbar), \text{ and } z_j - y_I + \ell_j \hbar = \prod_{i \in I} (z_j - y_i + \ell_j \hbar).$$

Inductively using the formula (20), we then have

$$(23) \quad W_\lambda^{\text{id}} = \sum_{I=(I_1, I_2, \dots, I_w) \vdash [1, v], |I_j|=v_j} W_{\lambda, I}^{\text{id}} \\ = \sum_{(I_1, I_2, \dots, I_w) \vdash [1, v], |I_j|=v_j} \left( \prod_{1 \leq t < s \leq w} \frac{y_{I_s} - y_{I_t} - 2\hbar}{y_{I_t} - y_{I_s}} \right) \cdot \left( \prod_{1 \leq s < a \leq w} (z_a - y_{I_s} + \ell_a \hbar) \right) \left( \prod_{1 \leq a < s \leq w} (y_{I_s} - z_a + \ell_a \hbar) \right).$$

Here

$$(24) \quad W_{\lambda, I}^{\text{id}} := \left( \prod_{1 \leq t < s \leq w} \frac{y_{I_s} - y_{I_t} - 2\hbar}{y_{I_t} - y_{I_s}} \right) \left( \prod_{1 \leq s < a \leq w} (z_a - y_{I_s} + \ell_a \hbar) \right) \left( \prod_{1 \leq a < s \leq w} (y_{I_s} - z_a + \ell_a \hbar) \right) \\ \in \mathbb{C}[\hbar] \otimes \mathbb{C}[y_s]_{s=1, \dots, v}^{\mathcal{S}_v} \left[ \prod_{i \neq j} \frac{1}{y_i - y_j} \right] \otimes \mathbb{C}[z_1, \dots, z_w]$$

Note that  $W_\lambda^{\text{id}}$  is regular in the variables  $y_1, \dots, y_v$ , but  $W_{\lambda, I}^{\text{id}}$  could have poles at  $y_i - y_j = 0$ .

**5.2. Restriction to torus fixed points.** For each fixed point  $\mu = (\mu_1, \mu_2, \dots, \mu_w) \in S(\ell_1, \dots, \ell_w)$ , we restrict the weight functions at fixed point  $\mu$ , denoted by  $W_{\lambda}^{\text{id}}|_{\mu}$ . That is, we substitute  $y_1, \dots, y_v$  in  $W^{\text{id}}(v, \vec{I}_w)_\lambda$  according to the equivariant Chern roots of  $V$  at the fixed point  $\mu$ :

$$(25) \quad z_i - \ell_i \hbar, z_i - (\ell_i - 2)\hbar, z_i - (\ell_i - 4)\hbar, \dots, z_i - (\ell_i - 2\mu_i + 2)\hbar, \quad i = 1, \dots, w.$$

Thus,  $W_{\lambda}^{\text{id}}|_{\mu} \in \mathbb{C}[\hbar, z_1, \dots, z_w]$ . Note that  $y_1, \dots, y_v$  is invariant under the permutation group  $\mathcal{S}_v$ , therefore any ordering of  $y_1, \dots, y_v$  under the substitution gives the same answer.

### 5.3. Properties of the weight functions.

**5.3.1.** Clearly, when  $w = 0$ , there is only one fixed point 0. We have  $W_0^{\text{id}} = 1$ . When  $v = 1$ , the variables are  $y, z_1, \dots, z_w$  in  $\text{SH}_{1, \vec{I}_w}$ . There are  $w$  number of partitions of  $\{1\}$ . We have

$$(I_1, \dots, I_s, \dots, I_w) = (\emptyset, \dots, \{1\}, \dots, \emptyset),$$

for only one subset  $I_s = \{1\}$ , and  $I_t = \emptyset$ , for  $s \neq t$ .

For the tuple  $e_s := (0, 0, \dots, 1, \dots, 0)$  with 1 at the position  $s$ . We have

$$(26) \quad W_{e_s}^{\text{id}} = \prod_{\{a|s < a \leq w\}} (z_a - y + \ell_a \hbar) \prod_{\{a|1 \leq a < s\}} (y - z_a + \ell_a \hbar) \in \text{SH}_{1, \vec{I}_w}.$$

**5.3.2.** We use the lexicographical order on the set of torus fixed points. That is: for  $\lambda = (v_1, \dots, v_w)$  and  $\mu = (\mu_1, \dots, \mu_w)$  in  $S(\ell_1, \dots, \ell_w)$ , we define

$$\lambda = (v_1, \dots, v_w) < \mu = (\mu_1, \dots, \mu_w) \iff v_1 = \mu_1, \dots, v_a = \mu_a, v_{a+1} < \mu_{a+1}, \text{ for some } a \in [1, w].$$

For two fixed points  $\lambda$  and  $\mu$ , set

$$\deg(W_{\lambda, I}^{\text{id}}|_{\mu}) := \sum_{1 \leq i < j \leq w} (\deg_{z_i - z_j}(W_{\lambda, I}^{\text{id}}|_{\mu})),$$

$$\deg(W_{\lambda}^{\text{id}}|_{\mu}) := \max\{\deg(W_{\lambda, I}^{\text{id}}|_{\mu}) \mid I \vdash [1, v]\}$$

Equivalently,  $\deg(W_{\lambda}^{\text{id}}|_{\mu})$  is the degree of the regular function  $W_{\lambda}^{\text{id}}|_{\mu}$  in  $z_1, z_2, \dots, z_w$ , such that

$$\deg(z_i) = 1, i \in [1, w], \quad \deg(\hbar) = 0.$$

We have the following properties for the weight functions  $W_{\lambda}^{\text{id}}$ . They are similar to the properties from [RTV15, Lemma 3.1].

**Lemma 5.1.** *Let  $\lambda, \mu \in S(\ell_1, \dots, \ell_w)$  be two fixed points of  $\mathfrak{M}(v, \vec{I}_w)$ .*

(1) If  $\lambda < \mu$ , we have

$$W_\lambda^{\text{id}}|_\mu = 0.$$

(2) If  $\lambda = \mu$ , we have

$$W_\lambda^{\text{id}}|_\lambda = \prod_{1 \leq s < a \leq w} \left( \prod_{i=v_s-v_a+1}^{v_s} (z_s - z_a + 2i\hbar + (\ell_a - \ell_s)\hbar) \prod_{i=0}^{v_s-1} (z_a - z_s - 2i\hbar + (\ell_s + \ell_a)\hbar) \right).$$

In particular, for  $1 \leq s < a \leq w$ , the degree of  $z_s - z_a$  in  $W_\lambda^{\text{id}}|_\lambda$  is  $v_a + v_s$  and therefore,

$$\deg(W_\lambda^{\text{id}}|_\lambda) = (w-1)v.$$

(3) For each partition  $I = (I_1, I_2, \dots, I_w) \vdash [1, v]$ , with  $|I_j| = v_j$ , for any two fixed points  $\lambda \geq \mu$ , let  $I_i^j := I_i \cap [\sum_{s=1}^{j-1} \mu_s + 1, \sum_{s=1}^j \mu_s]$ , then we have

$$\deg_{z_i - z_j}(W_{\lambda, I}^{\text{id}}|_\mu) = \mu_j + \mu_i - |I_i^j|$$

and

$$\deg(W_{\lambda, I}^{\text{id}}|_\mu) = (w-1)v - \sum_{i < j} |I_i^j|$$

(4) For any  $w \in \mathbb{N}$ , we have, for  $\lambda \geq \mu$ , then,

$$\deg(W_\lambda^{\text{id}}|_\lambda) \geq \deg(W_\lambda^{\text{id}}|_\mu).$$

*Proof.* This follows from a direct computation. For the convenience of the reader, we include a proof here.

At the fixed point  $\mu$ , we use the following substitution

$$\begin{aligned} y_1 &= z_1 - \ell_1 \hbar, \quad y_2 = z_1 - \ell_1 \hbar + 2\hbar, \quad \dots, \quad y_{\mu_1} = z_1 - \ell_1 \hbar + 2(\mu_1 - 1)\hbar, \\ y_{\mu_1+1} &= z_2 - \ell_2 \hbar, \quad y_{\mu_1+2} = z_2 - \ell_2 \hbar + 2\hbar, \quad \dots, \quad y_{\mu_1+\mu_2} = z_2 - \ell_2 \hbar + 2(\mu_2 - 1)\hbar \\ &\dots \\ y_{\sum_{i=1}^{a-1} \mu_i+1} &= z_a - \ell_a \hbar, \quad y_{\sum_{i=1}^{a-1} \mu_i+2} = z_a - \ell_a \hbar + 2\hbar, \quad \dots, \quad y_{\sum_{i=1}^a \mu_i} = z_a - \ell_a \hbar + 2(\mu_a - 1)\hbar. \end{aligned}$$

For each partition  $I = (I_1, I_2, \dots, I_w) \vdash [1, v]$  such that  $|I_1| = v_1, \dots, |I_w| = v_w$ , the summand  $W_{\lambda, I}^{\text{id}}|_\mu$  is given by the formula (24). Note that the factor  $y_{I_s} - z_a + \ell_a \hbar$  is zero, if and only if there exists an  $a \in [1, w]$  and an  $s$  with  $a < s \leq w$  such that

$$\sum_{i=1}^{a-1} \mu_i + 1 \in I_s,$$

Assume  $W_{\lambda, I}^{\text{id}}|_\mu$  (24) is non-zero. Then,  $y_{I_s} - z_a + \ell_a \hbar \neq 0$  implies  $\sum_{i=1}^{a-1} \mu_i + 1 \notin I_s$ , for any  $a \in [1, w]$  and any  $s$  such that  $a < s \leq w$ . This forces that

$$1 \in I_1, \quad \mu_1 + 1 \in I_1 \sqcup I_2, \quad \dots, \quad \sum_{i=1}^{a-1} \mu_i + 1 \in \sqcup_{s=1}^a I_s, \quad \dots$$

The factor  $y_{I_s} - y_{I_t} - 2\hbar \neq 0$ , with  $s > t$ , implies that

If  $1 \in I_1$ , then we must have  $2, 3, \dots, \mu_1 \in I_1$ ,

If  $\mu_1 + 1 \in I_1 \sqcup I_2$ , then we must have  $\mu_1 + 2, \mu_1 + 3, \dots, \mu_1 + \mu_2 \in I_1 \sqcup I_2$ ,

furthermore, if  $\mu_1 + k \in I_2$ , then we must have  $\mu_1 + k - 1, \mu_1 + k - 2, \dots, \mu_1 + 1 \in I_2$ ,

$\dots$ ,

If  $\sum_{i=1}^{a-1} \mu_i + 1 \in \sqcup_{s=1}^a I_s$ , then we must have  $\sum_{i=1}^{a-1} \mu_i + 2, \sum_{i=1}^{a-1} \mu_i + 3, \dots, \sum_{i=1}^a \mu_i \in \sqcup_{s=1}^a I_s$ ,

furthermore, if  $\sum_{i=1}^{a-1} \mu_i + k \in I_m$ , then we must have  $\sum_{i=1}^{a-1} \mu_i + k - 1, \dots, \sum_{i=1}^{a-1} \mu_i + 1 \in I_m \sqcup I_{m+1} \dots \sqcup I_a$ .

Proof of (1): By assumption, we have the total order  $(v_1, \dots, v_w) < (\mu_1, \dots, \mu_w)$ . That is, there exists some number  $a \in [1, w]$ , such that  $v = \mu_1, \dots, v_a = \mu_a$ , and  $v_{a+1} < \mu_{a+1}$ . Therefore

$$|I_1| = v_1 = \mu_1, \dots, |I_a| = v_a = \mu_a, |I_{a+1}| = v_{a+1} < \mu_{a+1}.$$

The discussion above shows that, if  $W_{\lambda, I}^{\text{id}}|_{\mu}$  (24) is non-zero, we have the following inequalities:

$$|I_1| \geq \mu_1, |I_1| + |I_2| \geq \mu_1 + \mu_2, \dots, \sum_{i=1}^a |I_i| \geq \sum_{i=1}^a \mu_i, \dots$$

This is a contradiction. Therefore,  $W_{\lambda}^{\text{id}}|_{\mu} = 0$ .

Proof of (2): If  $W_{\lambda, I}^{\text{id}}|_{\mu}$  (24) is non-zero and  $\lambda = \mu$ , then, we must have

$$I_1 = [1, v_1], I_2 = [v_1 + 1, v_1 + v_2], \dots, I_v = [\sum_{i=1}^{w-1} v_i, v].$$

Therefore, we have the substitution  $y_{I_s} = z_s - \ell_s + 2j\hbar$ ,  $j = 0, 1, \dots, v_{s-1}$ , for any  $s = 1, \dots, w$ . Substituting in the formula of  $W_{\lambda}^{\text{id}}$ , we have

$$\begin{aligned} W_{\lambda}^{\text{id}}|_{\lambda} &= \left( \prod_{1 \leq t < s \leq w} \frac{\prod_{i=0}^{v_s-1} \prod_{j=0}^{v_t-1} ((z_s - \ell_s \hbar + 2i\hbar) - (z_t - \ell_t \hbar + 2j\hbar) - 2\hbar)}{\prod_{i=0}^{v_s-1} \prod_{j=0}^{v_t-1} ((z_t - \ell_t \hbar + 2j\hbar) - (z_s - \ell_s \hbar + 2i\hbar))} \right) \\ &\quad \left( \prod_{1 \leq s < a \leq w} \prod_{i=0}^{v_s-1} (z_a - (z_s - \ell_s \hbar + 2i\hbar) + \ell_a \hbar) \right) \prod_{1 \leq a < s \leq w} \left( \prod_{i=0}^{v_s-1} ((z_s - \ell_s \hbar + 2i\hbar) - z_a + \ell_a \hbar) \right) \\ &= \prod_{1 \leq s < a \leq w} \left( \prod_{i=v_s-v_a+1}^{v_s} (z_s - z_a + 2i\hbar + (\ell_a - \ell_s)\hbar) \prod_{i=0}^{v_s-1} (z_a - z_s - 2i\hbar + (\ell_s + \ell_a)\hbar) \right) \end{aligned}$$

Clearly, for  $1 \leq s < a \leq w$ , the degree of  $z_s - z_a$  is  $v_a + v_s$ .

Proof of (3): In general, for the fixed point  $\mu$ , set

$$I_a^1 := I_a \cap [1, \mu_1], I_a^2 := I_a \cap [\mu_1 + 1, \mu_1 + \mu_2], \dots, I_a^w := I_a \cap \left[ \sum_{i=1}^{w-1} \mu_i + 1, v \right], \text{ for } a = 1, 2, \dots, w.$$

Then,  $I_a = I_a^1 \sqcup I_a^2 \sqcup \dots \sqcup I_a^w$  and  $[\sum_{i=1}^{k-1} \mu_i + 1, \sum_{i=1}^k \mu_i] = I_1^k \sqcup \dots \sqcup I_w^k$ . The restriction  $W_{\lambda, I}^{\text{id}}|_{\mu}$  is non-zero, then

- (1)  $I_a^i = \emptyset$ , if  $i < a$ ;
- (2) and for each  $k \in [1, w]$ , in the decomposition  $[\sum_{i=1}^{k-1} \mu_i + 1, \sum_{i=1}^k \mu_i] = I_1^k \sqcup \dots \sqcup I_k^k$ , the ordering of the elements is  $i_s < i_t$ , for any  $i_s \in I_s^k, i_t \in I_t^k$  with  $s > t$ . We write  $I_k^k < I_{k-1}^k < \dots < I_1^k$  for short.



By setting  $\hbar = 0$ , if  $W_{\lambda, I}^{\text{id}}|_{\mu}$  is non-zero, then the degree of  $W_{\lambda, I}^{\text{id}}|_{\mu}$  can be computed as follows.

$$\deg(W_{\lambda, I}^{\text{id}}|_{\mu}) = \deg\left(\prod_{a \in [1, w]} \prod_{\{1 \leq s \leq b \leq w | s \neq a, b \neq a\}} (z_a - y_{I_s^b})\right)|_{\mu} = \deg\left(\prod_{1 \leq a \neq b \leq w} \prod_{\{1 \leq s \leq b | s \neq a\}} (z_a - z_b)^{|I_s^b|}\right).$$

Therefore, for  $i < j$ , if  $W_{\lambda, I}^{\text{id}}|_{\mu}$  is non-zero, then the power of  $z_i - z_j$  in  $W_{\lambda, I}^{\text{id}}|_{\mu}$  is given by

$$\sum_{\{1 \leq s \leq j | s \neq i\}} |I_s^j| + \sum_{1 \leq s \leq i} |I_s^i| = \mu_j + \mu_i - |I_i^j|.$$

Proof of (4): It follows from (3) that

$$\deg(W_{\lambda}^{\text{id}}|_{\mu, I}) = (w-1)v - \sum_{i < j} |I_i^j| \leq (w-1)v = \deg(W_{\lambda}^{\text{id}}|_{\lambda}),$$

for any partition  $I$ . This shows the assertion.  $\square$

**5.4. The action of  $\mathcal{S}_w$ .** Recall we have the fixed point set from (7)

$$S(\ell_1, \dots, \ell_w) = \{(v_1, v_2, \dots, v_w) \mid 0 \leq v_i \leq \ell_i, \forall i \in [1, w], \text{ and } \sum_{i=1}^w v_i = v\}.$$

For any element  $\sigma$  in the symmetric group  $\mathcal{S}_w$ ,  $\sigma$  permutes  $(\ell_1, \dots, \ell_w)$  by  $\sigma \cdot (\ell_1, \dots, \ell_w) = (\ell_{\sigma(1)}, \dots, \ell_{\sigma(w)})$ . Therefore, we have the following

$$\sigma : S(\ell_1, \dots, \ell_w) \rightarrow S(\ell_{\sigma(1)}, \dots, \ell_{\sigma(w)}), \quad (v_1, \dots, v_w) \mapsto (v_{\sigma(1)}, \dots, v_{\sigma(w)})$$

Define the weight function associated to  $\sigma \in \mathcal{S}_w$  at  $\lambda \in S(\ell_{\sigma(1)}, \dots, \ell_{\sigma(w)})$  to be

$$(27) \quad W_{\lambda}^{\sigma}(y_1, \dots, y_w; z_1, \dots, z_w; \hbar) := W_{\sigma^{-1}\lambda}^{\text{id}}(y_1, \dots, y_w; z_{\sigma^{-1}(1)}, \dots, z_{\sigma^{-1}(w)}; \hbar),$$

where  $\sigma^{-1}(\lambda) = \sigma^{-1}(v_1, \dots, v_w) = (v_{\sigma^{-1}(1)}, \dots, v_{\sigma^{-1}(w)}) \in S(\ell_1, \dots, \ell_w)$ .

For a general element  $\sigma \in \mathcal{S}_w$ , we define the total order on the set  $S(\ell_{\sigma(1)}, \dots, \ell_{\sigma(w)})$  depending on  $\sigma$  by

$$\lambda \leq_{\sigma} \mu \text{ in } S(\ell_{\sigma(1)}, \dots, \ell_{\sigma(w)}) \iff \sigma^{-1}(\lambda) \leq \sigma^{-1}(\mu) \text{ in } S(\ell_1, \dots, \ell_w).$$

Then, Lemma 5.1 implies the following.

**Lemma 5.2.** (1) Let  $\sigma \in \mathcal{S}_w$ . Let  $\lambda, \mu$  be two fixed points in  $S(\ell_{\sigma(1)}, \dots, \ell_{\sigma(w)})$ . If  $\lambda <_{\sigma} \mu$ , we have

$$W_{\lambda}^{\sigma}|_{\mu} = 0.$$

(2) For any  $w \in \mathbb{N}$ , we have, for  $\lambda \geq_{\sigma} \mu$ , then,

$$\deg(W_{\lambda}^{\sigma}|_{\lambda}) \geq \deg(W_{\lambda}^{\sigma}|_{\mu}).$$

*Proof.* By definition we have

$$W_{\lambda}^{\sigma}(y_1, \dots, y_w; z_1, \dots, z_w; \hbar)|_{\mu} = W_{\sigma^{-1}\lambda}^{\text{id}}(y_1, \dots, y_w; z_{\sigma^{-1}(1)}, \dots, z_{\sigma^{-1}(w)}; \hbar)|_{\sigma^{-1}\mu}.$$

By Lemma 5.1, the above is zero if  $\sigma^{-1}(\lambda) < \sigma^{-1}(\mu)$ , which is equivalent to  $\lambda <_{\sigma} \mu$ . This shows (1). (2) follows from Lemma 5.1 (4).  $\square$

## 6. COMPUTATION OF R-MATRICES

**6.1. Case  $w = 1$ .** Fix the dimension vector  $(v, \vec{1}_w)$  of  $\tilde{Q}$ . For  $w = 1$ , there is only one fixed point  $\lambda = v \in \mathbb{N}$ , and the multiplication  $\star_{\lambda}$  is the identity map. Therefore,

$$W_v^{\text{id}} = 1.$$

**6.2. Case  $w = 2$ .** Fix  $(\ell_1, \ell_2) \in \mathbb{N}^2$ . In this case, there are two variables  $z_1, z_2$ . Let  $(21) \in \mathcal{S}_2$  be the non-trivial element. Write the fixed points as a pair  $(v_1, v_2)$ , such that  $v_1 + v_2 = v$ , and  $0 \leq v_1 \leq \ell_1, 0 \leq v_2 \leq \ell_2$ .

We have

$$W_{(v_1, v_2)}^{\text{id}} = \sum_{(I_1, I_2) \vdash [1, v], |I_1|=v_1, |I_2|=v_2} \left( \frac{y_{I_2} - y_{I_1} - 2\hbar}{y_{I_1} - y_{I_2}} \right) (z_2 - y_{I_1} + \ell_2 \hbar)(y_{I_2} - z_1 + \ell_1 \hbar) \in \mathbb{C}[\hbar][y_1, \dots, y_v]^{S_v} \otimes \mathbb{C}[z_1, z_2],$$

$$W_{(v_2, v_1)}^{(21)} = \sum_{(I_1, I_2) \vdash [1, v], |I_1|=v_1, |I_2|=v_2} \left( \frac{y_{I_2} - y_{I_1} - 2\hbar}{y_{I_1} - y_{I_2}} \right) (z_1 - y_{I_1} + \ell_1 \hbar)(y_{I_2} - z_2 + \ell_2 \hbar) \in \mathbb{C}[\hbar][y_1, \dots, y_v]^{S_v} \otimes \mathbb{C}[z_1, z_2].$$

**6.2.1.** For  $v = 1, w = 2$ , there are 2 fixed points:

- $(v_1, v_2) = (1, 0)$  which gives the partition  $(I_1, I_2) = (\{1\}, \emptyset)$ .
- $(v_1, v_2) = (0, 1)$  which gives the partition  $(I_1, I_2) = (\emptyset, \{1\})$ .

Using the formula (26), the weight functions are then

$$W_{(1,0)}^{\text{id}} = z_2 - y + \ell_2 \hbar, \quad W_{(0,1)}^{\text{id}} = y - z_1 + \ell_1 \hbar.$$

and

$$W_{(1,0)}^{(21)} = y - z_2 + \ell_2 \hbar, \quad W_{(0,1)}^{(21)} = z_1 - y + \ell_1 \hbar.$$

At the fixed point  $(1, 0)$ , the weight of  $V$  is  $y = z_1 - \ell_1 \hbar$ , and at the fixed point  $(0, 1)$ , the weight of  $V$  is  $y = z_2 - \ell_2 \hbar$ . Therefore,

$$\begin{aligned} W_{(1,0)}^{\text{id}}|_{(1,0)} &= z_2 - (z_1 - \ell_1 \hbar) + \ell_2 \hbar = -z + (\ell_1 + \ell_2) \hbar, \\ W_{(1,0)}^{\text{id}}|_{(0,1)} &= z_2 - (z_2 - \ell_2 \hbar) + \ell_2 \hbar = 2\ell_2 \hbar \\ W_{(0,1)}^{\text{id}}|_{(1,0)} &= (z_1 - \ell_1 \hbar) - z_1 + \ell_1 \hbar = 0, \\ W_{(0,1)}^{\text{id}}|_{(0,1)} &= (z_2 - \ell_2 \hbar) - z_1 + \ell_1 \hbar = -z + (\ell_1 - \ell_2) \hbar. \end{aligned}$$

Similarly, we have the restrictions

$$\begin{aligned} W_{(1,0)}^{(21)}|_{(1,0)} &= (z_1 - \ell_1 \hbar) - z_2 + \ell_2 \hbar = z - (\ell_1 - \ell_2) \hbar, \\ W_{(1,0)}^{(21)}|_{(0,1)} &= (z_2 - \ell_2 \hbar) - z_2 + \ell_2 \hbar = 0, \\ W_{(0,1)}^{(21)}|_{(1,0)} &= z_1 - (z_1 - \ell_1 \hbar) + \ell_1 \hbar = 2\ell_1 \hbar, \\ W_{(0,1)}^{(21)}|_{(0,1)} &= z_1 - (z_2 - \ell_2 \hbar) + \ell_1 \hbar = z + (\ell_1 + \ell_2) \hbar. \end{aligned}$$

Therefore, we have

$$\begin{aligned} R(z) &= [W_\lambda^{\text{id}}|_\mu]^{-1} [W_\lambda^{(21)}|_\mu] \\ &= \begin{bmatrix} -z + (\ell_1 + \ell_2) \hbar & 0 \\ 2\ell_2 \hbar & -z + (\ell_1 - \ell_2) \hbar \end{bmatrix}^{-1} \begin{bmatrix} z - (\ell_1 - \ell_2) \hbar & 2\ell_1 \hbar \\ 0 & z + (\ell_1 + \ell_2) \hbar \end{bmatrix} \\ &= \frac{1}{(z - (\ell_1 + \ell_2) \hbar)(z - (\ell_1 - \ell_2) \hbar)} \begin{bmatrix} -z + (\ell_1 - \ell_2) \hbar & 0 \\ -2\ell_2 \hbar & -z + (\ell_1 + \ell_2) \hbar \end{bmatrix} \begin{bmatrix} z - (\ell_1 - \ell_2) \hbar & 2\ell_1 \hbar \\ 0 & z + (\ell_1 + \ell_2) \hbar \end{bmatrix} \\ &= \frac{1}{(z - (\ell_1 + \ell_2) \hbar)(z - (\ell_1 - \ell_2) \hbar)} \begin{bmatrix} -(z - (\ell_1 - \ell_2) \hbar)^2 & -2\ell_1 \hbar(z - (\ell_1 - \ell_2) \hbar) \\ -2\ell_2 \hbar(z - (\ell_1 - \ell_2) \hbar) & -z^2 + (\ell_1 - \ell_2)^2 \hbar^2 \end{bmatrix} \\ &= \frac{1}{z - (\ell_1 + \ell_2) \hbar} \begin{bmatrix} -z + (\ell_1 - \ell_2) \hbar & -2\ell_1 \hbar \\ -2\ell_2 \hbar & -z - (\ell_1 - \ell_2) \hbar \end{bmatrix} \end{aligned}$$

In the pure spin case, when  $\ell_1 = \ell_2 = \ell$ , we have

$$\begin{aligned} W_{(1,0)}^{(21)} &= \frac{-z}{z-2\ell\hbar} W_{(1,0)}^{\text{id}} + \frac{-2\ell\hbar}{z-2\ell\hbar} W_{(0,1)}^{\text{id}}, \\ W_{(0,1)}^{(21)} &= \frac{-2\ell\hbar}{z-2\ell\hbar} W_{(1,0)}^{\text{id}} + \frac{-z}{z-2\ell\hbar} W_{(0,1)}^{\text{id}} \end{aligned}$$

Therefore, when  $\ell_1 = \ell_2 = \ell$ , the transition matrix between the two bases is

$$\frac{1}{z-2\ell\hbar} \begin{bmatrix} -z & -2\ell\hbar \\ -2\ell\hbar & -z \end{bmatrix} = \frac{-z \text{Id} - 2\ell\hbar P}{z-2\ell\hbar}, \text{ where } \text{Id} = \begin{bmatrix} 1 & 0 \\ 0 & 1 \end{bmatrix} \text{ and } P = \begin{bmatrix} 0 & 1 \\ 1 & 0 \end{bmatrix}.$$

This is the well-known formula for the  $R$ -matrix of the Yangian  $Y(\mathfrak{sl}_2)$ .

6.2.2. For  $v = 2, w = 2$ , fix  $(\ell_1, \ell_2) \in \mathbb{N}^2$ , such that  $\ell_1 \geq 2$  and  $\ell_2 \geq 2$ , there are 3 fixed points:

- $(v_1, v_2) = (2, 0)$  which gives the partition  $(I_1, I_2) = (\{1, 2\}, \emptyset)$ .
- $(v_1, v_2) = (1, 1)$  which gives the partitions  $(I_1, I_2) = (\{1\}, \{2\})$  and  $(I_1, I_2) = (\{2\}, \{1\})$ .
- $(v_1, v_2) = (0, 2)$  which gives the partition  $(I_1, I_2) = (\emptyset, \{1, 2\})$ .

The weight functions are then

$$\begin{aligned} W_{(2,0)}^{\text{id}} &= (z_2 - y_1 + \ell_2\hbar)(z_2 - y_2 + \ell_2\hbar) \\ W_{(1,1)}^{\text{id}} &= \left(\frac{y_2 - y_1 - 2\hbar}{y_1 - y_2}\right)(z_2 - y_1 + \ell_2\hbar)(y_2 - z_1 + \ell_1\hbar) \\ &\quad + \left(\frac{y_1 - y_2 - 2\hbar}{y_2 - y_1}\right)(z_2 - y_2 + \ell_2\hbar)(y_1 - z_1 + \ell_1\hbar) \\ W_{(0,2)}^{\text{id}} &= (y_1 - z_1 + \ell_1\hbar)(y_2 - z_1 + \ell_1\hbar) \\ W_{(2,0)}^{(21)} &= (y_1 - z_2 + \ell_2\hbar)(y_2 - z_2 + \ell_2\hbar) \\ W_{(1,1)}^{(21)} &= \left(\frac{y_2 - y_1 - 2\hbar}{y_1 - y_2}\right)(z_1 - y_1 + \ell_1\hbar)(y_2 - z_2 + \ell_2\hbar) \\ &\quad + \left(\frac{y_1 - y_2 - 2\hbar}{y_2 - y_1}\right)(z_1 - y_2 + \ell_1\hbar)(y_1 - z_2 + \ell_2\hbar) \\ W_{(0,2)}^{(21)} &= (z_1 - y_1 + \ell_1\hbar)(z_1 - y_2 + \ell_1\hbar). \end{aligned}$$

- At the fixed point  $(2, 0)$ , the weights of  $V$  are

$$y_1 = z_1 - \ell_1\hbar, y_2 = z_1 - (\ell_1 - 2)\hbar.$$

- At the fixed point  $(1, 1)$ , the weights of  $V$  are

$$y_1 = z_1 - \ell_1\hbar, y_2 = z_2 - \ell_2\hbar.$$

- At the fixed point  $(0, 2)$ , the weights of  $V$  are

$$y_1 = z_2 - \ell_2\hbar, y_2 = z_2 - (\ell_2 - 2)\hbar.$$

Let  $z := z_1 - z_2$ .

The restrictions of the  $W_\lambda^{\text{id}}$  to the fixed points can be encoded into a matrix

$$[W_\lambda^{\text{id}}|_\mu] = \begin{bmatrix} (z - (\ell_1 + \ell_2)\hbar)(z - (\ell_1 + \ell_2 - 2)\hbar) & 0 & 0 \\ -(z - (\ell_1 + \ell_2)\hbar)2\ell_2\hbar & -(z - (\ell_1 - \ell_2 - 2)\hbar)(z - (\ell_1 + \ell_2)\hbar) & 0 \\ 2\ell_2(2\ell_2 - 2)\hbar^2 & 2(2\ell_2 - 2)\hbar(z - (\ell_1 - \ell_2)\hbar) & (z - (\ell_1 - \ell_2)\hbar)(z - (\ell_1 - \ell_2 + 2)\hbar) \end{bmatrix}$$

where the column is  $\lambda$  and the row  $\mu$ , with the ordering  $\{(2, 0), (1, 1), (0, 2)\}$ .

Similarly,

$$[W_\lambda^{(21)}]_\mu = \begin{bmatrix} (z-(\ell_1-\ell_2)\hbar)(z-(\ell_1-\ell_2-2)\hbar) & -2(2\ell_1-2)\hbar(z-(\ell_1-\ell_2)\hbar) & 2\ell_1(2\ell_1-2)\hbar^2 \\ 0 & -(z-(\ell_1-\ell_2+2)\hbar)(z+(\ell_1+\ell_2)\hbar) & 2\ell_1\hbar(z+(\ell_1+\ell_2)\hbar) \\ 0 & 0 & (z+(\ell_1+\ell_2)\hbar)(z+(\ell_1+\ell_2-2)\hbar) \end{bmatrix}$$

Therefore, we have

$$R(z) = [W_\lambda^{\text{id}}]_\mu^{-1} [W_\lambda^{(21)}]_\mu = \begin{bmatrix} \frac{(z-(\ell_1-\ell_2)\hbar)(z-(\ell_1-\ell_2-2)\hbar)}{(z-(\ell_1+\ell_2)\hbar)(z-(\ell_1+\ell_2-2)\hbar)} & -\frac{2(2\ell_1-2)\hbar(z-(\ell_1-\ell_2)\hbar)}{(z-(\ell_1+\ell_2)\hbar)(z-(\ell_1+\ell_2-2)\hbar)} & \frac{2\ell_1(2\ell_1-2)\hbar^2}{(z-(\ell_1+\ell_2)\hbar)(z-(\ell_1+\ell_2-2)\hbar)} \\ -\frac{2\ell_2\hbar(z-(\ell_1-\ell_2)\hbar)}{(z-(\ell_1+\ell_2)\hbar)(z-(\ell_1+\ell_2-2)\hbar)} & \frac{z^2-2z\hbar-(2\ell_1+\ell_1^2+2\ell_2-6\ell_1\ell_2+\ell_2^2)\hbar^2}{(z+(\ell_1+\ell_2)\hbar)(z+(\ell_1+\ell_2-2)\hbar)} & -\frac{2\ell_1\hbar(z+(\ell_1-\ell_2)\hbar)}{(z-(\ell_1+\ell_2)\hbar)(z-(\ell_1+\ell_2-2)\hbar)} \\ \frac{2\ell_2(2\ell_2-2)\hbar^2}{(z-(\ell_1+\ell_2)\hbar)(z-(\ell_1+\ell_2-2)\hbar)} & -\frac{2(2\ell_2-2)\hbar(z+(\ell_1-\ell_2)\hbar)}{(z-(\ell_1+\ell_2)\hbar)(z-(\ell_1+\ell_2-2)\hbar)} & \frac{(z+(\ell_1-\ell_2)\hbar)(z+(\ell_1-\ell_2+2)\hbar)}{(z-(\ell_1+\ell_2)\hbar)(z-(\ell_1+\ell_2-2)\hbar)} \end{bmatrix}$$

The poles of the entries of  $R(z)$  are at  $z = (\ell_1 + \ell_2)\hbar$  and  $z = (\ell_1 + \ell_2 - 2)\hbar$ . In the case when  $\ell_1 = \ell_2 = \ell = 2$ , and  $\epsilon = -2\ell\hbar, \phi = 2\hbar$ , this gives the spin 1  $R$ -matrix in [BJZ20, Page 17].

**6.3. The case when  $w = 2$  and any  $v \in \mathbb{N}$ .** In this section, let  $w = 2$  and consider any  $v \in \mathbb{N}$  and any  $(\ell_1, \ell_2) \in \mathbb{N}^2$ , such that  $\ell_1 \geq v$  and  $\ell_2 \geq v$ .

For each fixed point  $(v_1, v_2) \in S(\ell_1, \ell_2)$ . Consider all possible partitions  $(I_1, I_2)$  of the set  $[1, v]$ , such that  $|I_1| = v_1$  and  $|I_2| = v_2$ . Denote by  $I^c = [1, v] \setminus I$  the complement of the set  $I$  in  $[1, v]$ . We then have  $I_2 = I_1^c$ .

In this case, the formula (23) gives the following

$$W_{(v_1, v_2)}^{\text{id}} = \sum_{I \subset [1, v], |I| = v_1} \left( \prod_{i \in I, j \in I^c} \frac{y_j - y_i - 2\hbar}{y_i - y_j} \prod_{i \in I} (z_2 - y_i + \ell_2\hbar) \prod_{j \in I^c} (y_j - z_1 + \ell_1\hbar) \right).$$

For any fixed point  $(\mu_1, \mu_2) \in S(\ell_1, \ell_2)$ , by Lemma 5.1, the restriction  $W_{(v_1, v_2)}^{\text{id}}|_{(\mu_1, \mu_2)} = 0$  is zero if  $(v_1, v_2) < (\mu_1, \mu_2)$ . So we consider  $(\mu_1, \mu_2) \in S(\ell_1, \ell_2)$ , such that  $v_1 \geq \mu_1$  and  $v_2 \leq \mu_2$ .

Recall  $W_{(v_1, v_2)}^{\text{id}}$ , as an element in  $\mathbb{C}[\hbar][y_1, \dots, y_v]^{S_v} \otimes \mathbb{C}[z_1, z_2]$ , is symmetric in the  $y$  variables. When computing the restriction  $W_{(v_1, v_2)}^{\text{id}}|_{(\mu_1, \mu_2)}$ , the ordering the substitution of  $y_1, \dots, y_v$  according to (25) does not matter. For convenience, we set

$$y_1 = z_1 - \ell_1\hbar, y_2 = z_1 - (\ell_1 - 2)\hbar, \dots, y_{\mu_1} = z_1 - (\ell_1 - 2\mu_1 + 2)\hbar, \\ y_{\mu_1+1} = z_2 - \ell_2\hbar, y_{\mu_1+2} = z_2 - (\ell_2 - 2)\hbar, \dots, y_v = z_2 - (\ell_2 - 2\mu_2 + 2)\hbar.$$

Under such choice, the summand  $W_{(v_1, v_2), (I_1, I_2)}^{\text{id}}|_{(\mu_1, \mu_2)}$  is non-zero, we must have  $(I_1, I_2) = (I_1^{st}, I_2^{st})$ , where

$$I_2^{st} = \{\mu_1 + 1, \mu_1 + 2, \dots, \mu_1 + v_2\} = [\mu_1 + 1, \mu_1 + v_2], \\ I_1^{st} = \{1, 2, \dots, \mu_1, \mu_2 + v_2, \dots, v\} = [1, \mu_1] \sqcup [\mu_2 + v_2, v].$$

We now relabel the indices. For  $j \in I_2^{st}$ , we write the substitution as

$$y_j = z_2 - (\ell_2 - 2b)\hbar, \text{ with } j = \mu_1 + 1 + b, \quad 0 \leq b \leq v_2 - 1.$$

For  $i \in I_1^{st}$ , we write the substitution as

$$y_i = \begin{cases} z_1 - (\ell_1 - 2a)\hbar, \text{ with } i = 1 + a, & 0 \leq a \leq \mu_1 - 1, & \text{if } i \in [1, \mu_1], \\ z_2 - (\ell_2 - 2c)\hbar, \text{ with } i = \mu_1 + 1 + c, & v_2 \leq c \leq \mu_2 - 1, & \text{if } i \in [\mu_2 + v_2, v]. \end{cases}$$

We then have

$$\begin{aligned}
W_{(v_1, v_2)}^{\text{id}}|_{(\mu_1, \mu_2)} &= \prod_{i \in I_1^{\text{st}}, j \in I_2^{\text{st}}} \frac{y_j - y_i - 2\hbar}{y_i - y_j} \prod_{i \in I_1^{\text{st}}} (z_2 - y_i + \ell_2 \hbar) \prod_{j \in I_2^{\text{st}}} (y_j - z_1 + \ell_1 \hbar)|_{(\mu_1, \mu_2)} \\
&= \prod_{b=0}^{v_2-1} \prod_{a=0}^{\mu_1-1} (-1)^{\frac{z + (\ell_2 - \ell_1 + 2(a-b)\hbar)\hbar}{z + (\ell_2 - \ell_1 + 2(a-b)\hbar)}} \prod_{b=0}^{v_2-1} \prod_{c=v_2}^{\mu_2-1} (-1)^{\frac{c-b+1}{c-b}} \\
&\quad \times \prod_{a=0}^{\mu_1-1} (-z + (\ell_1 + \ell_2 - 2a)\hbar) \prod_{c=v_2}^{\mu_2-1} (2(\ell_2 - c)\hbar) \prod_{b=0}^{v_2-1} (-z - (\ell_2 - \ell_1 - 2b)\hbar) \\
&= (-1)^{\mu_1 v_2} \prod_{b=0}^{v_2-1} \frac{z + (\ell_2 - \ell_1 + 2(\mu_1 - b)\hbar)}{z + (\ell_2 - \ell_1 - 2b)\hbar} (-1)^{v_2(\mu_2 - v_2)} \frac{\mu_2!}{v_2!(\mu_2 - v_2)!} \\
&\quad \times (-1)^{\mu_1} \prod_{a=0}^{\mu_1-1} (z - (\ell_1 + \ell_2 - 2a)\hbar) \frac{(\ell_2 - v_2)!}{(\ell_2 - \mu_2)!} (2\hbar)^{\mu_2 - v_2} (-1)^{v_2} \prod_{b=0}^{v_2-1} (z + (\ell_2 - \ell_1 - 2b)\hbar) \\
&= (-1)^{v_1 v_2 + \mu_1 + v_2} \binom{\mu_2}{v_2} \frac{(\ell_2 - v_2)!}{(\ell_2 - \mu_2)!} (2\hbar)^{\mu_2 - v_2} \prod_{b=0}^{v_2-1} (z + (\ell_2 - \ell_1 + 2(\mu_1 - b)\hbar)) \prod_{a=0}^{\mu_1-1} (z - (\ell_1 + \ell_2 - 2a)\hbar)
\end{aligned}$$

where we set  $z = z_1 - z_2$ .

For any  $\sigma \in \mathcal{S}_2$ , denote by  $A^\sigma$  the matrix whose  $(i, j)$ -entry is  $(A^\sigma)_{ij} = W_{(v-j, j)}^{\sigma}|_{(v-i, i)}$ , for  $0 \leq i, j \leq v$ . The matrix  $A^{\text{id}}$  can be easily inverted (see [BZJ20, Appendix B] for the inverse matrix in the pure spin case):

$$(A^{\text{id}})_{ji}^{-1} = [i \leq j] (-1)^{(j+1)v+j} \binom{j}{i} \frac{(\ell_2 - i)!}{(\ell_2 - j)!} (2\hbar)^{j-i} \frac{z + (\ell_2 - \ell_1 + 2(v-2i)\hbar)}{\prod_{b=0}^j (z + (\ell_2 - \ell_1 + 2(v-i-b)\hbar)) \prod_{a=0}^{v-i-1} (z - (\ell_1 + \ell_2 - 2a)\hbar)},$$

where the notation  $[i \leq j]$  means [true] = 1, [false] = 0.

For  $(21) \in \mathcal{S}_2$ , the restriction  $W_{(v_1, v_2)}^{(21)}|_{(\mu_1, \mu_2)}$  can be obtained from  $W_{(v_1, v_2)}^{\text{id}}|_{(\mu_1, \mu_2)}$  by substituting  $z_1 \leftrightarrow z_2$ ,  $v_1 \leftrightarrow v_2$ ,  $\ell_1 \leftrightarrow \ell_2$ ,  $\mu_1 \leftrightarrow \mu_2$ , cf (27); therefore,

$$(A^{(21)})_{ij} = [i \leq j] (-1)^{j(v+1)} \binom{v-i}{v-j} \frac{(\ell_1 - v + j)!}{(\ell_1 - v + i)!} (2\hbar)^{j-i} \prod_{b=0}^{v-j-1} (z + (\ell_2 - \ell_1 - 2(i-b)\hbar)) \prod_{a=0}^{i-1} (z + (\ell_1 + \ell_2 - 2a)\hbar).$$

Finally, the  $R$ -matrix, which expresses the change of basis from the weight function at  $\sigma = \text{id}$  to the weight function at  $\sigma = (21)$ , is given by

$$\begin{aligned}
R_{jj'} &= \sum_{i=0}^v (A^{\text{id}})_{ji}^{-1} (A^{(21)})_{ij'} \\
&= (-1)^{v+(j-j')(v+1)} \sum_{i=0}^{\min(j, j')} \binom{j}{i} \binom{v-i}{v-j'} \frac{(\ell_2 - i)! (\ell_1 - v + j')!}{(\ell_2 - j)! (\ell_1 - v + i)!} (2\hbar)^{j'+j-2i} \\
&\quad \times \frac{(z + (\ell_2 - \ell_1 + 2(v-2i)\hbar)) \prod_{b=0}^{v-j'-1} (z + (\ell_2 - \ell_1 - 2(i-b)\hbar)) \prod_{a=0}^{i-1} (z + (\ell_1 + \ell_2 - 2a)\hbar)}{\prod_{b=0}^j (z + (\ell_2 - \ell_1 + 2(v-i-b)\hbar)) \prod_{a=0}^{v-i-1} (z - (\ell_1 + \ell_2 - 2a)\hbar)}
\end{aligned}$$

## 7. THE LATTICE MODEL

As in the rest of the paper, fix the data of two nonnegative integers  $w$  and  $v$ , of a  $w$ -tuple of positive integers  $(\ell_1, \dots, \ell_w)$ , and let  $(v_1, \dots, v_w)$  vary over the set  $S(\ell_1, \dots, \ell_w)$  (cf (7)).

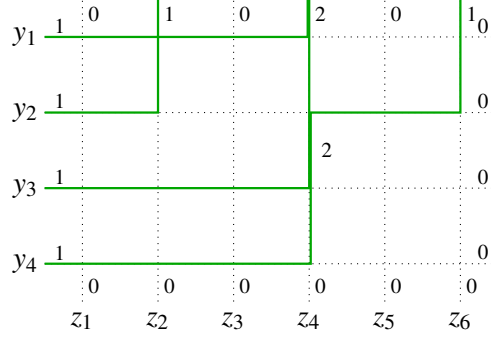

FIGURE 1. An example of state of a lattice model with  $v = 4$ ,  $w = 6$ , and  $(v_1, \dots, v_w) = (0, 1, 0, 2, 0, 1)$ .

Consider the following *lattice model*. Given a  $v \times w$  rectangular grid (i.e., a rectangular planar graph with external edges included), number its columns (resp. rows)  $1, \dots, w$  from left to right (resp.  $1, \dots, v$  from top to bottom). The space of states  $\mathcal{C}_{(v_1, \dots, v_w)}$  is the set of labellings of the edges of the grid, in such a way that

- (i) Labels of horizontal edges are in  $\{0, 1\}$ ;
- (ii) Labels of vertical edges in column  $j$  are in  $\{0, 1, \dots, \ell_j\}$ ;
- (iii) The labels on external edges are fixed: they are 0 on the South and East sides, 1 on the West side, and  $v_j$  on the North side in column  $j$ ;
- (iv) Around each vertex, the sum of labels of left and bottom adjacent edges is equal to the sum of labels of right and top adjacent edges.

See Figure 1 for an example. For pictorial purposes, we think of the labels as “occupations numbers” of each edge, the condition (iv) ensuring that they can be represented as continuous paths. In particular label 0 is drawn as an empty edge, and label 1 as a single path crossing the edge, and we shall often omit such labels when they can be inferred from the context.

We assign the variable  $y_i$  to the horizontal line  $i$  and  $z_j$  to the vertical line  $j$ , as on Figure 1. To each state  $c$  in  $\mathcal{C}_{(v_1, \dots, v_w)}$  we associate its “Boltzmann weight”  $F(c)$  of the form

$$F(c) = \prod_{i=1}^v \prod_{j=1}^w f^{(\ell_j)}(c(i, j), y_i - z_j) \in \mathbb{C}[\hbar, y_1, \dots, y_v, z_1, \dots, z_w]$$

where  $c(i, j)$  symbolically denotes the configuration of labels of the edges around vertex  $(i, j)$  in  $c$ , and the function  $f$  is given by

$$(28) \quad \begin{array}{cccc} \text{configuration } c & \begin{array}{c} \text{---} \\ | \\ \text{---} \\ | \\ \text{---} \end{array} & \begin{array}{c} \text{---} \\ | \\ \text{---} \\ | \\ \text{---} \end{array} & \begin{array}{c} \text{---} \\ | \\ \text{---} \\ | \\ \text{---} \end{array} & \begin{array}{c} \text{---} \\ | \\ \text{---} \\ | \\ \text{---} \end{array} \\ \text{around a vertex } (i, j) & \begin{array}{c} m \\ | \\ m \end{array} & \begin{array}{c} m \\ | \\ m \end{array} & \begin{array}{c} m-1 \\ | \\ m \end{array} & \begin{array}{c} m+1 \\ | \\ m \end{array} \\ f^{(l)}(c(i, j), u) & u - (l - 2m)\hbar & u + (l - 2m)\hbar & 2m\hbar & 2(l - m)\hbar \end{array}$$

Finally, we write

$$(29) \quad \tilde{W}_{(v_1, \dots, v_w)} = \sum_{c \in \mathcal{C}_{(v_1, \dots, v_w)}} F(c).$$

**Example 7.1.** For  $v = w = 2$ , and  $(v_1, v_2) = (1, 1)$  here are the two states of the lattice model and their Boltzmann weights:



$$4\ell_1\ell_2\hbar^2(y_1 - z_2 - (\ell_2 - 2)\hbar)(y_2 - z_1 + \ell_1\hbar) \quad 4\ell_1\ell_2\hbar^2(y_1 - z_1 + (\ell_1 - 2)\hbar)(y_2 - z_2 - \ell_2\hbar)$$

Summing them up leads to

$$\begin{aligned} \tilde{W}_{(1,1)} &= 4\ell_1\ell_2\hbar^2(2y_1y_2 - (z_1 + z_2 - \ell_1\hbar + \ell_2\hbar)y_1 - (z_1 + z_2 - \ell_1\hbar + \ell_2\hbar)y_2 \\ &\quad + 2(z_1z_2 + (\ell_2 - 1)\hbar z_1 - (\ell_1 - 1)\hbar z_2 - (\ell_1\ell_2 - \ell_1 - \ell_2)\hbar^2)) \\ &= 4\ell_1\ell_2\hbar^2\left(\frac{y_2 - y_1 - 2\hbar}{y_1 - y_2}\right)(z_2 - y_1 + \ell_2\hbar)(y_2 - z_1 + \ell_1\hbar) \\ &\quad + 4\ell_1\ell_2\hbar^2\left(\frac{y_1 - y_2 - 2\hbar}{y_2 - y_1}\right)(z_2 - y_2 + \ell_2\hbar)(y_1 - z_1 + \ell_1\hbar) \\ &= 4\ell_1\ell_2\hbar^2 W_{(1,1)}^{\text{id}}. \end{aligned}$$

**Theorem 7.2.** *One has*

$$\tilde{W}_{(v_1, \dots, v_w)} = \prod_{j=1}^w (-1)^{v_j(v+w-j-\sum_{s=1}^j v_s)} (2\hbar)^{v_j} \frac{\ell_j!}{(\ell_j - v_j)!} W_{(v_1, \dots, v_w)}^{\text{id}}.$$

*Proof.* Consider the vector space  $V = (K^2)^{\otimes v}$ , where  $K = \mathbb{C}(\hbar, y_1, \dots, y_v, z_1, \dots, z_w)$ , endowed with its standard basis  $\{|a_1, \dots, a_v\rangle \mid a_i \in \{0, 1\}, i = 1, \dots, v\}$  and dual basis  $\{\langle a_1, \dots, a_v \mid \mid a_i \in \{0, 1\}, i = 1, \dots, v\}$  of  $V^\vee$ . We interpret each column of a state of our lattice model as a linear operator acting on  $V$ , in such a way that concatenating columns corresponds to the natural linear operator product; explicitly, let  $T_{m,n}^{(l)}(x) \in \text{End}(V) = V^\vee \otimes V$  be the linear operator on  $V$  pictorially represented as

$$T_{m,n}^{(l)}(x) = \begin{array}{c} y_1 \text{ --- } | \text{ --- } m \\ \leq l \\ \vdots \\ \leq l \\ y_v \text{ --- } | \text{ --- } n \\ x \end{array}$$

that is, such that the coefficient  $\langle b_1, \dots, b_v \mid T_{m,n}^{(l)}(x) \mid a_1, \dots, a_v \rangle$  is zero if there are no configuration of labels of a  $v \times 1$  grid, where the external labels are fixed to be  $m, a_1, \dots, a_v, n, b_v, \dots, b_1$  clockwise, and the internal edges are in  $\{0, \dots, l\}$ , satisfying the conditions above, and the product  $\prod_{i=1}^v f^{(l)}(c(i), y_i - x)$  if there exists a (necessarily unique) configuration  $c$  that does. Here we omit the label of the column as the vertex only depends on  $i \in [1, v]$ .

We then have

$$(30) \quad \tilde{W}_{(v_1, \dots, v_w)} = \langle 1, \dots, 1 \mid T_{v_1, 0}^{(\ell_1)}(z_1) \dots T_{v_w, 0}^{(\ell_w)}(z_w) \mid 0, \dots, 0 \rangle.$$

**Lemma 7.3.** *There exists a basis  $\{|a_1, \dots, a_v\rangle \mid a_i \in \{0, 1\}, i = 1, \dots, v\}$  of  $V$  (with dual basis  $\{\langle a_1, \dots, a_v \mid \mid a_i \in \{0, 1\}, i = 1, \dots, v\}$ ) such that*

- (i)  $|0, \dots, 0\rangle = |0, \dots, 0\rangle$ .
- (ii)  $\langle 1, \dots, 1 \mid = \langle 1, \dots, 1 \mid$ .
- (iii) *For all  $0 \leq m \leq l$  and any  $x \in K$ , the matrix of  $T_{m,0}^{(l)}(x)$  is given by*

$$\begin{aligned} & \langle b_1, \dots, b_v \mid T_{m,0}^{(l)}(x) \mid a_1, \dots, a_v \rangle \\ &= \delta_{\sum_{i=1}^v (b_i - a_i), m} (2\hbar)^m \frac{l!}{(l-m)!} \prod_{\substack{i,j=1 \\ b_i=1, a_i=0 \\ b_j=a_j=0}}^v \frac{y_i - y_j - 2\hbar}{y_i - y_j} \prod_{i=1}^v \begin{cases} y_i - x - l\hbar & \text{for } b_i = a_i = 0 \\ y_i - x + l\hbar & \text{for } b_i = a_i = 1 \\ 1 & \text{for } b_i = 1, a_i = 0 \\ 0 & \text{for } b_i = 0, a_i = 1 \end{cases} \end{aligned}$$

The proof of this lemma requires more lattice model technology than the rest of this paper, and we defer it to Appendix A.

We now use Lemma 7.3 to prove Theorem 7.2. For each  $j = 1, \dots, w-1$ , write

$$\text{Id} = \sum_{\{(a_1^{(j)}, \dots, a_v^{(j)}) \in (0,1)^v\}} \left| a_1^{(j)}, \dots, a_v^{(j)} \right\rangle \left\langle a_1^{(j)}, \dots, a_v^{(j)} \right| \in \text{End}(V).$$

Then, by (30), we have

$$\begin{aligned} \tilde{W}_{(v_1, \dots, v_w)} &= \sum_{\left\{ \begin{array}{l} a_1^{(1)}, \dots, a_v^{(w-1)} \\ a_i^{(j)} \in \{0,1\}, \\ i \in [1,v], j \in [1, w-1] \end{array} \right\}} \langle 1, \dots, 1 \mid T_{v_1,0}^{(\ell_1)}(z_1) \mid a_1^{(1)}, \dots, a_v^{(1)} \rangle \langle a_1^{(1)}, \dots, a_v^{(1)} \mid T_{v_2,0}^{(\ell_2)}(z_2) \dots \\ & \quad \dots T_{v_{w-1},0}^{(\ell_{w-1})}(z_{w-1}) \mid a_1^{(w-1)}, \dots, a_v^{(w-1)} \rangle \langle a_1^{(w-1)}, \dots, a_v^{(w-1)} \mid T_{v_w,0}^{(\ell_w)}(z_w) \mid 0, \dots, 0 \rangle. \end{aligned}$$

Use the convention that  $a_i^{(0)} = 1$  and  $a_i^{(w)} = 0$  for all  $i = 1, \dots, v$ . According to Lemma 7.3, for fixed  $i \in [1, v]$ , the value of  $a_i^{(j)}$ ,  $j \in [0, w]$ , can only decrease, thus jumping from 1 to 0 at exactly one value of  $j$ . Furthermore, for fixed  $j$ , because of the factor  $\delta_{\sum_{i=1}^v (b_i - a_i), v_j}$ , exactly  $v_j$  jumps occur. One can therefore replace the summation over the intermediate basis elements with a summation over subsets  $I_j = \{i : a_i^{(j-1)} = 1, a_i^{(j)} = 0\}$ ,  $j = 1, \dots, w$ :

$$\begin{aligned} & \tilde{W}_{(v_1, \dots, v_w)} \\ &= \sum_{\substack{I_1, \dots, I_w \subseteq \{1, \dots, v\} \\ |I_j| = v_j \\ I_1, \dots, I_w \text{ disjoint}}} \prod_{j=1}^w (2\hbar)^{v_j} \frac{\ell_j!}{(\ell_j - v_j)!} \prod_{1 \leq k < j \leq w} (y_{I_k} - z_j - \ell_j \hbar) \frac{y_{I_k} - y_{I_j} + 2\hbar}{y_{I_k} - y_{I_j}} \prod_{w \geq k > j \geq 1} (y_{I_k} - z_j + \ell_j \hbar) \\ &= \left( \prod_{j=1}^w (2\hbar)^{v_j} \frac{\ell_j!}{(\ell_j - v_j)!} \right) \sum_{\substack{I_1, \dots, I_w \subseteq \{1, \dots, v\} \\ |I_j| = v_j \\ I_1, \dots, I_w \text{ disjoint}}} \prod_{1 \leq k < j \leq w} (-1)^{v_k + v_k v_j} (z_j - y_{I_k} + \ell_j \hbar) \frac{y_{I_j} - y_{I_k} - 2\hbar}{y_{I_k} - y_{I_j}} \prod_{w \geq k > j \geq 1} (y_{I_k} - z_j + \ell_j \hbar) \\ &= \left( \prod_{j=1}^w (-1)^{v_j(v+w-j-\sum_{s=1}^j v_s)} (2\hbar)^{v_j} \frac{\ell_j!}{(\ell_j - v_j)!} \right) W_{(v_1, \dots, v_w)}^{\text{id}}. \end{aligned}$$

□



## 8. RELATION TO THE STABLE ENVELOPE

Let  $p_\lambda \in S(\ell_1, \dots, \ell_w)$  be a torus fixed point. We have the embeddings

$$p_\lambda \xrightarrow{i_\lambda} \tilde{X}(v, \vec{1}_w)^{st} \xrightarrow{j} \tilde{X}(v, \vec{1}_w),$$

where  $i_\lambda$  is a closed embedding and  $j$  is an open embedding. Pushforward along  $i_\lambda$  and pullback along  $j$  gives the following commutative diagram.

$$\begin{array}{ccccc} H_{T_w \times \mathbb{C}^*}^*(p_\lambda) & \xrightarrow{i_{\lambda*}} & H_{c, T_w \times G_v \times \mathbb{C}^*}^*(\tilde{X}(v, \vec{1}_w)^{st}, \varphi_{\mathbf{w}})^\vee & \xleftarrow{j^*} & H_{c, T_w \times G_v \times \mathbb{C}^*}^*(\tilde{X}(v, \vec{1}_w), \varphi_{\mathbf{w}})^\vee \\ \parallel & & \downarrow s_* & & \downarrow s_* \\ H_{T_w \times \mathbb{C}^*}^*(p_\lambda) & \xrightarrow{i_{\lambda*}} & H_{c, T_w \times G_v \times \mathbb{C}^*}^*(\tilde{X}(v, \vec{1}_w)^{st}, \mathbb{C})^\vee & \xleftarrow{j^*} & H_{c, T_w \times G_v \times \mathbb{C}^*}^*(\tilde{X}(v, \vec{1}_w), \mathbb{C})^\vee \end{array}$$

By the dimension reduction in Proposition 2.1, we have the isomorphism

$$H_{c, \mathbb{C}^* \times T_w}^*(\tilde{X}(v, \vec{1}_w)^{st}/G_v, \varphi_{\mathbf{w}})^\vee \cong H_{c, \mathbb{C}^* \times T_w}^*(\mu_{v,w}^{-1}(0)^{st} \times_{G_v} \mathbb{C}^{wv}, \mathbb{C})^\vee \cong H_{c, \mathbb{C}^* \times T_w}^{*-wv}(\mathfrak{M}^+(v, \vec{1}_w), \mathbb{C})^\vee.$$

The vertical maps  $s_*$  are pullforward along the closed embeddings  $s : \mu_{v,w}^{-1}(0)^{st} \times_{G_v} \mathbb{C}^{wv} \hookrightarrow \tilde{X}(v, \vec{1}_w)^{st}$  and  $\mu_{v,w}^{-1}(0) \times_{G_v} \mathbb{C}^{wv} \hookrightarrow \tilde{X}(v, \vec{1}_w)$ .

By (12), we have the following tangent complexes (see [CZ23, Section 3.1] in detail for the derived structure of the critical loci and the derived tangent complexes)

$$[T(\mathfrak{M}^+(v, \vec{1}_w))] = [-\text{End}(\mathcal{V}) + (\mathcal{V}^\vee \otimes \mathcal{V} \otimes \mathbb{C}_\epsilon^\vee + \sum_i \mathcal{W}_i^\vee \otimes \mathcal{V} \otimes \mathbb{C}_{a_i}^\vee) - \sum_i \mathcal{W}_i^\vee \otimes V \otimes \mathbb{C}_{\epsilon^i a_i}^\vee],$$

$$\begin{aligned} [T((\mu_{v,w}^{-1}(0)^{st} \times_{G_v} \mathbb{C}^{wv})/G_v)] &= [-\text{End}(\mathcal{V}) + (\mathcal{V}^\vee \otimes \mathcal{V} \otimes \mathbb{C}_\epsilon^\vee + \sum_i \mathcal{W}_i^\vee \otimes \mathcal{V} \otimes \mathbb{C}_{a_i}^\vee + \sum_i \mathcal{V}^\vee \otimes \mathcal{W}_i \otimes \mathbb{C}_{a_i}^\vee) \\ &\quad - \sum_i \mathcal{W}_i^\vee \otimes V \otimes \mathbb{C}_{\epsilon^i a_i}^\vee], \end{aligned}$$

$$[T\tilde{X}(v, \vec{1}_w)] = [-\text{End}(\mathcal{V}) + (\mathcal{V}^\vee \otimes \mathcal{V} \otimes \mathbb{C}_\epsilon^\vee + \sum_i \mathcal{W}_i^\vee \otimes \mathcal{V} \otimes \mathbb{C}_{a_i}^\vee + \sum_i \mathcal{V}^\vee \otimes \mathcal{W}_i \otimes \mathbb{C}_{a_i}^\vee)].$$

Therefore,  $s^* s_*$  is given by the multiplication of the Euler class of the bundle  $\sum_i \mathcal{W}_i^\vee \otimes V \otimes \mathbb{C}_{\epsilon^i a_i}^\vee$ :

$$(31) \quad s^* s_* = \prod_{i=1}^w \prod_{j=1}^v (-z_i + y_j - \ell_i \hbar) = (-1)^{vw} \prod_{i=1}^w \prod_{j=1}^v (z_i - y_j + \ell_i \hbar).$$

It is also the same as the Euler class of the bundle  $\text{Hom}(\mathcal{W}, \mathcal{V})$  coming from the arrows  $a_i, i \in [1, w]$ , up to the sign  $(-1)^{vw}$ .

Similar as the discussion in [RTV15, §2.5], for the torus  $T_w$ , let  $\mathfrak{t}_w := \text{Lie}(T_w)$  be the Lie algebra of  $T_w$ . We then have the real vector space embedding

$$(\mathfrak{t}_w)_\mathbb{R} = \text{Cochar}(T_w) \otimes_{\mathbb{Z}} \mathbb{R} \subset \mathfrak{t}_w.$$

Let  $z_1, \dots, z_w$  be the standard basis of the dual space  $\mathfrak{t}_w^\vee$ . We have the root hyperplanes  $z_i - z_j = 0$  of  $(\mathfrak{t}_w)_\mathbb{R}$ , for any  $1 \leq i \neq j \leq w$ . This gives the open chambers  $\mathfrak{C}_\sigma = \{x \in (\mathfrak{t}_w)_\mathbb{R} \mid z_{\sigma(1)}(x) > \dots > z_{\sigma(w)}(x)\}$ , such that

$$(\mathfrak{t}_w)_\mathbb{R} \setminus \bigcup_{1 \leq i \neq j \leq w} \{z_i - z_j = 0\} = \bigsqcup_{\sigma \in S_w} \mathfrak{C}_\sigma.$$

As conjectured in [BZJ20], the stable envelope  $\{S_\lambda^\sigma \mid \lambda \in S(\ell_1, \dots, \ell_w)\}$ , where  $\sigma \in \mathcal{S}_w$  is the labeling of the chamber  $\mathfrak{C}_\sigma$ , should be unique classes in  $H_{c, T_w \times G_v \times \mathbb{C}^*}^*(\tilde{X}(v, \vec{1}_w)^{st}, \mathbb{C})^\vee \cong H_{c, \mathbb{C}^* \times T_w}^{*-wv}(\mathfrak{M}^+(v, \vec{1}_w), \mathbb{C})^\vee$  satisfying the characterisation in [BZJ20, Conjecture 2].

The weight functions  $\{W_\lambda^\sigma \mid \lambda \in S(\ell_1, \dots, \ell_w)\}$  are elements in  $H_{c, T_w \times G_v \times \mathbb{C}^*}^*(\tilde{X}(v, \vec{1}_w), \mathbb{C})^\vee$ . Pushforward along  $s$  of the stable envelope, we should get

$$s_*(S_\lambda^\sigma) = j^*(W_\lambda^\sigma).$$

Formally, by (31), we have

$$(-1)^{vw} \prod_{i=1}^w \prod_{j=1}^v (z_i - y_j + \ell_i \hbar) (S_\lambda^\sigma) = s^* s_*(S_\lambda^\sigma) = s^* j^*(W_\lambda^\sigma).$$

Therefore, by inverting the Euler class  $\prod_i \prod_j (z_i - y_j + \ell_i \hbar)$ , we have the equality

$$(32) \quad S_\lambda^\sigma = \frac{s^* j^*(W_\lambda^\sigma)}{(-1)^{vw} \prod_{i=1}^w \prod_{j=1}^v (z_i - y_j + \ell_i \hbar)}$$

in the localised ring  $H_{c, T_w \times G_v \times \mathbb{C}^*}^*(\tilde{X}(v, \vec{1}_w)^{st}, \mathbb{C})^\vee \otimes_{H_{T_w \times G_v \times \mathbb{C}^*}(\text{pt})} H_{T_w \times G_v \times \mathbb{C}^*}(\text{pt})[\prod_{i=1}^w \prod_{j=1}^v \frac{1}{z_i - y_j + \ell_i \hbar}]$ . We remark that the formula (32) is not enough for the support condition in [BZJ20, Conjecture 2]. We will investigate this in the future [CYZJ].

#### APPENDIX A. PROOF OF LEMMA 7.3

In this appendix we use more of the diagrammatic calculus that was introduced in §7. In what follows, when we draw a diagram, we view it as a linear operator where the source is the tensor product of vector spaces associated to the incoming lines (with out conventions, lines coming from the right; or from the top for vertical lines) and the target is associated to the outgoing lines (going to the left; or going down for vertical lines). In particular, the labels of internal edges are implicitly summed over, corresponding to natural operator product. Labelling the external edges corresponds to picking a particular entry of those linear operators. Pictorially, the following two diagrams mean some linear operator from  $V_1 \otimes V_2$  to  $V_3 \otimes V_4$ .



**A.1. The six-vertex  $R$ -matrix.** Let  $K$  be the base field. Given  $u \in K$ , define the six-vertex  $R$ -matrix  $\check{R}(u)$  to be the following linear operator on  $(K^2)^{\otimes 2}$ . Denote the matrix entries by  $\langle b_1 b_2 | \check{R}(u) | a_1 a_2 \rangle$ , where

$b_1, b_2, a_1, a_2 \in \{0, 1\}$ . The following 6 entries of  $\check{R}(u)$  are best described diagrammatically as

$$\begin{array}{ccc}
 \begin{array}{c} \diagup \diagdown \\ \diagdown \diagup \end{array} & \begin{array}{c} \cdots \diagup \cdots \diagdown \\ \cdots \diagdown \cdots \diagup \end{array} & \begin{array}{c} \diagdown \cdots \diagup \\ \diagup \cdots \diagdown \end{array} \\
 \langle 11 | \check{R}(u) | 11 \rangle = 1 & \langle 00 | \check{R}(u) | 00 \rangle = 1 & \langle 10 | \check{R}(u) | 01 \rangle = \beta(u) \\
 \begin{array}{c} \cdots \diagdown \cdots \diagup \\ \cdots \diagup \cdots \diagdown \end{array} & \begin{array}{c} \diagdown \diagup \\ \cdots \diagup \cdots \diagdown \end{array} & \begin{array}{c} \cdots \diagup \cdots \diagdown \\ \diagup \diagdown \end{array} \\
 \langle 01 | \check{R}(u) | 10 \rangle = \beta(u) & \langle 10 | \check{R}(u) | 10 \rangle = \gamma(u) & \langle 01 | \check{R}(u) | 01 \rangle = \gamma(u)
 \end{array}
 \tag{33}$$

where

$$\begin{aligned}
 \beta(u) &= \frac{u}{u - 2\hbar}, \\
 \gamma(u) &= \frac{2\hbar}{u - 2\hbar}.
 \end{aligned}$$

All other entries of  $\check{R}(u)$  are zero.

When we want to talk about the linear operator itself without specifying a particular matrix entry, we'll write

$$\check{R}(u_1 - u_2) = \begin{array}{c} u_1 \diagdown \\ \diagup u_2 \end{array}$$

where a black line means a line whose label is unspecified. Furthermore, the parameter  $u$  is always chosen to be the difference of two parameters each attached to each of the two lines crossing.

The  $R$ -matrix satisfies several key identities. Firstly, the Yang–Baxter equation is an identity in  $\text{End}((K^2)^{\otimes 3})$  that holds for all  $u_1, u_2, u_3 \in K$ :

$$\begin{array}{ccc}
 \begin{array}{c} u_1 \diagdown \\ u_2 \diagup \\ u_3 \diagdown \end{array} & & \begin{array}{c} u_1 \diagdown \\ u_2 \diagup \\ u_3 \diagdown \end{array} \\
 \text{(34)} & = & \text{(34)}
 \end{array}$$

Secondly, the unitarity equation holds as an identity in  $\text{End}((K^2)^{\otimes 2})$ :

$$\begin{array}{ccc}
 \begin{array}{c} u_1 \diagdown \\ u_2 \diagup \end{array} & = & \begin{array}{c} u_1 \text{---} \\ u_2 \text{---} \end{array} \\
 \text{(35)} & & \text{(35)}
 \end{array}$$

where the right hand side is nothing but the identity operator.

The last relation involves both the six-vertex  $R$ -matrix introduced above, and the so-called  $L$ -matrix implicitly defined in §7 as an operator from  $K^{l+1} \otimes K^2$  to  $K^2 \otimes K^{l+1}$ :

$$\check{L}^{(k)}(u_1 - u_2) = u_1 \begin{array}{c} | \\ \hline | \\ u_2 \end{array}$$

where the nonzero entries of the operator are given by (28). These weights depend on the extra parameter  $l$ , which is the upper bound on the labels of the thick line; this parameter will not be mentioned on the picture for the sake of simplicity.

The  $RLL$  relation, which is another form of the Yang–Baxter equation, then states that

$$(36) \quad \begin{array}{c} u_1 \\ \diagdown \quad \diagup \\ \diagup \quad \diagdown \\ u_2 \end{array} \begin{array}{c} | \\ \hline | \\ u_3 \end{array} = \begin{array}{c} u_1 \\ | \\ \diagdown \quad \diagup \\ \diagup \quad \diagdown \\ u_2 \end{array} \begin{array}{c} | \\ \hline | \\ u_3 \end{array}$$

All these identities can be checked by direct computation, and we leave it to the interested reader.

Finally, given a permutation  $\sigma \in \mathcal{S}_v$ , pick any wiring diagram of it and consider it as a product of  $R$ -matrices; e.g., if  $\sigma = (231)$ ,

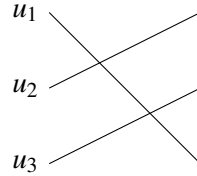

Thanks to equations (34)–(35), the resulting element of  $\text{End}((K^2)^{\otimes v})$  is independent of the choice of wiring diagram (reduced or not). We denote it symbolically by

$$\check{R}_\sigma(u_1, \dots, u_v) = \begin{array}{c} u_1 \\ \vdots \\ u_v \end{array} \begin{array}{|c|} \hline \sigma \\ \hline \end{array} \begin{array}{c} u_{\sigma(1)} \\ \vdots \\ u_{\sigma(v)} \end{array}$$

In the example above,  $\check{R}_{(231)}(u_1, u_2, u_3) := \check{R}_{(12)}(u_1 - u_2)\check{R}_{(23)}(u_1 - u_3) \in \text{End}((K^2)^{\otimes 3})$ .

We comment here that the summation over all the labels in the interior of a wiring diagram is equivalent to a summation over *subwords* of the corresponding word of  $\sigma$ . We shall not need to spell out this statement more explicitly, except for the following important consequence: consider binary strings  $(a_1, \dots, a_v)$  and  $(b_1, \dots, b_v)$ , and the smallest permutation (in Bruhat order)  $\rho$  in  $\mathcal{S}_v$  such that  $a_i = b_{\rho(i)}$  (which is easily shown to exist). Then  $\langle b_1, \dots, b_v | \check{R}_\sigma | a_1, \dots, a_v \rangle$  is zero unless  $\sigma$  is greater or equal to  $\rho$  in Bruhat order. We shall use this property repeatedly in what follows.

As a simple consequence of the formalism above, we have the following result:

**Lemma A.1.** *The function  $\tilde{W}_{(v_1, \dots, v_w)}$  defined in (29) is a symmetric polynomial in  $y_1, \dots, y_v$ .*

*Proof.* With our updated graphical conventions, one can rewrite (29) explicitly as

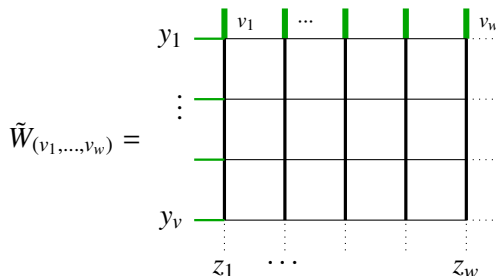

where once again the dependence on  $\ell_1, \dots, \ell_w$  is suppressed on the picture.

Now pick  $i \in \{1, \dots, v-1\}$  and consider the following diagram

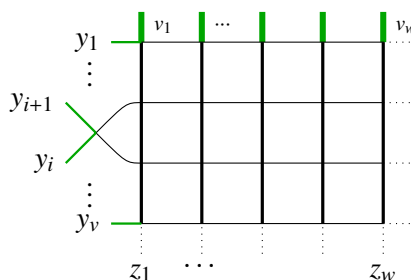

which differs from the preceding one by the addition of an extra  $R$ -matrix to the left between rows  $i$  and  $i+1$ . According to (33), the only possible labels on the right side of this  $R$ -matrix (i.e., that produce a nonzero weight) are 1s, and the corresponding weight is 1. Therefore this diagram is also equal to  $\tilde{W}_{(v_1, \dots, v_w)}$ .

On the other hand, apply repeatedly the RLL relation (36) to it: one obtains

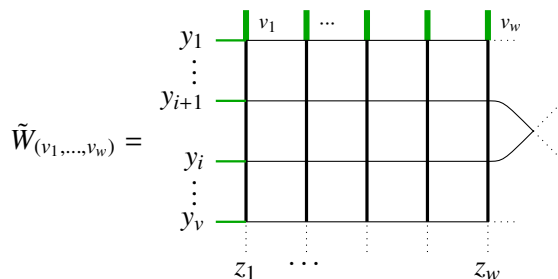

By the same argument, the only possible labels on the left side of the  $R$ -matrix are 0s, with corresponding weight 1. We then recognize the same diagram that we started with, but with  $y_i$  and  $y_{i+1}$  switched.  $\square$

**A.2. Definition of the  $F$ -basis.** We define the tilded basis of Lemma 7.3, usually known as  $F$ -basis.<sup>1</sup>

In this section we abbreviate binary strings  $(a_1, \dots, a_v)$ ,  $a_i \in \{0, 1\}$ , with the notation  $a$ . Given such an  $a = (a_1, \dots, a_v)$  with say  $v'$  0s and  $v''$  1s, where  $v' + v'' = v$ , we define

$$\begin{aligned} \text{sort}(a) &= (\underbrace{0, \dots, 0}_{v'}, \underbrace{1, \dots, 1}_{v''}) \\ \text{rsort}(a) &= (\underbrace{1, \dots, 1}_{v''}, \underbrace{0, \dots, 0}_{v'}) \end{aligned}$$

<sup>1</sup>Note that the  $F$ -basis has the simple geometric meaning of fixed point basis, so that the computation of §A.3 is a thinly disguised equivariant localisation calculation, similar in spirit to those of §3 and §4.

Now consider any permutation  $\sigma \in \mathcal{S}_v$  such that  $\text{sort}(a)_{\sigma(i)} = a_i$  for all  $i$ , and then define

$$\widetilde{|a\rangle} = \check{R}_\sigma(y_1, \dots, y_v) |\text{sort}(a)\rangle =$$

This definition is independent of the choice of representative  $\sigma$  in the left coset space  $\mathcal{S}_v / (\mathcal{S}_{v'} \times \mathcal{S}_{v''})$  because varying  $\sigma$  within the coset would amount to inserting/removing extra crossings on the right of the picture between two lines with equal occupancy, and the first two weights of (33) are 1.

In particular, note that if  $a = \text{sort}(a)$ ,  $\widetilde{|a\rangle} = |a\rangle$ , proving part (i) of Lemma 7.3.

Similarly, consider any permutation  $\tau$  such that  $a_{\tau(i)} = \text{rsort}(a)_i$  for all  $i$ , and then define

$$\widetilde{\langle a|} = \kappa_a^{-1} \langle \text{rsort}(a) | \check{R}_\tau(y_{\bar{\tau}(1)}, \dots, y_{\bar{\tau}(v)}) = \kappa_a^{-1}$$

where  $\bar{\tau} = \tau^{-1}$ , and  $\kappa_a \in K$  is a constant that we choose of the form

$$\kappa_a = \prod_{i,j: a_i=1, a_j=0} \beta(y_i - y_j)$$

for reasons that will become clear right below (Lemma A.2). Once again, this definition is independent of the choice of representative  $\tau$  in the right coset space  $(\mathcal{S}_{v''} \times \mathcal{S}_{v'}) \backslash \mathcal{S}_v$ .

As a warm-up for the main calculation of this appendix, let us show the following

**Lemma A.2.** *Given binary strings  $a = (a_1, \dots, a_v)$  and  $b = (b_1, \dots, b_v)$ , one has the duality statement*

$$\widetilde{\langle b |} \widetilde{|a\rangle} = \delta_{b,a}.$$

In what follows we use the following well-known fact about double cosets in  $(\mathcal{S}_{\bar{v}''} \times \mathcal{S}_{\bar{v}'}) \backslash \mathcal{S}_v / (\mathcal{S}_{v'} \times \mathcal{S}_{v''})$ : they possess a unique minimal element which is a *bigrassmannian* permutation, namely a permutation  $\sigma$  such that the descent set  $\{i \in [1, v-1] \mid \sigma(i) > \sigma(i+1)\}$  of  $\sigma$  (resp.  $\sigma^{-1}$ ) is contained in  $\{v'\}$  (resp.  $\{\bar{v}''\}$ ), and such bigrassmannian permutations are in bijection with cosets.

*Proof.* Because  $R$ -matrices preserve the occupation number, we may assume without loss of generality that  $a$  and  $b$  have the same number of 0s and 1s, otherwise the l.h.s. of the equality is trivially zero. Choosing  $\sigma$

so that  $\text{sort}(a)_{\sigma(i)} = a_i$  and  $\tau$  such that  $b_{\tau(i)} = \text{rsort}(b)_i$ , one has

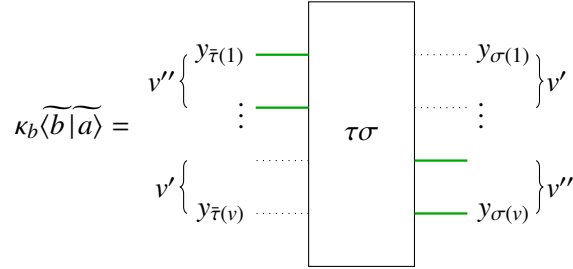

For this to be nonzero,  $\tau\sigma$  has to be greater or equal in Bruhat order to the bigrassmannian permutation  $\rho$  of the form  $\rho(i) = i + v'$  for  $1 \leq i \leq v'$ ,  $\rho(i) = i - v'$  for  $v' + 1 \leq i \leq v$ . But this is the greatest bigrassmannian permutation among all  $(\mathcal{S}_{v''} \times \mathcal{S}_{v'}) \backslash \mathcal{S}_v / (\mathcal{S}_{v'} \times \mathcal{S}_{v''})$  double coset representatives, so as a double coset,  $\tau\sigma = \rho$ . This immediately implies

$$a_i = \text{sort}(a)_{\sigma(i)} = \text{sort}(a)_{\tau(\rho(i))} = \text{rsort}(a)_{\tau(i)} = \text{rsort}(b)_{\tau(i)} = b_i$$

where we have used the fact that  $a$  and  $b$  have same content. Finally, we compute

$$\kappa_a \langle \widetilde{b} | \widetilde{a} \rangle = \prod_{i,j: a_i=1, a_j=0} \beta(y_i - y_j).$$

□

In particular, note that if  $a = \text{rsort}(a)$ ,  $\langle \widetilde{a} | a \rangle = \kappa_a^{-1} \langle a | a \rangle$ , proving part (ii) of Lemma 7.3.

**A.3. Matrix entries of  $T_{m,0}^{(l)}(x)$ .** We now come to part (iii) of Lemma 7.3. The setup is similar to that of the proof of Lemma A.2, except now the contents of  $a$  and  $b$  must differ:

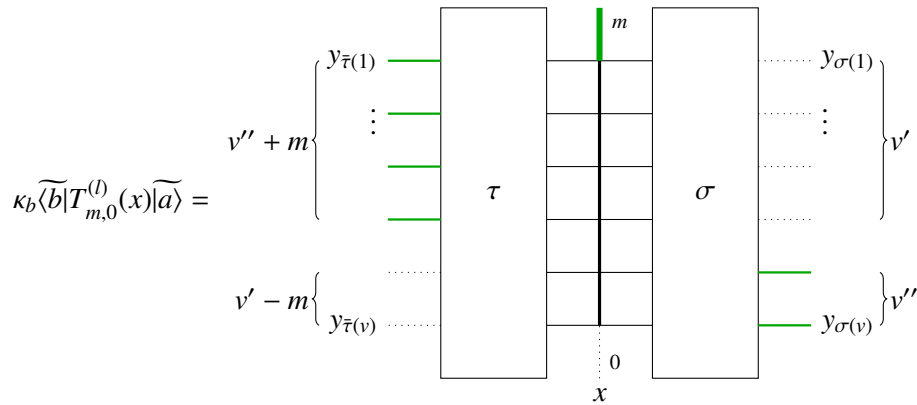

where  $a$  has  $v'$  0s and  $v''$  1s, whereas  $b$  has  $v' - m$  0s and  $v'' + m$  1s. We recall that the dependence on  $l$  lies in the fact that labels on the thick line are in  $\{0, \dots, l\}$ , and in the weights (28).

By repeated application of the RLL relation (36), we can move the vertical line to the right:

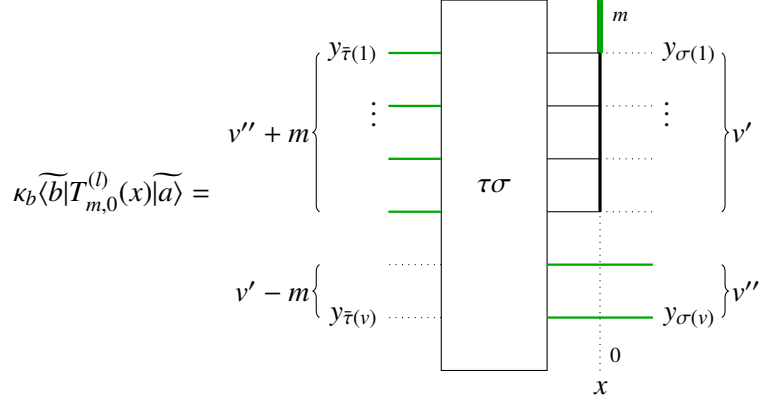

We have indicated on the bottom right of the picture that some labels are “forced” by the defining condition (iv) for a lattice model state.

Once again, by direct inspection, the only bigrassmannian permutation  $\pi$  that is large enough in Bruhat order for the r.h.s. to be nonzero is given by  $\pi(i) = i$  for  $1 \leq i \leq m$ ,  $\pi(i) = i + v''$  for  $m + 1 \leq i \leq v'$ , and  $\pi(i) = i - v' + m$  for  $v' + 1 \leq i \leq v$ . Therefore, as a double coset,  $\tau\sigma = \pi$ . Now compare

$$\begin{aligned} a_i &= \text{sort}(a)_{\sigma(i)} \\ &= \underbrace{(0, \dots, 0)}_{v'} \underbrace{(1, \dots, 1)}_{v''} \bar{\tau}(\pi(i)) \\ &= \underbrace{(0, \dots, 0)}_m \underbrace{(1, \dots, 1)}_{v''} \underbrace{(0, \dots, 0)}_{v'-m} \bar{\tau}(i) \end{aligned}$$

with

$$b_i = \underbrace{(1, \dots, 1)}_{v'+m} \underbrace{(0, \dots, 0)}_{v'-m} \bar{\tau}(i).$$

We see that  $a_i = b_i$  except if  $i \in I = \tau(\{1, \dots, m\})$ , in which case  $a_i = 0$ ,  $b_i = 1$ . In particular,  $b_i \geq a_i$ , which is consistent with part (iii) of Lemma 7.3.



We now compute

$$\begin{aligned}
 \kappa_b \langle \widetilde{b} | T_{m,0}^{(l)}(x) | \widetilde{a} \rangle &= \begin{array}{c} \begin{array}{c} m \\ \vdots \\ 1 \\ 0 \end{array} \\ \left. \begin{array}{c} y_{\bar{\tau}(1)} \\ \vdots \\ y_{\sigma(1)} \end{array} \right\} v' \\ \left. \begin{array}{c} v'' \\ \vdots \\ v' - m \end{array} \right\} v'' \\ \begin{array}{c} y_{\bar{\tau}(v)} \\ \vdots \\ y_{\sigma(v)} \end{array} \\ \left. \begin{array}{c} \vdots \\ 1 \\ 0 \end{array} \right\} v'' \\ x \end{array} \\
 &= (2\hbar)^m \frac{l!}{(l-m)!} \prod_{i: b_i=a_i=0} (y_i - x - l\hbar) \prod_{i: b_i=a_i=1} (y_i - x + l\hbar) \prod_{\substack{i: a_i=1 \\ j: b_j=0}} \beta(y_i - y_j),
 \end{aligned}$$

where the last equality follows from the weights in (28) and (33).

Finally we take care of the product of  $\beta$ s:

$$\kappa_b^{-1} \prod_{\substack{i: a_i=1 \\ j: b_j=0}} \beta(y_i - y_j) = \frac{\prod_{\substack{i: a_i=1 \\ j: b_j=0}} \beta(y_i - y_j)}{\prod_{\substack{i: b_i=1 \\ j: b_j=0}} \beta(y_i - y_j)} = \frac{1}{\prod_{\substack{i: b_i=1, a_i=0 \\ j: b_j=a_j=0}} \beta(y_i - y_j)}$$

where we have used the fact that  $b_i \geq a_i$  for all  $i$ .

#### A.4. The R-matrix.

**Remark A.3.** In view of Theorem 7.2, the definition of the R-matrix (4) for an elementary transposition  $\sigma = (j, j+1)$  can be traced back to the following pictorial identity:

$$\begin{array}{c} \begin{array}{c} v_1 \\ \vdots \\ v_j \\ v_{j+1} \\ \vdots \\ v_w \end{array} \\ \begin{array}{c} y_1 \\ \vdots \\ y_v \end{array} \\ \begin{array}{c} z_1 \\ \vdots \\ z_j \\ z_{j+1} \\ \vdots \\ z_w \end{array} \end{array} = \begin{array}{c} \begin{array}{c} v_1 \\ \vdots \\ v_j \\ v_{j+1} \\ \vdots \\ v_w \end{array} \\ \begin{array}{c} y_1 \\ \vdots \\ y_v \end{array} \\ \begin{array}{c} z_1 \\ \vdots \\ z_{j+1} \\ z_j \\ \vdots \\ z_w \end{array} \end{array} \otimes \begin{array}{c} \times \\ = PDR(z_j/z_{j+1})D^{-1} \end{array}$$

where  $D$  is a diagonal matrix that cares of the prefactors occurring in Theorem 7.2, defined by  $D |v_j, v_{j+1}\rangle = (-1)^{v_j+v_{j+1}+v_j v_{j+1}} (2\hbar)^{v_j+v_{j+1}} \binom{\ell_j!}{(\ell_j-v_j)!} \binom{\ell_{j+1}!}{(\ell_{j+1}-v_{j+1})!} |v_j, v_{j+1}\rangle$ , and  $P |v_j, v_{j+1}\rangle = |v_{j+1}, v_j\rangle$  is some conventional re-ordering of the tensor product. We note that this equation is automatically satisfied on condition that yet

another version of the Yang–Baxter equation holds, namely

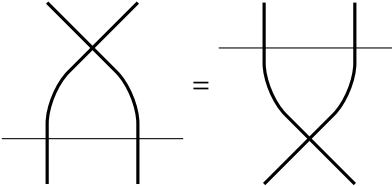
(37) 

and the fact that  $\langle 0, 0 | R(z) = \langle 0, 0 |$  (which typically follows from conservation of occupation numbers and normalisation). Equation (37) is indeed known to be satisfied.

#### REFERENCES

- [AO17] M. Aganagic and A. Okounkov, *Quasimap counts and Bethe eigenfunctions*, Mosc. Math. J. **17** (2017), no. 4, 565–600, [arXiv:1704.08746](#), [doi:10.17323/1609-4514-2017-17-4-565-600](#). [1.4](#)
- [B23] T. Botta, *Framed cohomological Hall algebras and cohomological stable envelopes*. Lett. Math. Phys. **113**(2023), no.5, Paper No. 95, 45 pp. [arXiv:2207.06280](#) [4](#)
- [BZJ20] D. Bykov, P. Zinn-Justin, *Higher spin  $\mathfrak{sl}_2$  R-matrix from equivariant (co)homology*. Lett. Math. Phys. **110** (2020), no.9, 2435–2470. [arXiv:1904.11107](#) ([document](#)), [5](#), [6.2.2](#), [6.3](#), [8](#), [8](#)
- [CP94] V. Chari, A. Pressley, *A Guide to Quantum Groups*. Cambridge University Press, Cambridge (1994). [1.1](#), [3.2](#), [3.2](#)
- [CYZJ] E. Carlsson, Y. Yang, P. Zinn-Justin, work in progress. [8](#)
- [CZ23] Y. Cao, G. Zhao, *Quasimaps to quivers with potentials*, [arXiv:2306.01302](#). [8](#)
- [D17] B. Davison, *The critical COHA of a quiver with potential*, (2015). The Quarterly Journal of Mathematics, Volume 68, Issue 2, 1 June 2017, Pages 635-703. Arxiv1311.7172 [1.1](#), [2.1](#), [2.1](#)
- [H07] D. Hernandez, *Drinfeld coproduct, quantum fusion tensor category and applications*, Proc. Lond. Math. Soc. (3) **95** (2007), no. 3, 567-608. [1.1](#), [3.2](#)
- [I86] B. Iversen, *Cohomology of sheaves*. Universitext Springer-Verlag, Berlin, 1986. [2.1](#)
- [KS11] M. Kontsevich, Y. Soibelman, *Cohomological Hall algebra, exponential Hodge structures and motivic Donaldson-Thomas invariants*, Commun. Number Theory Phys. **5** (2011), no. 2, 231-352. [1.1](#), [2.1](#)
- [MO19] D. Maulik, A. Okounkov, *Quantum Groups and Quantum Cohomology*, Astérisque 2019. [4](#)
- [RSYZ18] M. Rapcak, Y. Soibelman, Y. Yang, Z. Zhao, *Cohomological Hall algebras, vertex algebras and instantons*. Commun. Math. Phys. **376**, pages1803–1873 (2020). [arXiv:1810.10402](#). [4](#), [3.1.3](#), [3.1.4](#)
- [RSYZ20] M. Rapcak, Y. Soibelman, Y. Yang, Z. Zhao, *Cohomological Hall algebras and perverse coherent sheaves on toric Calabi-Yau 3-folds*, preprint, (2020). [arXiv:2007.13365](#). [4](#), [1.1](#), [1.1](#), [3.1](#), [3.1.3](#), [3.1.3](#)
- [RTV15] R. Rimányi, Richárd; V. Tarasov, A. Varchenko, *Partial flag varieties, stable envelopes, and weight functions*. Quantum Topol. **6**(2015), no.2, 333-364. [arXiv:1212.6240](#) ([document](#)), [4](#), [5.3.2](#), [8](#)
- [VV23] M. Varagnolo, E. Vasserot, *Non symmetric quantum loop groups and critical convolution algebras*, preprint, (2023) [arXiv:2308.01809](#). [3](#), [1.1](#)
- [WZP16] M. Wheeler, P. Zinn-Justin, *Refined Cauchy/Littlewood identities and six-vertex model partition functions: III. Deformed bosons*, Adv. Math. **299** (2016) 543–600. [arXiv:1508.02236](#).
- [YZ14] Y. Yang and G. Zhao, *The cohomological Hall algebra of a preprojective algebra*, Proc. Lond. Math. Soc. **116** (2018), 1029-1074. [arXiv:1407.7994](#) [1.2](#), [3.1.4](#), [4.2](#), [4.1](#), [4.2](#)
- [YZ16] Y. Yang and G. Zhao, *Cohomological Hall algebras and affine quantum groups*, Selecta Mathematica, Vol. 24, Issue 2 (2018), pp. 1093-1119. [arXiv:1604.01865](#) [3.2](#)
- [YZ17] Y. Yang, G. Zhao, *How to sheaffy an elliptic quantum group*. 2017 MATRIX Annals, Volume 2, Springer. [arXiv:1803.06627](#) [4](#)
- [YZ22] Y. Yang, G. Zhao, *The cohomological Hall algebras of a preprojective algebra with symmetrizer*, Algebras and Representation Theory, to appear, DOI 10.1007/s10468-022-10125-6. [arXiv:1911.02689](#) [3](#)

THE UNIVERSITY OF MELBOURNE, SCHOOL OF MATHEMATICS AND STATISTICS, 813 SWANSTON STREET, PARKVILLE VIC 3010, AUSTRALIA  
Email address: [yaping.yang1@unimelb.edu.au](mailto:yaping.yang1@unimelb.edu.au)

THE UNIVERSITY OF MELBOURNE, SCHOOL OF MATHEMATICS AND STATISTICS, 813 SWANSTON STREET, PARKVILLE VIC 3010, AUSTRALIA  
Email address: [pzinn@unimelb.edu.au](mailto:pzinn@unimelb.edu.au)