

Efficient Data Access Paths for Mixed Vector-Relational Search

Viktor Sanca
viktor.sanca@epfl.ch
EPFL
Switzerland

Anastasia Ailamaki
anastasia.ailamaki@epfl.ch
EPFL
Switzerland

Abstract

The rapid growth of machine learning capabilities and the adoption of data processing methods using vector embeddings sparked a great interest in creating systems for vector data management. While the predominant approach of vector data management is to use specialized index structures for fast search over the entirety of the vector embeddings, once combined with other (meta)data, the search queries can also become selective on relational attributes - typical for analytical queries. As using vector indexes differs from traditional relational data access, we revisit and analyze alternative access paths for efficient mixed vector-relational search.

We first evaluate the accurate but exhaustive scan-based search and propose hardware optimizations and alternative tensor-based formulation and batching to offset the cost. We outline the complex access-path design space, primarily driven by relational selectivity, and the decisions to consider when selecting an exhaustive scan-based search against an approximate index-based approach. Since the vector index primarily avoids expensive computation across the entire dataset, contrary to the common relational knowledge, it is better to scan at lower selectivity and probe at higher, with a cross-point between the two approaches dictated by data dimensionality and the number of concurrent search queries.

CCS Concepts

• **Information systems** → **Data access methods**; **Data scans**; **Point lookups**; *Database query processing*; Parallel and distributed DBMSs; *Main memory engines*; *Online analytical processing engines*; Data analytics; *Retrieval models and ranking*; **Search engine architectures and scalability**.

Keywords

Access Methods, Vector Databases, Index Structures, Query Optimization, Vector-Relational Databases

ACM Reference Format:

Viktor Sanca and Anastasia Ailamaki. 2024. Efficient Data Access Paths for Mixed Vector-Relational Search. In *Proceedings of Make sure to enter the correct conference title from your rights confirmation email (Conference acronym 'XX)*. ACM, New York, NY, USA, 7 pages. <https://doi.org/XXXXXX.XXXXXXX>

Permission to make digital or hard copies of all or part of this work for personal or classroom use is granted without fee provided that copies are not made or distributed for profit or commercial advantage and that copies bear this notice and the full citation on the first page. Copyrights for components of this work owned by others than the author(s) must be honored. Abstracting with credit is permitted. To copy otherwise, or republish, to post on servers or to redistribute to lists, requires prior specific permission and/or a fee. Request permissions from permissions@acm.org.

Conference acronym 'XX, June 03–05, 2018, Woodstock, NY

© 2024 Copyright held by the owner/author(s). Publication rights licensed to ACM.

ACM ISBN 978-1-4503-XXXX-X/18/06

<https://doi.org/XXXXXX.XXXXXXX>

1 Introduction

The widespread surge in the popularity and use of LLMs and embedding-driven ML models resulted in an urgent need for systems that support storing and processing vector embeddings. Use-cases such as Retrieval-Augmented Generation [12], search [9], and caching [19, 25] are currently observed and optimized mostly as *vector-only* processing. Still, the topic of vector index structures representing a fundamental building block of vector management isn't new, being thoroughly studied over the years [10, 14, 17, 23, 24].

Efficient data access and processing is fundamental to decades of research and industrial data management systems efforts. This has resulted in studies of data layouts, index structures, and using various storage and processing hardware for optimizing and selecting data access methods [11]. However, research and industrial efforts typically target operations and the processing of relational data, resulting in benchmarks such as TPC-H, TPC-DS [22], and Star Schema Benchmark [16]. On the other hand, with the proliferation of use, building efficient vector search systems and components becomes an imperative, resulting in corresponding test suites and evaluations such as ANN-Benchmark [3, 4].

As model-driven vector capabilities become commonplace and start interacting with (relational) analytical systems driven by novel use-cases [18, 21], the mix of both relational and vector data access characteristics will bring a richer design space to consider. Applying both relational filters and vector similarity search is relevant when not all the embeddings should be considered, for example, searching for embeddings in a particular date range or having certain characteristics, such as in document tagging [7] or misinformation detection [15]. In a simpler case, the user might want to search for images similar to a given one but only taken in a certain location in a given date range, both of which we consider relational data.

We consider the mixed vector-relational data use case and study the data access path characteristics and trade-offs for the in-memory scale-up case and:

- outline the parameters impacting the access path selection for relational, vector, and the mixed selective data access in Section 2,
- describe the landscape of scan-based, exhaustive search strategies and introduce a novel batch-based tensor search and propose hardware optimizations in Section 3, and describe relational filtering approaches for vector indexes in Section 4.
- evaluate the different access strategies in Section 5, and demonstrate the parameters affecting the selection of the most efficient strategy, showing that the access path selection needs to be adaptive based on the workload and particular execution parameters such as selectivity.

Using a particular access path can yield orders of magnitude difference, reinforcing the need to adapt the strategy based on the runtime needs rather than having a single static method.

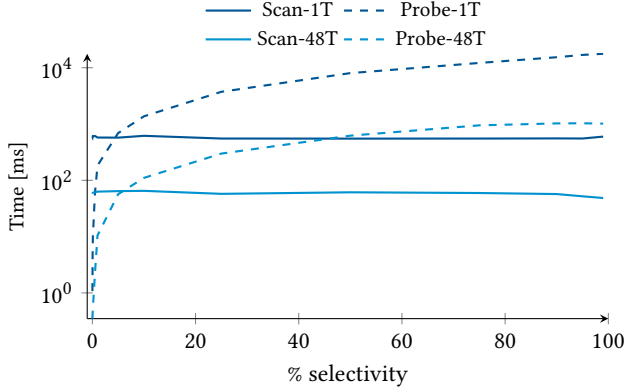

Figure 1: Scan vs Probe in relational context (SUM query), in-memory, using 1 and 48 threads.

2 Background

Selecting a subset of qualifying records to process is a fundamental data processing operation. Still, there are several differences between the relational and vector search contexts.

2.1 Traditional relational search

Relational search most commonly filters out results based on a predicate which is often a numerical expression, and yields an exact result set of data records that satisfy the condition.

Subject to the nature of the predicate, this typically results in a point search or a range search with varying selectivity. Depending on the sortedness of the data, the presence of auxiliary data structures such as indexes (and their nature, e.g. primary/secondary, hash/tree), and the estimated cost based on selectivity, the query optimizer makes a decision that reduces the access cost. An index on the search key enables finding the qualifying data but comes at a random access cost and should be used when the selectivity is low. We demonstrate this in a simple in-memory SCAN-FILTER-SUM query (Figure 1), where a sequential scan with a lightweight filtering predicate processed at memory bandwidth has a better per-tuple throughput. The more cores are allocated, the more per-core memory bandwidth is available (up to the maximum and based on configuration), speeding up the sequential access. Conversely, more cores can issue concurrent requests and probe an index structure. An optimizer should select the access path based primarily on the estimated selectivity of the query.

2.2 Vector-based search

Vector search aims to retrieve other vectors that satisfy the provided distance function or expression in a given range or by retrieving top-k results. This entails comparing high-dimensional vectors, which is computationally intensive and requires accessing and moving high-dimensional tuples across the memory hierarchy.

To minimize the cost of an exhaustive but accurate search, vector indexes aim to organize and transform the vector data in a way that reduces the search across all the embeddings, based on the construction-time parameters such as the desired distance function [10, 14, 17, 23, 24]. This way, a more efficient approximate similarity search can take place, especially considering the size of

the search space [10]. This search aims to reduce data access and mitigate the significant impact of expensive comparisons between high-dimensional vectors.

Takeaway While both types of indexes aim to reduce data access and retrieve relevant data records, the per-tuple predicate evaluation is computationally more expensive for vector data.

3 Scan: Exhaustive Mixed Search

We consider a column-store layout that stores both vector and relational data. We start from describing and analyzing scan-based brute-force approach and formalize the selection operator over vector data in the table (relation) R using vector v as the search parameter (query) and ϵ as distance function:

$$\sigma_{\epsilon,v}(R) = \{t \in R, \epsilon(t, v)\}$$

(Selection with query vector v and similarity predicate ϵ)

In a pure vector search, the scan-based approach is equivalent to the cross-product of the search query v and the vector column of table R .

$$\sigma_{\epsilon,v}(R) \Leftrightarrow \sigma_{\epsilon}(v \times R) \quad (\text{Brute force selection.})$$

In the case of a mixed vector-relational search with a relational predicate θ_R , the predicate can be pushed down to the relational columns of table R , reducing the number of candidate vectors to compare with.

$$\sigma_{\epsilon,v,\theta_R}(R) \Leftrightarrow \sigma_{\epsilon,\theta_R}(v \times R) \Leftrightarrow \sigma_{\epsilon}(v \times \sigma_{\theta_R}(R))$$

(Brute force similarity search with relational predicate θ .)

3.1 Optimization Strategies

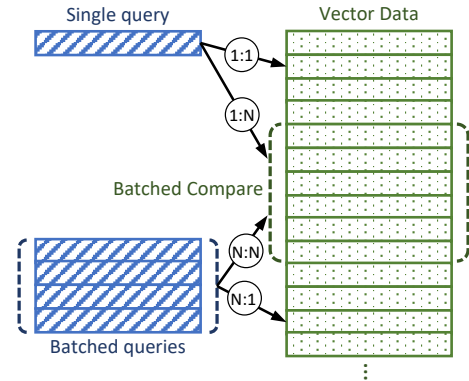

Figure 2: Scan-based vector selection strategies: 1 : 1 single query-single data, 1 : N single query-batched data, N : N batched query-batched data, N : 1 batched query-single data.

We observe four possible strategies for scan-based processing (Figure 2). 1 : 1 compares a single query vector with a single data vector at a time, where hardware-based optimizations such as using vectorized (SIMD) instructions can speed up the processing of individual vectors. An alternative to individual comparisons is batching the vectors to prioritize cache-local computation and avoid the

overhead of excessive data movement ($1 : N, N : 1, N : N$). Finally, applying the general concept of batching several queries where they can benefit from shared data access and computation [8], we propose batching both the data and query vectors v .

This is an especially applicable case if there are many concurrent or temporally-close requests. In this case, there are opportunities to use more efficient algorithms, which we propose as a batched **Tensor formulation**, based on BLAS linear algebra algorithms [5]. By blurring the boundary between individual vectors, the tensor-based computation is more cache-efficient, keeping the data in the caches the longest with efficient vector processing procedures. For example, if the distance function ϵ is cosine distance, it can be represented as a dot product of two normalized input matrices.

3.2 Relational Predicate Pushdown

We consider two strategies for the relational predicate pushdown. One happens on the fly, appropriate for the $1 : 1$ and $N : 1$ approach, where the relational filter is checked, and if the condition is satisfied, the vector comparison takes place.

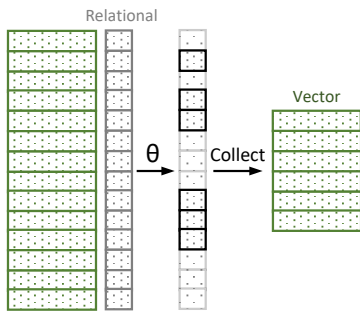

Figure 3: Scan-based vector selection based on a relational predicate-first strategy.

For the batched approach, we propose a late materialization-based [2] strategy by first staging the fast relational predicate filtering, then collecting the vectors that satisfy the condition, which are then processed in a batch using the **Tensor approach** (Figure 3).

Takeaway Scan-based exhaustive approaches offer sequential data access and optimization opportunities that can benefit further from optimizing the data access to the memory hierarchy, such as batching. This approach excels in relational filtering, typically filtering values at memory scan speed, and is expected to bring benefits with highly selective predicates and when the search accuracy (recall) is prioritized.

4 Index: Probe-Based (Approximate) Search

Index-based search relies on constructing data structures and organizing data such that similar data are clustered together. One such approach is Hierarchical Navigable Small World (HNSW) [14], which is an algorithm based on the idea of *small-world networks* where most nodes can be reached from any other by a small number of steps, despite the large initial network. This results in a multi-layered graph-based structure, where each layer is a (probabilistic)

subset of the layer below, where the bottom layer contains all the data points. The probabilistic search procedure provides an **approximate** nearest neighbor search capability, tunable to the recall and speed properties.

4.1 Relational Filtering

Current vector indexes typically reorganize the underlying data and don't natively support relational filtering [24]. Still, there are existing approaches to achieve this. One approach is to perform the vector search and then apply the relational filter in a **post-filtering** step. This might invalidate all the results where qualifying tuples aren't immediately the most similar to the query vector. Another approach is **pre-filtering**, where the tuples are first checked for the relational condition. To preserve the properties of the data structure and the connectivity of HNSW, the tuples are not discarded for search but simply not included in the result set, influencing the probing of the index.

Takeaway Indexes represent a probe-based approach, facing the penalty of random accesses and less-suitable relational filtering. They are more expensive than relational indexes, currently taking milliseconds per vector query for in-memory execution [3]. They are expected to excel when most of the data is considered for the search, with a crossing point where the scan-based approach computation matches the index-based approach's random access (and the computation).

5 Evaluation

We start by evaluating the optimization of the exhaustive scan-based approach and comparing them against different batch sizes and data dimensionalities, concluding on the best strategy given the parameters. Then, we focus on selective data access with a scan-based approach. Finally, we compare the index to the scan-based approach, providing an answer to the question "*Should I Scan or Should I Probe?*" [11] in mixed vector-relational setting with a selectivity-driven analysis.

System To conduct the in-depth study, we compare all the approaches in a standalone system in C++ and use Intel AVX instructions for SIMD execution. Tensor formulation benchmarks use Intel oneAPI Math Kernel Library for CPU-aware and efficient BLAS-based linear algebra operations. If otherwise not noted, the experiments run on 48 all threads (physical+hyperthreads).

Vector Index We use `hnswlib` [13, 14] as a vector index, which comes with pre-filtering support, and do not account for index construction cost in our experiments, assuming a correct index already exists. We build an index with parameters $M = 64$, $ef_construction = 512$, and the inner product as the distance function. We use $k = 64$ for top-k retrieval.

Hardware Setup We run the end-to-end and scalability experiments on a two-socket Intel Xeon Gold 5118 CPU (2 x 12-core, 48 threads) and 384GB of RAM.

Dataset All experiments are with in-memory data; experiments with synthetic data use the same random number generator seed for reproducibility. The vector data of various dimensionalities and relational data are generated uniformly at random. If otherwise

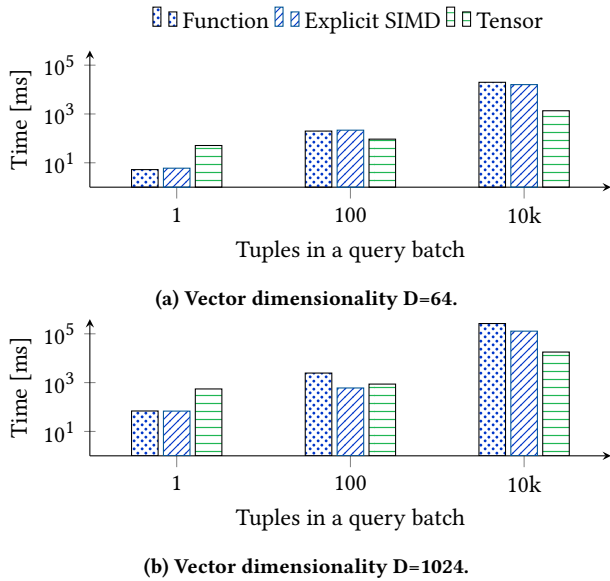

Figure 4: Different scan strategies for 1M tuples and dimensionalities.

not noted, we use 1M data points as the dataset and repeat the experiments 5 times with warm caches. We use cosine similarity > 0.9 as a vector distance metric.

5.1 Which scan-based approach to select?

We first compare three strategies, running the per-tuple search with explicit hardware vectorization (Explicit SIMD), inlined function call (Function), and the Tensor formulation (Tensor). For this, we vary the vector dimensionality and the batch size (Figure 4).

First, we notice the benefit of explicit vectorization with increased vector dimensionality (Figure 4b) and in bigger batches where computation dominates. Not using the hardware capabilities is detrimental when computation dominates but less apparent otherwise. With fewer computations, particularly in small batches and low dimensionality, the tensor-based approach overhead is significant compared to the per-tuple approaches (Figure 4a). However, pushing this boundary beyond per-tuple-vector but to a whole tuple-vector-batch (Tensor), when sufficient computation can benefit from the cache locality, significantly improves the execution time in the high-dimension, large batch case.

This is more apparent in the per-dimension breakdown (Figure 5) For per-vector search queries, it is best to optimize fully the individual probe, as there is only a performance penalty for setting up the BLAS procedure call (Figure 5a). The more sharing opportunities via batching exist, the more the initial Tensor overhead pays off in larger batches (Figure 5b, Figure 5c), resulting in almost an order of magnitude difference in execution time between the Tensor and Explicit SIMD approach in the case of batch size 10k.

Takeaway A hardware-optimized, non-batched search is more efficient for individual vector queries. For larger query batches, the tensor-based approach enables faster computation over many queries due to a more efficient, cache-conscious BLAS algorithm.

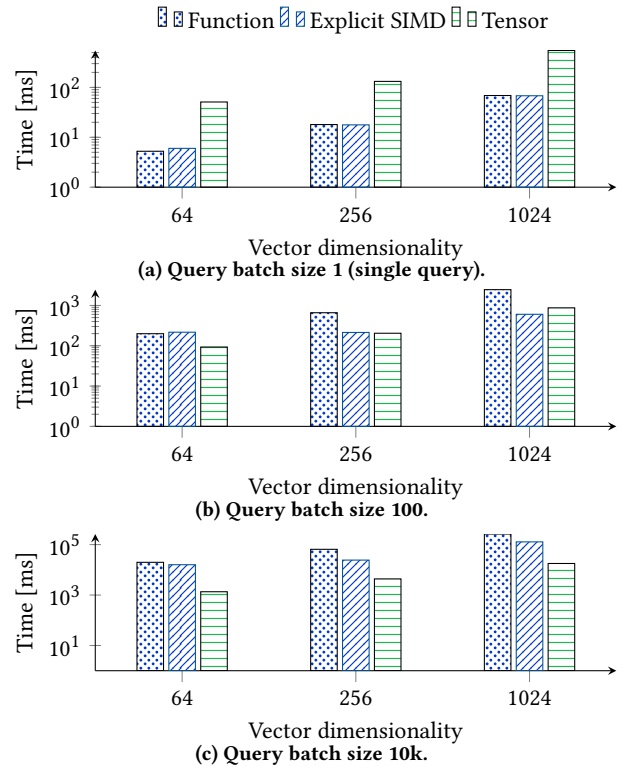

Figure 5: Scan strategies, 1M tuples, varying query batch size.

5.2 Selective exhaustive search

We now address whether relational selectivity impacts the previous findings on batching and selecting the scan-based approach. To answer this, we show the time breakdown of various steps of Tensor approach, as also outlined in Figure 3. First, the relational filtering happens, then the vector data is (re-)materialized into dense vectors, then normalized (for cosine similarity computation), and then the dot product is computed.

Figure 6 shows the breakdown of execution time across three dimensions: vector dimensionality (Figure 6a, Figure 6b), batch size (1, 100, 10k), and selectivity (10%, 90%). We normalize the times to 100% to calculate the fraction of the particular execution strategy. This validates the claim that where the computation dominates (large batch sizes), the Tensor-based approach is beneficial as it optimizes this phase. As a full filtering and data movement/copy step has to happen before (albeit linear in input size), it dominates the overall cost in both dimensionalities (but less so when $D = 1024$). As relational filtering dominates, the more practical method is Explicit SIMD (Figure 5). A mini-batch strategy similar to *vectorized*¹ data processing [6] or sparse-vector computation could help the performance and overlap the filtering and computation steps, which remains a future research topic.

Takeaway Having two optimized scan-based strategies: individual hardware optimized for low batch sizes and a tensor-based strategy for large batches (or vector joins [21]) enables an optimizer (or a user) to select a more efficient workload-based method.

¹vectorization is becoming a severely overloaded term

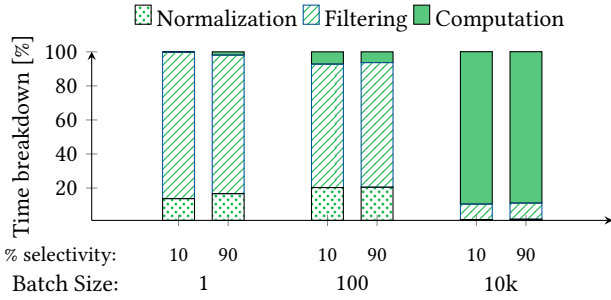

(a) Vector dimensionality D=64.

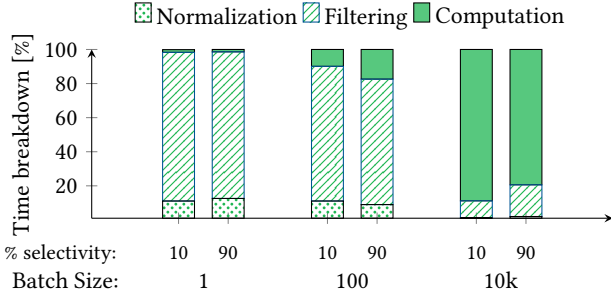

(b) Vector dimensionality D=1024.

Figure 6: Tensor strategy time breakdown, varying the selectivity, dimensionality, and batch size.

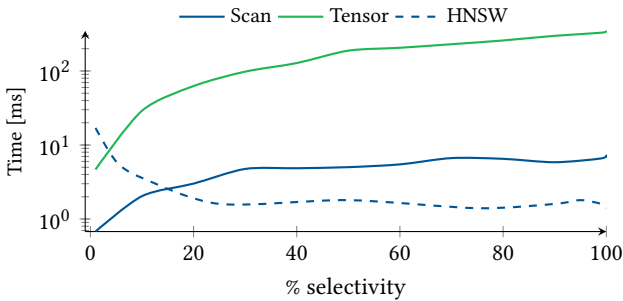

(a) Scan vs Probe D=64

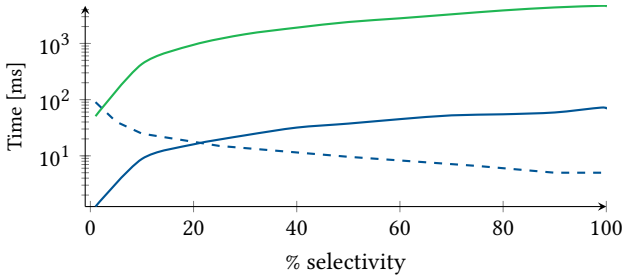

(b) Scan vs Probe D=1024

Figure 7: Different search strategies, query batch size is 1.

5.3 Selective queries: should I scan or probe?

Finally, we shed light on which access path to select: a scan-based one or an index-based one (probe). We extend the HNSW approach with filtering capabilities on relational columns by using a provided

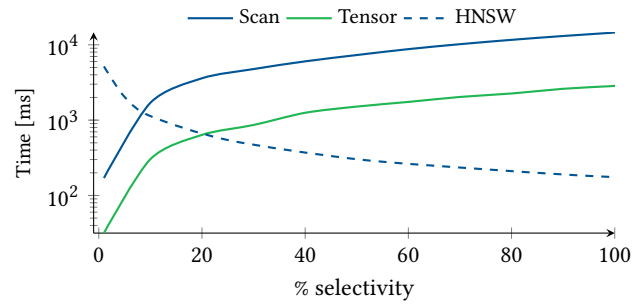

(a) Scan vs Probe D=64

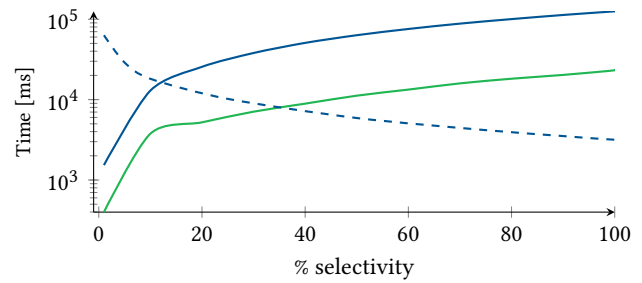

(b) Scan vs Probe D=1024

Figure 8: Different search strategies, query batch size is 10k.

filtering function interface and probing the relational column using the unique vector ID. This imposes random access (per number of filters and qualifying elements) in addition to the vector index traversal. We use a filter on a single column in all of our experiments, controlling the relational selectivity.

At a lower selectivity, the index-based approach with pre-filtering will have to navigate more as the vectors might not satisfy the relational predicate, leading to more random accesses and vector comparisons (Figure 7). As more values are selected, the approximate nearest neighbor algorithm can find sufficient tuples that satisfy the condition without excess comparisons.

While both scan-based strategies intersect with the index-based approach (Figure 7a, Figure 7b), selecting an optimal strategy to improve the search performance is crucial. Results in Figure 8 further reinforce the previous finding that the Tensor-based strategy is better for larger batch sizes, in both cases significantly improving the execution time until the intersection point with the parallel index-based approach, and resulting in an order of magnitude speedup if the most efficient of the methods is selected.

Takeaway Selecting between scan-based and index-based access paths depends primarily on selectivity, dimensionality, and the batching strategy. It is worth noting that vector indexes can also be constructed with various parameters affecting the intersection point between the scan and the probe. Contrary to relational indexes, vector indexes perform better when more tuples satisfy the selection condition.

5.4 Looking Forward and Lessons Learned

Selecting efficient access methods for mixed vector-relational search enriches the design space to improve end-to-end efficiency. It brings

vector data management closer to traditional query optimization, especially if a vector index is not the main (vector) database structure [18]. Use cases not purely a search, such as joins [21] that still rely on vector indexes can also provide workload-driven access path selection for more efficient execution, similar to prior art in purely relational operators.

	Scan	Index
Accuracy	Exact	Approximate
Cost	Compute & Scan	Build & Compute & Probe
Flexibility	Any Expression	Construction-Time Distance
Benefit	Selective Predicate	Full Search

Table 1: Index versus scan-based vector search.

We outline key differences between scan and index-based approaches in Table 1. Indexes are efficient but, at the same time, limited to the parameters given at construction time. If the query has different requirements, it is imperative to have an efficient fall-back option to an efficient exhaustive scan. This might include queries over different vector distance functions than with which the index structure was constructed or range instead of top-k search for which an index might not be suitable (or the most efficient access path).

From the modern hardware perspective, technologies such as High-Bandwidth Memory (HBM) or CPU-side accelerators for vector data processing such as the Intel Advanced-Matrix Extensions (AMX) [1, 20], have the potential to change the computational and data access tradeoffs. Naturally, the GPU-side tensor processing units or using dedicated Tensor Processing Units (TPUs) further expands the domain of using accelerators or heterogeneous hardware, emphasizing the need for designing efficient and adaptive vector data management systems that efficiently use the underlying hardware

6 Conclusion

Vector data management driven predominantly by index structures with support for efficient approximate nearest neighbor search faces a challenge once a single well-optimized workload assumption changes, especially when interacting with relational operators. For relational systems with support for vector indexes, selecting the most efficient data access path remains crucial for performance and efficiency. In this work, we presented and evaluated scan-based methods against an index-based search, and outlined the optimization space and parameters affecting the performance of data access paths for mixed vector-relational search, showing the trade-off between different methods and guidelines for selecting the most efficient and performant approach.

References

[1] [n.d.]. Intel® Advanced Matrix Extensions (Intel® AMX) Overview. <https://www.intel.com/content/www/us/en/products/docs/accelerator-engines/advanced-matrix-extensions/overview.html>. Accessed: 2024-03-15.

[2] Daniel J Abadi, Daniel S Myers, David J DeWitt, and Samuel R Madden. 2006. Materialization strategies in a column-oriented DBMS. In *2007 IEEE 23rd International Conference on Data Engineering*. IEEE, 466–475.

[3] Martin Aumüller, Erik Bernhardsson, and Alec Faithfull. 2024. ANN-Benchmarks: A Benchmarking Tool for Approximate Nearest Neighbor Algorithms. <https://ann-benchmarks.com/>. Accessed: 2024-03-15.

[4] Martin Aumüller, Erik Bernhardsson, and Alexander John Faithfull. 2020. ANN-Benchmarks: A benchmarking tool for approximate nearest neighbor algorithms. *Inf. Syst.* 87 (2020). <https://doi.org/10.1016/j.is.2019.02.006>

[5] L Susan Blackford, Antoine Pettit, Roldan Pozo, Karin Remington, R Clint Whaley, James Demmel, Jack Dongarra, Iain Duff, Sven Hammarling, Greg Henry, et al. 2002. An updated set of basic linear algebra subprograms (BLAS). *ACM Trans. Math. Software* 28, 2 (2002), 135–151.

[6] Peter A. Boncz, Marcin Zukowski, and Niels Nes. 2005. MonetDB/X100: Hyper-Pipelining Query Execution. In *Second Biennial Conference on Innovative Data Systems Research, CIDR 2005, Asilomar, CA, USA, January 4-7, 2005, Online Proceedings*. www.cidrdb.org, 225–237. <http://cidrdb.org/cidr2005/papers/P19.pdf>

[7] Sheng Chen, Akshay Soni, Aasish Pappu, and Yashar Mehdad. 2017. Doc-Tag2Vec: An Embedding Based Multi-label Learning Approach for Document Tagging. In *Proceedings of the 2nd Workshop on Representation Learning for NLP, Rep4NLP@ACL 2017, Vancouver, Canada, August 3, 2017*, Phil Blunsom, Antoine Bordes, Kyunghyun Cho, Shay B. Cohen, Chris Dyer, Edward Grefenstette, Karl Moritz Hermann, Laura Rimell, Jason Weston, and Scott Yih (Eds.). Association for Computational Linguistics, 111–120. <https://doi.org/10.18653/V1/W17-2614>

[8] Georgios Giannikis, Gustavo Alonso, and Donald Kossmann. 2012. SharedDB: Killing One Thousand Queries With One Stone. *Proc. VLDB Endow.* 5, 6 (2012), 526–537. <https://doi.org/10.14778/2168651.2168654>

[9] Jui-Ting Huang, Ashish Sharma, Shuying Sun, Li Xia, David Zhang, Philip Pronin, Janani Padmanabhan, Giuseppe Ottaviano, and Linjun Yang. 2020. Embedding-based retrieval in facebook search. In *Proceedings of the 26th ACM SIGKDD International Conference on Knowledge Discovery & Data Mining*. 2553–2561.

[10] Jeff Johnson, Matthijs Douze, and Hervé Jégou. 2021. Billion-Scale Similarity Search with GPUs. *IEEE Trans. Big Data* 7, 3 (2021), 535–547. <https://doi.org/10.1109/TBDATA.2019.2921572>

[11] Michael S. Kester, Manos Athanassoulis, and Stratos Idreos. 2017. Access Path Selection in Main-Memory Optimized Data Systems: Should I Scan or Should I Probe?. In *Proceedings of the 2017 ACM International Conference on Management of Data, SIGMOD Conference 2017, Chicago, IL, USA, May 14-19, 2017*, Semih Salihoglu, Wenchao Zhou, Rada Chirkova, Jun Yang, and Dan Suciu (Eds.). ACM, 715–730. <https://doi.org/10.1145/3035918.3064049>

[12] Patrick S. H. Lewis, Ethan Perez, Aleksandra Piktus, Fabio Petroni, Vladimir Karpukhin, Naman Goyal, Heinrich Küttler, Mike Lewis, Wen-tau Yih, Tim Rocktäschel, Sebastian Riedel, and Douwe Kiela. 2020. Retrieval-Augmented Generation for Knowledge-Intensive NLP Tasks. In *Advances in Neural Information Processing Systems 33: Annual Conference on Neural Information Processing Systems 2020, NeurIPS 2020, December 6-12, 2020, virtual*, Hugo Larochelle, Marc'Aurelio Ranzato, Raia Hadsell, Maria-Florina Balcan, and Hsuan-Tien Lin (Eds.). <https://proceedings.neurips.cc/paper/2020/hash/6b493230205f780e1bc26945df7481e5-Abstract.html>

[13] Yu. A. Malkov et al. 2024. HNSWlib: Efficient Algorithm for Approximate Nearest Neighbor Search. <https://github.com/nmslib/hnswlib>. Accessed: 2024-03-15.

[14] Yury A. Malkov and Dmitry A. Yashunin. 2020. Efficient and Robust Approximate Nearest Neighbor Search Using Hierarchical Navigable Small World Graphs. *IEEE Trans. Pattern Anal. Mach. Intell.* 42, 4 (2020), 824–836. <https://doi.org/10.1109/TPAMI.2018.2889473>

[15] Meta AI. 2024. Using AI to Detect COVID-19 Misinformation and Exploitative Content. <https://ai.meta.com/blog/using-ai-to-detect-covid-19-misinformation-and-exploitative-content/>. Accessed: 2024-02-20.

[16] Patrick E. O’Neil, Elizabeth J. O’Neil, Xuedong Chen, and Stephen Revilak. 2009. The Star Schema Benchmark and Augmented Fact Table Indexing. In *Performance Evaluation and Benchmarking, First TPC Technology Conference, TPCTC 2009, Lyon, France, August 24-28, 2009, Revised Selected Papers (Lecture Notes in Computer Science, Vol. 5895)*, Raghunath Othayoth Nambiar and Meikel Poess (Eds.). Springer, 237–252. https://doi.org/10.1007/978-3-642-10424-4_17

[17] Rapidsai. 2022. Rapidsai/raft: RAFT contains fundamental widely-used algorithms and primitives for data science, Graph and machine learning. <https://github.com/rapidsai/raft>

[18] Viktor Sanca and Anastasia Ailamaki. 2023. Analytical Engines With Context-Rich Processing: Towards Efficient Next-Generation Analytics. In *39th IEEE International Conference on Data Engineering, ICDE 2023, Anaheim, CA, USA, April 3-7, 2023*. IEEE, 3699–3707. <https://doi.org/10.1109/ICDE55515.2023.00298>

[19] Viktor Sanca and Anastasia Ailamaki. 2023. E-Scan: Consuming Contextual Data with Model Plugins. In *Joint Proceedings of Workshops at the 49th International Conference on Very Large Data Bases (VLDB 2023), Vancouver, Canada, August 28 - September 1, 2023 (CEUR Workshop Proceedings, Vol. 3462)*, Rajesh Bordawekar, Cinzia Cappiello, Vasilis Efthymiou, Lisa Ehrlinger, Vijay Gadepally, Sainyam Galhotra, Sandra Geisler, Sven Gropp, Le Gruenwald, Alon Y. Halevy, Hazar Harmouch, Oktie Hassanzadeh, Ihab F. Ilyas, Ernesto Jiménez-Ruiz, Sanjay Krishnan, Tirthankar Lahiri, Guoliang Li, Jiaheng Lu, Wolfgang Maurer, Umar Farooq Minhas, Felix Naumann, M. Tamer Özsu, El Kindi Rezig, Kavitha

- Srinivas, Michael Stonebraker, Satyanarayana R. Valluri, Maria-Esther Vidal, Haixun Wang, Jiannan Wang, Yingjun Wu, Xun Xue, Mohamed Zait, and Kai Zeng (Eds.). CEUR-WS.org. <https://ceur-ws.org/Vol-3462/CDMS11.pdf>
- [20] Viktor Sanca and Anastasia Ailamaki. 2023. Post-Moore’s Law Fusion: High-Bandwidth Memory, Accelerators, and Native Half-Precision Processing for CPU-Local Analytics. In *Joint Proceedings of Workshops at the 49th International Conference on Very Large Data Bases (VLDB 2023), Vancouver, Canada, August 28 - September 1, 2023 (CEUR Workshop Proceedings, Vol. 3462)*, Rajesh Bordawekar, Cinzia Cappiello, Vasilis Efthymiou, Lisa Ehrlinger, Vijay Gadepally, Sainyam Galhotra, Sandra Geisler, Sven Groppe, Le Gruenwald, Alon Y. Halevy, Hazar Harmouch, Oktie Hassanzadeh, Ihab F. Ilyas, Ernesto Jiménez-Ruiz, Sanjay Krishnan, Tirthankar Lahiri, Guoliang Li, Jiaheng Lu, Wolfgang Mauerer, Umar Farooq Minhas, Felix Naumann, M. Tamer Özsu, El Kindi Rezig, Kavitha Srinivas, Michael Stonebraker, Satyanarayana R. Valluri, Maria-Esther Vidal, Haixun Wang, Jiannan Wang, Yingjun Wu, Xun Xue, Mohamed Zait, and Kai Zeng (Eds.). CEUR-WS.org. <https://ceur-ws.org/Vol-3462/ADMS1.pdf>
- [21] Viktor Sanca, Manos Chatzakis, and Anastasia Ailamaki. 2023. Context-Enhanced Relational Operators with Vector Embeddings. *CoRR* abs/2312.01476 (2023). <https://doi.org/10.48550/ARXIV.2312.01476>
- [22] Transaction Processing Performance Council. 2024. TPC Homepage. <https://www.tpc.org/> Accessed: 2024-03-15.
- [23] Yuming Xu, Hengyu Liang, Jin Li, Shuotao Xu, Qi Chen, Qianxi Zhang, Cheng Li, Ziyue Yang, Fan Yang, Yuqing Yang, Peng Cheng, and Mao Yang. 2023. SPFresh: Incremental In-Place Update for Billion-Scale Vector Search. In *Proceedings of the 29th Symposium on Operating Systems Principles, SOSP 2023, Koblenz, Germany, October 23-26, 2023*, Jason Flinn, Margo I. Seltzer, Peter Druschel, Antoine Kaufmann, and Jonathan Mace (Eds.). ACM, 545–561. <https://doi.org/10.1145/3600006.3613166>
- [24] Qianxi Zhang, Shuotao Xu, Qi Chen, Guoxin Sui, Jiadong Xie, Zhizhen Cai, Yaoqi Chen, Yinxuan He, Yuqing Yang, Fan Yang, Mao Yang, and Lidong Zhou. 2023. VBASE: Unifying Online Vector Similarity Search and Relational Queries via Relaxed Monotonicity. In *17th USENIX Symposium on Operating Systems Design and Implementation, OSDI 2023, Boston, MA, USA, July 10-12, 2023*, Roxana Geambasu and Ed Nightingale (Eds.). USENIX Association, 377–395. <https://www.usenix.org/conference/osdi23/presentation/zhang-qianxi>
- [25] Renrui Zhang, Xiangfei Hu, Bohao Li, Siyuan Huang, Hanqiu Deng, Yu Qiao, Peng Gao, and Hongsheng Li. 2023. Prompt, Generate, Then Cache: Cascade of Foundation Models Makes Strong Few-Shot Learners. In *IEEE/CVF Conference on Computer Vision and Pattern Recognition, CVPR 2023, Vancouver, BC, Canada, June 17-24, 2023*. IEEE, 15211–15222. <https://doi.org/10.1109/CVPR52729.2023.01460>

Received 22 March 2024