

# Noise-induced shallow circuits and absence of barren plateaus

Antonio Anna Mele,<sup>1,\*</sup> Armando Angrisani,<sup>2,3,†</sup> Soumik Ghosh,<sup>4</sup>

Sumeet Khatri,<sup>1</sup> Jens Eisert,<sup>1,5</sup> Daniel Stilck França,<sup>6,‡</sup> and Yihui Quek<sup>7,§</sup>

<sup>1</sup>*Dahlem Center for Complex Quantum Systems, Freie Universität Berlin, 14195 Berlin, Germany*

<sup>2</sup>*LIP6, CNRS, Sorbonne Université, 75005 Paris, France*

<sup>3</sup>*Institute of Physics, Ecole Polytechnique Fédérale de Lausanne (EPFL), CH-1015 Lausanne, Switzerland*

<sup>4</sup>*Department of Computer Science, University of Chicago, Chicago, Illinois 60637, USA*

<sup>5</sup>*Fraunhofer Heinrich Hertz Institute, 10587 Berlin, Germany*

<sup>6</sup>*Univ Lyon, ENS Lyon, UCBL, CNRS, Inria, LIP, F-69342, Lyon Cedex 07, France*

<sup>7</sup>*Departments of Mathematics and Physics, Massachusetts Institute of Technology,  
182 Memorial Drive, Cambridge, MA 02138, USA*

(Dated: March 22, 2024)

Motivated by realistic hardware considerations of the pre-fault-tolerant era, we comprehensively study the impact of uncorrected noise on quantum circuits. We first show that any noise ‘truncates’ most quantum circuits to effectively logarithmic depth, in the task of computing Pauli expectation values. We then prove that quantum circuits under any non-unital noise exhibit lack of barren plateaus for cost functions composed of local observables. But, by leveraging the effective shallowness, we also design a classical algorithm to estimate Pauli expectation values within inverse-polynomial additive error with high probability over the ensemble. Its runtime is independent of circuit depth and it operates in polynomial time in the number of qubits for one-dimensional architectures and quasi-polynomial time for higher-dimensional ones. Taken together, our results showcase that, unless we carefully engineer the circuits to take advantage of the noise, it is unlikely that noisy quantum circuits are preferable over shallow quantum circuits for algorithms that output Pauli expectation value estimates, like many variational quantum machine learning proposals. Moreover, we anticipate that our work could provide valuable insights into the fundamental open question about the complexity of sampling from (possibly non-unital) noisy random circuits.

## I. Introduction

One of the most important questions for quantum computers of today is to understand the behavior and impact of noise [1]. It is crucial to understand whether noisy quantum computers provide any advantage, both for practically relevant problems [2, 3], or even as proof-of-principle [4], or whether we ultimately need error-corrected logical qubits to achieve this goal [5]. Past years have seen a tussle between demonstrations of quantum advantage [3, 4, 6–8] and subsequent efficient classical simulation [9–19]. The issue of noise shows up in a multi-faceted way in various areas of near-term quantum computation. In quantum machine learning, certain types of noises cause ‘barren plateaus’ in optimization landscapes – that is, the optimization landscape becomes flat, and any quantum signal is destroyed [20, 21]. In random quantum circuit sampling [8], a popular framework for demonstrations of quantum advantage, certain type of noise makes it possible to simulate the systems efficiently classically [22]. However, the vast majority of prior work assumes the noise to be *local*, *unital*, and *primitive* (e.g., depolarizing)—where a quantum channel is deemed unital if it maps the maximally mixed state onto itself, and primitive if any state converges to the maximally mixed state if the channel is applied often enough. However, for a number of current physical platforms, it is by far more natural and realistic to consider the noise as *non-unital* [4, 23–25], which can decrease the entropy of the system – to the extent that depolarizing noise can be a misleading model. Previous results have studied the qualitatively different behavior of this noise in certain contexts; for instance, fault tolerance [26] and random circuit sampling [27].

In this work, we make significant strides in presenting a comprehensive understanding of the impact of possibly non-unital noise on typical quantum circuits. Our assumptions about the noise are minimal, in particular we consider it to be *local* and *incoherent*, i.e., the noise present in the device has a tensor product structure and it is not given by a unitary channel. Our main results can be succinctly stated as follows:

- **Effective depth:** We show that deep random quantum circuits, under *any* uncorrected, possibly non-unital noise, effectively get ‘truncated’ in the following sense: the influence of gates on Pauli expectation values decreases exponentially in their distance from the last layer, i.e., only the last layers contribute significantly to the expectation value.

\* a.mele@fu-berlin.de

† armando.angrisani@epfl.ch

‡ daniel.stilck-franca@ens-lyon.fr

§ yquek@mit.edu

- **Lack of barren plateaus:** Because the effective circuit is always ‘shallow’, we get a provable lack of barren plateaus for cost functions made out of local observables—that is, the cost landscape is never flat, and the gradient of the cost function never vanishes—at any depth, under non-unital noise. This also implies that local expectation values of arbitrary deep random quantum circuits with non-unital noise are *not too concentrated* towards a fixed value, in stark contrast to the unital noise scenario. This phenomenon, however, is not good news for variational quantum algorithms [21], as we show that such circuits behave like shallow circuits, which have limited computational power.
- **Classical simulation:** Furthermore, by exploiting the effective shallowness of the circuits, we show how to classically simulate, on average over the class of noisy quantum circuits, expectation values of any local observable, up to  $\varepsilon$  additive precision, at *any* depth, within runtime  $\exp(O(\log^D(\varepsilon^{-2})))$ , where  $D$  is the spatial dimension of the system. So, for constant precision, the algorithm is efficient for *any* constant spatial dimension, and for inverse polynomial precision, the algorithm is efficient for one-dimensional architectures.

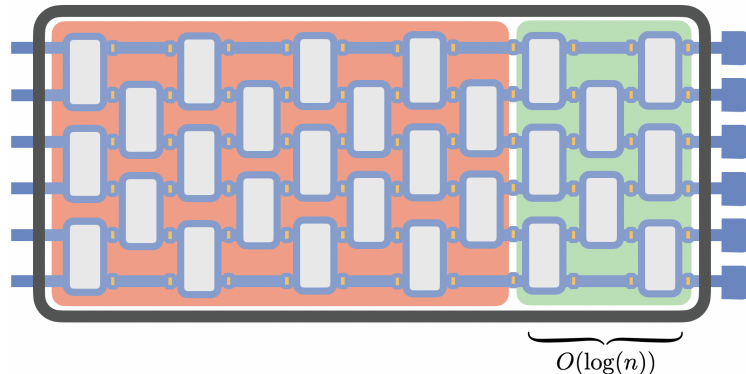

Figure 1. For most of the quantum circuits with non-unital noise only the last  $O(\log(n))$  influence significantly the expectation values of local observables. Here,  $n$  is the number of qubits.

In summary, our results show that *most* quantum circuits with non-unital noise at *any* depth behave qualitatively as (noisy) shallow quantum circuits for the task of estimating Pauli expectation values. Beyond this task, we further establish that the majority of noisy quantum circuits  $\Phi$ , with a depth at least linear in the number of qubits, become independent to the initial states – specifically, for any two states  $\rho$  and  $\sigma$ , the trace distance between  $\Phi(\rho)$  and  $\Phi(\sigma)$  vanishes exponentially in the number of qubits.

Note that although we are significantly more general than many previous results when it comes to noise model, our results hold only on average over a well-motivated class of quantum circuits and do not apply to every circuit in the class. However, this limitation is necessary; specifically, it reflects the fact that not every quantum circuit without access to fresh auxiliary systems becomes computationally trivial after a certain number of operations under more general noise, unlike circuits subjected to depolarizing noise [28]. For instance, Ref. [26] has shown that it is possible to perform exponentially long quantum computations under non-unital noise, with specially constructed circuits. Because of this, we cannot expect to prove our statements for *all* quantum circuits with non-unital noise.

From a technical perspective, our results rely on bounding various second moments of observable expectation values under noisy random quantum circuits. In particular, we show how combining a normal form of qubit channels [29] with a reduction to ensembles of random Clifford circuits renders most computations tractable. The only assumption we need is satisfied for any architecture where the local gates form 2-designs [30, 31], making our results widely applicable. Taken together, our results substantially advance our understanding of the noise impact on near-term quantum computation and showcase that, unless we carefully engineer the circuits to take advantage of the noise (e.g., as in Ref. [26]), it is unlikely that a quantum computer with non-unital noise is preferable over one with depolarizing noise.

### 1. Related works

Previous studies have shown that circuits subjected to possibly non-unital noise can produce output states that are effectively independent from their input states [32, 33], i.e., they present a notion of an *effective depth*. However, these studies explore regimes significantly and distinctly different from ours. Specifically, Ref. [32] has shown that the output

states of any circuit with depth more than exponential in the number of qubits  $n$ , when interleaved with non-unital noise, become effectively independent of the input state. In our work, instead, we show that even linear-depth circuits can accomplish this – although only on average over the circuit class. The same cannot be shown for worst-case circuits because non-unital noise can be leveraged to perform fault-tolerant quantum computation up to  $O(\exp(n))$  depth without needing fresh ancillary qubits [26]. Furthermore, Ref. [33] has shown that circuits, composed of  $\Omega(n)$  layers of global 2-designs interspersed with non-unital noise, yield output states that are effectively independent of their initial states. In contrast, we only assume that each of the local two-qubit gate forms a 2-design, which is arguably a more realistic circuit model. Moreover, Refs. [34, 35] provide contraction bounds for quantum annealers and limitations for the *quantum approximate optimization algorithm* (QAOA) which holds for several families of non-unital noise. Here, we show that most quantum circuits with non-unital noise behave like shallow quantum circuits for the task of computing Pauli expectation values. In this regard, a line of research has delved into the limitations of shallow quantum circuits in terms of their computational capabilities. Notably, across a broad spectrum of combinatorial optimization problems, classical algorithms outperform quantum algorithms implemented by shallow quantum circuits [34–39]. On the other hand, it has been shown that shallow quantum circuits are unconditionally more powerful than shallow classical circuits [40–42].

The interplay between barren plateaus, random circuits and noise has been thoroughly explored by the previous literature in the context of *variational quantum algorithms* (VQAs) [21]. In the noiseless scenario, it has been highlighted [43, 44] that if the parameter distribution underlying the parametrized quantum circuit forms a global 2-design [45], then any associated cost function exhibits barren plateaus. The influence of the locality of observables on the onset of barren plateaus has been explored in Refs. [46–48]. Methods for avoiding or mitigating barren plateaus in noiseless scenarios have been proposed, primarily relying on specific heuristic-based initialization strategies [44, 49–54], as well as by constraining the circuit expressibility [55–64]. Furthermore, it has been recently conjectured that methods to ‘provably’ avoid barren plateaus typically enable also efficient classical simulation, either with purely classical resources or after an initial data acquisition phase which may require a quantum computer [65]. In the context of noisy scenarios, Ref. [20] showed that under the action of unital noise, both cost functions and gradients experience exponential decay in the circuit depth. This phenomenon has been dubbed ‘*noise-induced barren plateaus*’ (NIBPs), and it has been considered as a major hurdle for VQAs since NIBPs kick in regardless of the used initialization strategy [20] – crucially, assuming unital noise. Another recent work [66] shows how barren plateaus can emerge even with non-unital noise when the circuit is made by global 2-designs interleaved by non-unital noise. Our work is different from [66], because we consider the arguably more realistic model in which the noise acts after each local gate that composes the circuit. In Ref. [67], the authors observed that properly engineered Markovian noise can prevent barren plateaus, although their analysis holds for a single noisy layer.

In our work, we show how non-unital noise leads to strikingly different conclusions than unital noise (e.g., depolarizing) in the context of barren plateaus. We prove that parametrized quantum circuits made by 2-qubit gates (each of them being drawn from a 2-design) do not exhibit exponential cost function concentration at any depth, and that the gates in the last  $O(\log(n))$  layers of the circuit are (the only) trainable, implying absence of barren plateaus. In contrast, in the depolarizing noise case, no gates are trainable for sufficiently deep circuits [20], implying exponential cost function concentration and the onset of barren plateaus. In other contexts, it has been pointed out how non-unital noise can lead to drastically different conclusions compared to unital noise. For example, in the context of fault-tolerant quantum computation, it was shown [26] that while in the non-unital noise scenario quantum computation is possible up to  $O(\exp(n))$  depth without the need for introducing *fresh* ancillary qubits, in the depolarizing noise scenario the same is possible only up to  $O(\log(n))$  depth [28, 68], or in the case of dephasing noise only up to  $O(\text{poly}(n))$  depth. Moreover, Ref. [27] showed how existing easiness and hardness proofs [69–71] of random circuit sampling break down, under non-unital noise, because the output distribution of the circuit is not ‘flat enough’—or in more technical terms, it does not ‘anticoncentrate’ [72].

The pursuit of efficient classical simulation algorithms for quantum circuits has also been addressed in previous research. The task of simulating expectation values was addressed in several works (see, for instance, Ref. [73] for shallow circuits and Ref. [74] for circuits interspersed by Pauli noise). In particular, if the circuit is shallow and the observable is local, then it is well-known that standard light-cone arguments suffice to compute efficiently the expectation value [73, 75]. (See Ref. [76] for a discussion on the strategy of considering light-cone arguments for estimating expectation values of local observables with respect to tensor network states.) In the case of noisy tensor network quantum states [76, 77], it has already been pointed out that only the last layers of the circuit preparing such states are sufficient for the estimation of local observables. In our work, we show that most of the states prepared by arbitrary deep noisy random quantum circuits have this property, leading to an efficient (average-case) classical simulation algorithm leveraging this effective shallowness and light-cone arguments. While for sufficiently deep circuits affected by depolarizing noise, estimating the expectation value merely requires outputting the result obtained from the maximally mixed state [20, 28]—yielding zero for Pauli observables—in scenarios involving non-unital noise, such an approach does not work, as we show that local expectation values of random quantum circuits with non-unital

noise are not very concentrated around a fixed value. For the task of approximately generating samples from the output distribution of random circuits interspersed by depolarizing noise, an efficient classical algorithm has been provided in Ref. [22]. However, the same analysis of [22] does not straightforwardly generalize to non-unital noise, as noted in Ref. [27], because of the very peaked nature of the output distribution. Thus, designing an efficient classical algorithm for this sampling task under non-unital noise remains an open problem to date.

### Overview of the results

Our work is organized as follows:

- In Subsection **IA**, we prove the effective depth picture. Namely, we show that the layers preceding the last  $\Theta(\log(n))$  have negligible influence for the task of estimating Pauli expectation values. Notably, here the only assumption on the noise is that the associated channel is not a unitary channel. Then, we also show that the trace distance between two arbitrary states affected by the same linear depth noisy random quantum circuit becomes exponentially small. In addition, we also investigate the impact of non-unital noise on worst-case (i.e., any possible) quantum circuit. In particular, we prove that, if the noise strength *exceeds* a certain threshold, the layers at superlogarithmic distance from the end bear a negligible influence on the output state of *any* circuit.
- In Subsection **IB**, leveraging the concept of effective shallowness, we present a classical simulation algorithm for estimating local expectation values of arbitrary deep noisy random quantum circuits. The algorithm’s core idea capitalizes on the fact that local expectation values of shallow quantum circuits can be computed efficiently through standard light-cone arguments. Furthermore, we discuss a *verification condition* that certifies the success of the classical simulation for a given fixed circuit.
- In Subsection **IC**, we show that expectation values of local observables of random quantum circuits with non-unital noise are not exponentially concentrated towards a fixed value, in stark contrast to the unital noise scenario. Moreover, we complement the results in Subsection **IA** by revealing that the last  $\Theta(\log(n))$  layers of random quantum circuits with non-unital noise have a non-trivial impact on local expectation values. This implies that non-unital noise induces an absence of barren plateaus at *any* depth, for cost functions defined with respect to local expectation values. Furthermore, we observe that cost functions defined with respect to global Pauli observables exhibit exponential cost-concentration and barren plateaus at any depth. Similarly, we show that fidelity quantum kernels [78–80], well-studied quantities in the context of quantum machine learning, experience exponential concentration at any depth under various noise models, including both unital and non-unital channels – in contrast to projected quantum kernels [78, 81]. For the special case of unital noise, we also present upper bounds for barren plateaus and fidelity kernels with a substantial improvement compared to previous results [78, 82], which are restricted only to certain types of unital noise, whereas our results holds for general unital noise and have a tighter dependence on the circuit depth.

The detailed technical aspects are covered extensively in the Supplementary Material – here we give an overview of the main results.

### 2. Preliminaries and definitions

As many of our results rely on understanding how noise behaves *on average* over circuits, we first introduce the circuit ensembles over which these averages are taken. We consider  $n$ -qubit quantum circuits  $\Phi$  consisting of layers of two-qubit gates interleaved by local (single-qubit) noise, with a final layer of single-qubit gates. All gates are assumed to be drawn from a 2-design, and we make no assumptions about geometric locality, except where explicitly mentioned. We express our circuits as

$$\Phi := \mathcal{V}^{\text{single}} \circ \mathcal{N}^{\otimes n} \circ \mathcal{U}_L \circ \dots \circ \mathcal{N}^{\otimes n} \circ \mathcal{U}_1, \quad (1)$$

where  $\mathcal{V}^{\text{single}} := V(\cdot)V^\dagger$ , with  $V := \bigotimes_{i=1}^n U_i$ , is a layer of single-qubit gates,  $L$  represents the number of layers, also referred to as circuit depth,  $\mathcal{U}_i$  corresponds to the channel associated with the  $i$ -th unitary circuit layer for  $i \in [L] := \{1, 2, \dots, L\}$ , and  $\mathcal{N}$  is a single-qubit quantum channel. Exploiting the fact that we draw gates from a two-qubit 2-design and we consider up to second-moment quantities, without loss of generality, the underlying distributions of unitaries do not change if we conjugate  $\mathcal{N}$  on the left and right by arbitrary unitary channels. Then, using the so-called ‘normal’ form representation of the channel [29, 83], without loss of generality,  $\mathcal{N}$  can be defined

in terms of two real vectors  $\mathbf{t} := (t_X, t_Y, t_Z) \in \mathbb{R}^3$  and  $\mathbf{D} := (D_X, D_Y, D_Z) \in \mathbb{R}^3$ , describing its action on a quantum state written in its Bloch sphere representation as

$$\mathcal{N}\left(\frac{I + \mathbf{w} \cdot \boldsymbol{\sigma}}{2}\right) = \frac{I}{2} + \frac{1}{2}(\mathbf{t} + D\mathbf{w}) \cdot \boldsymbol{\sigma}, \quad (2)$$

where  $D := \text{diag}(\mathbf{D})$ ,  $\mathbf{w} \in \mathbb{R}^3$  with  $\|\mathbf{w}\|_2 \leq 1$ , and  $\boldsymbol{\sigma} := (X, Y, Z)$  is the vector of single-qubit Pauli matrices. In our work, it is crucial to consider the constant  $c := \frac{1}{3}(\|\mathbf{D}\|_2^2 + \|\mathbf{t}\|_2^2)$ , as we show that it quantifies the contraction rate with respect to the depth of our noisy random circuits. Particularly, we show that  $c \leq 1$ , and the equality holds if and only if  $\mathcal{N}$  is a unitary channel. We will often analyze noisy circuits in the Heisenberg picture. In particular, the adjoint channel  $\mathcal{N}^*$  acts on  $Q \in \{X, Y, Z\}$  as

$$\mathcal{N}^*(Q) = t_Q I + D_Q Q \quad (3)$$

and on  $I$  as  $\mathcal{N}^*(I) = I$ . Note that if the noise is unital, i.e.,  $\mathcal{N}(I) = I$ , then we have  $t_Q = 0$  for all  $Q \in \{X, Y, Z\}$ .

### A. Noise-induced effective shallow circuits

Here, we first present a high-level motivation for our investigation of the effective depth of noisy quantum circuits with respect to the task of estimating Pauli observables and then move to present our results formally.

#### *Effective depth: a high-level motivation*

The question of how uncorrected noise affects quantum computation has gained prominence in the era of *noisy intermediate-scale quantum devices* (NISQ) [1, 84], where resources for fault-tolerance are scarce. To address this question for a commonly studied task, we investigate how non-unital noise impacts quantum computations whose output is given by the expectation value of some observable of interest, e.g., a Pauli observable  $P$ , or an estimation thereof. A centerpiece of our work is the bound

$$\mathbb{E}_\Phi[|\text{Tr}(P\Phi(\rho - \sigma))|] \leq \exp(-\Omega(\text{depth}(\Phi))), \quad (4)$$

which holds for any two input states  $\rho$  and  $\sigma$ . Here the expected value  $\mathbb{E}_\Phi$  is taken over the local gates that compose the (possibly non-unital) noisy circuit  $\Phi$  and that are assumed to be distributed according to a local 2-design. Several early results [20, 22, 68, 85] assumed that the noise in a circuit could be modeled as *single-qubit depolarizing noise*. One result in this line [28] asserts that any circuit  $\Phi^{\text{dep}}$  with depth  $L = \Omega(\log(n))$  interspersed with layers of depolarizing noise outputs the maximally-mixed state up to error which vanishes exponentially in  $L$  in trace distance as

$$\|\Phi^{\text{dep}}(\rho) - \mathbb{I}/2^n\|_1 \leq O(\sqrt{n}b^L), \quad (5)$$

for some constant  $b \in (0, 1)$  that is independent of the state  $\rho$ . This implies that also  $|\text{Tr}(P\Phi^{\text{dep}}(\rho - \sigma))|$  is bounded from above by  $O(\sqrt{n}b^L)$ , for any two states  $\rho$  and  $\sigma$  and any Pauli operator  $P$ . We refer to Section E 1 for a concise derivation of Eq. (5). What is notable about this expression is that a *single* state—the maximally-mixed state—is the ‘limit’ to which all circuits affected by depolarizing noise converge, independent of what gates are actually in the circuit, or its input state. The depolarizing noise assumption, if true, enormously constrains noisy quantum algorithms outputting expectation values and without access to fresh auxiliary qubits: to perform useful computation, they should be executable within  $O(\log(n))$  depth. According to Eq. (5), any noisy circuit with depth larger than  $O(\log(n))$  cannot be efficiently distinguished by the maximally mixed state. Thus, for estimating Pauli expectation values  $P$  up to inverse polynomial error, one can always output the fixed quantity  $\text{Tr}(P\mathbb{I}/2^n) = 0$ . If the depth is  $O(\log(n)^{1/D})$ , where  $D$  is the spatial dimensionality of the circuit, then Pauli expectation values of any quantum circuit interspersed with depolarizing noise can be computed efficiently by standard light-cone arguments (if the observable is local) or by exploiting the fact that Pauli expectation values are exponentially suppressed with the Pauli weight (if the observable is global). For one-dimensional architectures, this provides an efficient classical simulation algorithm to estimate Pauli expectation values of any circuit under depolarizing noise at any depth [86].

However, one could justifiably raise concerns about this conclusion on physical grounds. First, the noise in real hardware is not necessarily depolarizing or even unital [4, 23–25]; secondly, even a slight departure from the depolarizing noise assumption causes the picture to change dramatically. For instance, consider the single-qubit dephasing noise  $\mathcal{D}$ , which acts as  $\mathcal{D}(\rho) = (1 - p)\rho + p \text{diag}(\rho_{0,0}, \rho_{1,1})$  for some  $p \in [0, 1]$ . Dephasing noise preserves the diagonal

elements of its input and thus still falls within the category of unital noise. Now, consider a three-qubit circuit consisting of  $L$  consecutive layers of Toffoli gates interspersed with layers of dephasing noise: this noisy circuit acts as the identity on the input states  $\rho_0 = |0, 0, 0\rangle\langle 0, 0, 0|$  and  $\sigma_0 = |1, 0, 0\rangle\langle 1, 0, 0|$ , no matter how deep it is. For these two input states, Eq. (5) does not hold. This example illustrates the impossibility of drawing any conclusions about expectation values like  $\text{Tr}(Z_1\Phi(\rho))$  that depend only on the *depth* of the circuit—when the noise is non-depolarizing, the actual gates in the circuit, as well as the input state  $\rho$ , can affect the result very much.

Broadening our scope to general non-unital noise, the non-trivial nature of analyzing arbitrary circuits under such noise arises from the following intuition. Unital noise preserves the maximally-mixed state, and so does any unitary. Thus, a circuit consisting of alternating layers of unitaries and unital noise has both its unitary and noise components acting ‘in tandem’ to drive the state towards the maximally-mixed state. When the noise is non-unital, however, the unitary and the noise components of the circuit do not have the same fixed point, and thus can be understood to be acting ‘in different directions’. Little is known about the behaviour of these noisy circuit ensembles—a debate to which we hope to contribute with Eq. (4). The expected value  $\mathbb{E}_\Phi$  in Eq. (4) is taken to avoid pathological cases: as previously noticed, on worst-case circuits the quantity  $|\text{Tr}(P\Phi(\rho - \sigma))|$  may attain a constant value independent of depth for certain kinds of noise, such as the dephasing channel. Moreover, the so-called *quantum refrigerator* construction [26] shows surprisingly how non-unital noise can be leveraged to perform fault-tolerant quantum computation for up to exponential depth with circuits similar to ours. Therefore, for these special classes of circuits, we do not expect this worst-case upper bound to hold.

Although contraction results for worst-case circuits have appeared in the literature [28, 34, 87], they encompass a less general class of channels than those considered in the present work. Thus, proving a contraction result for general—possibly non-unital—noise is far from trivial, and to our knowledge, our work provides the strongest result in this regard, by crucially leveraging the randomness of the circuit.

#### *Effective depth: formal result*

In this subsection, we formally present our results concerning the effective depth of arbitrary deep random quantum circuits under possibly non-unital noise, with respect to the task of estimating Pauli expectation values. Our results reveal that the influence of gates on Pauli expectation values decreases exponentially with their distance from the last layer. See Fig. 1 for a graphical representation. Our main result can be stated as follows.

**Proposition 1** (Effective logarithmic depth). *Let  $P \in \{I, X, Y, Z\}^{\otimes n}$ ,  $\rho_0$  be any initial state,  $L$  be the depth of the noisy circuit  $\Phi$ , and  $l \in \mathbb{N}$ . We assume that the noise in the circuit is not a unitary channel. Then, we have*

$$\mathbb{E}_\Phi[|\text{Tr}(P\Phi(\rho_0)) - \text{Tr}(P\Phi_{[L-l, L]}(\rho_0))|] \leq \exp(-\Omega(l)). \quad (6)$$

Here,  $\Phi_{[L-l, L]}(\cdot)$  refers to the noisy circuit where only the last  $l$  layers are considered, the average  $\mathbb{E}_\Phi$  is taken with respect to the 2-design distribution of every two-qubit gate that composes the circuit, and  $\Omega(\cdot)$  hides noise parameters.

By Markov’s inequality, this result directly implies that, for most noisy arbitrary deep quantum circuits, considering only the last  $\Theta(\log(n))$  layers suffices to obtain an estimate of any Pauli expectation value with precision scaling inverse-polynomially with the number of qubits. This result is a particular case of the following more general statement.

**Theorem 2** (General scaling). *Let  $\rho$  and  $\sigma$  be arbitrary quantum states,  $P \in \{I, X, Y, Z\}^{\otimes n}$  with Pauli weight  $|P|$ , and  $L$  be the depth of the noisy circuit. Assuming that the noise is not a unitary channel, we have*

$$\mathbb{E}_\Phi[\text{Tr}(P\Phi(\rho - \sigma))^2] \leq \exp(-\Omega(L + |P|)). \quad (7)$$

Specifically, the upper bound that we prove is  $O(c^{L+|P|})$ , where  $c < 1$  is the constant defined in the preliminary Subsection I 2. We now provide a sketch of the proof of Theorem 2. At a high level, the proof works by going into the Heisenberg picture, ‘peeling off’ a unitary and noisy layer of the depth- $L$  circuit, and then applying the adjoint of these layers to the Pauli  $P$ . Using properties of the random circuit and that of the noise channel, we then show that this recovers a Pauli expectation value on a noisy circuit of depth  $L - 1$ , which puts us in the position to reiterate the argument.

*Proof sketch of Theorem 2.* Because our local two-qubit gates are drawn from a 2-design and we are computing a second moment, we can assume that all gates are Clifford [88] and that the noise channels are in their normal form. Let  $\tilde{\Phi}$  be a noisy circuit of depth  $L - 1$  and let  $\Phi$  be a noisy circuit of depth  $L$ . That is,  $\Phi = \mathcal{V}^{\text{single}} \circ \mathcal{N}^{\otimes n} \circ \mathcal{U}_L \circ \tilde{\Phi}$ ,

where we used the same notation defined in Eq. (1). Averaging over the last layer of single-qubit unitaries, we have

$$\mathbb{E}[\text{Tr}(P\Phi(\rho - \sigma))^2] = \frac{1}{3^{|P|}} \sum_{\substack{Q \in \{I, X, Y, Z\}^{\otimes n}: \\ \text{supp}(Q) = \text{supp}(P)}} \mathbb{E} \left[ \text{Tr} \left( Q \mathcal{N}^{\otimes n} \circ \mathcal{U}_L \circ \tilde{\Phi}(\rho - \sigma) \right)^2 \right].$$

Taking the adjoint of the layer of noise  $\mathcal{N}^{\otimes n}$  and using properties of the random gates that compose the unitary layer  $\mathcal{U}_L$ , we have

$$\mathbb{E} \left[ \text{Tr} \left( Q \mathcal{N}^{\otimes n} \circ \mathcal{U}_L \circ \tilde{\Phi}(\rho - \sigma) \right)^2 \right] = \sum_{\alpha \in \{0,1\}^{|Q|}} \prod_{j \in \text{supp}(Q)} (t_{Q_j}^{\alpha_j} D_{Q_j}^{1-\alpha_j})^2 \mathbb{E} \left[ \text{Tr} \left( \left( \bigotimes_{j \in \text{supp}(Q)} Q_j^{1-\alpha_j} \right) \mathcal{U}_L \circ \tilde{\Phi}(\rho - \sigma) \right)^2 \right].$$

Thus, taking the adjoint of the last unitary layer on the Pauli and using the fact that it is made of Clifford gates, which map a Pauli observable to another Pauli observable, we have

$$\begin{aligned} \mathbb{E}[\text{Tr}(P\Phi(\rho - \sigma))^2] &\leq \frac{1}{3^{|P|}} \sum_{\substack{Q \in \{I, X, Y, Z\}^{\otimes n}: \\ \text{supp}(Q) = \text{supp}(P)}} \sum_{\alpha \in \{0,1\}^{|Q|}} \prod_{j \in \text{supp}(Q)} (t_{Q_j}^{\alpha_j} D_{Q_j}^{1-\alpha_j})^2 \max_{Q \in \{I, X, Y, Z\}^{\otimes n}} \mathbb{E} \left[ \text{Tr} \left( Q \tilde{\Phi}(\rho - \sigma) \right)^2 \right] \\ &= \frac{1}{3^{|P|}} (\|\mathbf{D}\|_2^2 + \|\mathbf{t}\|_2^2)^{|P|} \max_{Q \in \{I, X, Y, Z\}^{\otimes n}} \mathbb{E} \left[ \text{Tr} \left( Q \tilde{\Phi}(\rho - \sigma) \right)^2 \right] \\ &= c^{|P|} \max_{Q \in \{I, X, Y, Z\}^{\otimes n}} \mathbb{E} \left[ \text{Tr} \left( Q \tilde{\Phi}(\rho - \sigma) \right)^2 \right], \end{aligned} \quad (8)$$

where we have used the multinomial theorem and the definition of  $c$  given in Subsection I 2. In the Supplementary Material, we prove that  $c < 1$  for every single-qubit channel that is not unitary. Moreover, we can assume that the maximum over the Paulis is not achieved by the identity because otherwise the RHS would be zero since  $\tilde{\Phi}$  is trace preserving and  $\rho - \sigma$  is traceless. Reiterating the argument to the remaining circuit layers establishes the claim.  $\square$

By Jensen's inequality, we obtain

$$\mathbb{E}[|\text{Tr}(P\Phi(\rho)) - \text{Tr}(P\Phi(\sigma))|] \leq \exp(-\Omega(L + |P|)). \quad (9)$$

Particularly, this also directly proves Proposition 1. As an implication of the previous result, we can show that at linear depth  $L = \Omega(n)$ , the average trace distance between two states affected by the same noisy quantum circuit becomes exponentially small in the number of qubits:

$$\mathbb{E}_{\Phi}[\|\Phi(\rho) - \Phi(\sigma)\|_1] \leq \exp(-\Omega(n)). \quad (10)$$

This implies that the application of the same linear depth *random* circuit affected by *any* amount of noise on two different input states renders them effectively indistinguishable (because of the Holevo-Helstrom theorem [89]). To our knowledge, this is the first result of this kind; except for the result of Ref. [32], which only applies to exponential depths but which holds for worst-case circuits, whereas our statement hold on average. As mentioned in Subsection I A, it is in principle not possible to prove our result for worst-case circuits, because there are some special classes of circuits [26] that would violate a worst-case version of our inequality (i.e., Eq. (10) without the expectation value). However, when the noise strength exceeds a certain threshold, we can show a worst-case upper bound on the trace distance that decays exponentially in the number of qubits. Specifically, we show the following.

**Proposition 3** (Worst-case effective depth with high noise). *For a given noise channel, let  $b := 12 \max_{P \in \{X, Y, Z\}} \frac{D_P}{1-D_P}$ , where  $D_P$  with  $P \in \{X, Y, Z\}$  is the noise parameter defined in the preliminary Subsection I 2. Let  $\Phi$  be a noisy random quantum circuit with of depth  $L$ , then the trace distance satisfies*

$$\|\Phi(\rho) - \Phi(\sigma)\|_1 \leq nb^L \|\rho - \sigma\|_1. \quad (11)$$

Thus, for any  $\varepsilon > 0$ , assuming that  $b < 1$  and  $L \geq \frac{1}{\log(b^{-1})} \Omega(\log(\frac{n}{\varepsilon}))$ , we have that  $\|\Phi(\rho) - \Phi(\sigma)\|_1 \leq \varepsilon$ .

The proof relies on passing to the quantum Wasserstein distance of order 1 [35], computing contraction coefficients and passing back to the trace distance using techniques laid out in Ref. [35]. Such results are known in the literature as reverse threshold theorems, as they show that for high enough noise rate error correction is not possible [90–92]. In contrast to previous results, we also extend them to non-unital channels.

## B. Classical simulation of random quantum circuits with possibly non-unital noise

We have shown that the presence of any non-unitary noise renders *most* circuits effectively shallow, for the task of estimating Pauli expectation values. Specifically, Theorem 2 establishes that for any  $L$ -depth circuit  $\Phi$  and Pauli  $P$ , the inequality

$$\mathbb{E}_{\Phi} [|\text{Tr}(P\Phi(|0^n\rangle\langle 0^n|)) - \text{Tr}(P\Phi_{[L-l,L]}(|0^n\rangle\langle 0^n|))|] \leq \exp(-\Omega(l + |P|)) \quad (12)$$

holds, where  $\Phi_{[L-l,L]}(\cdot)$  refers to the noisy circuit where only the last  $l$  layers are considered. Eq. (12) leads to a simple classical algorithm for estimating local Pauli expectation values to additive error: work in the Heisenberg picture and ‘propagate’ the local Pauli  $P$  only a few layers backward; compute the matrix  $P_l := \Phi_{[L-l,L]}^*(P)$  and evaluate  $\text{Tr}(P_l |0^n\rangle\langle 0^n|)$ . Assuming a geometrically local circuit architecture with constant dimension  $D$ , this algorithm has a total time complexity bounded above by  $\exp(O((|P| + l)^D))$ , independent of the number of qubits (because of light-cone arguments). Its guarantees can be proven via Markov inequality applied to Eq. (12). More specifically, we have the following.

**Proposition 4** (Average classical simulation of local expectation values). *Let  $\varepsilon, \delta > 0$ . Consider  $P \in \{I, X, Y, Z\}^{\otimes n}$ , and let  $\rho_0 := |0^n\rangle\langle 0^n|$ . For a noisy  $D$ -dimensional geometrically-local quantum circuit  $\Phi$  of depth  $L$ , sampled according to the described circuit distribution, there exists a classical algorithm that outputs a value  $\hat{C}$  satisfying*

$$|\hat{C} - \text{Tr}(P\Phi(\rho_0))| \leq \varepsilon \quad (13)$$

with at least  $1 - \delta$  probability of success. Specifically, the classical algorithm involves computing  $\hat{C} := \text{Tr}(P\Phi_{[L-l,L]}(\rho_0))$  with

$$l := \left\lceil \frac{1}{\log(c^{-1})} \log\left(\frac{4}{\delta\varepsilon^2}\right) \right\rceil, \quad (14)$$

where  $c$  is the noise parameter defined in the preliminary Subsection I 2. Its runtime is bounded from above as

$$\text{Runtime} \leq \exp\left[O\left(\left(|P| + \frac{1}{\log(c^{-1})} \log\left(\frac{1}{\varepsilon^2\delta}\right)\right)^D\right)\right]. \quad (15)$$

In particular, the runtime is polynomial in the inverse of the precision for one-dimensional architectures, and quasi-polynomial for higher-dimensional architectures. Furthermore, in the Supplementary Material, we provide an alternative *early-break condition* that, if met at some step  $t$ , guarantees an  $\varepsilon$  approximation. This allows us to stop ‘unraveling’ the circuit and simply output  $P_t := \Phi_{[L-t,L]}^*(P)$  with the current value of  $P_t$ . The condition to check is

$$\min_{c \in \mathbb{R}} \|P_t - cI\|_{\infty} \leq \varepsilon/2. \quad (16)$$

Moreover, if this condition is satisfied, we can be certain to have successfully estimated the expectation value. Checking this condition can be done with runtime  $\exp(O((|P| + t)^D))$  by solving a semi-definite problem (SDP) with an analytical solution which we provide in the Supplementary Material. The intuition behind this verification step is that if  $P_t$  were proportional to the identity, then adding further (adjoint) layers would not change the matrix  $P_t$ , due to unitality of the adjoint channel.

Upon inspecting our proof of Theorem 2, it is evident that we often make conservative estimates on the contraction at each step, as it is proportional to exponential in the locality of the input Pauli, and we always bound this from below by 1. Thus, by incorporating a finer analysis of the dynamics of the weight, we conjecture that it is possible to show that this early-break condition will be met before the runtime stated in Proposition 4 with high probability. We leave the proof of this conjecture open for future work.

The above algorithm is efficient if the weight of the Pauli  $P$  is  $|P| = O(\log(n))$  (i.e., its time complexity runs polynomially in the number of qubits), and it is no longer efficient otherwise. However, in the regime of high Pauli weight, no algorithm execution is necessary. Instead, we can simply output zero and ensure, with high probability, an inverse-polynomial accuracy in the number of qubits, as detailed in our Supplementary Material. This stems from the fact that for any noise that is not a unitary channel, we have

$$\mathbb{E}_{\Phi}(\text{Tr}(P\Phi(\rho_0))) = 0, \quad \text{Var}_{\Phi}(\text{Tr}(P\Phi(\rho_0))) \leq \exp(\Omega(-|P|)), \quad (17)$$

followed by an application of Chebyshev’s inequality. We can then summarize our result as follows.



**Remark 5** (Estimating classically any Pauli expectation value). *There is an algorithm for estimating any Pauli expectation value of noisy random quantum circuits at any depth, up to an inverse polynomial precision in the number of qubits. The runtime of the algorithm is polynomial in the number of qubits for one-dimensional architectures and quasi-polynomial for higher-dimensional ones.*

It is worth mentioning that quantum circuits with non-unital noise can have Pauli expectation values of local observables significantly far from zero also in the high-depth regime. We show this in the next section. This is in stark contrast to the case of circuits with, e.g., depolarizing noise, in which Pauli expectation values decay exponentially to zero in the circuit depth [20, 28], which implies that outputting zero suffices to estimate accurately the expectation value for sufficiently deep circuits. This strategy does not work as a classical simulation algorithm for circuits affected non-unital noise, for the reason mentioned in the first sentence of this paragraph.

### C. Lack of barren plateaus with non-unital noise, but only the last $\Theta(\log(n))$ layers matter

The *barren plateaus phenomenon* [20, 43], has been considered one of the main hurdles for *variational quantum algorithms* (VQAs) [21]. These algorithms involve encoding the solution to a problem in the minimization of a cost function, typically defined in terms of expectation values of observables, with the free parameters for optimization being the gate parameters. Barren plateaus are characterized by the phenomenon where the norm of the gradient of the cost function, on average, vanishes exponentially in the number  $n$  of qubits. Consequently, in the presence of barren plateaus, randomly selecting an instance of the parameterized circuit would overwhelmingly lead to a circuit instance situated within a region of the landscape necessitating an exponential number of measurements to navigate, implying loss of any potential quantum advantage. There are two signatures of barren plateaus: exponential concentration of the cost function around a fixed value, and the fact that the norm of the gradient of the cost function is exponentially small. We show that both are avoided in the non-unital noise scenario for cost functions made by local observables. However, we will see that this absence of barren plateaus is only due to the last  $\Theta(\log(n))$  layers of the circuit, while the gradient contribution coming from the preceding layers is negligible. This is essentially a consequence of what we have explored in the preceding sections: we are working with circuits that exhibit an effective logarithmic depth.

#### 1. Lack of exponential concentration for local cost functions with non-unital noise

We consider a circuit  $\Phi$  as we have described in Subsection I 2, where the local noise channels are characterized by the parameters of their normal form representation  $\mathbf{t} := (t_X, t_Y, t_Z)$  and  $\mathbf{D} := (D_X, D_Y, D_Z)$ , which we assume to be constants with respect to the number of qubits. Our first main theorem is the following.

**Theorem 6** (Variance of expectation values of random circuits with non-unital noise). *Let  $H := \sum_{P \in \{I, X, Y, Z\}^{\otimes n}} a_P P$  be an arbitrary Hamiltonian, with  $a_P \in \mathbb{R}$  for  $P \in \{I, X, Y, Z\}^{\otimes n}$ . Let  $\rho$  be a quantum state. We assume that the noise is non-unital and that  $\|\mathbf{t}\|_2 = \Theta(1)$ . Then, at any depth, we have*

$$\text{Var}_{\Phi}[\text{Tr}(H\Phi(\rho))] = \sum_{P \in \{I, X, Y, Z\}^{\otimes n}} a_P^2 \exp(-\Theta(|P|)). \quad (18)$$

The proof of this theorem is provided in the Supplementary Material. Note that the variance scaling in the non-unital noise scenario is independent of the circuit depth, which contrasts sharply with noiseless random quantum circuits or circuits with unital noise [20, 48], where the variance becomes exponentially small in the number of qubits at sufficiently high depth. Our Theorem 6 directly implies that, under non-unital noise, the variance of *local cost functions*—i.e., expectation values of local observables, e.g.,  $\text{Tr}(Z_1\Phi(\rho))$ —is significantly large.

**Corollary 7** (Lack of exponential concentration for local cost functions). *Let  $\rho$  be any quantum state,  $P$  be a local Pauli ( $|P| = \Theta(1)$ ), and  $\Phi$  be the noisy random circuit ansatz. Under the same noise assumptions as above, at any circuit depth, we have*

$$\text{Var}_{\Phi}[\text{Tr}(P\Phi(\rho))] = \Theta(1). \quad (19)$$

In particular, the lower bound on the variance that we prove is  $\frac{1}{3}\|\mathbf{t}\|_2^{2|P|}$ . Here,  $\|\mathbf{t}\|_2$  is the noise-parameter, which quantifies the non-unitality of the channel. As expected, if the noise is unital ( $\|\mathbf{t}\|_2 = 0$ ), we get a vacuous zero lower bound. It is interesting to note that even a *tiny* deviation from the unitality assumption, i.e., if the non-unital noise parameter  $\|\mathbf{t}\|_2$  scales inverse-polynomially with the number of qubits, the variance is not exponentially small.

This implies that local expectation values under non-unital noise are not ‘too concentrated’ around their mean value  $\mathbb{E}_\Phi[\text{Tr}(P\Phi(\rho))] = 0$ , in contrast with the depolarizing noise scenario, in which case the variance decays exponentially with the depth [20]. However, we show that global cost functions—i.e., expectation values of high Pauli weight observables, e.g.,  $\text{Tr}(Z^{\otimes n}\Phi(\rho))$ —still exhibit exponential concentration, as in the noiseless case [46, 48] and in the depolarizing noise scenario. Formally, we find the following cost concentration.

**Corollary 8** (Cost concentration for global expectation values). *Let  $P \in \{I, X, Y, Z\}^{\otimes n}$  with Pauli weight  $|P| = \Theta(n)$ . Assuming that the noise is not a unitary channel, for any constant noise parameters, we have*

$$\text{Var}_\Phi[\text{Tr}(P\Phi(\rho))] \leq \exp(-\Omega(n)). \quad (20)$$

2. *Lack of vanishing gradients for local cost functions, but only the last  $\Theta(\log(n))$  layers are trainable*

The effective depth of noisy random circuits, elucidated in Section IA, implies that, on average, changing the gates in the layers preceding the last  $\Theta(\log(n))$  will not significantly influence the Pauli expectation value. This suggests that only the last few layers of the circuit can substantially alter the expectation value. We analyze this formally using the notion of ‘trainability’ of a parametrized gate. As is common in the literature [21, 65], we refer to a cost function  $C$  as trainable with respect to a parametrized gate labeled by  $\mu$  if and only if  $\text{Var}[\partial_\mu C] = \Omega(1/\text{poly}(n))$ , that is, the variance of the cost function partial derivative with respect to such a parameter vanishes no more than inverse-polynomially in the number of qubits. For a formal definition of cost function partial derivatives and detailed proofs of the following results, we refer to the Supplementary Material. We rigorously show that for local cost functions, under non-unital noise, only the last  $\Theta(\log(n))$  layers of the circuit are trainable, meaning they have significantly large partial derivatives.

**Theorem 9** (Only the last few layers are trainable for local cost functions). *Let  $C = \text{Tr}(P\Phi(\rho_0))$  be a cost function associated with a local Pauli  $P$  (with Pauli weight  $|P| = \Theta(1)$ ), an initial state  $\rho_0$ , and a depth- $L$  noisy random circuit ansatz  $\Phi$  in arbitrary constant dimension. Let  $\mu$  be a parameter (in the light cone) of the  $k$ -th layer. Assume that the noise is not unital and it is not a replacer channel (i.e., it does not output a fixed state). Then, we have*

$$\text{Var}[\partial_\mu C] = \exp(-\Theta(L - k)). \quad (21)$$

Theorem 9 states that local cost functions are mostly sensitive to changes of parameters in the last few layers. This is in stark contrast to the case of depolarizing noise or the noiseless case, in which the partial derivative variances with respect to gates in *all* the layers are exponentially suppressed with the number of qubits at sufficiently high depth [20, 48, 93].

As a corollary of the previous theorem, we have that the norm of the gradient of local cost functions does not exponentially vanish in the number of qubits at any depth. Crucially, this fact is only due to the last few layers of the circuits, which we have shown to be trainable.

**Corollary 10** (Non-vanishing gradient for local cost functions with non-unital noise). *Let  $\rho_0$  be any quantum state and  $P$  be a local Pauli. Let  $C := \text{Tr}(P\Phi(\rho_0))$  be the cost function associated with a noisy random quantum circuit ansatz of any depth. We assume that the noise is non-unital and it is not a replacer channel (i.e., it does not output a fixed state). Then, we have*

$$\mathbb{E}[\|\nabla C\|_2^2] = \Theta(1). \quad (22)$$

In the Supplementary Material, we also show that global cost functions—i.e., those cost functions associated with high-weight Pauli observables—have all partial derivative variances exponentially vanishing in the number of qubits, and therefore also their gradients. Furthermore, in the Supplementary Material, we present numerical simulations that corroborate our findings and attempt to extend beyond the assumptions of our theorems, such as the assumption that two-qubit gates are sampled from a 2-design. We provide evidence that even for more restricted classes of ansätze, such as QAOA [94], the same qualitative behavior is observed.

3. *Improved upper bounds for barren plateaus in the unital noise scenario*

The technical tools developed in this work also allow us, in the unital-noise scenario, to improve upon the barren plateaus upper bounds presented in Ref. [20]. In particular, we establish the following.

**Proposition 11** (Improved upper bound on the partial derivative for unital noise). *Let  $C := \text{Tr}(P\Phi(\rho))$  be the cost function, where  $P$  is a Pauli,  $\rho$  is an arbitrary initial state, and  $\Phi$  is a random quantum circuit ansatz of depth  $L$  in arbitrary dimension. We assume that the noise is unital and not unitary. Let  $\mu$  denote a parameter of any 2-qubit gate  $\exp(-i\theta_\mu H_\mu)$  in the circuit such that  $\|H_\mu\|_\infty \leq 1$ . Then, we have*

$$\text{Var}[\partial_\mu C] \leq \exp(-\Omega(|P| + L)). \quad (23)$$

It is noteworthy that the upper bound of Ref. [20] has no dependence on the Pauli weight, unlike ours. Furthermore, the upper bound of Ref. [20] includes an  $n^{1/2}$  factor in front of the exponential decay in  $L$ , making it meaningful only at depths  $\Omega(\log(n))$ , whereas our result is without such a factor. Moreover, our result is more general than that shown in [20] because it extends to any unital noise, whereas the results shown in Ref. [20] apply only to primitive Pauli noise, which is only a particular type of unital noise (e.g., dephasing is not included in this class).

#### 4. Exponential concentration and lack thereof in noisy kernels

As a complementary result, we demonstrate how quantum kernels [78–80] exhibit a similar behavior to cost functions under the influence of non-unital noise. We show that fidelity quantum kernels [78–80] can incur an exponential concentration at any depth, whereas projected quantum kernels [78, 81] never exhibit exponential concentration. This stark discrepancy is analogous to that witnessed for global cost functions and local cost functions. In particular, assuming that the noise parameters satisfy  $\|\mathbf{t}\|_2^2 + \|\mathbf{D}\|_2^2 < 1$ , we show that

$$\mathbb{E}_{\Phi, \Phi'}[\text{Tr}[\Phi(\rho)\Phi'(\rho)]] \leq \exp(-\Omega(n)), \quad (24)$$

for any two noisy quantum circuits  $\Phi$  and  $\Phi'$ , where the expectation is taken over the random gates in both the circuits. This result follows by upper bounding the overlap of two states in terms of their purities by the Cauchy-Schwarz inequality, expanding the expected purities in the Pauli basis, and upper bounding the contribution of each Pauli by means of Theorem 6.

Furthermore, we are able to show worst-case concentration bounds by introducing an additional assumption on the noise model. In particular, we assume that the noise channel  $\tilde{\mathcal{N}}$  is the composition of the depolarizing channel  $\mathcal{N}_p^{(\text{dep})}$  with constant  $p > 0$  and an arbitrary noise channel with  $\|\mathbf{t}\|_2 < 1$ , i.e.,  $\tilde{\mathcal{N}} := \mathcal{N} \circ \mathcal{N}_p^{(\text{dep})}$ . Thus, we obtain that

$$\text{Tr}[\Phi(\rho)\Phi'(\rho)] \leq 2^{n(\delta_L - 1)}, \quad (25)$$

where  $\delta_L := (1 - p)^{2L} + \|\mathbf{t}\|_2^2 \frac{1 - (1 - p)^{2L}}{2p - p^2}$ .

We emphasize that, when the noise is purely depolarizing, i.e.  $\|\mathbf{t}\|_2 = 0$ , this bound predicts exponential concentration at any depth, thus improving a previous result given in Ref. [78], predicting exponential concentration at linear depth.

As for the projected quantum kernels [78, 81], we show the result

$$\text{Var}_{\Phi, \Phi'} \left[ \sum_{k=1}^n [\|\Phi_k(\rho) - \Phi'_k(\rho)\|_2^2] \right] \geq \Omega(n\|\mathbf{t}\|_2^4), \quad (26)$$

where  $\Phi_k(\rho) = \text{Tr}_{[n] \setminus \{k\}} \Phi(\rho)$ . We remark that the analysis of projected quantum kernels involves some additional assumptions on the families of random circuits, which are formally defined in Section D 2.

## II. Conclusions

Our work substantially advances our understanding of how quantum circuits—specifically, random quantum circuits—behave under possibly non-unital noise on several fronts, developing a comprehensive picture of the impact of noise. First, we have shown what we called the effective depth picture, establishing that most quantum circuits under non-unital noise behave like shallow circuits, no matter how deep they are. We have also shown that the output is essentially independent of the input state or the initial gates in the circuit. These statements have followed from various average contraction results.

We have then used our effective depth picture to argue that, in contrast to the noiseless and unital cases, in the presence of non-unital noise, variational quantum algorithms do not suffer from barren plateaus. This is a striking insight in its own right. But it is important to contextualize this result and not think that it is good news: Indeed,

we show that the lack of barren plateaus emerges from the fact that these circuits behave similarly to shallow circuits and that just the last few layers are trainable.

We have also used this fact to come up with a simple classical simulation algorithm for estimating Pauli expectation values of quantum circuits under non-unital noise, on average over the ensemble. Furthermore, we have shown that the algorithm is efficient for inverse-polynomial precision even for arbitrarily deep circuits in one-dimensional architectures, and for constant precision in any spatial dimensions. In short, a good way of summarizing our results is that we show that, unless we carefully exploit the structure of the noise affecting the quantum device, as long as we are interested in using a noisy quantum device to estimate Pauli expectation values, it is unlikely that one affected by local depolarizing noise is preferable over one with non-unital with a similar rate. The result can also be seen as an invitation to more carefully investigate the underlying noise to draw precise conclusions about the anticipated quantum application, and that overly simplified models can be misleading.

### Open problems

Our results invite a number of follow-up research questions. In particular, they leave open two important problems about random circuits with non-unital noise.

#### *Sampling from random quantum circuits under non-unital noise*

In Ref. [22], an algorithm has been presented to efficiently sample from random quantum circuits under local depolarizing noise of  $\Theta(\log(n))$  depth. However, the techniques outlined in Ref. [22] do not seem to be applicable under non-unital noise due to the fact that such circuits do not anticentralize, i.e., their output distribution never becomes sufficiently uniform [27]. In addition, unlike circuits with depolarizing noise [28, 95] or most circuits with other unital noise sources [96], non-unital noisy circuits do not converge to the maximally mixed state. Thus, the complexity of sampling from random quantum circuits with non-unital noise remains an interesting open question. See also the discussion related to this open question in Ref. [27]. Our work brings a new perspective that may provide new insights to address this fundamental open question. Specifically, our work suggests that random quantum circuits with non-unital noise behave effectively as logarithmic-depth noisy circuits—in particular, only the last  $O(\log(n))$  layers seem to matter. Moreover, Ref. [27] has shown that the outcome probability distribution of random quantum circuits under non-unital noise is never ‘too flat’, i.e., it is quite peaked. These results impose quite a lot of structure on such random circuits with non-unital noise—it seems that we are dealing with effective noisy random quantum circuits that are both shallow and peaked. Interestingly, it has recently been shown how to efficiently sample classically from two-dimensional (constant depth) shallow peaked circuits [97] – even though their definition of a distribution being ‘peaked’ is stronger than that used in Ref. [27], and their definition of a circuit being ‘shallow’ refers to a constant depth circuit, whereas for us, it refers to a logarithmic depth circuit. However, the algorithm proposed in Ref. [97] works for all circuits (worst-case scenario) – whereas in our case we only need an average case statement, since we consider random circuits, which could potentially simplify the problem due to the fact that we are asking to generate approximately correct samples ‘only’ with high probability over the ensemble and not in the worst case. That said, we leave to future work the rigorous exploration of whether the ideas developed in our work can be used to design such a classical sampling algorithm or to establish that the task is hard for classical computers.

#### *Estimating Pauli expectation values efficiently in arbitrary dimension within inverse-polynomial precision*

The classical algorithm we formulated in Section IB to estimate Pauli expectation values with precision  $O(1/\text{poly}(n))$  runs in polynomial time for 1-D architectures, but in quasipolynomial time for 2-D architectures. Other classical algorithms for estimating Pauli expectation values of constant depth quantum circuits [98] also run in quasi-polynomial time. It remains open whether we could construct a polynomial time algorithm to estimate, within inverse-polynomial precision, expectation values of local observables, under random circuits with non-unital noise, in 2-D. It must be also pointed out that our algorithm might be improved by use of more sophisticated techniques, like tensor network methods. Additionally, it also remains open whether the early break condition in Eq. (16) is met with high probability over the ensemble.

*Acknowledgements*

AAM thanks Lennart Bittel for useful discussions regarding the partial derivative lower bound. AAM and AA thank Marco Cerezo and Samson Wang for useful discussions on their previous work [20]. AA thanks Giacomo De Palma and Isabella Uta Meyer for discussions about channel distinguishability. SG thanks Bill Fefferman, Kunal Sharma, Michael Gullans, and Kohdai Kuroiwa for insightful discussions regarding the Heisenberg picture and optimization problems under noise. DSF acknowledges funding from the European Union under Grant Agreement 101080142 and the project EQUALITY. The Berlin team has been supported by the BMBF (DAQC, MUNIQC-Atoms), the Munich Quantum Valley (K-4 and K-8), the Quantum Flagship (PasQuans2, Millenion), QuantERA (HQCC), the Cluster of Excellence MATH+, the DFG (CRC183), the Einstein Foundation (Einstein Research Unit on Quantum Devices), and the ERC (DebuQC). AA acknowledges financial support from the QICS (Quantum Information Center Sorbonne).

- 
- [1] J. Preskill, Quantum computing in the NISQ era and beyond, *Quantum* **2**, 79 (2018).
- [2] J.-Y. Cai, Shor’s algorithm does not factor large integers in the presence of noise (2023), [arXiv:2306.10072](https://arxiv.org/abs/2306.10072).
- [3] Y. Kim, A. Eddins, S. Anand, K. X. Wei, E. van den Berg, S. Rosenblatt, H. Nayfeh, Y. Wu, M. Zaletel, K. Temme, and A. Kandala, Evidence for the utility of quantum computing before fault tolerance, *Nature* **618**, 500–505 (2023).
- [4] F. Arute *et al.*, Quantum supremacy using a programmable superconducting processor, *Nature* **574**, 505 (2019).
- [5] D. Bluvstein, S. J. Evered, A. A. Geim, S. H. Li, H. Zhou, T. Manovitz, S. Ebadi, M. Cain, M. Kalinowski, D. Hangleiter, J. P. Bonilla Ataides, N. Maskara, I. Cong, X. Gao, P. Sales Rodriguez, T. Karolyshyn, G. Semeghini, M. J. Gullans, M. Greiner, V. Vuletić, and M. D. Lukin, Logical quantum processor based on reconfigurable atom arrays, *Nature* **626**, 58–65 (2024).
- [6] Q. Zhu, S. Cao, F. Chen, M.-C. Chen, X. Chen, T.-H. Chung, H. Deng, Y. Du, D. Fan, M. Gong, C. Guo, C. Guo, S. Guo, L. Han, L. Hong, H.-L. Huang, Y.-H. Huo, L. Li, N. Li, S. Li, Y. Li, F. Liang, C. Lin, J. Lin, H. Qian, D. Qiao, H. Rong, H. Su, L. Sun, L. Wang, S. Wang, D. Wu, Y. Wu, Y. Xu, K. Yan, W. Yang, Y. Yang, Y. Ye, J. Yin, C. Ying, J. Yu, C. Zha, C. Zhang, H. Zhang, K. Zhang, Y. Zhang, H. Zhao, Y. Zhao, L. Zhou, C.-Y. Lu, C.-Z. Peng, X. Zhu, and J.-W. Pan, Quantum computational advantage via 60-qubit 24-cycle random circuit sampling, *Science Bulletin* **67**, 240 (2022).
- [7] L. S. Madsen, F. Laudenbach, M. F. Askarani, F. Rortais, T. Vincent, J. F. F. Bulmer, F. M. Miatto, L. Neuhaus, L. G. Helt, M. J. Collins, A. E. Lita, T. Gerrits, S. W. Nam, V. D. Vaidya, M. Menotti, I. Dhand, Z. Vernon, N. Quesada, and J. Lavoie, Quantum computational advantage with a programmable photonic processor, *Nature* **606**, 75 (2022).
- [8] D. Hangleiter and J. Eisert, Computational advantage of quantum random sampling, *Rev. Mod. Phys.* **95**, 035001 (2023).
- [9] F. Pan and P. Zhang, Simulating the Sycamore quantum supremacy circuits (2021), [arXiv:2103.03074](https://arxiv.org/abs/2103.03074).
- [10] J. F. F. Bulmer, B. A. Bell, R. S. Chadwick, A. E. Jones, D. Moise, A. Rigazzi, J. Thorbecke, U.-U. Haus, T. V. Vaerenbergh, R. B. Patel, I. A. Walmsley, and A. Laing, The boundary for quantum advantage in Gaussian boson sampling, *Science Adv.* **8**, eabl9236 (2022).
- [11] P. Clifford and R. Clifford, Faster classical boson sampling (2020), [arXiv:2005.04214](https://arxiv.org/abs/2005.04214).
- [12] X. Gao and L. Duan, Efficient classical simulation of noisy quantum computation (2018), [arXiv:1810.03176](https://arxiv.org/abs/1810.03176).
- [13] F. Pan and P. Zhang, Simulation of quantum circuits using the big-batch tensor network method, *Phys. Rev. Lett.* **128**, 030501 (2022).
- [14] K. Kechedzhi, S. Isakov, S. Mandrà, B. Villalonga, X. Mi, S. Boixo, and V. Smelyanskiy, Effective quantum volume, fidelity and computational cost of noisy quantum processing experiments, *Future Generation Computer Systems* **153**, 431–441 (2024).
- [15] T. Begušić and G. K.-L. Chan, Fast classical simulation of evidence for the utility of quantum computing before fault tolerance (2023), [arXiv:2306.16372](https://arxiv.org/abs/2306.16372).
- [16] H.-J. Liao, K. Wang, Z.-S. Zhou, P. Zhang, and T. Xiang, Simulation of IBM’s kicked Ising experiment with projected entangled pair operator (2023), [arXiv:2308.03082](https://arxiv.org/abs/2308.03082).
- [17] M. S. Rudolph, E. Fontana, Z. Holmes, and L. Cincio, Classical surrogate simulation of quantum systems with lowesa (2023), [arXiv:2308.09109](https://arxiv.org/abs/2308.09109).
- [18] T. Begušić, J. Gray, and G. K.-L. Chan, Fast and converged classical simulations of evidence for the utility of quantum computing before fault tolerance, *Science Adv.* **10**, eadk4321 (2024).
- [19] S. Patra, S. S. Jahromi, S. Singh, and R. Orus, Efficient tensor network simulation of IBM’s largest quantum processors (2023), [arXiv:2309.15642](https://arxiv.org/abs/2309.15642).
- [20] S. Wang, E. Fontana, M. Cerezo, K. Sharma, A. Sone, L. Cincio, and P. J. Coles, Noise-induced barren plateaus in variational quantum algorithms, *Nature Comm.* **12**, 6961 (2021).
- [21] M. Cerezo, A. Arrasmith, R. Babbush, S. C. Benjamin, S. Endo, K. Fujii, J. R. McClean, K. Mitarai, X. Yuan, L. Cincio, and P. J. Coles, Variational quantum algorithms, *Nature Rev. Phys.* **3**, 625 (2021).
- [22] D. Aharonov, X. Gao, Z. Landau, Y. Liu, and U. Vazirani, A polynomial-time classical algorithm for noisy random circuit sampling, in *Proceedings of the 55th Annual ACM Symposium on Theory of Computing*, STOC ’23 (ACM, 2023).
- [23] A. Kandala, A. Mezzcapo, K. Temme, M. Takita, M. Brink, J. W. Chow, and J. M. Gambetta, Hardware-efficient variational quantum eigensolver for small molecules and quantum magnets, *Nature* **549**, 242 (2017).

- [24] L. Chirulli and G. Burkard, Decoherence in solid-state qubits, *Adv. Phys.* **57**, 225 (2008).
- [25] J., M. Pino, J. M. Dreiling, C. Figgatt, J. P. Gaebler, S. A. Moses, M. S. All-man, C. H. Baldwin, M. Foss-Feig, D. Hayes, K. Mayer, C. Ryan-Anderson, and B. Neyenhuis, Demonstration of the trapped-ion quantum ccd computer architecture, *Nature* **592**, 209–213 (2021).
- [26] M. Ben-Or, D. Gottesman, and A. Hassidim, Quantum refrigerator (2013), [arXiv:1301.1995](https://arxiv.org/abs/1301.1995).
- [27] B. Fefferman, S. Ghosh, M. Gullans, K. Kuroiwa, and K. Sharma, Effect of non-unital noise on random circuit sampling (2023), [arXiv:2306.16659](https://arxiv.org/abs/2306.16659).
- [28] A. Müller-Hermes, D. Stilck França, and M. M. Wolf, Relative entropy convergence for depolarizing channels, *J. Math. Phys.* **57**, 022202 (2016).
- [29] C. King and M. Ruskai, Minimal entropy of states emerging from noisy quantum channels, *IEEE Trans. Inf. Th.* **47**, 192–209 (2001).
- [30] A. A. Mele, Introduction to Haar measure tools in quantum information: A beginner’s tutorial (2023), [arXiv:2307.08956v2](https://arxiv.org/abs/2307.08956v2).
- [31] D. Gross, K. Audenaert, and J. Eisert, Evenly distributed unitaries: On the structure of unitary designs, *J. Math. Phys.* **48**, 052104 (2007).
- [32] O. Fawzi, A. Müller-Hermes, and A. Shayeghi, A lower bound on the space overhead of fault-tolerant quantum computation, in *13th Innovations in Theoretical Computer Science Conference (ITCS 2022)* (Schloss Dagstuhl – Leibniz-Zentrum für Informatik, 2022).
- [33] Y. Quek, D. S. França, S. Khatri, J. J. Meyer, and J. Eisert, Exponentially tighter bounds on limitations of quantum error mitigation (2023), [arXiv:2210.11505](https://arxiv.org/abs/2210.11505).
- [34] D. Stilck França and R. García-Patrón, Limitations of optimization algorithms on noisy quantum devices, *Nature Phys.* **17**, 1221–1227 (2021).
- [35] G. De Palma, M. Marvian, D. Trevisan, and S. Lloyd, The quantum Wasserstein distance of order 1, *IEEE Trans. Inf. Th.* **67**, 6627 (2021).
- [36] S. Bravyi, A. Kliesch, R. Koenig, and E. Tang, Obstacles to variational quantum optimization from symmetry protection, *Phys. Rev. Lett.* **125**, 260505 (2020).
- [37] E. Farhi, D. Gamarnik, and S. Gutmann, The quantum approximate optimization algorithm needs to see the whole graph: Worst case examples (2020), [arXiv:2005.08747](https://arxiv.org/abs/2005.08747).
- [38] E. Farhi, D. Gamarnik, and S. Gutmann, The quantum approximate optimization algorithm needs to see the whole graph: A typical case (2020), [arXiv:2004.09002](https://arxiv.org/abs/2004.09002).
- [39] A. Anshu and T. Metger, Concentration bounds for quantum states and limitations on the QAOA from polynomial approximations, *Quantum* **7**, 999 (2023).
- [40] S. Bravyi, D. Gosset, and R. König, Quantum advantage with shallow circuits, *Science* **362**, 308–311 (2018).
- [41] A. B. Watts and N. Parham, Unconditional quantum advantage for sampling with shallow circuits (2024), [arXiv:2301.00995](https://arxiv.org/abs/2301.00995).
- [42] S. Bravyi, D. Gosset, R. König, and M. Tomamichel, Quantum advantage with noisy shallow circuits, *Nature Physics* **16**, 1040–1045 (2020).
- [43] J. R. McClean, S. Boixo, V. N. Smelyanskiy, R. Babbush, and H. Neven, Barren plateaus in quantum neural network training landscapes, *Nature Comm.* **9**, 4812 (2018).
- [44] Z. Holmes, K. Sharma, M. Cerezo, and P. J. Coles, Connecting ansatz expressibility to gradient magnitudes and barren plateaus, *PRX Quantum* **3**, 010313 (2022).
- [45] F. G. S. L. Brandão, A. W. Harrow, and M. Horodecki, Local random quantum circuits are approximate polynomial-designs, *Commun. Math. Phys.* **346**, 397 (2016).
- [46] M. Cerezo, A. Sone, T. Volkoff, L. Cincio, and P. J. Coles, Cost function dependent barren plateaus in shallow parametrized quantum circuits, *Nature Comm.* **12**, 1791 (2021).
- [47] A. Uvarov and J. D. Biamonte, On barren plateaus and cost function locality in variational quantum algorithms, *J. Phys. A* **54**, 245301 (2021).
- [48] J. Napp, Quantifying the barren plateau phenomenon for a model of unstructured variational ansätze (2022), [arXiv:2203.06174](https://arxiv.org/abs/2203.06174).
- [49] E. Grant, L. Wossnig, M. Ostaszewski, and M. Benedetti, An initialization strategy for addressing barren plateaus in parametrized quantum circuits, *Quantum* **3**, 214 (2019).
- [50] S. H. Sack, R. A. Medina, A. A. Michailidis, R. Kueng, and M. Serbyn, Avoiding barren plateaus using classical shadows, *PRX Quantum* **3**, 020365 (2022).
- [51] A. A. Mele, G. B. Mbeng, G. E. Santoro, M. Collura, and P. Torta, Avoiding barren plateaus via transferability of smooth solutions in a hamiltonian variational ansatz, *Phys. Rev. A* **106**, L060401 (2022).
- [52] M. S. Rudolph, J. Miller, D. Motlagh, J. Chen, A. Acharya, and A. Perdomo-Ortiz, Synergy between quantum circuits and tensor networks: Short-cutting the race to practical quantum advantage (2023), [arXiv:2208.13673](https://arxiv.org/abs/2208.13673).
- [53] N. Jain, B. Coyle, E. Kashefi, and N. Kumar, Graph neural network initialisation of quantum approximate optimisation, *Quantum* **6**, 861 (2022).
- [54] X. Shi and Y. Shang, Avoiding barren plateaus via Gaussian mixture model (2024), [arXiv:2402.13501](https://arxiv.org/abs/2402.13501).
- [55] L. Schatzki, M. Larocca, Q. T. Nguyen, F. Sauvage, and M. Cerezo, Theoretical guarantees for permutation-equivariant quantum neural networks (2022), [arXiv:2210.09974](https://arxiv.org/abs/2210.09974).
- [56] K. Zhang, M.-H. Hsieh, L. Liu, and D. Tao, Toward trainability of quantum neural networks (2020), [arXiv:2011.06258](https://arxiv.org/abs/2011.06258).
- [57] T. Volkoff and P. J. Coles, Large gradients via correlation in random parameterized quantum circuits, *Quant. Sc. Tech.* **6**, 025008 (2021).

- [58] A. Pesah, M. Cerezo, S. Wang, T. Volkoff, A. T. Sornborger, and P. J. Coles, Absence of barren plateaus in quantum convolutional neural networks, *Phys. Rev. X* **11**, 041011 (2021).
- [59] X. Liu, G. Liu, J. Huang, H.-K. Zhang, and X. Wang, Mitigating barren plateaus of variational quantum eigensolvers (2022), [arXiv:2205.13539](https://arxiv.org/abs/2205.13539).
- [60] J. J. Meyer, M. Mularski, E. Gil-Fuster, A. A. Mele, F. Arzani, A. Wilms, and J. Eisert, Exploiting symmetry in variational quantum machine learning, *PRX Quantum* **4**, 010328 (2023).
- [61] C.-Y. Park and N. Killoran, Hamiltonian variational ansatz without barren plateaus (2023), [arXiv:2302.08529](https://arxiv.org/abs/2302.08529).
- [62] M. Larocca, F. Sauvage, F. M. Sbahti, G. Verdon, P. J. Coles, and M. Cerezo, Group-invariant quantum machine learning, *PRX Quantum* **3**, 030341 (2022).
- [63] K. Zhang, L. Liu, M.-H. Hsieh, and D. Tao, Escaping from the barren plateau via gaussian initializations in deep variational quantum circuits, *Adv. Neur. Inf. Proc. Sys.* **35**, 18612 (2022).
- [64] C.-Y. Park, M. Kang, and J. Huh, Hardware-efficient ansatz without barren plateaus in any depth (2024), [arXiv:2403.04844](https://arxiv.org/abs/2403.04844).
- [65] M. Cerezo, M. Larocca, D. García-Martín, N. L. Diaz, P. Braccia, E. Fontana, M. S. Rudolph, P. Bermejo, A. Ijaz, S. Thanasilp, E. R. Anschuetz, and Z. Holmes, Does provable absence of barren plateaus imply classical simulability? or, why we need to rethink variational quantum computing (2023), [arXiv:2312.09121](https://arxiv.org/abs/2312.09121).
- [66] M. Schumann, F. K. Wilhelm, and A. Ciani, Emergence of noise-induced barren plateaus in arbitrary layered noise models (2023), [arXiv:2310.08405](https://arxiv.org/abs/2310.08405).
- [67] A. Sannia, F. Tacchino, I. Tavernelli, G. L. Giorgi, and R. Zambrini, Engineered dissipation to mitigate barren plateaus (2023), [arXiv:2310.15037](https://arxiv.org/abs/2310.15037).
- [68] D. Aharonov, M. Ben-Or, R. Impagliazzo, and N. Nisan, Limitations of noisy reversible computation (1996), [arXiv:quant-ph/9611028](https://arxiv.org/abs/quant-ph/9611028).
- [69] S. Boixo, S. V. Isakov, V. N. Smelyanskiy, R. Babbush, N. Ding, Z. Jiang, M. J. Bremner, J. M. Martinis, and H. Neven, Characterizing quantum supremacy in near-term devices, *Nature Phys.* **14**, 595 (2018).
- [70] A. Deshpande, P. Niroula, O. Shtanko, A. V. Gorshkov, B. Fefferman, and M. J. Gullans, Tight bounds on the convergence of noisy random circuits to the uniform distribution, *PRX Quantum* **3**, 040329 (2022).
- [71] A. W. Harrow and S. Mehraban, Approximate unitary t-designs by short random quantum circuits using nearest-neighbor and long-range gates, *Commun. Math. Phys.* **401**, 1531 (2023).
- [72] A. M. Dalzell, N. Hunter-Jones, and F. G. Brandão, Random quantum circuits anticentralize in log depth, *PRX Quantum* **3**, 010333 (2022).
- [73] S. Bravyi, D. Gosset, R. König, and M. Tomamichel, Quantum advantage with noisy shallow circuits, *Nature Phys.* **16**, 1040–1045 (2020).
- [74] E. Fontana, M. S. Rudolph, R. Duncan, I. Rungger, and C. Cirstoiu, Classical simulations of noisy variational quantum circuits (2023), [arXiv:2306.05400](https://arxiv.org/abs/2306.05400).
- [75] S. Bravyi, M. B. Hastings, and F. Verstraete, Lieb-Robinson Bounds and the generation of correlations and topological quantum order, *Phys. Rev. Lett.* **97**, 050401 (2006).
- [76] M. Schwarz, O. Buerschaper, and J. Eisert, Approximating local observables on projected entangled pair states, *Phys. Rev. A* **95**, 060102 (2017).
- [77] J. Borregaard, M. Christandl, and D. Stilck França, Noise-robust exploration of many-body quantum states on near-term quantum devices, *npj Quant. Inf.* **7**, 45 (2021).
- [78] S. Thanasilp, S. Wang, M. Cerezo, and Z. Holmes, Exponential concentration and untrainability in quantum kernel methods (2022), [arXiv:2208.11060](https://arxiv.org/abs/2208.11060).
- [79] S. Jerbi, L. J. Fiderer, H. Poulsen Nautrup, J. M. Kübler, H. J. Briegel, and V. Dunjko, Quantum machine learning beyond kernel methods, *Nature Comm.* **14**, 517 (2023).
- [80] M. Schuld and N. Killoran, Quantum machine learning in feature Hilbert spaces, *Phys. Rev. Lett.* **122**, 040504 (2019).
- [81] H.-Y. Huang, M. Broughton, M. Mohseni, R. Babbush, S. Boixo, H. Neven, and J. R. McClean, Power of data in quantum machine learning, *Nature Comm.* **12**, 2631 (2021).
- [82] S. Wang, E. Fontana, M. Cerezo, K. Sharma, A. Sone, L. Cincio, and P. J. Coles, Noise-induced barren plateaus in variational quantum algorithms, *Nature Comm.* **12**, 6961 (2021).
- [83] M. Beth Ruskai, S. Szarek, and E. Werner, An analysis of completely-positive trace-preserving maps on  $M_2$ , *Linear Algebra and its Applications* **347**, 159 (2002).
- [84] S. Chen, J. Cotler, H.-Y. Huang, and J. Li, The complexity of NISQ (2022), [arXiv:2210.07234](https://arxiv.org/abs/2210.07234).
- [85] A. M. Dalzell, N. Hunter-Jones, and F. G. S. L. Brandão, Random quantum circuits transform local noise into global white noise (2021), [arXiv:2111.14907](https://arxiv.org/abs/2111.14907).
- [86] However, for spatial dimension  $D > 1$ , if the depth is between  $O(\log(n)^{1/D})$  and  $O(\log(n))$ , to our knowledge it is not yet known whether there is an efficient classical simulation algorithm.
- [87] C. Hirche, C. Rouzé, and D. S. França, On contraction coefficients, partial orders and approximation of capacities for quantum channels, *Quantum* **6**, 862 (2022).
- [88] D. Gottesman, The Heisenberg representation of quantum computers (1998), [arXiv:quant-ph/9807006](https://arxiv.org/abs/quant-ph/9807006).
- [89] M. M. Wilde, *Quantum information theory* (Cambridge University Press, 2013).
- [90] A. A. Razborov, An upper bound on the threshold quantum decoherence rate (2003), [arXiv:quant-ph/0310136](https://arxiv.org/abs/quant-ph/0310136).
- [91] J. Kempe, O. Regev, F. Unger, and R. De Wolf, Upper bounds on the noise threshold for fault-tolerant quantum computing, in *International Colloquium on Automata, Languages, and Programming* (Springer, 2008) pp. 845–856.

- [92] C. Hirche, C. Rouzé, and D. S. França, Quantum differential privacy: An information theory perspective, *IEEE Trans. Inf. Th.* **69**, 5771 (2023).
- [93] J. R. McClean, S. Boixo, V. N. Smelyanskiy, R. Babbush, and H. Neven, Barren plateaus in quantum neural network training landscapes, *Nature Comm.* **9**, 4812 (2018).
- [94] E. Farhi, J. Goldstone, and S. Gutmann, A Quantum Approximate Optimization Algorithm (2014), [arXiv:1411.4028](https://arxiv.org/abs/1411.4028).
- [95] D. Aharonov and M. Ben-Or, Polynomial simulations of decohered quantum computers, in *Proceedings of 37th Conference on Foundations of Computer Science* (1996) pp. 46–55, [quant-ph/9611029](https://arxiv.org/abs/quant-ph/9611029).
- [96] A. Deshpande, P. Niroula, O. Shtanko, A. V. Gorshkov, B. Fefferman, and M. J. Gullans, Tight bounds on the convergence of noisy random circuits to the uniform distribution, *PRX Quantum* **3**, 040329 (2022).
- [97] S. Bravyi, D. Gosset, and Y. Liu, Classical simulation of peaked shallow quantum circuits (2023), [arXiv:2309.08405](https://arxiv.org/abs/2309.08405).
- [98] S. Bravyi, D. Gosset, and R. Movassagh, Classical algorithms for quantum mean values, *Nature Phys.* **17**, 337–341 (2021).
- [99] S. Aaronson and D. Gottesman, Improved simulation of stabilizer circuits, *Phys. Rev. A* **70**, 052328 (2004).
- [100] Z. Webb, The Clifford group forms a unitary 3-design (2016), [arXiv:1510.02769](https://arxiv.org/abs/1510.02769).
- [101] H. Zhu, R. Kueng, M. Grassl, and D. Gross, The Clifford group fails gracefully to be a unitary 4-design (2016), [arXiv:1609.08172](https://arxiv.org/abs/1609.08172).
- [102] R. Bhatia, *Positive definite matrices* (Princeton University Press, Princeton, 2007).
- [103] L. D. Landau and L. M. Lifshitz, *Quantum mechanics non-relativistic theory, third edition: Volume 3*, 3rd ed. (Butterworth-Heinemann, 1981).
- [104] S. Wang, P. Czarnik, A. Arrasmith, M. Cerezo, L. Cincio, and P. J. Coles, Can error mitigation improve trainability of noisy variational quantum algorithms? (2021), [arXiv:2109.01051](https://arxiv.org/abs/2109.01051).
- [105] G. E. Crooks, Gradients of parameterized quantum gates using the parameter-shift rule and gate decomposition (2019), [arXiv:1905.13311](https://arxiv.org/abs/1905.13311).
- [106] G. De Palma, M. Marvian, C. Rouzé, and D. S. França, Limitations of variational quantum algorithms: A quantum optimal transport approach, *PRX Quantum* **4**, 010309 (2023).
- [107] M. Mosonyi and F. Hiai, On the quantum renyi relative entropies and related capacity formulas (2010), [arXiv:0912.1286](https://arxiv.org/abs/0912.1286) [quant-ph].
- [108] M. Christandl and A. Müller-Hermes, Relative entropy bounds on quantum, private and repeater capacities, *Commun. Math. Phys.* **353**, 821 (2017).
- [109] R. Rubboli, R. Takagi, and M. Tomamichel, Mixed-state additivity properties of magic monotones based on quantum relative entropies for single-qubit states and beyond (2023), [arXiv:2307.08258](https://arxiv.org/abs/2307.08258).
- [110] Y. Liu, S. Arunachalam, and K. Temme, A rigorous and robust quantum speed-up in supervised machine learning, *Nature Phys.* **17**, 1013 (2021).
- [111] V. Havlíček, A. D. Córcoles, K. Temme, A. W. Harrow, A. Kandala, J. M. Chow, and J. M. Gambetta, Supervised learning with quantum-enhanced feature spaces, *Nature* **567**, 209 (2019).
- [112] M. Schuld, Supervised quantum machine learning models are kernel methods (2021), [arXiv:2101.11020](https://arxiv.org/abs/2101.11020).
- [113] S. Shalev-Shwartz and S. Ben-David, *Understanding machine learning: From theory to algorithms* (Cambridge university press, 2014).
- [114] C. L. Canonne, A short note on an inequality between KL and TV (2022), [arXiv:2202.07198](https://arxiv.org/abs/2202.07198).
- [115] A. Angrisani, M. Doosti, and E. Kashefi, A unifying framework for differentially private quantum algorithms (2023), [arXiv:2307.04733](https://arxiv.org/abs/2307.04733).



# Supplementary Material

## Contents

I. Introduction	1
1. Related works	2
2. Preliminaries and definitions	4
A. Noise-induced effective shallow circuits	5
B. Classical simulation of random quantum circuits with possibly non-unital noise	8
C. Lack of barren plateaus with non-unital noise, but only the last $\Theta(\log(n))$ layers matter	9
1. Lack of exponential concentration for local cost functions with non-unital noise	9
2. Lack of vanishing gradients for local cost functions, but only the last $\Theta(\log(n))$ layers are trainable	10
3. Improved upper bounds for barren plateaus in the unital noise scenario	10
4. Exponential concentration and lack thereof in noisy kernels	11
II. Conclusions	11
References	13
A. Preliminaries	18
1. Notation and basic definitions	18
2. Haar measure and unitary designs	19
a. Properties of layers of single-qubit random gates	21
3. Quantum channels	22
a. Pauli transfer matrix representation of a quantum channel	22
b. Normal form representation of a quantum channel	23
4. Circuit and noise model	25
B. Pauli expectation values of noisy random quantum circuits	28
1. Variance lower bound: Local expectation values with non-unital noise are not exponentially concentrated	29
2. Variance upper bound: Global expectation values are exponentially concentrated	31
3. Effective shallow circuits	32
4. Indistinguishability of quantum states affected by noisy quantum circuits	33
a. Worst-case upper bound on the trace distance	34
5. Classical simulation of Pauli expectation values of noisy random quantum circuits	36
C. Quantum machine learning under non-unital noise: Barren plateaus	40
1. Preliminaries on barren plateaus	40
2. Gradients: useful lemmas	42
3. Absence of barren plateaus, but only few layers are trainable	45
a. Partial derivative upper bound: Layers before the last $O(\log(n))$ are not trainable	46
b. Partial derivative lower bound: the last $\Theta(\log(n))$ layers are the only trainable	48
4. Improved upper bounds for unital noise	52
D. Purity and kernel methods under non-unital noise	54
1. Purity of average and worst-case circuits	54
2. Quantum machine learning under non-unital noise: Kernel methods	56
a. Fidelity quantum kernels: Exponential concentration at any depth	57
b. Projected quantum kernels: Absence of exponential concentration at any depth	58
E. Miscellaneous	59
1. Trace distance decay for worst-case circuits under local depolarizing noise	60
2. Numerical simulations	61

## A. Preliminaries

### 1. Notation and basic definitions

Throughout this work, we employ the following notation and conventions.

- $\mathcal{L}(\mathbb{C}^d)$  denotes the set of linear operators that act on the  $d$ -dimensional complex vector space  $\mathbb{C}^d$ .
- The *unitary group*, denoted as  $U(d)$ , comprises operators  $U \in \mathcal{L}(\mathbb{C}^d)$  satisfying  $U^\dagger U = I$ , with  $I$  representing the identity operator. Additionally, we use  $[d]$  to represent the set of integers from 1 to  $d$ , i.e.,  $[d] := \{1, \dots, d\}$ .
- Given a vector  $v \in \mathbb{C}^d$  and a value  $p \in [1, \infty]$ , we denote the  $p$ -norm of  $v$  as  $\|v\|_p$ , defined as

$$\|v\|_p := \left( \sum_{i=1}^d |v_i|^p \right)^{1/p}.$$

- **Norms:** For a matrix  $A \in \mathcal{L}(\mathbb{C}^d)$ , its *Schatten  $p$ -norm* is  $\|A\|_p := \text{Tr}((\sqrt{A^\dagger A})^p)^{1/p}$ , corresponding to the  $p$ -norm of the vector of singular values of  $A$ .

The trace norm and Hilbert-Schmidt norm, specific instances of Schatten  $p$ -norms, are, respectively, denoted as  $\|\cdot\|_1$  and  $\|\cdot\|_2$ .

The infinity norm,  $\|\cdot\|_\infty$ , of a matrix is the maximum singular value, which is equal to the limit of the Schatten  $p$ -norm as  $p$  approaches infinity.

The Hilbert-Schmidt norm arises from the scalar product  $\langle A, B \rangle_{HS} := \text{Tr}(A^\dagger B)$  for  $A, B \in \mathcal{L}(\mathbb{C}^d)$ .

The *Hölder inequality*,  $|\langle A, B \rangle_{HS}| \leq \|A\|_p \|B\|_q$ , holds for  $1 \leq p, q \leq \infty$  such that  $p^{-1} + q^{-1} = 1$ .

For all matrices  $A$  and  $1 \leq p \leq q$ , we have  $\|A\|_q \leq \|A\|_p$  and  $\|A\|_p \leq \text{rank}(A)^{(p^{-1}-q^{-1})} \|A\|_q$ . In particular, we have that  $\|A\|_1 \leq \sqrt{d} \|A\|_2$ .

- **Quantum states:** The set of density matrices (*quantum states*) is

$$\mathcal{S}(\mathbb{C}^d) := \{\rho \in \mathcal{L}(\mathbb{C}^d) : \rho \geq 0, \text{Tr}(\rho) = 1\}.$$

We adopt the bra-ket notation, denoting a vector  $v \in \mathbb{C}^d$  as  $|v\rangle$  and its adjoint as  $\langle v|$ . A vector  $|\psi\rangle \in \mathbb{C}^d$  is a (pure) state vector if  $\| |\psi\rangle \|_2 = 1$ . The canonical basis of  $\mathbb{C}^d$  is  $\{|i\rangle\}_{i=1}^d$ , and the non-normalized maximally entangled state vector is given by  $|\Omega\rangle := \sum_{i=1}^d |i\rangle \otimes |i\rangle = \sum_{i=1}^d |i, i\rangle$ .

- Given an element of  $A \in \mathcal{L}(\mathbb{C}^{d_1} \otimes \mathbb{C}^{d_2})$ , we indicate with  $\text{Tr}_1(A)$  the partial trace of  $A$  with respect the first subsystem, and similarly for  $\text{Tr}_2(A)$ , for partial trace of  $A$  with respect the second subsystem.
- When addressing a system of  $n$  qubits, we use  $I$  to denote the identity operator on the Hilbert space  $\mathbb{C}^2$  of one qubit, while  $I_n = I^{\otimes n}$  denotes the identity on the Hilbert space of  $n$  qubits.
- **Pauli basis:** Let  $d = 2^n$ , where  $n \in \mathbb{N}$ . Elements of the Pauli basis  $\{I, X, Y, Z\}^{\otimes n}$  are Hermitian, unitary, traceless, they square to the identity and they are orthogonal to each other with respect the Hilbert-Schmidt Scalar product. The Pauli basis forms an orthogonal basis for the linear operators  $\mathcal{L}(\mathbb{C}^d)$ . We denote  $\sigma := (X, Y, Z)$  the vector of single qubit Pauli matrices.

Given  $P \in \{I, X, Y, Z\}^{\otimes n}$  such that  $P = Q_1 \otimes \dots \otimes Q_n$ , we define  $[P]$  the set  $[P] := \{Q_1, \dots, Q_n\}$ .

- **Support:** We define the *support of  $P \in \{I, X, Y, Z\}^{\otimes n}$*  as the set of integers containing the non-identity terms in  $[P]$ , i.e.,

$$\text{supp}(P) := \{i \in [n] : Q_i \in [P] \text{ and } Q_i \neq I\}.$$

For example,  $\text{supp}(X \otimes I \otimes Y) = \{1, 3\}$ .

Similarly, if  $H$  is an operator expressed in the Pauli basis as  $H = \sum_{i=1}^M c_i P_i$ , where  $\{c_i\}_{i=1}^M$  are real non-zero numbers, and  $\{P_i\}_{i=1}^M$  are elements of the Pauli basis, then

$$\text{supp}(H) := \bigcup_{i=1}^M \text{supp}(P_i). \quad (\text{A1})$$

- **Pauli weight:** The *Pauli-weight* of  $P$ , denoted as  $|P|$ , is the number of Pauli in the tensor product decomposition of  $P$  different from  $I$ , namely  $|P| := |\text{supp}(P)|$ . For example  $|X \otimes I \otimes Y| = |\{1, 3\}| = 2$ . The Pauli- $X$  weight of  $P$ , denoted as  $|P|_X$ , corresponds to the number of Pauli- $X$  operators in the tensor-product decomposition of  $P$ . Similarly, the Pauli- $Y$  weight of  $P$ , denoted as  $|P|_Y$ , represents the number of Pauli- $Y$  operators in the decomposition of  $P$ . Analogously, the Pauli- $Z$  weight is denoted as  $|P|_Z$ .
- **Locality of an observable:** The *locality* of a Hermitian operator  $H$  is defined as  $|\text{supp}(H)|$ .
- **Light cone:** The light-cone of a Hermitian operator  $H$  with respect to a linear map  $\Phi$  is defined as

$$\text{Light}(\Phi, H) := \text{supp}(\Phi^*(H)), \quad (\text{A2})$$

where  $\Phi^*$  denotes the adjoint of  $\Phi$  with respect the Hilbert-Schmidt scalar product.

- **Asymptotic notation:** Big-O Notation: For a function  $f(n)$ , if there exists a constant  $c$  and a specific input size  $n_0$  such that  $f(n) \leq c \cdot g(n)$  for all  $n \geq n_0$ , where  $g(n)$  is a well-defined function, then we express it as  $f(n) = O(g(n))$ . This notation signifies the upper limit of how fast a function grows in relation to  $g(n)$ .

Big-Omega Notation: For a function  $f(n)$ , if there exists a constant  $c$  and a specific input size  $n_0$  such that  $f(n) \geq c \cdot g(n)$  for all  $n \geq n_0$ , where  $g(n)$  is a well-defined function, then we express it as  $f(n) = \Omega(g(n))$ . This notation signifies the lower limit of how fast a function grows in relation to  $g(n)$ .

Big-Theta Notation: For a function  $f(n)$ , if  $f(n) = O(g(n))$  and if  $f(n) = \Omega(g(n))$ , where  $g(n)$  is a well-defined function, then we express it as  $f(n) = \Theta(g(n))$ .

Little-Omega Notation: For a function  $f(n)$ , if for any constant  $c$ , there exists an input size  $n_0$  such that  $f(n) > c \cdot g(n)$  for all  $n \geq n_0$ , where  $g(n)$  is a well-defined function, then then we express it as  $f(n) = \omega(g(n))$ . This notation implies that the function grows strictly faster than the provided lower bound.

## 2. Haar measure and unitary designs

In the following, for our proofs it will be useful to have some familiarity with the Haar measure, which formalizes the notion of uniform distribution over unitaries. For a more detailed explanation we refer to Ref. [30] – here we state a few crucial properties that will be useful later on. We define as the *Haar measure*  $\mu_H(\text{U}(d))$  the (unique) probability distribution over the unitary group  $\text{U}(d)$  which is left and right invariant, which means that for any integrable function  $f$ , we have

$$\mathbb{E}_{U \sim \mu_H} [f(U)] = \mathbb{E}_{U \sim \mu_H} [f(UV)] = \mathbb{E}_{U \sim \mu_H} [f(VU)], \quad (\text{A3})$$

for any  $U, V \in \text{U}(d)$ . In the last equation, we have used  $\mu_H \equiv \mu_H(\text{U}(d))$ , that is, we omitted to specify the group  $\text{U}(d)$ , and we will do the same in subsequent sections. Moreover, it holds that

$$\mathbb{E}_{U \sim \mu_H} [f(U)] = \mathbb{E}_{U \sim \mu_H} [f(U^\dagger)]. \quad (\text{A4})$$

### Useful relations

We define the *identity*  $\mathbb{I}$  and the *flip operator*  $\mathbb{F}$ , also known as the permutation operators associated to a tensor product of two Hilbert spaces, as

$$\mathbb{I} := \sum_{i,j=1}^d |i, j\rangle\langle i, j|, \quad \mathbb{F} := \sum_{i,j=1}^d |i, j\rangle\langle j, i|. \quad (\text{A5})$$

From this definition, it can be observed that they satisfy

$$\mathbb{I}(|\psi\rangle \otimes |\phi\rangle) = |\psi\rangle \otimes |\phi\rangle, \quad \mathbb{F}(|\psi\rangle \otimes |\phi\rangle) = |\phi\rangle \otimes |\psi\rangle, \quad (\text{A6})$$

for all  $|\psi\rangle, |\phi\rangle \in \mathbb{C}^d$ . Useful properties of the flip operator are the *swap-trick* and the *partial-swap-trick*

$$\text{Tr}(A \otimes B\mathbb{F}) = \text{Tr}(AB), \quad \text{Tr}_2(A \otimes B\mathbb{F}) = AB, \quad (\text{A7})$$

equalities that can be easily verified in terms of tensor network diagrams.

Let  $n$  now be the number of qubits in a system. If  $d = 2^n$ , then the flip operator can be written in terms of the Pauli basis as

$$\mathbb{F} = \frac{1}{d} \sum_{P \in \{I, X, Y, Z\}^{\otimes n}} P \otimes P, \quad (\text{A8})$$

where we have used the fact that the Pauli basis is an orthogonal basis and the *swap-trick*.

Two formulas, involving expected values over the Haar measure and permutation operators, will be crucial in our proofs. Given  $O \in \mathcal{L}(\mathbb{C}^d)$ , we have the so called *first-moment formula*, given by

$$\mathbb{E}_{U \sim \mu_H} [UOU^\dagger] = \frac{\text{Tr}(O)}{d} I. \quad (\text{A9})$$

Given  $O \in \mathcal{L}((\mathbb{C}^d)^{\otimes 2})$ , we have the second-moment formula

$$\mathbb{E}_{U \sim \mu_H} [U^{\otimes 2} O U^{\dagger \otimes 2}] = c_{\mathbb{I}, O} \mathbb{I} + c_{\mathbb{F}, O} \mathbb{F}, \quad (\text{A10})$$

where

$$c_{\mathbb{I}, O} = \frac{\text{Tr}(O) - d^{-1} \text{Tr}(\mathbb{F}O)}{d^2 - 1} \quad \text{and} \quad c_{\mathbb{F}, O} = \frac{\text{Tr}(\mathbb{F}O) - d^{-1} \text{Tr}(O)}{d^2 - 1}. \quad (\text{A11})$$

(see Ref. [30] for a proof of the previous two equations). A probability distribution over unitaries  $\nu$  is defined to be a *k-design* [31], for  $k \in \mathbb{N}$ , if and only if

$$\mathbb{E}_{U \sim \mu_H} [U^{\otimes k} O U^{\dagger \otimes k}] = \mathbb{E}_{V \sim \nu} [V^{\otimes k} O V^{\dagger \otimes k}]. \quad (\text{A12})$$

If the distribution  $\nu$  is a  $(k+1)$ -design, then it is also a  $k$ -design. An important set of unitaries which will be useful in our work is the Clifford group [88].

**Definition 12** (Clifford group [88, 99]). *The Clifford group  $\text{Cl}(n)$  is the set of unitaries which sends the Pauli group  $\mathcal{P}_n := \{i^k\}_{k=0}^3 \times \{I, X, Y, Z\}^{\otimes n}$  in itself under the adjoint operation:*

$$\text{Cl}(n) := \{U \in \text{U}(2^n) : UPU^\dagger \in \mathcal{P}_n \text{ for all } P \in \{I, X, Y, Z\}^{\otimes n}\}. \quad (\text{A13})$$

and it is equivalent to the set of unitaries generated by  $\{H, \text{CNOT}, S\}$  where  $H$ ,  $\text{CNOT}$ , and  $S$  are, respectively, the Hadamard, Controlled-NOT, and Phase gates.

We make extensive use of the following seminal result throughout our work.

**Lemma 13** (Clifford group is a 2-design [100, 101]). *The uniform distribution over the Clifford group  $\text{Cl}(n)$  is a 2-design.*

The Clifford group is actually also a 3-design [100, 101], but in our work we need only its 2-design property. Now, we state an important formula – the Pauli mixing formula – that we use in many of the proofs.

**Lemma 14** (Pauli mixing). *Let  $d = 2^n$  and consider  $\nu$  to be a 2-design distribution. If  $P_1, P_2 \in \{I, X, Y, Z\}^{\otimes n}$  are elements of the Pauli basis, then*

$$\mathbb{E}_{U \sim \nu} [U^{\otimes 2} (P_1 \otimes P_2) U^{\dagger \otimes 2}] = \delta_{P_1, P_2} \mathbb{E}_{U \sim \nu} [U^{\otimes 2} (P_1 \otimes P_1) U^{\dagger \otimes 2}] \quad (\text{A14})$$

$$= \begin{cases} I \otimes I & \text{if } P_1 = P_2 = I, \\ \frac{1}{d^2 - 1} \sum_{P \in \{I, X, Y, Z\}^{\otimes n} \setminus I_n} P \otimes P & \text{if } P_1 = P_2 \neq I, \\ 0 & \text{if } P_1 \neq P_2. \end{cases} \quad (\text{A15})$$

This can be shown using the second-moment formula previously introduced and the decomposition of the flip operator in terms of the Pauli basis.

a. *Properties of layers of single-qubit random gates*

In our work, frequent calculations involve averages over the tensor product of single-qubit 2-design gates. To facilitate these calculations, we introduce two Lemmas that will be instrumental in later sections of our work.

**Lemma 15** (A layer of 1-qubit Haar random gates is a global 1-design). *Let  $\nu$  be a distribution over the tensor product of single-qubit 1-design gates, namely over unitaries  $U$  of the form  $U = \bigotimes_{i=1}^n u_i$ , where  $u_i$  is a single-qubit unitary acting on the  $i$ -th qubit. Then,  $\nu$  is a  $n$ -qubit 1-design.*

*Proof.* Let  $O \in \mathcal{L}(\mathbb{C}^d)$  with  $d = 2^n$ . By writing it in the Pauli basis, we have

$$\mathbb{E}_{U \sim \nu} [UOU^\dagger] = \frac{1}{d} \sum_{P \in \{I, X, Y, Z\}^{\otimes n}} \text{Tr}(OP) \mathbb{E}_{U \sim \nu} [UPU^\dagger] = \frac{\text{Tr}(O)}{d} I_n, \quad (\text{A16})$$

where in the last equality we have used the first-moment formula (Eq. (A9)) on each of the qubits and used that the Pauli are trace-less.  $\square$

As a consequence of the Pauli mixing property, we have the following lemma.

**Lemma 16** (Second moments of single-qubit random gates layers). *Let  $\nu$  be a distribution over the tensor product of single-qubit 2-design gates, namely over unitaries  $U$  of the form  $U = \bigotimes_{i=1}^n u_i$ , where  $u_i$  is a single-qubit unitary acting on the  $i$ -th qubit. Let  $\rho$  be any quantum state. Then we have*

1. Let  $O := \sum_{P \in \{I, X, Y, Z\}^{\otimes n}} a_P P$ , with  $a_P \in \mathbb{R}$  for any  $P \in \{I, X, Y, Z\}^{\otimes n}$ . We have

$$\mathbb{E}_{U \sim \nu} [\text{Tr}(OU\rho U^\dagger)^2] = \sum_{P \in \{I, X, Y, Z\}^{\otimes n}} a_P^2 \mathbb{E}_{U \sim \nu} [\text{Tr}(PU\rho U^\dagger)^2]. \quad (\text{A17})$$

2. For any  $P \in \{I, X, Y, Z\}^{\otimes n}$ , we have

$$\mathbb{E}_{U \sim \nu} [\text{Tr}(PU\rho U^\dagger)^2] = \frac{1}{3^{|P|}} \sum_{\substack{Q \in \{I, X, Y, Z\}^{\otimes n}; \\ \text{supp}(Q) = \text{supp}(P)}} \text{Tr}(Q\rho)^2. \quad (\text{A18})$$

*Proof.* We have

$$\begin{aligned} \mathbb{E}_{U \sim \nu} [\text{Tr}(OU\rho U^\dagger)^2] &= \mathbb{E}_{U \sim \nu} [\text{Tr}(O^{\otimes 2} U^{\otimes 2} \rho^{\otimes 2} U^{\dagger \otimes 2})] \\ &= \sum_{P, Q \in \{I, X, Y, Z\}^{\otimes n}} a_P a_Q \mathbb{E}_{U \sim \nu} [\text{Tr}((P \otimes Q) U^{\otimes 2} \rho^{\otimes 2} U^{\dagger \otimes 2})] \\ &= \sum_{P, Q \in \{I, X, Y, Z\}^{\otimes n}} a_P a_Q \mathbb{E}_{U \sim \nu} [\text{Tr}(U^{\dagger \otimes 2} (P \otimes Q) U^{\otimes 2} \rho^{\otimes 2})] \\ &= \sum_{P \in \{I, X, Y, Z\}^{\otimes n}} a_P^2 \mathbb{E}_{U \sim \nu} [\text{Tr}(U^{\dagger \otimes 2} (P \otimes P) U^{\otimes 2} \rho^{\otimes 2})] \\ &= \sum_{P \in \{I, X, Y, Z\}^{\otimes n}} a_P^2 \mathbb{E}_{U \sim \nu} [\text{Tr}(PU\rho U^\dagger)^2], \end{aligned} \quad (\text{A19})$$

where for the fourth equality we have used the fact that  $U = \bigotimes_{i=1}^n u_i$  is a layer of single-qubit 2-design unitaries,

$$\mathbb{E}_{U \sim \mu_H} [f(U)] = \mathbb{E}_{U \sim \mu_H} [f(U^\dagger)] \quad (\text{A20})$$

for any measurable function  $f$ , and the Pauli mixing property in Eq. (A14) for each of the single-qubit unitaries to conclude that  $\mathbb{E}_{u_i \sim \mu_H} [u_i^{\otimes 2} (P_1 \otimes P_2) u_i^{\dagger \otimes 2}] = 0$  for two different single-qubit Pauli  $P_1$  and  $P_2$ .

Similarly, for  $P \in \{I, X, Y, Z\}^{\otimes n}$  such that  $P = P_1 \otimes P_2 \otimes \dots \otimes P_n$ , we use the Pauli-mixing property in Eq. (A15), along with the fact that  $U = \bigotimes_{i=1}^n u_i$  is a tensor product of single-qubit unitaries from a 2-design, to obtain

$$\mathbb{E}_{U \sim \nu} [\text{Tr}(PU\rho U^\dagger)^2] = \mathbb{E}_{U \sim \nu} [\text{Tr}(U^{\dagger \otimes 2} (P \otimes P) U^{\otimes 2} \rho^{\otimes 2})] \quad (\text{A21})$$

$$\begin{aligned}
&= \text{Tr} \left( \mathbb{E}_{U \sim \nu} \left[ \bigotimes_{i=1}^n u_i^{\otimes 2}(P_i \otimes P_i) u_i^{\dagger \otimes 2} \right] \rho^{\otimes 2} \right) \\
&= \text{Tr} \left( \mathbb{E}_{U \sim \nu} \left[ \bigotimes_{i \in \text{supp}(P)} u_i^{\otimes 2}(P_i \otimes P_i) u_i^{\dagger \otimes 2} \right] \rho^{\otimes 2} \right) \\
&= \text{Tr} \left( \left( \bigotimes_{i \in \text{supp}(P)} \frac{1}{3} \sum_{Q_i \in \{X, Y, Z\}} Q_i \otimes Q_i \right) \rho^{\otimes 2} \right) \\
&= \frac{1}{3^{|\text{P}|}} \sum_{\substack{Q \in \{I, X, Y, Z\}^{\otimes n}; \\ \text{supp}(Q) = \text{supp}(P)}} \text{Tr}(Q^{\otimes 2} \rho^{\otimes 2}),
\end{aligned}$$

which is the desired result, because  $\text{Tr}(Q^{\otimes 2} \rho^{\otimes 2}) = \text{Tr}(Q\rho)^2$ .  $\square$

### 3. Quantum channels

A *quantum channel*  $\mathcal{N} : \mathcal{L}(\mathbb{C}^d) \rightarrow \mathcal{L}(\mathbb{C}^d)$  is a linear, completely positive, and trace-preserving map. Completely positive means that for all positive operators  $\sigma \in \mathcal{L}(\mathbb{C}^d \otimes \mathbb{C}^D)$ , for any  $D \in \mathbb{N}$ , the operator  $(\mathcal{N} \otimes \mathcal{I})(\sigma)$  is positive. The trace-preserving property means that  $\text{Tr}(\mathcal{N}(A)) = \text{Tr}(A)$  for any  $A \in \mathcal{L}(\mathbb{C}^d)$ . Here,  $\mathcal{I} : \mathcal{L}(\mathbb{C}^D) \rightarrow \mathcal{L}(\mathbb{C}^D)$  denotes the identity map. Any quantum channel  $\mathcal{N}$  can be represented in terms of at most  $d^2$  Kraus operators  $\{K_i\}_{i=1}^{d^2}$ , i.e.,

$$\mathcal{N}(\cdot) = \sum_{i=1}^{d^2} K_i(\cdot) K_i^\dagger, \quad (\text{A22})$$

with the condition  $\sum_{i=1}^{d^2} K_i^\dagger K_i = I$  to satisfy trace-preservation. Given a quantum channel  $\mathcal{N}$ , we say that  $\mathcal{N}$  is *unital* if and only if it maps the identity operator to the identity operator, i.e.,  $\mathcal{N}(I) = I$ . Otherwise, we say that  $\mathcal{N}$  is *non-unital*. Given a quantum channel  $\mathcal{N} : \mathcal{L}(\mathbb{C}^d) \rightarrow \mathcal{L}(\mathbb{C}^d)$ , its adjoint map  $\mathcal{N}^* : \mathcal{L}(\mathbb{C}^d) \rightarrow \mathcal{L}(\mathbb{C}^d)$  is defined as the linear map such that

$$\langle \mathcal{N}^*(A), B \rangle_{HS} = \langle A, \mathcal{N}(B) \rangle_{HS} \quad (\text{A23})$$

for any  $A, B \in \mathcal{L}(\mathbb{C}^d)$ . If  $\{K_i\}_{i=1}^{d^2}$  is a set of Kraus operators for  $\mathcal{N}$ , then the adjoint channel  $\mathcal{N}^*$  can be expressed as

$$\mathcal{N}^*(\cdot) = \sum_{i=1}^{d^2} K_i^\dagger(\cdot) K_i. \quad (\text{A24})$$

Note that  $\mathcal{N}^*$  is always unital,  $\mathcal{N}^*(I) = I$ , inherited from the property of the channel being trace-preserving. However the adjoint is not necessarily trace-preserving: it holds that  $\mathcal{N}^*$  is trace preserving if and only if  $\mathcal{N}$  is unital. If the Kraus operators of the quantum channel  $\mathcal{N}$  are Hermitian, then the adjoint channel coincides with the quantum channel  $\mathcal{N}^* = \mathcal{N}$ . If  $\mathcal{N}_1, \mathcal{N}_2$  are two quantum channels, then  $(\mathcal{N}_1 \circ \mathcal{N}_2)^* = \mathcal{N}_2^* \circ \mathcal{N}_1^*$ . Moreover  $(\mathcal{N}_1 \otimes \mathcal{N}_2)^* = \mathcal{N}_1^* \otimes \mathcal{N}_2^*$ . For any Hermitian operator  $O$ , we have [102]

$$\|\mathcal{N}^*(O)\|_\infty \leq \|O\|_\infty. \quad (\text{A25})$$

#### a. Pauli transfer matrix representation of a quantum channel

In this subsection, we introduce the Pauli transfer matrix representation of a single-qubit quantum channel. Let  $\mathcal{N} : \mathcal{L}(\mathbb{C}^2) \rightarrow \mathcal{L}(\mathbb{C}^2)$  be a linear map. Any linear map can be expressed in terms of its action on the Pauli basis, i.e.

$$\mathcal{N}(P) = \sum_{Q \in \{I, X, Y, Z\}} T_{Q,P} Q, \quad (\text{A26})$$

where  $T_{Q,P} := \frac{1}{2} \text{Tr}(Q\mathcal{N}(P))$ . Assuming that  $\mathcal{N}$  represents a quantum channel, it inherently preserves Hermiticity, implying that  $T_{Q,P} \in \mathbb{R}$ . Furthermore, by employing the *Hölder inequality*, we establish that  $|T_{Q,P}| \leq 1$  for all  $P, Q \in \{I, X, Y, Z\}$ . Given that a quantum channel is trace-preserving and the Pauli matrices are all trace-less except for the identity, we deduce that  $T_{I,P} = \delta_{I,P}$ . Consequently, we have

$$\mathcal{N}(I) = I + T_{X,I}X + T_{Y,I}Y + T_{Z,I}Z, \quad (\text{A27})$$

$$\mathcal{N}(X) = T_{X,X}X + T_{Y,X}Y + T_{Z,X}Z, \quad (\text{A28})$$

$$\mathcal{N}(Y) = T_{X,Y}X + T_{Y,Y}Y + T_{Z,Y}Z, \quad (\text{A29})$$

$$\mathcal{N}(Z) = T_{X,Z}X + T_{Y,Z}Y + T_{Z,Z}Z. \quad (\text{A30})$$

From Eqs. (A27)-(A30), we can see that considering a non-unital noise channel is equivalent to assuming that at least one of the parameters  $T_{X,I}$ ,  $T_{Y,I}$ , or  $T_{Z,I}$  must be non-zero.

We define the Pauli transfer matrix  $\mathbb{T}(\mathcal{N})$  of the channel  $\mathcal{N}$  as the matrix with components defined as  $[\mathbb{T}(\mathcal{N})]_{Q,P} := \frac{1}{2} \text{Tr}(Q\mathcal{N}(P)) = T_{Q,P}$  for all  $Q, P \in \{I, X, Y, Z\}$ , i.e.,

$$\mathbb{T}(\mathcal{N}) = \begin{bmatrix} 1 & 0 & 0 & 0 \\ T_{X,I} & T_{X,X} & T_{X,Y} & T_{X,Z} \\ T_{Y,I} & T_{Y,X} & T_{Y,Y} & T_{Y,Z} \\ T_{Z,I} & T_{Z,X} & T_{Z,Y} & T_{Z,Z} \end{bmatrix}. \quad (\text{A31})$$

It is important to note that any single-qubit quantum channel can be expressed in such a form. However, not every linear map of this form represents a valid quantum channel. Furthermore, utilizing the definition of the adjoint map, we can easily verify that the adjoint map  $\mathcal{N}^*$  is given by  $\mathcal{N}^*(P) = \sum_{Q \in \{I, X, Y, Z\}} T_{P,Q}Q$ . This results in the fact that the Pauli transfer matrix of the adjoint channel is the transpose of the Pauli transfer matrix of the channel, i.e.,

$$\mathbb{T}(\mathcal{N}^*) = \mathbb{T}(\mathcal{N})^T. \quad (\text{A32})$$

Given two quantum channels  $\mathcal{N}^{(A)}$  and  $\mathcal{N}^{(B)}$ , we have that the Pauli transfer matrix associated to their composition is given by the multiplication of their Pauli transfer matrices:

$$\mathbb{T}(\mathcal{N}^{(A)} \circ \mathcal{N}^{(B)}) = \mathbb{T}(\mathcal{N}^{(A)}) \cdot \mathbb{T}(\mathcal{N}^{(B)}). \quad (\text{A33})$$

### b. Normal form representation of a quantum channel

We now present a quantum channel representation [29, 83] that will be useful when dealing with noisy random circuits. In words, it says that the Pauli transfer matrix of a single-qubit noise channel, up to unitary rotations, is diagonal in the sub-block corresponding to the non-identity Pauli matrices. We include here the lemma and proof of this representation for easy reference.

**Lemma 17** (Normal form of a quantum channel [29, 83]). *Any single-qubit quantum channel  $\mathcal{N}$  can be written in the so called ‘normal’ form:*

$$\mathcal{N}(\cdot) = U\mathcal{N}'(V^\dagger(\cdot)V)U^\dagger, \quad (\text{A34})$$

where  $U, V$  are unitaries and  $\mathcal{N}'(\cdot)$  is a quantum channel with Pauli transfer matrix

$$\mathbb{T}(\mathcal{N}') = \begin{bmatrix} 1 & 0 & 0 & 0 \\ t_X & D_X & 0 & 0 \\ t_Y & 0 & D_Y & 0 \\ t_Z & 0 & 0 & D_Z \end{bmatrix}, \quad (\text{A35})$$

where  $\mathbf{t} := (t_X, t_Y, t_Z)$  and  $\mathbf{D} := (D_X, D_Y, D_Z) \in \mathbb{R}^3$ , such that the entries of  $\mathbf{D}$  have all the same sign.

*Proof.* Let us consider the Pauli transfer matrix of  $\mathcal{N}$ , which is characterized by the real  $3 \times 3$  matrix  $B \in \mathcal{L}(\mathbb{R}^3)$  and the vector  $\mathbf{b} = (b_X, b_Y, b_Z) \in \mathbb{R}^3$ :

$$\mathbb{T}(\mathcal{N}) = \begin{bmatrix} 1 & 0 & 0 & 0 \\ b_X & B_{X,X} & B_{X,Y} & B_{X,Z} \\ b_Y & B_{Y,X} & B_{Y,Y} & B_{Y,Z} \\ b_Z & B_{Z,X} & B_{Z,Y} & B_{Z,Z} \end{bmatrix}. \quad (\text{A36})$$

Any single qubit quantum state  $\rho$  can be written as  $\rho = (I + \mathbf{w} \cdot \boldsymbol{\sigma})/2$ , where  $\mathbf{w} := (w_X, w_Y, w_Z) \in \mathbb{R}^3$  with  $\|\mathbf{w}\|_2 \leq 1$  and  $\boldsymbol{\sigma} := (X, Y, Z)$ . Then, we have

$$\mathcal{N}(\rho) = \mathcal{N}\left(\frac{I}{2}\right) + \frac{1}{2}\mathcal{N}(\mathbf{w} \cdot \boldsymbol{\sigma}) = \left(\frac{I}{2} + \frac{1}{2}\mathbf{b} \cdot \boldsymbol{\sigma}\right) + \frac{1}{2}(B\mathbf{w}) \cdot \boldsymbol{\sigma} = \frac{I}{2} + \frac{1}{2}(\mathbf{b} + B\mathbf{w}) \cdot \boldsymbol{\sigma}. \quad (\text{A37})$$

Next, because  $B$  is real, we can perform a real singular value decomposition of  $B$  and have  $B = R_1 D R_2^T$ , where  $D$  is a diagonal matrix with the non-negative diagonal elements  $(D_X, D_Y, D_Z) \in \mathbb{R}^3$  and  $R_1, R_2$  are in general orthogonal  $O(3)$  matrices. Now, every orthogonal matrix has determinant equal to  $\pm 1$ . This fact, along with the fact that  $\det(-R) = (-1)^3 \det(R) = -\det(R)$  for every  $R \in O(3)$ , means that we can, without loss of generality, assume that  $R_1$  and  $R_2$  both have determinant equal to 1. In other words, we can assume that  $R_1$  and  $R_2$  are both special-orthogonal matrices in  $SO(3)$ . The diagonal elements  $(D_X, D_Y, D_Z)$  are then not necessarily non-negative, but they all have the same sign. We now use the fact that for every special-orthogonal matrix  $R \in SO(3)$ , there exists a unitary  $U \in U(2)$  such that [103]:

$$(R\mathbf{v}) \cdot \boldsymbol{\sigma} = U(\mathbf{v} \cdot \boldsymbol{\sigma})U^\dagger, \quad (\text{A38})$$

for all  $\mathbf{v} \in \mathbb{R}^3$ . The previous identity can be easily verified by choosing  $U := \exp(-i\frac{\theta}{2}\hat{n} \cdot \boldsymbol{\sigma})$ , where  $\hat{n}$  and  $\theta$  are, respectively, the unit-norm vector and the rotation angle which characterizes the special-orthogonal matrix  $R \in SO(3)$ . Thus, we have that

$$\mathcal{N}(\rho) = U\left(\frac{I}{2} + \frac{1}{2}(R_1^T \mathbf{b} + D R_2^T \mathbf{w}) \cdot \boldsymbol{\sigma}\right)U^\dagger = U\mathcal{N}'\left(\frac{I + (R_2^T \mathbf{w}) \cdot \boldsymbol{\sigma}}{2}\right)U^\dagger = U\mathcal{N}'\left(V^\dagger\left(\frac{I + \mathbf{w} \cdot \boldsymbol{\sigma}}{2}\right)V\right)U^\dagger, \quad (\text{A39})$$

where  $U$  and  $V$  are the unitaries associated to the special-orthogonal matrices  $R_1$  and  $R_2$ , and  $\mathcal{N}'$  is the linear map such that  $\mathcal{N}'\left(\frac{I + \mathbf{w} \cdot \boldsymbol{\sigma}}{2}\right) = \frac{I + (\mathbf{t} + D\mathbf{w}) \cdot \boldsymbol{\sigma}}{2}$ , where  $\mathbf{t} := R_1^T \mathbf{b}$ . Hence, we have shown that  $\mathcal{N}(\rho)$  can be written as  $\mathcal{N}(\rho) = U\mathcal{N}'(V^\dagger \rho V)U^\dagger$ , where the Pauli transfer matrix of  $\mathcal{N}'$  is the one in Eq. (A35).  $\square$

Thus, every single-qubit quantum channel  $\mathcal{N}$  can be expressed as  $\mathcal{N}(\cdot) = U\mathcal{N}'(V^\dagger(\cdot)V)U^\dagger$ , where  $U, V$  are unitaries, and  $\mathcal{N}'$  is a quantum channel such that it acts on a quantum state written in its Bloch sphere representation as

$$\mathcal{N}'\left(\frac{I + \mathbf{w} \cdot \boldsymbol{\sigma}}{2}\right) = \frac{I}{2} + \frac{1}{2}(\mathbf{t} + D\mathbf{w}) \cdot \boldsymbol{\sigma}, \quad (\text{A40})$$

where  $\mathbf{w} \in \mathbb{R}^3$  with  $\|\mathbf{w}\|_2 \leq 1$ ,  $\mathbf{t} := (t_X, t_Y, t_Z) \in \mathbb{R}^3$  and  $D := \text{diag}(\mathbf{D})$  with  $\mathbf{D} := (D_X, D_Y, D_Z) \in \mathbb{R}^3$ .

We now prove that the parameters of the normal form representation satisfy a particular constrain. Such constrain will be crucial in our following discussion.

**Lemma 18** (Contraction coefficient in terms of the normal form parameters). *For any single-qubit quantum channel, the parameters  $\mathbf{t}, \mathbf{D} \in \mathbb{R}^3$  of its normal form representation satisfy:*

$$c := \frac{1}{3}(t_X^2 + D_X^2 + t_Y^2 + D_Y^2 + t_Z^2 + D_Z^2) \leq 1, \quad (\text{A41})$$

and the equality is saturated if and only if the channel is unitary. Furthermore, it also holds  $\|\mathbf{t}\|_2 \leq 1$ .

*Proof.* Because of the previous Lemma, any single-qubit quantum channel  $\mathcal{N}$  can be expressed as  $\mathcal{N}(\cdot) = U\mathcal{N}'(V^\dagger(\cdot)V)U^\dagger$ , where  $U, V$  are unitaries, and  $\mathcal{N}'$  such that it holds Eq. (A40). Let  $\rho$  be an arbitrary qubit quantum state. Noting that  $\mathcal{N}'$  is a quantum channel, on account of being a composition of quantum channels, it holds that  $\|\mathcal{N}'(\rho)\|_\infty \leq 1$ . If we let  $\mathbf{w} \in \mathbb{R}^3$  be the Bloch vector corresponding to  $\rho$ , then because  $\|\mathcal{N}'(\rho)\|_\infty$  is equal to the largest eigenvalue of  $\mathcal{N}'(\rho)$ , we find that

$$1 \geq \|\mathcal{N}'(\rho)\|_\infty = \frac{1}{2}(1 + \|\mathbf{t} + D\mathbf{w}\|_2). \quad (\text{A42})$$

Hence, we get

$$(t_X + D_X w_x)^2 + (t_Y + D_Y w_y)^2 + (t_Z + D_Z w_z)^2 = \|\mathbf{t} + D\mathbf{w}\|_2^2 \leq 1. \quad (\text{A43})$$

Now, recall that  $\|\mathbf{w}\|_2 \leq 1$ . If  $\mathbf{w} = 0$ , then we get  $\|\mathbf{t}\|_2 \leq 1$ . In particular by choosing  $w = (\pm 1, 0, 0)$ , we get

$$(t_X \pm D_X)^2 \leq 1, \quad (\text{A44})$$



and similarly for  $Y$  and  $Z$ . Now, assume that the entries of  $\mathbf{D}$  are all non-negative (remember that they have the same sign). Together with the previous equation, this implies that

$$t_X^2 + D_X^2 + t_Y^2 + D_Y^2 + t_Z^2 + D_Z^2 \leq (t_X + \text{sign}(t_X)D_X)^2 + (t_Y + \text{sign}(t_Y)D_Y)^2 + (t_Z + \text{sign}(t_Z)D_Z)^2 \leq 3. \quad (\text{A45})$$

Similarly, if the entries of  $\mathbf{D}$  are all negative, we have

$$t_X^2 + D_X^2 + t_Y^2 + D_Y^2 + t_Z^2 + D_Z^2 \leq (t_X - \text{sign}(t_X)D_X)^2 + (t_Y - \text{sign}(t_Y)D_Y)^2 + (t_Z - \text{sign}(t_Z)D_Z)^2 \leq 3. \quad (\text{A46})$$

This proves Eq. (A41).

Finally, we show that Eq. (A41) is saturated if and only if  $\mathcal{N}$  is unitary. If  $\mathcal{N}$  is unitary, then also  $\mathcal{N}'$  is unitary. This implies that  $\mathbf{t} = 0$ , because unitary channels are also unital. Moreover, it also implies that the purity of any state must remain the same, so the diagonal matrix  $D := \text{diag}(\mathbf{D})$  must be norm-preserving, hence orthogonal. Therefore, we have  $D = \pm \text{diag}(1, 1, 1)$ . This saturates inequality (A41). Now, let us assume that

$$\frac{1}{3}(t_X^2 + D_X^2 + t_Y^2 + D_Y^2 + t_Z^2 + D_Z^2) = 1. \quad (\text{A47})$$

From the inequality (A44), we get also that  $t_X^2 + D_X^2 \leq 1$ , and the same for  $Y$  and  $Z$ . Hence, Eq. (A47) implies  $t_X^2 + D_X^2 = 1$ , and the same for  $Y$  and  $Z$ . Using this with Eq. (A44), we have that the possible values for  $t_X^2$  and  $D_X^2$  are, respectively, 1 and 0, or vice versa. Similarly for  $Y$  and  $Z$ . From Eq. (A43), we deduce that the only possibility is that  $\mathbf{t} = 0$  and that  $D_X^2 = D_Y^2 = D_Z^2 = 1$ . Hence, we have that the Pauli transfer matrix of  $\mathcal{N}'$  is equal, up to a possible minus sign factor, to the identity matrix. This implies that  $\mathcal{N}'$  must be the identity channel and that  $\mathcal{N}$  is unitary.  $\square$

Here, we give examples of normal form parameters  $\mathbf{t} = (t_X, t_Y, t_Z)$  and  $\mathbf{D} = (D_X, D_Y, D_Z)$  for standard noise channels. The single-qubit depolarizing channel with parameter  $p \in [0, 1]$  can be defined as

$$\mathcal{N}_p^{(\text{dep})}(\sigma) = (1 - p)\sigma + p \frac{\text{Tr}(\sigma)}{2} I. \quad (\text{A48})$$

Its normal form parameters are  $\mathbf{t} = (0, 0, 0)$  and  $\mathbf{D} = (1 - p, 1 - p, 1 - p)$ . The amplitude damping channel  $\mathcal{N}_q^{(\text{amp})}$ , parameterized by  $q \in [0, 1]$ , is given in the computational basis as

$$\mathcal{N}_q^{(\text{amp})}(\sigma) = \begin{pmatrix} \sigma_{0,0} + q\sigma_{1,1} & \sqrt{1-q}\sigma_{0,1} \\ \sqrt{1-q}\sigma_{1,0} & (1-q)\sigma_{1,1} \end{pmatrix}, \quad (\text{A49})$$

where  $\sigma_{i,j} := \langle i | \sigma | j \rangle$ . Here,  $\mathbf{t} = (0, 0, q)$  and  $\mathbf{D} = (\sqrt{1-q}, \sqrt{1-q}, 1-q)$ . The single-qubit dephasing channel  $\mathcal{N}_p^{(\text{deph})}$  with  $p \in [0, 1]$  can be defined as

$$\mathcal{N}_p^{(\text{deph})}(\sigma) = \begin{pmatrix} \sigma_{0,0} & (1-p)\sigma_{0,1} \\ (1-p)\sigma_{1,0} & \sigma_{1,1} \end{pmatrix}. \quad (\text{A50})$$

Its normal form parameters are  $\mathbf{t} = (0, 0, 0)$  and  $\mathbf{D} = (1 - p, 1 - p, 1)$ .

#### 4. Circuit and noise model

In our work, we examine  $n$ -qubit quantum circuits  $\Phi$  formed by layers of two-qubit random unitary gates interleaved by local noise, with a final layer of random single qubit gates. For example, the standard brickwork circuit architecture is within our model (Figure 2). Mathematically,

$$\Phi := \mathcal{V}^{\text{single}} \circ \mathcal{N}^{\otimes n} \circ \mathcal{U}_L \circ \dots \circ \mathcal{N}^{\otimes n} \circ \mathcal{U}_1, \quad (\text{A51})$$

where  $\mathcal{V}^{\text{single}} := V(\cdot)V^\dagger$  with  $V := \bigotimes_{i=1}^n u_i$  is a layer of single-qubit gates,  $\mathcal{U}_i := U_i(\cdot)U_i^\dagger$  corresponds to the  $n$ -qubit unitary channel associated with the  $i$ -th unitary layer  $U_i$  for  $i \in [L]$ , and  $\mathcal{N}$  is a single-qubit quantum channel.

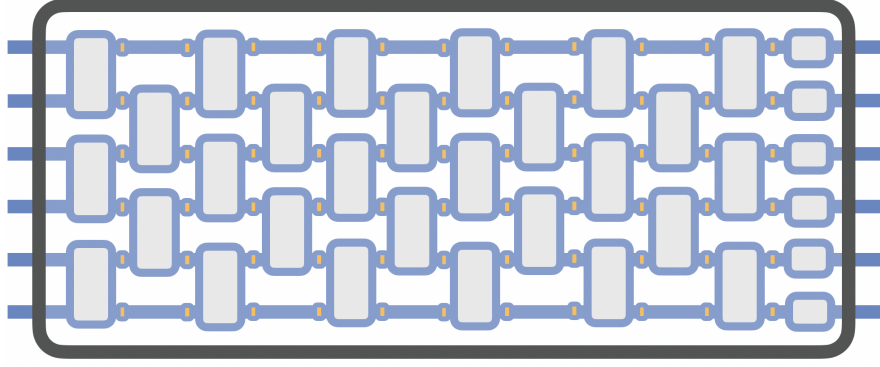

Figure 2. Example of the architecture that our model encompasses: A brickwork circuit composed of two-qubit gates followed by local noise (depicted with yellow circles).

### Assumption on the circuit distribution

Firstly, we assume that each single-qubit gate in the layer  $\bigotimes_{i=1}^n u_i$  is distributed according to a single-qubit 2-design (e.g., Haar random). Moreover, we assume that each unitary layer  $\mathcal{U}_i := U_i(\cdot)U_i^\dagger$ , for  $i \in [L]$ , consists of two-local qubit gates, each forming a local 2-design. More precisely, we assume that each  $U_i$  for  $i \in [L]$  is distributed according to a 2-local 2-design layer distribution, defined as follows:

**Definition 19** (2-local 2-design layer distribution). *We say that  $\nu$  is a 2-local 2-design layer distribution if and only if it is a probability distribution over quantum circuits formed by local 2-qubit gates, where each of them is distributed accordingly to a local 2-design and each qubit is acted on by at least one of the gates.*

Moreover, we point out that we consider an arbitrary circuit geometry/architecture, i.e., we do not make any particular assumptions on the geometric dimensionality of our circuit, except when explicitly mentioned. Note that our model is in stark contrast to works [33, 66] where the unitary layers are chosen as global  $n$ -qubit 2-designs, and we expect that the model that we consider is more realistic.

### Noise model

Moreover, since before and after any noise channel  $\mathcal{N}$  there is a gate that is distributed according to a 2-design and in our work we consider up to second moment quantities, because of the normal form representation of the channel and unitary invariance, we can restrict the noise channels  $\mathcal{N}$  to have a sparse Pauli transfer matrix of the form of Eq. (A35), characterized by two real vectors  $\mathbf{t} := (t_X, t_Y, t_Z)$  and  $\mathbf{D} := (D_X, D_Y, D_Z)$ . In particular, the adjoint channel  $\mathcal{N}^*$  acts on  $Q \in \{X, Y, Z\}$  as

$$\mathcal{N}^*(Q) = t_Q I + D_Q Q = \sum_{a \in \{0,1\}} D_Q^a t_Q^{1-a} Q^a. \quad (\text{A52})$$

Since we work with at most second-moment quantities, we often single out ‘for free’ from each 2-local 2-design unitary layer  $\{\mathcal{U}_i\}_{i=1}^L$  layers of single qubit Haar random gates, due to the invariance of the Haar measure and because each qubit is acted on by at least one of the 2-local 2-design gates. Specifically, without loss of generality, we can consider equivalently circuits of the form

$$\Phi = (\mathcal{V}_L^{\text{single}} \circ \mathcal{N}^{\otimes n} \circ \mathcal{U}_L) \circ \dots \circ (\mathcal{V}_1^{\text{single}} \circ \mathcal{N}^{\otimes n} \circ \mathcal{U}_1), \quad (\text{A53})$$

where  $\{\mathcal{V}_k^{\text{single}}\}_{k=1}^L$  are layers of single-qubit gates distributed according a single-qubit 2-design. However, such single qubits layers, apart from  $\mathcal{V}_L^{\text{single}}$ , do not play a fundamental role in our model and can be removed. We will often denote circuits derived from  $\Phi$  by removing the last layer of single-qubit gates and the last layer of noise. In this case, we use the notation

$$\Phi' := (\mathcal{N}^{\otimes n} \circ \mathcal{U}_L) \circ \dots \circ (\mathcal{V}_1^{\text{single}} \circ \mathcal{N}^{\otimes n} \circ \mathcal{U}_1), \quad (\text{A54})$$

$$\Phi'' := \mathcal{U}_L \circ \dots \circ (\mathcal{V}_1^{\text{single}} \circ \mathcal{N}^{\otimes n} \circ \mathcal{U}_1). \quad (\text{A55})$$

Here,  $\Phi'$  denotes the circuit without the final layer of single-qubit gates, while  $\Phi''$  denotes the circuit without the final layer of single-qubit gates layer and also without the final layer of noise.

We also often need to denote circuits derived from  $\Phi$  by retaining certain layers from the start or from the end. In these cases, we use subscripts to indicate the relevant layers. That is, for  $a \leq b \in [L]$ ,

$$\Phi_{[a,b]} := (\mathcal{V}_b^{\text{single}} \circ \mathcal{N}^{\otimes n} \circ \mathcal{U}_b) \circ \dots \circ (\mathcal{V}_a^{\text{single}} \circ \mathcal{N}^{\otimes n} \circ \mathcal{U}_a). \quad (\text{A56})$$

Whenever we write an expectation value,  $\mathbb{E}[\cdot]$  or  $\text{Var}[\cdot]$ , without explicitly specifying the underlying distribution, we consider the probability distribution over the defined random circuit.

## B. Pauli expectation values of noisy random quantum circuits

In this section, we analyze expectation values of random quantum circuits under possibly non-unital noise. We make here a summary of our results that we analyze in detail in their respective subsections. We consider a circuit  $\Phi$  as we described in subsection A 4, where the local noise channels are characterized by the parameters of their normal form representation  $\mathbf{t} := (t_X, t_Y, t_Z)$  and  $\mathbf{D} := (D_X, D_Y, D_Z)$ , which we assume to be constants with respect to the number of qubits. Our first main theorem is the following.

**Theorem 20** (Variance of expectation values of random circuits with non-unital noise). *Let  $H := \sum_{P \in \{I, X, Y, Z\}^{\otimes n}} a_P P$ , with  $a_P \in \mathbb{R}$  for  $P \in \{I, X, Y, Z\}^{\otimes n}$ , be an arbitrary Hamiltonian. Let  $\rho$  be a quantum state. We assume that the noise is non-unital, specifically  $\|\mathbf{t}\|_2 = \Theta(1)$ . Then, at any depth of the noisy circuit  $\Phi$ , as defined in Eq. (A51), we have*

$$\text{Var}[\text{Tr}(H\Phi(\rho))] = \sum_{P \in \{I, X, Y, Z\}^{\otimes n}} a_P^2 \exp(-\Theta(|P|)). \quad (\text{B1})$$

To prove Theorem 20, we make use of results we show in subsection B 1 and subsection B 2, where we respectively show a lower bound on the variance (Proposition 23) and a matching upper bound (Proposition 25).

Theorem 20 directly implies that the variance of expectation value of local observables (i.e., *local expectation values*) can be significantly large, e.g.,  $\text{Var}[\text{Tr}(Z_1\Phi(\rho))] = \Omega(1)$ . This means that local expectation values can deviate significantly from their mean value  $\mathbb{E}[\text{Tr}(H\Phi(\rho))]$ . This is in stark contrast to the behaviour of noiseless random quantum circuits or circuits with unital noise [20, 48]. Theorem 20 also implies that the variance of expectation value of global observables (i.e., *global expectation values*) are exponentially concentrated to their mean value, e.g.,  $\text{Var}[\text{Tr}(Z^{\otimes n}\Phi(\rho))] = \exp(-\Omega(n))$ .

Moreover, based on the results shown in Subsection B 3 and in Subsection B 4, we prove the following result.

**Theorem 21** (Average distance between two quantum states). *Let  $P \in \{I, X, Y, Z\}^{\otimes n}$ . Let  $\rho$  and  $\sigma$  be any quantum states. Let  $\Phi$  be any noisy random quantum circuit with depth  $L$ , as defined in Eq. (A51). We assume that the noise is not a unitary channel. Then,*

$$\mathbb{E}[|\text{Tr}(P\Phi(\rho)) - \text{Tr}(P\Phi(\sigma))|] \leq \exp(-\Omega(L + |P|)), \quad (\text{B2})$$

This implies that for  $L = \Omega(n)$ , we have

$$\mathbb{E}[\|\Phi(\rho) - \Phi(\sigma)\|_1] \leq \exp(-\Omega(n)). \quad (\text{B3})$$

The average trace distance upper bound is proven in Subsection B 4, where we prove also a worst-case trace distance upper bound (i.e., without the expected value) that holds in the high-noise regime. Note that we cannot hope to prove a worst-case upper bound on the trace distance that is valid for every noise regime. This is because there are quantum error correction methods, such as the so-called *quantum refrigerator* construction [26], which can leverage non-unital noise to perform fault-tolerant quantum computation in a model similar to ours, up to depths that are exponential in the number of qubits. Thus, for these special classes of circuits, the trace distance remains of constant order. Moreover, it is known that this result is tight [32], as bounds on the worst-case convergence are known in the regime where the depth is exponential in the number of qubits.

From a direct application of Eq. (B2), it follows that we can compute classically expectation values for most of the circuit instances, as explained in Subsection B 5. In particular, we get the following:

**Proposition 22** (Average classical simulation). *Let  $\varepsilon, \delta > 0$ . Let  $P \in \{I, X, Y, Z\}^{\otimes n}$ . Let  $\rho_0 := |0^n\rangle\langle 0^n|$ . By sampling an instance of a noisy quantum circuit  $\Phi$  of depth  $L$ , as defined in Eq. (A51), we can guarantee with probability at least  $1 - \delta$  probability that*

$$|\text{Tr}(P\Phi(\rho_0)) - \text{Tr}(P\Phi_{[L-\ell, L]}(\rho_0))| \leq \varepsilon. \quad (\text{B4})$$

Here,  $\Phi_{[L-\ell, L]}$  denotes the channel  $\Phi$  restricted only to the last  $\ell$  layers, where  $\ell := O(\log(1/(\delta\varepsilon^2)))$ .

Note that if  $P$  is local, then  $\text{Tr}(P\Phi_{[L-\ell, L]}(\rho_0))$  can be computed efficiently classically via light-cone arguments. Moreover, if  $\Phi_{[L-\ell, L]}^*(P)$  is close to something proportional to the identity (which can be verified efficiently classically), then we can certify that our algorithm has succeeded. If  $P$  is global, then we can just output zero instead for estimating the expectation value with inverse-polynomial precision. Collectively, these insights underpin a classical simulation algorithm capable of estimating Pauli expectation values of random quantum circuits affected by –possibly non-unital– noise. Its runtime depends polynomially by the inverse of the precision for one dimensional architectures and quasipolynomially for higher dimensional ones.

### 1. Variance lower bound: Local expectation values with non-unital noise are not exponentially concentrated

In this subsection, we show that local expectation values of average quantum circuits with non-unital noise can be far from zero, in contrast to what happens with unital noise or in the noiseless case. Let us consider a circuit  $\Phi$  as described in Subsection A 4, where the local noise channel is characterized by the parameters of its normal form representation  $\mathbf{t} := (t_X, t_Y, t_Z)$  and  $\mathbf{D} := (D_X, D_Y, D_Z)$ , and we consider any circuit depth  $L \geq 1$ .

**Proposition 23** (Lower bound on the variance). *Let  $H := \sum_{P \in \{I, X, Y, Z\}^{\otimes n}} a_P P$ , with  $a_P \in \mathbb{R}$  for all  $P \in \{I, X, Y, Z\}^{\otimes n}$ , be an arbitrary Hamiltonian. Let  $\rho$  be a quantum state. Then, for any depth of the noisy circuit  $\Phi$ , we have*

$$\text{Var}[\text{Tr}(H\Phi(\rho))] \geq \sum_{P \in \{I, X, Y, Z\}^{\otimes n}} a_P^2 \left( \frac{\|\mathbf{t}\|_2^2}{3} \right)^{|P|}, \quad (\text{B5})$$

where we note that  $\|\mathbf{t}\|_2$  is non-zero if the noise channel is non-unital.

*Proof.* Because our circuit ends with a layer of random single qubit gates  $\otimes_{i=1}^n u_i$ , it holds that  $\mathbb{E}[\text{Tr}(P\Phi(\rho))] = 0$  for any  $P \in \{I, X, Y, Z\}^{\otimes n}$ , which follows from Lemma 15. We therefore have that

$$\mathbb{E}[\text{Tr}(H\Phi(\rho))] = 0. \quad (\text{B6})$$

We now focus on  $\mathbb{E}[\text{Tr}(H\Phi(\rho))^2]$ . First of all, using point 1 of Lemma 16, we have

$$\mathbb{E}[\text{Tr}(H\Phi(\rho))^2] = \sum_{P \in \{I, X, Y, Z\}^{\otimes n}} a_P^2 \mathbb{E}[\text{Tr}(P\Phi(\rho))^2]. \quad (\text{B7})$$

Let us now analyze each term  $\mathbb{E}[\text{Tr}(P\Phi(\rho))^2]$  in the sum above separately. Using point 2 of Lemma 16, we obtain

$$\mathbb{E}[\text{Tr}(P\Phi(\rho))^2] = \frac{1}{3^{|P|}} \sum_{\substack{Q \in \{I, X, Y, Z\}^{\otimes n}: \\ \text{supp}(Q) = \text{supp}(P)}} \mathbb{E}[\text{Tr}(Q\Phi'(\rho))^2], \quad (\text{B8})$$

which corresponds to ‘removing’ the last layer of single-qubit gates and using the Pauli mixing property. Recall that  $\Phi'$  denotes the noisy circuit channel without the last layer of single qubit gates, while  $\Phi''$  denotes the noisy circuit channel without the last layer of single qubit gates and last layer of noise, i.e.,  $\Phi' = \mathcal{N}^{\otimes n} \circ \Phi''$ . Taking the adjoint of the noise, and using the fact that  $\mathcal{N}^*$  is a unital channel, we obtain

$$\begin{aligned} \mathbb{E}[\text{Tr}(Q\Phi'(\rho))^2] &= \mathbb{E} \left[ \text{Tr}(\mathcal{N}^{*\otimes n}(Q)\Phi''(\rho))^2 \right] \\ &= \mathbb{E} \left[ \text{Tr} \left( \left( \bigotimes_{j \in \text{supp}(Q)} \mathcal{N}^*(Q_j) \right) \Phi''(\rho) \right)^2 \right] \\ &= \mathbb{E} \left[ \text{Tr} \left( \left( \bigotimes_{j \in \text{supp}(Q)} (t_{Q_j} I_j + D_{Q_j} Q_j) \right) \Phi''(\rho) \right)^2 \right] \\ &= \mathbb{E} \left[ \text{Tr} \left( \left( \sum_{a \in \{0,1\}^{|\mathcal{Q}|}} \bigotimes_{j \in \text{supp}(Q)} (t_{Q_j}^{a_j} D_{Q_j}^{1-a_j} Q_j^{1-a_j}) \right) \Phi''(\rho) \right)^2 \right] \end{aligned} \quad (\text{B9})$$

$$= \sum_{a \in \{0,1\}^{|\mathcal{Q}|}} \prod_{j \in \text{supp}(Q)} (t_{Q_j}^{a_j} D_{Q_j}^{1-a_j})^2 \mathbb{E} \left[ \text{Tr} \left( \left( \bigotimes_{k \in \text{supp}(Q)} Q_k^{1-a_k} \right) \Phi''(\rho) \right)^2 \right] \quad (\text{B10})$$

where in the third step we have used the normal-form parametrization of the channel, specifically, Eq. (A52). The fifth step follows by observing that we can apply point 1 of Lemma 16, which we can do because  $\Phi''$  ends with a 2-local 2-design unitary layer, hence we can single-out from it a layer of single qubit Haar random gates, due to the invariance of the Haar measure and because each qubit is acted on by at least one of the 2-qubit 2-design gate.

Now, we are left with a sum of positive terms and from such sum we can keep only the term corresponding to identity term, and we lower bound the remaining terms with zero. This implies that

$$\begin{aligned} & \sum_{a \in \{0,1\}^{|Q|}} \prod_{j \in \text{supp}(Q)} t_{Q_j}^{2a_j} D_{Q_j}^{2(1-a_j)} \mathbb{E} \left[ \text{Tr} \left( \left( \bigotimes_{k \in \text{supp}(Q)} Q_k^{1-a_k} \right) \Phi''(\rho) \right)^2 \right] \\ & \geq |t_X|^{2|Q|_X} |t_Y|^{2|Q|_Y} |t_Z|^{2|Q|_Z} \mathbb{E} \left[ \text{Tr}(I_n \Phi''(\rho))^2 \right] \\ & = |t_X|^{2|Q|_X} |t_Y|^{2|Q|_Y} |t_Z|^{2|Q|_Z}, \end{aligned}$$

where, in the last step, we have used simply that density matrices have unit trace. Substituting, we get

$$\mathbb{E} \left[ \text{Tr}(P\Phi(\rho))^2 \right] \geq \frac{1}{3^{|P|}} \sum_{\substack{Q \in \{I, X, Y, Z\}^{\otimes n}: \\ \text{supp}(Q) = \text{supp}(P)}} |t_X|^{2|Q|_X} |t_Y|^{2|Q|_Y} |t_Z|^{2|Q|_Z} = \frac{1}{3^{|P|}} (|t_X|^2 + |t_Y|^2 + |t_Z|^2)^{|P|} \quad (\text{B11})$$

where we have used the multinomial theorem in the last equality.  $\square$

Note that if the noise is unital, i.e.,  $\|\mathbf{t}\|_2 = 0$ , the previous lower bound becomes vacuous. As an immediate corollary of the previous inequality we have the following.

**Corollary 24** (Local expectation values are not exponentially concentrated on average). *Let  $P \in \{I, X, Y, Z\}^{\otimes n}$  be a Pauli operator with weight  $|P| = \Theta(1)$ . Let us assume that the noise is non-unital, specifically that  $\|\mathbf{t}\|_2 = \Theta(1)$ . Then, we have*

$$\text{Var}[\text{Tr}(P\Phi(\rho))] = \Theta(1). \quad (\text{B12})$$

We can easily translate the fact that the variance is large into the fact that the probability of deviating from the mean is large. For example, let  $C := \text{Tr}(P\Phi(\rho))$ , with  $\text{sup}(|C|) \leq 1$ . By using the following probability inequality (see Lemma 64 in the last *miscellaneous* section), we find that

$$\text{Prob} \left( |C - \mathbb{E}[C]| > \sqrt{\frac{\text{Var}[C]}{2}} \right) \geq \frac{1}{8} \text{Var}[C]. \quad (\text{B13})$$

Note that for an inverse polynomially small non-unital noise rate, i.e.,  $\|\mathbf{t}\|_2 = \Omega\left(\frac{1}{\text{poly}(n)}\right)$ , we would get that

$$\text{Var}[\text{Tr}(P\Phi(\rho))] = \Omega\left(\frac{1}{\text{poly}(n)}\right), \quad (\text{B14})$$

which implies a lack of exponential concentration of local expectation values even for such small non-unital noise regime.

From a more technical perspective, we have shown that *random quantum circuits* with non-unital noise have local expectation values that are not exponentially concentrated. This is in stark contrast with the behavior of random quantum circuits in the noiseless regime or with local depolarizing noise [48], as summarized in Table B 1.

Table I. **Concentration of local expectation values for  $\Omega(n)$ -depth circuits**

Noise model	$\text{Var}[\text{Tr}(Z_1\rho)]$
Noiseless [43, 48]	$\exp(-\Theta(n))$
Unital noise [20]	$\exp(-\Theta(n))$
Non-unital noise [This work]	$\Theta(1)$

Table II. The table illustrates that if a state is prepared by a non-unital noisy-random quantum circuit, the expectation value of local observables never exhibits exponential concentration at any depth around a fixed value. This stands in stark contrast to the noiseless and unital noise regimes.

## 2. Variance upper bound: Global expectation values are exponentially concentrated

In this section, we show that expectation values of global observables are typically exponentially concentrated around their mean value. As we have previously done, we consider a circuit model as described in Subsection A 4. We let

$$c := \frac{1}{3} (\|\mathbf{t}\|_2^2 + \|\mathbf{D}\|_2^2), \quad (\text{B15})$$

where we recall that  $\mathbf{t} := (t_X, t_Y, t_Z)$  and  $\mathbf{D} := (D_X, D_Y, D_Z)$  are the local noise channel parameters of its normal form representation. We consider any circuit depth  $L \geq 1$ . From Lemma 17, we have that  $c < 1$  if and only if the channel is not unitary.

**Proposition 25** (Variance upper bound). *Let  $H := \sum_{P \in \{I, X, Y, Z\}^{\otimes n}} a_P P$ , with  $a_P \in \mathbb{R}$  for any  $P \in \{I, X, Y, Z\}^{\otimes n}$ . Let  $\rho$  be any quantum state. Then, at any depth of the noisy circuit  $\Phi$ , as defined in Eq. (A51), we have*

$$\text{Var}[\text{Tr}(H\Phi(\rho))] \leq \sum_{P \in \{I, X, Y, Z\}^{\otimes n}} a_P^2 c^{|P|}, \quad (\text{B16})$$

where the parameter  $c$  is defined in Eq. (B15).

*Proof.* The proof follows the same initial steps of the proof of Proposition 23. In particular, the mean is  $\mathbb{E}[\text{Tr}(H\Phi(\rho))] = 0$ , and we have

$$\mathbb{E}[\text{Tr}(H\Phi(\rho))^2] = \sum_{P \in \{I, X, Y, Z\}^{\otimes n}} a_P^2 \mathbb{E}[\text{Tr}(P\Phi(\rho))^2], \quad (\text{B17})$$

with

$$\mathbb{E}[\text{Tr}(P\Phi(\rho))^2] = \frac{1}{3^{|P|}} \sum_{\substack{Q \in \{I, X, Y, Z\}^{\otimes n}: \\ \text{supp}(Q) = \text{supp}(P)}} \mathbb{E}[\text{Tr}(Q^{\otimes 2} \Phi'(\rho)^{\otimes 2})], \quad (\text{B18})$$

Therefore, by taking the adjoint of the last layer of noise, as done in the proof of Proposition 23 (specifically, Eq. (B10)), we have

$$\mathbb{E}[\text{Tr}(Q\Phi'(\rho))^2] = \sum_{a \in \{0,1\}^{|Q|}} \prod_{j \in \text{supp}(Q)} (t_{Q_j}^{a_j} D_{Q_j}^{1-a_j})^2 \mathbb{E} \left[ \text{Tr} \left( \left( \bigotimes_{j \in \text{supp}(Q)} Q_j^{1-a_j} \right) \Phi''(\rho) \right)^2 \right]. \quad (\text{B19})$$

Now, using the fact that  $\text{Tr}(P\sigma) \leq 1$  for every Pauli  $P$  and state  $\sigma$ , we have

$$\begin{aligned} \sum_{a \in \{0,1\}^{|Q|}} \prod_{j \in \text{supp}(Q)} (t_{Q_j}^{a_j} D_{Q_j}^{1-a_j})^2 \mathbb{E} \left[ \text{Tr} \left( \left( \bigotimes_{j \in \text{supp}(Q)} Q_j^{1-a_j} \right) \Phi''(\rho) \right)^2 \right] &\leq \sum_{a \in \{0,1\}^{|Q|}} \prod_{j \in \text{supp}(Q)} t_{Q_j}^{2a_j} D_{Q_j}^{2(1-a_j)} \\ &= \prod_{j \in \text{supp}(Q)} (t_{Q_j}^2 + D_{Q_j}^2). \end{aligned} \quad (\text{B20})$$

Thus, by substituting, we find

$$\mathbb{E}[\text{Tr}(P\Phi(\rho))^2] \leq \frac{1}{3^{|P|}} \sum_{\substack{Q \in \{I, X, Y, Z\}^{\otimes n}: \\ \text{supp}(Q) = \text{supp}(P)}} \prod_{j \in \text{supp}(Q)} (t_{Q_j}^2 + D_{Q_j}^2) \quad (\text{B21})$$

$$= \frac{1}{3^{|P|}} (t_X^2 + D_X^2 + t_Y^2 + D_Y^2 + t_Z^2 + D_Z^2)^{|P|} \quad (\text{B22})$$

$$= c^{|P|}, \quad (\text{B23})$$

where we have used the multinomial theorem.  $\square$

As an immediate corollary of the previous inequality, we find the following corollary.

**Corollary 26** (Global expectation values are exponentially concentrated on average). *Let  $P \in \{I, X, Y, Z\}^{\otimes n}$  be a Pauli operator with weight  $|P| = \Theta(n)$ . Then, at any depth of the noisy circuit  $\Phi$  defined in Eq. (A51), and for any constant noise parameters, we have*

$$\text{Var}[\text{Tr}(P\Phi(\rho))] = \exp(-\Theta(n)). \quad (\text{B24})$$

By combining the lower bound on the variance derived in the previous section (Proposition 23) with the matching upper bound derived in this section (Proposition 25), we get a proof of Theorem 20.

### 3. Effective shallow circuits

In the previous Subsection B 1, we have shown that local expectation values can have a large variance in the presence of non-unital noise. In this subsection, we identify even more compelling consequences of this feature. We show that such large variance can only be due to the last few layers of the circuit. Specifically, we prove that the layers preceding the last  $\Theta(\log(n))$  do not significantly affect Pauli expectation values.

**Proposition 27.** *Let  $P \in \{I, X, Y, Z\}^{\otimes n}$ , let  $\rho$  and  $\sigma$  be quantum states, and let  $L$  be depth of the noisy circuit  $\Phi$  defined in Eq. (A51). Then, we have*

$$\mathbb{E}[\text{Tr}(P\Phi(\rho - \sigma))^2] \leq 4c^{|P|+L-1}, \quad (\text{B25})$$

where the parameter  $c$  is defined in Eq. (B15).

*Proof.* By removing the last layer of single qubits gates and using Lemma 16, we have

$$\mathbb{E}[\text{Tr}(P\Phi(\rho - \sigma))^2] = \frac{1}{3^{|P|}} \sum_{\substack{Q \in \{I, X, Y, Z\}^{\otimes n}: \\ \text{supp}(Q) = \text{supp}(P)}} \mathbb{E}[\text{Tr}(Q\Phi'(\rho - \sigma))^2]. \quad (\text{B26})$$

Now using the exactly the same argument used in Eq. (B10) in the proof of Proposition 23, we obtain

$$\mathbb{E}[\text{Tr}(Q\Phi'(\rho - \sigma))^2] = \sum_{a \in \{0,1\}^{|Q|}} \prod_{j \in \text{supp}(Q)} (t_{Q_j}^{a_j} D_{Q_j}^{1-a_j})^2 \mathbb{E} \left[ \text{Tr} \left( \left( \bigotimes_{j \in \text{supp}(Q)} Q_j^{1-a_j} \right) \Phi''(\rho - \sigma) \right)^2 \right]. \quad (\text{B27})$$

Note that the expected value on the right-hand side can be bounded from above by  $\max_{Q \in \{I, X, Y, Z\}^{\otimes n}} \mathbb{E}[\text{Tr}(Q\Phi''(\rho - \sigma))^2]$ . Thus, we have

$$\begin{aligned} \mathbb{E}[\text{Tr}(P\Phi(\rho - \sigma))^2] &\leq \frac{1}{3^{|P|}} \sum_{\substack{Q \in \{I, X, Y, Z\}^{\otimes n}: \\ \text{supp}(Q) = \text{supp}(P)}} \sum_{a \in \{0,1\}^{|Q|}} \prod_{j \in \text{supp}(Q)} (t_{Q_j}^{a_j} D_{Q_j}^{1-a_j})^2 \max_{Q \in \{I, X, Y, Z\}^{\otimes n}} \mathbb{E}[\text{Tr}(Q\Phi''(\rho - \sigma))^2] \quad (\text{B28}) \\ &= \frac{1}{3^{|P|}} \sum_{\substack{Q \in \{I, X, Y, Z\}^{\otimes n}: \\ \text{supp}(Q) = \text{supp}(P)}} \prod_{j \in \text{supp}(Q)} (t_{Q_j}^2 + D_{Q_j}^2) \max_{Q \in \{I, X, Y, Z\}^{\otimes n}} \mathbb{E}[\text{Tr}(Q\Phi''(\rho - \sigma))^2] \\ &= \frac{1}{3^{|P|}} (\|\mathbf{D}\|_2^2 + \|\mathbf{t}\|_2^2)^{|P|} \max_{Q \in \{I, X, Y, Z\}^{\otimes n}} \mathbb{E}[\text{Tr}(Q\Phi''(\rho - \sigma))^2] \\ &= c^{|P|} \max_{Q \in \{I, X, Y, Z\}^{\otimes n}} \mathbb{E}[\text{Tr}(Q\Phi''(\rho - \sigma))^2], \end{aligned}$$

where we have used the multinomial theorem. Moreover, we can assume that the maximum over the Pauli operators is not achieved by the identity, otherwise the right-hand side of the above inequality would be zero, because  $\Phi''$  is trace preserving and  $\rho - \sigma$  is traceless. Thus, we have

$$\mathbb{E}[\text{Tr}(P\Phi(\rho - \sigma))^2] \leq c^{|P|} \max_{Q \in \{I, X, Y, Z\}^{\otimes n} \setminus I_n} \mathbb{E}[\text{Tr}(Q\Phi''(\rho - \sigma))^2]. \quad (\text{B29})$$



We can assume now that all the two-qubit gates in the circuit are Clifford (see Definition 12), as we are computing a second moment and the Cliffords form a 2-design (Lemma 13). Thus, the two qubit gates of the circuit will also map Paulis to Paulis. Moreover, we assume without loss of generality that before each layer of noise there is a layer of single-qubit 2-design unitaries, as we are computing a second moment over 2-design quantities and we can use the invariance of the Haar measure to do so. Therefore, the Pauli  $Q \neq I_n$  above will be mapped by the two-qubits Clifford to another Pauli still different from the identity. Since now we have a circuit that ends with a layer of single qubits 2-design unitaries, which are preceded by a noise layer and a layer of two-qubits 2-design gates, we are in the same situation we faced at the beginning of the proof. So reiterating the argument to the next layer, we have

$$\begin{aligned} \mathbb{E}[\text{Tr}(Q\Phi''(\rho - \sigma))^2] &\leq \max_{R \in \{I, X, Y, Z\}^{\otimes n} \setminus I_n} c^{|R|} \mathbb{E} \left[ \text{Tr} \left( R\Phi''_{[1, L-1]}(\rho - \sigma) \right)^2 \right] \\ &\leq c \max_{R \in \{I, X, Y, Z\}^{\otimes n} \setminus I_n} \mathbb{E} \left[ \text{Tr} \left( R\Phi''_{[1, L-1]}(\rho - \sigma) \right)^2 \right], \end{aligned} \quad (\text{B30})$$

where we have used the notation  $\Phi''_{[1, k]} := \mathcal{U}_k \circ \dots \circ \mathcal{N}^{\otimes n} \circ \mathcal{U}_1$  and used the fact that the Pauli weight of  $R$  is at least one.

Recursively applying the above reasoning to all of the remaining layers of the circuit, and using the fact that for any Pauli operator  $P$  we have  $|\text{Tr}(P(\rho - \sigma))| \leq \|\rho - \sigma\|_1$  (because of the Hölder inequality), we obtain

$$\mathbb{E}[\text{Tr}(Q\Phi''(\rho - \sigma))^2] \leq c^{L-1} \|\rho - \sigma\|_1^2 \leq 4c^{L-1}, \quad (\text{B31})$$

where in the last step we have used using triangle inequality and the fact that quantum states have one-norm equal to one. Substituting back in Eq. (B29), we conclude the proof.  $\square$

Proposition 27 implies that if  $\rho$  and  $\sigma$  are states created by the ‘first’ part of the same circuit architecture with different parameters of the gates (e.g., the red part of the circuit in Fig. 1), then if we implement on them a noisy quantum circuit of depth  $L = \omega(\log(n))$ , on average we have that the influence on the expectation value of the different gates in the first part of the circuit will be super-polynomially small.

#### 4. Indistinguishability of quantum states affected by noisy quantum circuits

We now translate the results in the previous section in terms of the trace distance.

**Proposition 28** (Average distance between two quantum states). *Let  $\Phi$  be a noisy random quantum circuit with of depth  $L$ , as defined in Eq. (A51). Then, the average trace distance between  $\Phi(\rho)$  and  $\Phi(\sigma)$ , where  $\rho$  and  $\sigma$  are two arbitrary quantum states, decays exponentially in  $L$  as*

$$\mathbb{E}[\|\Phi(\rho) - \Phi(\sigma)\|_1] \leq 2^{n+1} c^{\frac{L-1}{2}}, \quad (\text{B32})$$

where we recall the definition of the parameter  $c$  in Eq. (B15). Thus, for any  $\varepsilon > 0$ , assuming that  $L \geq \frac{1}{\log(c^{-1})} \Omega(n + \log(\frac{1}{\varepsilon}))$ , we have that  $\mathbb{E}[\|\Phi(\rho) - \Phi(\sigma)\|_1] \leq \varepsilon$ .

*Proof.* We have

$$\begin{aligned} (\mathbb{E}[\|\Phi(\rho) - \Phi(\sigma)\|_1])^2 &\leq \mathbb{E}[\|\Phi(\rho) - \Phi(\sigma)\|_1^2] \\ &\leq 2^n \mathbb{E}[\|\Phi(\rho) - \Phi(\sigma)\|_2^2] \\ &= \sum_{P \in \{I, X, Y, Z\}^{\otimes n}} \mathbb{E}[\text{Tr}(P(\Phi(\rho) - \Phi(\sigma)))^2] \\ &\leq 4 \sum_{P \in \{I, X, Y, Z\}^{\otimes n}} c^{|P|+L-1} \\ &= 4(1 + 3c)^n c^{L-1}. \end{aligned} \quad (\text{B33})$$

In the first step, we have used Jensen’s inequality, in the second step we have used the fact that  $\|\cdot\|_1 \leq 2^{\frac{n}{2}} \|\cdot\|_2$ , and in the third step we expressed  $\Phi(\rho) - \Phi(\sigma)$  in the Pauli basis and used the fact that  $\|A\|_2^2 = \text{Tr}(A^\dagger A)$  for any matrix  $A$ . This, in particular, implies that

$$\|H\|_2^2 = \frac{1}{2^n} \sum_{P \in \{I, X, Y, Z\}^{\otimes n}} \text{Tr}(PH)^2 \quad (\text{B34})$$

for every Hermitian matrix  $H$ . Then, in the fourth step, we have used Proposition 27, and in the final step the binomial theorem. Finally, from the fact that  $1 + 3c \leq 4$ , on account of the fact that  $c \leq 1$ , we obtain

$$\mathbb{E}[\|\Phi(\rho) - \Phi(\sigma)\|_1] \leq 2(1 + 3c)^{\frac{n}{2}} c^{\frac{L-1}{2}} \leq 2^{n+1} c^{\frac{L-1}{2}}. \quad (\text{B35})$$

The right-most expression in the above chain of inequalities is bounded from above by  $\varepsilon$  if

$$L \geq \frac{1}{\log(c^{-1})} \left( 2n + 2 \log\left(\frac{1}{\varepsilon}\right) + 3 \right), \quad (\text{B36})$$

which implies the desired result.  $\square$

The previous proposition implies that for most of noisy circuit of depth larger than  $L = \Omega(n)$ , the trace distance between the two output states is bounded from above by  $\exp(-\Theta(n))$ , which means that the two output states cannot be distinguished between each other efficiently by performing arbitrary measurements on polynomially many copies of the state, because of the Holevo-Helstrom theorem [89].

One may wonder if it is possible to prove an upper bound on the worst-case trace distance (i.e., with no expected value) that decreases exponentially with the number of layers. However, this is not possible for arbitrary noise regime in general. In fact, the so-called *quantum refrigerator* construction [26] shows surprisingly how non-unital noise can be exploited to perform fault-tolerant quantum computations in a model similar to ours, up to exponential depth. Therefore, for these special classes of circuits, the trace distance remains of constant order. However, we show below that in a certain high noise regime, we can find a worst-case upper bound on the trace distance that decays exponentially in the number of qubits.

#### a. Worst-case upper bound on the trace distance

In this section we give a worst-case bound for the trace distance that holds whenever the noise parameters exceed certain thresholds. We first introduce a some technical tools before proving our worst-case trace distance upper bound. Our argument is based on the contraction coefficients of the quantum Wasserstein distance of order 1 ( $W_1$  distance) [35].

Let  $O_n^T \subset \mathcal{L}(\mathbb{C}^{2^n})$  be the subset of traceless self-adjoint linear operators. The  $W_1$  distance is induced by the quantum  $W_1$  norm, which is defined as follows [35]:

$$\|X\|_{W_1} = \frac{1}{2} \min \left\{ \sum_{i=1}^n \|X^{(i)}\|_1 : X^{(i)} \in O_n^T, \text{Tr}_i X^{(i)} = 0, X = \sum_{i=1}^n X^{(i)} \right\}. \quad (\text{B37})$$

Hence, for two arbitrary states  $\rho, \sigma$ , the  $W_1$  distance is defined as

$$W_1(\rho, \sigma) := \|\rho - \sigma\|_{W_1}. \quad (\text{B38})$$

The quantum  $W_1$  norm and the trace norm are always within a factor of  $n$ :

$$\frac{1}{2} \|X\|_1 \leq \|X\|_{W_1} \leq \frac{n}{2} \|X\|_1. \quad (\text{B39})$$

We will employ the *contraction coefficient* of a channel  $\Phi$  with respect to the quantum  $W_1$  distance, defined as

$$\|\Phi\|_{W_1 \rightarrow W_1} := \max_{\rho \neq \sigma \in \mathcal{S}(\mathbb{C}^{2^n})} \frac{\|\Phi(\rho) - \Phi(\sigma)\|_{W_1}}{\|\rho - \sigma\|_{W_1}} = \max_{\substack{X \in O_n^T, \\ \|X\|_{W_1} = 1}} \|\Phi(X)\|_{W_1}. \quad (\text{B40})$$

The contraction coefficient is not in general bounded by 1, as the  $W_1$  does not satisfy a data-processing inequality for all channels. Importantly, as showed in Ref. [35], if  $\Phi$  is a layer of  $k$ -qubit gates, the contraction coefficient of  $\Phi$  can be bounded by light-cone argument as follows

$$\|\Phi\|_{W_1 \rightarrow W_1} \leq \begin{cases} 1 & \text{if } k = 1, \\ \frac{3}{2}k & \text{if } k > 1 \quad ([35], \text{ Proposition 13}). \end{cases} \quad (\text{B41})$$

And thus a layer of two qubit gates has contraction coefficient at most 3. If  $\mathcal{N}$  is a single-qubit channel, the contraction coefficient of the tensor power channel  $\mathcal{N}^{\otimes n}$  can be upper bounded by the diamond distance between  $\mathcal{N}$  and a suitable 1-qubit channel  $\mathcal{E}$  [35], as follows.

**Proposition 29** (Proposition 11, [35]). *Let  $\Phi$  be a single qubit quantum channel with fixed point a quantum state  $\tau$  and let  $\mathcal{E}$  the single-qubit quantum channel that replaces any state with  $\tau$ . Then,*

$$\frac{1}{2}\|\Phi - \mathcal{E}\|_{1 \rightarrow 1} \leq \|\Phi^{\otimes n}\|_{W_1 \rightarrow W_1} \leq \|\Phi - \mathcal{E}\|_{\diamond} \leq 2\|\Phi - \mathcal{E}\|_{1 \rightarrow 1}, \quad (\text{B42})$$

where we recall that for any single-qubit Hermitian-preserving linear map  $\mathcal{F}$ ,

$$\|\mathcal{F}\|_{1 \rightarrow 1} = \max_{\rho \in \mathcal{S}(\mathbb{C}^2)} \|\mathcal{F}(\rho)\|_1, \quad (\text{B43})$$

$$\|\mathcal{F}\|_{\diamond} = \max_{\rho \in \mathcal{S}(\mathbb{C}^2 \otimes \mathbb{C}^2)} \|\mathcal{F} \otimes \mathcal{I}(\rho)\|_1. \quad (\text{B44})$$

By exploiting the above result, we give an explicit upper bound of the contraction coefficient in terms of the parameters of the noise channel  $\mathcal{N}$  expressed in the normal form. We remark that the adoption of the normal form comes without loss of generality: as discussed in Section A 3 b, we can always write a single-qubit channel  $\mathcal{M}$  as  $\mathcal{M}(\cdot) = U\mathcal{N}(V^\dagger(\cdot)V)U^\dagger$ , where  $U, V$  are suitable single-qubit unitaries. By Eq. (B41),  $U$  and  $V$  do not alter the  $W_1$  norm, thus they can be neglected in our analysis.

**Lemma 30.** *Let  $\mathcal{N}$  be a single-qubit channel that acts as  $\mathcal{N}(I + \mathbf{w} \cdot \boldsymbol{\sigma}) = I + (\mathbf{t} + D\mathbf{w}) \cdot \boldsymbol{\sigma}$ . Then,*

$$\|\mathcal{N}^{\otimes n}\|_{W_1 \rightarrow W_1} \leq \max_{P \in \{X, Y, Z\}} \frac{2D_P}{1 - D_P} \|\mathcal{N} - \mathcal{I}\|_{1 \rightarrow 1}. \quad (\text{B45})$$

*Proof.* The only fixed state of  $\mathcal{N}$  is

$$\tau = \frac{I}{2} + \sum_{P \in \{X, Y, Z\}} \frac{t_P}{2(1 - D_P)} P. \quad (\text{B46})$$

We consider a single-qubit state parametrized as

$$\rho = \frac{I}{2} + \sum_{P \in \{X, Y, Z\}} w_P P, \quad (\text{B47})$$

where  $\mathbf{w} = (w_X, w_Y, w_Z)$  is a unit vector in  $\mathbb{R}^3$ . We have,

$$\|\mathcal{N}(\rho) - \tau\|_1 = \frac{1}{2} \left\| \sum_{P \in \{X, Y, Z\}} \left( t_P + D_P w_P - \frac{t_P}{1 - D_P} \right) P \right\|_1 \quad (\text{B48})$$

$$= \frac{1}{2} \left\| \sum_{P \in \{X, Y, Z\}} \frac{D_P}{1 - D_P} (-t_P + (1 - D_P)w_P) P \right\|_1$$

$$\leq \frac{1}{2} \left\| \max_{Q \in \{X, Y, Z\}} \frac{D_Q}{1 - D_Q} \sum_{P \in \{X, Y, Z\}} (w_P - (w_P D_P + t_P)) P \right\|_1 \quad (\text{B49})$$

$$= \max_{Q \in \{X, Y, Z\}} \frac{D_Q}{2(1 - D_Q)} \left\| \sum_{P \in \{X, Y, Z\}} (w_P - (w_P D_P + t_P)) P \right\|_1$$

$$= \max_{Q \in \{X, Y, Z\}} \frac{D_Q}{1 - D_Q} \|\rho - \mathcal{N}(\rho)\|_1.$$

Hence, the contraction coefficient of the quantum  $W_1$  distance can be bounded via Proposition 29 as

$$\begin{aligned} \|\mathcal{N}^{\otimes n}\|_{W_1 \rightarrow W_1} &\leq 2\|\mathcal{N} - \mathcal{E}\|_{1 \rightarrow 1} = 2 \max_{\rho \in \mathcal{S}} \|\mathcal{N}(\rho) - \tau\|_1 \\ &\leq 2 \max_{\rho \in \mathcal{S}} \max_{P \in \{X, Y, Z\}} \frac{D_P}{1 - D_P} \|\rho - \mathcal{N}(\rho)\|_1 \\ &= \max_{P \in \{X, Y, Z\}} \frac{2D_P}{1 - D_P} \|\mathcal{N} - \mathcal{I}\|_{1 \rightarrow 1}, \end{aligned} \quad (\text{B50})$$

as required.  $\square$

The above bound applies to any local noise channel expressed in its normal form. This can be used to argue that, if the noise strength exceeds a given threshold, we witness a logarithmic effective depth for any fixed circuit. This result complements the findings of the previous section, which held for average-case circuits. The following proof extends to the non-unital case a result (Proposition IV.8) that was proven in Ref. [92] for the case of local depolarizing noise.

**Proposition 31.** *Let  $\mathcal{N}$  be a single-qubit channel that acts as  $\mathcal{N}(I + \mathbf{w} \cdot \boldsymbol{\sigma}) = I + (\mathbf{t} + D\mathbf{w}) \cdot \boldsymbol{\sigma}$ , and let  $b := 12 \max_{P \in \{X, Y, Z\}} \frac{D_P}{1 - D_P}$ . Let  $\Phi$  be a noisy random quantum circuit with depth  $L$ . Then, the  $W_1$  distance between  $\Phi(\rho)$  and  $\Phi(\sigma)$ , where  $\rho$  and  $\sigma$  are two arbitrary quantum states, decays exponentially in  $L$  as*

$$\|\Phi(\rho) - \Phi(\sigma)\|_{W_1} \leq b^L \|\rho - \sigma\|_{W_1}. \quad (\text{B51})$$

Furthermore, we have the following upper bound on the trace distance:

$$\|\Phi(\rho) - \Phi(\sigma)\|_1 \leq nb^L \|\rho - \sigma\|_1. \quad (\text{B52})$$

Thus, for any  $\varepsilon > 0$ , assuming that  $b < 1$  and  $L \geq \frac{1}{\log(b^{-1})} \Omega(\log(\frac{n}{\varepsilon}))$ , we have that  $\|\Phi(\rho) - \Phi(\sigma)\|_1 \leq \varepsilon$ .

*Proof.* Let  $\mathcal{U} = U(\cdot)U^\dagger$  be a layer of 2-qubit unitaries. Then, by Eq. (B41), we have  $\|\mathcal{U}\|_{W_1 \rightarrow W_1} \leq 3$ . Moreover, Lemma 30 yields

$$\|\mathcal{U} \circ \mathcal{N}^{\otimes n}\|_{W_1 \rightarrow W_1} \leq \|\mathcal{U}\|_{W_1 \rightarrow W_1} \|\mathcal{N}^{\otimes n}\|_{W_1 \rightarrow W_1} \quad (\text{B53})$$

$$\leq 3 \max_{P \in \{X, Y, Z\}} \frac{2D_P}{1 - D_P} \|\mathcal{N} - \mathcal{I}\|_{1 \rightarrow 1} \quad (\text{B54})$$

$$\leq 12 \max_{P \in \{X, Y, Z\}} \frac{D_P}{1 - D_P} \quad (\text{B55})$$

$$= b, \quad (\text{B56})$$

where in the first inequality we used the submultiplicativity property of  $\|\cdot\|_{W_1 \rightarrow W_1}$ , in the third inequality we used the fact that  $\|\mathcal{N} - \mathcal{I}\|_{1 \rightarrow 1} \leq 2$ , due to the triangle inequality. Iterating over all the layers of the noisy circuit  $\Phi$ , we obtain

$$\|\Phi\|_{W_1 \rightarrow W_1} \leq b^L, \quad (\text{B57})$$

which directly implies Eq. (B51). Furthermore, Eq. (B52) follows from the fact that the  $W_1$  distance and the trace distance are within a factor of  $n$ , i.e.,  $\frac{1}{2}\|X\|_1 \leq \|X\|_{W_1} \leq \frac{n}{2}\|X\|_1$ .  $\square$

In particular, assuming that  $b$  is a constant less than one, we have

$$\|\Phi(\rho - \sigma)\|_1 \leq n2^{-\Omega(L)}. \quad (\text{B58})$$

## 5. Classical simulation of Pauli expectation values of noisy random quantum circuits

We have seen that the presence of any non-unitary noise in the circuit renders the circuit effectively shallow for the purpose of computing expectation values, where to compute expectation values to inverse polynomial precision the last logarithmically-many layers suffice. Specifically, a direct consequence of Proposition 27 implies the following:

**Corollary 32** (Effective-depth picture). *Let  $l \in \mathbb{N}$ ,  $P \in \{I, X, Y, Z\}^{\otimes n}$ , and  $\rho_0 := |0^n\rangle\langle 0^n|$ . Let  $L$  be depth of the noisy circuit  $\Phi$ . Then, we have*

$$\mathbb{E}[|\text{Tr}(P\Phi(\rho_0)) - \text{Tr}(P\Phi_{[L-l, L]}(\rho_0))|^2] \leq 4c^{|P|+l-1}. \quad (\text{B59})$$

Here,  $\Phi_{[L-l, L]}(\cdot)$  refers to the noisy circuit where only the last  $l$  layers are considered.

So far, we did not make any assumptions on the locality of the circuits. However, now we assume that the circuit architecture is geometrically local, with constant dimension  $D$ . This yields the following simple algorithm for estimating local expectation values: work in the Heisenberg picture and ‘propagate’ the local Pauli  $P$  only a few number of layers backwards; compute classically the matrix  $P_l := \Phi_{[L-l, L]}^*(P)$ , and then evaluate  $\text{Tr}(P_l \rho_0)$ . Due to standard light-cone arguments, this algorithm incurs a total time complexity bounded from above by  $\exp(O((|P| + l)^D))$ , independent of the number of qubits. We refer to Sec. A 1 for a formal definition of the light-cone of an observable.

**Proposition 33** (Average classical simulation of local expectation values). *Let  $\varepsilon, \delta > 0$ . Let  $P \in \{I, X, Y, Z\}^{\otimes n}$ . Let  $\rho_0 := |0^n\rangle\langle 0^n|$ . Let  $\Phi$  be a noisy geometrically-local quantum circuit of depth  $L$ , sampled according to the described circuit distribution. There is a classical algorithm that outputs a value  $\hat{C}$  that satisfies:*

$$|\hat{C} - \text{Tr}(P\Phi(\rho_0))| \leq \varepsilon \quad (\text{B60})$$

with at least  $1 - \delta$  probability of success. Specifically, the classical algorithm involves computing  $\hat{C} := \text{Tr}(P\Phi_{[L-l, L]}(\rho_0))$  with

$$l := \left\lceil \frac{1}{\log(c^{-1})} \log\left(\frac{4}{\delta\varepsilon^2}\right) \right\rceil. \quad (\text{B61})$$

Its runtime is upper bounded by

$$\text{Runtime} \leq \exp\left[O\left(\left(|P| + \frac{1}{\log(c^{-1})} \log\left(\frac{1}{\varepsilon^2\delta}\right)\right)^D\right)\right], \quad (\text{B62})$$

where  $D$  is the geometrical dimensionality of the circuit and  $c$  is the noise parameter defined in Lemma 17.

*Proof.* Because of the Markov inequality, we have

$$\begin{aligned} \text{Prob}(|\text{Tr}(P\Phi(\rho_0)) - \text{Tr}(P\Phi_{[L-l, L]}(\rho_0))| > \varepsilon) &\leq \frac{1}{\varepsilon^2} \mathbb{E}[|\text{Tr}(P\Phi(\rho_0)) - \text{Tr}(P\Phi_{[L-l, L]}(\rho_0))|^2] \\ &\leq \frac{4}{\varepsilon^2} c^l, \end{aligned} \quad (\text{B63})$$

where we have used Corollary 32 with  $|P| \geq 1$ . The right-hand side of this inequality is at most  $\delta$  if we choose

$$l \geq \left\lceil \frac{1}{\log(c^{-1})} \log\left(\frac{4}{\delta\varepsilon^2}\right) \right\rceil \quad (\text{B64})$$

. The algorithm consists of computing classically the matrix  $P_l := \Phi_{[L-l, L]}^*(P)$  and then evaluate  $\text{Tr}(P_l\rho_0)$ , which can be done in time  $\exp(O((|P| + l)^D))$ , via standard light-cone arguments. Substituting  $l$ , we find the claimed computational time.  $\square$

Note that for one-dimensional circuits  $D = 1$ , the time complexity runtime is  $\text{poly}(\exp(|P|), \frac{1}{\varepsilon^2\delta})$  i.e., depends only polynomially by the accuracy  $\varepsilon$ , while for higher dimension the time complexity depends quasi-polynomially by  $\varepsilon$ . Moreover, if  $\Phi_{[L-l, L]}^*(P)$  is close to something proportional to the identity (which can be verified efficiently classically), then we can certify that our algorithm has succeeded. The intuition about this is that if  $\Phi_{[L-l, L]}^*(P)$  were proportional to the identity, then keeping adding (adjoint) layers does not change the matrix because of the unitality of the adjoint channel. Specifically, at the end of the previous algorithm, we can check (efficiently in the effective dimension of the propagated observable) if the condition

$$E := \min_{q \in \mathbb{R}} \|\Phi_{[L-l, L]}^*(P) - qI\|_\infty \leq \varepsilon/2 \quad (\text{B65})$$

is satisfied. If it is, then the previous algorithm succeeded with unit probability, as we are going to show in the next observation.

**Observation 34** (Verification guarantees). *After running the algorithm described in Proposition 33, if such condition is true:*

$$E := \min_{q \in \mathbb{R}} \|P_l - qI\|_\infty \leq \varepsilon/2, \quad (\text{B66})$$

where  $P_l := \Phi_{[L-l, L]}^*(P)$ , then we can conclude that the algorithm in Proposition 33 succeeded with unit probability. Furthermore, such condition can be verified in polynomial time in the effective dimension of the observable  $P_l$  (which is  $\exp(O((|P| + l)^D))$ ), since it holds that

$$E = \frac{1}{2} (|\lambda_{\max}(P_l) - \lambda_{\min}(P_l)|), \quad (\text{B67})$$

where  $\lambda_{\min}(P_l)$  and  $\lambda_{\max}(P_l)$  are respectively the minimum and the maximum eigenvalue of  $P_l$ .

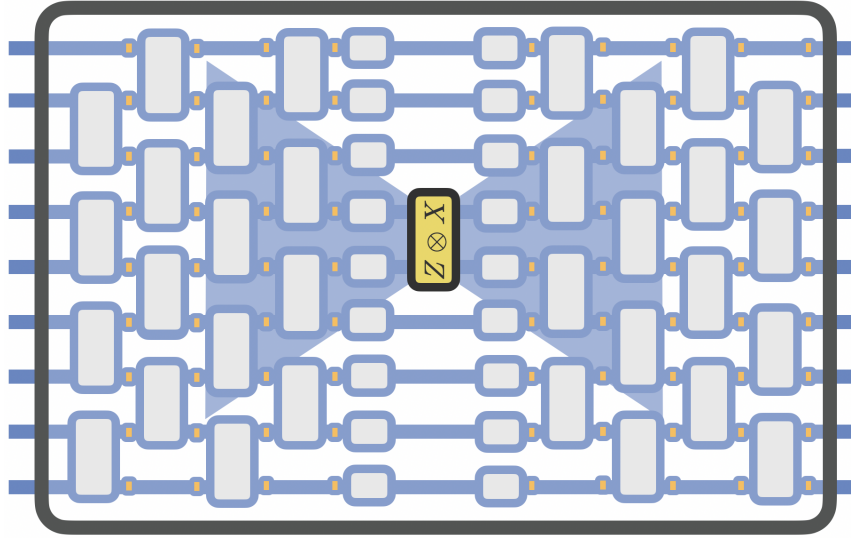

Figure 3. A graphical representation of  $\Phi_{[L-2,L]}^*(P)$  with respect to the local Pauli observable  $P$  represented by the blue shaded area. The (noisy) gates outside the blue shaded area are contracted trivially due to the fact that the adjoint of every channel is unital, and thus cannot influence the expectation value of the Pauli. Even if the qubits in the system are  $n$ , the computation of  $\Phi_{[L-2,L]}^*(P)$  is restricted to only a constant number of qubits.

*Proof.* Assuming that  $E := \min_{q \in \mathbb{R}} \|P_l - qI\|_\infty \leq \varepsilon/2$ , we have

$$\begin{aligned}
 |\mathrm{Tr}(P\Phi(\rho_0)) - \mathrm{Tr}(P\Phi_{[L-l,L]}(\rho_0))| &\leq |\mathrm{Tr}(P\Phi(\rho_0)) - q| + |q - \mathrm{Tr}(P\Phi_{[L-l,L]}(\rho_0))| & (\text{B68}) \\
 &= |\mathrm{Tr}(P_l\Phi_{[1,L]}(\rho_0)) - q| + |\mathrm{Tr}(P_l\rho_0) - q| \\
 &= |\mathrm{Tr}((P_l - qI)\Phi_{[1,L]}(\rho_0))| + |\mathrm{Tr}((P_l - qI)\rho_0)| \\
 &\leq \|P_l - qI\|_\infty + \|P_l - qI\|_\infty \\
 &\leq \varepsilon,
 \end{aligned}$$

where in the last step we have used Hölder inequality. This shows that if  $E \leq \varepsilon/2$ , then the algorithm in Proposition 33 succeeds with unit probability.

Moreover,  $E$  can be computed in polynomial time in the effective dimension of the observable  $P_l$ . This can be seen for example by noting that  $E$  depends only by the eigenvalues of  $P_l$ , since it suffices to compute its spectrum. In particular, we have

$$\min_{q \in \mathbb{R}} \|P_l - qI\|_\infty = \min_{q \in \mathbb{R}} \max(|\lambda_{\min}(P_l) - q|, |\lambda_{\max}(P_l) - q|) = \frac{1}{2} (|\lambda_{\max}(P_l) - \lambda_{\min}(P_l)|). \quad (\text{B69})$$

This completes the proof. □

We note that such verification step can be also inserted at each step in which we take the adjoint of each of the last unitary layer. We refer to Algorithm 1 for a summary of the described steps.

---

**Algorithm 1** Computing local expectation values on noisy circuit
 

---

**Parameters:**  $\varepsilon, \delta > 0$  (desired precision and success probability).

**Input:** Classical descriptions of  $\mathcal{C}$  (noiseless circuit), noise channel  $\mathcal{N}$  with parameter  $c$  and observable of interest  $P$ .

```

1: Initialize:  $P_0 = P$ .
2:  $l := \lceil \frac{1}{\log(c-1)} \log(\frac{4}{\delta\varepsilon^2}) \rceil$ .
3: for  $t = 1$  to  $l$ , do
4:    $P_t \leftarrow \Phi_{[L-t, L]}^*(P_{t-1})$ .
5:    $E_t \leftarrow \frac{1}{2} (|\lambda_{\max}(P_t) - \lambda_{\min}(P_t)|)$  ▷ Check early-break condition
6:   if  $2E_t \leq \varepsilon$  then
7:     Output  $\text{Tr}(P_t |0^n\rangle\langle 0^n|)$ .
8:     Break
9:   end if
10: end for
11: Output  $\text{Tr}(P_l |0^n\rangle\langle 0^n|)$ 

```

---

The above algorithm is efficient if  $|P| = O(\log(n))$  (i.e., its time complexity runs polynomially in the number of qubits), and it is no longer efficient if  $|P| = \omega(\log(n))$ . However, in this high Pauli-weight regime, we do not need to run any algorithm, since we can just output zero and this succeeds with high probability and with an inverse-polynomial accuracy, due to the following observation.

**Observation 35** (Output zero if the Pauli is Global). *Let  $\varepsilon = \Theta(1/\text{poly}(n))$ ,  $P \in \{I, X, Y, Z\}^{\otimes n}$ ,  $\rho_0$  an arbitrary initial state, and let  $\Phi$  be a noisy quantum circuit of any depth sampled according to the described circuit distribution. If  $|P| = \omega(\log(n))$ , then the probability that expectation value  $\text{Tr}(P\Phi(\rho_0))$  is larger than  $\varepsilon$  is negligible:*

$$\text{Prob}(|\text{Tr}(P\Phi(\rho_0))| \geq \varepsilon) \leq \text{negl}(n), \quad (\text{B70})$$

where  $\text{negl}(n)$  denotes a negligible function, i.e., a function that grows more slowly than any inverse polynomial in the number of qubits  $n$ .

*Proof.* Recalling that  $\mathbb{E}[\text{Tr}(P\Phi(\rho_0))] = 0$ , the Chebyshev inequality implies that

$$\text{Prob}(|\text{Tr}(P\Phi(\rho_0))| \geq \varepsilon) \leq \frac{1}{\varepsilon^2} \text{Var}[\text{Tr}(P\Phi(\rho_0))] \leq \frac{c^{|P|}}{\varepsilon^2}, \quad (\text{B71})$$

where we have used Proposition 25. If  $\varepsilon$  is at most inverse-polynomially small and  $c^{|P|}$  with  $|P| = \omega(\log(n))$  is super-polynomially small, then  $c^{|P|}/(\varepsilon^2)$  will be negligible.  $\square$

Taken together, the results of this subsection give a classical simulation algorithm for estimating Pauli expectation values of (possibly non-unital) noisy random quantum circuits. If the required precision is constant in the number of qubits  $n$ , then the running time of the algorithm is polynomial in  $n$  for any spatial dimension. If the required precision scales inverse-polynomially, then the algorithm runs in polynomial time for 1-D architectures, while in quasi-polynomial time in higher dimensionality.

### C. Quantum machine learning under non-unital noise: Barren plateaus

In this section, we rigorously show that non-unital noise induces absence of barren plateaus for local cost functions, in contrast to the unital scenario [20]. Specifically, in Subsection C3 we establish that the gates in the last  $\Theta(\log(n))$  layers are trainable, whereas those preceding them are not. This complements the results presented in the previous section by rigorously showing the significance of the last  $\Theta(\log(n))$  layers. Moreover, we establish that global cost functions exhibit barren plateaus. In Subsection C4, we also present an improved upper bound on the onset of barren plateaus in the unital noise scenario compared to the one shown in Ref. [20].

The results we show in this section are in stark contrast with the behavior of quantum circuits in the noiseless regime or with local depolarizing noise [48, 85], as summarized in Table C.

Table III. **Trainability w.r.t. the last  $g(n)$ -layers**

Noise model	$g(n) = \omega(\log(n))$	$\Theta(\log(n))$	$\Theta(1)$
Noiseless [43, 48]	✗	✗	✗
Unital noise [20]	✗	✗	✗
Non-unital noise [This work]	✗	✓	✓

Table IV. Table II shows that the last  $\Theta(\log(n))$  layers of a non-unital noise circuit are the only trainable layers. This behavior is notably absent in the unital and noiseless noise regime for circuits with depth  $\omega(\log(n))$ : in these cases the gates in all the layers are not trainable.

#### 1. Preliminaries on barren plateaus

In this section, we introduce concepts that will be crucial for our discussion. We use an analogous circuit model described in subsection A4, namely we consider  $n$ -qubit quantum circuits  $\Phi$  of the form

$$\Phi = (\mathcal{V}_L^{\text{single}} \circ \mathcal{N}^{\otimes n} \circ \mathcal{U}_L) \circ \dots \circ (\mathcal{V}_1^{\text{single}} \circ \mathcal{N}^{\otimes n} \circ \mathcal{U}_1), \quad (\text{C1})$$

where  $L$  represents the number of layers, also referred to as circuit depth,  $\{\mathcal{V}_k^{\text{single}}\}_{k=1}^L$  are layers of single-qubit gates distributed according a single-qubit 2-design,  $\mathcal{U}_i := U_i(\cdot)U_i^\dagger$  corresponds to the  $n$ -qubit unitary channel associated with the unitary layer  $U_i$  for  $i \in [L]$  which is formed by two-qubits gates, and  $\mathcal{N}$  is a single-qubit quantum channel. Recall that we assume that the two-qubit gates in the circuit are distributed according to a two-qubit 2-design (see Definition 19). For example, our model encompasses the brickwork architecture in Fig. 2. Remember that, because of the unitary invariance of the two-qubit 2-design layers, one can add ‘for free’ layers of single-qubit Haar random gates layers, since we will be considering only up to second moment quantities. Thus, in the above equation, the layer of single-qubit gates (apart from the last one,  $\mathcal{V}_L^{\text{single}}$ ) do not play a fundamental role in our model.

We now assume that the circuit is also also dependent on variational parameters  $\boldsymbol{\theta} := (\theta_1, \dots, \theta_m) \in \mathbb{R}^m$ , which parameterize some of the two-qubit gates, which come from the set  $\{\exp(-i\theta_\mu H_\mu)\}_{\mu=1}^m$ , where  $H_\mu$  are two-local Hermitian operators with  $\|H_\mu\|_\infty \leq 1$ . Specifically, we assume for simplicity that these parameterized gates are positioned at the start of the unitary layer  $\mathcal{U}_i$  for  $i \in [L]$ . It is important to note that while we introduce these parameterized gates, they do not impact our model due to left-right invariance of the two-qubit 2-design layers we consider, and so they can be considered part of one of the unitary layers  $\mathcal{U}_i$  for  $i \in [L]$ ; their introduction is primarily to facilitate the discussion on partial derivatives and barren plateaus.

In quantum machine learning jargon, the term *cost function* is usually referred to as an expectation value of an Hermitian operator over a ‘parameterized’ quantum state.

**Definition 36** (Cost function). *Let  $H$  be an Hermitian operator. Let  $\rho_0$  be a quantum state and  $\Phi$  be a noisy quantum circuit as defined previously. We define the cost function  $C(\boldsymbol{\theta})$  associated with  $H$  and  $\Phi(\rho_0)$  as*

$$C(\boldsymbol{\theta}) := \text{Tr}(H\Phi(\rho_0)). \quad (\text{C2})$$

We will often omit the  $\boldsymbol{\theta}$ -dependence and write simply  $C$  instead of  $C(\boldsymbol{\theta})$ . As usual, when we write expected values or variances, it will always be with respect to the distribution from which we sample the gates that compose our quantum circuit.

Next, we introduce the notion of lack of barren plateaus.



**Definition 37** (Lack of barren plateaus). *We say a cost function  $C$  lacks barren plateaus if and only if*

$$\mathbb{E} [\|\nabla_{\theta} C\|_2^2] = \Omega\left(\frac{1}{\text{poly}(n)}\right), \quad (\text{C3})$$

where  $\nabla_{\theta} C := (\frac{\partial C}{\partial \theta_1}, \dots, \frac{\partial C}{\partial \theta_m})$  is the gradient of the cost function.

Hence, we assert that a cost function has barren plateaus if and only if the variance of the 2-norm of the gradient is at least super-polynomially small. We define now the notion of *trainability* of a parametrized gate, which is useful to identify which gate in the circuit influences significantly the cost function (on average).

**Definition 38** (Trainability of the cost function with respect to a parameter). *We say that a cost function  $C$  is trainable with respect the parameter  $\theta_{\mu}$  if and only if*

$$\text{Var}[\partial_{\mu} C] = \Omega\left(\frac{1}{\text{poly}(n)}\right), \quad (\text{C4})$$

where we denoted  $\partial_{\mu} C := \frac{\partial C}{\partial \theta_{\mu}}$ .

We point out that partial derivatives of expectation values are not only important for the consideration of barren plateaus, but also to understand which gate in the circuit has significant influence on the expectation value.

### Review of previous results

In the noiseless scenario, initial observations by McClean *et al.* [43] pointed out that if the parameter distribution underlying the parametrized quantum circuit forms a global 2-design with respect to the Haar measure of  $n$ -qubit unitaries, then any associated cost function exhibits barren plateaus. Furthermore, when modeling a noiseless parametrized quantum circuit (often referred to as an *ansatz*) as a ‘local random quantum circuit,’ composed of geometrically local two-qubit gates, where each gate is distributed according to the Haar measure, barren plateaus start to manifest at  $O(n)$  depth. This is because studies by Brandão *et al.* [45] have demonstrated that at linear  $O(n)$  depth in one-dimensional architectures, the distribution over such circuits becomes ‘approximately’ a 2-design. Similar results have been extended to higher-dimensional quantum circuit architectures. Specifically, it has been shown by Harrow *et al.* [71] that the ‘approximate’ 2-design property emerges at  $O(n^{1/D})$ , where  $D$  represents the dimension of the lattice of the circuit. Discussions concerning the relationship between barren plateaus and approximate notions of 2-design can be found in Ref. [44]. The influence of the locality of observables on the onset of barren plateaus has been explored in Ref. [46].

In one-dimensional architectures, it has been observed that while cost functions associated with  $O(1)$ -local observables do not exhibit barren plateaus at logarithmic depth, cost functions associated with global observables manifest barren plateaus even at constant depth. Furthermore, these results have been generalized in Ref. [48], where it has been noted that the gradient of the cost function decays exponentially with respect to the circuit depth and the Hamiltonian locality. These findings were established under the assumption that the 2-qubit gates composing the circuits are distributed according to a unitary 2-design. Methods for avoiding or mitigating barren plateaus in noiseless scenarios have been proposed, primarily relying on specific heuristic-based initialization strategies [44, 49–54], as well as by constraining the expressibility of the ansatz [55–61, 64]. This constraint can be achieved, for instance, through the utilization of symmetries [60, 62]—from an intuitive perspective, these strategies aim to limit the expressiveness of the ansatz, rendering it less akin to a global 2-design with respect to the Haar measure over the full  $n$ -qubit unitary group. Furthermore, it has been argued/conjectured that if one can prove absence of barren plateaus, then one should also be able to classically simulate the ansatz class [65], either with purely classical resources or after an initial data acquisition phase, which may require a quantum computer.

In the context of noisy scenarios, an important observation has been pointed out in Ref. [20], revealing that both expectation values and gradients experience exponential decay in the circuit depth. Consequently, at linear depth, the expectation values and gradients of cost functions decay exponentially with respect to the number of qubits. This phenomenon has been dubbed ‘noise-induced barren plateaus’. The results hold even without using randomness of the gates, i.e., for any fixed circuit. Significantly, this latter study assumed the presence of a local depolarizing noise model, which is unital in nature. Strikingly, even when employing error mitigation strategies, it appears challenging to effectively counteract the emergence of noise-induced barren plateaus, as argued in Ref. [104].

However, up to our knowledge, none of previous works has rigorously addressed a study for a general kind of local non-unital noise within our circuit model, and this is where our work comes in. As we will prove, the last  $O(\log(n))$  layers of the circuit are trainable, i.e., do not suffer from (sub-)exponentially vanishing partial derivatives, making the norm of the gradient of the cost function large overall. However, we will show that the partial derivatives taken are negligible. This is why we claim to be dealing with an ‘effective log-depth circuit’.

## 2. Gradients: useful lemmas

We now give a formula to compute directly the partial derivative, which can be useful to handle calculations. However, one might also take it as an equivalent definition of partial derivative.

**Lemma 39** (Partial derivative). *Let  $\mu \in [m]$ . Consider a parameterized 2-qubit gate  $\exp(-i\theta_\mu H_\mu)$ , positioned at the start of unitary layer  $\mathcal{U}_k$ , where  $k \in [L]$  is the index of the layer where the gate is positioned in the circuit. We have*

$$\partial_\mu C = i \operatorname{Tr} \left( \Phi_{[1,k-1]}(\rho_0) \left[ H_\mu, \Phi_{[k,L]}^*(H) \right] \right), \quad (\text{C5})$$

where we have denoted

$$\Phi_{[a,b]} := (\mathcal{V}_b^{\text{single}} \circ \mathcal{N}^{\otimes n} \circ \mathcal{U}_b) \circ \dots \circ (\mathcal{V}_a^{\text{single}} \circ \mathcal{N}^{\otimes n} \circ \mathcal{U}_a), \quad (\text{C6})$$

for  $a \leq b \in [L]$ .

*Proof.* We can write the cost function as

$$C = \operatorname{Tr}(\Phi(\rho_0)H) = \operatorname{Tr}(\Phi_{[1,k]} \circ \Phi_{[k,L]}(\rho_0)H) = \operatorname{Tr}(\Phi_{[k,L]}(\rho_0)\Phi_{[1,k]}^*(H)). \quad (\text{C7})$$

By taking the partial derivative with respect the parameter  $\theta_\mu$ , we have

$$\begin{aligned} \partial_\mu C &= \operatorname{Tr} \left( \Phi_{[1,k]}(\rho_0) \partial_\mu (\Phi_{[k,L]}^*(H)) \right) \\ &= i \operatorname{Tr} \left( \Phi_{[1,k]}(\rho_0) H_\mu \Phi_{[k,L]}^*(H) \right) - i \operatorname{Tr} \left( \Phi_{[1,k]}(\rho_0) \Phi_{[k,L]}^*(H) H_\mu \right) \\ &= i \operatorname{Tr} \left( \Phi_{[1,k]}(\rho_0) \left[ H_\mu, \Phi_{[k,L]}^*(H) \right] \right), \end{aligned} \quad (\text{C8})$$

where we have used the fact that  $\partial_\mu \exp(-i\theta_\mu H_\mu) = -iH_\mu \exp(-i\theta_\mu H_\mu)$ .  $\square$

From now on, when using the above formula for the partial derivatives, since we are considering second moment quantities, we will ignore the parametrized gates in the circuit, since they can be absorbed in the two-qubit 2-design layers. We now show that the expected value of the partial derivative with respect any parameter is zero.

**Lemma 40.** *The expected value of the partial derivative of the cost function is 0 with respect any parameter, i.e.,*

$$\mathbb{E}[\partial_\mu C] = 0. \quad (\text{C9})$$

*Proof.* Due to left and right invariance, the 2-qubit parameterized unitaries can be absorbed in the 2-design unitaries. Moreover, by Eq. (C5), we have

$$\partial_\mu C = i \operatorname{Tr} \left( \Phi_{[1,k]}(\rho_0) \left[ H_\mu, \Phi_{[k,L]}^*(H) \right] \right). \quad (\text{C10})$$

Since  $\Phi_{[k,L]}^*(H)$  ends with a layer of single-qubits 2-design gates and these form a 1-design (Lemma 15) by taking the expected value only over that layer, we have

$$\begin{aligned} \mathbb{E}[\partial_\mu C] &= i \operatorname{Tr} \left( \Phi_{[k,L]}(\rho_0) \left[ H_\mu, \mathbb{E} \left( \Phi_{[k,L]}^*(H) \right) \right] \right) \\ &= i \operatorname{Tr} \left( \Phi_{[k,L]}(\rho_0) \left[ H_\mu, \operatorname{Tr} \left( \Phi_{[k,L]}^*(H) \right) \frac{I_n}{2^n} \right] \right) \\ &= 0, \end{aligned} \quad (\text{C11})$$

where in the last equality we have used the first moment formula (Eq. (A9)) and the fact that any operator commutes with the identity.  $\square$

The previous Lemma implies that  $\operatorname{Var}[\partial_\mu C] = \mathbb{E}[(\partial_\mu C)^2]$ , so we care only about the latter quantity from now on. We now present a lemma, similar in spirit to Lemma 16, which will be useful to deal with upper and lower bounds of partial derivatives.

**Lemma 41** (Pauli mixing to Gradients). *Let  $H_\mu$  be a 2-local Hamiltonian. Let  $f(\cdot) := i \operatorname{Tr}\left(\Phi_{[1,k]}(\rho_0) \left[H_\mu, \Phi_{[k,L]}^*(\cdot)\right]\right)$  be an operator function. Then we have*

- Let  $H := \sum_{P \in \{I, X, Y, Z\}^{\otimes n}} a_P P$ , with  $a_P \in \mathbb{R}$  for any  $P \in \{I, X, Y, Z\}^{\otimes n}$ . We have

$$\mathbb{E}[(f(H))^2] = \sum_{P \in \{I, X, Y, Z\}^{\otimes n}} a_P^2 \mathbb{E}[(f(P))^2], \quad (\text{C12})$$

- Moreover, for any  $P \in \{I, X, Y, Z\}^{\otimes n}$ , we have

$$\mathbb{E}[(f(P))^2] = \frac{1}{3^{|P|}} \sum_{\substack{Q \in \{I, X, Y, Z\}^{\otimes n}: \\ \operatorname{supp}(Q) = \operatorname{supp}(P)}} \mathbb{E}[(f(Q))^2]. \quad (\text{C13})$$

*Proof.* We have

$$\begin{aligned} (f(H))^2 &= \left( i \operatorname{Tr}\left(\Phi_{[1,k]}(\rho_0) \left[H_\mu, \Phi_{[k,L]}^*(H)\right]\right) \right)^2 \\ &= \left( \sum_{P \in \{I, X, Y, Z\}^{\otimes n}} a_P \operatorname{Tr}\left(\Phi_{[1,k]}(\rho_0) \left[\Phi_{[k,L]}^*(P), H_\mu\right]\right) \right)^2 \\ &= \sum_{P, Q \in \{I, X, Y, Z\}^{\otimes n}} a_P a_Q \operatorname{Tr}\left(\Phi_{[1,k]}(\rho_0) \left[\Phi_{[k,L]}^*(P), H_\mu\right]\right) \operatorname{Tr}\left(\Phi_{[1,k]}(\rho_0) \left[\Phi_{[k,L]}^*(Q), H_\mu\right]\right) \\ &= \sum_{P, Q \in \{I, X, Y, Z\}^{\otimes n}} a_P a_Q \operatorname{Tr}\left(\Phi_{[1,k]}(\rho_0)^{\otimes 2} \left([\Phi_{[k,L]}^*(P), H_\mu] \otimes [\Phi_{[k,L]}^*(Q), H_\mu]\right)\right). \end{aligned} \quad (\text{C14})$$

We now consider the expected value of this quantity with respect the final unitary layer in  $\Phi_{[k,L]}^*$  (specifically, the layer that acts directly on  $P$  and  $Q$ ). Such expected value reduces to computing the expected value

$$\mathbb{E}\left([\Phi_{[k,L]}^*(P), H_\mu] \otimes [\Phi_{[k,L]}^*(Q), H_\mu]\right). \quad (\text{C15})$$

By expanding the two commutators, we have

$$\begin{aligned} &[\Phi_{[k,L]}^*(P), H_\mu] \otimes [\Phi_{[k,L]}^*(Q), H_\mu] \\ &= (\Phi_{[k,L]}^*(P) \otimes \Phi_{[k,L]}^*(Q))(H_\mu \otimes H_\mu) - (I_n \otimes H_\mu)(\Phi_{[k,L]}^*(P) \otimes \Phi_{[k,L]}^*(Q))(H_\mu \otimes I_n) \\ &\quad - (H_\mu \otimes I_n)(\Phi_{[k,L]}^*(P) \otimes \Phi_{[k,L]}^*(Q))(I_n \otimes H_\mu) + (H_\mu \otimes H_\mu)(\Phi_{[k,L]}^*(P) \otimes \Phi_{[k,L]}^*(Q)). \end{aligned} \quad (\text{C16})$$

Consequently, our attention can be directed solely towards the expression

$$\begin{aligned} \mathbb{E}(\Phi_{[k,L]}^*(P) \otimes \Phi_{[k,L]}^*(Q)) &= \mathbb{E}\left(\Phi_{[k,L]}^{*\otimes 2}(\mathbb{E}_{\mathcal{V}}(\mathcal{V}^{\text{single}}(P) \otimes \mathcal{V}^{\text{single}}(Q)))\right) \\ &= \delta_{P,Q} \mathbb{E}\left(\Phi_{[k,L]}^{*\otimes 2}(\mathbb{E}_{\mathcal{V}}(\mathcal{V}^{\text{single}}(P) \otimes \mathcal{V}^{\text{single}}(P)))\right) \\ &= \delta_{P,Q} \frac{1}{3^{|P|}} \sum_{\substack{R \in \{I, X, Y, Z\}^{\otimes n}: \\ \operatorname{supp}(R) = \operatorname{supp}(P)}} \mathbb{E}\left(\Phi_{[k,L]}^{*\otimes 2}(R \otimes R)\right) \\ &= \delta_{P,Q} \frac{1}{3^{|P|}} \sum_{\substack{R \in \{I, X, Y, Z\}^{\otimes n}: \\ \operatorname{supp}(R) = \operatorname{supp}(P)}} \mathbb{E}\left(\Phi_{[k,L]}^*(R) \otimes \Phi_{[k,L]}^*(R)\right) \end{aligned} \quad (\text{C17})$$

where in the first step we singled out ‘for free’ a layer of Haar random gates from  $\Phi_{[k,L]}^*$ , in the second step we applied the Pauli mixing formula Eq. (A14) for each of the single qubits gates (similarly as done in Lemma 16). Therefore, by substituting in Eq. (C16) and repeating the steps backwards, we can conclude.  $\square$

Because of the previous lemma, computing the variance of a cost function partial derivative defined with respect to a Hermitian operator reduces to computing the variance of a cost function partial derivative defined with respect to a Pauli operator. Consequently, we have the following corollary.

**Corollary 42** (Partial derivative variance of an Hamiltonian). *Let  $\mu \in [m]$  be the index of the parameter  $\theta_\mu$  which parametrize a gate in the  $k$ -th layer. Let  $H := \sum_{P \in \{I, X, Y, Z\}^{\otimes n}} a_P P$ , with  $a_P \in \mathbb{R}$  for any  $P \in \{I, X, Y, Z\}^{\otimes n}$ . We have*

$$\text{Var}[\partial_\mu C] = \sum_{P \in \{I, X, Y, Z\}^{\otimes n}} a_P^2 \text{Var}[\partial_\mu C_P], \quad (\text{C18})$$

where  $C_P := \text{Tr}(P\Phi(\rho_0))$  with  $\Phi$  and  $\rho_0$  are respectively the noisy quantum circuit and the initial state.

*Proof.* This follows immediately from Lemma 40 and Lemma 41.  $\square$

We now show a worst-case upper bound on the  $\alpha$ -th order partial derivative that will be useful later.

**Lemma 43** ( $\alpha$ -th order Partial derivative upper bound). *The  $\alpha$ -th order partial derivative with respect the parameter  $\theta_\mu$  is upper bounded by:*

$$|\partial_\mu^\alpha C| \leq 2^\alpha \|H\|_\infty \|H_\mu\|_\infty^\alpha \quad (\text{C19})$$

*Proof.* We have  $C = \text{Tr}(\Phi(\rho_0)H) = \text{Tr}(\Phi_{[1,k]}(\rho_0)\Phi_{[k,L]}^*(H))$ . Thus

$$\partial_\mu^\alpha C = \text{Tr}(\Phi_{[1,k]}(\rho_0) \partial_\mu^\alpha \Phi_{[k,L]}^*(H)). \quad (\text{C20})$$

Because of Hölder inequality, we have  $|\partial_\mu^\alpha C| \leq \|\partial_\mu^\alpha \Phi_{[k,L]}^*(H)\|_\infty$ , where we also used that the one-norm of a quantum state is one. We now prove by induction that

$$\|\partial_\mu^\alpha \Phi_{[k,L]}^*(H)\|_\infty \leq 2^\alpha \|H\|_\infty \|H_\mu\|_\infty^\alpha. \quad (\text{C21})$$

For  $\alpha = 1$ , we have

$$\partial_\mu \Phi_{[k,L]}^*(H) = i [H_\mu, \Phi_{[k,L]}^*(H)], \quad (\text{C22})$$

where we have used the fact that  $\partial_\mu \exp(-i\theta_\mu H_\mu) = -iH_\mu \exp(-i\theta_\mu H_\mu)$  as done in the proof of Lemma 39. Thus,

$$\|\partial_\mu \Phi_{[k,L]}^*(H)\|_\infty \leq 2 \|H_\mu\|_\infty \|\Phi_{[k,L]}^*(H)\|_\infty \leq 2 \|H_\mu\|_\infty \|H\|_\infty, \quad (\text{C23})$$

where we have used the triangle inequality, submultiplicativity of the  $p$ -norms and in the last step we have used the inequality  $\|\Phi^*(O)\|_\infty \leq \|O\|_\infty$  (see, e.g., Ref. [102]) valid for all operators  $O$ . This shows the base case. For  $\alpha > 1$ , we have

$$\|\partial_\mu^\alpha \Phi_{[k,L]}^*(H)\|_\infty = \|\partial_\mu^{\alpha-1} i [H_\mu, \Phi_{[k,L]}^*(H)]\|_\infty = \|[H_\mu, \partial_\mu^{\alpha-1} \Phi_{[k,L]}^*(H)]\|_\infty \leq 2 \|H_\mu\|_\infty \|\partial_\mu^{\alpha-1} \Phi_{[k,L]}^*(H)\|_\infty, \quad (\text{C24})$$

where in the last step we have used triangle inequality and submultiplicativity. We can conclude by the using the induction step.  $\square$

We introduce a precise definition of the standard notion of the light-cone of an observable with respect to a quantum channel (typically representing a quantum circuit).

**Definition 44** (Light cone). *Let  $H$  be an Hermitian operator and  $\Phi$  be a quantum channel. The light-cone of  $H$  with respect to  $\Phi$  is defined as*

$$\text{Light}(\Phi, H) := \text{supp}(\Phi^*(H)), \quad (\text{C25})$$

where  $\text{supp}(\cdot)$  is defined in our notation section.

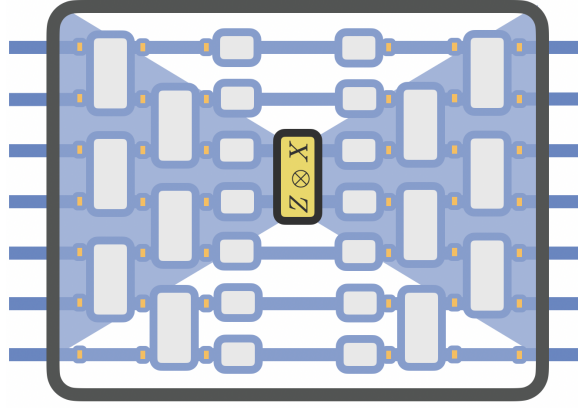

Figure 4. The light-cone of a local Pauli observable with respect to  $\Phi_{[1,L]}$  is the set of qubits within the shaded area. The (noisy) gates outside the blue shaded area are contracted trivially due to the fact that any adjoint channel is unital, and thus cannot influence the expectation value of the Pauli.

In the subsequent subsection, we need to consider the light cone not with respect to only a specific quantum circuit, but with respect to a family of quantum circuits provided by the support of a considered random quantum circuits probability distribution, denoted as  $\mathcal{F}$  (recall that the support of a random variable is defined as the set of all values for which the probability density function is strictly greater than zero). Formally, we define:

$$\text{Light}_{\mathcal{F}}(H) := \bigcup_{\Phi \in \mathcal{F}} \text{supp}(\Phi^*(H)). \quad (\text{C26})$$

In particular, we consider the family  $\mathcal{F}_k$  of quantum circuits corresponding to the support of the probability distribution associated with  $\Phi_{[k,L]}$ , where  $k \in [L]$ . To streamline the notation, we refer to  $\text{Light}_{\mathcal{F}_k}(H)$  as the ‘light-cone of  $H$  with respect to  $\Phi_{[k,L]}$ ’. In Fig. 4, we provide a graphical example for a one-dimensional geometrical local quantum circuit. We now give the following Lemma, which will be useful later on.

**Lemma 45** (Partial derivative is zero outside the light cone). *Let  $H$  be an Hermitian operator. Let  $\mu \in [m]$ . Consider a parameterized 2-qubit gate  $\exp(-i\theta_{\mu}H_{\mu})$ , positioned in the  $k$ -th layer, such that its Hamiltonian generator  $H_{\mu}$  has support outside the light cone of  $\Phi_{[k,L]}$  with respect to  $H$ . Then, the partial derivative is zero  $\partial_{\mu}C = 0$ .*

*Proof.* In words, the partial derivative must be zero since the cost function does not depend effectively by the gates outside the light-cone (because they contract trivially). However, formally this can be seen as follows. By using Eq. (C5), we have

$$\partial_{\mu}C = i \text{Tr} \left( \Phi_{[1,k]}(\rho_0) \left[ H_{\mu}, \Phi_{[k,L]}^*(H) \right] \right). \quad (\text{C27})$$

Since  $H_{\mu}$  has support outside the light cone of  $\Phi_{[k,L]}$  with respect to  $H$ , by definition of light-cone it follows that  $\left[ H_{\mu}, \Phi_{[k,L]}^*(H) \right] = 0$ .  $\square$

### 3. Absence of barren plateaus, but only few layers are trainable

In this subsection, we will show that the gates in the last  $\Theta(\log(n))$  layers (in the light cone of a local observable) are the only trainable gates of the circuits. This also implies that the expectation value of an observable can be significantly influenced only by such gates in the last layers. We first state our main claims here, which will then be detailed further. Leveraging Lemma 42, we focus on cost functions associated with Pauli observables instead of general Hermitian operator, without loss of generality. In Subsection C3a, we present the following upper bound assuming constant noise parameters:

**Theorem 46** (Layers before  $\Theta(\log(n))$  layers are not trainable). *Let  $C := \text{Tr}(P\Phi(\rho_0))$  be the cost function, where  $P \in \{I, X, Y, Z\}^{\otimes n}$ ,  $\rho_0$  is an arbitrary initial state, and  $\Phi$  is a noisy quantum circuit of depth  $L$ . We assume that the noise is not a unitary channel. Let  $\mu$  denote a parameter of a gate in the  $k$ -th layer of the circuit. Then, we have*

$$\text{Var}[\partial_{\mu}C] \leq \exp(-\Omega(|P| + L - k)). \quad (\text{C28})$$

This result immediately implies that the gates before the last  $\Theta(\log(n))$  layers are not trainable. Moreover, it directly implies barren plateaus for global cost functions.

**Corollary 47** (Global cost function induced barren plateaus). *Let  $C$  be the cost function associated with a Pauli  $P$  with  $|P| = \Theta(n)$ . Then, we have  $\text{Var}[\partial_\mu C] \leq \exp(-\Omega(n))$*

In subSubsection C 3 a, we establish the following lower bound assuming constant noise parameters.

**Theorem 48** (Last  $\Theta(\log(n))$  layers do matter). *Let  $C := \text{Tr}(P\Phi(\rho_0))$  be the cost function, where  $P \in \{I, X, Y, Z\}^{\otimes n}$ ,  $\rho_0$  is an arbitrary state, and  $\Phi$  is a non-unital noisy geometrically local quantum circuit of depth  $L$  in constant dimension. We assume noise is not a replacer channel. Let  $\mu$  denote a parameter of a gate in the  $k$ -th layer of the circuit. Then, if the support of such a gate is contained in the light cone of  $\Phi_{[k,L]}$  with respect to the Pauli  $P$ , we have*

$$\text{Var}[\partial_\mu C] \geq \exp(-O(|P|(L-k))), \quad (\text{C29})$$

otherwise, if the support of the parametrized gate is outside the light cone, we have  $\text{Var}[\partial_\mu C] = 0$ .

Note that the variance upper and lower bounds are matched for local cost functions (i.e.,  $|P| = O(1)$ ). Moreover, the latter theorem leads to the following corollary affirming the absence of barren plateaus for local cost functions:

**Corollary 49** (Absence of barren plateaus for local cost functions). *Let  $C$  be a cost function associated with a local Pauli  $P$ , and a geometrically local quantum circuit of any depth in constant dimension. We assume non-unital noise and that is not a replacer channel. Then, we have*

$$\mathbb{E}\left[\|\nabla C\|_2^2\right] \geq \Omega(1). \quad (\text{C30})$$

However, this absence of barren plateaus in arbitrarily deep quantum circuit is only due to the last  $\Theta(\log(n))$  layers which significantly influence the expectation value of local observables. Furthermore, in Subsection C 4, we show improved upper bound for the onset of barren plateaus in the unital noise scenario, improving upon previous works [20].

*a. Partial derivative upper bound: Layers before the last  $O(\log(n))$  are not trainable*

We are now going to show the upper bound on the partial derivative. Here, we do not make any assumption on the geometrical locality of the circuit.

**Proposition 50** (Partial Derivative Upper Bound). *Let  $C := \text{Tr}(P\Phi(\rho_0))$  be the cost function, where  $P \in \{I, X, Y, Z\}^{\otimes n}$ ,  $\rho_0$  is an arbitrary initial state, and  $\Phi$  is a noisy quantum circuit of depth  $L$ . We assume that the noise is not a unitary channel. Let  $\mu$  denote a parameter of a gate in the  $k$ -th layer of the circuit. Then, we have*

$$\text{Var}[\partial_\mu C] \leq 4c^{(|P|+L-k-1)}. \quad (\text{C31})$$

*Proof. Proof method 1:* We show first a shorter and more immediate proof method, which yields a slightly worse upper bound  $O(c^{(|P|+L-k-1)/3})$  albeit always with the desired exponential scaling. Let  $K := L - k$ . We have  $\text{Var}[\partial_\mu C] = \mathbb{E}[(\partial_\mu C)^2]$  due to Eq. (C19). Due to the Taylor remainder theorem and for any three differentiable functions  $f(x)$ , this relationship can be expressed using standard finite-difference formulas (see, e.g., here):

$$|\partial f(x)| \leq \left| \frac{f(x+h) - f(x-h)}{2h} \right| + \frac{h^2}{6} |\text{sup}(\partial^3 f)|, \quad (\text{C32})$$

for any  $h \in [0, \infty)$ . Hence

$$\begin{aligned} (\partial f(x))^2 &\leq \left| \frac{f(x+h) - f(x-h)}{2h} \right|^2 + \frac{h^4}{36} |\text{sup}(\partial^3 f)|^2 + 2 \left| \frac{f(x+h) - f(x-h)}{2h} \right| \frac{h^2}{3} |\text{sup}(\partial^3 f)| \\ &\leq \left| \frac{f(x+h) - f(x-h)}{2h} \right|^2 + \frac{h^4}{36} |\text{sup}(\partial^3 f)|^2 + \frac{h}{3} |\text{sup}(f)| |\text{sup}(\partial^3 f)| \end{aligned} \quad (\text{C33})$$

By using this for our function  $C$  with respect the parameter  $\theta_\mu$ , taking the expected values both terms and using Lemma 43, we have

$$\mathbb{E}(\partial_\mu C)^2 \leq \mathbb{E} \left| \frac{\text{Tr}(P\Phi_{[L-K+1,L]}(\rho)) - \text{Tr}(P\Phi_{[L-K+1,L]}(\sigma))}{2h} \right|^2 + 2^6 \frac{h^4}{36} \|H_\mu\|_\infty^6 + 2^3 \frac{h}{3} \|H_\mu\|_\infty^3 \quad (\text{C34})$$

$$\begin{aligned}
&\leq \frac{1}{4h^2} c^{K+|P|-1} + 4h^4 \|H_\mu\|_\infty^6 + 4h \|H_\mu\|_\infty^3 \\
&\leq \frac{1}{4} c^{(K+|P|-1)/3} + 8c^{(K+|P|-1)/3} \\
&\leq 9c^{(K+|P|-1)/3},
\end{aligned}$$

where we have defined  $\rho$  and  $\sigma$  to be defined as the state  $\text{Tr}(P\Phi_{[1,L-K]}(\rho_0))$  computed respectively respectively in  $\theta_\mu + h$  and  $\theta_\mu - h$ , and we have chosen  $h := c^{(K+|P|)/3}$ .

**Proof method 2:** We now establish a tighter upper bound using the partial derivative formula involving the commutator (Eq. (C5)). The proof follows a similar spirit to the one used in Proposition 27 (i.e., effective depth). Instead of using Lemma 16 (as in the effective depth proof), we employ the analogous Lemma 41. First, we have

$$\text{Var}[\partial_\mu C] = \mathbb{E}[(\partial_\mu C)^2] = \mathbb{E}[f_0(P)^2], \quad (\text{C35})$$

where we define the function

$$f_j(\cdot) := i \text{Tr} \left( \Phi_{[1,k]}(\rho_0) \left[ H_\mu, \Phi_{[k,L-j]}^*(\cdot) \right] \right). \quad (\text{C36})$$

Using Lemma 41 and averaging over the last layer of single qubit gates in  $\Phi_{[k,L]}^*$ , we have

$$\mathbb{E}[(f_0(P)^2)] = \frac{1}{3^{|P|}} \sum_{\substack{Q \in \{I,X,Y,Z\}^{\otimes n}: \\ \text{supp}(Q) = \text{supp}(P)}} \mathbb{E}[(f_0(Q))^2]. \quad (\text{C37})$$

Let us focus on  $\mathbb{E}[(f_0(Q))^2]$ . Taking the adjoint of the last layer of noise on  $Q$ , we have

$$\mathcal{N}^{*\otimes n}(Q) = \bigotimes_{j \in \text{supp}(Q)} (t_{Q_j} I_j + D_{Q_j} Q_j) = \sum_{a \in \{0,1\}^{|\text{Q}|}} \bigotimes_{j \in \text{supp}(Q)} (t_{Q_j}^{a_j} D_{Q_j}^{1-a_j} Q_j^{1-a_j}). \quad (\text{C38})$$

We define the function  $f'_j(\cdot)$  as

$$f'_j(\cdot) := i \text{Tr} \left( \Phi_{[1,k]}(\rho_0) \left[ H_\mu, \Phi_{[k,L-j]}'^*(\cdot) \right] \right), \quad (\text{C39})$$

where  $\Phi_{[k,L-j]}'$  is equal to  $\Phi_{[k,L-j]}$  but without the last layer of single qubit gates and noise. Applying Lemma 41 again, we have

$$\begin{aligned}
\mathbb{E}[(f_0(Q))^2] &= \sum_{a \in \{0,1\}^{|\text{Q}|}} \prod_{j \in \text{supp}(Q)} t_{Q_j}^{2a_j} D_{Q_j}^{2(1-a_j)} \mathbb{E}[(f'_0(\bigotimes_{j \in \text{supp}(Q)} Q_j^{1-a_j}))^2] \\
&\leq \sum_{a \in \{0,1\}^{|\text{Q}|}} \prod_{j \in \text{supp}(Q)} t_{Q_j}^{2a_j} D_{Q_j}^{2(1-a_j)} \max_{R \in \{I,X,Y,Z\}^{\otimes n}} \mathbb{E}[(f'_0(R))^2].
\end{aligned} \quad (\text{C40})$$

Substituting, we have

$$\begin{aligned}
\mathbb{E}[(f_0(P)^2)] &= \frac{1}{3^{|P|}} \sum_{\substack{Q \in \{I,X,Y,Z\}^{\otimes n}: \\ \text{supp}(Q) = \text{supp}(P)}} \mathbb{E}[(f_0(Q))^2] \\
&\leq \frac{1}{3^{|P|}} \sum_{\substack{Q \in \{I,X,Y,Z\}^{\otimes n}: \\ \text{supp}(Q) = \text{supp}(P)}} \sum_{a \in \{0,1\}^{|\text{Q}|}} \prod_{j \in \text{supp}(Q)} t_{Q_j}^{2a_j} D_{Q_j}^{2(1-a_j)} \max_{R \in \{I,X,Y,Z\}^{\otimes n}} \mathbb{E}[(f'_0(R))^2] \\
&= c^{|P|} \max_{R \in \{I,X,Y,Z\}^{\otimes n}} \mathbb{E}[(f'_0(R))^2],
\end{aligned} \quad (\text{C41})$$

where we have used the multinomial theorem together with the fact that

$$c = \frac{1}{3^{|P|}} (\|\mathbf{D}\|_2^2 + \|\mathbf{t}\|_2^2). \quad (\text{C42})$$

As in the proof of Proposition 27, we can assume that the maximum over Pauli in the latter equation is achieved by a Pauli different from the identity (otherwise the RHS would be zero). Moreover, we can assume now that all the two-qubit gates in the circuit are Clifford, as we are computing a second moment, and the Cliffords form a 2-design. Thus, the two qubit gates of the circuit will also map Pauli to Pauli. Therefore, the Pauli above will be mapped by the two-qubits Clifford to another Pauli still different from the identity. Since now we have a circuit that ends with a layer of single qubits 2-design unitaries, which are preceded by a noise layer and a layer of two-qubits 2-design gates, we are in the same situation we faced at the beginning of the proof with

$$\mathbb{E}[(f_0(P))^2] \leq c^{|P|} \max_{Q \in \{I, X, Y, Z\}^{\otimes n} \setminus I_n} \mathbb{E}[(f_1(Q))^2]. \quad (\text{C43})$$

So reiterating the argument to the next layers, and using that the Pauli weight of the considered Pauli at each iteration is at least one, we have

$$\mathbb{E}[(f_0(P))^2] \leq c^{|P|+L-k-1} \max_{Q \in \{I, X, Y, Z\}^{\otimes n} \setminus I_n} \mathbb{E}[(f_{L-k}(Q))^2]. \quad (\text{C44})$$

By using the definition of  $f_{L-k}(\cdot)$ , we have

$$\begin{aligned} \mathbb{E}[(f_0(P))^2] &\leq c^{|P|+L-k-1} \mathbb{E} \max_{Q \in \{I, X, Y, Z\}^{\otimes n} \setminus I_n} (i \text{Tr}(\Phi_{[1,k]}(\rho_0) [H_\mu, Q]))^2 \\ &\leq c^{|P|+L-k-1} \max_{Q \in \{I, X, Y, Z\}^{\otimes n} \setminus I_n} \mathbb{E} \|\Phi_{[1,k]}(\rho_0)\|_1^2 \| [H_\mu, Q] \|_\infty^2 \\ &\leq 4c^{|P|+L-k-1} \max_{Q \in \{I, X, Y, Z\}^{\otimes n} \setminus I_n} \|H_\mu\|_\infty^2 \|Q\|_\infty^2 \\ &\leq 4c^{|P|+L-k-1}, \end{aligned} \quad (\text{C45})$$

where we have used the Hölder inequality in the second step, submultiplicativity of the infinity norm in the third step, and in the last step the fact that all the involved norms are  $\leq 1$ .  $\square$

We point out that the previous statement could also have been proved using the Parameter Shift Rule [105] assuming a restricted class of parameterized gates, that is, of the form  $\exp(i\theta_\mu H_\mu)$ , with  $H_\mu$  such that  $H_\mu^2 = I$ . But for the sake of generality we decided to use the proof methods presented. In this connection, note that the parameter shift rule also applies to noisy circuits, as can be seen, e.g., by making use standard Stinespring dilation arguments.

We point out that by applying Chebyshev's inequality, the upper bound on the variance can be translated into the probability statement:

$$\text{Prob}(|\partial_\mu C| > \varepsilon) \leq \frac{\text{Var}[\partial_\mu C]}{\varepsilon^2} \leq \frac{4}{\varepsilon^2} c^{|P|+L-k-1}. \quad (\text{C46})$$

This equation implies that the probability of sampling a point in the parameters space such that the absolute value of the partial derivative is greater than  $\varepsilon$  decays exponentially with both the Pauli weight  $|P|$  and  $L-k$ , which is the distance from the end of the circuit to the layer where the partial derivative is taken.

The previous proposition also directly implies that cost functions associated with global Pauli operators (i.e.,  $\Theta(n)$  Pauli weight) have all partial derivatives exponentially vanishing in the number of qubits.

**Corollary 51** (Global cost function induced barren plateaus). *Let  $C$  be a cost function associated with a global Pauli operator, i.e., with  $|P| = \Theta(n)$ . Let  $\mu$  denote a parameter of a gate in any of the layers. Then, we have*

$$\text{Var}[\partial_\mu C] \leq \exp(-\Omega(n)). \quad (\text{C47})$$

*b. Partial derivative lower bound: the last  $\Theta(\log(n))$  layers are the only trainable*

Here, we establish a lower bound on the partial derivative variance, assuming a geometrically local circuit in any constant dimension, such as the brickwork structure for one dimension, as illustrated in Fig. 2. The proof technique employed here is novel and may be of independent interest, allowing lower bounds on other second or third moment quantities of noisy random quantum circuits. In summary, dealing with a second-moment quantity and considering all 2-qubit gates in the circuit as local 2-designs (effectively Clifford gates), we condition on specific *Clifford choices* among various combinations to obtain a non-trivial lower bound.

Here, we assume that the noise is non-unital (i.e.,  $\|\mathbf{t}\|_2 = \Theta(1)$ ) and that the noise is not a replacer channel (i.e., the noise parameter  $\|\mathbf{D}\|_2$  is a non-zero constant).



**Proposition 52** (Partial derivative lower bound). *Let  $C := \text{Tr}(P\Phi(\rho_0))$  be the cost function, where  $P \in \{I, X, Y, Z\}^{\otimes n}$ ,  $\rho_0$  is an arbitrary initial state, and  $\Phi$  is a non-unital noisy geometrically local quantum circuit of depth  $L$  in constant dimension (e.g., two-dimensional). We also assume that the noise is not a replacer channel (otherwise, any partial derivative would be zero). Let  $\mu$  denote the parameter  $\theta_\mu$  of the gate  $\exp(-i\theta_\mu H_\mu)$  in the  $k$ -th layer of the circuit. Then, if the support of such a gate is contained in the light cone of  $\Phi_{[k,L]}$  with respect to the Pauli  $P$ , we have*

$$\text{Var}[\partial_\mu C] \geq \exp(-\Theta(|P|(L-k))), \quad (\text{C48})$$

otherwise, if the support of the parametrized gate is outside the light cone, we have  $\text{Var}[\partial_\mu C] = 0$ .

*Proof.* If the support of the parametrized gate is outside the light cone,  $\partial_\mu C = 0$ , as stated in Lemma 45. Therefore, we focus on the case in which the gate is within the light cone. By employing Lemma 40 and 39 to express the variance of the partial derivative, we have

$$\text{Var}[\partial_\mu C] = \mathbb{E}[(\partial_\mu C)^2] = \mathbb{E}[f_0(P)^2]. \quad (\text{C49})$$

Here,  $f_j(\cdot) := i \text{Tr}\left(\Phi_{[1,k]}(\rho_0) \left[H_\mu, \Phi_{[k,L-j]}^*(\cdot)\right]\right)$ . It is noteworthy that  $\tilde{O} := i \left[H_\mu, \Phi_{[k,L]}^*(P)\right]$  is a Hermitian operator with locality  $|\tilde{O}| = O(L-k+|P|)$  because of light-cone arguments. Based on this, one might be tempted to directly apply Theorem 20 to lower-bound the variance of the expectation value  $\text{Tr}\left(\Phi_{[1,k]}(\rho_0)\tilde{O}\right)$  by  $\exp(-\Theta(|\tilde{O}|))$ . However, the analysis becomes more intricate as  $\tilde{O}$  could be zero for certain gate configurations, and Theorem 20 assumes non-zero observables. Therefore, a more fine-grained analysis is required. By applying Lemma 41 and averaging over the last layer of single-qubit gates in  $\Phi_{[k,L]}^*$ , we arrive at:

$$\text{Var}[\partial_\mu C] = \frac{1}{3^{|P|}} \sum_{\substack{R \in \{I, X, Y, Z\}^{\otimes n} \\ \text{supp}(R) = \text{supp}(P)}} \mathbb{E}[(f_0(R))^2] \geq \frac{1}{3^{|P|}} (\mathbb{E}[(f_0(P_X))^2] + \mathbb{E}[(f_0(P_Y))^2] + \mathbb{E}[(f_0(P_Z))^2]), \quad (\text{C50})$$

where  $P_X := \bigotimes_{j \in \text{supp}(P)} X_j$ , and  $P_Y, P_Z$  are similarly defined. Focusing on  $\mathbb{E}[(f_0(P_X))^2]$ , we define the function  $f'_j(\cdot)$  as

$$f'_j(\cdot) := i \text{Tr}\left(\Phi_{[1,k]}(\rho_0) \left[H_\mu, \Phi_{[k,L-j]}^*(\cdot)\right]\right), \quad (\text{C51})$$

with  $\Phi'_{[k,L-j]}$  identical to  $\Phi_{[k,L-j]}$  but lacking the last layer of single-qubit gates and noise. Taking the adjoint of the last layer of noise on  $P_X$  and applying Lemma 41 again, we obtain

$$\mathbb{E}[(f_0(P_X))^2] = \sum_{a \in \{0,1\}^{|P_X|}} \prod_{j \in \text{supp}(P_X)} t_{(P_X)_j}^{2a_j} D_{(P_X)_j}^{2(1-a_j)} \mathbb{E}[(f'_0(\bigotimes_{j \in \text{supp}(P_X)} (P_X)_j^{1-a_j}))^2] \quad (\text{C52})$$

$$\geq D_X^{2|P|} \mathbb{E}[(f'_0(P_X))^2]. \quad (\text{C53})$$

Now, we delve into the technical part of this proof. As is customary when dealing with second-moment quantities, we treat our circuits as random Clifford circuits. The ultimate goal is to ensure that the commutator  $\left[H_\mu, \Phi_{[k,L-j]}^*(\cdot)\right]$  is non-zero for some Clifford gate instances. To achieve this, we fix *some* of the 2-qubits Clifford gates in the circuit. However, caution is required not to fix all the Clifford gates, as this would result in unfavorable scaling. Specifically, each 2-qubit Clifford  $C_{\text{fixed}}$  that we fixed in the circuit contributes a factor of  $|\mathcal{C}_2|^{-1}$ , where  $|\mathcal{C}_2|$  is the size of the 2-qubit Clifford group  $\mathcal{C}_2$ . This is expressed by the lower bound

$$\mathbb{E}_{C \sim \mathcal{C}_2} [g(C)] = \frac{1}{|\mathcal{C}_2|} \sum_{C \in \mathcal{C}_2} (g(C))^2 \geq \frac{1}{|\mathcal{C}_2|} (g(C_{\text{fixed}}))^2, \quad (\text{C54})$$

for any real function  $g(\cdot)$ . Now, we proceed to fix the Cliffords in the circuit. The strategy involves fixing a few Cliffords such that: 1) one of the single-qubit Pauli in the Pauli decomposition of  $P_X$  is connected with  $H_\mu$  by a path of Clifford gates (which will be responsible for making the commutator non-zero), 2) the chosen Cliffords ‘protect the Pauli’, i.e., they ensure the Pauli weight  $|P|$  does not increase throughout the application of the unitary layer, 3) at each layer iteratively, as done in Eq. (C53), we select only the Pauli operators that have all  $X$  in their support that arises when we take the adjoint of the noise. Thus, this would give rise to the lower bound

$$\mathbb{E}[(f_0(P_X))^2] \geq \frac{1}{|\mathcal{C}_2|^{\#\text{fixed clifford}}} D_X^{2|P|(L-k+1)} \mathbb{E}[(f_k(\mathcal{V}^{\text{single}}(\tilde{P}_X))^2]. \quad (\text{C55})$$

where  $\tilde{P}_X$  represents a Pauli operator that has been mapped by all the Clifford circuit, and  $\mathcal{V}^{\text{single}}$  is a single-qubit layer of random gates. The term  $(D_X^{2|P|})^{(L-k+1)}$  represents the factor obtained at each of the  $L - k + 1$  layers when encountering a layer of noise, applying Eq. (C53), and utilizing the fact that the Pauli weight does not increase in the ‘Clifford path’. Note that

$$f_k(\mathcal{V}^{\text{single}}(\tilde{P}_X)) = \left( \Phi_{[1,k]}(\rho_0) i \left[ H_\mu, \mathcal{V}^{\text{single}}(\tilde{P}_X) \right] \right) \quad (\text{C56})$$

We now show the existence of this particular Clifford gates choice that satisfy the listed desiderata, by fixing some of the 2-qubit gates to be the identity gate or the SWAP gate (noting that the SWAP gate is Clifford, as it can be expressed as a combination of 3 CNOT gates).

Since  $H_\mu$  is in the light-cone with respect to  $\Phi_{[k,L]}$ , by definition, there must exist a path of 2-qubit (Clifford) gates that connects  $H_\mu$  with one of the single-qubit Paulis  $X$  appearing in the tensor product decomposition of  $P_X$ . Let us choose one such path connecting  $H_\mu$  with a specific single-qubit Pauli  $X$ . We can fix each 2-qubit gate in this path to be the SWAP gate or the identity gate, in such a way that the  $X$  gate has the support overlapping with  $H_\mu$ . The number of gates in this Clifford path is  $L - k + 1$ . Next, we fix other Cliffords in the circuit to be trivial Identity  $I$  Clifford gates, specifically those connecting *perpendicularly to the layers* with the remaining Paulis  $X$  in the tensor product decomposition of  $P_X$ . See Figure 5 for an example. Consequently, the non-trivial Pauli  $\tilde{P}_X$  remains the same as before, but one of its  $X$  Paulis is swapped to a position where it acts non-trivially with  $H_\mu$ . The count of fixed Cliffords in the circuit is then given by

$$\# \text{ fixed Cliffords} \leq |P|(L - k + 1), \quad (\text{C57})$$

since, at each layer (of which there are  $L - k + 1$ ), we fix at most one gate for each of the single-qubit Paulis in the Pauli decomposition of  $P_X$ . Now, we utilize the last layer of single-qubit random gates to map the  $X$  Pauli, which is now in the support of  $H_\mu$ , to a Pauli that does not commute with  $H_\mu$ . Note that such a Pauli exists, as any operator commuting with all the Paulis should be the identity. However,  $H_\mu$  cannot be the identity (on the qubit on which it interacts with  $X$ ) because that would contradict the assumption that the support of  $H_\mu$  is in the light-cone. We denote the resulting Pauli as  $Q$ . Thus, by repeating the same for  $P_Y$  and  $P_Z$ , and mapping them at the end to  $Q$ , we

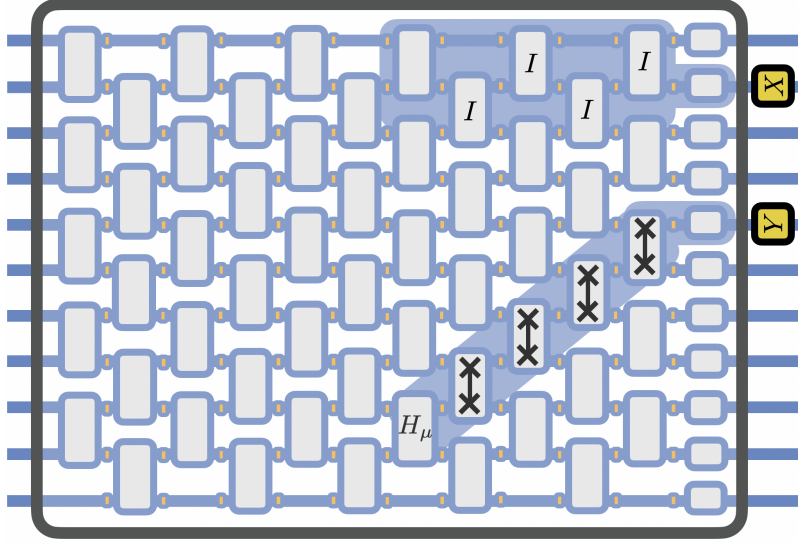

Figure 5. Example of Clifford path choices. The shaded region indicates the fixed Clifford gates. Note that we choose some Clifford gates to be SWAP gates so that they connect one of the Paulis to  $H_\mu$ . We protect the other remaining Pauli from spreading across the circuit with identity Clifford gates.

have the lower bound

$$\text{Var}[\partial_\mu C] \geq \frac{1}{|C_2|^{|P|(L-k+1)}} \frac{1}{3^{|P|}} \left( D_X^{2|P|(L-k+1)} + D_Y^{2|P|(L-k+1)} + D_Z^{2|P|(L-k+1)} \right) \mathbb{E}(\text{Tr}(\Phi_{[1,k]}(\rho_0) i [H_\mu, Q]))^2.$$

Since  $H_\mu$  is a 2-qubit gate, it can be expanded in its 2-qubits Pauli decomposition, as

$$H_\mu = \sum_{R \in \{I, X, Y, Z\}^{\otimes 2}} b_R R, \quad (\text{C58})$$

Thus, substituting and using Lemma 16, we have

$$\mathbb{E}(\text{Tr}(\Phi_{[1,k]}(\rho_0) i [H_\mu, Q]))^2 = \sum_{R \in \{I, X, Y, Z\}^{\otimes 2}} b_R^2 \mathbb{E}(\text{Tr}(\Phi_{[1,k]}(\rho_0) Q_R))^2, \quad (\text{C59})$$

where we defined  $Q_R := i[R, Q]$ . Here we note that  $Q_R$  is a Hermitian operator, and in particular, it is a Pauli operator (or the zero operator). Thus, we have

$$\begin{aligned} \mathbb{E}(\text{Tr}(\Phi_{[1,k]}(\rho_0) i [H_\mu, Q]))^2 &= \sum_{R \in \{I, X, Y, Z\}^{\otimes 2}} b_R^2 \mathbb{E}(\text{Tr}(\Phi_{[1,k]}(\rho_0) Q_R))^2 \\ &\geq \sum_{R \in \{I, X, Y, Z\}^{\otimes 2}} b_R^2 \|\mathbf{t}\|_2^{2|Q_R|}, \\ &\geq \|\mathbf{t}\|_2^{2(|P|+1)} \sum_{R \in \{I, X, Y, Z\}^{\otimes 2}} b_R^2 \end{aligned} \quad (\text{C60})$$

where in the second step we have used the lower bound on variance expectation values derived in Proposition 23, in the last step we observed that  $|Q_R| \leq |P| + 1$  and used that  $\|\mathbf{t}\|_2 \leq 1$  (Lemma 17). Now we observe that

$$\sum_{R \in \{I, X, Y, Z\}^{\otimes 2}} b_R^2 = \frac{1}{2} \|H_\mu\|_2 \geq \frac{1}{2} \|H_\mu\|_\infty. \quad (\text{C61})$$

Putting everything together, we have

$$\text{Var}[\partial_\mu C] \geq \frac{1}{|\mathcal{C}_2|^{|P|(L-k+1)}} \frac{1}{3^{|P|}} \left( D_X^{2|P|(L-k+1)} + D_Y^{2|P|(L-k+1)} + D_Z^{2|P|(L-k+1)} \right) \frac{1}{2} \|H_\mu\|_\infty \|\mathbf{t}\|_2^{2(|P|+1)}.$$

We note that if all the entries of  $\mathbf{D} = (D_X, D_Y, D_Z)$  are equal to zero, then the noise is a replacer channel. This because it holds that

$$\mathcal{N}\left(\frac{I + \mathbf{w} \cdot \boldsymbol{\sigma}}{2}\right) = \frac{I}{2} + \frac{1}{2}(\mathbf{t} + D\mathbf{w}) \cdot \boldsymbol{\sigma},$$

where  $D = \text{diag}(\mathbf{D})$ ,  $\mathcal{N}$  is a single-qubit noise channel, and  $\frac{I + \mathbf{w} \cdot \boldsymbol{\sigma}}{2}$  represents a density matrix for  $\|\mathbf{w}\|_2 \leq 1$  (see Eq. (A40)). However for assumption, the noise cannot be a replacer channel and so at least one of the entries of  $\mathbf{D}$ , say  $D_X$ , should be nonzero. Further lower bounding, we get

$$\text{Var}[\partial_\mu C] \geq \sum_{Q \in \{X, Y, Z\}} \frac{1}{2} \left( \frac{D_Q^2 \|\mathbf{t}\|_2^2}{3|\mathcal{C}_2|} \right)^{|P|(L-k+1)} \|H_\mu\|_\infty.$$

This quantity has the claimed scaling, so we can conclude the proof.  $\square$

It might be useful to give the same scaling without the asymptotic notation.

**Remark 53** (Scaling without asymptotic notation). *The lower bound (without the asymptotic notation) we found in the previous Proposition 52 on the partial derivative with respect the parameter  $\theta_\mu$  of the gate  $\exp(-i\theta_\mu H_\mu)$  in the  $k$ -layer of a  $L$ -depth circuit is:*

$$\text{Var}[\partial_\mu C] \geq \sum_{Q \in \{X, Y, Z\}} \frac{1}{2} \left( \frac{D_Q^2 \|\mathbf{t}\|_2^2}{3|\mathcal{C}_2|} \right)^{|P|(L-k+1)} \|H_\mu\|_\infty,$$

where  $\mathbf{D}$  and  $\mathbf{t}$  are the noise parameters (see Lemma 17),  $|\mathcal{C}_2|$  is the size of the 2-qubits Clifford group.

We note that even if the non-unital noise rate  $\|\mathbf{t}\|_2$  is polynomially small in the number of qubits, then the derived lower bound still indicates absence of barren plateaus (due to the last few layers). Proposition 52 readily leads to the following conclusion regarding a lower bound on the expected value of the 2-norm of the gradient.

**Corollary 54** (Lower bound on the expected value of the 2-norm of the gradient). *Let us consider a cost function associated to a local Pauli  $P$  with  $|P| = \Theta(1)$ , and the same assumption as in Proposition 52. Then, we have*

$$\mathbb{E}[\|\nabla C\|_2^2] \geq \Omega(1). \quad (\text{C62})$$

*Proof.* The proof follows immediately by focusing only on the last parameter  $\theta_m$  of the last layer (which gate is in the light cone of  $P$ ). In particular, we have

$$\mathbb{E}[\|\nabla C\|_2^2] \geq \sum_{\mu=1}^m \mathbb{E}[\partial_\mu C^2] \geq \mathbb{E}[\partial_m C^2] = \text{Var}[\partial_m C^2] \geq \Omega(1), \quad (\text{C63})$$

where we have used the fact that the partial derivative has zero mean and Proposition 52.  $\square$

We can now rephrase our previous result in terms of a probability statement.

**Corollary 55** (Probability statement). *Assuming that the cost function has a number of free parameters upper bounded by  $O(\text{poly}(n))$ , we have*

$$\text{Prob}\left(\|\nabla C\|_2^2 > \Omega(1)\right) \geq \Omega(1/\text{poly}(n)). \quad (\text{C64})$$

*Proof.* By applying the probability inequality in Lemma 65 with  $f := \|\nabla C\|_2^2$  and utilizing Corollary 54, we arrive at

$$\text{Prob}\left(\|\nabla C\|_2^2 > \Omega(1)\right) \geq \frac{\Omega(1)}{\sup(\|\nabla C\|_2^2)}. \quad (\text{C65})$$

In order to conclude, we need to establish an upper bound for  $\sup(\|\nabla C\|_2^2)$ . This upper bound can be derived as

$$\sup(\|\nabla C\|_2^2) \leq m \max_{\mu \in [m]} (\partial_\mu C)^2 \leq 4m \max_{\mu \in [m]} \|H_\mu\|_\infty^2 \|P\|_\infty^2 \leq 4m. \quad (\text{C66})$$

In this equation,  $m$  represents the number of parameters, and we employ Lemma 43 in the final step.  $\square$

In summary, we have shown that the probability of sampling an instance of a circuit in which the gradient is larger than a constant is not exponentially small. However, it is important to stress that achieving a large average gradient norm can be accomplished by focusing on the last layers. In fact, the components corresponding to the initial layers of a linear depth circuit are exponentially small.

#### 4. Improved upper bounds for unital noise

In this section, we present improved upper bounds on the barren plateaus phenomenon in the context of random quantum circuit ansatz with unital noise. Our derived bounds are tighter compared to those presented in Ref. [20]. Notably, our approach leverages the randomness of the circuit, whereas [20] relied solely on the contraction property of the unital noise channel analyzed. We start by showing the variance of expectation values in the case of random quantum circuits with unital noise. Up to our knowledge, this was not known before. The noiseless case was instead addressed in Ref. [48]. In the following, due to Lemma 16, we can focus on Pauli observables without loss of generality.

**Proposition 56** (Improved expectation values concentration for unital noise). *Let  $P \in \{I, X, Y, Z\}^{\otimes n}$ ,  $\rho_0$  be any quantum state, and  $L$  be the depth of the noisy circuit  $\Phi$  defined in Eq. (A51) in arbitrary dimension. Specifically, we assume that the noise is unital. Then, we have*

$$\text{Var}[\text{Tr}(P\Phi(\rho_0))] \leq 4c^{|P|+L-1}, \quad (\text{C67})$$

where the parameter  $c$  is defined in Eq. (B15).

*Proof.* Because our circuit ends with a layer of random single-qubit gates, it holds that  $\mathbb{E}[\text{Tr}(P\Phi(\rho))] = 0$ , following from Lemma 15. Thus, we focus on  $\mathbb{E}[\text{Tr}(P\Phi(\rho_0))^2]$ . We have

$$\mathbb{E}[\text{Tr}(P\Phi(\rho_0))^2] = \mathbb{E}\left[\text{Tr}\left(P\Phi\left(\rho_0 - \frac{I_n}{2^n}\right)\right)^2\right], \quad (\text{C68})$$

where we have used the unitality of the noise channels to get  $\Phi(I_n) = I_n$ , and the fact that the Pauli operators are traceless. The claim follows by applying the effective depth Theorem 27.  $\square$

We now show an upper bound on the partial derivative variance in the case of unital noise. Due to Lemma 41, we can focus on Pauli observables without loss of generality.

**Proposition 57** (Improved upper bound on the partial derivative for unital noise). *Let  $C := \text{Tr}(P\Phi(\rho_0))$  be the cost function, where  $P \in \{I, X, Y, Z\}^{\otimes n}$ ,  $\rho_0$  is an arbitrary initial state, and  $\Phi$  is a quantum circuit of depth  $L$  in arbitrary dimension. We assume that the noise is unital. Let  $\mu$  denote a parameter of any 2-qubit gate  $\exp(-i\theta_\mu H_\mu)$  in the circuit such that  $\|H_\mu\|_\infty \leq 1$ . Then, we have*

$$\text{Var}[\partial_\mu C] \leq 4c^{|P|+L-1}. \quad (\text{C69})$$

*Proof.* By repeating the same steps of the proof of Proposition 25, namely the upper bound on the variance for non-unital noise, we get

$$\text{Var}[\partial_\mu C] = \mathbb{E}[(\partial_\mu C)^2] \leq c^{|P|+L-k-1} \max_{Q \in \{I, X, Y, Z\}^{\otimes n} \setminus I_n} \mathbb{E}(\text{Tr}(\Phi_{[1,k]}(\rho_0) i [H_\mu, Q]))^2. \quad (\text{C70})$$

Since  $H_\mu$  is a 2-qubit gate, it can be expanded in its 2-qubits Pauli decomposition, as

$$H_\mu = \sum_{R \in \{I, X, Y, Z\}^{\otimes 2}} b_R R. \quad (\text{C71})$$

Thus, substituting and using Lemma 16, we have

$$\mathbb{E}(\text{Tr}(\Phi_{[1,k]}(\rho_0) i [H_\mu, Q]))^2 = \sum_{R \in \{I, X, Y, Z\}^{\otimes 2}} b_R^2 \mathbb{E}(\text{Tr}(\Phi_{[1,k]}(\rho_0) Q_R))^2. \quad (\text{C72})$$

Here, we note that  $Q_R := i [R, Q]$  is a Hermitian operator, and in particular, it is a Pauli operator (or the zero operator). Thus, we have

$$\begin{aligned} \mathbb{E}(\text{Tr}(\Phi_{[1,k]}(\rho_0) i [H_\mu, Q]))^2 &= \sum_{R \in \{I, X, Y, Z\}^{\otimes 2}} b_R^2 \mathbb{E}(\text{Tr}(\Phi_{[1,k]}(\rho_0) Q_R))^2 \\ &\leq c^k \sum_{R \in \{I, X, Y, Z\}^{\otimes 2}} b_R^2, \end{aligned} \quad (\text{C73})$$

where in the last step we have used Proposition 56 and that the Pauli weight of the non-zero Pauli is lower bounded by one. Now we observe that

$$\sum_{R \in \{I, X, Y, Z\}^{\otimes 2}} b_R^2 = \frac{1}{2} \|H_\mu\|_2 \leq \|H_\mu\|_\infty \leq 1, \quad (\text{C74})$$

which concludes the proof.  $\square$

This result improves upon the partial derivative variance upper bound presented in Ref. [20], where the upper bound scaled as

$$\text{Var}[\partial_\mu C] = O(n^{1/2} 2^{-\alpha L}), \quad (\text{C75})$$

for some positive constant  $\alpha$ . It is noteworthy that this latter upper bound has no dependence on the Pauli weight, unlike ours. Furthermore, it includes a  $n^{1/2}$  factor in front of the exponential, making it meaningful only at depths  $\Omega(\log(n))$ . Moreover, our result is more general than that shown in Ref. [20] also because it extends to any unital noise, whereas the results shown in Ref. [20] apply only to primitive unital noise, which is only a particular type of unital noise (e.g., dephasing is not included in this class).

## D. Purity and kernel methods under non-unital noise

When a circuit is interspersed with primitive, unital noise, the decay in purity can be investigated by employing well-known entropy accumulation techniques (see, for instance, Refs. [34, 87, 90, 91, 106]). However, this approach has limited applicability under non-unital noise, as the noise channel can potentially decrease the entropy of the system. Here, we address this gap in the literature by providing upper and lower bounds on the purity of a noisy circuit, leveraging prior techniques along with the tools developed in the present work. As an application, we employ our upper bounds to investigate the limitations of quantum kernel methods under non-unital noise.

### 1. Purity of average and worst-case circuits

In this section, we explore the decay in purity under non-unital noise. We propose two distinct approaches: first, we provide upper and lower bounds for average-case circuits under possibly non-unital noise; second, we provide upper bounds for worst-case circuits, under the further assumption that the noise channel can be decomposed into a depolarizing channel followed by an arbitrary channel.

#### *Purity of an average-case noisy circuit*

We now upper and lower bound the expected purity of the output state of a noisy circuit, as defined in Eq. (A51).

**Proposition 58** (Average-case upper and lower bounds on the purity). *Let  $\rho$  be a quantum state. Then, at any depth of the noisy circuit  $\Phi$ , we have*

$$\left(\frac{1 + \|\mathbf{t}\|_2^2}{2}\right)^n \leq \mathbb{E} \text{Tr}[\Phi(\rho)^2] \leq \left(\frac{1 + \|\mathbf{t}\|_2^2 + \|\mathbf{D}\|_2^2}{2}\right)^n. \quad (\text{D1})$$

*Proof.* We first recall that the purity can be expressed in the Pauli basis as

$$\text{Tr}[\Phi(\rho)^2] = \text{Tr}[\mathbb{F}\Phi(\rho)^{\otimes 2}] = \frac{1}{2^n} \sum_{P \in \{I, X, Y, Z\}^{\otimes n}} \text{Tr}[P^{\otimes 2}\Phi(\rho)^{\otimes 2}] = \frac{1}{2^n} \sum_{P \in \{I, X, Y, Z\}^{\otimes n}} \text{Tr}[P\Phi(\rho)]^2. \quad (\text{D2})$$

Hence, plugging the upper and lower bound on the expected second moments (Eqs. B5, B22) yields the desired results:

$$\begin{aligned} \mathbb{E} \text{Tr}[\Phi(\rho)^2] &= \frac{1}{2^n} \sum_{P \in \{I, X, Y, Z\}^{\otimes n}} \mathbb{E} \text{Tr}[P\Phi(\rho)]^2 \leq \sum_{P \in \{I, X, Y, Z\}^{\otimes n}} \left(\frac{\|\mathbf{t}\|_2^2 + \|\mathbf{D}\|_2^2}{3}\right)^{|P|} \\ &= \frac{1}{2^n} \sum_{k=0}^n \binom{n}{k} (\|\mathbf{t}\|_2^2 + \|\mathbf{D}\|_2^2)^k = \left(\frac{1 + \|\mathbf{t}\|_2^2 + \|\mathbf{D}\|_2^2}{2}\right)^n, \end{aligned} \quad (\text{D3})$$

and

$$\begin{aligned} \mathbb{E} \text{Tr}[\Phi(\rho)^2] &= \frac{1}{2^n} \sum_{P \in \{I, X, Y, Z\}^{\otimes n}} \mathbb{E} \text{Tr}[P\Phi(\rho)]^2 \geq \sum_{P \in \{I, X, Y, Z\}^{\otimes n}} \left(\frac{\|\mathbf{t}\|_2^2}{3}\right)^{|P|} \\ &= \frac{1}{2^n} \sum_{k=0}^n \binom{n}{k} \|\mathbf{t}\|_2^{2k} = \left(\frac{1 + \|\mathbf{t}\|_2^2}{2}\right)^n, \end{aligned} \quad (\text{D4})$$

which ends the proof.  $\square$

In particular, if  $\mathcal{N}$  is a unital non-unitary channel, we have  $\|\mathbf{t}\|_2^2 = 0$  and  $\|\mathbf{D}\|_2^2 < 1$ , which implies

$$\mathbb{E} \text{Tr}[\Phi(\rho)^2] \leq 2^{-\Omega(n)}. \quad (\text{D5})$$

We observe that the bounds given in Proposition 58 hold also for reduced states, that is states obtained by performing a partial trace on the output state of the circuit. In particular, for any arbitrary state  $\rho$ , we let  $\rho_S := \text{Tr}_{[n] \setminus S}[\rho]$  the reduced state on a subset  $S$  of the qubits of size  $|S| = k$ . Then we have

$$\left(\frac{1 + \|\mathbf{t}\|_2^2}{2}\right)^k \leq \mathbb{E} \text{Tr}[\Phi(\rho)_S^2] \leq \left(\frac{1 + \|\mathbf{t}\|_2^2 + \|\mathbf{D}\|_2^2}{2}\right)^k. \quad (\text{D6})$$

*Purity of a worst-case noisy circuit*

In this section, we consider a layered circuit  $\mathcal{C}$  of the form

$$\mathcal{C} = \tilde{\mathcal{N}}^{\otimes n} \circ \mathcal{U}_L \circ \dots \circ \tilde{\mathcal{N}}^{\otimes n} \circ \mathcal{U}_1, \quad (\text{D7})$$

where we do not make any assumption on the structure of each unitary layer  $\mathcal{U}_i = U_i^\dagger(\cdot)U_i$ . In contrast, we will make a further assumption on the noise channel. In particular, we will model the local noise as the composition of two single-qubit channels, namely a local depolarizing channel  $\mathcal{N}_p^{(\text{dep})}(X) = p\frac{I}{2} \text{Tr}[X] + (1-p)X$  and arbitrary noise channel  $\mathcal{N}$  expressed in the normal form, i.e.,

$$\tilde{\mathcal{N}} = \mathcal{N} \circ \mathcal{N}_p^{(\text{dep})}, \quad (\text{D8})$$

where  $\mathcal{N}(I + \mathbf{w} \cdot \boldsymbol{\sigma}) = I + (\mathbf{t} + D\mathbf{w}) \cdot \boldsymbol{\sigma}$ . Under this stronger assumption, we provide two upper bounds on the purity of a worst-case noisy circuit. We also remark that order of  $\mathcal{N}$  and  $\mathcal{N}_p^{(\text{dep})}(X)$  does not play a central role in our analysis, therefore the same results could be derived inverting their order.

Let us recall the definition of quantum relative entropy and quantum sandwiched Rényi divergence [? ?]. Let  $\rho, \sigma$  be two quantum states. If  $\text{supp}(\rho) \subseteq \text{supp}(\sigma)$ , we define the quantum relative entropy as

$$D(\rho\|\sigma) := \text{Tr}(\rho \log \rho) - \text{Tr}(\rho \log \sigma). \quad (\text{D9})$$

For a parameter  $\alpha \in (0, 1) \cup (1, \infty)$ , the quantum Rényi divergence of order  $\alpha$  is defined as

$$D_\alpha(\rho\|\sigma) := \frac{1}{\alpha - 1} \log \text{Tr} \left[ \left( \sigma^{\frac{1-\alpha}{2\alpha}} \rho \sigma^{\frac{1-\alpha}{2\alpha}} \right)^\alpha \right]. \quad (\text{D10})$$

This definition applies when  $\text{supp}(\rho) \subseteq \text{supp}(\sigma)$ , for  $\alpha \in (1, \infty)$ . In the limit  $\alpha \rightarrow 1$ , the quantum Rényi divergence reduces to the quantum relative entropy, i.e.,  $\lim_{\alpha \rightarrow 1} D_\alpha(\rho\|\sigma) = D(\rho\|\sigma)$ . The  $\infty$ -relative entropy is defined, for  $\text{supp}(\rho) \subseteq \text{supp}(\sigma)$ , as

$$D_\infty(\rho\|\sigma) := \inf \{ \gamma : \rho \leq 2^\gamma \sigma \}.$$

It is useful to recall that for  $\alpha > \beta > 0$ , the Rényi divergences satisfy the monotonicity property, i.e.,  $D_\alpha(\rho\|\sigma) \geq D_\beta(\rho\|\sigma)$ .

By mean of the *data-processed triangle inequality* ([108], Theorem 3.1), the authors of [34, 106], obtained an upper bound on the purity of the output of a non-unital channel, which is exponentially small in  $n$  when the unital component of the noise ‘dominates’ the non-unital one. We rephrase such result within our model, giving an explicit expression in terms of  $p$  and  $\mathbf{t}$ .

**Corollary 59** (Worst-case upper bound on the purity). *Let  $\rho$  an arbitrary quantum state and assume  $p > 0$  and  $\|\mathbf{t}\|_2 \neq 1$ . Then for any constant noise parameters, we have*

$$D_2 \left( \mathcal{C}(\rho) \left\| \frac{I}{2^n} \right. \right) \leq n \left( (1-p)^{2L} + \|\mathbf{t}\|_2 \frac{1 - (1-p)^{2L}}{2p - p^2} \right) := n \cdot \delta_L. \quad (\text{D11})$$

*This implies the following upper bound on the purity*

$$\text{Tr}[\mathcal{C}(\rho)^2] \leq 2^{n(\delta_L - 1)}. \quad (\text{D12})$$

*Proof.* We first recall that  $\text{Tr}[\rho^2] = 2^{-n + D_2(\rho\|I/2^n)}$ , then first bound implies the second. We note the following

$$D_\infty \left( \mathcal{N}^{\otimes n} \left( \frac{I}{2^n} \right) \left\| \frac{I}{2^n} \right. \right) = n D_\infty \left( \mathcal{N} \left( \frac{I}{2} \right) \left\| \frac{I}{2} \right. \right) = n \log(1 + \|\mathbf{t}\|_2) \leq n \|\mathbf{t}\|_2, \quad (\text{D13})$$

where the second identity is a special case of Lemma 23 in Ref. [109]. Moreover, Lemma C.1 in Ref. [106] ensures the following:

$$D_2 \left( \mathcal{C}(\rho) \left\| \frac{I}{2^n} \right. \right) \leq (1-p)^{2L} D_2 \left( \rho \left\| \frac{I}{2^n} \right. \right) + \sum_{t=0}^L (1-p)^{2t} D_\infty \left( \mathcal{N}^{\otimes n} \left( \frac{I}{2^n} \right) \left\| \frac{I}{2^n} \right. \right). \quad (\text{D14})$$

Then the desired upper bound on  $D_2(\mathcal{C}(\rho)\|I/2^n)$  immediately follows.  $\square$

Note that the term  $\delta_L$  converges exponentially fast to  $\|\mathbf{t}\|_2/(2p - p^2)$ , and thus in this regime the bound is non-trivial if  $\|\mathbf{t}\|_2 \leq 2p - p^2$ .

## 2. Quantum machine learning under non-unital noise: Kernel methods

Quantum kernel methods offer a hopeful avenue for advancing quantum machine learning. However, despite certain positive results, as documented in Ref. [110], these methods remain susceptible to trainability challenges. In particular, the work of Thanasilp *et al.* [78] has demonstrated that various factors, such as circuit randomness and unital noise, can potentially compromise their trainability, in analogy to the phenomenon of barren plateaus for cost functions. Here we improve this result in a twofold way: first, we incorporate both unital and non-unital noise in our analysis and we show that fidelity kernels exponentially concentrate even at constant depth. This starkly improves the result of Ref. ([78], Theorem 3), which predicts exponential concentration at linear depth for unital noise. Moreover, we show that projected kernels do not incur in exponential concentration at any depth on average-case circuits interspersed by non-unital noise, in analogy with the lack of barren plateaus for local cost functions presented in Section B 1.

### Preliminaries on quantum kernel methods

Consider an  $n$ -qubit data-embedding channel  $\Phi_{\mathbf{x}}$  parametrized by a point  $\mathbf{x} \in \mathcal{X}$ , so that

$$\rho(\mathbf{x}) = \Phi_{\mathbf{x}}(\rho_0), \quad (\text{D15})$$

where  $\rho_0$  is the initial state of the circuit, usually set as  $\rho_0 = |0^n\rangle\langle 0^n|$ . A kernel  $\kappa : \mathcal{X} \times \mathcal{X} \rightarrow \mathbb{R}^+$  is a similarity measure between pair of points  $\mathbf{x}, \mathbf{y} \in \mathcal{X}$ . In particular, quantum kernels rely on the quantum embedding scheme described in the Equation D15 above. We consider the fidelity quantum kernel [111, 112], defined as

$$\kappa^{FQ}(\mathbf{x}, \mathbf{y}) = \text{Tr}[\rho(\mathbf{x})\rho(\mathbf{y})]. \quad (\text{D16})$$

The projected quantum kernel [81] is defined as

$$\kappa^{PQ}(\mathbf{x}, \mathbf{y}) := \exp\left(-\gamma \sum_{k=1}^n \|\rho_k(\mathbf{x}) - \rho_k(\mathbf{y})\|_2^2\right), \quad (\text{D17})$$

where  $\rho_k(\mathbf{x}) = \text{Tr}_{\bar{k}}\rho(\mathbf{x})$  is the reduced density matrix of the  $k$ -th qubit and  $\gamma$  is a positive hyperparameter. Kernel-based learning methods are notable for their capacity to transform data from the original space  $\mathcal{X}$  into a higher-dimensional feature space, which in our case coincides with the a  $2^n$ -dimensional Hilbert space. In this new feature space, inner products are computed, enabling the training of decision boundaries like support vector machines, as explained in reference [112].

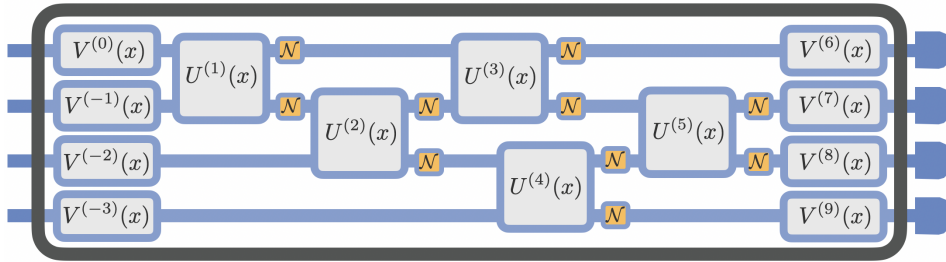

Figure 6. Example of a noisy quantum circuit on  $n = 4$  qubits with two-qubit and single-qubit gates, parametrized by the input vector  $\mathbf{x} \in \mathcal{X}$ .

### Kernel-based supervised learning

To better suite our results, we sketch how kernel methods can be used to perform supervised learning. We consider a training set of labelled inputs  $\mathcal{S} = \{\mathbf{x}^{(i)}, f(\mathbf{x}^{(i)})\}_{i \in [m]}$ , where  $f(\cdot)$  is some unknown function that we want to learn. Thus our goal is to find a function  $h$  approximating  $f$ . Thanks to the Representer Theorem (see, for instance, [113], Theorem 16.1), the optimal function can be expressed as

$$h(z) = \sum_{i=1}^m a_i \kappa(\mathbf{x}^{(i)}, z), \quad (\text{D18})$$



where the  $\mathbf{a} = (a_1, a_2, \dots, a_m)$  is a vector of parameters to be optimized with respect to a suitable loss function.

Then, to enable the implementation of kernel methods, it is necessary to estimate the Gram matrix. This matrix, denoted as  $\mathcal{G}$ , comprises the kernels derived from pairs of inputs within the training set  $\mathbf{x}^{(1)}, \mathbf{x}^{(2)}, \dots, \mathbf{x}^{(m)}$ , and is defined as

$$\forall i \in [m] : \mathcal{G}[i, j] = \kappa(\mathbf{x}^{(i)}, \mathbf{x}^{(j)}). \quad (\text{D19})$$

We recall that kernels exhibit exponential concentration with respect to a distribution  $\mathcal{D}$  over  $\mathcal{X}$ , if there exists a real number  $\mu \in \mathbb{R}$  and a value  $\delta \in 2^{-O(n)}$  such that

$$\Pr_{\mathbf{x}, \mathbf{y} \sim \mathcal{D}} [|\kappa(\mathbf{x}, \mathbf{y}) - \mu| \geq \delta] \in 2^{-\Omega(n)}. \quad (\text{D20})$$

In this case, all the entries of the Gram matrix are exponentially close to  $\mu$  with exponentially high probability, making the optimization of the vector  $\mathbf{a}$  an information-theoretically hard task.

*Assumption on the training data distribution*

Assume that each point in the training set is sampled from a distribution  $\mathcal{D} : \mathcal{X} \rightarrow [0, 1]$  and denote by  $\nu'$  the corresponding induced distribution over quantum channels. Then we make the following assumptions over  $\nu'$ :

1.  $\nu'$  satisfies Definition 19, i.e., it is 2-local 2-design layer distribution;
2. each layer is invariant under left-multiplication by a layer of single-qubit Clifford gates;
3. moreover, the circuit is ended by a layer of single-qubit Clifford gates sampled uniformly at random.

The second and third assumptions will play a pivotal role in the proof of absence of exponential concentration for the projected quantum kernels. We also remark that these assumptions could be further relaxed, since our computation only involve (up to) fourth moments.

*a. Fidelity quantum kernels: Exponential concentration at any depth*

The Cauchy-Schwarz inequality implies that the fidelity quantum kernel can be upper bounded by the square root of the purities of the output states

$$\text{Tr}[\rho(\mathbf{x})\rho(\mathbf{x}')] \leq \sqrt{\text{Tr}[\rho(\mathbf{x})^2] \text{Tr}[\rho(\mathbf{x}')^2]}. \quad (\text{D21})$$

By a direct application Proposition 58, we obtain the following result.

**Corollary 60** (Exponential concentration of quantum kernels, average-case circuit).

$$\mathbb{E}_{\mathbf{x}, \mathbf{x}' \kappa^{FQ}(\mathbf{x}, \mathbf{x}') \leq \left( \frac{1 + \|\mathbf{t}\|_2^2 + \|\mathbf{D}\|_2^2}{2} \right)^n. \quad (\text{D22})$$

In a similar fashion, we can derive a worst-case concentration bound by employing Corollary 59.

**Corollary 61** (Exponential concentration of quantum kernels, worst-case circuit). *Let  $\mathcal{U}_{\mathbf{x}}, \mathcal{U}_{\mathbf{x}'}$  two noisy circuits interspersed by  $L$  layers of local noise, modeled by the channel  $\mathcal{N}^{\otimes n} \circ \mathcal{N}_p^{(\text{dep}) \otimes n}$ . Denote by  $\rho(\mathbf{x}) = \mathcal{U}_{\mathbf{x}}(\rho_0)$  and  $\rho(\mathbf{x}') = \mathcal{U}_{\mathbf{x}'}(\rho_0)$  the output states of the noisy circuits. Assume that  $p = \Theta(1)$  and  $\|\mathbf{t}\|_2 \neq 1$ . Then the fidelity quantum kernel  $\kappa^{FQ}(\mathbf{x}, \mathbf{x}') = \text{Tr}[\rho(\mathbf{x})\rho(\mathbf{x}')] satisfies the following upper bound:$*

$$\kappa^{FQ}(\mathbf{x}, \mathbf{x}') \leq 2^{n(\delta_L - 1)}, \quad (\text{D23})$$

where  $\delta_L := (1 - p)^{2L} + \|\mathbf{t}\|_2 \frac{1 - (1 - p)^{2L}}{2p - p^2}$ .

As mentioned in Subsection D 1, this bound can be exponentially vanishing in the number of qubits for certain range of parameters.

We also emphasize when  $\|\mathbf{t}\| = 0$ , our bound predicts that the kernel  $\kappa^{FQ}(\mathbf{x}, \mathbf{x}')$  is at most  $2^{-n(2p - p^2)} = 2^{-\Omega(n)}$ , even after a single layer of noise, whereas Theorem 3 in [78] only predicts that  $|\kappa^{FQ}(x, x') - 1/2^n| \leq (1 - p)^2 = \Theta(1)$ . Thus, compared to the previous literature, our result is exponentially tighter with respect to the number of layers for the local depolarizing noise. An analogous bound for local Pauli noise can be derived along the lines of Supplementary Lemma 6 in Ref. [20].

b. *Projected quantum kernels: Absence of exponential concentration at any depth*

In the following, we lower bound the expected value and the variance of the quantity  $Q(\mathbf{x}, \mathbf{x}') := \sum_{k=1}^n \|\rho_k(\mathbf{x}) - \rho_k(\mathbf{x}')\|_2^2$ . Notice that this quantity can be related to the quantum projected kernels via  $\kappa(\mathbf{x}, \mathbf{x}') = e^{-\gamma Q(\mathbf{x}, \mathbf{x}')}$ .

**Theorem 62** (Expected value).

$$\|\mathbf{t}\|_2^2 \leq \mathbb{E}_{\mathbf{x}, \mathbf{x}'} \|\rho_k(\mathbf{x}) - \rho_k(\mathbf{x}')\|_2^2 \leq \|\mathbf{t}\|_2^2 + \|\mathbf{D}\|_2^2. \quad (\text{D24})$$

*Proof.* We first expand the Hilbert-Schmidt distance as follows,

$$\mathbb{E}_{\mathbf{x}, \mathbf{x}'} \|\rho_k(\mathbf{x}) - \rho_k(\mathbf{x}')\|_2^2 = \mathbb{E}_{\mathbf{x}, \mathbf{x}'} \{ \text{Tr}[\rho_k(\mathbf{x})^2] + \text{Tr}[\rho_k(\mathbf{x}')^2] - 2 \text{Tr}[\rho_k(\mathbf{x})\rho_k(\mathbf{x}')] \} \quad (\text{D25})$$

$$= \mathbb{E}_{\mathbf{x}} \text{Tr}[\rho_k(\mathbf{x})^2] + \mathbb{E}_{\mathbf{x}'} \text{Tr}[\rho_k(\mathbf{x}')^2] - 2 \text{Tr}[\mathbb{E}_{\mathbf{x}} \rho_k(\mathbf{x}) \mathbb{E}_{\mathbf{x}'} \rho_k(\mathbf{x}')]. \quad (\text{D26})$$

Then the result follows by combining Eq. (D6) with the fact that the first moment of a Haar-random state is the maximally mixed state.  $\square$

We observe that, under local Pauli noise, the same quantity is exponentially suppressed as the circuit depth increases, i.e.,  $\|\rho_k(\mathbf{x}) - \rho_k(\mathbf{x}')\|_2^2 \leq 2^{-\Omega(L)}$  ([78], Theorem 3). Moreover, we also observe that  $Q(\mathbf{x}, \mathbf{x}')$  has polynomially large variance at any depth.

**Theorem 63** (Variance). *We have,*

$$\text{Var}_{\mathbf{x}, \mathbf{x}'} \sum_{k=1}^n [\|\rho_k(\mathbf{x}) - \rho_k(\mathbf{x}')\|_2^2] \geq \Omega(n \|\mathbf{t}\|_2^4). \quad (\text{D27})$$

*Proof.* For the scope of this proof, we only need to consider the last two layers of unitaries and the last layer of local noise. In particular, we will use the fact that the last layer is a tensor product of random single-qubit Cliffords, and the second-to-last layer is invariant under post-processing by tensor products of random single-qubit Cliffords.

Thus, we can re-express the reduced states  $\rho_k(\mathbf{x})$  and  $\rho_k(\mathbf{x}')$  as follows

$$\rho_k(\mathbf{x}) = V_{\mathbf{x}}^{(k)} \mathcal{N} \left( \tilde{V}_{\mathbf{x}}^{(k)} \hat{\rho}(\mathbf{x}) \tilde{V}_{\mathbf{x}}^{(k)\dagger} \right) V_{\mathbf{x}}^{(k)\dagger}, \quad (\text{D28})$$

$$\rho_k(\mathbf{x}') = V_{\mathbf{x}'}^{(k)} \mathcal{N} \left( \tilde{V}_{\mathbf{x}'}^{(k)} \hat{\rho}(\mathbf{x}') \tilde{V}_{\mathbf{x}'}^{(k)\dagger} \right) V_{\mathbf{x}'}^{(k)\dagger}, \quad (\text{D29})$$

where  $V_{\mathbf{x}}^{(k)}, V_{\mathbf{x}'}^{(k)}, \tilde{V}_{\mathbf{x}}^{(k)}$  and  $\tilde{V}_{\mathbf{x}'}^{(k)}$  are single-qubit Cliffords acting on the  $k$ -th qubit. We denote by  $\hat{\rho}(\mathbf{x})$  and  $\hat{\rho}(\mathbf{x}')$  the states obtained after the action of the first  $L-1$  layers of the noisy circuits and after tracing out all the qubits except from the  $k$ -th.

Throughout this proof, we will consider the conditional expectation with respect to the following event:

$$A = \{V_{\mathbf{x}}^{(k)} = V_{\mathbf{x}'}^{(k)}\}, \quad (\text{D30})$$

that is, we condition upon the last gate acting on the  $k$ -th qubit being the same for both the classical inputs  $\mathbf{x}$  and  $\mathbf{x}'$ . Since  $V_{\mathbf{x}}^{(k)}$  and  $V_{\mathbf{x}'}^{(k)}$  are single-qubit Cliffords sampled uniformly at random from  $\text{Cl}(1)$ , the event  $A$  happens with constant probability:  $\Pr[A] = |\text{Cl}(1)|^{-1} = \Theta(1)$ .

First, we notice that the expected purities of  $\rho_k(\mathbf{x})$  and  $\rho_k(\mathbf{x}')$  do not change if we condition on the event  $A$ :

$$\mathbb{E}_{\mathbf{x}} \text{Tr}[\rho_k(\mathbf{x})^2] = \mathbb{E}_{\mathbf{x}'} \text{Tr}[\rho_k(\mathbf{x}')^2] = \mathbb{E}_{\mathbf{x}} \{ \text{Tr}[\rho_k(\mathbf{x})^2] | A \} = \mathbb{E}_{\mathbf{x}'} \{ \text{Tr}[\rho_k(\mathbf{x}')^2] | A \}. \quad (\text{D31})$$

Moreover, since the Clifford group forms a 1-design, the expected overlap takes the value

$$\mathbb{E}_{\mathbf{x}, \mathbf{x}'} \text{Tr}[\rho_k(\mathbf{x})\rho_k(\mathbf{x}')] = \text{Tr} \left[ \left( \frac{I}{2} \right)^2 \right] = \frac{1}{2}. \quad (\text{D32})$$

Similarly, conditioning on  $A$  we obtain

$$\mathbb{E}_{\mathbf{x}, \mathbf{x}'} \{ \text{Tr}[\rho_k(\mathbf{x})\rho_k(\mathbf{x}') | A] \} \quad (\text{D33})$$

$$= \mathbb{E}_{\mathbf{x}, \mathbf{x}'} \text{Tr} \left[ \mathcal{N} \left( \tilde{V}_{\mathbf{x}}^{(k)} \hat{\rho}(\mathbf{x}) \tilde{V}_{\mathbf{x}}^{(k)\dagger} \right) \mathcal{N} \left( \tilde{V}_{\mathbf{x}'}^{(k)} \hat{\rho}(\mathbf{x}') \tilde{V}_{\mathbf{x}'}^{(k)\dagger} \right) \right] \quad (\text{D34})$$

$$= \text{Tr} \left[ \mathcal{N} \left( \frac{I}{2} \right)^2 \right] = \frac{1 + \|\mathbf{t}\|_2^2}{2}. \quad (\text{D35})$$

Therefore, the difference between  $\mathbb{E}_{\mathbf{x}, \mathbf{x}'} \{ \|\rho_k(\mathbf{x}) - \rho_k(\mathbf{x}')\|_2^2 | A \}$  and  $\mathbb{E}_{\mathbf{x}, \mathbf{x}'} \|\rho_k(\mathbf{x}) - \rho_k(\mathbf{x}')\|_2^2$  can be expressed as

$$\mathbb{E}_{\mathbf{x}, \mathbf{x}'} \{ \|\rho_k(\mathbf{x}) - \rho_k(\mathbf{x}')\|_2^2 | A \} - \mathbb{E}_{\mathbf{x}, \mathbf{x}'} \|\rho_k(\mathbf{x}) - \rho_k(\mathbf{x}')\|_2^2 \quad (\text{D36})$$

$$= 2\mathbb{E}_{\mathbf{x}, \mathbf{x}'} \{ \text{Tr}[\rho_k(\mathbf{x})\rho_k(\mathbf{x}')] | A \} - 2\mathbb{E}_{\mathbf{x}, \mathbf{x}'} \text{Tr}[\rho_k(\mathbf{x})\rho_k(\mathbf{x}')] \quad (\text{D37})$$

$$= 2 \text{Tr} \left[ \mathcal{N} \left( \frac{I}{2} \right)^2 \right] - 2 \text{Tr} \left[ \left( \frac{I}{2} \right)^2 \right] = \|\mathbf{t}\|_2^2. \quad (\text{D38})$$

This immediately translates into a lower bound on the variance of  $\|\rho_k(\mathbf{x}) - \rho_k(\mathbf{x}')\|_2^2$  with respect to the random gates  $V_{\mathbf{x}}^{(k)}, V_{\mathbf{x}'}^{(k)}, \tilde{V}_{\mathbf{x}}^{(k)}, \tilde{V}_{\mathbf{x}'}^{(k)}$ . Let  $\mu := \mathbb{E}_{\mathbf{x}, \mathbf{x}'} [\|\rho_k(\mathbf{x}) - \rho_k(\mathbf{x}')\|_2^2]$ . We have

$$\text{Var}_{V_{\mathbf{x}}^{(k)}, V_{\mathbf{x}'}^{(k)}, \tilde{V}_{\mathbf{x}}^{(k)}, \tilde{V}_{\mathbf{x}'}^{(k)}} [\|\rho_k(\mathbf{x}) - \rho_k(\mathbf{x}')\|_2^2] \quad (\text{D39})$$

$$= \mathbb{E}_{V_{\mathbf{x}}^{(k)}, V_{\mathbf{x}'}^{(k)}, \tilde{V}_{\mathbf{x}}^{(k)}, \tilde{V}_{\mathbf{x}'}^{(k)}} [(\mu - \|\rho_k(\mathbf{x}) - \rho_k(\mathbf{x}')\|_2^2)^2] \quad (\text{D40})$$

$$= \Pr[A] (\mu - \mathbb{E}[\|\rho_k(\mathbf{x}) - \rho_k(\mathbf{x}')\|_2^2 | A])^2 + \Pr[\bar{A}] (\mu - \mathbb{E}[\|\rho_k(\mathbf{x}) - \rho_k(\mathbf{x}')\|_2^2 | \bar{A}])^2 \quad (\text{D41})$$

$$\geq \Pr[A] (\mu - \mathbb{E}[\|\rho_k(\mathbf{x}) - \rho_k(\mathbf{x}')\|_2^2 | A])^2 = \Pr[A] \|\mathbf{t}\|_2^4 \geq \Omega(\|\mathbf{t}\|_2^4). \quad (\text{D42})$$

It remains to lower bound the variance of the sum of all the terms, i.e.,  $\sum_{k=1}^n [\|\rho_k(\mathbf{x}) - \rho_k(\mathbf{x}')\|_2^2]$ ,

$$\text{Var}_{\mathbf{x}, \mathbf{x}'} \sum_{k=1}^n [\|\rho_k(\mathbf{x}) - \rho_k(\mathbf{x}')\|_2^2] \geq \text{Var}_{V_{\mathbf{x}}, V_{\mathbf{x}'}, \tilde{V}_{\mathbf{x}}, \tilde{V}_{\mathbf{x}'}} \sum_{k=1}^n [\|\rho_k(\mathbf{x}) - \rho_k(\mathbf{x}')\|_2^2] \quad (\text{D43})$$

$$= \sum_{k=1}^n \text{Var}_{V_{\mathbf{x}}^{(k)}, V_{\mathbf{x}'}^{(k)}, \tilde{V}_{\mathbf{x}}^{(k)}, \tilde{V}_{\mathbf{x}'}^{(k)}} [\|\rho_k(\mathbf{x}) - \rho_k(\mathbf{x}')\|_2^2] \quad (\text{D44})$$

$$\geq n \cdot \min_{k \in [n]} \text{Var}_{V_{\mathbf{x}}^{(k)}, V_{\mathbf{x}'}^{(k)}, \tilde{V}_{\mathbf{x}}^{(k)}, \tilde{V}_{\mathbf{x}'}^{(k)}} \|\rho_k(\mathbf{x}) - \rho_k(\mathbf{x}')\|_2^2 \geq \Omega(n\|\mathbf{t}\|_2^4). \quad (\text{D45})$$

In the first step, we lower bounded the variance with respect to entire circuit, with that over the last two layers of single-qubit unitaries; whereas the identity follows from the fact that the single-qubit gates are sampled independently, and thus we can swap the variance and the sum.  $\square$

## E. Miscellaneous

*Useful lemmas: concentration inequalities*

**Lemma 64** (Large variance implies significant probability of deviation). *Let  $f$  be a real function depending by parameters distributed according to a probability distribution  $\mu$ . Then, the inequality*

$$\text{Prob} \left( |f - \mathbb{E}[f]| > \sqrt{\frac{\text{Var}[f]}{2}} \right) \geq \frac{\text{Var}[f]}{8 \sup(|f|)^2} \quad (\text{E1})$$

*holds, where the expected value and variance are taken with respect the probability distribution  $\mu$ .*

*Proof.* Let  $T > 0$  be a real value that we will fix later. We have

$$\begin{aligned} \text{Var}[f] &:= \int (f - \mathbb{E}[f])^2 d\mu \quad (\text{E2}) \\ &= \int_{|f - \mathbb{E}[f]| \leq T} (f - \mathbb{E}[f])^2 d\mu + \int_{|f - \mathbb{E}[f]| > T} (f - \mathbb{E}[f])^2 d\mu \\ &\leq T^2 \int_{|f - \mathbb{E}[f]| \leq T} 1 d\mu + \int_{|f - \mathbb{E}[f]| > T} (f - \mathbb{E}[f])^2 d\mu \end{aligned}$$

$$\begin{aligned}
&\leq T^2 \left( 1 - \int_{|f - \mathbb{E}[f]| > T} 1 d\mu \right) + 4(\sup(|f|))^2 \int_{|f - \mathbb{E}[f]| > T} 1 d\mu \\
&= T^2 + \left( 4(\sup(|f|))^2 - T^2 \right) \text{Prob}(|f - \mathbb{E}[f]| > T),
\end{aligned}$$

where in the fourth step we have used that  $|f - \mathbb{E}[f]| \leq |f| + |\mathbb{E}[f]| \leq 2 \sup(|f|)$ . Therefore, rearranging the previous inequality, we have

$$\text{Prob}(|f - \mathbb{E}[f]| > T) \geq \frac{\text{Var}[f] - T^2}{4 \sup(|f|)^2 - T^2}. \quad (\text{E3})$$

By choosing  $T := \frac{1}{\sqrt{2}} \sqrt{\text{Var}[f]}$ , we get

$$\text{Prob} \left( |f - \mathbb{E}[f]| > \sqrt{\frac{\text{Var}[f]}{2}} \right) \geq \frac{\text{Var}[f]}{8 \sup(|f|)^2 - \text{Var}[f]} \geq \frac{\text{Var}[f]}{8 \sup(|f|)^2}. \quad (\text{E4})$$

□

**Lemma 65** (Large first moments). *Let  $f$  be a real function depending by parameters distributed according to a probability distribution  $\mu$ . Then, the inequality*

$$\text{Prob} \left( f > \frac{\mathbb{E}[f]}{2} \right) \geq \frac{\mathbb{E}[f]}{2 \sup(|f|)} \quad (\text{E5})$$

holds, where the expected value and variance are taken with respect the probability distribution  $\mu$ .

*Proof.* Let  $T$  a real value  $T > 0$ . Then, we have

$$\mathbb{E}[f] = \int f d\mu = \int_{|f| \leq T} f d\mu + \int_{|f| > T} f d\mu \leq T + \sup(|f|) \text{Prob}(f > T). \quad (\text{E6})$$

Now, if we assume  $T = \mathbb{E}[f]/2$  and rearrange the inequality, we obtain

$$\text{Prob} \left( f > \frac{\mathbb{E}[f]}{2} \right) \geq \frac{\mathbb{E}[f]}{2 \sup(|f|)}. \quad (\text{E7})$$

□

### 1. Trace distance decay for worst-case circuits under local depolarizing noise

As documented by the previous literature [28, 82, 87], the output of any circuit affected by unital, primitive noise converges exponentially fast in the depth to the maximally mixed state with respect to the trace distance. The proof relies on the Pinsker's inequality and on the contraction coefficients of the quantum Rényi divergence of order 2. See the definition of Rényi divergence in Eq. D10.

For the sake of simplicity, we will consider the special case of the depolarizing noise, and refer to [82, 87] for an extension to arbitrary Pauli channels with normal form parameters satisfying  $D_P < 1$  for all  $P \in \{X, Y, Z\}$ . We will need the following lemma.

**Lemma 66** (Strong data-processing inequality. Adapted from Theorem 6.1 in Ref. [28]). *Let  $\mathcal{N}_p^{(\text{dep})}$  be the single-qubit depolarizing channel of rate  $p$ , i.e.,  $\mathcal{N}_p^{(\text{dep})}(X) = p \frac{I}{2} + (1-p)X$ . Let  $\Phi := \bigcirc_{i=1}^L (\mathcal{N}_p^{(\text{dep}) \otimes n} \circ \mathcal{U}_i)$  be a circuit of  $L$  unitary layers interspersed by local depolarizing noise. Then, for every state  $\rho$ , we have*

$$D_2 \left( \Phi(\rho) \left\| \frac{I}{2^n} \right. \right) \leq (1-p)^{2L} n. \quad (\text{E8})$$

Then the desired result follows by a direct application of the Pinsker's inequality.

**Proposition 67** (Deviation from maximal mixedness). *Under the same assumptions of Lemma 66, we obtain*

$$\left\| \Phi(\rho) - \frac{I}{2^n} \right\|_1 \leq \sqrt{2n}(1-p)^L. \quad (\text{E9})$$

And therefore, for all states  $\rho$  and  $\sigma$ , we have

$$\|\Phi(\rho) - \Phi(\sigma)\|_1 \leq 2\sqrt{2n}(1-p)^L. \quad (\text{E10})$$

*Proof.* Combining the Pinsker's inequality with the monotonicity of the the quantum Rényi divergence, we obtain

$$\left\| \Phi(\rho) - \frac{I}{2^n} \right\|_1^2 \leq 2D\left(\Phi(\rho) \left\| \frac{I}{2^n} \right.\right) \leq 2D_2\left(\Phi(\rho) \left\| \frac{I}{2^n} \right.\right) \quad (\text{E11})$$

Hence Proposition 67 implies

$$\left\| \Phi(\rho) - \frac{I}{2^n} \right\|_1 \leq \sqrt{2n}(1-p)^L. \quad (\text{E12})$$

Thus, a direct application of the triangle inequality yields the desired result:

$$\|\Phi(\rho) - \Phi(\sigma)\|_1 \leq \left\| \Phi(\rho) - \frac{I}{2^n} \right\|_1 + \left\| \Phi(\sigma) - \frac{I}{2^n} \right\|_1 \leq 2\sqrt{2n}(1-p)^L. \quad (\text{E13})$$

□

We emphasize that the above result does not require randomness, unlike our Theorem 21. On the other hand, Theorem 21 yields non trivial bound even at constant depth, while the above depolarizing-noise result is vacuous at sub-logarithmic depth. We remark that a non-vacuous bound for shallow depths could be derived by means of the quantum Bretagnolle-Huber inequality (see, for instance, Ref. [114], (Lemma B.1 in Ref. [115]) and references therein).

Informally, Proposition 67 says that the output of a noisy circuit becomes computationally trivial at super-logarithmic depths, provided that the noise is unital and primitive. This poses severe constraints on the capabilities of noisy devices, as exemplified by the following result.

**Corollary 68** (Exponential concentration, unital case). *Under the same assumptions of Lemma 66, for every state  $\rho$  and for every observable  $O$ , we obtain*

$$\left| \text{Tr}[O\Phi(\rho)] - \frac{\text{Tr}[O]}{2^n} \right| \leq \sqrt{2n}(1-p)^L \|O\|_\infty. \quad (\text{E14})$$

*Proof.* First, we notice that the LHS can be rearranged as follows:

$$\left| \text{Tr}[O\Phi(\rho)] - \frac{\text{Tr}[O]}{2^n} \right| = \left| \text{Tr} \left[ O \left( \Phi(\rho) - \frac{1}{2^n} \right) \right] \right|. \quad (\text{E15})$$

Hence, we obtain

$$\left| \text{Tr} \left[ O \left( \Phi(\rho) - \frac{1}{2^n} \right) \right] \right| \leq \left\| \Phi(\rho) - \frac{I}{2^n} \right\|_1 \|O\|_\infty \leq \sqrt{2n}(1-p)^L \|O\|_\infty, \quad (\text{E16})$$

where the first inequality follows from the Holder's inequality, and the second one is a consequence of Proposition 67. □

## 2. Numerical simulations

In this section we present numerical results that corroborate our analytical results and explore regimes that go beyond the assumptions and results of our theorems, such as the one of assuming the 2-qubit gates to be distributed according to a local 2-design. We start by considering a brickwork architecture as depicted in Fig. 2, where each 2-qubit gate takes the form

$$U_{i,i+1}(\theta_1, \theta_2, \theta_3, \theta_4) := (R_Y(\theta_4) \otimes R_Y(\theta_3)) \text{CNOT}_{i,i+1} (R_X(\theta_2) \otimes R_X(\theta_1)). \quad (\text{E17})$$

We consider the noise model given by the composition of amplitude damping and depolarizing channels:

$$\mathcal{N}_{(p,q)}^{(\text{dep,amp})} := \mathcal{N}_p^{(\text{dep})} \circ \mathcal{N}_q^{(\text{amp})}, \quad (\text{E18})$$

where two noise channels are defined respectively in Eq. (A49) and Eq. (A48) with  $p, q \in [0, 1]$ .

Moreover, we assume, in contrast to our circuit model in Fig. 2, that the circuit ends with a layer of noise (instead of a layer of single-qubits gates). Furthermore, we consider an expectation value with respect to the observable  $Z_1$ . In Fig. 7 (Left), we can clearly observe that the partial derivatives taken at the end of the circuit are significantly

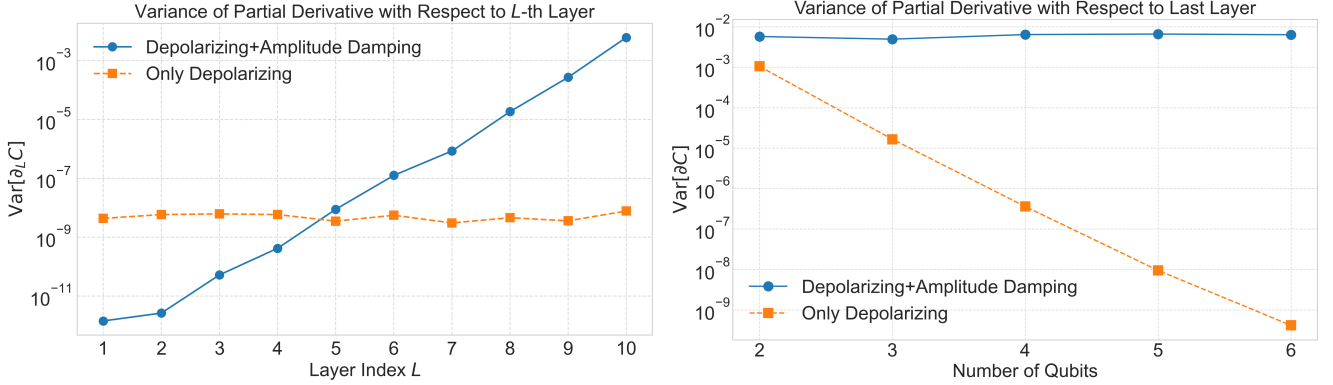

Figure 7. **Left:** Variance of the partial derivative with respect to a gate in the  $L$ -th layer of 5 qubits one-dimensional quantum circuit of depth 10. We confirm that the expectation value is exponentially less ‘sensitive’ to the gates in the first part of the circuit compared to the last layers. We set the depolarizing and amplitude damping parameters to  $p = q = 0.2$ . If we switch off the amplitude damping ( $q = 0$ ), we observe that all the partial derivatives exhibit similar scaling uniformly across all the layers. All the free parameters are uniformly sampled in  $[0, 2\pi]$ . **Right:** Variance of the partial derivative with respect to a gate in the last layer of the circuit versus the number of qubits. The depth of the circuit is chosen to be  $2n$ , where  $n$  is the number of qubits. In the case of both amplitude damping and depolarizing noise with  $p = q = 0.2$ , we observe a consistent behavior where the partial derivative with respect to the last layer remains constant regardless of the number of qubits. However, when  $q = 0$ , an exponential decay is observed. In both plots, the variance was estimated based on 100 randomly sampled points in the parameter space, and all the free parameters are uniformly sampled in  $[0, 2\pi]$ .

larger compared to those taken at the beginning of the circuit. This confirms the exponential decay that we proved in Theorem 50. It is noteworthy that if we were to deactivate the amplitude damping component, we would observe an average exponential concentration in all partial derivatives, regardless of the layer at which the derivative is taken. This aligns with the findings of the study on (depolarizing-)noise-induced barren plateaus [20] and with our Proposition 57. Furthermore, in our experiments, we observe that the partial derivatives in the final layers remain constant as the number of qubits increases, as depicted in Fig. 7 (Right). This observation corroborates the conclusions drawn in our Corollary 49. In particular, this implies that the 2-norm of the gradient remains constant on average with respect to the number of qubits. Another consideration is whether our theorems heavily depend on the assumption that the 2-qubit gate is sampled by a 2-design, and whether this assumption can be relaxed. Our evidence suggests that we might relax such assumption: in our numerical simulations, we observe a similar trend of what we proved even with more structured ansatz like QAOA, the *quantum approximate optimization algorithm* [94]), as demonstrated in Fig. 8. This provides further support for the notion that the assumption regarding the 2-qubit gates being sampled by a 2-design is not crucial.

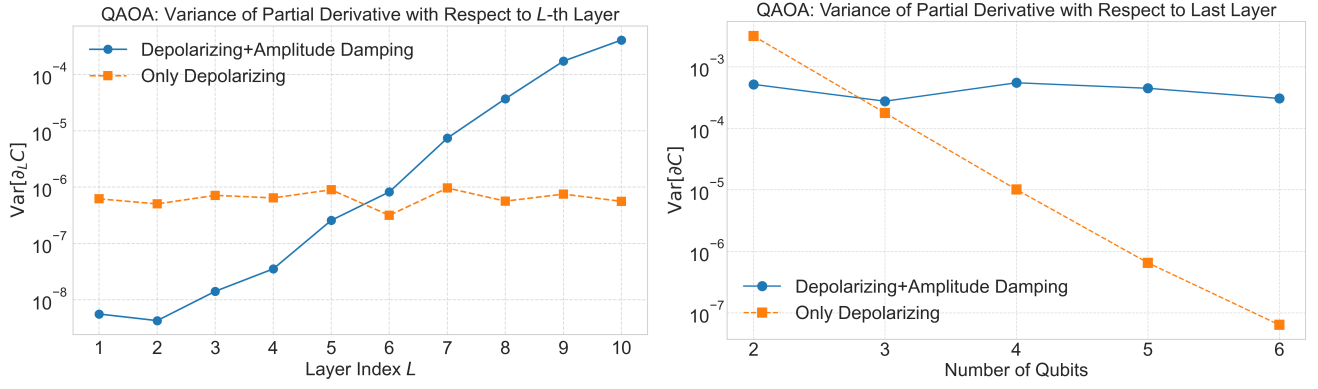

Figure 8. The same quantities as in the previous figure. However, in this case, we employed a QAOA circuit ansatz. Notably, we observed that the results do not undergo a qualitative change. This provides evidence that our findings are not limited to unstructured ansatz composed of 2-design 2-qubits gates. The choice of parameters remains consistent with those used in the previous plots, with the only difference being the use of  $X_1$  as an observable instead of  $Z_1$  (as the expectation value of  $Z_1$  should always be zero in the noiseless case for any fixed QAOA circuit, due to symmetry reasons). The QAOA ansatz chosen has the form  $\prod_{i=1}^D \exp(-i\beta_i H_x) \exp(-i\gamma_i H_z) |+\rangle^{\otimes n}$ , where  $H_z := \sum_{i=1}^{n-1} Z_i Z_{i+1}$  and  $H_x := \sum_{i=1}^n X_i$ , where each  $\gamma_i$  and  $\beta_i$  are sampled uniformly randomly in  $[0, 2\pi]$ .