



# Complete equational theories for classical and quantum Gaussian relations

Robert I. Booth  

University of Edinburgh, United Kingdom

University of Bristol, United Kingdom

Titouan Carette  

LIX, CNRS, École polytechnique, Institut Polytechnique de Paris, 91120, Palaiseau, France

Cole Comfort

Université de Lorraine, CNRS, Inria, LORIA, F 54000 Nancy, France

---

## Abstract

---

We give generators and relations for the hypergraph props of Gaussian relations [65] and positive affine Lagrangian relations. The former extends Gaussian probabilistic processes by completely-uninformative priors, and the latter extends Gaussian quantum mechanics with infinitely-squeezed states. These presentations are given by adding a generator to the presentation of real affine relations and of real affine Lagrangian relations which freely codiscards effects, as well as certain rotations.

The presentation of positive affine Lagrangian relations provides a rigorous justification for many common yet informal calculations in the quantum physics literature involving infinite-squeezing. Our presentation naturally extends Menicucci et al.’s graph-theoretic representation of Gaussian quantum states [59] with a representation for Gaussian transformations. Using this graphical calculus, we also give a graphical proof of Braunstein and Kimble’s continuous-variable quantum teleportation protocol [25]. We also interpret the LOv-calculus [27], a diagrammatic calculus for reasoning about passive linear-optical quantum circuits in our graphical calculus. Moreover, we show how our presentation allows for additional optical operations such as active squeezing.

**2012 ACM Subject Classification** Theory of computation → Models of computation; Theory of computation → Rewrite systems

**Keywords and phrases** Graphical algebra, symplectic geometry, string diagrams, category theory, Markov categories, probabilistic computation, categorical quantum mechanics, quantum information, quantum computing, quantum mechanics, quantum optics, graph theory

**Acknowledgements** CC is supported by the project NEASQC funded from the European Union’s Horizon 2020 research and innovation programme (grant agreement No 951821).

## 1 Introduction

The research programme of categorical quantum mechanics seeks to axiomatize quantum mechanics and quantum computing using the theory of monoidal categories. More specifically, the ZX-calculus community has sought out to find diagrammatic presentations for different fragments of quantum theory using string diagrams [29, 54, 61, 4, 73, 49, 5, 32]. This graphical quantum-mechanical paradigm has found a wide-ranging applications in quantum computing [53, 41, 35, 31, 52, 40, 56, 6, 67], as well as in teaching quantum theory [30, 50].

Up until relatively recently, however, the fragments of quantum mechanics of study have been almost exclusively finite dimensional. This is partly due to the inconvenient fact that the category of (infinite-dimensional) Hilbert spaces is not compact closed, a highly desirable feature for rewriting. This is at odds with much of quantum physics, where many systems have continuous degrees of freedom which can only be modelled in infinite dimensions. Famously, the canonical commutation relations only hold in infinite dimensions.

Different approaches have been taken to get around this obstacle and attempt to diagrammatically axiomatize infinite-dimensional quantum systems.

One general approach to tackling this obstacle has been to change the semantics. For example, Gogioso and Genovese suggest embedding Hilbert spaces into a larger compact closed category using nonstandard analysis [45]. On the other hand Cockett et al. have sought to completely abandon the Hilbert space semantics, shifting to non-degenerate models of multiplicative linear logic, and exploiting more refined notion of duals in the setting of \*-autonomous categories [28]. However, neither of these lines of inquiry have provided presentations in the same spirit of the ZX-calculus; instead, they have led to categorical reconstructions, and exotic toy models of quantum mechanics.

Another approach has been to just put up with the lack of duals [2]. This line of thinking has produced graphical presentations for different fragments of quantum mechanics, including for coherent control [23] and passive linear quantum optics [27, 51]. However, the lack of duals makes it harder to incorporate existing quantum circuit optimization techniques which exploit duals and hypergraph structure. For example the quantum circuit optimisation package PyZx represents quantum circuits as undirected open graphs [56], and the cutting-edge ZX-calculus quantum circuit optimization techniques often make use of these graph-like representations [40, 56, 6].

However, these two approaches are not mutually exclusive. For example De Felice et al. [36] mix both approaches: working in one semantics without duals, and taking finite truncations into another semantics in a way similar to Gogioso and Genovese, albeit without nonstandard analysis.

In this paper, we restrict our attention in two main ways. Firstly, we seek an axiomatization only of the *Gaussian* fragment of infinite-dimensional quantum mechanics. Gaussian quantum mechanics (GQM) is an important fragment for many candidate physical systems for implementing quantum computation [58, 26, 62], including quantum optics [43, 78, 79, 3, 10, 37]. Formally, it bears a strong resemblance to the stabiliser fragment of finite-dimensional quantum theory, although many of the primitives of stabiliser theory do not generalize well to infinite-dimensional Hilbert spaces.

Secondly, instead of looking for a Hilbert space semantics, we give our semantics in the category  $\text{AffLagRel}_{\mathbb{C}}$  of *complex affine Lagrangian relations*. This allows us to express all of Gaussian quantum mechanics, as well the nonphysical operations known as “infinite squeezing,” which includes hypergraph structure, compact structure as well as a notion of Dirac deltas (eg. [72, page 18]). Our relational interpretation of Dirac deltas makes them behave algebraically how physicists (often informally) manipulate them; however we do not give a distributional semantics in the sense of Schwartz [64]. To be more specific about our semantics, we construct a subcategory of  $\text{AffLagRel}_{\mathbb{C}}$  of relations verifying a positivity condition which exactly captures these aforementioned primitives. This change of semantic category is partly motivated by the fact that the stabiliser fragments of odd prime dimensional qudit quantum systems are already known to be projectively equivalent to categories of affine Lagrangian relations over finite fields [33]. Therefore the equational theory of affine Lagrangian relations of Booth et al. [22] restricts to the stabiliser fragment of the ZX-calculus [21, 63]. Furthermore, Lagrangian relations have been extensively studied in the context of geometric quantization:  $\text{AffLagRel}_{\mathbb{C}}$  is Weinstein’s affine symplectic category [75], we discuss this connection further in subsection 3.3.

Notably, although they do not give semantics in terms of Lagrangian relations, Menicucci et al. use symplectic-geometric methods in order to represent Gaussian states using graphs [59]. Although they do not give generators and relations for a monoidal category, they do provide

graph transformation rules. Therefore, our work can be seen as a relational/compositional extension of theirs.

Although our original motivation was find a relational semantics, as well as a graphical presentation for Gaussian quantum mechanics; surprisingly, by imposing a single additional constraint on our subspaces, we also obtain a complete presentation for the category of Gaussian relations, which was originally formulated by Stein and Samuelson [65]. Our semantic formulation of this category makes it into a concrete category of relations: where composition is given merely by relational composition. This presentation extends that of affine relations by Bonchi et al. [17] (at least over  $\mathbb{R}$ ) which itself extends the presentation of linear relations by Bonchi et al. [18]. Similar, yet disjoint presentations exist for piecewise linear relations [13], and polyhedral relations [15]. Such presentations for categories of relations with algebraic structure have been used as a syntax for signal flow diagrams in control theory [16, 8, 20, 19, 34, 42], systems with bounded resources [15], and electrical circuits [17, 14, 7, 9, 13, 34]. Therefore, it is likely that our presentation for positive affine Lagrangian relations will be useful outside of quantum mechanics.

### Related work.

Independently of this work, Stein et al. [66] give the same presentation of Gaussian relations. However, their semantics are completely different: their semantics are non-linear varieties whereas we regard Gaussian relations as a subcategory of affine relations. The precise connection between these interpretations still needs to be elucidated. Their characterisation does not extend to the quantum case.

### Structure of paper

In section 2, we review string diagrams for symmetric monoidal categories, and related notions. In section 3, we review graphical symplectic algebra: commencing with a brief review of symplectic linear algebra in subsection 3.1, and the graphical language for affine Lagrangian relations in subsection 3.2. In subsection 3.3, we begin to discuss the quantum nature of affine Lagrangian relations, which motivates our more refined semantics.

Section 4 is devoted to giving a complete presentation of Gaussian relations. We first review Gaussian probability theory in subsection 4.1. Then in subsection 4.2, we give a novel formulation of Gaussian relations in terms of a subcategory of complex affine Lagrangian relations, followed by a graphical presentation in subsection 4.3.

The final section 5 is devoted to giving a complete presentation for positive affine Lagrangian relations. We begin with subsection 5.1 with a review of Gaussian quantum mechanics. In subsection 5.2, we characterize positive Lagrangian relations more concretely. In subsection 5.3, we give a presentation for this category. In subsection 5.3, we connect our work to Menicucci et al.'s graphical representation of Gaussian states [59]. In subsection 5.5, we give a graphical proof of Braunstein and Kimble's continuous variable quantum teleportation protocol [25]. Similarly, in subsection 5.6 we show how the graphical language for passive linear quantum optics known as the LOv calculus [27] can be interpreted in our language.

## 2 Graphical languages

In this section we review the necessary background on string diagrams and graphical languages needed to understand this article. A more in depth introduction to this topic can be found in the article of Booth et al. [22, section 2].

## 2.1 String diagrams

A **prop** is a strict symmetric monoidal category such that the monoid of objects under the tensor product is the natural numbers under addition. For this reason, by convention we denote the tensor product on objects by  $+$ , and on maps by  $\oplus$ . We draw a map of type  $n \rightarrow m$  as a box with  $n$  incoming wires and  $m$  outgoing wires. The composition of  $g \circ f$  of arrows  $f$  and  $g$  is drawn by “plugging wires” and the monoidal product  $f \oplus g$  as “vertical juxtaposition”; we can also exchange wires with the symmetry map  $\sigma_{1,1} : 2 \rightarrow 2$  drawn as two wires crossing (satisfying the topologically evident equations):

Equation (1) shows three parts of string diagram identities. The first part shows composition: a box for  $g \circ f$  is equal to a box for  $f$  with a box for  $g$  plugged into its output wires. The second part shows the monoidal product: a box for  $f \oplus g$  is equal to two boxes, one for  $f$  and one for  $g$ , stacked vertically. The third part shows the symmetry map: two wires crossing is equal to two parallel wires, and a box for  $f$  with two crossing wires is equal to a box for  $f$  with two parallel wires. The equation is labeled (1).

Arrows of type  $0 \rightarrow n$  are **states**;  $n \rightarrow 0$  are **effects**;  $0 \rightarrow 0$  are **scalars**.

## 2.2 Duality and flexsymmetry

► **Definition 1.** A **compact prop** is a prop in which a single wire can be bent into cups  $\eta_1 : 0 \rightarrow 2$  and caps  $\varepsilon_1 : 2 \rightarrow 0$ , satisfying the topologically evident equations:

The equation shows the definitions of a cup  $\eta_1$  (a U-shaped wire) and a cap  $\varepsilon_1$  (an inverted U-shaped wire). It then shows three topological identities: a cup followed by a cap is equal to a straight wire, a cap followed by a cup is equal to a straight wire, and a cup followed by a cap with a crossing is equal to a straight wire with a crossing. The equation is labeled (1).

One advantage of working with compact props is that every map  $f : n \rightarrow m$ , can be uniquely represented by a state called its **name** given by bending the inputs into outputs  $[f] : 0 \rightarrow n + m$ . Sometimes the order of wires in the name of a map doesn’t matter:

► **Definition 2.** An arrow  $f : n \rightarrow m$  in a compact prop is **flexsymmetric** if for any permutation  $\varsigma$  of  $m + n$ ,  $\varsigma \circ [f] = [f]$ .

In some cases, compact props admit presentations where all generators are flexsymmetric. This means that the string diagrams consisting of such generators can be treated as undirected graphs. We use this extensively throughout this paper.

## 2.3 Scalable notation

In order to reason about props  $\mathbb{C}$ , it will often be useful to work in their strictification  $[\mathbb{C}]$ . When representing maps in  $[\mathbb{C}]$ , each wire is labelled by a natural number  $n$ , indicating that the wire represents a bundle of  $n$  atomic wires. This prop is given by the generators and equations of  $\mathbb{C}$  in addition to new generators which divide and gather the wires:

Equation (2) shows the divider and gatherer generators. A divider  $\Sigma$  is a box with  $n_1, \dots, n_k$  incoming wires and  $n_j$  outgoing wires. A gatherer  $\Sigma$  is a box with  $n_1, \dots, n_k$  incoming wires and  $n_j$  outgoing wires. The equations show that a divider followed by a gatherer is equal to a straight wire, and a gatherer followed by a divider is equal to a straight wire. The equation is labeled (2).

In other words, in this setting, we are able to reason about composite systems in  $\mathbb{C}$ . As a matter of convention, we will typeset generic wires as thicker, to indicate when there may be some  $n \in \mathbb{N}$  atomic wires bundled together. If we know that there is only a single atomic wire within such a bundle, we will draw it thinly; moreover, if we know that the bundle is empty, we will omit the wire entirely. This will allow us to make inductive arguments using only pictures; therefore, given any such  $\mathbb{C}$ , getting a hold of  $[\mathbb{C}]$  will be very useful. We will call the ways of thinking about  $\mathbb{C}$  using  $[\mathbb{C}]$  **scalable notations**.

### 3 Graphical symplectic algebra

In this section, we review graphical symplectic algebra of Booth et al. [22, section 3]:

#### 3.1 Symplectic linear algebra

First, we review symplectic linear algebra.  $\mathbb{K}$  will denote an arbitrary field, although in the remainder of the article and unless otherwise stated, we will take  $\mathbb{K}$  to be either the field of real, or complex numbers. The group of units of  $\mathbb{K}$  is denoted by  $\mathbb{K}^*$ .

► **Definition 3.** A *symplectic  $\mathbb{K}$ -vector space* is a  $\mathbb{K}$ -vector space  $V$  endowed with a bilinear map  $\omega_V : V \oplus V \rightarrow \mathbb{K}$  called the *symplectic form* which is:

- **Alternating:** For all  $\vec{v} \in V$ ,  $\omega_V(\vec{v}, \vec{v}) = 0$ .
- **Nondegenerate:** Given some  $\vec{v} \in V$ : if for all  $\vec{u} \in V$   $\omega_V(\vec{v}, \vec{u}) = 0$ , then  $\vec{v} = \vec{0}$ .

A *symplectic  $\mathbb{K}$ -linear map* between symplectic spaces  $(V, \omega_V) \rightarrow (W, \omega_W)$  is a  $\mathbb{K}$ -linear map  $S : V \rightarrow W$  that preserves the symplectic form, i.e.  $\omega_W(S\vec{v}, S\vec{u}) = \omega_V(\vec{v}, \vec{u})$  for all  $\vec{v}, \vec{u} \in V$ . A *symplectomorphism* is a symplectic isomorphism. Similarly, a *symplectic  $\mathbb{K}$ -affine map*  $S, \vec{a}$  is a  $\mathbb{K}$ -affine map whose linear component  $S$  is symplectic; and an *affine symplectomorphism* is an symplectic  $\mathbb{K}$ -affine isomorphism.

► **Example 4.** The vector space  $\mathbb{K}^{2n}$  has a symplectic form  $\omega_n \left( \begin{bmatrix} \vec{z} \\ \vec{x} \end{bmatrix}, \begin{bmatrix} \vec{z}' \\ \vec{x}' \end{bmatrix} \right) := \sum_{j=0}^{n-1} z_j x'_j - x_j z'_j$

As a matter of notation, denote the skew-symmetric  $2n \times 2n$  matrix which represents this form by  $\Omega_n$ . Note that  $\omega_1$  measures the (oriented) area of parallelograms in  $\mathbb{K}^2$ .

► **Theorem 5 (Linear Darboux theorem).** Every finite-dimensional symplectic vector space  $(V, \omega_V)$  is symplectomorphic to the symplectic vector space  $(\mathbb{K}^{2n}, \omega_n)$ .

A linear subspace  $S$  of a symplectic vector space  $(V, \omega)$  is **Lagrangian**, if  $2 \dim(S) = \dim(V)$  and for all  $\vec{v}, \vec{w} \in S$ ,  $\omega(\vec{v}, \vec{w}) = 0$ . In particular, every Lagrangian subspace  $S \subseteq (\mathbb{K}^{2n}, \omega_n)$  is the kernel of a  $n \times 2n$  matrix  $\ker[Z|X] = S$ , called a **generator matrix**, so that for all rows  $\vec{v}, \vec{w}$ ,  $\omega(\vec{v}, \vec{w}) = 0$ . Recall the following generalisation of a linear subspace:

► **Definition 6.** Given  $n \in \mathbb{N}$ , an **affine subspace** of  $\mathbb{K}^n$  is a subset  $S + \vec{a} := \{\vec{v} \in \mathbb{K}^n \mid S\vec{v} = \vec{a}\} \subseteq \mathbb{K}^n$  for some vector  $\vec{a} \in \mathbb{K}^m$  and matrix  $S : n \rightarrow m$ . An affine subspace  $S + \vec{a}$  of a symplectic vector space  $(V, \omega)$  is **Lagrangian** when either  $S$  is Lagrangian or empty. An **affine Lagrangian relation**  $m \rightarrow n$  is an affine Lagrangian subspace of  $\mathbb{K}^{2m} \oplus \mathbb{K}^{2n}$  with respect to the symplectic form given by:

$$\omega_{m,n} \left( \begin{bmatrix} \vec{z}_0 \\ \vec{x}_0 \\ \vec{z}_1 \\ \vec{x}_1 \end{bmatrix}, \begin{bmatrix} \vec{z}_2 \\ \vec{x}_2 \\ \vec{z}_3 \\ \vec{x}_3 \end{bmatrix} \right) := \omega_n \left( \begin{bmatrix} \vec{z}_1 \\ \vec{x}_1 \end{bmatrix}, \begin{bmatrix} \vec{z}_3 \\ \vec{x}_3 \end{bmatrix} \right) - \omega_m \left( \begin{bmatrix} \vec{z}_0 \\ \vec{x}_0 \end{bmatrix}, \begin{bmatrix} \vec{z}_2 \\ \vec{x}_2 \end{bmatrix} \right)$$

We must introduce this twisted symplectic form  $\omega_{m,n}$ , as opposed to  $\omega_{m+n}$ , so that affine Lagrangian relations can be composed relationally:

► **Definition 7.** The compact prop of affine Lagrangian relations  $\text{AffLagRel}_{\mathbb{K}}$  has:

- **Arrows** affine Lagrangian relations.
- **Composition** of  $R : n \rightarrow m$  and  $S : m \rightarrow k$  is given by:

$$S \circ R := \{(\vec{a}, \vec{c}) \in \mathbb{K}^{2n} \oplus \mathbb{K}^{2k} \mid \exists \vec{b} \in \mathbb{K}^{2m} : (\vec{a}, \vec{b}) \in R, (\vec{b}, \vec{c}) \in S\} : n \rightarrow k$$

- ─ **Identity** on  $n$ , given by the diagonal relation  $\{(\vec{v}, \vec{v}) \in \mathbb{K}^{2n} \oplus \mathbb{K}^{2n}\} : n \rightarrow n$
- ─ **Monoidal structure**, given by the object  $0$  and the direct sum:

$$S \oplus T := \left\{ \left( \left( \begin{bmatrix} \vec{z}_S \\ \vec{z}_T \\ \vec{x}_S \\ \vec{x}_T \end{bmatrix}, \begin{bmatrix} \vec{z}'_S \\ \vec{z}'_T \\ \vec{x}'_S \\ \vec{x}'_T \end{bmatrix} \right) \middle| \left( \begin{bmatrix} \vec{z}_S \\ \vec{x}_S \end{bmatrix}, \begin{bmatrix} \vec{z}'_S \\ \vec{x}'_S \end{bmatrix} \right) \in S, \left( \begin{bmatrix} \vec{z}_T \\ \vec{x}_T \end{bmatrix}, \begin{bmatrix} \vec{z}'_T \\ \vec{x}'_T \end{bmatrix} \right) \in T \right\}$$

- ─ **Symmetric structure** is given by the relation:

$$\sigma_{1,1} := \left\{ \left( \left( \begin{bmatrix} z_0 \\ z_1 \\ x_0 \\ x_1 \end{bmatrix}, \begin{bmatrix} z_1 \\ z_0 \\ x_1 \\ x_0 \end{bmatrix} \right) \middle| z_0, z_1, x_0, x_1 \in \mathbb{K} \right\} : 2 \rightarrow 2$$

- ─ **The compact structure** is given by:

$$\eta_1 := \left\{ \left( \left( \bullet, \begin{bmatrix} z \\ z \\ x \\ -x \end{bmatrix} \right) \middle| z, x \in \mathbb{K} \right\} : 0 \rightarrow 2 \quad \varepsilon_1 := \left\{ \left( \left( \begin{bmatrix} z \\ z \\ x \\ -x \end{bmatrix}, \bullet \right) \middle| z, x \in \mathbb{K} \right\} : 2 \rightarrow 0$$

Note that every affine symplectic map  $f$  induces an affine Lagrangian relation via its graph  $\Gamma(f)$ . This is a faithful functor so  $\text{AffLagRel}_{\mathbb{K}}$  strictly generalises (affine) symplectic maps.

### 3.2 Graphical presentation

In this section, we review the presentation of affine Lagrangian relations of Booth et al [22]:

► **Theorem 8.** *Given a field  $\mathbb{K}$ , the compact prop  $\text{AffLagRel}_{\mathbb{K}}$  has a flexsymmetric presentation  $\text{GSA}_{\mathbb{K}}$  (read **graphical symplectic algebra**), generated by, for all  $a, b \in \mathbb{K}$  and  $n, m \in \mathbb{N}$ :*

$$\begin{aligned} \left[ \begin{array}{c} \text{a, b} \\ \vdots \\ m \\ \vdots \\ n \end{array} \right]_{\text{ALR}}^{\text{GSA}} &:= \left\{ \left( \left( \begin{bmatrix} \vec{z} \\ x \\ \vdots \\ m \\ x \end{bmatrix}, \begin{bmatrix} \vec{z}' \\ x \\ \vdots \\ n \\ x \end{bmatrix} \right) \middle| \vec{z} \in \mathbb{K}^m, \vec{z}' \in \mathbb{K}^n, x \in \mathbb{K} \text{ such that} \right. \\ &\quad \left. \sum_{j=0}^{m-1} z_j - \sum_{k=0}^{n-1} z'_k + bx = a \right\} \\ \left[ \begin{array}{c} \text{a, b} \\ \vdots \\ m \\ \vdots \\ n \end{array} \right]_{\text{ALR}}^{\text{GSA}} &:= \left\{ \left( \left( \begin{bmatrix} z \\ \vdots \\ m \\ z \\ \vec{x} \end{bmatrix}, \begin{bmatrix} -z \\ \vdots \\ n \\ -z \\ \vec{x}' \end{bmatrix} \right) \middle| \vec{x} \in \mathbb{K}^m, \vec{x}' \in \mathbb{K}^n, z \in \mathbb{K} \text{ such that} \right. \\ &\quad \left. \sum_{j=0}^{m-1} x_j + \sum_{k=0}^{n-1} x'_k - bz = a \right\} \end{aligned}$$

Modulo flexsymmetry of the generators and for all  $a, b, c, d \in \mathbb{K}$  and  $z \in \mathbb{K}^*$ , the equations:

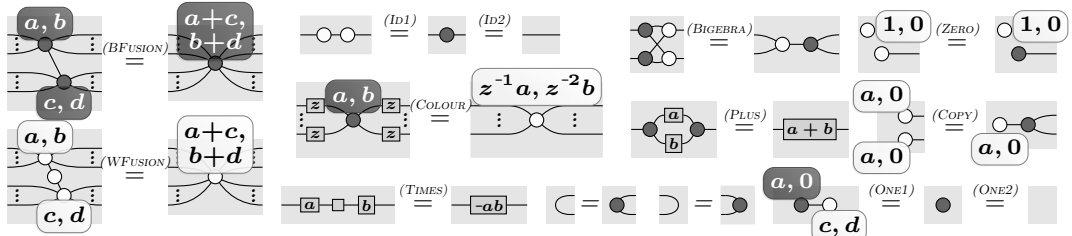

With derived generators, for all  $a \in \mathbb{K}$ :

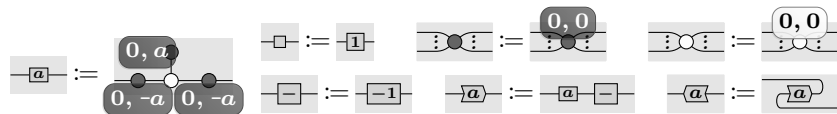

Call the white and grey nodes *spiders*. The Abelian group  $\mathbb{K}^2$  from which they take their labels is called their *phase-group*. Call the first component of  $\mathbb{K}^2 \cong \mathbb{K} \oplus \mathbb{K}$  the *affine phase*, and the second component the *symplectic phase*. Spiders which are unlabelled are called *phase-free*. The distinguished boxes with labels 1 and  $-1$  are respectively the *symplectic Fourier transform* and *inverse symplectic Fourier transform*. The derived arrow-shaped generators are called *squeezing maps*.

A prop equipped with the structure satisfying the axioms encapsulated by the phase-free grey spiders here is called a *hypergraph-prop* [55]. Conceptually, the grey spider should be regarded as way to formally wire things together.

It is useful to have some geometric intuition for the generators of  $\text{GSA}_{\mathbb{K}}$ . The affine phases of  $1 \rightarrow 1$  grey and white spiders shift the affine plane in orthogonal directions; whereas, the symplectic phases shear the affine plane. The symplectic Fourier transform rotates the affine plane by  $\pi/2$ . A squeezing map by  $a$  multiplies one axis in the plane by  $a$  and divides the other axis by  $a$ . Spiders with more legs are more complicated to visualise..

► **Remark 9.** We can restrict the semantics to the prop  $\text{AffRel}_{\mathbb{K}}$  of affine relations whose morphisms are merely affine subspaces, by restricting the syntax to the following generators,

for all  $a \in \mathbb{K}$ : 

There is a presentation, which we call  $\text{GAA}_{\mathbb{K}}$ , whose axioms we have included in appendix A.1. Here, the squeezing map corresponds to ordinary scalar multiplication.

Let  $\text{Sym}_n(\mathbb{K})$  denote the set of symmetric  $n \times n$  matrices over  $\mathbb{K}$  and  $M_{m,n}(\mathbb{K})$  the set of  $m \times n$  matrices over  $\mathbb{K}$ . We define scalable versions of the generators of  $\text{GSA}_{\mathbb{K}}$ , where now multiple wires are bundled together:

► **Definition 10.** Phase free scalable spiders are defined by induction on the number of wires. The base case is trivial, and the inductive step is given by:

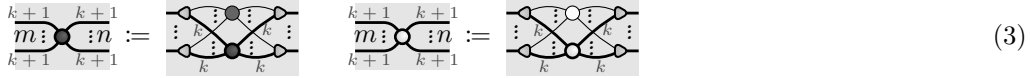

This allow us to define block matrices by induction as well, with the inductive step:



When restricted to  $\text{GAA}_{\mathbb{K}} \cong \text{AffRel}_{\mathbb{K}}$  these block matrices correspond to honest matrices, regarded as affine relations. Back in  $\text{GSA}_{\mathbb{K}}$ , we also have scalable versions of the Fourier transform, as well and the relational converse of matrices:



Now we define  $\mathbb{K}^k \times \text{Sym}_k(\mathbb{K})$ -phased scalable spiders. For the inductive step, take  $n, m \in \mathbb{N}$ ,  $a, b \in \mathbb{K}$ ,  $\vec{v}, \vec{w} \in \mathbb{K}^k$  and  $A \in \text{Sym}_k(\mathbb{K})$ , we define  $[k + 1]$ -coloured phased spiders as:

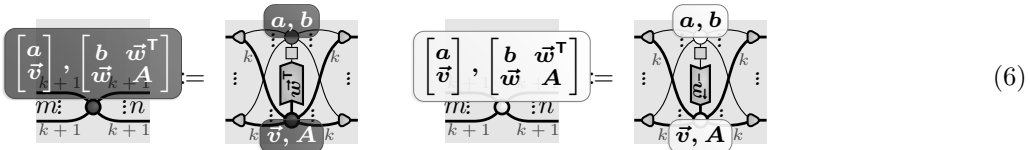

A  $[k]$ -coloured  $n \rightarrow m$  spider parametrizes an undirected open graph with edges coloured by  $\mathbb{K}$ , vertices coloured by  $\mathbb{K}^2$ , with  $n / m$  distinguished inputs / outputs:

► **Example 11.** On the left hand side we have a “graph state” with  $n = 0$ ,  $m = 1$  and  $k = 3$ . On the right hand side, we have a spider with  $m = 3$ ,  $n = 2$  and  $k = 3$ :



Theorem 8 follows from the fact that nonempty states  $0 \rightarrow n$  in  $\text{GSA}_{\mathbb{K}}$  can be uniquely represented by a more general notion of graph where not all vertices are outputs:

► **Proposition 12.** *Every nonempty state  $0 \rightarrow n$  in  $\text{GSA}_{\mathbb{K}}$  is reducible to a unique **reduced-AP form**, given by a 5-tuple  $(L, \Sigma, \vec{x}, \vec{\mu}, \varsigma)$ , where  $m \leq n \in \mathbb{N}$ ,  $\vec{x} \in \mathbb{K}^m$ ,  $\vec{\mu} \in \mathbb{K}^{n-m}$ ,  $L \in M_{m, n-m}(\mathbb{K})$  and  $\Sigma \in \text{Sym}_{n-m}(\mathbb{K})$ , where  $\varsigma \in M_{n, n}(\mathbb{K})$  is a permutation:*

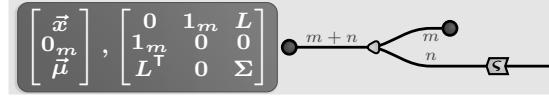

It is also useful to think of this normal form concretely in terms of generator matrices:

► **Remark 13.** The normal form of proposition 12 corresponds to reducing a nonempty affine Lagrangian relation to a unique generator matrix:

$$\ker \left( \left[ \begin{array}{ccc|c} I_m & L & \Sigma & 0 \\ 0 & 0 & -L^T & I_{n-m} \end{array} \right] \begin{bmatrix} \varsigma & 0 \\ 0 & \varsigma \end{bmatrix} \right) + \begin{bmatrix} \vec{x} \\ \vec{\mu} \end{bmatrix} \begin{bmatrix} \varsigma & 0 \\ 0 & \varsigma \end{bmatrix}$$

The affine part of the subspace is irrelevant for much of the calculations; therefore, we will often just refer to the pair  $([I, L]\varsigma, \Sigma)$  as the **AP-invariant** of the Lagrangian subspace.

### 3.3 Weil representation into Hilbert spaces

In this subsection, we begin to discuss how  $\text{AffLagRel}_{\mathbb{K}}$  gives a semantics for fragments of quantum mechanics. First, we recall the state space for finite dimensional quantum systems:

► **Definition 14.** *Given a finite set  $X$ , there is an associated  $|X|$ -dimensional Hilbert space of **square summable functions** on  $X$ :*

$$\ell^2(X) := \left\{ f : X \rightarrow \mathbb{C} \mid \sum_{x \in X} |f(x)|^2 < \infty \right\} \quad \text{with inner product} \quad \langle f, g \rangle := \sum_{x \in X} \bar{f}(x)g(x)$$

The Dirac deltas for elements of  $X$  determine a distinguished orthonormal basis  $\{|x\rangle\}_{x \in X}$  on  $\ell^2(X)$ . Given some  $1 \leq d \in \mathbb{N}$ , we identify the Hilbert space  $\ell^2(\mathbb{Z}/d\mathbb{Z})$  with the state space of a **qudit**, and  $\ell^2((\mathbb{Z}/d\mathbb{Z})^n) \cong (\ell^2(\mathbb{Z}/d\mathbb{Z}))^{\otimes n}$  with the state space of  $n$ -qudits.

Informally, qudits are  $d$ -dimensional quantum analogues of classical bits: the basis elements (and their normalized linear combinations) are the possible values of the qudit.

Building on the work of Gross [46], Comfort and Kissinger showed that for odd prime  $p$ , there is a projective equivalence between  $\text{AffLagRel}_{\mathbb{F}_p}$  and “*odd-prime qudit stabiliser quantum circuits*” (where there is an isomorphism of crings  $\mathbb{F}_p \cong \mathbb{Z}/p\mathbb{Z}$ ) [33]. Symplectic vector spaces  $(\mathbb{F}_p^{2n}, \omega_n)$  are identified with Hilbert spaces  $\ell^2(\mathbb{F}_p^n)$ ; and nonempty affine Lagrangian subspaces  $(S + \vec{a}) \subseteq (\mathbb{F}_p^{2n}, \omega_n)$  with **stabiliser states**  $\ell^2(\mathbb{F}_p^0) \rightarrow \ell^2(\mathbb{F}_p^n)$  given by the projector:



$$\frac{1}{p^n} \sum_{[\bar{z}^\top \ \bar{x}^\top]^\top \in S} \bigotimes_{j=0}^{p^n-1} \exp(2\pi i a_i / p) \mathcal{Z}^{z_j} \mathcal{X}^{x_j} \quad \text{where} \quad \mathcal{Z}|j\rangle := \exp(2\pi i j / p)|j\rangle \quad \mathcal{X}|j\rangle := |j+1\rangle \quad (8)$$

Because finite dimensional Hilbert spaces, and in particular, qudit stabiliser circuits are compact, this determines the representation completely. There is a natural generalization of qudits to infinite dimensions, used for example, in quantum optics:

► **Definition 15.** *The Hilbert space of square integrable functions on  $\mathbb{R}^n$  is:*

$$L^2(\mathbb{R}^n) := \left\{ f : \mathbb{R}^n \rightarrow \mathbb{C} \mid \int_{\mathbb{R}^n} |f(\vec{v})|^2 d\vec{v} < \infty \right\} \quad \text{with} \quad \langle f, g \rangle := \int_{\mathbb{R}^n} \bar{f}(\vec{v})g(\vec{v}) d\vec{v}$$

We identify the Hilbert space  $L^2(\mathbb{R})$  with the state space of a **qumode**, and  $L^2(\mathbb{R}^n) \cong (L^2(\mathbb{R}))^{\otimes n}$  with the state space of  $n$ -qumodes.

One might hope to obtain a similar projective representation of  $\text{AffLagRel}_{\mathbb{R}}$  into infinite dimensional Hilbert spaces. Indeed, affine symplectomorphisms on  $(\mathbb{R}^{2n}, \omega_n)$  are known to give a projective representation of the group of ‘‘Gaussian unitaries’’ on the Hilbert space  $L^2(\mathbb{R}^n)$  (see subsection 5.1, definition 30). However, attempting to lift the representation of states taken in the discrete setting to qumodes reveals that the analogous projector to that in equation (8) is not bounded, and therefore not a state in the category of Hilbert spaces. Even worse, the category infinite dimensional Hilbert spaces is not even compact, so it does not suffice to only concern ourselves with states.

Nevertheless, this technical difficulty has not stopped physicists from widely employing such ‘‘unphysical’’ states in their calculations, where they are known as *infinitely-squeezed* states [60, 47]. Because  $\text{AffLagRel}_{\mathbb{R}}$  has a simple presentation in terms of the hypergraph prop  $\text{GSA}_{\mathbb{R}}$ , this provides both a rigorous syntax and semantics for infinitely squeezed states and Gaussian operators: so that  $\text{GSA}_{\mathbb{R}}$  can be regarded as the ‘‘ZX-calculus for infinitely squeezed quantum circuits with Gaussian operators.’’ For example, we can think of the diagram  $\boxed{r, \mathbf{0}} \text{---} \bigcirc \text{---}$  as a formal Dirac delta centered at  $r \in \mathbb{R}$ .

The hypergraph structure of  $\text{AffLagRel}_{\mathbb{R}}$  has already been exploited to perform calculations on affinely constrained, *classical* mechanical systems. For example, in the context of electrical circuits, the hypergraph structure is interpreted as idealised-resistance-free wiring [7, 9]. Quantising this classical mechanical interpretation of  $\text{AffLagRel}_{\mathbb{R}}$  is a notoriously difficult problem in geometric quantisation. Much research has been done on the geometric quantization of classical mechanics although, oftentimes they work in the nonlinear setting of Lagrangian submanifolds between symplectic manifolds [48, 75, 12, 57, 68, 76, 11, 69, 1].

There *is* however a natural continuous-variable analogue of the finite-dimensional stabiliser circuits, called **Gaussian quantum mechanics** (GQM) [74], where the states of GQM are genuine quantum states (ie. normalized, bounded linear maps out of  $\mathbb{C}$ ). In this setting, the measurement statistics are described by Gaussian probability distributions, and the reversible transformations are given by Gaussian unitaries. However, as we have just discussed, GQM is not adequately axiomatised by  $\text{AffLagRel}_{\mathbb{R}}$ . The main goal of this article to obtain a presentation of a hypergraph prop that preserves the convenient features of  $\text{AffLagRel}_{\mathbb{R}}$  while being expressive enough to capture GQM. In order to transform infinitely squeezed states to Gaussian states, we need to add some notion of Gaussian blur to them, which will have the effect of making them ‘‘less sharp,’’ and thus continuous.

## 4 Classical Gaussians

In this section we first review how Gaussian transformations can be composed. Next, we give a novel concrete description of the prop of Gaussian relations of Stein and Samuelson [65] as a sub-prop of  $\text{AffLagRel}_{\mathbb{C}}$ . Finally, we give a presentation for Gaussian relations by extending that of  $\text{GAA}_{\mathbb{R}}$ .

### 4.1 Gaussian distributions and transformations

First, we review multivariate Gaussian distributions. Given any  $n \in \mathbb{N}$  and  $\Sigma \in \text{Sym}_n(\mathbb{K})$ , denote that  $\Sigma$  is respectively positive semi-definite and positive definite by  $0 \preceq \Sigma$  and  $0 \prec \Sigma$ .

► **Definition 16.** *Given any  $n \in \mathbb{N}$ , an  $n$ -variable **Gaussian distribution**  $\mathcal{N}(\Sigma, \vec{\mu})$  is a probability distribution on  $\mathbb{R}^n$  determined by some  $0 \preceq \Sigma \in \text{Sym}_n(\mathbb{R})$ , called the **covariance matrix** and a vector  $\vec{\mu} \in \mathbb{R}^n$ , called the **mean**. The characteristic function of  $\mathcal{N}(\Sigma, \vec{\mu})$  is given by  $\vec{u} \mapsto \exp(i\vec{u}^T \vec{\mu} - \frac{1}{2}\vec{u}^T \Sigma \vec{u})$ . Moreover, when  $0 \prec \Sigma$ , then  $\mathcal{N}(\Sigma, \vec{\mu})$  has a density function given by  $\vec{u} \mapsto \exp(\frac{-1}{2}(\vec{u} - \vec{\mu})^T \Sigma^{-1}(\vec{u} - \vec{\mu})) / \sqrt{(2\pi)^n \det(\Sigma)}$ .*

Gaussian distributions can be pushed forward along affine transformations to form a prop, following Fritz [44, §6]:

► **Definition 17.** *The prop, **Gauss**, of Gaussian transformations has:*

- **Morphisms:** given by triples  $(A \in \text{M}_{m,n}(\mathbb{K}), 0 \preceq \Sigma \in \text{Sym}_m(\mathbb{R}), \vec{\mu} \in \mathbb{R}^m) : n \rightarrow m$ ;
- **Composition:**  $(B, \Delta, \vec{v}) \circ (A, \Sigma, \vec{\mu}) := (BA, \Delta + A^T \Sigma A, \vec{v} + A\vec{\mu})$  and  $1_n := (1_n, 0, 0)$ ;
- The rest of the prop structure is given pointwise by the direct sum.

Affine transformations embed in Gaussian transformations via  $(T, \vec{a}) \mapsto (T, 0, \vec{a})$ . Thus, is natural to ask if Gaussian distributions can also be composed relationally. To find the right category we need to get a hold of the subobjects that will arise by relational composition. The following notion was first introduced by Willems [77], and later coined by Stein and Samuelson [65] to this end:

► **Definition 18.** *An **extended Gaussian distribution** on  $\mathbb{R}^n$  consists of a linear subspace  $D \subseteq \mathbb{R}^n$  in addition to a Gaussian distribution  $\mathcal{N}(\Sigma, \vec{\mu})$  on the quotient  $\mathbb{R}^n / D \cong \mathbb{R}^{n - \dim(D)}$ .*

### 4.2 Gaussian relations

In this subsection, we refine the morphisms of complex affine Lagrangian relations in order to us to compose extended Gaussian distributions, relationally:

► **Definition 19.** *A complex Lagrangian relation  $S : n \rightarrow m$  is:*

- **positive** when for all  $\vec{v} \in S$ , then  $i\omega_{n,m}(\vec{v}, \vec{v}) \geq 0$ ;
- **quasi-real** when it is positive, and for all  $[\vec{v}_I^T \ \vec{v}_O^T]^T, [\vec{w}_I^T \ \vec{w}_O^T]^T \in S$ :

$$\chi_m(\vec{v}_O, \vec{w}_O) - \chi_n(\vec{v}_I, \vec{w}_I) = 0 \quad \text{where} \quad \chi_n([\vec{z}_0^T \ \vec{x}_0^T]^T, [\vec{z}_1^T \ \vec{x}_1^T]^T) := \vec{z}_0^T \vec{x}_1 + \vec{x}_0^T \vec{z}_1$$

A nonempty affine Lagrangian relation  $(S + \vec{a})$  is positive (resp. quasi-real) when both  $\vec{a}$  is real and  $S$  is positive (resp. quasi-real), where empty affine Lagrangian relations are quasi-real.

Both of these notions induce more refined compact props:

► **Lemma 20.** *Both positive and quasi-real complex affine Lagrangian relations are closed under composition and tensor product, and the prop structure is positive and quasi-real.*

There are different equivalent definitions of positive Lagrangian subspaces:

► **Proposition 21.** *Let  $\mathcal{L}$  be a Lagrangian subspace of  $(\mathbb{C}^{2n}, \omega_n)$  with AP-invariant  $(E, \varphi)$ , where  $r := \text{rank}(\text{Im}(\varphi))$  then the following conditions are equivalent:*

1.  $E$  has real coefficients and  $\text{Im}(\varphi) \succeq 0$ ;
2.  $\mathcal{L}$  is real symplectomorphic to  $\ker [I_n | i \text{diag}(I_r, \vec{0})]$ .

That is, there exist a real symplectomorphism  $S$  such that  $\left[ \left[ \begin{array}{c} \mathbf{0}, i \\ \circ \end{array} \right] \circ \left[ \begin{array}{c} S \\ \circ \end{array} \right] \right]_{\text{ALR}}^{\text{GSA}} = \mathcal{L}$ ;

3.  $\mathcal{L}$  is positive.

Similarly, there are equivalent ways to define quasi-real Lagrangian subspaces:

► **Proposition 22.** *Let  $\mathcal{L}$  be a Lagrangian subspace of  $(\mathbb{C}^{2n}, \omega_n)$  with AP-invariant  $(E, \varphi)$ , where  $r := \text{rank}(\text{Im}(\varphi))$ , then the following conditions are equivalent:*

1.  $\text{Re}(\varphi) = 0$ ;
2.  $\mathcal{L}$  is real diagonal symplectomorphic to  $\ker \begin{bmatrix} I_r & 0 & i \text{diag}(I_r, \vec{0}) & 0 \\ 0 & 0 & 0 & I_{n-r-m} \end{bmatrix}$  for  $m \geq n - r$ .

That is, there exists an invertible matrix  $S$  such that  $\left[ \left[ \begin{array}{c} \mathbf{0}, i \\ \circ \end{array} \right] \circ \left[ \begin{array}{c} S \\ \circ \end{array} \right] \right]_{\text{ALR}}^{\text{GSA}} = \mathcal{L}$ ;

3.  $\mathcal{L}$  is quasi-real.

With propositions 22 and 21 combined, we have enough information to completely characterize the reduced AP-form of quasi-real affine Lagrangian subspaces:

► **Proposition 23.** *Nonempty, quasi-real affine Lagrangian subspaces of  $(\mathbb{C}^{2n}, \omega_n)$  have reduced AP-form given by 5-tuples  $(L, i\Sigma, 0, \vec{\mu}, \varsigma)$ , where  $L \in M_{n, n-m}(\mathbb{R})$ ,  $\vec{\mu} \in \mathbb{R}^{n-m}$  and  $0 \preceq \Sigma \in \text{Sym}_{n-m}(\mathbb{R})$ . This induces an extended Gaussian distribution  $\mathcal{N}(\Sigma, \vec{\mu})$  on  $\mathbb{R}^n / (\ker([I, L]\varsigma))$ , so that if  $m = 0$ , this is a Gaussian distribution on  $\mathbb{R}^n$ .*

Annoyingly, due to an incompatibility of conventions because we chose our normal form to have black spiders as vertices, this restricts to affine relations with respect to the *colour-swapped*, interpretation of remark 9, where an antipode must be also be inserted.

► **Definition 24.** *Define the compact prop of **Gaussian relations**,  $\text{GaussRel}$ , to be the sub-prop of  $\text{AffLagRel}_{\mathbb{C}}$  whose morphisms are quasi-real.*

Gauss embeds in  $\text{GaussRel}$ , just as affine symplectomorphisms embed in  $\text{AffLagRel}_{\mathbb{K}}$ . As previously mentioned, the prop of Gaussian relations was first formulated by Stein and Samuelson [65], although it is constructed using structured cospans, where composition is given by conditionals instead of directly by relational composition. Surprisingly, a detour through symplectic geometry makes this into a concrete category of relations!

### 4.3 Graphical presentation

Just as in the previous subsection, we restricted  $\text{AffLagRel}_{\mathbb{C}}$  to obtain  $\text{GaussRel}$ ; here we take the opposite approach and extend the presentation  $\text{GAA}_{\mathbb{R}} \cong \text{AffRel}_{\mathbb{R}} \hookrightarrow \text{AffLagRel}_{\mathbb{C}}$  with shearing by  $i$ ,  $\left[ \begin{array}{c} \mathbf{0}, i \\ \circ \end{array} \right] \circ \text{---}$ , interpreted as the Gaussian distribution  $\mathcal{N}(1, 0)$  on  $\mathbb{R}$ , to present  $\text{GaussRel}$ :

► **Definition 25.** Let GGA be the compact prop given by adding adding a single generator  $\textcircled{\ominus} : 0 \rightarrow 1$  to  $\text{GAA}_{\mathbb{R}}$ , called the **vacuum** such that the scalable vacuum codiscards rotations and effects; ie. so that for all  $n \in \mathbb{N}$ ,  $\vec{x} \in \mathbb{R}^n$  and  $\theta \in [0, 2\pi)$ :

$$\textcircled{\mathcal{R}(\theta)} = \textcircled{\ominus} \quad \textcircled{\ominus} = \textcircled{\ominus} \textcircled{\ominus} = \textcircled{\ominus} \textcircled{\ominus} \textcircled{\ominus} = \textcircled{\ominus} \textcircled{\ominus} \textcircled{\ominus} \textcircled{\ominus} \quad \text{where} \quad \textcircled{\ominus}_n = \textcircled{\ominus}_{n+1}$$

► **Theorem 26.** There is an isomorphism of compact props  $\text{GGA} \cong \text{GaussRel}$ .

Note that our *proof* of completeness follows from the analogous result for positive Lagrangian relations (theorem 38) in the following section. However, this is purely pedagogical, as we need to introduce Gaussian probability theory before Gaussian quantum mechanics.

## 5 Symplectic Gaussians

Recall from subsection 3.3 that affine Lagrangian subspaces of  $(\mathbb{R}^{2n}, \omega_n)$  cannot be canonically represented by bounded linear maps  $L^2(\mathbb{R}^0) \rightarrow L^2(\mathbb{R}^n)$  because they would correspond to infinitely-squeezed states. It turns out that by dropping the requirement from the previous section that affine Lagrangian relations are quasi-real, we obtain a semantics which can accommodate for both such infinitely-squeezed state and “Gaussian” quantum states.

### 5.1 Gaussian quantum mechanics

In this section, we review Gaussian quantum mechanics, and their Wigner representation. See the review article of Weedbrook et al. for a detailed reference [74]. Brask provides an abridged, yet helpful reference [24]. Recall from subsection 3.3, that the continuous variable analogue of a qudit, the qumode has state space given by the Hilbert space of square integrable complex functions on  $\mathbb{R}$ ,  $L^2(\mathbb{R})$ ; where the state space of  $n$ -qumodes is identified with the Hilbert space of square integrable complex functions on  $\mathbb{R}^n$ ,  $L^2(\mathbb{R}^n)$ :

► **Definition 27.** An  $n$ -qumode **Gaussian state**  $\varphi \in L^2(\mathbb{R}^n)$  has the form:

$$\varphi(\vec{x}) = \exp(i\alpha) \exp(i\vec{s}^T \vec{x}) \sqrt[4]{\det(\text{Im}(\Phi)) / \pi^n} \exp(i(\vec{x} - \vec{t})^T \Phi (\vec{x} - \vec{t}) / 2)$$

where  $\alpha \in [0, 2\pi)$ ,  $\vec{s}, \vec{t} \in \mathbb{R}^n$ , and  $\Phi \in \text{Sym}_n(\mathbb{C})$  with  $\text{Im}(\Phi) \succ 0$ . We call such a matrix  $\Phi$  a **phase matrix**, and the vector  $[\vec{s}^T \ \vec{t}^T]^T \in \mathbb{R}^{2n}$  a **displacement**. Together, they characterise the Gaussian state up to the “global phase”  $\exp(i\alpha)$ . There is an important Gaussian state on  $L^2(\mathbb{R})$  called the **vacuum** with trivial displacement and phase matrix  $i$ .

Importantly, unlike Dirac deltas, Gaussian states are continuous and normalized, so that they are quantum states. In other words  $\varphi$  can be regarded as a wave-function.

The connection between Gaussian quantum states and the Gaussian probability distributions which we discussed in section 4 is revealed by considering the symplectic vector space  $(\mathbb{R}^{2n}, \omega_n)$  as the **phase space** for the quantum system on  $L^2(\mathbb{R}^n)$ , on which Gaussian states correspond to particular Gaussian distributions.

► **Definition 28.** The **Wigner transform** of  $\varphi \in L^2(\mathbb{R}^n)$  is a real-valued  $W \in L^2(\mathbb{R}^{2n})$ :

$$W \left( \begin{bmatrix} \vec{q} \\ \vec{p} \end{bmatrix} \right) := \frac{1}{\pi^n} \int_{\mathbb{R}^n} \bar{\varphi}(\vec{q} + \vec{\xi}) \varphi(\vec{q} - \vec{\xi}) \exp(2i\vec{\xi}^T \vec{p}) d\vec{\xi} \quad \text{for all } \vec{p}, \vec{q} \in \mathbb{R}^n$$

► **Proposition 29.** *The Wigner transform of an  $n$ -qumode Gaussian state with phase matrix  $\Phi$  and displacement  $\vec{\mu}$  is the density function of the Gaussian distribution  $\mathcal{N}(\Sigma, \vec{\mu})$  on  $\mathbb{R}^{2n}$  where:*

$$\Sigma := \begin{bmatrix} \text{Im}(\Phi) + \text{Re}(\Phi) \text{Im}(\Phi)^{-1} \text{Re}(\Phi) & -\text{Re}(\Phi) \text{Im}(\Phi)^{-1} \\ -\text{Im}(\Phi)^{-1} \text{Re}(\Phi) & \text{Im}(\Phi)^{-1} \end{bmatrix}$$

Moreover, this is a bijection up to global phase, as conversely, Gaussian distributions  $\mathcal{N}(\Delta, \vec{\mu})$  on  $\mathbb{R}^{2n}$ , with

$$\Delta := \begin{bmatrix} A & B \\ B^\top & C \end{bmatrix}$$

for  $A, C \in \text{Sym}_n(\mathbb{R})$ ,  $B \in \text{M}_{n,n}(\mathbb{R})$  such that  $\det(\Delta) = 1$  and  $\Delta + i\Omega_n \succeq 0$  induce Gaussian states with phase matrix  $\Phi := -BC^{-1} + iC^{-1}$ .

► **Definition 30.** *The  $n$ -qumode **Gaussian unitaries** are the unitaries on  $L^2(\mathbb{R}^n)$  whose action on Gaussian states by postcomposition is closed.*

To characterize Gaussian unitaries up to global phase, it suffices to know how their action on Gaussian states effects their Wigner representation:

► **Lemma 31.** *Any Gaussian unitary  $U$  on  $L^2(\mathbb{R}^n)$  can be represented, up to global phase, by an affine symplectomorphism  $(\vec{x}, S)$  on  $(\mathbb{R}^{2n}, \omega_n)$  such that the action of  $U$  on the Wigner representation of Gaussian states is described by  $\Sigma \mapsto S\Sigma S^\top$  and  $\vec{\mu} \mapsto \vec{\mu} + \vec{x}$ .*

In other words, since the pair  $(\Sigma, \vec{\mu})$  does not account for global phases, Gaussian unitaries correspond to a projective representation of the real affine symplectic group [74]. Although this representation *can* be deprojectivised to a genuine unitary representation, called the *metaplectic* representation [39], our graphical calculi do not account for global scalars in the first place. As a result, we content ourselves with the projective representation described by lemma (31). Finally, there is also a good notion of Gaussian quantum effect:

► **Definition 32.** *Take a Gaussian state  $\varphi$  represented by the Gaussian distribution  $\mathcal{N}(\Sigma, \vec{\mu})$  on  $\mathbb{R}^{2n} \oplus \mathbb{R}^{2m}$ , and another  $\psi$  represented by  $\mathcal{N}(\Delta, \vec{\nu})$  on  $\mathbb{R}^{2n}$  where:*

$$\Sigma := \begin{bmatrix} \Sigma_{n,n} & \Sigma_{n,m} \\ \Sigma_{n,m}^\top & \Sigma_{m,m} \end{bmatrix} \quad \vec{\mu} := \begin{bmatrix} \vec{\mu}_n \\ \vec{\mu}_m \end{bmatrix}$$

The **projection** of  $\varphi$  onto  $\psi$  is the Gaussian state represented by the Gaussian distribution induced by generalised Schur complement:

$$\mathcal{N}(\Sigma_{m,m} - \Sigma_{n,m}(\Sigma_{n,n} + \Delta)^+ \Sigma_{n,m}^\top, \vec{\mu}_m - \Sigma_{n,m}(\Sigma_{n,n} + \Delta)^+(\vec{\mu}_n - \vec{\nu})) \quad (9)$$

Where  $(\Sigma_{n,n} + \Delta)^+$  denotes the Moore-Penrose pseudo-inverse of  $\Sigma_{n,n} + \Delta$  (this coincides with the inverse when the matrix is invertible).

These projections correspond precisely to the corresponding projections of quantum states in Hilbert space, lifted to the covariance matrix representation.

► **Definition 33.** *The prop of quantum Gaussian transformations, **QGauss**, has:*

- **morphisms** generated by  $n$ -qumode Gaussian states with type  $0 \rightarrow n$ ,  $n$ -qumode Gaussian unitaries with type  $n \rightarrow n$ , and projections onto  $n$ -qumode Gaussian states of type  $n \rightarrow 0$  for all  $n \in \mathbb{N}$ , all up to global phase;
- **composition** given by the action in lemma 31 and equation (9);
- the rest of the prop structure is given pointwise by the direct sum.

It is easy to see how there is an embedding  $\text{Gauss} \rightarrow \text{QGauss}$ , by doubling.

## 5.2 Positive Lagrangian relations

Recall the characterization of Gaussian relations of definition 24 in terms of quasi-real complex affine Lagrangian relations. In this section, we relax the requirement that these relations need to be quasi-real, yet retain that they must be positive:

► **Definition 34.** Let  $\text{AffLagRel}_{\mathbb{C}}^{\dagger}$  denote the sub-prop of  $\text{AffLagRel}_{\mathbb{C}}$  of positive affine Lagrangian relations.

From proposition 21, it follows that:

► **Proposition 35.** Nonempty positive affine Lagrangian subspaces of  $(\mathbb{C}^{2n}, \omega_n)$  have reduced AP-form given by 5-tuples  $(L, \Delta + i\Sigma, \vec{v}, \vec{\mu}, \varsigma)$ , where  $L \in \text{M}_{n, n-m}(\mathbb{R})$ ,  $\vec{\mu} \in \mathbb{R}^{n-m}$ ,  $\vec{v} \in \mathbb{R}^m$  and  $\Delta, \Sigma \in \text{Sym}_{n-m}(\mathbb{R})$  with  $0 \preceq \Sigma$ .

By regarding the Wigner representation of  $n$ -qumode Gaussian states as positive, affine Lagrangian subspaces of  $(\mathbb{C}^{2n}, \omega_n)$ , effects as subspaces of  $(\mathbb{C}^{2n}, -\omega_n)$ , and taking the complex graphs of the affine symplectomorphisms given by Gaussian unitaries, it is clear that:

► **Proposition 36.** There is an embedding of props  $\text{QGauss} \rightarrow \text{AffLagRel}_{\mathbb{C}}^{\dagger}$ .

## 5.3 Graphical presentation

Just as in the previous subsection, we restricted  $\text{AffLagRel}_{\mathbb{C}}$  to obtain  $\text{AffLagRel}_{\mathbb{C}}^{\dagger}$ ; here we take the opposite approach and extend the presentation  $\text{GSA}_{\mathbb{R}} \cong \text{AffLagRel}_{\mathbb{R}} \hookrightarrow \text{AffLagRel}_{\mathbb{C}}$  with shearing by  $i$ ,  $(\mathbf{0}, i) \circ \text{---}$ , interpreted as the vacuum, to give a presentation for  $\text{AffLagRel}_{\mathbb{C}}^{\dagger}$ :

► **Definition 37.** The compact prop  $\text{GSA}_{\mathbb{C}}^{\dagger}$  is presented by adding adding a single generator  $\text{---} \circ \text{---} : 0 \rightarrow 1$  to  $\text{GSA}_{\mathbb{R}}$  modulo the equations codiscarding symplectic rotations and effects. Equationally, we impose that for all  $n \in \mathbb{N}$ ,  $a, b \in \mathbb{R}$ ,  $\theta \in [0, 2\pi) \setminus \{\pi/2, 3\pi/2\}$ , and  $\vartheta \in [0, 2\pi)$ :

► **Theorem 38.** There is an isomorphism of compact props  $\text{GSA}_{\mathbb{C}}^{\dagger} \cong \text{AffLagRel}_{\mathbb{C}}^{\dagger}$ .

This elucidates the connection of positive Lagrangian relations to Gaussian relations:

► **Corollary 39.** There is a symmetric monoidal embedding  $[-]_{\text{GGA}}^{\text{GSA}_{\mathbb{C}}^{\dagger}} : \text{GSA}_{\mathbb{C}}^{\dagger} \rightarrow \text{GGA}$  acting on objects by  $[n]_{\text{GGA}}^{\text{GSA}_{\mathbb{C}}^{\dagger}} := 2n$  and on generators by:

So that we see that positive affine Lagrangian relations can be regarded as extended Gaussian distributions on the phase space.

Putting things together we have the following commutative diagram of props, which wraps around on the left and right:

## 5.4 Picturing Gaussian quantum states

There is a close link between the states of  $\text{GSA}_{\mathbb{C}}^+$  and the graph-theoretic representation of Gaussian states of Menicucci et al. [59]. This mirrors the relationship between quantum graph states [71, 80] and states in the stabiliser ZX-calculus for both even [4] and odd-prime-dimensional quantum systems [21].

Recall from [59] that any Gaussian state can be uniquely associated to a matrix  $U + iV$  where  $U, V \in \text{Sym}_n(\mathbb{R})$  and  $V$  is positive-definite. This matrix corresponds exactly to the phase matrix of the associated Gaussian state. As a result, it is represented in  $\text{GSA}_{\mathbb{C}}$  by  $\boxed{0, U + iV} \bullet$ . Therefore, there is a very natural embedding of the graph representation of [59] into  $\text{GSA}_{\mathbb{C}}^+ \hookrightarrow \text{GSA}_{\mathbb{C}}$  given by the following algorithm:

1. To each vertex of the graph, associate a grey spider. If that vertex has a self-edge with weight  $w$ , give the corresponding grey spider the label  $(0, w)$ .
2. To each edge between two different vertices with weight  $w$ , associate an edge between the corresponding spiders mediated by an  $a$ -labelled box.
3. Connect each spider in the graph to a (unique) output.
4. Using **BFUSION**, for each vertex unfuse the complex symplectic phase  $ai$  of vertices into one-legged spiders, and then use **COLOUR**, to turn this spider into a vacuum state connected to the original vertex with edge-weight  $1/\sqrt{a}$ .

This amounts to identifying the phase matrices of the graph representation and the  $\text{GSA}_{\mathbb{C}}^+$  diagram. For example:

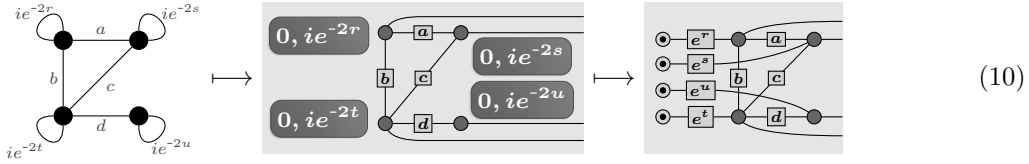

In other words, we have extended the diagrammatic representation of Menicucci et al. with a representation of Gaussian unitaries and effects as diagrams rather than through their action on Gaussian states, along with an equational theory for manipulating these diagrams. By completeness of  $\text{GSA}_{\mathbb{C}}^+$ , the action of Gaussian unitaries on Gaussian states is derivable. We also have a natural representation of translations, although the reduced-AP form of translated Gaussian states is not as simple as equation (10) since it can include internal vertices which carry part of the translation.

## 5.5 Picturing quantum protocols

Infinitely-squeezed eigenstates of the position and momentum displacement operators  $\hat{p}$  and  $\hat{q}$  are represented by  $|p : \hat{p}\rangle \mapsto \boxed{p, 0} \bullet$  and  $|q : \hat{q}\rangle \mapsto \boxed{q, 0} \circ\circ$ . The vacuum state is represented by  $|\varphi\rangle \mapsto \boxed{0, i} \bullet$ . We can also translate a universal gate set for Gaussian unitaries into our language; consisting of the **displaced shear** of position, the **Fourier transform** and **weighted CNOT** [47] with  $a, b \in \mathbb{R}$ :

$$\exp(i(a\hat{q} + b\hat{q}^2)) \mapsto \boxed{a, b} \bullet \quad \exp\left(i\frac{\pi}{2}(\hat{q}^2 + \hat{p}^2)\right) \mapsto \boxed{\square} \quad \exp(ia(\hat{q} \otimes \hat{p})) \mapsto \boxed{\text{S}} \quad (11)$$

We can now give a straightforward graphical proof of Braunstein and Kimble's continuous variable quantum teleportation protocol [25] (to be compared with the graphical proof in

finite dimensions eg. [70, §5.4] or [30, §9.2.7]), where Alice and Bob share a Gaussian Bell state with covariance of position  $0 < \varepsilon \in \mathbb{R}$ . Alice records the homodyne measurement outcome  $(a, b) \in \mathbb{R}^2$  in the Bell basis, and sends it to Bob, who performs the phase correction  $\hat{p}^{-b}\hat{q}^{-a}$ . This is stated graphically and simplified as follows:

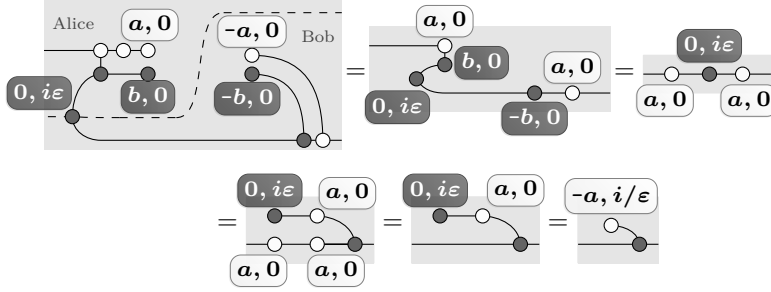

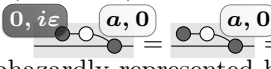
The result is a quantum channel with an error; however, in the infinitely-squeezed limit of  $\varepsilon = 0$  Alice teleports a perfect channel to Bob: . In the literature, the infinitely-squeezed Bell state is often haphazardly represented by the non-convergent integral  $\int_{\mathbb{R}} |p : \hat{p}\rangle \otimes |p : \hat{p}\rangle dp$ . However, we reiterate that this expression *can* be represented in our calculus by an unlabeled 2-legged grey node; and it is interpreted *soundly* in our semantics by replacing the integral over position eigenstates  $|p : \hat{p}\rangle$  with the *relational composition* in the phase-space.

Note that in this derivation we could have used the vacuum generator instead of the  $(0, i)$  phase, just like in equation (10).

## 5.6 Picturing quantum optics

$\text{GSA}_{\mathbb{C}}^+$  allows us to reason diagrammatically about Gaussian quantum mechanics. Perhaps the most important application of Gaussian quantum mechanics is for quantum optics. The LOv-calculus is a complete diagrammatic language for *passive linear* quantum optics [27]. It is a prop defined on the following set of generators, for all  $\theta, \varphi \in \mathbb{R}$ ;

the *phase shifter*, *wave plate*, *beam splitter*, *polarising beam splitter*, *vacuum state* and *effect*:

$$\boxed{\varphi} : 1 \rightarrow 1 \quad \boxed{\theta} : 1 \rightarrow 1 \quad \boxed{\diamond} : 2 \rightarrow 2 \quad \boxed{\theta} : 2 \rightarrow 2 \quad \boxed{\emptyset} : 0 \rightarrow 1 \quad \boxed{\ominus} : 1 \rightarrow 0$$

There is a symmetric monoidal embedding  $\text{LOv} \rightarrow \text{GSA}_{\mathbb{C}}^+$ , given by  $\llbracket n \rrbracket_{\text{GSA}_{\mathbb{C}}^+}^{\text{LOv}} = 2n$  and:

$$\begin{aligned} \llbracket \boxed{\theta} \rrbracket_{\text{GSA}_{\mathbb{C}}^+}^{\text{LOv}} &= \text{Diagram with } \cos(\theta) \text{ and } \tan(\theta) \text{ nodes} & \llbracket \boxed{\varphi} \rrbracket_{\text{GSA}_{\mathbb{C}}^+}^{\text{LOv}} &= \text{Diagram with } \varphi \text{ and } \emptyset \text{ nodes} & \llbracket \boxed{\ominus} \rrbracket_{\text{GSA}_{\mathbb{C}}^+}^{\text{LOv}} &= \text{Diagram with } \ominus \text{ node} \\ \llbracket \boxed{\theta} \rrbracket_{\text{GSA}_{\mathbb{C}}^+}^{\text{LOv}} &= \text{Diagram with } \cos(\theta) \text{ and } \tan(\theta) \text{ nodes} & \llbracket \boxed{\diamond} \rrbracket_{\text{GSA}_{\mathbb{C}}^+}^{\text{LOv}} &= \text{Diagram with } \diamond \text{ node} & \llbracket \boxed{\emptyset} \rrbracket_{\text{GSA}_{\mathbb{C}}^+}^{\text{LOv}} &= \text{Diagram with } \emptyset \text{ node} \end{aligned}$$

The doubling of the objects of LOv accounts for the two polarisation modes of light (typically the *vertical* and *horizontal* modes). By working in  $\text{GSA}_{\mathbb{C}}^+$ , we already have the ability to model additional quantum-optical components and Gaussian unitaries that are not present in LOv, given by the real affine symplectic group [74]. For instance, active squeezing of the vertical polarisation mode, and shearing between the position and momentum operators,



are respectively given for  $a \in \mathbb{R}$  by:

$$\text{---} \begin{array}{c} \boxed{a} \\ \text{---} \end{array} \text{---} \quad \text{---} \begin{array}{c} \boxed{0, a} \\ \text{---} \end{array} \text{---} \quad (12)$$

Furthermore  $\text{GSA}_{\mathbb{C}}^{\dagger}$  is compact closed, as opposed to the usual infinite dimensional Hilbert space semantics, so by contrast we have much more freedom for rewriting in this setting.

---

## References

- 1 A symplectic framework for field theories. URL: <http://link.springer.com/10.1007/3-540-09538-1>, doi:10.1007/3-540-09538-1.
- 2 Samson Abramsky and Chris Heunen.  $H^*$ -algebras and nonunital Frobenius algebras: first steps in infinite-dimensional categorical quantum mechanics. URL: <http://arxiv.org/abs/1011.6123>, arXiv:1011.6123.
- 3 Warit Asavanant, Yu Shiozawa, Shota Yokoyama, Baramée Charoensombutamom, Hiroki Emura, Rafael N. Alexander, Shuntaro Takeda, Jun-ichi Yoshikawa, Nicolas C. Menicucci, Hidehiro Yonezawa, and Akira Furusawa. Time-Domain Multiplexed 2-Dimensional Cluster State: Universal Quantum Computing Platform. *Science*, 366(6463):373–376, October 2019. arXiv:1903.03918. URL: <http://arxiv.org/abs/1903.03918>, doi:10.1126/science.aay2645.
- 4 Miriam Backens. The ZX-calculus is complete for stabilizer quantum mechanics. 16(9):093021. URL: <http://arxiv.org/abs/1307.7025>, arXiv:1307.7025, doi:10.1088/1367-2630/16/9/093021.
- 5 Miriam Backens and Aleks Kissinger. ZH: A complete graphical calculus for quantum computations involving classical non-linearity. *Electronic Proceedings in Theoretical Computer Science*, 287:23–42, January 2019. doi:10.4204/eptcs.287.2.
- 6 Miriam Backens, Hector Miller-Bakewell, Giovanni de Felice, Leo Lobski, and John van de Wetering. There and back again: A circuit extraction tale. *Quantum*, 5:421, March 2021. URL: <http://dx.doi.org/10.22331/q-2021-03-25-421>, doi:10.22331/q-2021-03-25-421.
- 7 John C. Baez, Brandon Coya, and Franciscus Rebro. Props in network theory. *Theory and Applications of Categories*, 33(25):727–783, 2018. URL: <http://www.tac.mta.ca/tac/volumes/33/25/33-25.pdf>.
- 8 John C. Baez and Jason Erbele. Categories in control. *Theory and Applications of Categories*, 30(24):836–881, 2015. URL: <http://www.tac.mta.ca/tac/volumes/30/24/30-24.pdf>.
- 9 John C. Baez and Brendan Fong. A compositional framework for passive linear networks. *Theory and Applications of Categories*, 33(38):pp 1158–1222, 2018. URL: <http://www.tac.mta.ca/tac/volumes/33/38/33-38.pdf>.
- 10 Sara Bartolucci, Patrick Birchall, Hector Bombín, Hugo Cable, Chris Dawson, Mercedes Gimeno-Segovia, Eric Johnston, Konrad Kieling, Naomi Nickerson, Mihir Pant, Fernando Pastawski, Terry Rudolph, and Chris Sparrow. Fusion-based quantum computation. *Nature Communications*, 14(1):912, February 2023. Number: 1 Publisher: Nature Publishing Group. URL: <https://www.nature.com/articles/s41467-023-36493-1>, doi:10.1038/s41467-023-36493-1.
- 11 Sergio Benenti. The category of symplectic reductions. In *Proceedings of the meeting "Geometry and Physics"*.
- 12 Sergio Benenti. Linear symplectic relations. In Albert Crumeyrolle and J. Griffone, editors, *Symplectic Geometry*. Pitman.
- 13 Guillaume Boisseau and Robin Piedeleu. Graphical piecewise-linear algebra. In *Lecture Notes in Computer Science*, pages 101–119. Springer International Publishing, 2022. URL: <https://arxiv.org/pdf/2111.03956.pdf>, doi:10.1007/978-3-030-99253-8\_6.
- 14 Guillaume Boisseau and Paweł Sobociński. String diagrammatic electrical circuit theory. *Electronic Proceedings in Theoretical Computer Science*, 372:178–191, November 2022. doi:10.4204/eptcs.372.13.

- 15 Filippo Bonchi, Alessandro Di Giorgio, and Paweł Sobociński. Diagrammatic polyhedral algebra. In Mikolaj Bojanczyk and Chandra Chekuri, editors, *41st IARCS Annual Conference on Foundations of Software Technology and Theoretical Computer Science, FSTTCS 2021, December 15-17, 2021, Virtual Conference*, volume 213 of *LIPICs*, pages 40:1–40:18. Schloss Dagstuhl - Leibniz-Zentrum für Informatik, 2021. doi:10.4230/LIPICs.FSTTCS.2021.40.
- 16 Filippo Bonchi, Joshua Holland, Robin Piedeleu, Paweł Sobociński, and Fabio Zanasi. Diagrammatic algebra: from linear to concurrent systems. *Proceedings of the ACM on Programming Languages*, 3(POPL):1–28, January 2019. URL: <https://www.ioc.ee/~pawel/papers/pop119.pdf>, doi:10.1145/3290338.
- 17 Filippo Bonchi, Robin Piedeleu, Paweł Sobociński, and Fabio Zanasi. Graphical affine algebra. In *2019 34th Annual ACM/IEEE Symposium on Logic in Computer Science (LICS)*, pages 1–12. IEEE, 2019. URL: <http://www.zanasi.com/fabio/files/paperLICS19.pdf>, doi:10.1109/LICS.2019.8785877.
- 18 Filippo Bonchi, Paweł Sobociński, and Fabio Zanasi. Interacting Hopf algebras. *Journal of Pure and Applied Algebra*, 221(1):144–184, 2017. URL: <https://arxiv.org/pdf/1403.7048.pdf>, doi:10.1016/j.jpaa.2016.06.002.
- 19 Filippo Bonchi, Paweł Sobociński, and Fabio Zanasi. *A Categorical Semantics of Signal Flow Graphs*, page 435–450. Springer Berlin Heidelberg, 2014. URL: <https://hal.science/hal-02134182/file/sfg.pdf>, doi:10.1007/978-3-662-44584-6\_30.
- 20 Filippo Bonchi, Paweł Sobociński, and Fabio Zanasi. The calculus of signal flow diagrams i: Linear relations on streams. *Information and Computation*, 252:2–29, February 2017. URL: <https://www.ioc.ee/~pawel/papers/sfg1.pdf>, doi:10.1016/j.ic.2016.03.002.
- 21 Robert I. Booth and Titouan Carette. Complete ZX-calculi for the stabiliser fragment in odd prime dimensions. In Stefan Szeider, Robert Ganian, and Alexandra Silva, editors, *47th International Symposium on Mathematical Foundations of Computer Science (MFCS 2022)*, volume 241 of *Leibniz International Proceedings in Informatics (LIPIcs)*, pages 24:1–24:15. Schloss Dagstuhl – Leibniz-Zentrum für Informatik. ISSN: 1868-8969. URL: <https://drops.dagstuhl.de/opus/volltexte/2022/16822>, doi:10.4230/LIPICs.MFCS.2022.24.
- 22 Robert I. Booth, Titouan Carette, and Cole Comfort. Graphical symplectic algebra, 2024. URL: <https://arxiv.org/abs/2401.07914>, arXiv:arXiv:2401.07914.
- 23 Cyril Branciard, Alexandre Clément, Mehdi Mhalla, and Simon Perdrix. Coherent control and distinguishability of quantum channels via pbs-diagrams. Schloss Dagstuhl – Leibniz-Zentrum für Informatik, 2021. URL: <https://drops.dagstuhl.de/entities/document/10.4230/LIPICs.MFCS.2021.22>, doi:10.4230/LIPICs.MFCS.2021.22.
- 24 Jonatan Bohr Brask. Gaussian states and operations – a quick reference, 2021. URL: <https://arxiv.org/abs/2102.05748>, arXiv:arXiv:2102.05748.
- 25 Samuel L Braunstein and H J Kimble. Teleportation of continuous quantum variables. 80(4):4. doi:10.1103/PhysRevLett.80.869.
- 26 Samuel L. Braunstein and Peter van Loock. Quantum information with continuous variables. *Reviews of Modern Physics*, 77(2):513–577, June 2005. arXiv: quant-ph/0410100. URL: <http://arxiv.org/abs/quant-ph/0410100>, doi:10.1103/RevModPhys.77.513.
- 27 Alexandre Clément, Nicolas Heurtel, Shane Mansfield, Simon Perdrix, and Benoît Valiron. LOV-calculus: A graphical language for linear optical quantum circuits. In Stefan Szeider, Robert Ganian, and Alexandra Silva, editors, *47th International Symposium on Mathematical Foundations of Computer Science (MFCS 2022)*, volume 241 of *Leibniz International Proceedings in Informatics (LIPIcs)*, pages 35:1–35:16. Schloss Dagstuhl – Leibniz-Zentrum für Informatik. ISSN: 1868-8969. URL: <https://drops.dagstuhl.de/opus/volltexte/2022/16833>, doi:10.4230/LIPICs.MFCS.2022.35.
- 28 Robin Cockett, Cole Comfort, and Priyaa Srinivasan. Dagger linear logic for categorical quantum mechanics. *Logical Methods in Computer Science*, Volume 17, Issue 4, November 2021. URL: [http://dx.doi.org/10.46298/LMCS-17\(4:8\)2021](http://dx.doi.org/10.46298/LMCS-17(4:8)2021), doi:10.46298/lmcs-17(4:8)2021.

- 29 Bob Coecke and Ross Duncan. Interacting quantum observables: categorical algebra and diagrammatics. *New Journal of Physics*, 13(4):043016, April 2011. doi:10.1088/1367-2630/13/4/043016.
- 30 Bob Coecke and Aleks Kissinger. *Picturing Quantum Processes: A First Course on Quantum Theory and Diagrammatic Reasoning*, page 28–31. Springer International Publishing, 2018. URL: [http://dx.doi.org/10.1007/978-3-319-91376-6\\_6](http://dx.doi.org/10.1007/978-3-319-91376-6_6), doi:10.1007/978-3-319-91376-6\_6.
- 31 Cole Comfort. The algebra for stabilizer codes. arXiv:2304.10584[quant-ph], doi:10.48550/arXiv.2304.10584.
- 32 Cole Comfort. The ZX-calculus: A complete graphical calculus for classical circuits using spiders. In Benoît Valiron, Shane Mansfield, Pablo Arrighi, and Prakash Panangaden, editors, Proceedings 17th International Conference on *Quantum Physics and Logic*, Paris, France, June 2 - 6, 2020, volume 340 of *Electronic Proceedings in Theoretical Computer Science*, pages 60–90. Open Publishing Association, 2021. doi:10.4204/EPTCS.340.4.
- 33 Cole Comfort and Aleks Kissinger. A graphical calculus for lagrangian relations. *Electronic Proceedings in Theoretical Computer Science*, 372:338–351, November 2022. URL: <http://dx.doi.org/10.4204/EPTCS.372.24>, doi:10.4204/eptcs.372.24.
- 34 Brandon Coya. *Circuits, bond graphs, and signal-flow diagrams: A categorical perspective*. PhD thesis, University of California Riverside, 2018. URL: <https://arxiv.org/pdf/1805.08290.pdf>.
- 35 Niel de Beaudrap and Dominic Horsman. The zx calculus is a language for surface code lattice surgery. *Quantum*, 4:218, January 2020. URL: <http://dx.doi.org/10.22331/q-2020-01-09-218>, doi:10.22331/q-2020-01-09-218.
- 36 Giovanni de Felice, Razin A. Shaikh, Boldizsár Poór, Lia Yeh, Quanlong Wang, and Bob Coecke. Light-matter interaction in the zxw calculus. *Electronic Proceedings in Theoretical Computer Science*, 384:20–46, August 2023. doi:10.4204/eptcs.384.2.
- 37 Grégoire de Gliniasty, Paul Hilaire, Pierre-Emmanuel Emeriau, Stephen C. Wein, Alexia Salavrakos, and Shane Mansfield. A Spin-Optical Quantum Computing Architecture, January 2024. arXiv:2311.05605 [quant-ph]. URL: <http://arxiv.org/abs/2311.05605>, doi:10.48550/arXiv.2311.05605.
- 38 Maurice A De Gosson. *Symplectic geometry and quantum mechanics*, volume 166. Springer Science & Business Media, 2006.
- 39 Maurice A. de Gosson. *Symplectic Methods in Harmonic Analysis and in Mathematical Physics*. Pseudo-Differential Operators. Springer, Basel, 2011.
- 40 Ross Duncan, Aleks Kissinger, Simon Perdrix, and John van de Wetering. Graph-theoretic simplification of quantum circuits with the ZX-calculus. 4:279. doi:10.22331/q-2020-06-04-279.
- 41 Richard D.P. East, John van de Wetering, Nicholas Chancellor, and Adolfo G. Grushin. Aklt-states as zx-diagrams: Diagrammatic reasoning for quantum states. *PRX Quantum*, 3(1), January 2022. URL: <http://dx.doi.org/10.1103/PRXQuantum.3.010302>, doi:10.1103/prxquantum.3.010302.
- 42 Jason Michael Erbele. *Categories in control: applied PROPs*. PhD thesis, University of California Riverside, 2016. URL: <https://arxiv.org/pdf/1611.07591.pdf>.
- 43 Claude Fabre and Nicolas Treps. Modes and states in quantum optics. 92(3):035005. URL: <http://arxiv.org/abs/1912.09321>, arXiv:1912.09321, doi:10.1103/RevModPhys.92.035005.
- 44 Tobias Fritz. A synthetic approach to markov kernels, conditional independence and theorems on sufficient statistics. *Advances in Mathematics*, 370:107239, August 2020. URL: <http://dx.doi.org/10.1016/j.aim.2020.107239>, doi:10.1016/j.aim.2020.107239.
- 45 Stefano Gogioso and Fabrizio Genovese. Infinite-dimensional categorical quantum mechanics. *Electronic Proceedings in Theoretical Computer Science*, 236:51–69, January 2017. URL: <http://dx.doi.org/10.4204/EPTCS.236.4>, doi:10.4204/eptcs.236.4.

- 46 D. Gross. Hudson’s theorem for finite-dimensional quantum systems. *Journal of Mathematical Physics*, 47(12), December 2006. URL: <http://dx.doi.org/10.1063/1.2393152>, doi:10.1063/1.2393152.
- 47 Mile Gu, Christian Weedbrook, Nicolas C. Menicucci, Timothy C. Ralph, and Peter van Loock. Quantum Computing with Continuous-Variable Clusters. *Physical Review A*, 79(6), June 2009. arXiv: 0903.3233. URL: <http://arxiv.org/abs/0903.3233>, doi:10.1103/PhysRevA.79.062318.
- 48 Victor Guillemin and Shlomo Sternberg. Some problems in integral geometry and some related problems in micro-local analysis. 101(4):915. doi:10.2307/2373923.
- 49 Amar Hadzihasanovic. A diagrammatic axiomatisation for qubit entanglement. In *2015 30th Annual ACM/IEEE Symposium on Logic in Computer Science (LICS)*, pages 573–584, Los Alamitos, CA, USA, jul 2015. IEEE Computer Society. URL: <https://arxiv.org/pdf/1501.07082.pdf>, doi:10.1109/LICS.2015.59.
- 50 Chris Heunen and Jamie Vicary. *Categories for quantum theory*. Oxford Graduate Texts in Mathematics. Oxford University Press, London, England, November 2019.
- 51 Nicolas Heurtel. A complete graphical language for linear optical circuits with finite-photon-number sources and detectors. URL: <http://arxiv.org/abs/2402.17693>, arXiv: 2402.17693[quant-ph], doi:10.48550/arXiv.2402.17693.
- 52 Jiaxin Huang, Sarah Meng Li, Lia Yeh, Aleks Kissinger, Michele Mosca, and Michael Vasmer. Graphical css code transformation using zx calculus. *Electronic Proceedings in Theoretical Computer Science*, 384:1–19, August 2023. URL: <http://dx.doi.org/10.4204/EPTCS.384.1>, doi:10.4204/eptcs.384.1.
- 53 Emmanuel Jeandel, Simon Perdrix, and Margarita Veshchezerova. Addition and Differentiation of ZX-Diagrams. In Amy P. Felty, editor, *7th International Conference on Formal Structures for Computation and Deduction (FSCD 2022)*, volume 228 of *Leibniz International Proceedings in Informatics (LIPIcs)*, pages 13:1–13:19, Dagstuhl, Germany, 2022. Schloss Dagstuhl – Leibniz-Zentrum für Informatik. URL: <https://drops.dagstuhl.de/entities/document/10.4230/LIPIcs.FSCD.2022.13>, doi:10.4230/LIPIcs.FSCD.2022.13.
- 54 Emmanuel Jeandel, Simon Perdrix, and Renaud Vilmart. Completeness of the ZX-Calculus. *Logical Methods in Computer Science*, Volume 16, Issue 2, June 2020. doi:10.23638/LMCS-16(2:11)2020.
- 55 Aleks Kissinger. Finite matrices are complete for (dagger-)hypergraph categories, August 2015. arXiv:1406.5942 [math]. URL: <http://arxiv.org/abs/1406.5942>, doi:10.48550/arXiv.1406.5942.
- 56 Aleks Kissinger and John van de Wetering. Reducing the number of non-clifford gates in quantum circuits. *Physical Review A*, 102(2), August 2020. URL: <https://arxiv.org/pdf/1903.10477.pdf>, doi:10.1103/physreva.102.022406.
- 57 B Lawruk, J Śniatycki, and W.M Tulczyjew. Special symplectic spaces. 17(2):477–497. URL: <https://linkinghub.elsevier.com/retrieve/pii/S0022039675900571>, doi:10.1016/0022-0396(75)90057-1.
- 58 Seth Lloyd and Samuel L. Braunstein. Quantum computation over continuous variables. *Physical Review Letters*, 82(8):1784–1787, February 1999. arXiv: quant-ph/9810082. URL: <http://arxiv.org/abs/quant-ph/9810082>, doi:10.1103/PhysRevLett.82.1784.
- 59 Nicolas C. Menicucci, Steven T. Flammia, and Peter van Loock. Graphical calculus for Gaussian pure states. *Physical Review A*, 83(4), April 2011. arXiv: 1007.0725. URL: <http://arxiv.org/abs/1007.0725>, doi:10.1103/PhysRevA.83.042335.
- 60 Nicolas C. Menicucci, Peter van Loock, Mile Gu, Christian Weedbrook, Timothy C. Ralph, and Michael A. Nielsen. Universal Quantum Computation with Continuous-Variable Cluster States. *Physical Review Letters*, 97(11), September 2006. arXiv: quant-ph/0605198. URL: <http://arxiv.org/abs/quant-ph/0605198>, doi:10.1103/PhysRevLett.97.110501.
- 61 Kang Feng Ng and Quanlong Wang. A universal completion of the ZX-calculus, 2017. URL: <https://arxiv.org/pdf/1706.09877.pdf>.

- 62 Luis Ortiz-Gutiérrez, Bruna Gabrielly, Luis F. Muñoz, Kainã T. Pereira, Jefferson G. Filgueiras, and Alessandro S. Villar. Continuous variables quantum computation over the vibrational modes of a single trapped ion. *Optics Communications*, 397:166–174, August 2017. arXiv:1603.00065 [quant-ph]. URL: <http://arxiv.org/abs/1603.00065>, doi:10.1016/j.optcom.2017.04.011.
- 63 Boldizsár Poór, Robert I. Booth, Titouan Carette, John Van De Wetering, and Lia Yeh. The qubit stabiliser ZX-travaganza: Simplified axioms, normal forms and graph-theoretic simplification. In *Electronic Proceedings in Theoretical Computer Science*, volume 384, pages 220–264. doi:10.4204/EPTCS.384.13.
- 64 Laurent Schwartz. Théorie des distributions à valeurs vectorielles. i. In *Annales de l'institut Fourier*, volume 7, pages 1–141, 1957.
- 65 Dario Stein and Richard Samuelson. A category for unifying gaussian probability and nondeterminism. Schloss Dagstuhl – Leibniz-Zentrum für Informatik, 2023. URL: <https://drops.dagstuhl.de/entities/document/10.4230/LIPIcs.CALCO.2023.13>, doi:10.4230/LIPIcs.CALCO.2023.13.
- 66 Dario Stein, Fabio Zanasi, Richard Samuelson, and Robin Piedeleu. Graphical quadratic algebra. URL: <http://arxiv.org/abs/2403.02284>, arXiv:2403.02284[cs,math].
- 67 Alexis Toumi, Richie Yeung, and Giovanni de Felice. Diagrammatic differentiation for quantum machine learning. *Electronic Proceedings in Theoretical Computer Science*, 343:132–144, September 2021. URL: <http://dx.doi.org/10.4204/EPTCS.343.7>, doi:10.4204/eptcs.343.7.
- 68 W. M. Tulczyjew and S. Zakrzewski. The category of Fresnel kernels. 1(3):79–120. URL: <https://www.sciencedirect.com/science/article/pii/S0393044084900214>, doi:10.1016/0393-0440(84)90021-4.
- 69 Pawel Urbanski. The structure of positive linear symplectic relations. 119. URL: <https://www.fuw.edu.pl/~urbanski/Skany/StrPosRel.pdf>.
- 70 John van de Wetering. ZX-calculus for the working quantum computer scientist, 2020. URL: <https://arxiv.org/pdf/2012.13966.pdf>.
- 71 Maarten Van den Nest, Jeroen Dehaene, and Bart De Moor. Graphical description of the action of local Clifford transformations on graph states. 69(2):022316. Publisher: American Physical Society. URL: <https://arxiv.org/pdf/quant-ph/0308151.pdf>, doi:10.1103/PhysRevA.69.022316.
- 72 John Von Neumann. *Mathematical foundations of quantum mechanics*. Princeton, NJ, February 2018.
- 73 Quanlong Wang. Qutrit ZX-calculus is complete for stabilizer quantum mechanics. In Bob Coecke and Aleks Kissinger, editors, Proceedings 14th International Conference on *Quantum Physics and Logic*, Nijmegen, The Netherlands, 3-7 July 2017, volume 266 of *Electronic Proceedings in Theoretical Computer Science*, pages 58–70. Open Publishing Association, 2018. doi:10.4204/EPTCS.266.3.
- 74 Christian Weedbrook, Stefano Pirandola, Raul Garcia-Patron, Nicolas J. Cerf, Timothy C. Ralph, Jeffrey H. Shapiro, and Seth Lloyd. Gaussian quantum information. 84(2):621–669. URL: <http://arxiv.org/abs/1110.3234>, arXiv:1110.3234, doi:10.1103/RevModPhys.84.621.
- 75 Alan Weinstein. Symplectic categories. arXiv:0911.4133[math], doi:10.48550/arXiv.0911.4133.
- 76 Alan Weinstein. The symplectic “category”. volume 905, pages 45–51. Springer Berlin Heidelberg. Book Title: *Differential Geometric Methods in Mathematical Physics* Series Title: *Lecture Notes in Mathematics*. URL: <http://link.springer.com/10.1007/BFb0092426>, doi:10.1007/BFb0092426.
- 77 Jan C. Willems. Open stochastic systems. *IEEE Transactions on Automatic Control*, 58(2):406–421, 2013. doi:10.1109/TAC.2012.2210836.
- 78 Shota Yokoyama, Ryuji Ukai, Seiji C. Armstrong, Chanond Sornphiphatphong, Toshiyuki Kaji, Shigenari Suzuki, Jun-ichi Yoshikawa, Hidehiro Yonezawa, Nicolas C. Menicucci, and

- Akira Furusawa. Ultra-large-scale continuous-variable cluster states multiplexed in the time domain. *Nature Photonics*, 7(12):982–986, December 2013. URL: <http://www.nature.com/articles/nphoton.2013.287>, doi:10.1038/nphoton.2013.287.
- 79 Jun-ichi Yoshikawa, Shota Yokoyama, Toshiyuki Kaji, Chanond Sornphiphatphong, Yu Shiozawa, Kenzo Makino, and Akira Furusawa. Generation of one-million-mode continuous-variable cluster state by unlimited time-domain multiplexing. *APL Photonics*, 1(6):060801, September 2016. arXiv: 1606.06688. URL: <http://arxiv.org/abs/1606.06688>, doi:10.1063/1.4962732.
- 80 D. L. Zhou, B. Zeng, Z. Xu, and C. P. Sun. Quantum computation based on d-level cluster states. 68(6):062303. URL: <http://arxiv.org/abs/quant-ph/0304054>, arXiv:quant-ph/0304054, doi:10.1103/PhysRevA.68.062303.

## A Axiom tables

### A.1 Graphical affine algebra

The following presentation of  $\text{AffRel}_{\mathbb{K}}$  is adapted from, Booth et al. [22], which is itself a modified version of the presentation given by Bonchi et al. [17].

► **Definition 40.** Let  $\text{GAA}_{\mathbb{K}}$  be the compact prop where the arrows are generated by grey and white spiders, as well as scalar multiplication for every  $a \in \mathbb{K}$ :

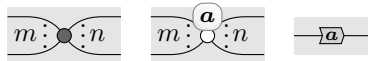

Modulo the equations making the grey and white spiders flexsymmetric as well as the equations, for all  $a, b \in \mathbb{K}$  and  $c \in \mathbb{K}^*$ :

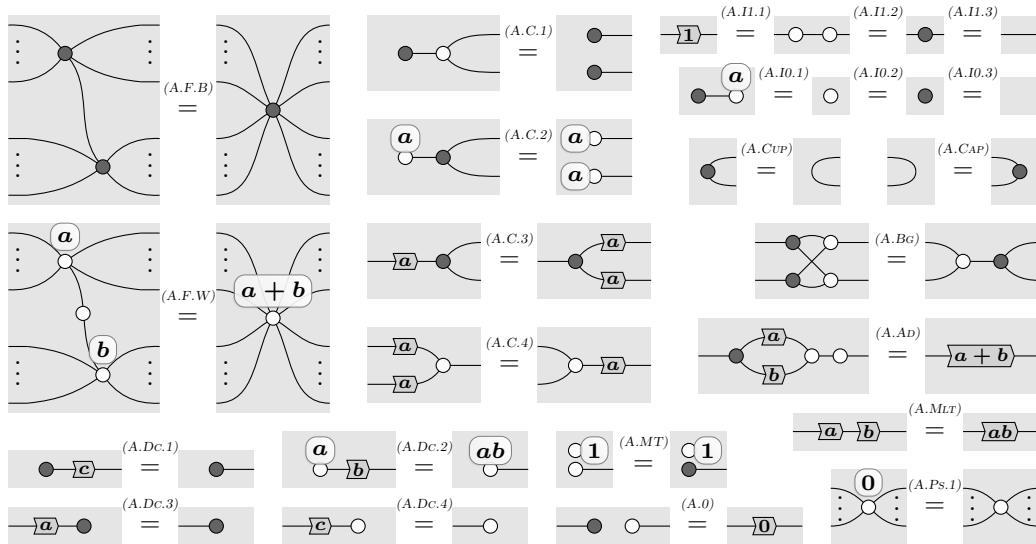

With the derived generators, for all  $a \in \mathbb{K}$ :

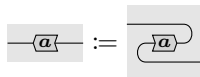

**B Representing symplectomorphisms and rotations**

In this appendix, we review generators for the groups of symplectomorphisms, rotations and symplectic rotations over  $\mathbb{R}$ .

► **Definition 41.** Denote the group of symplectomorphisms on  $(\mathbb{K}^{2n}, \omega_n)$  by  $\text{Sp}_n(\mathbb{K})$ .

► **Lemma 42.** Elements of this group have the following matrix representation

$$\text{Sp}_n(\mathbb{K}) = \left\{ \begin{bmatrix} A & B \\ C & D \end{bmatrix} \in \text{M}_{2n,2n}(\mathbb{K}) \mid \begin{array}{l} A^\top C = C^\top A \\ B^\top C = C^\top B \\ I = A^\top D - C^\top B \end{array} \right\}$$

► **Lemma 43.** The prop  $\bigcup_{n \in \mathbb{N}} \text{Sp}_n(\mathbb{K})$  is generated by the following matrices (with the corresponding matrices in  $\text{GSA}_{\mathbb{K}}$  drawn beside them) under the direct sum and composition, for all  $A \in \text{Gl}_n(\mathbb{K})$  and  $B \in \text{Sym}_n(\mathbb{K})$ :

$$\begin{bmatrix} A & 0 \\ 0 & A^{-\top} \end{bmatrix} \leftrightarrow \text{---} \begin{array}{c} \text{A} \\ \text{D} \end{array} \text{---}, \quad \begin{bmatrix} I & B \\ 0 & I \end{bmatrix} \leftrightarrow \text{---} \begin{array}{c} \text{0, B} \\ \text{---} \end{array} \text{---}, \quad \begin{bmatrix} I & 0 \\ B & I \end{bmatrix} \leftrightarrow \text{---} \begin{array}{c} \text{0, B} \\ \text{---} \end{array} \text{---}, \quad \begin{bmatrix} 0 & I \\ -I & 0 \end{bmatrix} \leftrightarrow \text{---} \square \text{---}$$

► **Definition 44.** A matrix  $Q \in \text{Gl}_n(\mathbb{K})$  is **orthogonal** when  $Q^\top Q = QQ^\top = 1$ . The orthogonal group  $\text{O}_n(\mathbb{K})$  consists of the subgroup of  $\text{Gl}_n(\mathbb{K})$  given by orthogonal matrices. A **rotation** is an orthogonal matrix  $R \in \text{O}_n(\mathbb{K})$  with  $\det(R) = 1$ . The **special orthogonal group**  $\text{SO}_n(\mathbb{K})$  is the subgroup of  $\text{O}_n(\mathbb{K})$  given by rotations.

► **Lemma 45.** The prop of rotations,  $\bigcup_{n \in \mathbb{N}} \text{SO}_n(\mathbb{R})$ , is generated rotation matrices  $\mathcal{R}(\theta)$  and the identity matrices on 0 and 1 under direct sum and composition, for all  $\theta \in [0, 2\pi)$ :

$$\mathcal{R}(\theta) := \begin{bmatrix} \cos(\theta) & -\sin(\theta) \\ \sin(\theta) & \cos(\theta) \end{bmatrix} \quad \text{drawn in } \text{GAA}_{\mathbb{K}} \text{ as } \text{---} \begin{array}{c} \mathcal{R}(\theta) \\ \text{D} \end{array} \text{---}$$

► **Definition 46.** The group of symplectic rotations is the intersection  $\text{Sp}_n(\mathbb{R}) \cap \text{O}_{2n}(\mathbb{R})$ . In other words, a symplectic rotation is a symplectomorphism of the form:

$$R := \begin{bmatrix} C & -S \\ S & C \end{bmatrix}$$

The condition that  $\mathbb{R}$  is a symplectomorphism is equivalent to  $A + iB$  being unitary; which induces a group isomorphism  $\text{Sp}_n(\mathbb{R}) \cap \text{O}_{2n}(\mathbb{R}) \cong \text{U}_n(\mathbb{C})$ .

► **Lemma 47.** The prop of symplectic rotations,  $\bigcup_{n \in \mathbb{N}} \text{Sp}_n(\mathbb{R}) \cap \text{O}_{2n}(\mathbb{R})$ , is generated by the following matrices under direct sum and composition, for all  $\theta \in [0, 2\pi)$ :

$$\mathcal{R}(\theta) := \begin{bmatrix} \cos(\theta) & -\sin(\theta) \\ \sin(\theta) & \cos(\theta) \end{bmatrix} \quad \text{and} \quad \mathcal{S}(\theta) := \begin{bmatrix} \cos(\theta) & -\sin(\theta) & 0 & 0 \\ \sin(\theta) & \cos(\theta) & 0 & 0 \\ 0 & 0 & \cos(\theta) & -\sin(\theta) \\ 0 & 0 & \sin(\theta) & \cos(\theta) \end{bmatrix}$$

The symplectic rotations  $\mathcal{R}(\pi/2)$ ,  $\mathcal{R}(3\pi/2)$ ,  $\mathcal{R}(\vartheta)$ , and  $\mathcal{S}(\vartheta)$  for  $\theta \in [0, 2\pi) \setminus \{\pi/2, 3\pi/2\}$  and  $\vartheta \in [0, 2\pi)$  are respectively given in  $\text{GSA}_{\mathbb{R}}$  by:

$$\text{---} \square \text{---}, \quad \text{---} \square \text{---}, \quad \text{---} \begin{array}{c} \text{cos}(\theta) \quad \text{0, cos}(\theta) \quad \text{sin}(\theta) \\ \text{---} \\ \text{0, tan}(\theta) \end{array} \text{---} \quad \text{and} \quad \text{---} \begin{array}{c} \mathcal{R}(\vartheta) \\ \text{D} \end{array} \text{---}$$

Where  $\mathcal{R}(\pi/4)^2 = \mathcal{R}(\pi/2)$  and  $\mathcal{R}(\pi/2)^3 = \mathcal{R}(3\pi/2)$ , so the symplectic Fourier transform and inverse symplectic Fourier transform, which account for the asymptotes of the tangent function are not needed as generators.

## C Proofs

### C.1 Proofs of section 4

**Proof of proposition 21.** First, remark that the definition of a Lagrangian subspace being positive is equivalent to the Hermitian form  $H := \frac{i}{2}\Omega$  being positive semidefinite, where we recall that  $\Omega$  is the antisymmetric matrix induced by the symplectic form  $\omega(-, =)$ .

We proceed by showing first (1)  $\Rightarrow$  (2) then (2)  $\Rightarrow$  (1) and finally (1)  $\Leftrightarrow$  (3). In each case, we have have a Lagrangian subspace  $\mathcal{L} \subseteq (\mathbb{C}^{2n}, \omega_n)$  with AP invariant  $(E, \varphi)$ , with  $r := \text{rank}(\text{Im}(\varphi))$ . For convenience, take  $J_r := \text{diag}(J_r, 0) \in M_{n,n}(\mathbb{R})$ .

$$\boxed{(1) \Rightarrow (2)}$$

Suppose that  $E$  is real and  $\text{Im}(\varphi) \succeq 0$ . Then,  $\mathcal{L}$  is real symplectomorphic to:

$$\ker \begin{bmatrix} I & L & | & \varphi & 0 \\ 0 & 0 & | & -L^\top & I \end{bmatrix}$$

Where  $L$  has real coefficients and  $\text{Im}(\varphi) \succeq 0$ . Then:

$$\begin{bmatrix} I & -L \\ 0 & I \end{bmatrix} \begin{bmatrix} I & L & | & \varphi & 0 \\ 0 & 0 & | & -L^\top & I \end{bmatrix} \begin{bmatrix} I & 0 & 0 & 0 \\ 0 & I & 0 & 0 \\ 0 & 0 & I & 0 \\ 0 & 0 & 0 & I \end{bmatrix} \begin{bmatrix} I & 0 & -\text{Re}(\varphi) - LL^\top & L \\ 0 & I & L^\top & -I \\ 0 & 0 & I & 0 \\ 0 & 0 & 0 & I \end{bmatrix} = \begin{bmatrix} I & 0 & | & i\text{Im}(\varphi) & 0 \\ 0 & I & | & 0 & 0 \end{bmatrix}$$

We get that  $\mathcal{L}$  is real symplectomorphic to:

$$\ker \begin{bmatrix} I & 0 & | & i\text{Im}(\varphi) & 0 \\ 0 & I & | & 0 & 0 \end{bmatrix}$$

Since  $\text{Im}(\varphi) \succeq 0$  there is an orthogonal matrix  $O$  such that  $O^\top \text{Im}(\varphi) O = \Lambda$  where  $\Lambda$  is a diagonal matrix with non-negative coefficients. We denote  $\sqrt{\Lambda}$  the invertible diagonal matrix whose coefficients are the square root of those of  $\Lambda$  if they are non-zero and else 1. We have  $\sqrt{\Lambda}^{-1} \Lambda \sqrt{\Lambda}^{-1} = J_r$ . Then:

$$\begin{bmatrix} O^\top & 0 \\ 0 & I \end{bmatrix} \begin{bmatrix} I & 0 & | & i\text{Im}(\varphi) & 0 \\ 0 & I & | & 0 & 0 \end{bmatrix} \begin{bmatrix} O & 0 & 0 & 0 \\ 0 & I & 0 & 0 \\ 0 & 0 & O & 0 \\ 0 & 0 & 0 & I \end{bmatrix} = \begin{bmatrix} I & 0 & | & i\Lambda & 0 \\ 0 & I & | & 0 & 0 \end{bmatrix}$$

and:

$$\begin{bmatrix} \sqrt{\Lambda}^{-1} & 0 \\ 0 & I \end{bmatrix} \begin{bmatrix} I & 0 & | & i\Lambda & 0 \\ 0 & I & | & 0 & 0 \end{bmatrix} \begin{bmatrix} \sqrt{\Lambda} & 0 & 0 & 0 \\ 0 & I & 0 & 0 \\ 0 & 0 & \sqrt{\Lambda}^{-1} & 0 \\ 0 & 0 & 0 & 0 \end{bmatrix} = \begin{bmatrix} I & 0 & | & iJ_r & 0 \\ 0 & I & | & 0 & 0 \end{bmatrix}$$

Finally,  $\mathcal{L}$  is real symplectomorphic to  $\ker [I | iJ_r]$ .

$$\boxed{(2) \Rightarrow (1)}$$



Suppose that  $\mathcal{L}$  is real symplectomorphic to  $\ker [I|iJ_r]$ . By reducing to the AP-form we already know that  $\mathcal{L}$  is real symplectomorphic to

$$\ker \left[ \begin{array}{c|c} I & L \\ \hline 0 & 0 \end{array} \middle| \begin{array}{c} \varphi & 0 \\ -L^\top & I \end{array} \right]$$

Furthermore we have:

$$\left[ \begin{array}{c|c} I & -L \\ \hline 0 & I \end{array} \right] \left[ \begin{array}{c|c} I & L \\ \hline 0 & 0 \end{array} \middle| \begin{array}{c} \varphi & 0 \\ -L^\top & I \end{array} \right] \left[ \begin{array}{cccc} I & 0 & 0 & 0 \\ 0 & I & 0 & 0 \\ 0 & 0 & I & 0 \\ 0 & 0 & 0 & I \end{array} \right] \left[ \begin{array}{ccc} I & 0 & \text{Re}(-\varphi - LL^\top) & \text{Re}(L) \\ 0 & I & \text{Re}(L^\top) & -I \\ 0 & 0 & I & 0 \\ 0 & 0 & 0 & I \end{array} \right] = \left[ \begin{array}{c|c} I & 0 \\ \hline 0 & I \end{array} \middle| \begin{array}{c} i \text{Im}(\varphi + LL^\top) & -i \text{Im}(L) \\ -i \text{Im}(L^\top) & 0 \end{array} \right]$$

Thus  $\mathcal{L}$  is real symplectomorphic to:

$$\ker \left[ \begin{array}{c|c} I & 0 \\ \hline 0 & I \end{array} \middle| \begin{array}{c} i \text{Im}(\varphi + LL^\top) & -i \text{Im}(L) \\ -i \text{Im}(L^\top) & 0 \end{array} \right]$$

Now setting  $\Phi := \begin{bmatrix} \text{Im}(\varphi + LL^\top) & -\text{Im}(L^\top) \\ -\text{Im}(L) & 0 \end{bmatrix}$ , we look at the conditions that  $L$  and  $\varphi$  must satisfy for  $\mathcal{L} = \ker [I|i\Phi]$  to be real symplectomorphic to  $\ker [I|iJ_r]$ . In other words, such that there exists real matrices  $A, B, C, D, X$  and  $Y$ , with  $X + iY$  invertible and  $\begin{bmatrix} A & B \\ C & D \end{bmatrix}$  a symplectomorphism, such that:

$$[I|iJ_r] \begin{bmatrix} A & B \\ C & D \end{bmatrix} = (X + iY) [I|i\Phi]$$

This gives:

$$[A + iJ_r C | B + iJ_r D] = [X + iY | -Y\Phi + iX\Phi]$$

and then by identifying the real and imaginary parts:

$$\begin{cases} A = X \\ J_r C = Y \\ B = -Y\Phi \\ J_r D = X\Phi \end{cases}$$

we can eliminate  $X$  and  $Y$ :

$$\begin{cases} B = -J_r C\Phi \\ J_r D = A\Phi \end{cases}$$

To this we can furthermore add the symplectic condition giving:

$$\begin{cases} B = -J_r C \Phi \\ J_r D = A \Phi \\ B^\top D = D^\top B \\ A^\top C = C^\top A \\ I = A^\top D - C^\top B \end{cases}$$

Notice that the third equation is redundant as it follows from the others:

$$B^\top D = -\Phi C^\top J_r D = -\Phi C^\top A \Phi = -\Phi A^\top C \Phi = -D^\top J_r C \Phi = -D^\top B.$$

We can now eliminate  $B$  and get:

$$\begin{cases} J_r D = A \Phi \\ A^\top C = C^\top A \\ I = A^\top D + C^\top J_r C \Phi \end{cases}$$

Multiplying the last equation by  $\Phi$  on the left we get:

$$\Phi = \Phi A^\top D + \Phi C^\top J_r C \Phi$$

Using  $J_r D = A \Phi$  gives:

$$\Phi = D^\top J_r D + \Phi C^\top J_r C \Phi$$

We see that  $\Phi$  is a sum of positive matrices, this implies that  $\Phi \succeq 0$ . But as  $\Phi = \begin{bmatrix} \text{Im}(\varphi + LL^\top) - \text{Im}(L^\top) \\ -\text{Im}(L) & 0 \end{bmatrix}$ , this implies that  $\text{Im}(L) = 0$  and  $\text{Im}(\varphi) \succeq 0$ . In other words  $E$  has real coefficients and  $\text{Im}(L) = 0$ .

$$\boxed{(3) \Leftrightarrow (1)}$$

As  $\mathcal{L}$  is Lagrangian, using  $\mathcal{L}^\omega = \mathcal{L}$  and  $\ker(B)^\omega = \text{Im}(\Omega B^\top)$  we get:

$$\mathcal{L} = \ker [Z|X] = \text{Im} \left( \Omega_n \begin{bmatrix} Z^\top \\ X^\top \end{bmatrix} \right) = \text{Im} \begin{bmatrix} X^\top \\ -Z^\top \end{bmatrix}$$

Thus the matrix representing the restriction  $H|_{\mathcal{L}}$  of the Hermitian form  $H$  to  $\mathcal{L}$  is:

$$[\bar{X} \ -\bar{Z}] \frac{-i}{2} \Omega_n \begin{bmatrix} X^\top \\ -Z^\top \end{bmatrix} = \frac{-i}{2} (\bar{Z} X^\top - \bar{X} Z^\top)$$

We now take  $[Z|X] = \begin{bmatrix} I & L & \varphi & 0 \\ 0 & 0 & -L^\top & I \end{bmatrix} \begin{bmatrix} P & 0 \\ 0 & P \end{bmatrix}$ . We notice that for any matrix, setting  $B = A \begin{bmatrix} P & 0 \\ 0 & P \end{bmatrix}$ , we have:

$$(\Omega_n B^\top)^\dagger \frac{-i}{2} \Omega_n (\Omega_n B^\top) = \frac{-i}{2} \bar{B} \Omega_n B^\top = \frac{-i}{2} \bar{A} \begin{bmatrix} P & 0 \\ 0 & P \end{bmatrix} \Omega_n \begin{bmatrix} P^\top & 0 \\ 0 & P^\top \end{bmatrix} A^\top = \frac{-i}{2} \bar{A} \Omega_n A^\top$$

This gives the following matrix for the restricted Hermitian form:

$$\begin{aligned} H|_{\mathcal{L}} &= \frac{-i}{2} \left( \begin{bmatrix} I & \bar{L} \\ 0 & 0 \end{bmatrix} \begin{bmatrix} \varphi & -L \\ 0 & I \end{bmatrix} - \begin{bmatrix} \bar{\varphi} & 0 \\ -\bar{L}^\top & I \end{bmatrix} \begin{bmatrix} I & 0 \\ L^\top & 0 \end{bmatrix} \right) \\ &= \begin{bmatrix} \operatorname{Im}(\varphi) & -\operatorname{Im}(L) \\ -\operatorname{Im}(L^\top) & 0 \end{bmatrix} \end{aligned}$$

This matrix is positive if and only if  $\operatorname{Im}(\varphi) \succeq 0$  and  $\operatorname{Im}(L) = 0$  in other words if and only if  $\operatorname{Im}(\varphi) \succeq 0$  and  $E$  has real coefficients.  $\blacktriangleleft$

**Proof of proposition 22.** We proceed in very similar fashion to the proof of proposition 21; indeed we reuse many facts established therein. As a matter of notation, let  $K$  be the symmetric matrix corresponding to the Hermitian form  $\chi(-, =)$ ; ie:

$$K := \begin{bmatrix} 0 & I \\ I & 0 \end{bmatrix}$$

Moreover, take  $J_r := \operatorname{diag}(J_r, \vec{0})$  to be the diagonal matrix with  $r$  1's followed by the appropriate number of 0's.

Again we first show (1)  $\Rightarrow$  (2) then (2)  $\Rightarrow$  (1) and finally (1)  $\Leftrightarrow$  (3). In each case, we have a positive Lagrangian subspace  $\mathcal{L} \subseteq (\mathbb{C}^{2n}, \omega_n)$  with AP invariant  $(E, \varphi)$ , with  $r := \operatorname{rank}(\operatorname{Im}(\varphi))$ . For convenience, take  $J_r := \operatorname{diag}(J_r, 0) \in M_{n,n}(\mathbb{R})$ .

$$\boxed{(1) \Rightarrow (2)}$$

$\mathcal{L}$  is real diagonal symplectomorphic to:

$$\ker \begin{bmatrix} I & L & \varphi & 0 \\ 0 & 0 & -L^\top & I \end{bmatrix}$$

Where  $L$  has real coefficients,  $\operatorname{Im}(\varphi) \succeq 0$  and  $\operatorname{Re}(\varphi) = 0$ . Then:

$$\begin{bmatrix} I & L & \varphi & 0 \\ 0 & 0 & -L^\top & I \end{bmatrix} \begin{bmatrix} I & -L & 0 & 0 \\ 0 & I & 0 & 0 \\ 0 & 0 & I & 0 \\ 0 & 0 & L^\top & I \end{bmatrix} = \begin{bmatrix} I & 0 & i \operatorname{Im}(\varphi) & 0 \\ 0 & 0 & 0 & I \end{bmatrix}$$

We reuse the same trick as for the positive case. Since  $\operatorname{Im}(\varphi) \succeq 0$  there is an orthogonal matrix  $O$  such that  $O^\top \operatorname{Im}(\varphi) O = \Lambda$  where  $\Lambda$  is a diagonal matrix with non-negative coefficients. Then:

$$\begin{bmatrix} O^\top & 0 \\ 0 & I \end{bmatrix} \begin{bmatrix} I & 0 & i \operatorname{Im}(\varphi) & 0 \\ 0 & 0 & 0 & I \end{bmatrix} \begin{bmatrix} O & 0 & 0 & 0 \\ 0 & I & 0 & 0 \\ 0 & 0 & O & 0 \\ 0 & 0 & 0 & I \end{bmatrix} = \begin{bmatrix} I & 0 & i \Lambda & 0 \\ 0 & 0 & 0 & I \end{bmatrix}$$

We denote  $\sqrt{\Lambda}$  the invertible diagonal matrix whose coefficients are the square root of those of  $\Lambda$  if they are non-zero and else 1. We have  $\sqrt{\Lambda}^{-1} \Lambda \sqrt{\Lambda}^{-1} = J_r$ . So:

$$\begin{bmatrix} \sqrt{\Lambda}^{-1} & 0 \\ 0 & I \end{bmatrix} \begin{bmatrix} I & 0 & i\Lambda & 0 \\ 0 & 0 & 0 & I \end{bmatrix} \begin{bmatrix} \sqrt{\Lambda} & 0 & 0 & 0 \\ 0 & I & 0 & 0 \\ 0 & 0 & \sqrt{\Lambda}^{-1} & 0 \\ 0 & 0 & 0 & I \end{bmatrix} = \begin{bmatrix} I & 0 & iJ_r & 0 \\ 0 & 0 & 0 & I \end{bmatrix}$$

Finally,  $\mathcal{L}$  is real diagonal symplectomorphic to  $\ker \begin{bmatrix} I & 0 & iJ_r & 0 \\ 0 & 0 & 0 & I \end{bmatrix}$ .

$$\boxed{(2) \Rightarrow (1)}$$

First,  $\mathcal{L}$  is real diagonal symplectomorphic to

$$\ker \begin{bmatrix} I & L & \varphi & 0 \\ 0 & 0 & -L^\top & I \end{bmatrix}$$

Using the same notation as before, denoting  $O$  the orthogonal matrix diagonalizing  $\text{Im}(\varphi)$  into a diagonal matrix  $\Lambda$ , we have:

$$\begin{bmatrix} O^\top & 0 \\ 0 & I \end{bmatrix} \begin{bmatrix} I & L & \varphi & 0 \\ 0 & 0 & -L^\top & I \end{bmatrix} \begin{bmatrix} O & -L & 0 & 0 \\ 0 & I & 0 & 0 \\ 0 & 0 & O & 0 \\ 0 & 0 & L^\top O & I \end{bmatrix} = \begin{bmatrix} I & 0 & O^\top \text{Re}(\varphi) O + i\Lambda & 0 \\ 0 & 0 & 0 & I \end{bmatrix}$$

Denoting again  $\sqrt{\Lambda}$  the invertible diagonal matrix whose coefficients are the square root of those of  $\Lambda$  if they are non-zero and else 1. We have  $\sqrt{\Lambda}^{-1} \Lambda \sqrt{\Lambda}^{-1} = J_r$  and then:

$$\begin{bmatrix} \sqrt{\Lambda}^{-1} & 0 \\ 0 & I \end{bmatrix} \begin{bmatrix} I & 0 & O^\top \text{Re}(\varphi) O + i\Lambda & 0 \\ 0 & 0 & 0 & I \end{bmatrix} \mathcal{D} \begin{bmatrix} \sqrt{\Lambda} & 0 & 0 & 0 \\ 0 & I & 0 & 0 \\ 0 & 0 & \sqrt{\Lambda}^{-1} & 0 \\ 0 & 0 & 0 & I \end{bmatrix} = \begin{bmatrix} I & 0 & \alpha + iJ_r & 0 \\ 0 & 0 & 0 & I \end{bmatrix}$$

with  $\alpha := \sqrt{\Lambda}^{-1} O^\top \text{Re}(\varphi) O \sqrt{\Lambda}^{-1}$ . We can now look for the necessary conditions on  $\text{Re}(\varphi)$  for  $\ker \begin{bmatrix} I & 0 & \alpha + iJ_r & 0 \\ 0 & 0 & 0 & I \end{bmatrix}$  to be real diagonal symplectomorphic to  $\ker \begin{bmatrix} I & 0 & iJ_r & 0 \\ 0 & 0 & 0 & I \end{bmatrix}$ . In other words, such that there exists real matrices  $A_1, A_2, A_3, A_4, D_1, D_2, D_3, D_4$  and complex matrices  $W_1, W_2, W_3, W_4$  with  $\begin{bmatrix} W_1 & W_2 \\ W_3 & W_4 \end{bmatrix}$  invertible and  $\begin{bmatrix} D_1 & D_2 \\ D_3 & D_4 \end{bmatrix}$  being the transpose of the inverse of  $\begin{bmatrix} A_1 & A_2 \\ A_3 & A_4 \end{bmatrix}$ , satisfying:

$$\begin{bmatrix} I & 0 & \alpha + iJ_r & 0 \\ 0 & 0 & 0 & I \end{bmatrix} \begin{bmatrix} A_1 & A_2 & 0 & 0 \\ A_3 & A_4 & 0 & 0 \\ 0 & 0 & D_1 & D_2 \\ 0 & 0 & D_3 & D_4 \end{bmatrix} = \begin{bmatrix} W_1 & W_2 \\ W_3 & W_4 \end{bmatrix} \begin{bmatrix} I & 0 & iJ_r & 0 \\ 0 & 0 & 0 & I \end{bmatrix}$$

This gives:

$$\begin{bmatrix} A_1 & A_2 & \alpha D_1 + iJ_r D_1 & \alpha D_2 + iJ_r D_2 \\ 0 & 0 & D_3 & D_4 \end{bmatrix} = \begin{bmatrix} W_1 & 0 & iW_1 J_r & W_2 \\ W_3 & 0 & iW_3 J_r & W_4 \end{bmatrix}$$

We directly get  $W_1 = A_1$ ,  $W_2 = \alpha D_2 + iJ_r D_2$ ,  $W_3 = 0$  and  $W_4 = D_4$ , and then  $A_2 = 0$  and  $D_3 = 0$ . From the constraints it follows that  $D_1 = A_1^{-\top}$ ,  $D_2 = -A_1^{-\top} A_3^\top A_4^{-\top}$  and  $D_4 = A_4^{-\top}$ .

Then by identifying the real and imaginary parts gives:

$$\begin{cases} \alpha A_1^{-\top} = 0 \\ J_r A_1^{-\top} = A_1 J_r \end{cases}$$

It implies that  $\alpha = 0$  and then  $\operatorname{Re}(\varphi) = 0$ , as expected.

$$\boxed{(3) \Leftrightarrow (1)}$$

As  $\mathcal{L}$  is Lagrangian, using  $\mathcal{L}^\omega = \mathcal{L}$  and  $\ker(B)^\omega = \operatorname{Im}(\Omega B^\top)$  we get:

$$\mathcal{L} = \ker [Z | X] = \operatorname{Im} \left( \Omega_n \begin{bmatrix} Z^\top \\ X^\top \end{bmatrix} \right) = \operatorname{Im} \begin{bmatrix} X^\top \\ -Z^\top \end{bmatrix}$$

Thus the matrix representing the restriction  $K|_{\mathcal{L}}$  of the Hermitian form  $K$  to  $\mathcal{L}$  is:

$$[\bar{X} \ -\bar{Z}] K \begin{bmatrix} X^\top \\ -Z^\top \end{bmatrix} = -\bar{Z} X^\top - \bar{X} Z^\top$$

We now take  $[Z \ X] = \begin{bmatrix} I & L & \varphi & 0 \\ 0 & 0 & -L^\top & I \end{bmatrix} \begin{bmatrix} P & 0 \\ 0 & P \end{bmatrix}$ . We notice that for any matrix, setting  $B = A \begin{bmatrix} P & 0 \\ 0 & P \end{bmatrix}$ , and using  $K\Omega_n = -\Omega_n K = \begin{bmatrix} -I & 0 \\ 0 & I \end{bmatrix}$  we have:

$$(\Omega_n B^\top)^\dagger K (\Omega_n B^\top) = \bar{A} \begin{bmatrix} P & 0 \\ 0 & P \end{bmatrix} \Omega_n K \Omega_n \begin{bmatrix} P^\top & 0 \\ 0 & P^\top \end{bmatrix} A^\top = \bar{A} K A^\top$$

This gives the following matrix for the restricted Hermitian form:

$$\begin{aligned} K|_{\mathcal{L}} &= - \left( \begin{bmatrix} I & \bar{L} \\ 0 & 0 \end{bmatrix} \begin{bmatrix} \varphi & -L \\ 0 & I \end{bmatrix} + \begin{bmatrix} \bar{\varphi} & 0 \\ -\bar{L}^\top & I \end{bmatrix} \begin{bmatrix} I & 0 \\ L^\top & 0 \end{bmatrix} \right) \\ &= \begin{bmatrix} 2 \operatorname{Re}(\varphi) & +2i \operatorname{Im}(L) \\ -2i \operatorname{Im}(L^\top) & 0 \end{bmatrix} \end{aligned}$$

As we already know that  $\operatorname{Im}(L) = 0$ , this matrix is 0 if and only if  $\operatorname{Re}(\varphi) = 0$ . ◀

**Proof of lemma 20.** First, we prove that positive affine Lagrangian relations are closed under composition. Take two such relations  $(S + \vec{s}) : n \rightarrow m$  and  $(R + \vec{r}) : m \rightarrow k$ . If the composite is empty, then the claim follows vacuously. Otherwise, take some  $[\vec{v}_I^\top \ \vec{v}_O^\top]^\top \in (R + \vec{r}) \circ (S + \vec{s})$ . Then there exists some  $\vec{w} \in \mathbb{C}^{2m}$  such that  $[\vec{v}_I^\top \ \vec{w}^\top]^\top \in (S + \vec{s})$  and  $[\vec{w}^\top \ \vec{v}_O^\top] \in (R + \vec{r})$ .

Therefore:

$$i\omega_{n,k} \left( \begin{bmatrix} \overline{v_I} \\ \overline{v_O} \end{bmatrix}, \begin{bmatrix} \overline{v_I} \\ \overline{v_O} \end{bmatrix} \right) = i\omega_{n,k} \left( \begin{bmatrix} \overline{v_I} \\ \overline{v_O} \end{bmatrix}, \begin{bmatrix} \overline{v_I} \\ \overline{v_O} \end{bmatrix} \right) \quad (13)$$

$$= i\omega_k(\overline{v_O}, \overline{v_O}) - i\omega_n(\overline{v_I}, \overline{v_I}) \quad (14)$$

$$= i\omega_k(\overline{v_O}, \overline{v_O}) - i\omega_k(\overline{w}, \overline{w}) + i\omega_k(\overline{w}, w) - i\omega_n(\overline{v_I}, \overline{v_I}) \quad (15)$$

$$= i\omega_{n,m} \left( \begin{bmatrix} \overline{v_I} \\ \overline{w} \end{bmatrix}, \begin{bmatrix} \overline{v_I} \\ \overline{w} \end{bmatrix} \right) + i\omega_{m,k} \left( \begin{bmatrix} \overline{w} \\ \overline{v_O} \end{bmatrix}, \begin{bmatrix} \overline{w} \\ \overline{v_O} \end{bmatrix} \right) \quad (16)$$

$$= i\omega_{n,m} \left( \begin{bmatrix} \overline{v_I} \\ \overline{w} \end{bmatrix}, \begin{bmatrix} \overline{v_I} \\ \overline{w} \end{bmatrix} \right) + i\omega_{m,k} \left( \begin{bmatrix} \overline{w} \\ \overline{v_O} \end{bmatrix}, \begin{bmatrix} \overline{w} \\ \overline{v_O} \end{bmatrix} \right) \geq 0 \quad (17)$$

Suppose moreover, that  $(S + \overline{s}) : n \rightarrow m$  and  $(R + \overline{r}) : m \rightarrow k$  are quasi-real. Again if the composite is empty, it is vacuously quasi-real. Otherwise, take some

$$[\overline{u_I}^T \ \overline{u_O}^T]^T, [\overline{v_I}^T \ \overline{v_O}^T]^T \in (R + \overline{r}) \circ (S + \overline{s})$$

Then there exist  $\vec{a}, \vec{b} \in \mathbb{C}^{2m}$  such that  $[\overline{v_I}^T \ \vec{a}^T]^T, [\overline{u_I}^T \ \vec{b}^T]^T \in (S + \overline{s}), [\vec{a}^T \ \overline{v_O}^T]^T, [\vec{b}^T \ \overline{u_O}^T]^T \in (R + \overline{r})$ . Therefore,

$$\chi_k(\overline{u_O}, \overline{v_O}) - \chi_n(\overline{u_I}, \overline{v_I}) \quad (18)$$

$$= \chi_k(\overline{u_O}, \overline{v_O}) - \chi_n(\overline{u_I}, \overline{v_I}) + 0 + 0 \quad (19)$$

$$= \chi_k(\overline{u_O}, \overline{v_O}) - \chi_n(\overline{u_I}, \overline{v_I}) - \chi_m(\vec{b}, \vec{a}) + \chi_n(\overline{u_I}, \overline{v_I}) - \chi_k(\overline{u_O}, \overline{v_O}) + \chi_m(\vec{b}, \vec{a}) \quad (20)$$

$$= \chi_k(\overline{u_O}, \overline{v_O}) - \chi_k(\overline{u_O}, \overline{v_O}) + \chi_n(\overline{u_I}, \overline{v_I}) - \chi_n(\overline{u_I}, \overline{v_I}) + \chi_m(\vec{b}, \vec{a}) - \chi_m(\vec{b}, \vec{a}) \quad (21)$$

$$= 0 \quad (22)$$

Now we prove that the cup quasi-real. Take any  $(\bullet, [z \ z \ x \ -x]) \in \eta_1$ . Then

$$\omega_{0,1}((\bullet, [z \ z \ x \ -x]^T), (\bullet, [z \ z \ x \ -x]^T)) = i\omega_1(\overline{[z \ z \ x \ -x]^T}, [z \ z \ x \ -x]^T) \quad (23)$$

$$= i\omega_1([\bar{z} \ \bar{z} \ \bar{x} \ -\bar{x}]^T, [z \ z \ x \ -x]^T) \quad (24)$$

$$= i(\bar{z}(x) + \bar{z}(-x) + \bar{x}(z) - \bar{x}(z)) \quad (25)$$

$$= 0 \quad (26)$$

$$(27)$$

So it is positive. Take another  $(\bullet, [z' \ z' \ x' \ -x']) \in \eta_1$ , then

$$\chi_1([z \ z \ x \ -x]^T, [z' \ z' \ x' \ -x']^T) = \bar{z}(x') + \bar{z}(-x') + \bar{x}(z') - \bar{x}(z') = 0 \quad (28)$$

so it is quasi real. The cap and identity are also quasi-real by the same argument. The symmetry are also clearly quasi-real, and the tensor product clearly preserves both properties.  $\blacktriangleleft$

► **Lemma 48.** Any diagram in  $\text{GAA}_{\mathbb{R}}$  can be rewritten as:

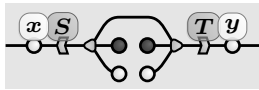

where  $S$  and  $T$  are invertible.

**Proof of lemma 48.** We will work with bipartite states. First any affine subspace can be written as the image of a matrix  $\begin{bmatrix} A \\ B \end{bmatrix}$  translated by a vector  $\begin{bmatrix} x \\ y \end{bmatrix}$  giving a diagram:

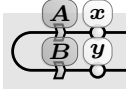

Then we know that we can act on  $A$  with an invertible matrix  $P$  and on  $B$  with an invertible matrix  $Q$  such that

$$A = P \begin{bmatrix} 0 \\ X \end{bmatrix} \quad \text{and} \quad B = Q \begin{bmatrix} Y \\ 0 \end{bmatrix}$$

Giving a diagram:

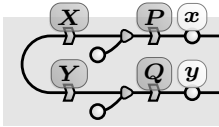

Now we decompose the domain as  $\ker(X) \cap \ker(Y) \oplus E$  and then as  $\ker(X) \cap \ker(Y) \oplus E \cap \ker(Y) \oplus S \oplus E \cap \ker(Y)$ . Denoting  $K$  an invertible matrix doing a change of basis adapted to this decomposition we get:

$$\begin{bmatrix} X \\ Y \end{bmatrix} K = \begin{bmatrix} 0 & X_0 & X_1 & 0 \\ 0 & 0 & Y_0 & Y_1 \end{bmatrix}$$

Diagrammatically:

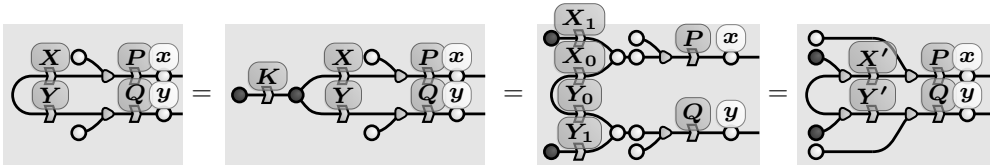

Then one can notice that both  $X' = [X_0 \ X_1]$  and  $Y' = [Y_0 \ Y_1]$  are invertible. ◀

► **Lemma 49.** Any diagram in GGA reduces to the pseudo normal form:

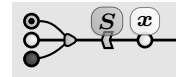

**Proof.** We start by moving all vacuums to the left giving a diagram in the form:

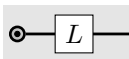

where  $L$  is a diagram in  $GAA_{\mathbb{R}}$ . Applying lemma 48 we get:

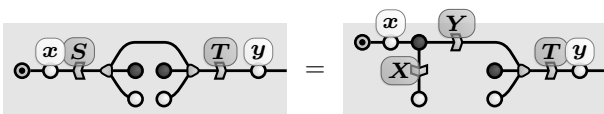

Thus without loss of generality we restrict to reducing in pseudo normal form diagrams of the form:

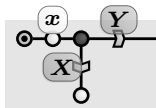

We first apply singular value decomposition to  $X$  giving:

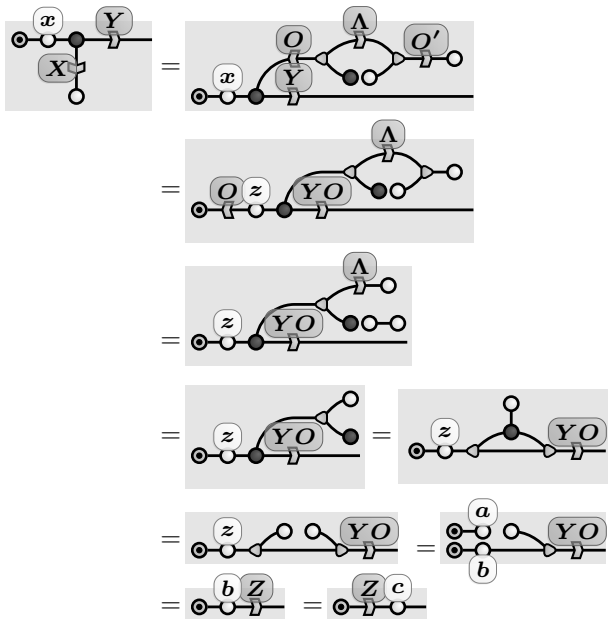

Then applying singular value decomposition to  $Z$  gives:

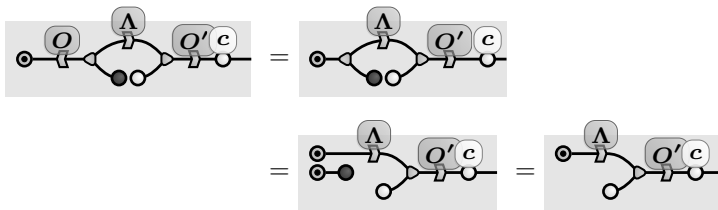

► Lemma 50.

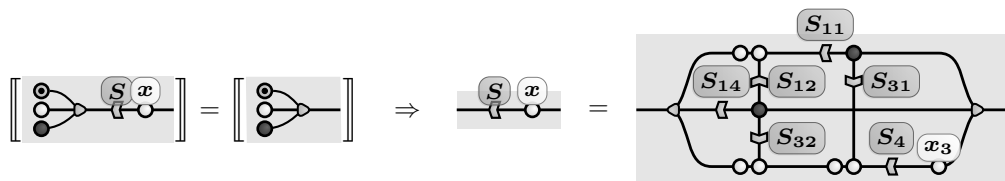

Where  $S_{11}$  is orthogonal, and  $S_{14}$  and  $S_4$  are invertible, furthermore the number of vacuum state generators must be the same on both sides.



**Proof.** In the semantics, the equality:

$$\left[ \left[ \begin{array}{c} \bullet \\ \bullet \\ \bullet \end{array} \right] \left[ \begin{array}{c} \bullet \\ \bullet \\ \bullet \end{array} \right] \right] = \left[ \left[ \begin{array}{c} \bullet \\ \bullet \\ \bullet \end{array} \right] \left[ \begin{array}{c} \bullet \\ \bullet \\ \bullet \end{array} \right] \right]$$

translates to:

$$\begin{bmatrix} x - a \\ -b \end{bmatrix} \in \ker \begin{bmatrix} I & 0 & iJ_r & 0 \\ 0 & 0 & 0 & I \end{bmatrix} \begin{bmatrix} S & 0 \\ 0 & S^{-\top} \end{bmatrix} \Leftrightarrow \begin{bmatrix} a \\ b \end{bmatrix} \in \ker \begin{bmatrix} I & 0 & iI_k & 0 \\ 0 & 0 & 0 & I \end{bmatrix}$$

This implies that that affine subspaces on the left contains 0, thus the affine shift on the left must be in the linear space on the right:

$$\begin{bmatrix} x \\ 0 \end{bmatrix} \in \ker \begin{bmatrix} I & 0 & iJ_k & 0 \\ 0 & 0 & 0 & I \end{bmatrix} \quad \text{so that} \quad x = \begin{bmatrix} 0 \\ 0 \\ x_3 \end{bmatrix}$$

Now that the affine shift has been taken care of we have:

$$\ker \begin{bmatrix} I & 0 & iJ_r & 0 \\ 0 & 0 & 0 & I \end{bmatrix} \begin{bmatrix} S & 0 \\ 0 & S^{-\top} \end{bmatrix} = \ker \begin{bmatrix} I & 0 & iI_k & 0 \\ 0 & 0 & 0 & I \end{bmatrix}$$

In other words, there is an invertible complex matrix  $W$  such that:

$$\begin{bmatrix} I & 0 & iJ_r & 0 \\ 0 & 0 & 0 & I \end{bmatrix} \begin{bmatrix} S & 0 \\ 0 & S^{-\top} \end{bmatrix} = W \begin{bmatrix} I & 0 & iJ_k & 0 \\ 0 & 0 & 0 & I \end{bmatrix}$$

Setting:

$$W = \begin{bmatrix} W_1 & W_2 \\ W_3 & W_4 \end{bmatrix}, S = \begin{bmatrix} S_1 & S_2 \\ S_3 & S_4 \end{bmatrix} \text{ and } S^{-\top} = \begin{bmatrix} (S^{-\top})_1 & (S^{-\top})_2 \\ (S^{-\top})_3 & (S^{-\top})_4 \end{bmatrix}$$

we get:

$$\begin{bmatrix} I & 0 & iJ_r & 0 \\ 0 & 0 & 0 & I \end{bmatrix} \begin{bmatrix} S_1 & S_2 & 0 & 0 \\ S_3 & S_4 & 0 & 0 \\ 0 & 0 & (S^{-\top})_1 & (S^{-\top})_2 \\ 0 & 0 & (S^{-\top})_3 & (S^{-\top})_4 \end{bmatrix} = \begin{bmatrix} W_1 & W_2 \\ W_3 & W_4 \end{bmatrix} \begin{bmatrix} I & 0 & iJ_k & 0 \\ 0 & 0 & 0 & I \end{bmatrix}$$

This gives:

$$\begin{bmatrix} S_1 & S_2 & iJ_r(S^{-\top})_1 & iJ_r(S^{-\top})_2 \\ 0 & 0 & (S^{-\top})_3 & (S^{-\top})_4 \end{bmatrix} = \begin{bmatrix} W_1 & 0 & iW_1J_k & W_2 \\ W_3 & 0 & iW_3J_k & W_4 \end{bmatrix}$$

We directly get  $W_1 = S_1$ ,  $W_2 = iJ_k(S^{-\top})_2$ ,  $W_3 = 0$  and  $W_4 = (S^{-\top})_4$ . We also have  $S_2 = 0$ ,  $J_r(S^{-\top})_1 = S_1J_k$  and  $(S^{-\top})_3 = 0$ . From the constraints it follows that  $(S^{-\top})_1 = (S_1)^{-\top}$ ,  $(S^{-\top})_4 = (S_4)^{-\top}$  and  $(S^{-\top})_2 = -S_1^{-\top}S_3^{\top}S_4^{-\top}$ . Therefore,  $r = k$  and:

$$S = \begin{bmatrix} S_1 & 0 \\ S_3 & S_4 \end{bmatrix}$$



with  $S_{11}$  orthogonal, and  $S_{14}$  and  $S_4$  invertible. Therefore:

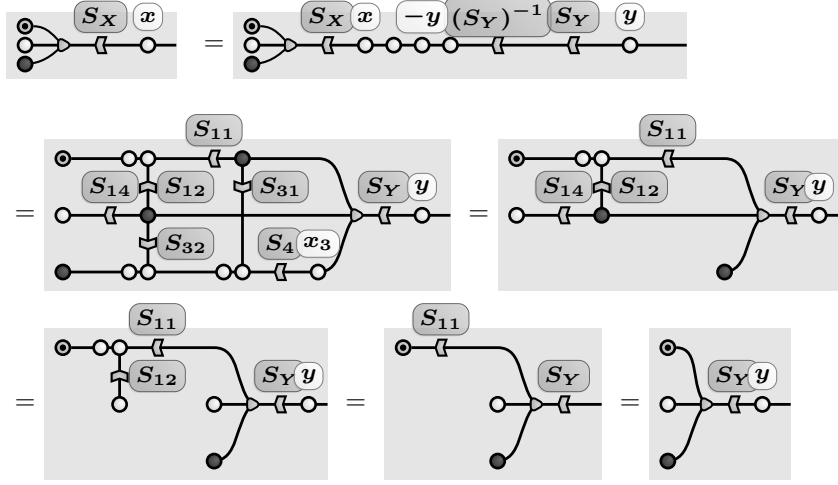

## C.2 Proofs of section 5

**Proof of proposition 29.** We start by computing the Wigner function from the wave-function:

$$W(q, p) = \frac{1}{\pi^n} \int_{\mathbb{R}^n} \bar{\varphi}(q + \xi) \varphi(q - \xi) \exp(2ip^\top \xi) d\xi \quad (29)$$

$$= \frac{1}{\pi^n} \sqrt{\frac{\det(\text{Im}(\Phi))}{\pi^n}} \int_{\mathbb{R}^n} \quad (30)$$

$$\exp\left(-\frac{i}{2}(q + \xi)^\top \bar{\Phi}(q + \xi)\right) \exp\left(\frac{i}{2}(q - \xi)^\top \Phi(q - \xi)\right) \exp(2ip^\top \xi) d\xi \quad (31)$$

We first compute the exponent:

$$-\frac{i}{2}(q + \xi)^\top \bar{\Phi}(q + \xi) + \frac{i}{2}(q - \xi)^\top \Phi(q - \xi) + 2ip^\top \xi \quad (32)$$

$$= \frac{i}{2}(-q^\top \bar{\varphi}q - 2q^\top \bar{\Phi}\xi - \xi^\top \bar{\Phi}\xi + q^\top \Phi q - 2q^\top \Phi\xi + \xi^\top \Phi\xi + 4p^\top \xi) \quad (33)$$

$$= \frac{i}{2}(2iq^\top \text{Im}(\Phi)q - 4q^\top \text{Re}(\Phi)\xi + 2i\xi^\top \text{Im}(\Phi)\xi + 4p^\top \xi) \quad (34)$$

$$= -q^\top \text{Im}(\Phi)q - 2iq^\top \text{Re}(\Phi)\xi - \xi^\top \text{Im}(\Phi)\xi + 2ip^\top \xi \quad (35)$$

$$= -q^\top \text{Im}(\Phi)q - \xi^\top \text{Im}(\Phi)\xi + 2i(p^\top - q^\top \text{Re}(\Phi))\xi \quad (36)$$

Back to the integral:

$$W(q, p) = \frac{1}{\pi^n} \sqrt{\frac{\det(\text{Im}(\Phi))}{\pi^n}} \exp(-q^\top \text{Im}(\Phi)q) \quad (37)$$

$$\int_{\mathbb{R}^n} \exp(-\xi^\top \text{Im}(\Phi)\xi + 2i(p^\top - q^\top \text{Re}(\Phi))\xi) d\xi \quad (38)$$

$$= \frac{1}{\pi^n} \exp(-q^\top \text{Im}(\Phi)q - (p^\top - q^\top \text{Re}(\Phi)) \text{Im}(\Phi)^{-1} (p - \text{Re}(\Phi)q)) \quad (39)$$

Here we used the identity:

$$\int_{\mathbb{R}^n} \exp(-\xi^T A \xi + i J^T \xi) d\xi = \sqrt{\frac{\pi^n}{\det(A)}} \exp\left(-\frac{1}{4} J^T A^{-1} J\right)$$

We can rewrite the exponent as:

$$= -q^T \operatorname{Im}(\Phi) q - (p^T - q^T \operatorname{Re}(\Phi)) \operatorname{Im}(\Phi)^{-1} (p - \operatorname{Re}(\Phi) q) \quad (40)$$

$$= -q^T (\operatorname{Im}(\Phi) + \operatorname{Re}(\Phi) \operatorname{Im}(\Phi)^{-1} \operatorname{Re}(\Phi)) q + 2q^T \operatorname{Re}(\Phi) \operatorname{Im}(\Phi)^{-1} p - p^T \operatorname{Im}(\Phi)^{-1} p \quad (41)$$

$$= - [q^T \ p^T] \begin{bmatrix} \operatorname{Im}(\Phi) + \operatorname{Re}(\Phi) \operatorname{Im}(\Phi)^{-1} \operatorname{Re}(\Phi) & - \operatorname{Re}(\Phi) \operatorname{Im}(\Phi)^{-1} \\ - \operatorname{Im}(\Phi)^{-1} \operatorname{Re}(\Phi) & \operatorname{Im}(\Phi)^{-1} \end{bmatrix} \begin{bmatrix} q \\ p \end{bmatrix} \quad (42)$$

Setting

$$\Sigma := \begin{bmatrix} \operatorname{Im}(\Phi) + \operatorname{Re}(\Phi) \operatorname{Im}(\Phi)^{-1} \operatorname{Re}(\Phi) & - \operatorname{Re}(\Phi) \operatorname{Im}(\Phi)^{-1} \\ - \operatorname{Im}(\Phi)^{-1} \operatorname{Re}(\Phi) & \operatorname{Im}(\Phi)^{-1} \end{bmatrix}$$

we get:

$$W(q, p) = \frac{1}{\pi^n} \exp\left(- [q^T \ p^T] \Sigma \begin{bmatrix} q \\ p \end{bmatrix}\right)$$

We still have to prove that  $\Sigma$  is a covariance matrix. Notice that by definition  $\Sigma^T = \Sigma$  and that the Shur complement formula directly gives  $\det(\Sigma) = 1$ . For positivity, setting:

$$S = \begin{bmatrix} \operatorname{Im}(\varphi)^{\frac{1}{2}} & - \operatorname{Re}(\varphi) \operatorname{Im}(\varphi)^{-\frac{1}{2}} \\ 0 & \operatorname{Im}(\varphi)^{-\frac{1}{2}} \end{bmatrix}$$

We get:  $SS^T = \Sigma \succeq 0$ . Finally, setting

$$T = \begin{bmatrix} 0 & \operatorname{Im}(\Phi)^{\frac{1}{2}} + i \operatorname{Re}(\Phi) \operatorname{Im}(\Phi)^{-\frac{1}{2}} \\ 0 & -i \operatorname{Im}(\Phi)^{-\frac{1}{2}} \end{bmatrix}$$

We get:  $TT^\dagger = \Sigma + i\Omega \succeq 0$ .

Conversely, given a covariance matrix  $\Sigma$  such that  $\Sigma^T = \Sigma$ ,  $\det(\Sigma) = 1$ ,  $\Sigma \succeq 0$  and  $\Sigma + i\Omega \succeq 0$ , Williamson theorem gives us a symplectic matrix  $S$  and a positive diagonal  $\Lambda$  such that:

$$S \begin{bmatrix} \Lambda & 0 \\ 0 & \Lambda \end{bmatrix} S^T = \Sigma$$

So:

$$\Sigma + i\Omega = S \begin{bmatrix} \Lambda & 0 \\ 0 & \Lambda \end{bmatrix} S^T + iS\Omega S^T = S \begin{bmatrix} \Lambda & iI \\ -iI & \Lambda \end{bmatrix} S^T$$

This matrix being positive semi-definite implies that  $\lambda \geq 1$  (take any principal minor of size two) for all symplectic eigenvalues  $\lambda$ . But  $\det(\Sigma) = 1$  implies that  $\lambda = 1$  such that

$\Lambda = I$ . Thus  $\Sigma = SS^T$ . Any symplectic matrix  $S$  admits a unique decomposition of the following form (see [38]):

$$S = \begin{bmatrix} I & B \\ 0 & I \end{bmatrix} \begin{bmatrix} A^{\frac{1}{2}} & 0 \\ 0 & A^{-\frac{1}{2}} \end{bmatrix} O$$

where  $B$  is symmetric and  $A$  is symmetric positive and  $O$  is symplectic orthogonal. Thus  $\Sigma$  is of the form:

$$\Sigma = \begin{bmatrix} A + BA^{-1}B & BA^{-1} \\ A^{-1}B & A^{-1} \end{bmatrix}$$

Setting  $\Phi = -B + iA$  we then see that there is a bijection between covariance matrices  $\Sigma$  and matrices  $\Phi$  such that  $\text{Im}(\Phi) \succ 0$ . The bijection is given by:

$$\Sigma = \begin{bmatrix} \text{Im}(\Phi) + \text{Re}(\Phi) \text{Im}(\Phi)^{-1} \text{Re}(\Phi) & -\text{Re}(\Phi) \text{Im}(\Phi)^{-1} \\ -\text{Im}(\Phi)^{-1} \text{Re}(\Phi) & \text{Im}(\Phi)^{-1} \end{bmatrix}$$

And if

$$\Sigma = \begin{bmatrix} A & B \\ B^T & C \end{bmatrix}$$

then  $\Phi = -BC^{-1} + iC^{-1}$ .



► **Lemma 51.** *Given any symmetric matrix  $X$  we have:*

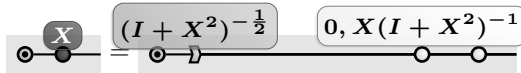

**Proof.** First remark that the composition of those three symplectomorphisms is a symplectic rotation:

$$\begin{bmatrix} I & 0 \\ -X & I \end{bmatrix} \begin{bmatrix} I & X(I + X^2)^{-1} \\ 0 & I \end{bmatrix} \begin{bmatrix} (I + X^2)^{-\frac{1}{2}} & 0 \\ 0 & (I + X^2)^{\frac{1}{2}} \end{bmatrix} = \begin{bmatrix} (I + X^2)^{\frac{1}{2}} & X(I + X^2)^{\frac{1}{2}} \\ -X(I + X^2)^{\frac{1}{2}} & (I + X^2)^{\frac{1}{2}} \end{bmatrix}$$

Thus we have:

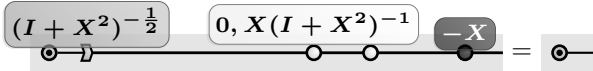

And then:

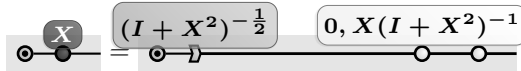

► **Lemma 52.** *Any diagram in  $\text{GSA}_{\mathbb{C}}^+$  can be reduced to the pseudo normal form:*

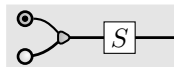

where  $S$  is a real affine symplectomorphism.





**Proof.** In the semantics, the equality:

$$\left[ \left[ \begin{array}{c} \bullet \\ \bullet \end{array} \right] \rightarrow \left[ \begin{array}{c} \bullet \\ \bullet \end{array} \right] \left[ S \right] \right] = \left[ \left[ \begin{array}{c} \bullet \\ \bullet \end{array} \right] \rightarrow \left[ \begin{array}{c} \bullet \\ \bullet \end{array} \right] \right]$$

implies that that affine subspaces on the left contains 0, thus the affine shift on the left must be in the linear space on the right:

$$[x] \in \ker [I | iJ_k]$$

so that

$$x = \begin{bmatrix} 0 \\ 0 \\ 0 \\ x_4 \end{bmatrix}$$

Now that the affine shift has been taken care of we end up with the equality:

$$\ker \left[ \begin{array}{c|c} I & 0 \\ \hline 0 & 0 \end{array} \middle| \begin{array}{c} iJ_r \\ 0 \end{array} \right] S = \ker \left[ \begin{array}{c|c} I & 0 \\ \hline 0 & 0 \end{array} \middle| \begin{array}{c} iI_k \\ 0 \end{array} \right]$$

For a real linear symplectomorphism  $S$ . In other words, such that there exists real matrices  $A, B, C, D, X$  and  $Y$ , with  $X + iY$  invertible and

$$\begin{bmatrix} A & B \\ C & D \end{bmatrix}$$

a symplectomorphism, such that:

$$[I | iJ_r] \begin{bmatrix} A & B \\ C & D \end{bmatrix} = (X + iY) [I | iJ_k]$$

This gives:

$$[A + iJ_r C | B + iJ_r D] = [X + iY | -Y\Phi + iX\Phi]$$

and then by identifying the real and imaginary parts:

$$\begin{cases} A = X \\ J_r C = Y \\ B = -Y I_k \\ J_r D = X I_k \end{cases}$$

we can eliminate  $X$  and  $Y$ :

$$\begin{cases} B = -J_r C I_k \\ J_r D = A I_k \end{cases}$$

To this we can furthermore add the symplectic condition giving:



$$\begin{cases} B = -J_r C J_k \\ J_r D = A J_k \\ B^\top D = D^\top B \\ A^\top C = C^\top A \\ I = A^\top D - C^\top B \end{cases}$$

Notice that the third equation follows from the others:

$$B^\top D = -J_k C^\top J_r D = -J_k C^\top A J_k = -J_k A^\top C J_k = -D^\top J_r C J_k = -D^\top B.$$

We can now eliminate  $B$  and get:

$$\begin{cases} J_r D = A J_k \\ A^\top C = C^\top A \\ I = A^\top D + C^\top J_r C J_k \end{cases}$$

We can now divide our matrices in blocks:

$$A := \begin{bmatrix} A_1 & A_2 \\ A_3 & A_4 \end{bmatrix} \quad C := \begin{bmatrix} C_1 & C_2 \\ C_3 & C_4 \end{bmatrix} \quad D := \begin{bmatrix} D_1 & D_2 \\ D_3 & D_4 \end{bmatrix}$$

The first constraint then gives:

$$\begin{bmatrix} I & 0 \\ 0 & 0 \end{bmatrix} \begin{bmatrix} D_1 & D_2 \\ D_3 & D_4 \end{bmatrix} = \begin{bmatrix} A_1 & A_2 \\ A_3 & A_4 \end{bmatrix} \begin{bmatrix} I & 0 \\ 0 & 0 \end{bmatrix}$$

Implying that  $D_2 = 0$ ,  $A_3 = 0$ , and  $A_1 = D_1$ . The third constraint gives:

$$\begin{bmatrix} I & 0 \\ 0 & I \end{bmatrix} = \begin{bmatrix} A_1^\top & 0 \\ A_2^\top & A_4^\top \end{bmatrix} \begin{bmatrix} A_1 & 0 \\ D_3 & D_4 \end{bmatrix} + \begin{bmatrix} C_1^\top & C_3^\top \\ C_2^\top & C_4^\top \end{bmatrix} \begin{bmatrix} I & 0 \\ 0 & 0 \end{bmatrix} \begin{bmatrix} C_1 & C_2 \\ C_3 & C_4 \end{bmatrix} \begin{bmatrix} I & 0 \\ 0 & 0 \end{bmatrix}$$

$$\begin{bmatrix} I & 0 \\ 0 & I \end{bmatrix} = \begin{bmatrix} A_1^\top A_1 & 0 \\ A_2^\top A_1 + A_4^\top D_3 & A_4^\top D_4 \end{bmatrix} + \begin{bmatrix} C_1^\top C_1 & 0 \\ C_2^\top C_1 & 0 \end{bmatrix}$$

This implies that  $A_4^\top D_4 = I$ , so the  $(n-r) \times (n-k)$  matrix  $D_4$  is injective. Therefore,  $(n-k) \leq (n-r)$ , and thus  $r \leq k$ . Since the role of  $k$  and  $r$  is symmetric up to replacing  $S$  by its inverse, we finally get that  $r = k$ , and that  $A_4^\top$  is invertible. We can now eliminate  $D_4 = A_4^{-\top}$  and reformulate the third constraint as:

$$\begin{cases} I = A_1^\top A_1 + C_1^\top C_1 \\ D_3 = -A_4^{-\top} A_2^\top A_1 - A_4^{-\top} C_2^\top C_1 \end{cases}$$

Allowing to eliminate  $D_3$ . The second constraint gives us:



$$\begin{bmatrix} A_1^\top & 0 \\ A_2^\top & A_4^\top \end{bmatrix} \begin{bmatrix} C_1 & C_2 \\ C_3 & C_4 \end{bmatrix} = \begin{bmatrix} C_1^\top & C_3^\top \\ C_2^\top & C_4^\top \end{bmatrix} \begin{bmatrix} A_1 & A_2 \\ 0 & A_4 \end{bmatrix}$$

In other words:

$$\begin{cases} A_1^\top C_1 = C_1^\top A_1 \\ A_2^\top C_1 + A_4^\top C_3 = C_2^\top A_1 \\ A_2^\top C_2 + A_4^\top C_4 = C_2^\top A_2 + C_4^\top A_4 \end{cases}$$

We can thus eliminate  $C_3 = A_4^{-\top} C_2^\top A_1 - A_4^{-\top} A_2^\top C_1$ .

If we gather the constraints we have so far, we have only  $A_1, A_2, A_4, C_1, C_2$  and  $C_4$  as degree of freedom satisfying:

$$\begin{cases} I = A_1^\top A_1 + C_1^\top C_1 \\ A_1^\top C_1 = C_1^\top A_1 \\ A_2^\top C_2 + A_4^\top C_4 = C_2^\top A_2 + C_4^\top A_4 \end{cases}$$

We get the following symplectomorphism:

$$\begin{bmatrix} A_1 & A_2 & -C_1 & 0 \\ 0 & A_4 & 0 & 0 \\ C_1 & C_2 & A_1 & 0 \\ A_4^{-\top} C_2^\top A_1 - A_4^{-\top} A_2^\top C_1 & C_4 & -A_4^{-\top} A_2^\top A_1 - A_4^{-\top} C_2^\top C_1 & A_4^{-\top} \end{bmatrix}$$

We can now decompose it. First  $A_4 \in \text{Gl}_{n-r}(\mathbb{R})$  only acts on the lower part:

$$\begin{bmatrix} I & 0 & 0 & 0 \\ 0 & A_4 & 0 & 0 \\ 0 & 0 & I & 0 \\ 0 & 0 & 0 & A_4^{-\top} \end{bmatrix} \begin{bmatrix} A_1 & A_2 & -C_1 & 0 \\ 0 & I & 0 & 0 \\ C_1 & C_2 & A_1 & 0 \\ C_2^\top A_1 - A_2^\top C_1 & A_4^\top C_4 & -A_2^\top A_1 - C_2^\top C_1 & I \end{bmatrix}$$

Then, we can see the symplectic rotation

$$\begin{bmatrix} A_1 & -C_1 \\ C_1 & A_1 \end{bmatrix}$$

acting on the upper part:

$$\begin{bmatrix} I & 0 & 0 & 0 \\ 0 & A_4 & 0 & 0 \\ 0 & 0 & I & 0 \\ 0 & 0 & 0 & A_4^{-\top} \end{bmatrix} \begin{bmatrix} I & A_2 & 0 & 0 \\ 0 & I & 0 & 0 \\ 0 & C_2 & I & 0 \\ C_2^\top & A_4^\top C_4 & -A_2^\top & I \end{bmatrix} \begin{bmatrix} A_1 & 0 & -C_1 & 0 \\ 0 & I & 0 & 0 \\ C_1 & 0 & A_1 & 0 \\ 0 & 0 & 0 & I \end{bmatrix}$$

Finally, denoting  $\beta := A_4^\top C_4 + A_2^\top C_2$ , we know that  $\beta$  is symmetric, thus we end up with a symplectomorphism of the form:

$$\begin{bmatrix} I & 0 & 0 & 0 \\ 0 & A_4 & 0 & 0 \\ 0 & 0 & I & 0 \\ 0 & 0 & 0 & A_4^{-\top} \end{bmatrix} \begin{bmatrix} I & A_2 & 0 & 0 \\ 0 & I & 0 & 0 \\ 0 & 0 & I & 0 \\ 0 & 0 & -A_2^\top & I \end{bmatrix} \begin{bmatrix} I & 0 & 0 & 0 \\ 0 & I & 0 & 0 \\ 0 & C_2 & I & 0 \\ C_2^\top & \beta & 0 & I \end{bmatrix} \begin{bmatrix} A_1 & 0 & -C_1 & 0 \\ 0 & I & 0 & 0 \\ C_1 & 0 & A_1 & 0 \\ 0 & 0 & 0 & I \end{bmatrix}$$

Then in  $\text{GSA}_{\mathbb{R}}$ :

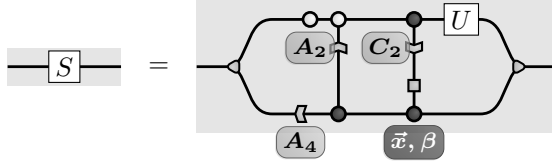

Where  $U$  is a symplectic rotation. ◀

**Proof of theorem 38.** We define an interpretation prop morphism  $\llbracket \_ \rrbracket : \text{GSA}_{\mathbb{R}}^+ \rightarrow \text{AffLagRel}_{\mathbb{C}}^+$  by sending all generator from  $\text{GSA}_{\mathbb{R}}$  to the corresponding Lagrangian subspaces and vacuum generators to the subspace corresponding to a white node with phase  $(0, i)$ .

By lemma 52 we know that any diagram in  $\text{GSA}_{\mathbb{R}}^+$  can be put in pseudo normal form, but by proposition 21, we see that replacing the vacuum generator by a white node with phase  $(0, i)$ , we can represent all positive subspaces. In other words the interpretation of  $\text{GSA}_{\mathbb{R}}^+$  into positive subspaces is surjective. It only remains to prove that this interpretation is also injective.

Let  $X$  and  $Y$  be two diagrams in  $\text{GSA}_{\mathbb{R}}^+$  such that  $\llbracket X \rrbracket = \llbracket Y \rrbracket$ . Using lemma 52 we can assume that both diagrams are in pseudo normal form. We have:

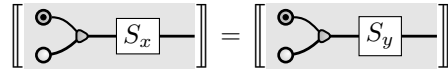

And then, by lemma 53 it follows that  $S = S_x(S_y)^{-1}$  is of the form:

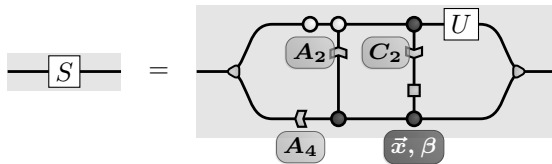

with  $\beta$  symmetric,  $U$  symplectic rotation and  $A_4$  invertible. Therefore:

