

WHITEPAPER
March 2024



GOVERNING THROUGH THE CLOUD: THE INTERMEDIARY ROLE OF COMPUTE PROVIDERS IN AI REGULATION

Lennart Heim, Tim Fist, Janet Egan, Sihao Huang, Stephen Zekany, Robert Trager, Michael A. Osborne & Noa Zilberman

arXiv:2403.08501v2 [cs.CY] 26 Mar 2024



In partnership with



Governing Through the Cloud: The Intermediary Role of Compute Providers in AI Regulation

Lennart Heim,^{* † 1} Tim Fist,^{* 2} Janet Egan,^{* 3} Sihao Huang,^{* 4}
Stephen Zekany,^{* ‡ 1} Robert Trager,^{* 1,6,7} Michael A Osborne,^{5,7} Noa Zilberman⁵

¹Centre for the Governance of AI (GovAI), ²Center for a New American Security, Institute for Progress,
³Harvard Kennedy School, ⁴Department of Politics and International Relations, University of Oxford,
⁵Department of Engineering Sciences, University of Oxford, ⁶Blavatnik School of Government, University of
Oxford, ⁷Oxford Martin AI Governance Initiative

Abstract

As jurisdictions around the world take their first steps toward regulating the most powerful AI systems, such as the EU AI Act and the US Executive Order 14110, there is a growing need for effective enforcement mechanisms that can verify compliance and respond to violations. We argue that compute providers should have legal obligations and ethical responsibilities associated with AI development and deployment, both to provide secure infrastructure and to serve as intermediaries for AI regulation. Compute providers can play an essential role in a regulatory ecosystem via four key capacities: as *securers*, safeguarding AI systems and critical infrastructure; as *record keepers*, enhancing visibility for policymakers; as *verifiers* of customer activities, ensuring oversight; and as *enforcers*, taking actions against rule violations. We analyze the technical feasibility of performing these functions in a targeted and privacy-conscious manner and present a range of technical instruments. In particular, we describe how non-confidential information, to which compute providers largely already have access, can provide two key governance-relevant properties of a computational workload: its type—e.g., large-scale training or inference—and the amount of compute it has consumed. Using AI Executive Order 14110 as a case study, we outline how the US is beginning to implement record keeping requirements for compute providers. We also explore how verification and enforcement roles could be added to establish a comprehensive AI compute oversight scheme. We argue that internationalization will be key to effective implementation, and highlight the critical challenge of balancing confidentiality and privacy with risk mitigation as the role of compute providers in AI regulation expands.

Each author contributed ideas and/or writing to the paper. However, being an author does not imply agreement with every claim made in the paper.

^{*}Denotes primary authors who contributed most significantly to the direction and content of the paper. Both primary authors and other authors are listed in approximately descending order of contribution.

[†]Correspondence to lennart.heim@governance.ai.

[‡]Work completed whilst a Summer Research Fellow at the Centre for the Governance of AI, Oxford.

Executive Summary

Introduction — Jurisdictions around the world are taking their first steps toward regulating AI, such as the EU AI Act and the US Executive Order 14110. While these regulatory efforts mark significant progress, they lack robust mechanisms to verify compliance and respond to violations. We propose compute service providers (*compute providers* below) as an important node for AI safety, both in providing secure infrastructure and acting in an intermediary role for AI regulation, leveraging their unique relationships with AI developers and deployers. Our proposal is not intended to replace existing regulations on AI developers but rather to complement them. (Section 1)

Compute Providers’ Intermediary Role — Increasingly large amounts of computing power are necessary for both the development and deployment of the most sophisticated AI systems. Consequently, advanced AI models today are trained, and deployed in data centers, housing tens of thousands of “AI accelerators” (specialized computers for AI applications). Because of the large upfront cost of building this infrastructure and economies of scale, AI developers often access large-scale compute through models like Infrastructure as a Service (IaaS), also often described as *cloud computing*. (Section 1.1)

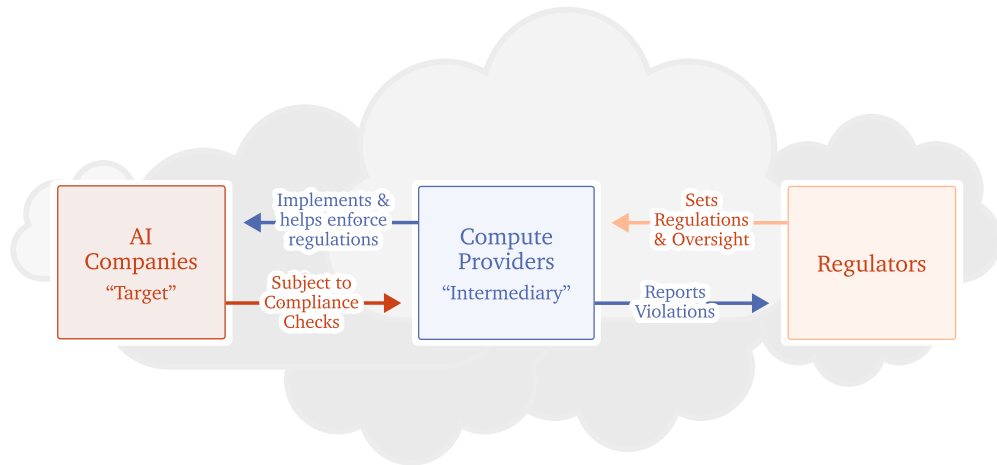

Figure 1: The intermediary role of compute providers in relation to AI companies and regulators.

Some leading AI firms currently manage their own data centers or maintain exclusive partnerships with leading entities in this domain, known as *hyperscalers*. Notably, the most advanced AI research is currently being conducted at or with these hyperscalers (e.g., Microsoft Azure, Amazon Web Services (AWS), Apple, Bytedance, Meta, Oracle, Tencent, and Google Cloud). While this situation presents complex challenges for regulatory oversight, our discussion also encompasses scenarios in which compute providers are internal to or closely linked with an AI firm.

We focus on frontier AI systems, which have the potential to give rise to dangerous capabilities and pose serious risks. As these systems necessitate extensive amounts of compute to train and deploy at large scales, targeting compute providers becomes a promising method to oversee the development and deployment of such systems. Furthermore, this target narrows the regulatory scope to the smaller set of key customers who are building AI systems at the frontier, thereby minimizing the burdens associated with regulatory compliance and enforcement. (Section 1.2)

Governance Capacities — We propose that compute providers can leverage their crucial role in the AI supply chain to secure infrastructure and serve as the intermediate node in support of regulatory objectives while maintaining customers’ privacy and rights. They can facilitate effective AI regulation via four key capacities: as *securers*, *record keepers*, *verifiers*, and, in some cases, even *enforcers*. Reporting represents a related yet distinct dimension, wherein compute providers provide information to authorities as mandated by law or regulations. (Section 2)

Governance Capacities			
Security	Record Keeping	Verification	Enforcement
<i>Helping provide physical and cybersecurity measures to secure the AI model, related intellectual property, and personal and confidential data.</i>	<i>The selective collection, organization, and maintenance of high-level information of a compute provider's infrastructure usage, such as a customer's compute usage data.¹</i>	<i>Actively verifying customer identities, specific activities, and high-level AI systems' properties.</i>	<i>Restriction or limitation of compute access to customers or workloads for non-compliant customers.</i>
Enables			
<i>Enables shared security standards to protect the public good, such as safeguarding critical infrastructure and helping prevent model theft.</i>	<i>Increases visibility into AI development, links customers and their usage to real-world actors, and enables post-incident attributions and forensics.</i>	<i>Ensures that the deployment and development of AI systems adhere to regulations or company policies and reported properties.</i>	<i>Directly impacts the capability of customers to develop or deploy advanced AI systems, ensuring adherence to rules.</i>
Examples			
<i>Help prevent IP (e.g., algorithms), model weights, and training data from being stolen by malicious actors.</i>	<i>Obtain insights into national compute use trends for policy formulation, such as compute distribution (e.g., US NAIRR).</i>	<i>Confirm compliance with mandatory reporting over training compute thresholds.</i>	<i>Restrict access to customers lacking licenses as an AI developer for their system.</i>
<i>Help prevent attacks on large-scale deployments of foundational models that could shut down dozens of critical services nationwide.</i>	<i>Enable monitoring for suspected violations of the reporting requirements under Executive Order 14110.</i>	<i>Verify compliance with data usage guidelines for frontier AI training.</i>	<i>Refuse to deploy an unlicensed or non-compliant AI model.</i>
	<i>Collect information on the environmental impact of AI compute use.</i>	<i>Verify if the deployed frontier AI system has an adequate license or certification.</i>	<i>Disable AI systems that demonstrate activity that is undesirable, uncontrollable, or in violation of regulations (e.g., computer worm-like AI system).</i>

Table 1: Summary of the key governance capacities that compute providers can enable.

Technical Feasibility — Our analysis indicates these governance capabilities are likely to be technically feasible and possible to implement in a confidentiality- and privacy-preserving way using techniques available to compute providers today. Compute providers often collect a wide range of data on their customers and workloads, for the purposes of billing, marketing, service analysis, optimization, and fulfilling legal obligations. Much of this data could also be used to support identity verification, as well as verifying technical properties of workloads. At a minimum, providers have access to billing information and can access basic technical data on how their hardware is used. This likely makes it possible for compute providers to develop techniques to detect and classify certain relevant workloads (e.g., whether a workload involves training a frontier model) and to quantify the amount of compute consumed by a workload. Verification of more detailed properties of a workload, such as the type of training data used, or whether a particular model evaluation was run, could be useful for governance purposes but is not currently possible without direct access to customer code and data. With further research and development efforts, compute providers may be able to offer “confidential computing” services to allow customers to prove these more detailed properties without otherwise revealing sensitive data. (Section 3)

¹Focusing on essential data that informs without compromising privacy and confidentiality.

Constructing an Oversight Scheme — Via Executive Order 14110 the US government is already beginning to implement record keeping roles for compute providers by requiring them to implement a Customer Identification Program (essentially a Know-Your-Customer (KYC) program) for foreign customers, and to report foreign customer training of highly capable models to government. Expanding the role of compute providers to also record and validate domestic customers using compute at frontier AI thresholds could enable the US government to identify and address AI safety risks arising domestically. Complementing these measures with verification and enforcement roles for compute providers could further enable the construction of a comprehensive compute oversight scheme, and ensure that AI firms and developers are complying with AI regulations. (Section 4)

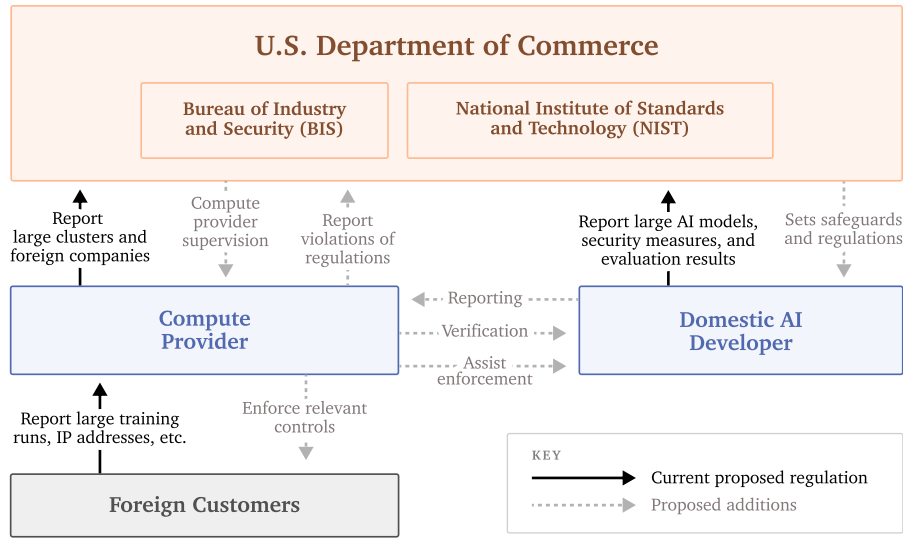

Figure 2: Additional measures, implemented by the Department of Commerce, would strengthen the intermediary role of compute providers and enable a compute oversight scheme.

Technical and Governance Challenges — To realize a robust governance model, several technical and governance challenges remain. These include identifying additional measurable properties of AI development that correspond to potential threats, making workload classification methods robust to potential evasion, and formulating privacy-preserving verification protocols. (Section 5.1)

The success of our proposed oversight scheme hinges on its multilateral adoption to prevent the migration of AI activities to jurisdictions with less stringent oversight. For an international framework to be durable and effective, it must address concerns from non-US governments. Cooperation will need to account for complex privacy and oversight issues associated with globally spread data centers. Compute provider oversight may affect competition in the AI ecosystem and raise concerns about issues of national competitiveness, and, consequently, this may influence the ability of US providers to offer products globally, including to foreign public-sector customers. Industry-led privacy-preserving standards could help ensure trust, but further research is needed to incentivize broad international buy-in to a global framework. (Section 1.4 and Section 5.2)

Conclusion — Compute providers are well-placed to support existing and future AI governance frameworks in a privacy-preserving manner. Many of the interventions we propose are feasible with the current capabilities of compute providers. However, realizing the full potential necessitates addressing technical and governance challenges, requiring concerted efforts in research and international cooperation. As governments and regulatory bodies move to address AI risks, compute providers stand as the intermediate node in ensuring the effective implementation of regulation. (Section 6)

Contents

Executive Summary	3
1 Introduction	7
1.1 Compute Providers' Intermediary Role	7
1.1.1 Regulatory Intermediaries	8
1.2 Focus on Frontier AI	9
1.3 Overview of our Contributions	9
1.4 Limitations and Future Research Directions	10
2 Governance Capacities of Compute Providers	10
2.1 Compute Providers in the AI Compute Supply Chain	11
2.2 Governance Capacities	12
2.2.1 I. Security	12
2.2.2 II. Record Keeping	14
2.2.3 III. Verification	16
2.2.4 IV. Enforcement	17
3 Technical Feasibility of Compute Providers' Governance Role	18
3.1 Security	20
3.2 Record Keeping	20
3.3 Verifying	21
3.3.1 Identity Verification	21
3.3.2 Workload Classification	23
3.3.3 Compute Accounting	26
3.3.4 Detailed Workload Verification	29
4 Constructing an Oversight Scheme	30
4.1 Case Study: Compute Providers' Intermediary Role in the US	31
4.1.1 Record Keeping and Reporting in the AI Executive Order	31
4.1.2 Potential for Verification Capacity	32
4.1.3 Future Additions	32
4.2 Regulating the Compute Providers Themselves	34
4.3 Domestic Government Capacity	34
4.4 International Coordination	35
5 Key Challenges	37
5.1 Technical Challenges	37
5.2 Governance Challenges	39
6 Conclusion	40
A Overview of Compute Provider Technologies	41
B Observable Data Attributes	42
References	46

1 Introduction

As governments, international organizations, and regional bodies formulate approaches for governing advanced AI, we ask: how can authorities gain visibility into development and deployment practices and enforce rules? The visibility is currently obscured because frontier AI development largely takes place within the private sector and often relies on self-reporting by AI companies, which may not always be reliable due to growing incentives to obfuscate the results (Anderljung et al., 2023b; Mulani & Whittlestone, 2023; Whittlestone & Clark, 2021). Ongoing governance processes worldwide require answers to this question.

Jurisdictions including China, the European Union (EU), the United Kingdom (UK), and the United States (US) are attempting to impose new reporting requirements on AI firms and compute providers (Future of Life Institute, 2024; Jiang & Cao, 2023; Secretary of State for Science, Innovation and Technology, 2023; Senator Scott Wiener, 2024; Sheehan, 2024; The White House, 2023b). They are also beginning to regulate the development and deployment of models with potentially harmful capabilities. Yet, enforcing these rules proves challenging; without appropriate mechanisms, it is difficult to detect violations (Hacker, 2023; Whittlestone et al., 2023). Governance approaches, such as the recent US Executive Order (The White House, 2023b) and the EU’s proposed AI Act (Council of the European Union, 2024), have not developed practical means such as robust spot-checking (randomized inspections to ensure compliance) and evidence-gathering mechanisms for achieving these goals.

This paper demonstrates how compute providers—firms who make computing resources (“compute” below)² available for AI development and deployment—can effectively serve as an intermediary for frontier AI governance between governments and the firms developing and deploying AI. In this role, compute providers can act as a first line of detection of violations of a governance regime and even defend against violations.

1.1 Compute Providers’ Intermediary Role

Large amounts of computing power are necessary for both the development and deployment of frontier AI systems. Consequently, advanced AI models are trained, and deployed, in *data centers*³, housing tens of thousands of AI accelerators. Because of the large upfront cost of building this infrastructure, AI developers often access large-scale compute through models like IaaS⁴, also often described as *cloud computing*.⁵ Throughout this paper, we refer to entities that provide access to this computational power as *compute providers*.

Some AI firms currently manage their own data centers or maintain exclusive partnerships with leading compute providers, known as *hyperscalers*.⁶ Notably, the most advanced AI research is currently being conducted at or with these hyperscalers.⁷ While this situation introduces complex challenges for regulatory oversight, our discussion also encompasses scenarios in which compute

²For a discussion of compute as a governance node, see Sastry et al. (2024).

³Our focus is on the entities that own and operate data centers, prioritizing the “legal entity” level of abstraction over the physical locations or “data centers” themselves.

⁴This discussion extends to services that offer hardware access with sufficient flexibility for customer-defined usage, which may occasionally encompass certain Platform-as-a-Service (PaaS) offerings. However, our emphasis is on scenarios in which usage surpasses certain AI compute thresholds that are of relevance for frontier AI. In contrast, services providing access to pre-configured AI models (Software-as-a-Service, or SaaS) fall outside our defined scope of compute providers. (The suggested governance capacities could still help if the regulation of these services is desired.)

⁵The term “cloud” is more associated with a specific business model rather than the underlying activity of providing compute resources. For this context, we prefer the term “compute providers” to accurately reflect the focus on the provision of computing power. This choice also allows us to include entities that predominantly provide their computational resources internally (e.g., Meta (Janardhan, 2023)) within the scope of our discussion.

⁶The most notable hyperscalers include Microsoft Azure, Amazon Web Services (AWS), Apple, Bytedance, Meta, Oracle, Alibaba, Tencent, and Google Cloud (Vailshery, 2024).

⁷Many prominent AI companies either operate as hyperscalers themselves or maintain strategic partnerships with them. For example, OpenAI’s collaboration with Microsoft (Microsoft Corporate Blogs, 2023), and Anthropic’s associations with AWS and Google Cloud (Amazon.com, Inc., 2023b; Anthropic, 2023), exemplify such relationships.

providers are internal to, or closely linked with an AI firm.⁸ For example, an AI company should not be able to circumvent the proposed guidelines by categorizing its usage as internal provisions or failing to identify itself as a customer. This would ensure comprehensive coverage of all relevant forms of compute provision for frontier AI.

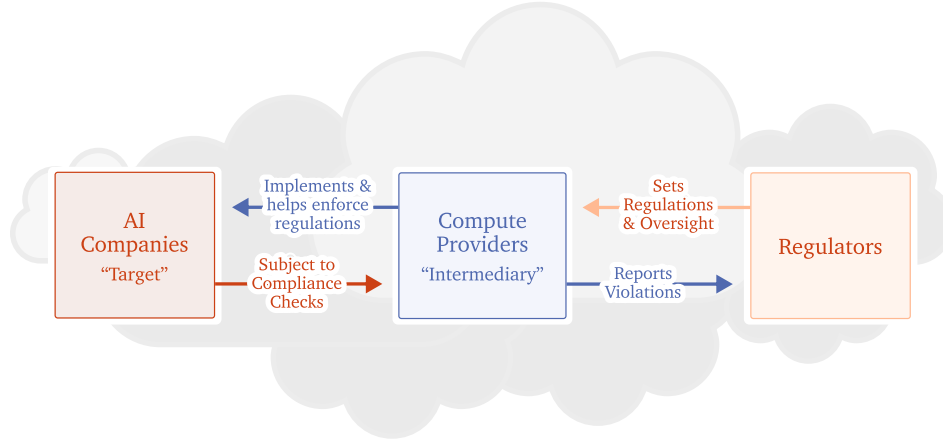

Figure 1: The intermediary role of compute providers in relation to AI companies and regulators.

1.1.1 Regulatory Intermediaries

The use of private sector entities as regulatory intermediaries is not a new concept (Abbott et al., 2017a;b; Hay & Shleifer, 1998). Regulations for the aviation industry require airline operators to maintain security plans, keep records on passengers, verify passenger identities, and deny boarding in response to specified violations (ECFR, 2024; Aviation Transport Security Act, 2005). In the context of communication service providers, some governments have enacted data retention policies that require the collection and retention of information on customers’ activities for a specified amount of time (Australian Attorney-General’s Department, 2015; Country Legal Frameworks Resource, 2023). Internationally coordinated anti-money laundering and counter-terrorism financing standards require financial institutions to keep records, verify identities, and act to prevent illicit flows of money (Financial Action Task Force, 2023).

Compute providers are already subject to regulations that dictate operational standards and data management practices. For example, laws targeting Child Sexual Abuse Material (CSAM) impose obligations on compute providers to detect and report such content (Amazon.com, Inc., 2023a; Biden, 2008; European Union, 2011). Data protection regulations, such as the General Data Protection Regulation (GDPR) in the EU, set stringent requirements for data handling, privacy, and user consent, which significantly affect how compute providers manage and secure user data (AWS, 2024a; European Union, 2016; Google Cloud, 2021). Additionally, legislation aimed at combating terrorism and extremism may require compute providers to monitor and restrict the dissemination of harmful content (European Union, 2021).

⁸These relationships and the concentrated market for large-scale compute have given rise to antitrust and competition concerns, drawing scrutiny from regulators, including an ongoing inquiry by the US Federal Trade Commission (Federal Trade Commission, 2024) and an investigation by the UK Competition and Markets Authority (Milmo, 2023). While we acknowledge the need to carefully analyze how enhanced regulatory measures may impact competition issues in the sector, we expect the impact to be limited and not broadly significant. This is due to the focused scope of the measures, targeting only those compute providers capable of supporting large-scale AI infrastructure and customers who are running large-scale workloads costing tens to hundreds of millions of dollars or more. A detailed discussion of these antitrust concerns requires broader analysis and is beyond the scope of this paper.

1.2 Focus on Frontier AI

The customer base of AI compute providers is diverse, ranging from individuals and small enterprises to large corporations and government agencies. However, the primary focus of this paper is on a subset of AI systems known as frontier AI. Frontier AI systems are defined as “*highly capable general-purpose AI models that can perform a wide variety of tasks and match or exceed the capabilities present in today’s most advanced models*” (UK DSIT, 2023).⁹ These systems represent the frontier of current AI capabilities and currently require substantial compute resources for their development and operation (Anderljung et al., 2023a; Sastry et al., 2024; Sevilla et al., 2022).

Given the significant compute and research demands, only a small number of entities possess the necessary resources to develop frontier AI systems. This paper addresses primarily large corporations for regulatory consideration. The intent of the proposed regulatory frameworks is not to encompass the entirety of compute providers’ customer base indiscriminately. Rather, the focus is limited to those actors who are in a position to develop or deploy frontier AI systems—based on their compute usage—warranting closer scrutiny and potential regulation. This targeted approach ensures that regulatory measures are both effective and proportional, avoiding unnecessary encumbrances on smaller entities or individual users who do not fall within the relevant frontier AI activities.¹⁰ Sastry et al. (2024) discuss the importance of compute for frontier models in more detail and examine the conditions under which compute, and by extension, compute providers, serve as effective policy levers, as well as scenarios and conditions where their impact is limited.

1.3 Overview of our Contributions

We suggest that compute providers can play a key role in governance regimes similar to the examples listed above via four key capacities: as *securers*, *record keepers*, *verifiers*, and *enforcers*. Security can restrict access to AI-related IP, such as the model weights, from bad actors. Record keeping allows selected information gathering for insights into AI activities and allows for post-incident attribution. Verification includes checking customer activities and AI systems to verify compliance with regulations and standards. Enforcement entails the restriction or limitation of compute access for non-compliant customers.

We analyze the technical means of performing each of these functions. Concerning *security*, we outline the role many compute providers already serve in establishing baseline levels of physical, infrastructure, and network security, and briefly discuss how this role should be expanded to address more sophisticated threats. Regarding *record keeping*, we describe the information that is likely already available to compute providers and the potential insights it can offer. Regarding *enforcement*, we review the capabilities of data center providers to facilitate the enforcement of standards, either of an external governance regime or of their own terms of service.

We focus much of our technical analysis on the role compute providers could play in *verification* in a targeted and privacy-conscious manner. We describe information that is already available to compute providers that can be used for four sub-categories of verification: workload classification, compute accounting, verification of properties of code and data (“detailed workload verification”), and identity verification, such as Know-Your-Customer (KYC) regimes (Egan & Heim, 2023; Smith, 2023). Several of these techniques could be used in real-time to establish whether a customer is engaging in an activity that might be subject to regulatory oversight. If compute providers were to implement these techniques, they could likely distinguish whether their customers are engaging in activities such as training a large model, or engaging in inference at scale, as well as quantify the amount of compute consumed by large workloads

After describing the technical possibilities, we focus on the US, explaining how some of the techniques we describe can facilitate compliance with the mandates of the Biden Administration’s 2023 Executive Order 14110 on Safe, Secure, and Trustworthy AI (hereafter “the AI Executive Order”) and support its overall objectives (The White House, 2023b). We identify a set of next steps for compute providers to verify that model developers have met their Section 4 requirements under the AI Executive Order.

⁹Also see Section 2.1 of Anderljung et al. (2023a).

¹⁰In Section 5.2, we elaborate on privacy and confidentiality considerations, emphasizing that our proposed regulatory measures are specifically aimed at key actors in frontier AI development, rather than being broadly applied to the entire customer base of compute providers, such as individuals. Heim & Egan (2023) and Egan & Heim (2023) also discuss the idea of “above-threshold compute usage.”

We further argue that the broad goals of the AI Executive Order could benefit from the full range of techniques described here, particularly when internationalized. In the final section, we highlight the technical and governance challenges and opportunities for technical governance and policy research.

1.4 Limitations and Future Research Directions

In this paper, we propose a conceptual model wherein compute providers improve the efficiency and effectiveness of the developing regulatory AI ecosystem. Our discussion is not a comprehensive policy blueprint ready for implementation. While certain aspects of our proposal may be directly actionable, other aspects require more evaluation. Our primary objective is to argue for particular roles for compute providers and to stimulate a debate: Should compute providers embrace the roles we have outlined? Which of the proposed activities are most viable, and which require further research?

While we emphasize the need to internationalize our proposed concept, we acknowledge that this aspect is not explored in detail, especially the legal aspects. The complexity of such an analysis extends beyond the scope of this paper, calling for detailed legal and policy analysis. Our aim is to motivate more research in this domain, recognizing the need for a more comprehensive investigation into the intricacies involved in applying these regulatory concepts across different jurisdictions. This is particularly relevant given the intricate challenges that have emerged in the past, such as those surrounding the EU-US Privacy Shield, and others (Buttarelli, 2018).

Some of the suggested regulatory measures may have implications on privacy and confidentiality for customers of compute providers and we recognize that increasing legal reporting requirements must be carefully weighed against the potential for misuse or government overreach. However, our focus—frontier AI—largely pertains to compute-intensive workloads undertaken by a limited number of corporate entities. This simplifies the regulatory landscape with respect to information describing these workloads and the companies running them, as stringent privacy regulations like the GDPR safeguard the personal data of individuals (“natural persons”), while typically imposing fewer constraints on data related to companies (“juridical person”).

The urgency of this discourse is magnified by the KYC requirements outlined in the US’s AI Executive Order, with implementation currently being progressed through the Department of Commerce’s proposed rule (Federal Register, 2024).¹¹ Reaching a comprehensive and thoughtful regulatory framework requires going beyond unilateral measures, which could lead to unintended adverse consequences. International coordination is crucial to address the questions arising from the intersection of AI regulation with international trade law, confidentiality, and privacy. This paper contributes to the dialogue and advocates for an AI regulatory framework that is collaborative, nuanced, effective, and globally inclusive and responsive.

2 Governance Capacities of Compute Providers

In the current ecosystem, frontier AI models are trained and deployed using large compute clusters consisting of thousands to tens of thousands of AI accelerators (Pilz & Heim, 2023; Sevilla et al., 2022). The concentrated supply chain, in addition to the detectability, excludability, and quantifiability of physical computing hardware, makes compute a particularly effective node of governance compared to other inputs to AI development (Belfield & Hua, 2022; Pilz & Heim, 2023).

Therefore, the physical infrastructure required for AI development and deployment can be used as an instrument to enhance existing AI regulations—making them more efficient and effective while enabling new policies. Compute providers can perform these functions via four key capacities: as *securers*, to protect IP; *record keepers*, enabling data collection for analysis and future reference; as *verifiers* of customer activities, enabling appropriate oversight; and as *enforcers*, taking actions against norm and rule violations. We discuss these capacities in this section in more detail.

This approach offers a nuanced alternative to broad measures such as chip export controls (Allen, 2022), positioning compute providers as a more precise and adaptable governance mechanism within

¹¹Especially, as some of the currently proposed measures may be overly broad, potentially violating confidentiality principles.

the AI supply chain. Unlike controls on physical computing hardware, the dynamic model of compute provision affords a higher degree of flexibility and specificity (Table 1 in Heim & Egan (2023)).

2.1 Compute Providers in the AI Compute Supply Chain

In the AI supply chain, compute providers act as an intermediary, offering computational resources to customers. These providers house large numbers of chips in their data center facilities, operating them cost-effectively in large quantities with necessary elements such as power, land, cooling, and connectivity, and optimizing them for developing and deploying AI models (Figure 3). With current technologies, training large AI systems requires physically co-located chips. This has caused much of contemporary AI deployment and development to occur in large facilities, wherein compute is made available to customers digitally and remotely, often through models like Infrastructure as a Service (IaaS) or cloud computing. The compute provider industry has seen significant consolidation in recent years due to the economic advantage of scale (Richter, 2024).

The Compute Supply Chain

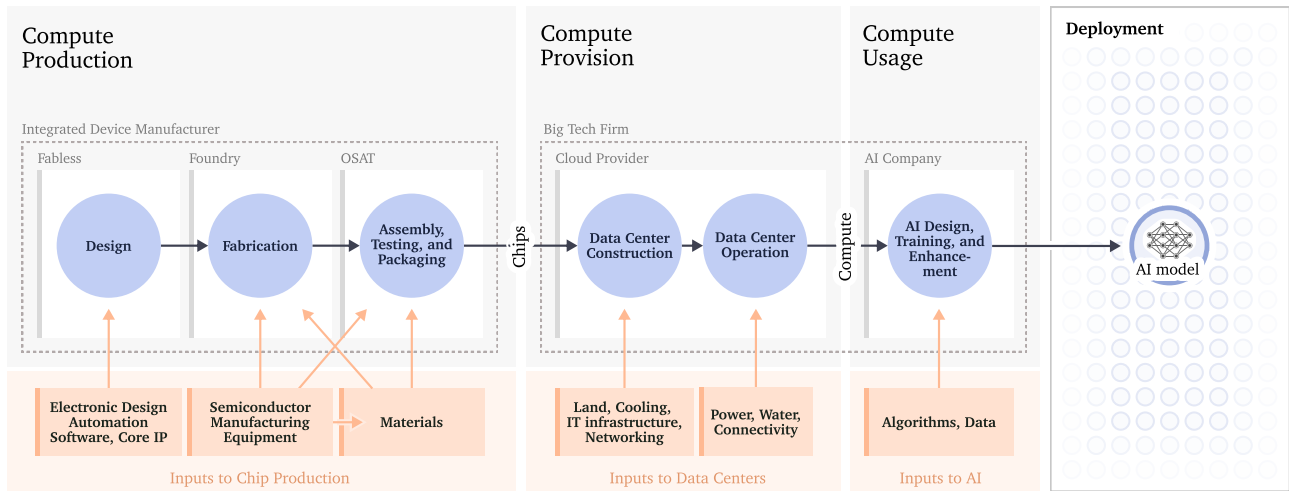

"Computing Power and the Governance of Artificial Intelligence"
 Sastry, Heim, Belfield, Anderjung, Brundage, Hazell, O'Keefe, Hadfield et al., 2024

Figure 3: The compute supply chain including compute providers in the middle. Like the production of state-of-the-art AI chips, compute providers' market shares are concentrated. (Figure from Sastry et al. (2024).)

By capitalizing on their position as infrastructure providers, compute providers can play a key role in regulating AI companies. Leveraging compute in this manner can help reduce regulatory burdens because each compute provider (i) typically services multiple AI firms,¹² thereby streamlining the regulatory process, and (ii) screens potential targets for regulation by the scale of compute usage (which can be supplemented by further criteria), whether it is used for training or deployment. This follows the model of how financial institutions operate under KYC schemes (Financial Crimes Enforcement Network, 2005; 2024; Egan & Heim, 2023), although compute providers with the capacity for frontier AI development and deployment are much fewer in number than banks.

¹²The size of the customer base of compute providers varies significantly. Typically, compute providers offer their services to a wide range of entities, with most usage falling outside the scope of our primary concern in this paper (see Section 1). Nonetheless, our analysis also includes large compute owners who exclusively use their resources internally. For example, a major technology company cannot circumvent the guidelines proposed in this discussion by merely categorizing its usage as "internal provisions" or not identifying itself as a "customer." This approach ensures comprehensive coverage of all relevant forms of compute provision for frontier AI.

2.2 Governance Capacities

Compute providers can facilitate effective AI regulation via four key capacities. They can be *securers*, *record keepers*, *verifiers*, and, in some cases, even *enforcers* (Section 2.2 and Figure 4).

Governance Capacities			
Security	Record Keeping	Verification	Enforcement
<i>Helping provide physical and cybersecurity measures to secure the AI model, related intellectual property, and personal and confidential data.</i>	<i>The selective collection, organization, and maintenance of high-level information of a compute provider's infrastructure usage, such as a customer's compute usage data.¹³</i>	<i>Actively verifying customer identities, specific activities, and high-level AI systems' properties.</i>	<i>Restriction or limitation of compute access to customers or workloads for non-compliant customers.</i>
Enables			
<i>Enables shared security standards to protect the public good, such as safeguarding critical infrastructure and helping prevent model theft.</i>	<i>Increases visibility into AI development, links customers and their usage to real-world actors, and enables post-incident attributions and forensics.</i>	<i>Ensures that the deployment and development of AI systems adhere to regulations or company policies and reported properties.</i>	<i>Directly impacts the capability of customers to develop or deploy advanced AI systems, ensuring adherence to rules.</i>
Examples			
<i>Help prevent IP (e.g., algorithms), model weights, and training data from being stolen by malicious actors.</i>	<i>Obtain insights into national compute use trends for policy formulation, such as compute distribution (e.g., US NAIRR).</i>	<i>Confirm compliance with mandatory reporting over training compute thresholds.</i>	<i>Restrict access to customers lacking licenses as an AI developer for their system.</i>
<i>Help prevent attacks on large-scale deployments of foundational models that could shut down dozens of critical services nationwide.</i>	<i>Enable monitoring for suspected violations of the reporting requirements under Executive Order 14110.</i>	<i>Verify compliance with data usage guidelines for frontier AI training.</i>	<i>Refuse to deploy an unlicensed or non-compliant AI model.</i>
	<i>Collect information on the environmental impact of AI compute use.</i>	<i>Verify if the deployed frontier AI system has an adequate license or certification.</i>	<i>Disable AI systems that demonstrate activity that is undesirable, uncontrollable, or in violation of regulations (e.g., computer worm-like AI system).</i>

Table 1: Summary of the key governance capacities that compute providers can enable.

These governance capacities are distinct from but related to obligations to *report* information to governments. In many cases, it will be appropriate for compute providers to collect and retain information internally and only provide information to governments in response to existing legal authorities (for example, identified violations of sanctions, or in response to legal warrants). In other cases, for example, where a customer is undertaking a large training run, regulators may see fit to mandate proactive reporting. Record keeping can ensure that compute providers are aware of, and able to comply with, broader regulations to increase visibility and oversight.

2.2.1 I. Security

Compute providers, as custodians of sensitive data and AI-related IP, have a distinct capacity for governing and implementing information security measures that protect AI systems.

¹³Focusing on essential data that informs without compromising privacy and confidentiality.

I. Securing

1. Provider takes physical and cybersecurity measures to secure the AI model, related intellectual property, and personal and confidential data.

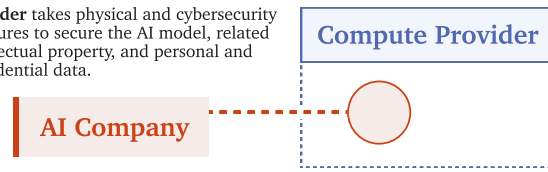

II. Record Keeping

1. Provider selectively collects, organizes, and maintains high-level information on the AI Company's infrastructure usage, focusing on essential data that helps validate regulatory compliance without compromising confidentiality or privacy.

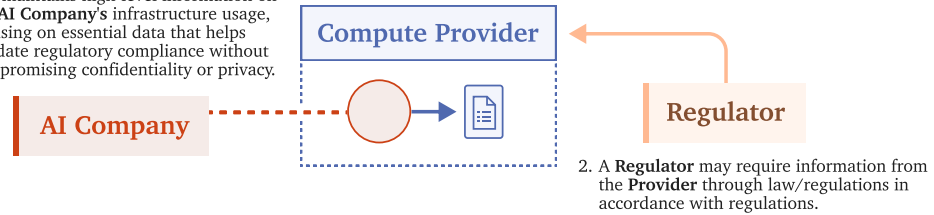

III. Verification

1. Provider actively verifies the AI Company's identities, specific activities, and AI Systems' high-level properties for compliance.

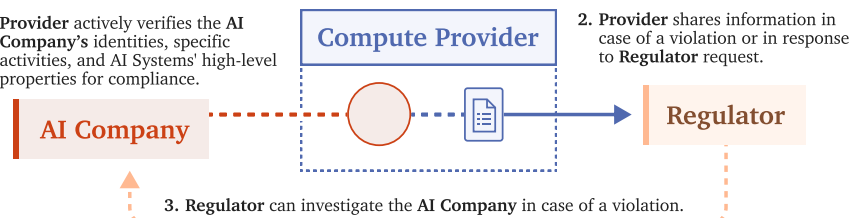

IV. Enforcement

1. Provider identifies an AI Company's violation (e.g., via verification).

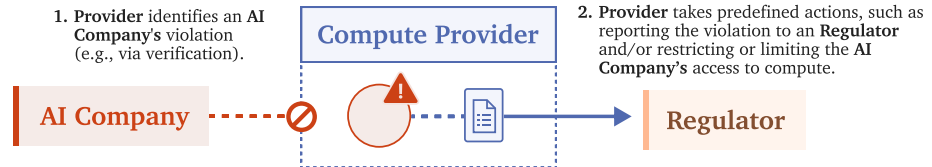

Figure 4: Overview of the different governance capacities and how they relate to three actors: customers (the AI developers and deployers), compute providers, and regulators.

Frontier AI models represent considerable financial, computational, research investments, and powerful tools that could be misused for financial or political gain; this makes them highly attractive to cyber attackers and other adversarial actors (Cottier, 2023; Sevilla et al., 2022). Security measures should extend beyond safeguarding model weights to include the protection of the model's architecture, its algorithmic innovations, training data, and other related intellectual property (IP) (Nevo et al., 2023). Therefore, it is important to take robust cybersecurity measures proportional to these risks. These measures could be legally mandated, as with the physical and cybersecurity precautions currently required from data centers that handle HIPAA- and ITAR-compliant health (Office for Civil Rights, 2016) and defense data¹⁴, as preventing the theft of potentially dual-use AI intellectual property and disruption to critical AI infrastructure are matters of public good.¹⁵

¹⁴ITAR compliance requires arms-related data to be secured from foreign persons. There is no formal certification process for cloud providers, although many choose to be audited by a third-party organization certified under the Federal Risk Authorization Management Program (FedRAMP) (Code of Federal Regulations, 2024).

¹⁵Such regulations could be enforced by chartering or registration (for example, firms cannot accept federally insured deposits unless chartered as a bank, credit union, or thrift) (Congressional Research Service, 2023), or

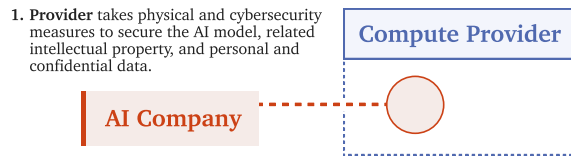

Figure 5: The security measures implemented by compute providers to help protect AI company’s models, intellectual property, and confidential data.

Such a measure should take into account existing industry practice: Large-scale compute providers already allocate significant resources to physical and cybersecurity, given strong business incentives to keep clients’ sensitive data secure (including, in some cases, classified government data (Lohr, 2023)). When multiple AI firms utilize a single compute provider, they inherently benefit from the provider’s comprehensive physical and cybersecurity measures, which benefit from the economies of scale and significant investment. Nevertheless, compute providers remain vulnerable to malicious cyber actors and can be the subjects of successful cyber attacks (Gatlan, 2023; Vanian, 2024). The potential for frontier AI to be stolen, misused, or to become critically important infrastructure, may warrant the development of stronger security requirements for the compute providers that train and deploy them. This necessity was reflected in the voluntary White House Commitments (The White House, 2023a) and the Hiroshima International Guiding Principles for AI, which advocate for strengthened safeguards in this domain (European Commission, 2023a;b).

It is crucial to acknowledge that the responsibility for ensuring information security does not rest solely with compute providers. The efficacy of their security measures requires robust security practices and collaborative efforts by AI companies themselves. Without these companies’ proactive engagement in safeguarding their operations, the protective mechanisms implemented by compute providers could prove ineffective. Therefore, these efforts are not substitutive but rather complementary, with both compute providers and AI companies sharing responsibility.

2.2.2 II. Record Keeping

Record keeping describes the process of collecting, organizing, and maintaining information on a compute provider’s customers and their infrastructure usage. Compute providers are inherently record keepers by virtue of their role and technical necessity. They store and process valuable technical data during large AI deployments and training runs for billing purposes, resource management, and service-level agreement tracking (see Section 3 for more detail). Provided that robust privacy protections are in place, this information could be useful to regulators in overseeing the development of advanced AI systems. We recommend that regulators and providers focus on essential data that informs AI regulation without compromising privacy and confidentiality (which we discuss in more detail in Section 5.2).

Record keeping serves three main purposes: it allows more visibility into the developments of AI generally, helps link customers and their usage to real-world actors, and enables post-incident attributions and forensics. First, it provides visibility into AI developments, which is important for monitoring the trajectory of AI systems and their compute requirements across various sectors (Sastry et al., 2024). As we have seen demonstrated by recent national compute initiatives (Center for Open Science, 2019; UK DSIT & Donelan, 2023; The European High Performance Computing Joint Undertaking, 2023; U.S. National Science Foundation, 2024), compute provision can be a mechanism to guide AI development and formulate policies for a beneficial distribution of compute resources (Besiroglu et al., 2024; Sastry et al., 2024). By gathering aggregated and anonymized compute usage data, governments are better positioned to formulate policies that mitigate unequal access, reduce market monopolization, address potential negative impacts, and boost beneficial innovations aligned with national objectives (Sastry et al., 2024).

_____ tied to a license to acquire specialized AI compute hardware, as is already in place for the export of certain equipment from US companies (AMD, 2024).

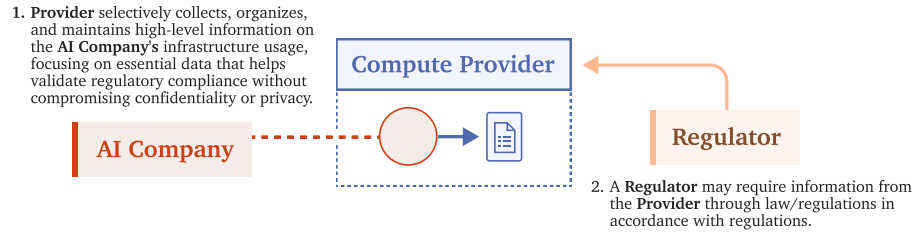

Figure 6: The compute provider collects and manages essential usage data on the AI company and its infrastructure usage, focusing on key data that helps validate regulatory compliance without compromising privacy. This facilitates greater transparency into AI advancements, could link compute use to real-world actors, and enables effective post-incident response and forensics.

Second, record keeping enables compute providers and regulators to identify their customers and the corresponding legal entities (KYC). With the development of frontier AI regulations, it will likely become necessary to verify the identity of compute customers utilizing large amounts of compute and ensure that they have the necessary certifications and safeguards in place, if they plan to build and deploy advanced AI systems. Furthermore, countries may wish to enforce export controls on compute, restricting the sales of data center capacity to actors with improper sources of funding (e.g., terrorist organizations) or originating from sanctioned geographical areas (US BIS & US DOC, 2023; Heim & Egan, 2023).

Third, and related to customer verification, record keeping enables post-incident attributions and forensics (O'Brien et al., 2023).¹⁶ Information about developers and their activities is critical for assigning liability or enhancing existing systems in the aftermath of incidents. This is akin to mandatory record keeping in the financial and telecommunications industries for law enforcement purposes (legislation.gov.uk, 2014; U.S. Securities and Exchange Commission, 2003). We propose careful legislation that requires compute providers to maintain relevant records while taking into account privacy concerns and the regulatory burden. This is especially important in cases of potential unlawful use where the developers may not keep adequate records in the absence of legislation. For example, high-level compute utilization data could be made available to regulators upon request, while detailed retained information may be kept confidential unless required for enforcement or legal proceedings.

In contrast to verification, which is introduced below, record keeping does not require active processing by the compute provider. Instead, it describes the collection of specific data, which is already happening to some extent, to make more information available to governments. For example, it could inform national policy decisions and strategies (Whittlestone & Clark, 2021), and help prevent and respond to serious incidents (where required under warrants and/or by regulation). The use of aggregated and anonymized compute usage statistics could offer valuable insights into trends in AI development and corresponding compute demands (e.g., to learn more about the impacts of the *compute divide* (Ahmed & Wahed, 2020; Besiroglu et al., 2024)). This approach allows regulators to understand and respond effectively to the evolving needs of the AI economy without encroaching upon the privacy and confidentiality of companies. This could operate on a need-to-know basis, ensuring that only pertinent information is gathered and utilized in a way that minimizes regulatory burden.

Furthermore, transparency requirements for environmental accountability, particularly in the context of compute providers' substantial energy consumption, have been suggested (OECD, 2022). Mandating reports on the environmental impact of compute providers could equip regulatory bodies with the insights necessary to fulfill environmental objectives. The EU already has implemented reporting requirements.¹⁷ Concurrently, numerous compute providers are already advancing toward greater

¹⁶An example of this could be in the event of an AI system malfunctioning and causing financial loss or physical harm, record keeping allows for the traceability of the AI's development and deployment process, helping to identify the origin of the fault (*forensics*) and parties responsible (*attribution*).

¹⁷⁷⁶Under the directive, owners and operators of data centers with 500 kilowatts or more of installed IT capacity will need to report their 2023 energy performance by May 15, 2024. That includes statistics about

environmental transparency and have pledged to undertake climate initiatives. (Amazon.com, Inc., 2024; Microsoft Azure, 2024a; Google Cloud, 2024b).

2.2.3 III. Verification

Compute providers can also actively verify customer compliance with regulatory requirements, providing AI firm oversight. Similar to banks and other financial intermediaries, compute providers can actively verify the identity of customers and key customer activities, checking that the properties of AI systems being deployed or developed match customer reporting. This might include verifying the type of computational workload run by the customer (e.g., training an AI model, or deploying a model at scale) as well as claims about the total amount of compute used, or the type of data used in the training process.¹⁸

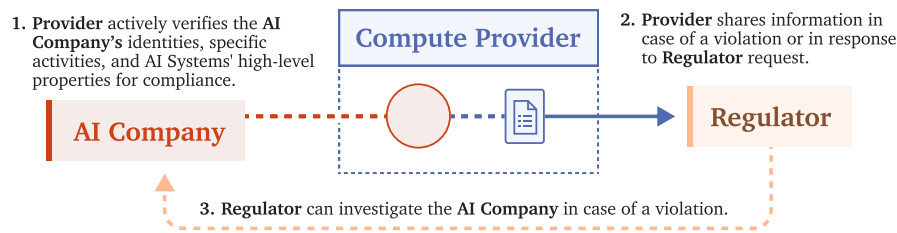

Figure 7: The compute provider actively verifies the AI company’s identities, specific activities, and/or properties of AI systems for regulatory compliance.

As we will discuss in Section 3, some of these capabilities, such as identifying whether a customer is training or deploying an AI model, can likely be implemented using existing data collected by compute providers. Providers could use this information to catch regulatory violations, including breaches of model training requirements, wherein developers avoid reporting requirements and the unauthorized deployment of AI models at scale.

Verification rules should balance between regulatory requirements, customer privacy laws, and safety considerations, similar to record keeping practices. Spot checks (including those triggered by reports or events that raise suspicion) may be adequate for less risky activities, while continuous monitoring to ensure that customer-submitted records are accurate may be mandated for riskier ones. Providers can then check if mandated or adequate risk practices are applied. AI safety regulations could be applied only to those using large amounts of compute and waived for smaller customers. Additional factors may warrant further examination, like a history of non-compliance or inclusion on restrictive lists like the US Department of Commerce’s Entity List, which serves to protect national security interests. The standardization and aggregation of reporting processes across providers is crucial for ensuring effective cross-provider verification. This uniformity prevents AI developers from evading regulations by splitting their training or deployment activities among multiple providers.

Verification becomes vital in cases of behavior that may indicate non-compliance, such as a failure to report details of a training run mandated by regulations like the AI Executive Order. For example, if there is credible evidence of a sophisticated AI model having been trained, regulators could request certain verifications from compute providers to confirm that model developers or providers are in compliance. This approach is similar to selective tax audits, providing the regulation with more enforcement capability (Advani et al., 2023). Even though immediate action might not be taken, having access to such information allows for inspection if necessary, especially in response to suspicious activity. Compute providers could respond to such regulatory requests by verifying customer activities and providing an additional check that model developers are following rules. This process may involve asking customers to provide justifications or evidence for their activities in the same way that financial institutions can inquire about suspicious transactions from their clients.

installed power, incoming and outgoing data traffic, total data stored and processed, energy consumption, power usage, temperature set points, waste heat utilization, and use of renewable energy.” (Korolov, 2023)

¹⁸Hardware-enabled mechanisms for verification and enforcement of governance regimes are discussed in Aarne et al. (2024) and Kulp et al. (2024).

Unlike record keeping, verification demands more proactive engagement from compute providers. Verification could span a wide range of different specific activities and may include confirming the identities of customers who use substantial compute resources or checking that the workload being executed matches their declared type. In complex cases (such as frontier model training) or direct violations of reporting requirements, the compute provider may flag the case and refer it directly to regulators. It is important to note that several open questions regarding privacy and technical feasibility must be investigated and potentially addressed prior to implementation. These considerations are discussed in the Section 5.

For illustrative purposes, imagine a scenario in which regulations require AI developers to report their compute usage, or notify a government prior to training a model above a certain compute threshold, as has been outlined in the AI Executive Order. In such cases, an AI developer could be required to provide information about compute usage to the provider. This allows customers to demonstrate that their computing power was employed for specific purposes, such as training several smaller models rather than a single larger model, which might be subject to different compliance standards. The provider then checks that the actual usage is consistent with the developer’s representations. If inconsistencies are identified, the compute provider can flag these events for further investigation and compliance checks. This arrangement, which uses compute providers as an intermediary, helps minimize regulatory burdens on the AI industry. Similarly, a compute provider could require a model developer to provide proof that they have appropriately notified the government of a threshold-exceeding training run prior to the compute provider allowing access to related compute.

2.2.4 IV. Enforcement

Compute providers can also aid regulatory enforcement. By virtue of controlling the AI data centers themselves, providers have the ability to directly deny access to rule-breaking customers, and, therefore, prevent the customer from developing or deploying certain kinds of AI systems with that provider. The compute provider might limit compute resources devoted to workloads that raise red flags pending further investigation. Similarly, record keeping and verification processes could trigger regulatory enforcement measures by other actors, such as the Department of Justice in the US.

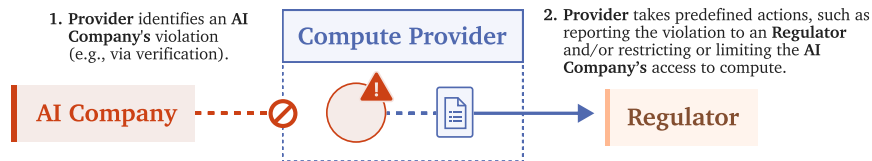

Figure 8: The compute provider detects violations by the AI company, e.g., via the verification process, and can take appropriate enforcement actions, such as restricting or limiting access to compute.

In addition to assisting governmental enforcement, compute providers can enforce their terms of service (ToS). By expanding their ToS to include stipulations on AI development and usage to promote safety, providers can autonomously enforce compliance. This self-regulation approach goes beyond merely reacting to government regulations; it could be an active promotion of responsible AI practices—reflecting the providers' commitment to ethical standards in AI development.

Direct enforcement by compute providers can come in multiple forms. On the most basic level, regulation could be crafted to require providers to refrain from providing compute to developers to train a model above a certain threshold until the developer proves they have taken appropriate regulatory steps, such as notifying the government of a large training run or obtaining relevant approvals. Providers could also help regulators enforce rulings (e.g., when a license is denied, or when a government is trying to prevent a malicious actor from accessing compute) or automatically deny the execution of AI software depending on whether the model is approved. More fine-grained restrictions, such as slowing access or limiting certain workloads until the proper regulatory approvals are issued (similar to financial service providers temporarily flagging a transaction for further review), could also be enforced. Compute providers could monitor the activity of customers using large

amounts of compute that have stated they are not engaging in model training for signs they are circumventing the types of requirements laid out above.

Enforcement works most effectively in conjunction with verification. Detected violations can be promptly acted upon through the compute providers' capabilities. However, it is crucial to keep these two capacities distinct. Enforcement actions can be based on information beyond what is verified by compute providers, for example, in response to intelligence provided by law enforcement agencies. Likewise, violations identified through the verification process may be addressed through means other than restricting compute access. For example, if a customer is found to be out of compliance with existing regulations, or the compute provider's ToS, the provider can restrict their access to the computational resources completely and report them to the relevant authorities. The provider can also use less onerous enforcement mechanisms, e.g., turning off the workload of concern, reducing the amount of available compute resources, or fining the actor.

3 Technical Feasibility of Compute Providers' Governance Role

This section examines the technical feasibility of activities within each of the governance capacities introduced in the previous section.

We assess feasibility in the context of the technical capacities available to compute providers today, and the capacities that could foreseeably be developed. An overview of the technology stack available to compute providers can be found in Appendix A and is recommended for readers unfamiliar with data center technology.

Key terms used in this section

Workload: A computational task, defined by a specific instance of software (i.e., written or compiled code) that will be run on a hardware configuration. For example, training an AI model is a type of workload. The input data to the workload may or may not be known in advance.

Operation (OP): A single calculation run on computer hardware, typically a multiplication or addition of two numbers. AI workloads usually involve large numbers of matrix-multiply operations, which are implemented as repetitive multiplications and additions (known as multiply-accumulate).

AI accelerator: A hardware device (typically a specialized chip) designed for fast and efficient execution of AI workloads. Typically AI accelerators excel at simple, parallel calculations, which can also be useful for graphical and scientific computing workloads. This is an umbrella term for both current hardware paradigms (such as GPUs and TPUs), as well as novel future designs.

Node: A single computer within a data center. Each node is a distinct unit with its own processing power, memory, and storage, capable of running a workload by itself, or in collaboration with other nodes. Each node may contain multiple AI accelerators.

(Computing) cluster: A group of linked nodes that can work together to process workloads. Typically used for workloads requiring significant computational resources, such as large-scale AI training.

Data center: A facility that hosts computing clusters (or other computing infrastructure) and provides the supporting infrastructure needed to operate them efficiently.

In summary, compute providers are responsible for maintaining secure premises, and physical and network infrastructure. They also operate controls over that infrastructure (at both the hardware and software level) that allow them to grant and revoke hardware access to particular customers, store and maintain customer data, track hardware performance, and debug technical issues. These same tools could allow compute providers to engage in security, record keeping, verification, and enforcement for frontier AI regulation, while preserving existing industry norms surrounding confidential and private data. Table 2 maps these governance capacities onto the relevant technical capacities available to compute providers, and indicates the current feasibility of using them.

Governance capacity	Relevant technical capacities of compute provider	Current technical feasibility
<i>Security</i>	<p>Physical security (e.g., locks, guards, surveillance).</p> <p>Infrastructure-level security (e.g., access controls, secure firmware, resource isolation).</p> <p>Network security (e.g., firewalls, network authentication).</p> <p>Providing additional cybersecurity services (e.g., user access management, encrypted storage).</p>	<p>Feasible for low-end threats (in a supporting role). Many compute providers provide decent default levels of physical, infrastructure, and network security. With adequate customer investments in cybersecurity, these measures are likely sufficient against opportunistic attackers, but not against well-resourced and persistent expert attackers.</p>
<i>Record keeping</i>	<p>Data record collection and maintenance (e.g., for required verification activities).</p> <p>Securing data records (e.g., encryption at rest and in transit, managing access).</p>	<p>Highly feasible. Compute providers can (and do) collect a wide variety of records on customers and their activities. These records are typically kept secure, and retained for as long as necessary to comply with relevant regulations or support internal business use cases.</p>
<i>Verification</i>	<p>Identity verification: ensuring a customer and/or user is who they say they are.</p> <p>Workload classification: determining whether a customer workload falls within a category relevant to regulatory requirements (e.g., training a very large AI model).</p> <p>Compute accounting: estimating the number of operations consumed by a workload (e.g., to validate compute threshold-based reporting requirements¹⁹).</p> <p>Detailed workload verification: verifying aspects of the specific code or data used in a workload (e.g., to validate whether a customer is complying with reporting requirements for certain high-risk training data²⁰).</p>	<p>Identity verification: likely feasible with a sufficiently rigorous process, focused on customers accessing large-scale compute resources.</p> <p>Workload classification: likely feasible for detecting large-scale pre-training and inference workloads.</p> <p>Compute accounting: feasible, with multiple approaches possible for large-scale pre-training/inference workloads.</p> <p>Detailed workload verification: currently not possible without directly observing customer code or data. “Confidential computing” techniques could change this.</p>
<i>Enforcement</i>	<p>Account-level enforcement: revoking service access to particular customers/accounts/users.</p> <p>Model-level enforcement: revoking service access where services are used to deploy particular models, or where models are displaying dangerous behavior (e.g., a computer worm-like AI system).</p>	<p>Account-level enforcement: highly feasible, compute providers have both physical and software management-based control over their hardware; this is widely used.</p> <p>Model-level enforcement: currently not possible without directly observing customer code or data. This may become possible with some technical effort.</p>

Table 2: Overview of relevant technical capacities available to compute providers and an assessment of their technical feasibility.

¹⁹For example, see the training compute threshold-based reporting requirement in the AI Executive Order (The White House, 2023b).

²⁰For example, the AI Executive Order (The White House, 2023b) creates specific reporting requirements on developers for models primarily trained with biological sequence data. It may become useful for these kinds of reporting requirements to also be validated by compute providers, or for compute providers to offer verification tools to developers (e.g., “confidential computing” services).

3.1 Security

Compute providers usually provide security at certain technology layers, whereas other layers are left up to customers (Google Cloud, 2023; AWS, 2024h; CoreWeave, 2023). The compute provider is typically responsible for:

- **Physical security**, which includes protecting data center premises with locks, cameras, guards, and surveillance.
- **Infrastructure security**, which includes ensuring that hardware is up-to-date with the latest firmware security patches, securely disposing of old hardware, restricting physical/virtual access to infrastructure to approved personnel for management and maintenance purposes, and ensuring appropriate isolation of critical system resources across different customers and workloads
- **Network security**, which includes operating firewalls and providing other forms of network-level security and isolation.

These physical, infrastructure, and network security measures are sufficient to provide customers with a baseline level of information security, one that many customers could not achieve on their own.

Customers are then generally held responsible for the parts of the technology stack they have control over, which encompasses many aspects of cybersecurity, including protecting data generated or collected by their workloads, ensuring their employees are well-trained in security best practices, and implementing access control policies based on different permission levels. Many compute providers, especially larger providers, offer cybersecurity software-as-a-service products for their customers to help them implement these measures; many of these products are free and/or standard with infrastructure offerings. These additional services typically provide the customer the ability to:

- Securely manage user access to resources in their account
- Work with encrypted data storage in transit and at rest
- Manage and secure inbound/outbound traffic from nodes
- Define different levels of security within different regions of their infrastructure

In the context of protecting frontier AI workloads, if a customer is working with a security-conscious compute provider, and the customer has systematically implemented industry best practices for cybersecurity, they are likely well-protected against most opportunistic attackers. However, these measures are almost certainly inadequate to defend against well-resourced, expert attackers, such as nation-state-backed hacking groups (also known as “advanced, persistent threats (APTs)”). Such threats are of significant concern for frontier AI, given the potential economic returns of model theft, and risks of misuse (Nevo et al., 2023).

As discussed in Section 2.2.1, it is therefore important to strengthen security standards for frontier AI workloads. In addition to requiring strong cybersecurity standards for frontier AI developers, regulators could define enhanced security standards for compute providers who offer infrastructure capable of training frontier models to close security gaps.²¹

3.2 Record Keeping

Record keeping is highly feasible using tools and metrics currently available to compute providers, who already collect a wide range of data on customers and service usage for:

- Accurately billing customers
- Marketing new services to customers
- Maintaining and optimizing service provision
- Detecting and responding to fraud, abuse, security risks, and technical issues

²¹For an example of what such standards might look like, see security requirements in the Federal Risk Authorization Management Program (FedRAMP). FedRAMP assigns different levels of requirements depending on the sensitivity of the use case (FedRAMP, 2024).

- Complying with legal obligations, such as financial record keeping

Compute providers also share these records with third parties for activities such as:

- Exchanging information with other companies for fraud prevention, detection, and credit risk reduction
- Providing third-party vendors with information for promotional and marketing purposes
- Complying with legal obligations, such as an enforceable government request

Compute providers typically have well-defined privacy policies around these records, including specific retention and security policies based on the sensitivity and business- or legal use cases for different kinds of records. Some of this data will likely be useful for verification activities relevant to frontier AI governance. The specific data attributes generally collected by compute providers can be found in Table 3 below, mapped onto specific use cases for governance purposes. This information is based on conversations, public data collection, and privacy policies available from a representative sample of large and small compute providers (AWS, 2024g; CoreWeave, 2022; FluidStack, 2022; Google Cloud, 2024c; Lambda Labs, 2022; Microsoft, 2024a).

3.3 Verifying

There are a range of verification activities that compute providers could perform to support frontier AI governance. Primarily, it will be useful for compute providers to verify the identity of any customer seeking to access a hardware configuration capable of efficiently training a frontier model (“identity verification”), as discussed in Egan & Heim (2023) and by Microsoft (Smith, 2023). It may also be useful for compute providers to serve as an independent form of validation for different properties of frontier AI workloads. We find that data attributes already widely available to compute providers can likely enable them to adequately verify two key properties of a workload that are currently highly relevant for frontier AI governance:

- The stage of the AI lifecycle the workload fits into, e.g., large-scale model training or inference (“workload classification”)
- The quantity of compute consumed by the workload (“compute accounting”)

In the future, it may also be useful for compute providers to verify aspects of the particular code or data used in a workload, such as the specific model that was deployed, or the type of data used to train a model. We describe such activities as “detailed workload verification.” Currently, this is largely not possible without directly observing confidential customer code or data. However, with some technical development work, it may become possible to implement wider use of “trusted execution environments” to allow customers to prove certain properties of their workloads to their compute provider (or directly to a regulator) without revealing other sensitive data (Aarne et al., 2024; NVIDIA, 2023). We now describe each of these potential verification activities in more detail.

3.3.1 Identity Verification

Identity verification (also commonly known as “Know-Your-Customer (KYC)”) is a useful measure to ensure customers are meeting applicable rules, and enforce relevant penalties. This may include ensuring particular developers are reporting relevant large-scale training runs or enforcing export controls that prevent certain customers (e.g., those with links to foreign military/intelligence organizations) from accessing particular services. In the beginning of 2024, the US Department of Commerce proposed new regulations that place explicit identity verification requirements on US compute providers offering services to foreign customers (Federal Register, 2024). Egan & Heim (2023) discuss in further detail the mechanisms of a KYC scheme for customers accessing large-scale compute, drawing on lessons from the financial sector.

Attribute category	Uses (in terms of specific verification activities)	Involves collection of data not already widely collected? ²²	Current state of collection, validation, and possible circumvention ²³
<i>Customer information</i> e.g., name, billing address, credit card data, IP addresses, date and time of access, device identifiers, language	Identity verification	No, already collected.	Compute providers already collect a wide range of customer information. Customers can potentially spoof much of this data to try to avoid identification.
<i>Billing-related technical information</i> e.g., hardware configuration requested by a customer, number of hours that hardware resources are used	Workload classification Compute accounting	No, already collected.	Already collected by compute providers for billing purposes. Highly difficult or impossible for customers to alter to avoid monitoring.
<i>Cluster-level technical information</i> e.g., power consumption, network bandwidth utilization between nodes	Workload classification Compute accounting	No, already collected.	Already collected by compute providers for service health monitoring and maintenance. Customers could modify their workloads to avoid certain forms of cluster-level verification, likely with performance penalties.
<i>Node-level technical information</i> e.g., AI accelerator core utilization, AI accelerator memory bandwidth utilization	Workload classification Compute accounting	Potentially, already collected. ²⁴	Possible to collect using existing tooling, and collected by some compute providers. ²⁵ Customers could modify their workloads to avoid certain forms of node-level verification, likely with performance penalties.
<i>Workload-level technical information</i> e.g., code, data, hyperparameters	Workload classification Compute accounting Detailed workload verification	Yes, currently not collected.	Compute providers cannot typically retain or inspect this information (by design). Confidential computing tools could potentially be developed to verify information in a privacy-preserving manner.

Table 3: An overview of the categories of data attributes available to compute providers and how they can be used for different verification activities.

Identity verification of this kind appears feasible, but we recommend that policymakers consider several strong caveats. As described above, compute providers typically collect a range of information relevant to verifying customer identities. This includes (AWS, 2024g; CoreWeave, 2022; FluidStack, 2022; Google Cloud, 2024c; Lambda Labs, 2022; Microsoft, 2024a):

²²Based on our current understanding and insights gathered from interviews, and given publicly available information.

²³In this column, we collect information on whether each data attribute is already collected, and if not, how it could be collected. We also list whether it might be possible for customers to falsify each data attribute in order to avoid information being verified.

²⁴While examining customer data is out-of-scope, collection and analysis of certain types of metadata could risk exposing details of the customer's data.

²⁵See Weng et al. (2022) and Google (2024).

- Personal information, such as legal names, user names, email addresses, phone numbers, and government-issued identification documents
- Information about customer organizations and the people in those organizations
- Financial information, such as credit card and bank account information, and tax identifiers
- Service-related information, such as the locations from which users are accessing the service, time zones, the type of device a user is using to access the service, the language used on that device, web cookies describing sites previously visited, and IP addresses used when accessing the service.

This equips compute providers with large amounts of useful information for verifying the identity of customers seeking to access infrastructure sufficient to efficiently run frontier AI workloads. Because such customers will by definition be few in number, best practices for identity verification could be drawn from more involved identity verification activities such as those conducted in other industries. One example is the “enhanced due diligence” process used in financial sectors for higher-risk customers or transactions, which can involve commissioning intelligence reports on customers or their “beneficial owners” (the entity that ultimately owns or controls the customer organization) (Financial Action Task Force, 2003). These kinds of measures may be necessary to successfully perform identity verification in situations where a well-resourced illicit actor is actively trying to obfuscate their identity.

In performing identity verification, it is important for regulators and compute providers to bear in mind potential trade-offs with user privacy and data privacy regulation in different jurisdictions. It would likely be useful for identity verification requirements to be standardized across different jurisdictions. We discuss these challenges in Sections 4.4 and 5.2.

3.3.2 Workload Classification

“Workload classification” describes a scenario where an infrastructure provider is attempting to classify a workload into a particular category. We will consider, from a frontier AI governance perspective, what these categories might be, and how they might be differentiated.

First, it is useful to know whether a workload relates broadly to AI. Frontier AI workloads will generally all use AI accelerators, but not all workloads that use AI accelerators will necessarily be AI workloads. For example, graphics and scientific computing workloads sometimes use AI accelerators. However, these workload categories can likely be differentiated using observable properties of the workload. Examples of such properties are outlined in Appendix B in the Appendix. Within the broad category of AI workloads, there are several sub-categories of workload, corresponding to stages in the AI model’s life cycle, that are useful to differentiate from a governance perspective:

- **Design**, in which researchers and engineers experiment with different model designs, algorithms, and datasets.
- **Training**, in which a model learns from a large dataset. Typically known as “pre-training” to distinguish from enhancement.
- **Enhancement**, in which a trained model is further refined using a smaller data set (e.g., fine-tuning), sometimes using techniques such as reinforcement learning.
- **Deployment** in which a trained model is used in an operational setting, e.g., to make new predictions (“inference”).

Each of these categories can be distinguished based on scale, among other attributes. Given the large scale of the frontier AI workloads we are interested in detecting and classifying, we can place a strong initial filter on which specific workloads warrant attention, ignoring the vast majority of workloads run on a compute provider’s infrastructure. As discussed by Sastry et al. (2024), the training stage, where compute demands are especially high, is an especially practical stage to monitor.²⁶

The simplest method of workload classification might be based purely on the hardware configuration (in terms of types and numbers of devices) available to a customer. For example, in 2024, if a customer has requested a hardware configuration involving tens of thousands of AI accelerators,

²⁶See Section 3.C of Sastry et al. (2024).

Simplified AI Lifecycle

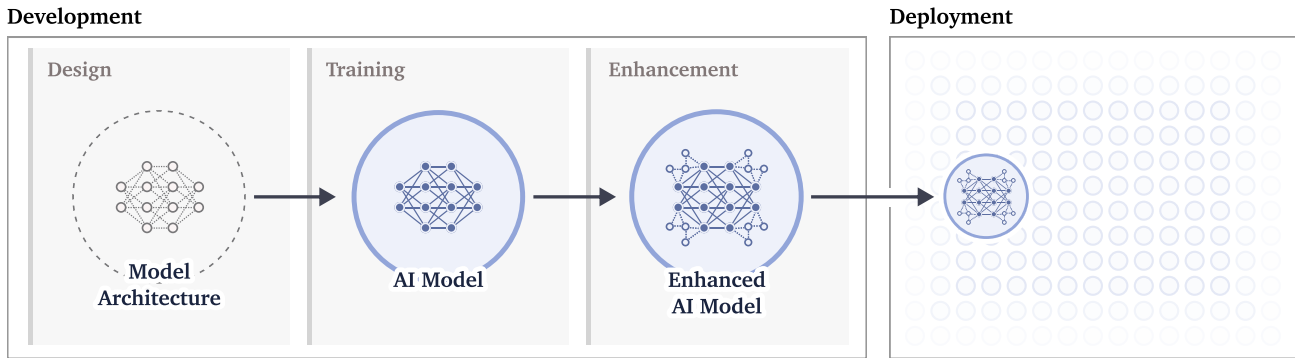

"Computing Power and the Governance of Artificial Intelligence"
Sastry, Heim, Bellfield, Anderjunga, Brundage, Hazell, O'Keefe, Hadfield et al., 2024

Figure 9: Simplified AI Lifecycle including training, enhancement (e.g., fine-tuning), and deployment (i.e., inference). (Figure from Sastry et al. (2024).)

connected together using a high-bandwidth network fabric, it becomes much more likely they intend to engage in large-scale training, relative to other customers. Combining this information with the amount of time the hardware is being used can tell us whether it was possible for a customer to run a particular workload (e.g., pre-training above a particular scale), which could provide grounds for a more detailed investigation. These coarse methods are possible using data already available to compute providers for billing purposes. See Section 3.3.3 below for more information on these kinds of approaches.

More precise methods for frontier workload classification might involve manually defining some technical characteristics of relevant workloads, or training a machine learning classifier using cluster- and node-level technical information to predict whether a workload falls into a relevant category. Compute providers could also collect declarations from customers about the workloads they are running, and use that information as a reference point for classification. These approaches are based on the assumption that different kinds of workloads will have characteristic and learnable features. As an example, we expect frontier-scale training in 2024 will likely have several distinguishing features relative to other possible workloads. These could include the number of accelerators used (tens of thousands), the peak operation throughput utilization of accelerators over time (fairly constant), the patterns of communication between and within nodes (following specific patterns corresponding to different forms of parallelization), and limited outbound/inbound communication to external networks, such as the Internet, during the training run. According to six interviews with commercial compute providers, including both large and smaller providers, these kinds of cluster- and node-level characteristics are often already collected and used to understand customer workloads to optimize their services.²⁷ Research released by Google, Microsoft, and Alibaba demonstrates some of the ways this technical information is collected and analyzed for business purposes (Jeon et al., 2019; Tirmazi et al., 2020; Weng et al., 2022). Some of this data has been released as public data sets that can be used to develop workload classification techniques (Alibaba, 2024; Google, 2024).

Workload classification techniques using these kinds of data have been studied in different contexts. (Tang et al., 2022) introduced the “MIT Supercloud Dataset,” containing node-level technical information for over 3,000 AI accelerator-based workloads. Workload classifiers trained on this data have reached 95% accuracy at distinguishing AI workloads across ten different model architectures (Weiss et al., 2022). Other research on workload classification for different kinds of high-performance computing workloads has reached similar levels of accuracy (Banjongkan et al., 2018; Terai et al., 2017), including classifiers trained only to use data on power draw (Copos & Peisert, 2020; Köhler et al., 2021).

²⁷Interviews conducted between October 2023 and February 2024

However, there are several ways these findings may not be representative for frontier AI workload classification in a production environment. First, the authors mostly generated labeled data by running workloads themselves, which likely involved a level of standardization in software and datasets that would be unrealistic for real-world conditions. Second, this research typically involved a small number of different hardware configurations and scales, whereas these parameters will likely vary further in production contexts. Lastly, even a 5% error rate may be prohibitively high in production, given the potential consequences of reporting a false positive to a regulator.

Compute providers offering large-scale AI clusters are likely to have the expertise to address these technical challenges. In doing so, we recommend that compute providers—in collaborative efforts where possible—consider a range of technical approaches for classification, ranging from simple manually defined thresholds through to machine-learning based classifiers. These methods could also be combined with other useful data and processes, such as by soliciting customer declarations on the intended use/purpose of a hardware configuration or workload, and by conducting follow-up investigations in cases where classification confidence is low. Box 1 demonstrates what a workload classification process combining these elements might look like.

Box 1: An example process for frontier AI workload classification.

1. The compute provider lists the specific set of hardware configurations and scales they offer that are sufficient for efficient training of frontier AI workloads (i.e., within defined cost/time boundaries). Given that compute providers tend to specialize in particular hardware configurations (e.g., AI accelerator types and node configurations), this number could be quite small.
2. The compute provider collects labeled cluster- and node-level data on workloads simulated or run on each of these configurations. Compute providers offering similar hardware configurations may benefit from coordinating to produce larger datasets.
3. The compute provider creates technical thresholds to define relevant workload categories based on their identifying characteristics, and tests them on the collected data. This could include training ML-based workload classifiers. It may be the case that a single classification approach works well for a range of different hardware configurations and/or scales, or that more specific classifiers are required for different configurations.²⁸
4. In operation, for any customer seeking access to or already using a relevant hardware configuration, the compute provider could then:
 - a. Ensure they have performed adequate identity verification.
 - b. Collect declarations from the customer on the intended use of the hardware configuration, and/or declarations on the nature of any sufficiently large workload run on that configuration.
 - c. Validate these declarations by running automated classification on workloads that use that configuration, and conduct follow-up analyses where useful, especially in cases where classification confidence is low.

The difficulty of classifying workloads increases if a compute customer is actively trying to disguise the nature of their workload. This kind of obfuscation may become likely in cases where a customer has a strong financial, criminal, or political incentive to avoid regulatory oversight. Such incentives are likely to grow when frontier AI models become both more attractive for criminal activities and more economically lucrative. Analogous practices can be observed in the finance sector, where illicit actors have engaged in “structuring” (breaking up a single transaction into several smaller transactions) to avoid automated transaction reporting from their bank to the regulator (Linn, 2010). We discuss and list these challenges in Section 5.1.

²⁸For an example of an approach for simulating workloads on large clusters, see Sliwko & Getov (2016).

3.3.3 Compute Accounting

We introduce “compute accounting”: measurements and techniques to produce an estimation of the amount of compute consumed by a customer running one or more workloads on a specific compute cluster. These techniques are comparatively similar to the previous section on workload classification (Section 3.3.2). However, rather than establishing the *class* of a workload, compute accounting aims to determine its *magnitude*. Moreover, compute accounting is useful even when the workload is not classified at all, as an estimate of the total amount of compute used by a given customer is an upper bound for a single (unknown) workload. From a practical governance perspective, compute accounting could be used as an input to workload classification, and/or as a standalone metric to determine whether a particular workload has exceeded a compute-based reporting threshold.

The amount of compute used by a given workload is a useful metric from a governance perspective. In the context of AI training, novel capabilities (and related risks) are likely to first emerge in models that require large amounts of compute (Pilz et al., 2024; Sevilla et al., 2022). In the context of AI inference, compute is correlated with the scale and processing speed of the deployment: how many copies of the model are being run, and how fast the model is operating (the throughput, e.g., tokens per second for LLMs). Insofar as the model is capable enough to potentially cause harm, these factors could then be correlated with risk and the need for enhanced oversight (Appendix I of O’Brien et al. (2023)).

More formally, the total computing power of a rented cluster and how long a customer has access to it results in a quantity of available compute—a “compute budget.” The customer is then choosing how to allocate that budget across different workloads. For example, a given set of AI accelerators could be used for a single training run, multiple small training runs, or model deployment (Figure 10). In cases where compute is being consumed by a customer (as opposed to hardware sitting idle), the amount of compute consumed can be attributed to at least one workload. The addition of workload classification allows fractions of that usage to be ascribed to workloads of particular types.

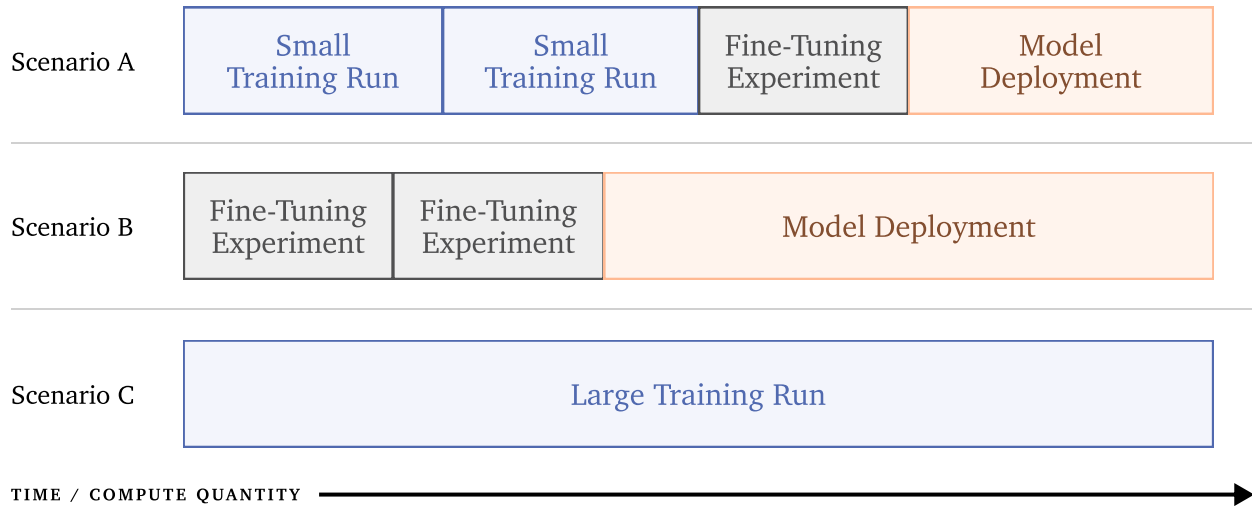

Figure 10: Three example scenarios of a set of AI accelerator nodes running different workloads over time. Compute accounting establishes the amount of compute used over time, while workload classification can differentiate between these three scenarios by mapping compute usage to specific workloads.

We can estimate the compute budget via two different approaches:

1. **Theoretical compute budget estimation:** calculated using the assumed throughput (measured in OP/s) of the hardware potentially involved in the workload, and multiplying it by the time the hardware is being used.

2. **Empirical compute budget estimation:** calculated using actual measurements from the hardware that can serve as more direct proxies for compute consumption. For example, aggregating AI accelerator core utilization and time-in-use data across all AI accelerators involved in a workload, and multiplying by the peak capacity of each core.

Theoretical compute is a derivative of empirical compute, useful for establishing an estimate in circumstances where empirical measurements are not available. As exact circumstances and configurations differ between compute providers, not all attributes of both theoretical and empirical compute are likely to be observable. However, in practice, both kinds could be used to inform an overall estimate of compute usage for a particular instance of running a workload (Figure 11).

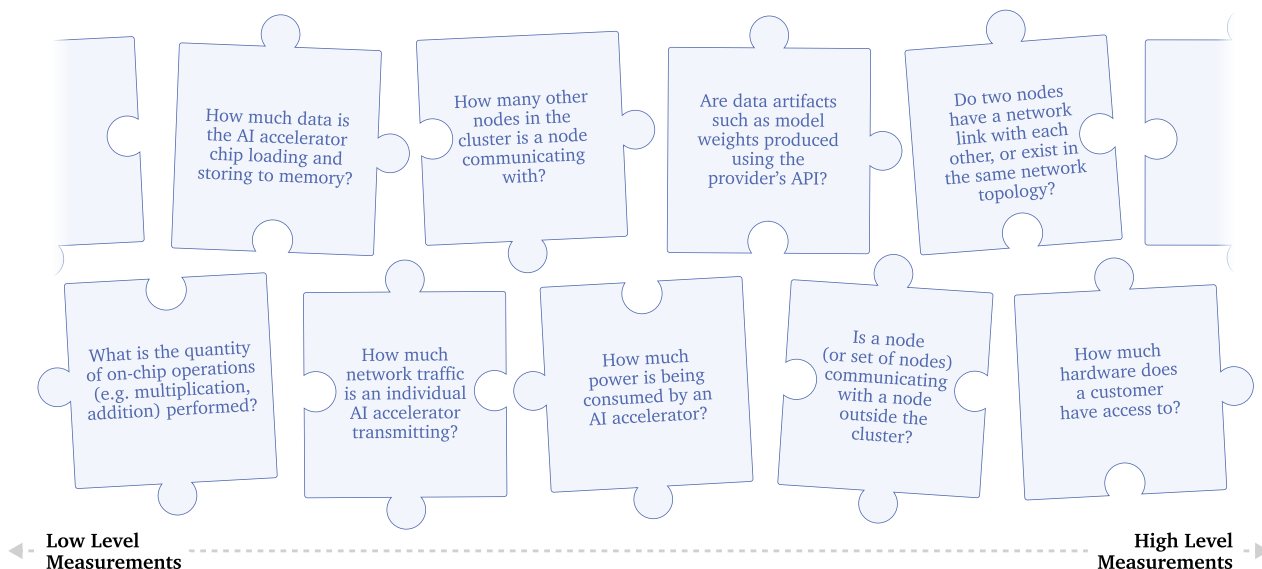

Figure 11: A spectrum of possible compute usage metrics for AI workload analysis, from low-level measurements, such as on-chip calculations, to more high-level measurements, such as the hardware available to a customer. Each of these metrics can be synergistically combined to enhance the accuracy and sensitivity of workload classification and compute accounting.

Regardless of whether the approach is theoretical or empirical, it will be important for compute providers to estimate both throughput (OP/s) and total quantity of operations (OP). This provides crucial information to detect cases where a customer is evading a reportable compute threshold by utilizing multiple compute providers or accounts to sequentially perform partial training of a model. In this case, the throughput available to the customer is necessary to identify that a *rate* of compute usage corresponding to a reportable threshold has been reached, even if the reportable threshold itself has not. We discuss this in 5.1.

Measuring Theoretical Compute Budget — Theoretical approaches measure the *potential* for a certain amount of compute to be used for one or more workloads within a given time frame. This is easier to measure than empirical compute, and in the simplest form is equivalent to hardware resources a customer has been allocated to access within the cluster. For any given compute provider, the number of customers with access to sufficient theoretical compute to train a frontier model will be small.²⁹ This makes theoretical compute a useful measure for determining which specific customers are relevant for a frontier AI regulatory regime. This can be calculated using data already available to compute providers for billing purposes (Table 3). Relevant data for measurement of compute are:

²⁹For example, to meet the AI Executive Order’s reporting requirement of 10^{26} operations for a training run, a customer will need access to around 60,000 cutting-edge AI accelerators (Nvidia H100) for 90 days, assuming a utilization of 34%.

- **Node assignment:** Compute providers can bill customers for *on-demand* nodes (a full or partial node) at a granularity ranging from seconds to hours (AWS, 2024e), or *reserved* nodes ranging from days to months (AWS, 2024f). Theoretically, the used compute budget can be calculated using this information by summing the theoretical peak performance of the AI accelerators in each node, multiplying it by the time the node is available to the customer, and the assumed average utilization of the AI accelerators.³⁰
- **Data ingress/egress:** Data into and out of the cluster is metered and sometimes billed (Google Cloud, 2024a; Microsoft Azure, 2024b; Pal et al., 2021). The communication of nodes within the cluster to endpoints outside the cluster, as well as the amount of data transferred and time when communication occurs, can inform whether nodes outside the cluster participated in a training run or deployment.

The exact procedures to allocate, measure, and invoice customer usage for billing purposes are not publicly available for any major provider. However, every provider must have internal control systems and diagnostics to record this information accurately, as well as status reporting and other telemetry to maintain the health of their clusters (such as the state of individual machines and network switches). While billing information provides a widely-measured baseline for customer compute usage, intra-cluster network information such as the network topology can provide greater detail. Specifically, knowledge of whether two nodes are capable of communicating within a cluster informs whether they may participate in running the same parallel workload.

Theoretical compute, while relatively simple to calculate in most cases, is useful primarily to establish an upper limit on the total compute budget of a customer. To map compute usage onto a particular workload requires additional information at the cluster or node level, as previously covered in Section 3.3.2.

Measuring empirical compute budget — Measurements of empirical compute usage involve observations of a cluster’s hardware-level characteristics, often measurements of the node itself (perhaps from a hypervisor or other privileged software) or inter-node communication fabric. Empirical compute, in contrast to theoretical, can provide a highly precise and accurate accounting of the amount of compute, though some limitations exist. We consider that two categories of measuring empirical compute exist: *operations* and *data transfer*. *Operations* refers to the mathematical calculations performed as part of a workload (most frequently multiplication and addition for contemporary AI workloads). *Data transfer* refers to the movement of the data necessary to perform those calculations: network links from node-to-node, or chip-to-chip within a node or loaded from an AI accelerator’s memory.

While these properties are essentially metadata, compute providers would need to detail collection and observation of this within their terms of service with very clear guidelines about how the data will be collected, stored, and used. While strict internal policies are necessary to ensure the integrity of such metadata, this kind of usage policy would likely not require any significant deviation from existing policies for sensitive customer data handling, or deviation from the kinds of data that are already often collected (AWS, 2024g; CoreWeave, 2022; FluidStack, 2022; Google Cloud, 2024c; Lambda Labs, 2022; Microsoft, 2024a).

Within a given node, opportunities to measure empirical compute include:

- **Operations performed on AI accelerators:** Individual chips contain *performance counters* to measure information such as the number of instructions executed (Wikipedia contributors, 2023). A vendor tool may be required to access this information (NVIDIA, 2024b).
- **Data flow to/from AI accelerator’s memory:** The rate at which data is written to or read from the AI accelerator’s memory can be observed over time, allowing measurement of throughput and quantity, and can inform an estimation of the total number of operations performed (National Energy Research Scientific Computing, 2024; Williams et al., 2008).
- **Data traffic between accelerators and other nodes:** Node-to-node and chip-to-chip communication is an indicator of participating in the same workload, even if the workload itself cannot be classified (Merritt, 2023; NVIDIA, 2024a; Shoeybi et al., 2020).

³⁰“Utilization” in this context refers to the usage as a proportion of the node’s theoretical peak computational performance.

Even without privileged software access to the node, other measurements of cluster operations are useful to inform an estimate of empirical compute:

- **Power consumption:** In cases where precise chip utilization is not observable, measurements of power consumption (of a node or individual AI accelerators within a node) can help inform an estimate. The amount of power consumed by each node is considerably higher when a node (or even an individual AI accelerator (NVIDIA, 2024c)) executes a workload compared to idle. However, power consumption does not simply scale linearly with performance (Patel et al., 2023), though specific calibration for a device may enable improved estimation. Power consumption will typically be a way of measuring both operations and data transfer, as both these activities consume energy within a node.
- **Data traffic between nodes:** Granular information such as the number of data sent to and from the node, the source and destination of this data, and the timing with which they are sent can inform how multiple nodes are cooperatively executing the same workload.

While many of these measurements alone provide limited insight, combining measurements can provide more insight into the compute usage of a particular workload (Figure 11). Empirical measurements form an upper bound for compute usage, as not every operation can be known to have contributed to a workload.

3.3.4 Detailed Workload Verification

To verify compliance with regulations on the development or deployment of frontier AI systems, it may be useful for a compute provider to validate more fine-grained features of a workload, such as whether a particular training dataset was used, the model architecture, or whether a particular model evaluation was run. We call such activities “detailed workload verification.” This form of verification differs from workload classification in that it will almost always require knowing certain properties of the code and/or data used by the customer.

One undesirable form of workload verification would simply require compute providers to have direct access to customer code and data. However, this level of access is not acceptable, as compute providers will not access customer data without permission unless required to maintain the health of their cluster or legally compelled (see AWS (2024b), and other terms of services from compute providers). Internal risk management processes, such as auditing access to customer data by employees, typically govern details such as when access occurred, by whom, and whether it was authorized.

However, using privacy-preserving technologies built into data center hardware, it may become possible for a compute provider, in collaboration with a customer, to verify particular properties of a workload without observing any other information—only the required verification result needs to be shared (Aarne et al., 2024). As one example, many modern CPUs and AI accelerators, such as NVIDIA’s H100, and data center CPUs from AMD and Intel, come equipped with a “trusted execution environment” (TEE), allowing the AI accelerator/CPU’s customer to assert the confidentiality and integrity of code/data, while exposing only the code/data they choose to, and having full control over who they expose it to (Figure 12). Techniques that leverage a TEE in this way are often known as “confidential computing.” Compute providers are increasingly making these features available to customers (AWS, 2024d; Microsoft, 2024b; 2023).

Using confidential computing techniques, customers may be able to provably verify particular governance-relevant properties of their workloads to their compute provider or directly to a regulator. For example, a customer may wish to demonstrate that they ran a particular model evaluation, obtained a particular result on a model evaluation, or did (not) use a particular dataset during training. However, these techniques have yet to be fully validated and implemented in production contexts. Several organizations are actively researching and developing software for using confidential computing to allow privacy-preserving auditing of models (Mithril Security, 2024b; OpenMined, 2023; 2024). There has also been some work on expanding these techniques to allow privacy-preserving auditing of training workloads (e.g., the dataset used, or quantity of compute consumed), though this area is less well-explored (Choi et al., 2023; Mithril Security, 2024a).³¹ If regulatory requirements on compute providers end up requiring them to validate more fine-grained properties of workloads, these

³¹Choi et al. (2023) propose a method for verifying training data, but it requires sharing of sensitive data with the verifier. Making the scheme fully privacy-preserving is discussed but left for future work by the authors.

1. A device-specific **Public and Private key pair** are created on the device, ideally using a dedicated **Security Module**. The public key is shared externally.
2. **Measurements** (e.g. the specific firmware loaded onto the device) are collected, ideally using a **TEE**. Using a TEE means measurements are only observable and shareable by the **Attester**.
3. The **Security Module** uses the **Private key** to create a “signature” of **measurements** taken from the device. This will be used to prove that the **measurements** collected came from the device.
4. Using the **evidence** provided by the **Attester**, the **Verifier** can now validate that the **measurements** are genuine.

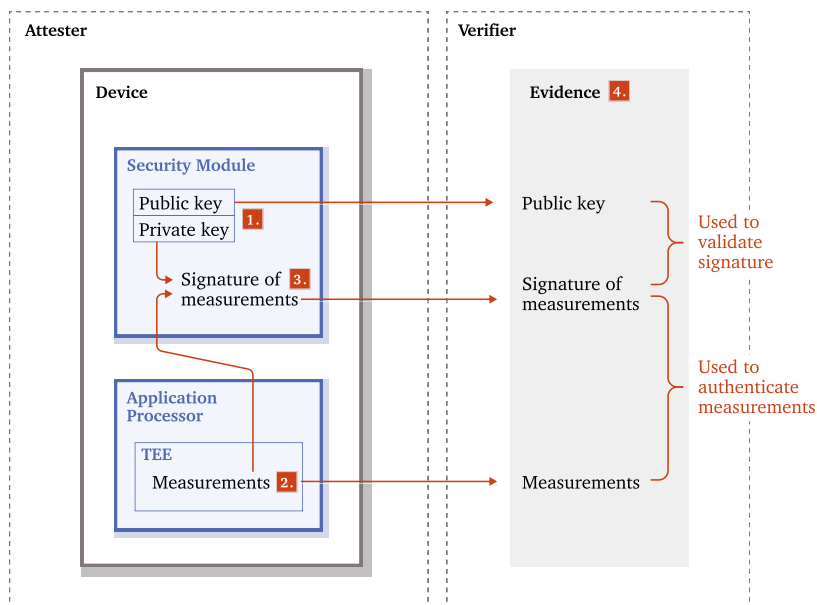

Figure 12: Using confidential computing techniques allows an “attester” (customer) to share high-level information about a workload with a “verifier” (e.g., a compute provider or a regulator) such that the verifier can trust the information, without the attester sharing any additional code or data. (Adapted from Aarne et al. (2024).)

kinds of methods could be used to achieve this in a way that preserves customer confidentiality and privacy. In the meanwhile, we encourage compute providers and developers to explore and develop these techniques to ensure they can be implemented without meaningful performance penalties, and while preserving other aspects of customer experience and confidentiality.

4 Constructing an Oversight Scheme

Incorporating roles for compute providers in security, record keeping, verification, and enforcement, accompanied by appropriate reporting, could form the basis of an effective compute oversight scheme. Such a scheme could enable greater visibility of AI development and help ensure the adoption of appropriate safeguards. There is an opportunity to build on and complement existing policies around compute governance occurring around the globe.

This section looks at the US as a case study. We examine the Biden Administration’s 2023 Executive Order 14110 on Safe, Secure, and Trustworthy AI (“the AI Executive Order”) (The White House, 2023b): outlining the ways in which it progresses record keeping requirements for foreign customers and signals a need for greater verification and enforcement capabilities. We then explore what additional steps might be required to enlist compute providers in administering a more comprehensive compute oversight scheme, and where further research is needed. We highlight the importance of internationalizing a compute oversight scheme, and outline some of the key challenges that need further attention and analysis before this proposal is ready for adoption.

Unlike proposed US foreign customer identification rules for IaaS providers (Federal Register, 2024), we focus on oversight of only frontier AI model development and deployment, rather than all compute use. While we explore these issues in the US context, similar analyses could also be done for other jurisdictions, like the EU, and in the international context. We encourage further policy analysis in this space.

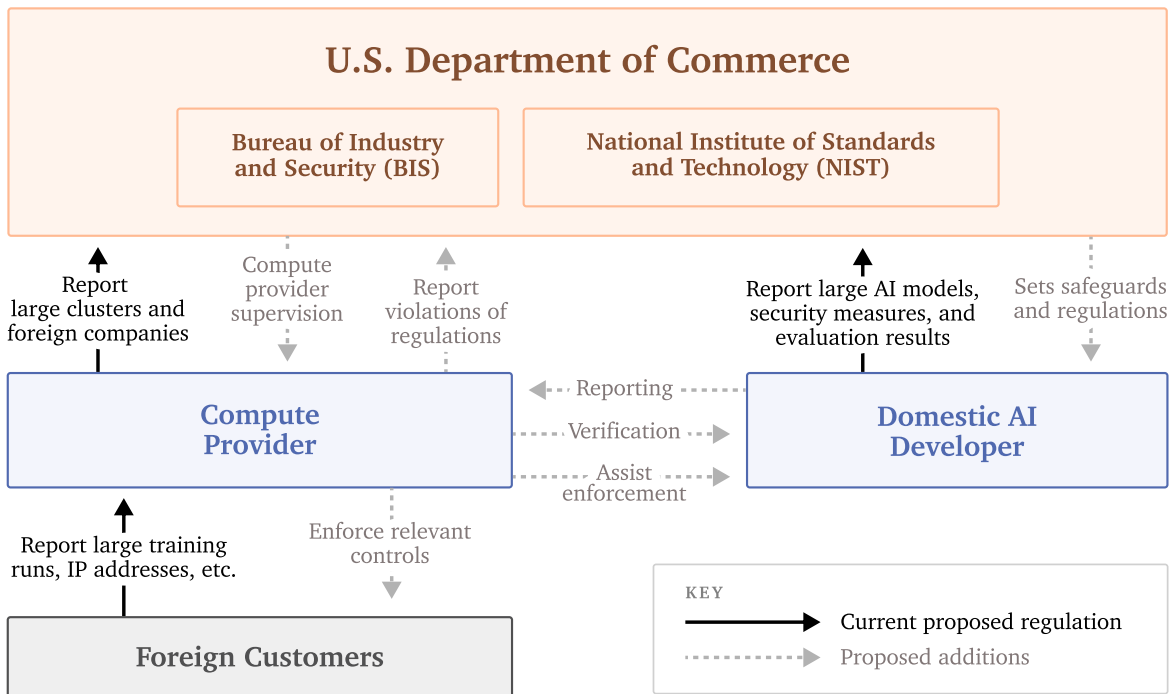

Figure 2: Additional measures, implemented by the Department of Commerce, would strengthen the intermediary role of compute providers and enable a compute oversight scheme.

4.1 Case Study: Compute Providers’ Intermediary Role in the US

4.1.1 Record Keeping and Reporting in the AI Executive Order

The AI Executive Order acknowledges the importance of compute providers in AI regulation, and begins to impose record keeping and reporting requirements. First, under the authority of the Defense Production Act (DPA), it requires firms owning or developing clusters capable of collectively providing more than 10²⁰ OP/s with more than 100 Gbit/s networking bandwidth³² to report its existence and location. Once implemented, this measure would provide the US Government with visibility of the most significant compute infrastructure in the US. While the high reporting threshold will not capture all compute clusters capable of training frontier AI, it will nevertheless be useful in identifying relevant industry stakeholders that would play a role in frontier AI governance.

Additionally, leveraging the powers of the International Emergency Economic Powers Act (IEEPA), the AI Executive Order requires that compute providers identify and report to the Department of Commerce when a foreign person uses their services to train a frontier AI model.³³ The Department of Commerce has proposed rules to implement this that would require US compute providers (and their foreign resellers) to maintain Customer Identification Programs.³⁴

³²Threshold as stipulated by the AI Executive Order. Note it is subject to updates.

³³In this case, models trained on with more than 10²⁶ operations and occurring on frontier infrastructure.

³⁴The proposed rules also require US IaaS providers and their foreign resellers to verify the identities of *all* foreign customers. This broader measure has come under criticism for being ineffective in addressing cyber threats, giving rise to privacy issues, and impacting the competitiveness of US compute provision (National Security Telecommunications Advisory Committee, 2023). This paper does not engage in analysis of this broader measure, and instead focuses on the subsection of compute for frontier AI. As outlined in the introduction, this narrower focus only captures a small number of AI firms and compute providers, which mitigates much of the concern around regulatory burden (see discussion in Section 1.4).

4.1.2 Potential for Verification Capacity

The AI Executive Order offers the potential for compute providers to exercise verification capacities. In a direct sense, the proposed rules would require US compute providers to take a risk-based approach to verifying the identities of foreign customers and their beneficial owners, whether the customer is running a training workload with particular technical properties, and reporting large training runs by foreign customers to the Department of Commerce (Federal Register, 2024). In an indirect sense, the AI Executive Order introduces a range of requirements for AI developers, which will eventually require verification capacities to be effective. For example, AI developers are required to report on the training of large models, the cybersecurity protections taken to secure model weights, and the results from red-team testing according to guidelines developed by the National Institute of Standards and Technology (NIST). While the AI Executive Order does not address how these measures will be verified, compute providers could become governments' natural partners for checking compliance.

The AI Executive Order and the proposed rules for IaaS providers give compute providers a role in *enforcing* regulations—enabling the Government to require the compute provider to prohibit or limit access to an account or an entire jurisdiction—but only when it involves foreign customers with demonstrated patterns of using US IaaS for malicious cyber-enabled activity. There is currently no explicit authority that requires compute providers to stop a foreign customer training a frontier model that might be used maliciously in the future. The existing authorities also would not apply in cases where risks arise from models being developed domestically.

4.1.3 Future Additions

The AI Executive Order lays the groundwork for an institutional structure that could support a compute oversight scheme. Importantly, it begins to build greater AI understanding and regulatory capacity within the US government, establishes clearer government accountabilities for frontier AI governance, and establishes foundational elements of a broader regulatory framework. Yet it falls short of a comprehensive oversight scheme. Additional steps are required to effectively identify and manage emerging risks and enable proportionate oversight of frontier AI development. We outline potential measures to achieve this, including ensuring proportionate information security practices, expanding and streamlining record keeping requirements, enhancing verification roles, and establishing enforcement capabilities.

Ensuring proportionate information security practices — Given the potential risks associated with frontier AI, further work may be warranted to ensure cybersecurity standards are proportionate to risk. Because compute providers are custodians of sensitive data and IP for a broad range of clients, actions they take to improve security will benefit all their AI developer customers and their respective users.³⁵ Further cooperation between industry and government (including bodies like NIST and CISA) is required to consider what cybersecurity standards are most appropriate for entities that hold sensitive frontier AI-related IP. This could be informed by the risk profiles underpinning the cybersecurity standards and practices that are currently being developed by leading AI companies, as per their voluntary White House commitments to manage AI risks (The White House, 2023c).

Expanding and streamlining record keeping — While the proposed rules require US compute providers to keep records on foreign AI developers, significant AI-related risks may also arise from domestic AI development. This may make it appropriate to expand the role of compute providers to also undertake KYC on domestic developers of frontier AI to enable a more comprehensive oversight scheme (Smith, 2023). Under the AI Executive Order, domestic AI developers are themselves accountable for reporting their own frontier training runs to the Department of Commerce. Using the compute provider to collect information that could then be used to validate these processes would help improve their effectiveness and ensure compliance. In this way, KYC could be implemented as a cohesive scheme, drawing on lessons from the financial sector (Egan & Heim, 2023).

In addition to using training compute thresholds, other measures should be employed to create a more precise risk-management system. The current 10²⁶ operations threshold minimizes regulations on existing systems while capturing next-generation models that may pose significant dual-use risks. However, below-threshold compute could also be relevant in identifying problematic trends

³⁵Note, however, that strong cyber security at the infrastructure level alone is insufficient. AI firms will still need to implement and maintain strong cyber security practices on their own systems (Section 3.1).

(e.g., from entities in particular geographic regions) and entities trying to break up workloads over multiple compute providers (Heim & Egan, 2023). Furthermore, the threshold should be constantly re-evaluated as frontier AI evolves and algorithmic innovations reduce the cost of training powerful systems and if our understanding of how to predict risks from compute in particular systems grows (Pilz et al., 2024). On the training side, indicators like training data (similar to the biological sequence data criterion referenced in the AI Executive Order), the architecture of the AI model, or the way training is conducted could all be useful proxies for identifying risk levels from new AI systems. On the deployment side, which does not currently fall under the purview of the AI Executive Order, factors like the use of customer data (e.g., voice or images), the scale of deployment, the level of access to the outside world (e.g., via the internet or physical effectors), and the ability to act with limited direct supervision could be used to set a range of regulatory thresholds (Shavit et al., 2023). Developing more nuanced thresholds, beyond blunt compute capacity and usage, will require further research and collaboration between government, compute providers, AI developers, and broader civil society.

Enhancing verification roles — There is an opportunity to leverage compute providers’ verification capabilities to help ensure both foreign and domestic AI developers are complying with AI safety standards and requirements. The AI Executive Order requires AI developers to report the total amount of training compute and whether biological sequence data was used to train their frontier models, as well as the outcomes of safety testing. However, there are presently no verification methods specified for these requirements. The ability of compute providers to capture insights from the metrics described in Section 3 could enable verification to be performed while minimizing privacy tradeoffs. For example, rather than reporting all metrics to the US government, compute providers could instead only report when they have reasonable grounds to suspect a violation of regulations or standards has occurred. Verification mechanisms will need to be resilient against evasion and exploitation. For example, privacy-preserving information sharing between compute providers could be used to help identify and manage attempts to break training runs down into smaller segments, or to obfuscate compute utilization patterns. As regulatory frameworks develop, there may be an opportunity for compute providers to play a role in advancing both responsible training requirements for frontier model developers, including notification and use of secure infrastructure, and pre-deployment safeguards, for example by requiring frontier model providers to demonstrate they have government approvals prior to placing a model on the market. Such approvals could be made contingent on the evaluation of highly capable models to a specified standard (O’Brien et al., 2023).

Privacy protections could also be aided by the application of confidential computing standards, which technically limit the ability of compute providers to ‘look in’ at sensitive data (IBM, 2024; OpenMined, 2023). Further work is required to explore the possibilities of data verification in a privacy-preserving way, particularly mechanisms to identify when a developer is using biological sequence data.

Establishing enforcement capabilities — To effectively leverage compute providers in an intermediary enforcement role, the US government would need to implement additional authorities and requirements for them to effectively halt training runs or deployment in response to violations of set controls and safety standards. Such authority could be linked to a comprehensive regulatory scheme with components such as developer licenses, training risk assessments, pre-deployment risk assessments, and the monitoring of criminal activity through models after deployment (Anderljung et al., 2023a), supplemented by a process for appeal and corrective action. To draw parallels from other industries, financial and aerospace regulators use a range of factors, like customer risk profiles, track records, and company practices, to evaluate the level of oversight necessary. AI developers with a pattern of risky behavior may warrant stricter oversight in order to purchase computing power. The ability to deploy an AI model at a large scale may also be linked to model licensing and proper privacy and safety precautions on the part of the compute customer in the future.

Once appropriate authorities have been established, there are several ways compute providers could help enforce rules. It could be desirable to be able to prevent or pause runs if the total amount of compute used exceeds the limit permitted by present approvals, if deployed models are actively causing harm, or if the developer is on the Entity List. Compute providers already have the ability to ration or cut off compute access to their customers. Therefore, key work that will need to be done here includes:

1. establishing formal rules for when AI developers can and cannot access compute at a particular scale,
2. creating formal channels of communication between compute providers and regulators, and
3. clearly establishing respective roles and authorities between government and industry.

4.2 Regulating the Compute Providers Themselves

For compute providers to effectively contribute to AI regulation downstream, they themselves also need to be subject to appropriate oversight and compliance measures. They are both intermediaries and agents: they act as pass-throughs that offer computing power (in the form of hardware, often acquired from other firms) to AI developers, and they make autonomous choices on pricing, select customers, and provide differentiated services.

The AI Executive Order requires that compute providers declare the existence and location of large-scale compute clusters, and the total amount of computing power available in each cluster. Ad hoc investigations and spot checks would help ensure compute providers are incentivized to prioritize this obligation. A chip registry, where policymakers mandate the reporting of the sale and transfer of cutting-edge AI chips, could also help ensure compliance (Fist et al., 2023; Fist & Grunewald, 2023; Sastry et al., 2024). But the need to verify compute provider compliance would be significantly heightened should they take up the key role of screening AI developers. Ongoing training and government and industry engagement could help ensure expectations are clear and requirements are met in a way that minimizes regulatory burden. Additional government capacity would likely be required to ensure appropriate spot checks and investigations can be carried out. To help ensure compute providers play an appropriate role in providing secure infrastructure and advancing verification and enforcement, there may also be a role for the licensing of compute providers themselves, similar to the way in which operators of critical infrastructure are licensed in other domains (Australian DITRDCA, 2024; California Energy Commission, 2024; OFWAT, 2024). Ensuring that government-established regulations are upheld and not tampered with will be key.

In cases where the compute provider and AI developer are the same firm or linked by a close partnership, additional steps should be considered. These arrangements are common for many leading AI companies, which either build AI data centers for their own products, for example, Google, or maintain close financial ties with their compute providers, like OpenAI with Microsoft and Anthropic with Amazon. The strength of these ties has prompted recent antitrust concerns: in January 2024, the US Federal Trade Commission began an inquiry into these partnerships (Ward & Hu, 2024). In such cases, there are unusually strong incentives to collude on false reporting, as rapid progress in AI development is in both entities' financial interests. This warrants additional external scrutiny and reporting. A whistleblower scheme could assist in identifying and addressing noncompliance, but in the longer term, prudential regulations may be needed to create an accountable compute ecosystem and ensure that providers are fit for acting as regulatory pass-throughs. Compliance with these regulations could be linked to maintaining operating licenses or accessing cutting-edge AI chips. These rules should ensure sufficient independence between compute providers and their customers, and that advanced AI and compute capabilities are safeguarded and accessed in an equitable manner. Steps to limit the partnerships that create the strongest incentives for collusion, including via antitrust law, could also help ensure proper oversight. In many industries, there are restrictions on how platform providers may operate on their own platforms, as such operations can involve anti-competitive market practices; a similar approach may mitigate unfair practices in the cloud computing market.

4.3 Domestic Government Capacity

Given the strong public interest in managing the risks of frontier AI, a robust government involvement will be key to the success of an oversight scheme (Anderljung et al., 2023a). Building on existing efforts, the US could establish a centralized authority within the Department of Commerce responsible for AI risk management and engagement with compute providers and AI developers. Locating both industry opportunity and risk management within the same department, alongside other AI-relevant agencies like NIST, will help enable a holistic, proportionate approach to frontier AI controls. It could also support alignment with the Department's Bureau of Industry and Security's (BIS) work on compute hardware controls, which leverages channels of engagement with similar stakeholders.

This authority should work closely with industry, researchers, and other government stakeholders to ensure a holistic approach to AI governance.

Additional regulatory and legislative authority will likely be required. The IEEPA provides the US government with broad abilities to control transactions with foreign persons in circumstances where the President declares a National Emergency (Congressional Research Service, 2024). This could provide the power for scrutiny and enforcement against *foreign* persons accessing US compute, but the requirement to maintain a constant state of ‘national emergency’ for these rules to apply could be criticized as government overreach (Boyle & Lau, 2021). The government is also limited in its ability to effectively utilize compute providers as a node for domestic oversight. While the DPA allows the government to require information from companies to undergo industrial base assessments, this falls short of establishing ongoing channels of information sharing and verification, and there are currently no clear mechanisms for checking compliance. The development of new legislation should involve thorough consultation with industry and affected stakeholders, as well as international counterparts.

4.4 International Coordination

A harmonized international approach will be essential for the success of a comprehensive compute oversight scheme: both to manage complex cross-jurisdictional oversight and privacy issues, and to minimize the risks of customers and businesses relocating to other jurisdictions to avoid regulations. International standards that preserve privacy and confidentiality should be explored as key components of the solution.

Cross-jurisdictional oversight issues — Existing cross-jurisdictional data, privacy, and oversight issues associated with compute providers with a global presence will be amplified in the context of AI compute oversight. Many large compute providers employ globally distributed data centers to enable low-latency international service provision and resilience to local disruptions. For example, while headquartered in the US, major compute providers like Microsoft and AWS have data centers spread across many regions and jurisdictions (AWS, 2024c). However, this distributed architecture can result in contradictory local and domiciled regulatory requirements. This has been evident in the law enforcement context, with the US enacting the Clarifying Lawful Overseas Use of Data (CLOUD) Act in 2018 in response to impositions on its ability to access data from US compute providers when that data was stored in a foreign data center (Rep. Collins, 2018).

In the context of AI compute providers, cross-jurisdictional oversight is of particular sensitivity, due to both the commercial value of frontier AI model weights, as well as the strategic significance of AI. With both the US and China actively competing to be the world leader in AI (The White House, 2023b), there would be strong incentives for states to misuse any access they may attain through a compute provider oversight regime. For example, China’s 2017 National Intelligence Law stipulates that PRC citizens and corporations must assist with China’s national intelligence efforts, if directed (China Law Translate, 2017), and in 2022, the US government used its powers under the Foreign Intelligence Surveillance Act to order Microsoft to give it access to between 42,000 and 43,996 accounts (Microsoft, 2022). This creates a low-trust environment that could diminish the competitiveness of compute providers in countries that have oversight regimes and diminish international support for such a scheme.

Privacy-preserving standards — To support international cooperation on mutually beneficial AI safety oversight, compute providers could play a leading role in working with governments to establish privacy-protecting compute provision norms and standards. The need to balance private interests with state interests, and security with privacy, is not new. In 2017, Microsoft proposed making major technology companies akin to a ‘Digital Switzerland’ – refusing to side with governments in any cyberattack and instead upholding a neutral and trusted environment (Smith, 2017). However, in 2022, major technology companies took an active stance in response to Russia’s invasion of Ukraine: Microsoft played an active role in defending Ukrainian government systems and networks (Farrell & Newman, 2023) and SpaceX immediately provided Ukraine with free access to its Starlink satellite networks (Jones et al., 2023). This has demonstrated a growing willingness of private technology companies to play an active role in geopolitics and this shift showcases the limitations of voluntary rules and norms (Farrell & Newman, 2023). In this environment, technical solutions could be key to establishing the trust and reliability necessary for customers to trust internationally-owned compute providers in the context of an oversight scheme. In particular, confidential computing techniques

(Confidential Computing Consortium, 2022) could ensure compute providers cannot be compelled by governments to hand over sensitive data (Section 3.3.4).

Notwithstanding privacy-preserving standards to protect sensitive customer data, requirements for compute providers to report on customers in foreign jurisdictions will raise significant interjurisdictional privacy challenges. Even between close partners like the US and EU, privacy protections have already come into conflict with free data flows across jurisdictions. For example, the EU-US Privacy Shield (European Commission, 2016) and its predecessor, the International Safe Harbor Privacy Principles (EU Agency for Cybersecurity, 2000), designed to allow data sharing between the EU and US, were both overturned by the European Court of Justice because of their failure to appropriately uphold EU citizens' privacy rights (BBC, 2020). Their replacement, the 2022 EU-US Data Privacy Agreement, is also under scrutiny, with privacy groups announcing their intention to contest it in court (Kim, 2023). Unilateral US action to require reporting on foreign compute customers will likely evoke similar privacy challenges that could inhibit US compute providers' abilities to serve global customers. To manage privacy issues with close allies, the US could develop tailored agreements that enable its oversight requirements to be met through compute providers reporting to the government of the allied country within which their customer is domiciled. This could be made contingent on some level of information exchange between the US and partner government. It could also serve to incentivize uptake of a consistent scheme amongst like-minded countries. We encourage further research to explore these issues in more depth. Ultimately, to be successful, a comprehensive compute oversight scheme will need to incorporate and gain a multilateral agreement for privacy protections that balance privacy and national security.

Consistent international approaches — Unilateral action by any one country—even those with a significant IaaS market share like the US—also risks incentivizing compute providers and customers to shift to lower regulatory environments. This could erode the market share of jurisdictions with greater oversight, diminishing the ability of governments to oversee and address emerging risks (Egan & Heim, 2023). The already broad geographic spread of major compute providers' data centers, and the ability to access them remotely, could potentially enable the global compute market to be more easily restructured. Unilateral action would also push malicious actors and high-risk projects into jurisdictions with lower scrutiny, thereby undermining efforts to increase AI safety. Achieving the greatest consistency possible across international jurisdictions will be key to ensuring that efforts to increase oversight are effective and robust to evasion.

Ultimately, given the global nature of the compute industry, some form of international agreement will be needed for monitoring and verification frameworks to be durable. International compute oversight coordination could be developed in a similar form to the Financial Action Task Force, which currently works to achieve international consistency in the application of anti-money laundering and counter-terrorism financing (AML/CTF) safeguards and regulations (Financial Action Task Force, 2024b). A similar body for compute oversight could facilitate information sharing and help align regulatory approaches and enforcement between international jurisdictions (Egan & Heim, 2023). Yet, while a majority of jurisdictions have strong shared incentives to combat organized crime and terrorism financing, there is a risk of differing incentives in the compute oversight context. Some states, particularly those skeptical of AI-related risks, may actively promote lower regulatory environments in an attempt to attract economic activity and investment – similar to how Ireland has used low corporate tax rates to successfully attract multinational corporations to be domiciled there (Alderman, 2021). Initiatives seeking to build a shared understanding of AI-related risks, like the 2023 UK Safety Summit (UK Government, 2024), will continue to be important for strengthening alignment on compute issues. Many countries, for example, India, UK, and Japan, are also exploring options to build greater sovereign compute capacity (Government of India, 2023; Nagao, 2023; UK Research and Innovation, 2023). This increasing self-reliance could lower interest in common international approaches that might impact national goals. Ensuring international buy-in to a compute oversight scheme would therefore require substantial diplomatic engagement alongside broader economic incentives.

International compute oversight could be advanced through a “club approach” (Trager et al., 2023) that predicates access to cutting-edge chips on adherence to the scheme. As the US, in partnership with its allies, currently has a chokehold on the manufacturing of the advanced chips needed for frontier AI compute (Allen et al., 2023), it could restrict exports to jurisdictions that are unwilling to implement appropriate oversight measures. Just as unimpeded access to the US banking system is conditioned on a jurisdiction's compliance with FATF standards and regulations (Farrell & Newman, 2023;

Financial Action Task Force, 2024a), so too could access to advanced AI chips require adherence with established compute oversight standards (Sastry et al., 2024). There would be significant risks with this approach that require further analysis. For example, the club approach could significantly impact the US semiconductor industry and diminish US technology leadership. Its success is also predicated on the US and aligned partners maintaining the lead in advanced chip hardware. But if carefully implemented with enough international consultation and engagement, it could provide incentives for a broader range of countries to opt into the scheme.

Even in the context of narrower oversight clubs, there is a benefit in supporting global standards on how compute provider governance in general can support AI oversight and regulation. A key challenge will be supporting cooperation between geostrategic rivals like the US and China, as the strategic significance and dual-use capabilities of AI incentivize strong competition. However, the foundation for increased cooperation is already being established: both the US and China attended the 2023 AI Safety Summit and signed the Bletchley Declaration foreshadowing greater cooperation on safety issues (Prime Minister's Office et al., 2023), and the US and China have also bilaterally agreed to work together on mitigating AI safety risks (Murgia, 2024).

International cooperation could be further strengthened by centering compute governance issues in G7 and G20 discussions – bringing together major economic players to agree upon shared priorities in this space and building on existing agreements to cooperate on AI governance (The White House, 2023d). Engagement with large regional bodies like the Indo-Pacific Economic Forum, the Association of Southeast Asian Nations (ASEAN), and the Africa Union (AU), could encourage buy-in for compute oversight harmonization. Working with global and regional banks may also help unlock options to link involvement with funding and investment.

The details of an international harmonization scheme require further research, consultation, and analysis. Further work is needed on issues of verification and enforcement between countries. Nevertheless, we encourage policymakers to give greater consideration to the need for cooperative compute provider governance in international discussions, as a first step in working toward a mutually beneficial scheme.

5 Key Challenges

While certain technical and institutional capabilities for conducting infrastructure governance already exist and could be employed, many areas still require further research to ensure robustness and scalability. Furthermore, as compute becomes an increasingly important resource in the global economy, regulators will need to make sure that access to compute is equitable, competitive, and privacy- and confidentiality-protected. Regulation also needs to strike the right balance with public safety as AI capabilities develop, ideally with differentiated regulatory levers that enable specific and nuanced policies. Below, we present some key technical and governance challenges that should be explored in the near term. The general challenges and considerations of using compute as a policy lever are discussed in Sastry et al. (2024) and are applicable here.

5.1 Technical Challenges

Variation in workload signatures due to changes in algorithms and hardware at the frontier.

Certain signatures (e.g., network bandwidth utilization, AI accelerator core utilization) could be used to classify customer workloads. However, these signatures depend on the model architecture and training algorithm used to train frontier models, which will likely change over time (Rabinovitsj, 2023).³⁶ Additionally, algorithmic progress within one type of model (e.g., utilizing AI accelerators more efficiently) would also change aspects of this signature. In order to ensure that infrastructure governance measures are effective, regulators and compute providers need to be kept aware of how the state-of-the-art algorithms and hardware are changing; classification techniques need to be updated over time to track these advancements.

Methods for workload classification that are robust to adversarial gaming.

In addition to this natural variation in workload signatures, adversarial actors may attempt to circum-

³⁶For example, techniques to reduce the memory footprint of training are an active area of research (e.g., (Dettmers et al., 2022)).

vent detection by intentionally changing the computational pattern³⁷ of their workload.³⁸ Compute providers will have to develop classification methods that are robust to deliberate obfuscation and adopt red-teaming techniques to check against these attacks. These changes could be much smaller and more unpredictable than the natural variation of algorithms, so these gaming techniques need to be anticipated prior to deploying the classification scheme.

Preventing evasion by structuring training runs across multiple data centers or compute providers.

As with money laundering techniques observed in the financial industry, malicious customers may split their workloads (e.g., training runs) across multiple data centers or compute providers to evade regulations (a practice described as “structuring” in the finance industry (Sanction Scanner, 2024)). Regulators and compute providers will have to develop and constantly update technical and governance methods to prevent evasion. Over time, techniques for avoiding detection will evolve, as will more sophisticated approaches to detection. This should become an active and resourced area of technical governance research.

Detecting training runs distributed across the data centers of a single provider is relatively straightforward due to the provider’s consolidated insight into infrastructure and relevant customer metrics. However, when workloads are distributed across multiple providers, compute providers face significant challenges in consolidating data for analysis. Yet, in practice, the number of providers capable of delivering the requisite level of compute for high-risk models is limited (Richter, 2024). This issue can be addressed by a technical framework that facilitates the secure and privacy-preserving information exchange between compute providers—being mindful of the commercial sensitivities and potential antitrust implications associated with sharing details about training runs and other client data.

Moreover, the strategic implementation of a compute threshold (Pistillo et al., forthcoming) could serve as a deterrent against “structured training” practices. Next-generation AI models generally necessitate an order of magnitude more training compute than their predecessors to achieve meaningful advancements in performance.³⁹ A compute threshold set slightly above the current models, for example, the one used in the AI Executive Order, reflects the reality that future, more advanced models will not just require marginal incremental compute increases but rather an exponential scale-up (usually an order of magnitude). Practically, this leads to the necessity of involving more than ten compute providers to distribute the workload sufficiently to circumvent the threshold. This requirement imposes substantial logistical and performance challenges. Simply identifying more than ten compute providers with sufficient compute capacity over which to structure a workload is a formidable challenge, and doing so without detection is even more difficult. Furthermore, next-generation models—given the exponential increase in training compute—increase the challenges even further. Should the exponential scaling of training compute persist, it would necessitate a proportionally exponential increase in the number of compute providers involved, exacerbating the challenges even further.

Using privacy-preserving technologies for detailed workload verification.

Emerging privacy and verification mechanisms such as trusted execution environments and proof-of-training may allow multiple parties to cooperate without the risk of exposing confidential or sensitive information to each other. For example, a compute provider, data provider, and software provider could cooperate in a mutually beneficial training run without needing to share trade secrets

³⁷A customer might attempt to hide the fact that they are engaging in AI training by using non-standard number representations, affecting traffic to/from outside networks, or deliberately using less efficient algorithms with different workload characteristics, such as under-utilizing memory or computation. However, the more a customer attempts to disguise workloads in this fashion, the greater the cost in terms of lost efficiency. In the context of frontier model training, where a single workload can cost tens of millions of dollars, perhaps these losses could be significant enough to make many forms of obfuscation too costly.

³⁸In the event of adversarial actors attempting to obscure their activities, it should be noted that such gaming of the system typically comes at a cost, potentially affecting the efficiency or performance of the AI system being trained. Compute providers and regulators will need to consider whether the penalties for non-compliance are substantial enough to deter such behavior, weighing if the cost of circumventing outweighs the cost of compliance.

³⁹Scaling laws suggest that achieving substantial enhancements in performance on downstream tasks necessitates exponential increases in training compute. This principle underscores that compute investments grow exponentially for comparatively linear improvements in task performance (Owen, 2024).

or personally identifiable information, producing a tamper-evident and privacy-preserving training record that can be later scrutinized by a verifier. More work is needed in this area to develop robust hardware mechanisms and algorithmic techniques that can provably account for and verify aspects of compute usage. Any methods of de-identifying personal or confidential data for such exercises must be robust enough to meet the standards imposed by key privacy laws, such as the EU GDPR, to avoid personal data breaches or privacy conflicts.

Creating a robust customer identification scheme.

Work must be done to robustly link cloud accounts to particular individuals and entities. This is needed for key functions like liability tracing, developer licensing, export control enforcement, and defending against “structured” training runs where an adversarial actor distributes its workload across multiple compute providers. Furthermore, advances in AI may continue to increase the challenge of verifying customers’ identities. For example, websites are already claiming to use neural networks to generate photos of highly plausible fake IDs, (Cox, 2024) which could potentially be applied to generate fake business documentation.⁴⁰ This issue is not unique to compute provider oversight and would need to be addressed on a broader scale to investigate how AI could help facilitate fraud, money laundering, and other criminal activity.

However, as discussed in Section 1.4, customer identification within the context of frontier AI predominantly involves a limited number of entities, primarily large-scale corporations. Rather than necessitating widespread identification efforts, our focus is on conducting thorough verifications for this select group, ensuring that these in-depth analyses are both effective and targeted.

Challenges from technological developments.

The utility of compute providers as intermediary regulators is supported by the need for significant computational resources for the training and deployment of frontier AI models (Sastry et al., 2024). While current compute and AI trends appear to reinforce the primacy of large-scale compute for such models, a variety of technical developments may challenge this norm (Heim, 2024; Pilz et al., 2024; Sastry et al., 2024). It will be important to ensure that compute governance policy is complemented by research into other effective mechanisms for AI governance.

5.2 Governance Challenges

Maintaining equitable access.

Increasing regulatory requirements on both compute providers and customers can increase the barriers to entry, preventing smaller, less well-resourced actors from entering the market. This risks intensifying power concentration among hyperscalers. Key challenges include making legislation legible, ensuring that secure implementation methods are accessible, and striking a balance between safety and regulatory burdens at various threat levels. For example, the technical tools needed for compute verification should be accessible to potential providers. Regulatory agencies, such as NIST, can play a role in determining standards and facilitating open-source solutions.

Strengthening regulatory structures for in-house compute.

Many AI developers currently operate their own data centers for training and deploying AI systems. This provides additional challenges for oversight. Since the AI developer and the compute provider are essentially the same entity, they may be incentivized to collude, weakening the *verification* and *enforcement* capabilities provided by an independent compute provider. In such cases, prudential regulations, whistleblower schemes, or even direct inspections by the regulator may be necessary to ensure adequate supervision. Experience may be drawn from the financial world, where regulators face a similar challenge with corporations running their own banks (Consumer Financial Protection Bureau, 2023). More work should be done on developing both regulatory and technical tools that enable robust and low-cost oversight in these situations.⁴¹

Ensuring compliance with privacy commitments and related laws on privacy and data transfer.

Although we discussed privacy-preserving methods to perform compute accounting and workload classification, it is critical that any implementation of an infrastructure governance scheme is in

⁴⁰The complexity of verification processes is further increased by the diversity of national ID and business registration regulations when considered in an international context (e.g., India has more advanced ID verification systems than other countries (India’s Ministry of Electronics and Information Technology, 2023)).

⁴¹E.g., zero-knowledge proofs that regulators can trust to verify compute usage without having direct access to data centers or sensitive data.

compliance with existing privacy laws and commitments (e.g., that personal data is not processed for purposes beyond that for which there exists a solid legal basis). There may also be issues surrounding international application for foreign privacy law. For example, if US providers are required to collect information on customers in the EU, the US government is likely to face similar challenges from EU institutions, member states, civil society, and US companies who have long dealt with EU-US data transfer legal uncertainties caused by US national security data collection and Schrems legal challenges regarding such collection for the past decade. In the long-term, there also needs to be a conversation about how to balance privacy commitments with public safety, differentiating between AI systems with varying risk levels.

Preventing regulatory flight across borders.

We have outlined international harmonization as a key step to minimize the risk of compute providers and AI developers and deployers relocating their businesses or simply moving their workloads to jurisdictions with lower regulatory standards. However, further work is needed to explore the most effective mechanisms for supporting broad buy-in to a coordinated regulatory scheme, as well as effective approaches for incentivizing businesses to remain in higher-regulatory environments. This work would be aided by analysis on the elasticity of the global compute and AI markets, and the extent to which businesses will attempt to avoid oversight measures.

6 Conclusion

As governments move to take action on addressing AI risks, compute providers can play a key role in ensuring regulations are upheld and enforced. Their concentrated role in the AI supply chain allows them to use record keeping, verification and enforcement capabilities to help secure sensitive AI-related IP and data, engage in greater oversight of emerging AI risks, provide post-incident attribution and forensics, prevent bad actors from training frontier AI models, and ensure AI developers adhere to set standards. In this way, they have the ability to act as *securers*, *record keepers*, *verifiers*, and *enforcers*.

Implementing this regulatory model in a way that preserves privacy and enables innovation will be key. Our analysis indicates that selected mechanisms of these governance capabilities are technically feasible and possible to implement in a privacy-preserving way. However, further work is required to ensure such a governance model remains resilient to evasion efforts, and to further refine particular technical mechanisms and standards that preserve privacy and innovation while allowing sufficient oversight. Greater oversight would also be required of the compute providers themselves. This will require close collaboration between compute providers, governments, and the research community.

When scaled internationally, this governance model has the potential to support global AI governance architecture. International coordination will be essential for addressing cross-border oversight and data issues, as well as to reduce the risk of compute providers and AI developers relocating to lower scrutiny jurisdictions.

Using compute providers as intermediary regulators will be most effective at addressing risks arising from large-scale AI training and deployment, rather than all AI-related risks. Moreover, the viability of compute as a governance node may be challenged by developments in hardware and software, which could reduce the need for large-scale data center usage (Sastry et al., 2024; Pilz et al., 2024). These proposals should therefore be complemented by other regulatory measures as required.

Compute providers can play a key role in a governance regime that protects privacy and innovation, while ensuring sufficient oversight to mitigate critical AI-related risks. We urge policymakers, regulators, compute providers, and the research community to work together on the next steps.

Acknowledgments

We would like to express our thanks to the people who have offered feedback and input on the ideas in this paper, including Aris Richardson, Boxi Wu, Christian Troncoso, Christoph Winter, Christopher Hoff, Chris Phenicie, Hadrien Pouget, Haydn Belfield, Keegan McBride, Konstantin Pilz, Maia Hammin, Markus Anderljung, Mauricio Baker, Owen Larter, Pam Dixon, Peter Cihon, Trey Herr, and Zaheed Kara.

We thank Beth Eakman for copy editing and José Medina for formatting assistance.

OpenAI’s ChatGPT and Google’s Gemini Advanced were used for editing assistance throughout this paper.

A Overview of Compute Provider Technologies

AI computing infrastructure is typically provided through “data centers”, buildings designed to power, house, and operate large amounts of computing hardware. AI data centers contain many “servers,” computers optimized for AI computational workloads (we abstractly refer to servers as “nodes” in Section 3).⁴² Each server contains a variable number of CPUs (general-purpose processors), AI accelerators (specialized AI processors such as GPUs and TPUs), networking to allow these devices to communicate, and shared data storage (Figure 13). A relatively large number of AI accelerators, and the capacity for those devices to communicate at high speed, are the primary attributes differentiating AI data centers from other kinds of data centers.

AI accelerators contain many “cores,” sub-processors that are optimized for simple, parallel computation. AI accelerators reach high throughput as measured by operations per unit time due to both the number of cores and the capability of these cores to perform “vector processing”: simple math operations on an entire array of numbers in a single step. Contemporary deep learning workloads are efficiently implemented in software using matrix multiplication, and the vector processing hardware is an efficient mechanism for computing these matrices. Different types of cores may exist within a single AI accelerator, where each type is optimized for handling different types of instructions or input data, such as graphics and video games, or mixed-precision operations beyond simple parallel operations such as matrix multiplication.

The primary goal of a compute provider is to map customer requests for compute (in the form of workloads or “machine instances”) to physical hardware resources efficiently: achieving high utilization of the (expensive) hardware while maintaining security and high performance. To achieve this, providers typically provide “virtualization.” This means dynamically creating virtual (rather than physical) versions of the hardware within a server, each with their own operating system and software, and isolated code and data. These virtual servers are often referred to as “instances,” and are used to partition physical hardware resources (e.g., cores, storage) to be efficiently shared across separate computational workloads and different customers. For the purposes of the kinds of workloads considered in this paper (large-scale AI workloads run on dedicated single-tenant infrastructure), sharing resources across workloads rather than customers is more relevant. Virtualization exists in part to subdivide a provider’s physical hardware resources, but also as a mechanism to isolate the provider from the customer. In cases where the tenant is the sole tenant of a server, two options exist: the provider can manage the server in the form of a hypervisor layer to provide services such as additional security, networking configuration, and software management through an API, or the provider can provide a “bare metal” instance to the customer, in which case the customer is responsible for all software. Even in the bare metal instance, the provider maintains control over their network.

On the software side, customer code is often run in combination with or on top of a standardized set of software packages such as frameworks and APIs provided by the infrastructure provider, set up by default on each instance. Code for a particular workload (e.g., training a model) is orchestrated by the CPU, which schedules tasks to run on AI accelerators. The main code executed on an AI accelerator is “compute kernels,” small programs written to execute a specific computational task on a core, typically involving operations on matrices. Compute kernels are often provided by AI

⁴²Typically a node and a server are equivalent, but “server” refers to the physical hardware, while a “node” is a unit of computational resources within the cluster’s infrastructure.

AI Data Center

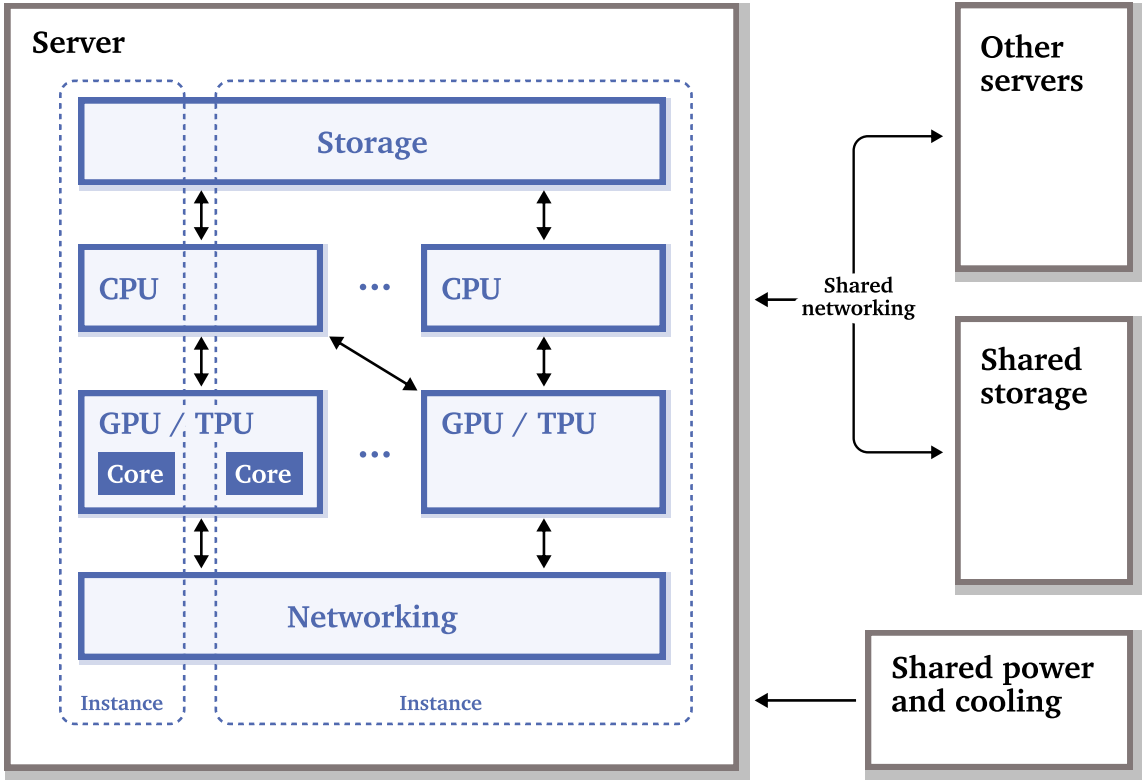

Figure 13: A logical diagram of the software and hardware components and interactions in an AI data center. A user provides their AI code and data, interacting with a software stack that differs depending on provider infrastructure but inherently includes the hardware interactions depicted above. A server can be partitioned into virtual instances, where each instance has a fraction of the physical resources: CPU, GPU/TPU, networking, and storage.

accelerator firms (e.g., NVIDIA’s CUDA library) or generated by a compiler (e.g., Triton), with support for customers writing their own custom kernel. AI accelerator firms also generally provide performance monitoring and debugging tools, which measure various aspects of an AI accelerator’s performance, such as which cores are active, whether the cores are running at full capacity, and the amount of data being transmitted to/from the AI accelerator’s memory. Typically these tools rely on hardware-based “performance counters,” which track different metrics on the AI accelerator.

The infrastructure provider runs management and scheduling software, which accepts customer requests and issues new instances to the customer, and allocates available hardware resources to workloads based on their computational requirements. In tandem, another software system monitors and maintains the cluster, tracking machine health (power consumption, temperature, network status, etc), and yet other software. This management software allows infrastructure providers to track which resources are being used by which customers, and bill customers for the resources they are using.

B Observable Data Attributes

Table 4: An overview of observable data attributes.

Visible attribute	Uses	Involves collection of data not already widely collected?	Ease of implementation	Ease of circumvention
Hardware configuration requested by the customer	<i>Workload classification.</i> The quantity of AI accelerators requested and networking setup are strongly suggestive of the workloads a customer intends to run.	No, already collected.	Already collected by compute providers to set up and provision infrastructure.	Highly difficult or impossible.
Number of hours that resources (e.g., AI accelerators) are in use	<i>Workload classification, compute accounting.</i> Allows high-level boundary setting on workload type/size.	No, already collected.	Already collected by compute providers for billing purposes.	Highly difficult or impossible.
Power draw	<i>Workload classification, compute accounting.</i> Allows high-level boundary setting on workload type/size, as increased power draw corresponds to increased throughput for a particular device. Power consumption over time may allow differentiation of inference from training (Patel et al., 2023).	No, already collected.	Possible to collect using existing tooling. Already collected by some compute providers.	Possible, but would involve substantial cost efficiency penalties.
Network bandwidth between AI accelerator servers	<i>Workload classification, compute accounting.</i> Large AI training workloads require high bandwidth between servers. Different communication patterns correspond to different kinds of workloads, and bandwidth utilization is related to the quantity of computation performed on each server.	No, already collected.	Possible to collect using existing tooling. Already collected by some compute providers.	Possible, but could involve substantial cost efficiency penalties.
Network bandwidth within AI accelerator servers	<i>Workload classification, compute accounting.</i> Different bandwidth patterns correspond to different kinds of workloads, and bandwidth utilization is related to the quantity of computation performed within each server.	No, already collected.	Possible to collect using existing tooling. Already collected by some compute providers.	Possible, but could involve substantial cost efficiency penalties.

Continued on next page.

Table 4 – Continued from previous page.

Visible attribute	Uses	Involves collection of data not already widely collected?	Ease of implementation	Ease of circumvention
AI accelerator core & memory bandwidth utilization	<p><i>Workload classification, compute accounting.</i></p> <p>Large AI workloads typically have high memory bandwidth utilization, and core utilization will tend to be constant for training, while inference is typically variable.</p>	No, already collected.	Possible to collect using existing tooling. Difficult to collect for bare-metal services.	Possible, but could involve substantial cost efficiency penalties.
Performance counters by numerical precision	<p><i>Workload classification, compute accounting.</i></p> <p>Lower precision is common in AI workloads and allows differentiation from most scientific computing workloads and possibly gaming. Counters also provide a direct measurement of operations consumed by a workload.</p>	Potentially. This degree of telemetry on an individual customer is unusual. Policies for collection and analysis would need to be clearly outlined in provider's terms of service.	Possible to collect using existing tooling. Difficult to collect for bare metal services.	Possible, but could involve moderate cost efficiency penalties.
Modification of weights in memory	<p><i>Workload classification, compute accounting.</i></p> <p>Model training requires changing the weights in memory using a backward pass. Typically the only large data structures in memory are the weights and activations, so it should be possible to observe whether stores are made to that region of memory. The magnitude and frequency of memory updates are related to the quantity of compute consumed.</p>	Potentially	Not currently possible.	Difficult: training requires modifying weights in memory to be highly performant.
Workload hyperparameters	<p><i>Workload classification, compute accounting, detailed workload verification.</i></p>	Yes. Can potentially be made privacy-preserving using confidential computing techniques.	Possible to collect with customer consent.	Unclear (highly dependent on implementation).

Continued on next page.

Table 4 – Continued from previous page.

Visible attribute	Uses	Involves collection of data not already widely collected?	Ease of implementation	Ease of circumvention
Training dataset	<i>Workload classification, compute accounting, detailed workload verification.</i>	Yes. Can potentially be made privacy-preserving using confidential computing techniques.	Possible to collect with customer consent.	Unclear (highly dependent on implementation).

References

- Aarne, O., Fist, T., and Withers, C. Secure, Governable Chips. Technical report, Center for a New American Security, January 2024. URL <https://www.cnas.org/publications/reports/secure-governable-chips>.
- Abbott, K. W., Levi-Faur, D., and Snidal, D. (eds.). *Regulatory intermediaries in the age of governance*, volume 670 of *The Annals of the American Academy of Political and Social Science*. SAGE, March 2017a. ISBN 978-1-5063-9011-6. URL <https://www.jstor.org/stable/i26361533>.
- Abbott, K. W., Levi-faur, D., and Snidal, D. Theorizing Regulatory Intermediaries: The RIT Model. *The ANNALS of the American Academy of Political and Social Science*, 670(1):14–35, March 2017b. ISSN 0002-7162, 1552-3349. doi: 10.1177/0002716216688272. URL <http://journals.sagepub.com/doi/10.1177/0002716216688272>.
- Advani, A., Elming, W., and Shaw, J. The Dynamic Effects of Tax Audits. *The Review of Economics and Statistics*, 105(3):545–561, May 2023. ISSN 0034-6535. doi: 10.1162/rest_a_01101. URL https://doi.org/10.1162/rest_a_01101.
- Ahmed, N. and Wahed, M. The De-democratization of AI: Deep Learning and the Compute Divide in Artificial Intelligence Research, October 2020. URL <http://arxiv.org/abs/2010.15581>. arXiv:2010.15581 [cs].
- Alderman, L. Ireland’s Days as a Tax Haven May Be Ending, but Not Without a Fight. *The New York Times*, July 2021. ISSN 0362-4331. URL <https://www.nytimes.com/2021/07/08/business/ireland-minimum-corporate-tax.html>.
- Alibaba. Alibaba Cluster Trace Program, March 2024. URL <https://github.com/alibaba/clusterdata>. original-date: 2017-09-05T03:16:34Z.
- Allen, G. C. Choking off China’s Access to the Future of AI. Technical report, Center for Strategic and International Studies, October 2022. URL <https://www.csis.org/analysis/choking-chinas-access-future-ai>.
- Allen, G. C., Benson, E., and Putnam, M. Japan and the Netherlands Announce Plans for New Export Controls on Semiconductor Equipment. Commentary, Center for Strategic and International Studies, April 2023. URL <https://www.csis.org/analysis/japan-and-netherlands-announce-plans-new-export-controls-semiconductor-equipment>.
- Amazon.com, Inc. An update on Amazon’s efforts to combat child sexual abuse material, April 2023a. URL <https://www.aboutamazon.com/news/policy-news-views/amazon-csam-transparency-report-2022>. Section: Policy news & views.
- Amazon.com, Inc. Amazon and Anthropic Announce Strategic Collaboration to Advance Generative AI, September 2023b. URL <https://press.aboutamazon.com/2023/9/amazon-and-anthropic-announce-strategic-collaboration-to-advance-generative-ai>.
- Amazon.com, Inc. Sustainability Amazon, 2024. URL <https://sustainability.aboutamazon.com/products-services/the-cloud>.
- AMD. AMD Regulatory Trade Compliance, 2024. URL <https://www.amd.com/en/legal/compliance/trade-compliance.html>.
- Anderljung, M., Barnhart, J., Korinek, A., Leung, J., O’Keefe, C., Whittlestone, J., Avin, S., Brundage, M., Bullock, J., Cass-Beggs, D., Chang, B., Collins, T., Fist, T., Hadfield, G., Hayes, A., Ho, L., Hooker, S., Horvitz, E., Kolt, N., Schuett, J., Shavit, Y., Siddarth, D., Trager, R., and Wolf, K. Frontier AI Regulation: Managing Emerging Risks to Public Safety, November 2023a. URL <http://arxiv.org/abs/2307.03718>. arXiv:2307.03718 [cs].
- Anderljung, M., Smith, E. T., O’Brien, J., Soder, L., Bucknall, B., Bluemke, E., Schuett, J., Trager, R., Strahm, L., and Chowdhury, R. Towards Publicly Accountable Frontier LLMs: Building an External Scrutiny Ecosystem under the ASPIRE Framework. Technical report, Centre for the Governance of AI, November 2023b. URL <https://www.governance.ai/research-paper/towards-publicly-accountable-frontier-llms>. arXiv:2311.14711 [cs].
- Anthropic. Anthropic Partners with Google Cloud, February 2023. URL <https://www.anthropic.com/news/anthropic-partners-with-google-cloud>.

Australian Attorney-General's Department. Data Retention: Guideline for Service Providers. Technical report, Australian Government, July 2015. URL <https://www.homeaffairs.gov.au/nat-security/files/data-retention-guidelines-service-providers.pdf>.

Australian DITRDCA. International Air Services Information Memorandum, January 2024. URL <https://www.infrastructure.gov.au/infrastructure-transport-vehicles/aviation/international-aviation/air-services-agreements-arrangements/international-air-services-information-memorandum>. Last Modified: 2024-01-18 Publisher: Department of Infrastructure, Transport, Regional Development, Communications and the Arts.

Aviation Transport Security Act. Aviation Transport Security Regulations, 2005. URL https://www8.austlii.edu.au/cgi-bin/viewdb/au/legis/cth/consol_reg/atrsr2005457/.

AWS. General Data Protection Regulation (GDPR) Center, 2024a. URL <https://aws.amazon.com/compliance/gdpr-center/>.

AWS. AWS Customer Agreement, 2024b. URL <https://aws.amazon.com/agreement/#:~:text=You%20consent%20to%20the%20storage,order%20of%20a%20governmental%20body>.

AWS. AWS Global Infrastructure, 2024c. URL <https://aws.amazon.com/about-aws/global-infrastructure/>.

AWS. AWS Nitro Enclaves, 2024d. URL <https://aws.amazon.com/ec2/nitro/nitro-enclaves/>.

AWS. Amazon EC2 On-Demand Pricing, 2024e. URL <https://aws.amazon.com/ec2/pricing/on-demand/>.

AWS. Amazon EC2 Reserved Instances, 2024f. URL <https://aws.amazon.com/ec2/pricing/reserved-instances/>.

AWS. AWS Privacy Notice, 2024g. URL <https://aws.amazon.com/privacy/>.

AWS. Security of the AWS Infrastructure, 2024h. URL <https://docs.aws.amazon.com/whitepapers/latest/introduction-aws-security/security-of-the-aws-infrastructure.html>.

Banjongkan, A., Pongsena, W., Chanklan, R., Kerdprasop, N., and Kerdprasop, K. Multi-label classification of high performance computing workload with variable transformation. *International Journal of Machine Learning and Computing*, 8:536–541, December 2018. doi: 10.18178/ijmlc.2018.8.6.742. URL <https://www.ijmlc.org/vol18/742-ML0023.pdf>.

BBC. EU-US Privacy Shield for data struck down by court. *BBC News*, July 2020. URL <https://www.bbc.com/news/technology-53418898>.

Belfield, H. and Hua, S.-S. Compute and Antitrust: Regulatory implications of the AI hardware supply chain, from chip design to cloud APIs. *Verfassungsblog*, August 2022. URL <https://verfassungsblog.de/compute-and-antitrust/>.

Besiroglu, T., Bergerson, S. A., Michael, A., Heim, L., Luo, X., and Thompson, N. The Compute Divide in Machine Learning: A Threat to Academic Contribution and Scrutiny?, January 2024. URL <http://arxiv.org/abs/2401.02452>. arXiv:2401.02452 [cs].

Biden, J. R. S.1738 - 110th Congress (2007-2008): PROTECT Our Children Act of 2008, October 2008. URL <https://www.congress.gov/bill/110th-congress/senate-bill/1738>. Archive Location: 2007-06-28.

Boyle, A. and Lau, T. The President's Extraordinary Sanctions Powers, July 2021. URL <https://www.brennancenter.org/our-work/research-reports/presidents-extraordinary-sanctions-powers>.

Buttarelli, G. The EU-U.S. Privacy Shield two years on, March 2018. URL <https://www.edps.europa.eu/press-publications/press-news/blog/eu-us-privacy-shield-two-years>.

California Energy Commission. Power Plant Licensing, 2024. URL <https://www.energy.ca.gov/programs-and-topics/topics/power-plants/power-plant-licensing>. Publisher: California Energy Commission.

Center for Open Science. BrainsCAN Computational Core Neuroimaging Wiki, March 2019. URL <https://osf.io/k89fh/>. Publisher: OSF.

China Law Translate. 中华人民共和国国家情报法(2018修正), June 2017. URL <https://www.chinalawtranslate.com/national-intelligence-law-of-the-p-r-c-2017/>.

Choi, D., Shavit, Y., and Duvenaud, D. Tools for Verifying Neural Models' Training Data, July 2023. URL <http://arxiv.org/abs/2307.00682>. arXiv:2307.00682 [cs].

Code of Federal Regulations. 22 CFR Part 120 - Purpose and Definitions, 2024. URL <https://www.ecfr.gov/current/title-22/part-120>.

Confidential Computing Consortium. Confidential Computing: Hardware-Based Trusted Execution for Applications and Data. Technical report, Confidential Computing Consortium, November 2022. URL https://confidentialcomputing.io/wp-content/uploads/sites/10/2023/03/CCC_outreach_whitepaper_updated_November_2022.pdf.

Congressional Research Service. Who Regulates Whom? An Overview of the U.S. Financial Regulatory Framework. CRS Report R44918, Congressional Research Service, October 2023. URL <https://sgp.fas.org/crs/misc/R44918.pdf>.

Congressional Research Service. The International Emergency Economic Powers Act: Origins, Evolution, and Use. CRS Report R45618, Congressional Research Service, January 2024. URL <https://sgp.fas.org/crs/natsec/R45618.pdf>.

Consumer Financial Protection Bureau. CFPB Proposes New Federal Oversight of Big Tech Companies and Other Providers of Digital Wallets and Payment Apps, November 2023. URL <https://www.consumerfinance.gov/about-us/newsroom/cfpb-proposes-new-federal-oversight-of-big-tech-companies-and-other-providers-of-digital-wallets-and-payment-apps/>.

Copos, B. and Peisert, S. Catch Me If You Can: Using Power Analysis to Identify HPC Activity, May 2020. URL <http://arxiv.org/abs/2005.03135>. arXiv:2005.03135 [cs].

CoreWeave. Privacy Policy, October 2022. URL <https://docs.coreweave.com/policies/terms-of-service/privacy-policy>.

CoreWeave. Security & Compliance, 2023. URL <https://docs.coreweave.com/policies/terms-of-service/security-and-compliance>.

Cottier, B. Trends in the Dollar Training Cost of Machine Learning Systems, January 2023. URL <https://epochai.org/blog/trends-in-the-dollar-training-cost-of-machine-learning-systems>.

Council of the European Union. Proposal for a Regulation of the European Parliament and of the Council laying down harmonised rules on artificial intelligence (Artificial Intelligence Act) and amending certain Union legislative acts, January 2024. URL <https://data.consilium.europa.eu/doc/document/ST-5662-2024-INIT/en/pdf>.

Country Legal Frameworks Resource. Provision of Real-time Lawful Interception Assistance, 2023. URL <https://clfr.globalnetworkinitiative.org/country/france/>.

Cox, J. Inside the Underground Site Where 'Neural Networks' Churn Out Fake IDs, February 2024. URL <https://www.404media.co/inside-the-underground-site-where-ai-neural-networks-churns-out-fake-ids-onlyfake/>.

Dettmers, T., Lewis, M., Belkada, Y., and Zettlemoyer, L. LLM.int8(): 8-bit Matrix Multiplication for Transformers at Scale, November 2022. URL <http://arxiv.org/abs/2208.07339>. arXiv:2208.07339 [cs].

ECFR. Acceptance and screening of individuals and accessible property., 2024. URL <https://www.ecfr.gov/current/title-49/part-1544/section-1544.201>.

Egan, J. and Heim, L. Oversight for Frontier AI through a Know-Your-Customer Scheme for Compute Providers. Technical report, Centre for the Governance of AI, October 2023. URL <https://www.governance.ai/research-paper/oversight-for-frontier-ai-through-kyc-scheme-for-compute-providers>.

EU Agency for Cybersecurity. Safe Harbor Privacy Principles, July 2000. URL <https://www.enisa.europa.eu/topics/risk-management/current-risk/laws-regulation/data-protection-privacy/safe-harbor-privacy-principles>.

European Commission. EU-U.S. Privacy Shield: Frequently Asked Questions, July 2016. URL https://ec.europa.eu/commission/presscorner/detail/hr/MEMO_16_2462.

European Commission. Commission welcomes G7 leaders' agreement on Guiding Principles and a Code of Conduct on Artificial Intelligence, October 2023a. URL https://ec.europa.eu/commission/presscorner/detail/en/ip_23_5379.

European Commission. Shaping Europe's digital future: Hiroshima Process International Code of Conduct for Advanced AI Systems, October 2023b. URL <https://digital-strategy.ec.europa.eu/en/library/hiroshima-process-international-code-conduct-advanced-ai-systems>.

European Union. Directive 2011/93/EU of the European Parliament and of the Council of 13 December 2011 on combating the sexual abuse and sexual exploitation of children and child pornography, and replacing Council Framework Decision 2004/68/JHA, July 2011. URL <https://eur-lex.europa.eu/eli/dir/2011/93/oj>.

European Union. Regulation (EU) 2016/679 of the European Parliament and of the Council of 27 April 2016 on the protection of natural persons with regard to the processing of personal data and on the free movement of such data, and repealing Directive 95/46/EC (General Data Protection Regulation), May 2016. URL <http://data.europa.eu/eli/reg/2016/679/oj>. 119.

European Union. Regulation (EU) 2021/784 of the European Parliament and of the Council of 29 April 2021 on addressing the dissemination of terrorist content online. *Official Journal of the European Union L 172/79*, pp. 79–109, May 2021. URL <https://eur-lex.europa.eu/eli/reg/2021/784/oj>.

Farrell, H. and Newman, A. *Underground Empire: How America Weaponized the World Economy*. Henry Holt and Co., September 2023. ISBN 978-1-250-84055-4. URL <https://us.macmillan.com/books/9781250840554/undergroundempire>.

Federal Register. Taking Additional Steps To Address the National Emergency With Respect to Significant Malicious Cyber-Enabled Activities: A Proposed Rule by the Commerce Department, January 2024. URL <https://www.federalregister.gov/documents/2024/01/29/2024-01580/taking-additional-steps-to-address-the-national-emergency-with-respect-to-significant-malicious>.

Federal Trade Commission. FTC Launches Inquiry into Generative AI Investments and Partnerships, January 2024. URL <https://www.ftc.gov/news-events/news/press-releases/2024/01/ftc-launches-inquiry-generative-ai-investments-partnerships>.

FedRAMP. Understanding Baselines and Impact Levels for FedRAMP Authorization, 2024. URL <https://www.fedramp.gov/baselines/>.

Financial Action Task Force. FATF 40 Recommendations October 2003 (incorporating all subsequent amendments until October 2004). Technical report, FATF, October 2003. URL <https://www.fatf-gafi.org/content/dam/fatf-gafi/recommendations/FATF%20Standards%20-%202040%20Recommendations%20rc.pdf>.

Financial Action Task Force. International Standards on Combating Money Laundering and the Financing of Terrorism and Proliferation. Technical report, FATF, Paris, France, November 2023. URL <https://www.fatf-gafi.org/content/dam/fatf-gafi/recommendations/FATF%20Recommendations%202012.pdf.coredownload.inline.pdf>.

Financial Action Task Force. High-risk and other monitored jurisdictions, 2024a. URL <https://www.fatf-gafi.org/en/topics/high-risk-and-other-monitored-jurisdictions.html>.

Financial Action Task Force. Financial Action Task Force Home, 2024b. URL <https://www.fatf-gafi.org/en/home.html>.

Financial Crimes Enforcement Network. FACT SHEET for Section 312 of the USA PATRIOT Act Final Regulation and Notice of Proposed Rulemaking. Technical report, U.S. Treasury, December 2005. URL <https://www.fincen.gov/fact-sheet-section-312-usa-patriot-act-final-regulation-and-notice-proposed-rulemaking>.

Financial Crimes Enforcement Network. Financial Crimes Enforcement Network - Mission, 2024. URL <https://www.fincen.gov/about/mission>.

Fist, T. and Grunewald, E. Preventing AI Chip Smuggling to China. Working Paper, Center for a New American Security, October 2023. URL <https://www.cnas.org/publications/reports/preventing-ai-chip-smuggling-to-china>.

Fist, T., Heim, L., and Schneider, J. Chinese Firms Are Evading Chip Controls, June 2023. URL <https://foreignpolicy.com/2023/06/21/china-united-states-semiconductor-chips-sanctions-evasion/>.

FluidStack. FluidStack Privacy Notice, February 2022. URL https://uploads-ssl.webflow.com/64e49a6c77bc12449a05e6a2/6502008478387e54d7816888_Privacy%20Policy.pdf.

Future of Life Institute. EU Artificial Intelligence Act: The Act Texts, 2024. URL <https://artificialintelligenceact.eu/the-act/>.

Gatlan, S. Microsoft breach led to theft of 60,000 US State Dept emails, September 2023. URL <https://www.bleepingcomputer.com/news/security/microsoft-breach-led-to-theft-of-60-000-us-state-dept-emails/>.

Google. google/cluster-data, March 2024. URL <https://github.com/google/cluster-data>. original-date: 2015-07-29T17:52:23Z.

Google Cloud. Google Cloud & the General Data Protection Regulation (GDPR), 2021. URL <https://cloud.google.com/privacy/gdpr>.

Google Cloud. Cloud Data Processing Addendum, November 2023. URL <https://cloud.google.com/terms/data-processing-addendum>.

Google Cloud. All networking pricing, 2024a. URL <https://cloud.google.com/vpc/network-pricing>.

Google Cloud. Climate Sustainability, 2024b. URL <https://cloud.google.com/gov/sustainability>.

Google Cloud. Google Cloud Privacy Notice, 2024c. URL <https://cloud.google.com/terms/cloud-privacy-notice>.

Government of India. Govt considering proposal to set up 25K GPUs, October 2023. URL <https://indbiz.gov.in/govt-considering-proposal-to-set-up-25k-gpus/>.

Hacker, P. The European AI liability directives – Critique of a half-hearted approach and lessons for the future. *Computer Law & Security Review*, 51:105871, November 2023. ISSN 0267-3649. doi: 10.1016/j.clsr.2023.105871. URL <https://www.sciencedirect.com/science/article/pii/S026736492300081X>.

Hay, J. R. and Shleifer, A. Private enforcement of public laws: a theory of legal reform. *American Economic Review Papers and Proceedings*, 88(2):398–403, 1998. URL <https://www.jstor.org/stable/116955>.

Heim, L. Crucial Considerations for Compute Governance, February 2024. URL <https://blog.heim.xyz/crucial-considerations-for-compute-governance/>.

Heim, L. and Egan, J. Accessing Controlled AI Chips via Infrastructure-as-a-Service (IaaS): Implications for Export Controls: Comment on BIS–2022–0025 (RIN 0694–AI94) — Question 1. Technical report, Centre for the Governance of AI, December 2023. URL https://cdn.governance.ai/Accessing_Controlled_AI_Chips_via_Infrastructure-as-a-Service.pdf.

IBM. What is Confidential Computing?, 2024. URL <https://www.ibm.com/topics/confidential-computing>.

India’s Ministry of Electronics and Information Technology. Proposed Digital India Act, 2023, March 2023. URL https://www.meity.gov.in/writereaddata/files/DIA_Presentation%2009.03.2023%20Final.pdf.

Janardhan, S. Reimagining Our Infrastructure for the AI Age, May 2023. URL <https://about.fb.com/news/2023/05/metasp-iaa-for-ai/>.

Jeon, M., Venkataraman, S., Phanishayee, A., Qian, J., Xiao, W., and Yang, F. Analysis of Large-Scale Multi-Tenant GPU Clusters for DNN Training Workloads, August 2019. URL <http://arxiv.org/abs/1901.05758>. arXiv:1901.05758 [cs].

Jiang, B. and Cao, A. China to create and implement national standard for large language models in move to regulate AI, while using its power to transform industries. *South China Morning Post*, July 2023. URL <https://www.scmp.com/tech/policy/article/3226942/china-create-and-implement-national-standard-large-language-models-move-regulate-ai-while-using-its>.

Jones, G., Egan, J., and Rosenbach, E. Advancing in Adversity: Ukraine’s Battlefield Technologies and Lessons for the U.S. Policy Brief, Belfer Center for Science and International Affairs, July 2023. URL <https://www.belfercenter.org/publication/advancing-adversity-ukraines-battlefield-technologies-and-lessons-us>.

Kim, C. Privacy activists slam EU-US pact on data sharing. *BBC News*, July 2023. URL <https://www.bbc.com/news/world-us-canada-66161135>.

- Korolov, M. Data centers unprepared for new European energy efficiency regulations, December 2023. URL <https://www.networkworld.com/article/1251883/data-centers-unprepared-for-new-european-energy-efficiency-regulations.html>.
- Kulp, G., Gonzales, D., Smith, E., Heim, L., Puri, P., Vermeer, M. J. D., and Winkelman, Z. Hardware-Enabled Governance Mechanisms: Developing Technical Solutions to Exempt Items Otherwise Classified Under Export Control Classification Numbers 3A090 and 4A090. Technical report, RAND Corporation, January 2024. URL https://www.rand.org/pubs/working_papers/WRA3056-1.html.
- Köhler, S., Wenzel, L., Plauth, M., Böning, P., Gampe, P., Geier, L., and Polze, A. Recognizing HPC Workloads Based on Power Draw Signatures. In *2021 Ninth International Symposium on Computing and Networking Workshops (CANDARW)*, pp. 278–284, December 2021. doi: 10.1109/CANDARW53999.2021.00053. URL <https://ieeexplore.ieee.org/document/9644213>.
- Lambda Labs. Lambda Privacy Policy, August 2022. URL <https://lambdalabs.com/legal/privacy-policy>.
- legislation.gov.uk. Data Retention and Investigatory Powers Act 2014, 2014. URL <https://www.legislation.gov.uk/ukpga/2014/27/crossheading/retention-of-relevant-communications-data/enacted>. Publisher: King’s Printer of Acts of Parliament.
- Linn, C. J. Redefining the Bank Secrecy Act: Currency Reporting and the Crime of Structuring. *Santa Clara Law Review*, 50(2):407–513, January 2010. URL <https://digitalcommons.law.scu.edu/lawreview/vol150/iss2/4/>.
- Lohr, A. Intelligence community and Defense Department to share classified cloud services, July 2023. URL <https://federalnewsnetwork.com/defense-main/2023/07/intelligence-community-and-defense-department-to-share-classified-cloud-services/>.
- Merritt, R. What Is NVLink?, March 2023. URL <https://blogs.nvidia.com/blog/what-is-nvidia-nvlink/>.
- Microsoft. US National Security Orders Reports | Microsoft CSR, 2022. URL <https://www.microsoft.com/en-us/corporate-responsibility/fisa>.
- Microsoft. What is confidential computing?, October 2023. URL <https://learn.microsoft.com/en-us/azure/confidential-computing/overview>.
- Microsoft. Microsoft Privacy Statement – Microsoft privacy, February 2024a. URL <https://privacy.microsoft.com/en-us/privacystatement>.
- Microsoft. Confidential Computing on Azure, February 2024b. URL <https://learn.microsoft.com/en-us/azure/confidential-computing/overview-azure-products>.
- Microsoft Azure. Azure Sustainability, 2024a. URL <https://azure.microsoft.com/en-us/explore/global-infrastructure/sustainability>.
- Microsoft Azure. Bandwidth pricing, 2024b. URL <https://azure.microsoft.com/en-us/pricing/details/bandwidth/>.
- Microsoft Corporate Blogs. Microsoft and OpenAI extend partnership, January 2023. URL <https://blogs.microsoft.com/blog/2023/01/23/microsoftandopenaiextendpartnership/>.
- Milmo, D. CMA to investigate UK cloud computing market amid Microsoft and Amazon concerns. *The Guardian*, October 2023. ISSN 0261-3077. URL <https://www.theguardian.com/business/2023/oct/05/amazon-and-microsofts-uk-cloud-computing-dominance-faces-investigation>.
- Mithril Security. mithril-security/aicert, January 2024a. URL <https://github.com/mithril-security/aicert>. original-date: 2023-07-04T07:24:29Z.
- Mithril Security. mithril-security/blindai, February 2024b. URL <https://github.com/mithril-security/blindai>. original-date: 2022-02-06T14:07:35Z.
- Mulani, N. and Whittlestone, J. Proposing a Foundation Model Information-Sharing Regime for the UK, June 2023. URL <https://www.governance.ai/post/proposing-a-foundation-model-information-sharing-regime-for-the-uk>.
- Murgia, M. White House science chief signals US-China co-operation on AI safety. *Financial Times*, January 2024. URL <https://www.ft.com/content/94b9878b-9412-4dbc-83ba-aac2baadafd9>.

- Nagao, R. Japan to pay for half of \$100m generative AI supercomputer - Nikkei Asia. *Nikkei Asia*, June 2023. URL <https://asia.nikkei.com/Business/Technology/Japan-to-pay-for-half-of-100m-generative-AI-supercomputer>.
- National Energy Research Scientific Computing. NERSC Documentation: Roofline Performance Model, 2024. URL <https://docs.nersc.gov/tools/performance/roofline/>.
- National Security Telecommunications Advisory Committee. NSTAC Report to the President: Addressing the Abuse of Domestic Infrastructure by Foreign Malicious Actors. Technical report, National Security Telecommunications Advisory Committee, 2023. URL https://www.cisa.gov/sites/default/files/2024-01/NSTAC_Report_to_the_President_on_Addressing_the_Abuse_of_Domestic_Infrastructure_by_Foreign_Malicious_Actors_508c.pdf.
- Nevo, S., Lahav, D., Karpur, A., Alstott, J., and Matheny, J. Securing Artificial Intelligence Model Weights: Interim Report. Technical report, RAND Corporation, October 2023. URL https://www.rand.org/pubs/working_papers/WRA2849-1.html.
- NVIDIA. Confidential Compute on NVIDIA Hopper H100, July 2023. URL <https://images.nvidia.com/aem-dam/en-zz/Solutions/data-center/HCC-Whitepaper-v1.0.pdf>.
- NVIDIA. NVIDIA BlueField Networking Platform, 2024a. URL <https://resources.nvidia.com/en-us-accelerated-networking-resource-library-ms/>.
- NVIDIA. NVIDIA Nsight Perf SDK, 2024b. URL <https://developer.nvidia.com/nsight-perf-sdk>.
- NVIDIA. Redfish APIs Support, 2024c. URL <https://docs.nvidia.com/dgx/dgxh100-user-guide/redfish-api-supp.html>.
- O'Brien, J., Ee, S., and Williams, Z. Deployment corrections: An incident response framework for frontier AI models. Technical report, Institute for AI Policy and Strategy, September 2023. URL <https://arxiv.org/abs/2310.00328>.
- OECD. Measuring the environmental impacts of artificial intelligence compute and applications: The AI footprint. OECD Digital Economy Papers 341, OECD, November 2022. URL https://www.oecd-ilibrary.org/science-and-technology/measuring-the-environmental-impacts-of-artificial-intelligence-compute-and-applications_7babf571-en. Series: OECD Digital Economy Papers Volume: 341.
- Office for Civil Rights. Guidance on HIPAA & Cloud Computing, October 2016. URL <https://www.hhs.gov/hipaa/for-professionals/special-topics/health-information-technology/cloud-computing/index.html>. Last Modified: 2023-02-02T10:24:50-0500.
- OFWAT. The Water Services Regulation Authority, 2024. URL <https://www.ofwat.gov.uk/regulated-companies/ofwat-industry-overview/licences/>.
- OpenMined. How to Audit an AI Model Owned by Someone Else (Part 1): An introduction to state-of-the-art AI auditing infrastructure, June 2023. URL <https://blog.openmined.org/ai-audit-part-1/>.
- OpenMined. OpenMined/PySyft, March 2024. URL <https://github.com/OpenMined/PySyft>. original-date: 2017-07-18T20:41:16Z.
- Owen, D. How predictable is language model benchmark performance?, January 2024. URL <http://arxiv.org/abs/2401.04757>. arXiv:2401.04757 [cs].
- Pal, B., Gorczynski, S., and Schmidt, D. Overview of Data Transfer Costs for Common Architectures | AWS Architecture Blog, June 2021. URL <https://aws.amazon.com/blogs/architecture/overview-of-data-transfer-costs-for-common-architectures/>. Section: Amazon EC2.
- Patel, P., Choukse, E., Zhang, C., Goiri, I., Warriar, B., Mahalingam, N., and Bianchini, R. POLCA: Power Oversubscription in LLM Cloud Providers, August 2023. URL <http://arxiv.org/abs/2308.12908>. arXiv:2308.12908 [cs].
- Pilz, K. and Heim, L. Compute at Scale: A Broad Investigation into the Data Center Industry, November 2023. URL <https://arxiv.org/abs/2311.02651v4>.
- Pilz, K., Heim, L., and Brown, N. Increased Compute Efficiency and the Diffusion of AI Capabilities, February 2024. URL <http://arxiv.org/abs/2311.15377>. arXiv:2311.15377 [cs].

- Prime Minister’s Office, FCDO UK, and DSIT UK. The Bletchley Declaration by Countries Attending the AI Safety Summit, 1-2 November 2023, November 2023. URL <https://www.gov.uk/government/publications/ai-safety-summit-2023-the-bletchley-declaration/the-bletchley-declaration-by-countries-attending-the-ai-safety-summit-1-2-november-2023>.
- Rabinovitsj, D. Opening AI Infrastructure: Ushering In The Age Of GenAI, December 2023. URL https://drive.google.com/file/d/1ud1JZqco2868AvmkNkrA-Axp-74PvwWx/view?usp=embed_facebook.
- Rep. Collins, D. R.-G.-. Text - H.R.4943 - 115th Congress (2017-2018): CLOUD Act, February 2018. URL <https://www.congress.gov/bill/115th-congress/house-bill/4943/text>. Archive Location: 2018-02-06.
- Richter, F. Amazon Maintains Cloud Lead as Microsoft Edges Closer, February 2024. URL <https://www.statista.com/chart/18819/worldwide-market-share-of-leading-cloud-infrastructure-service-providers>.
- Sanction Scanner. What is the Difference Between Smurfing and Structuring?, 2024. URL <https://sanctionscanner.com/blog/what-is-the-difference-between-smurfing-and-structuring-594>.
- Sastry, G., Heim, L., Belfield, H., Anderljung, M., Brundage, M., Hazell, J., O’Keefe, C., Hadfield, G. K., Ngo, R., Pilz, K., Gor, G., Bluemke, E., Shoker, S., Egan, J., Trager, R. F., Avin, S., Weller, A., Bengio, Y., and Coyle, D. Computing Power and the Governance of Artificial Intelligence, February 2024. URL <http://arxiv.org/abs/2402.08797>. arXiv:2402.08797 [cs].
- Secretary of State for Science, Innovation and Technology. A pro-innovation approach to AI regulation. Policy paper Command Paper Number: 815, GOV.UK., August 2023. URL <https://www.gov.uk/government/publications/ai-regulation-a-pro-innovation-approach/white-paper>. ISBN: 978-1-5286-4009-1.
- Senator Scott Wiener. Senator Wiener Introduces Legislation to Ensure Safe Development of Large-Scale Artificial Intelligence Systems and Support AI Innovation in California, February 2024. URL <https://sd11.senate.ca.gov/news/20240208-senator-wiener-introduces-legislation-ensure-safe-development-large-scale-artificial>.
- Sevilla, J., Heim, L., Ho, A., Besiroglu, T., Hobbhahn, M., and Villalobos, P. Compute Trends Across Three Eras of Machine Learning. In *2022 International Joint Conference on Neural Networks (IJCNN)*, pp. 1–8, July 2022. doi: 10.1109/IJCNN55064.2022.9891914. URL <http://arxiv.org/abs/2202.05924>. arXiv:2202.05924 [cs].
- Shavit, Y., Agarwal, S., Brundage, M., and Adler, S. Practices for Governing Agentic AI Systems. Research Paper, OpenAI, December 2023. URL <https://cdn.openai.com/papers/practices-for-governing-agentic-ai-systems.pdf>.
- Sheehan, M. Tracing the Roots of China’s AI Regulations. Technical report, Carnegie Endowment for International Peace, February 2024. URL <https://carnegieendowment.org/2024/02/27/tracing-roots-of-china-s-ai-regulations-pub-91815>.
- Shoeybi, M., Patwary, M., Puri, R., LeGresley, P., Casper, J., and Catanzaro, B. Megatron-LM: Training Multi-Billion Parameter Language Models Using Model Parallelism, March 2020. URL <http://arxiv.org/abs/1909.08053>. arXiv:1909.08053 [cs].
- Sliwko, L. and Getov, V. AGOCS — Accurate Google Cloud Simulator Framework. In *2016 Intl IEEE Conferences on Ubiquitous Intelligence & Computing, Advanced and Trusted Computing, Scalable Computing and Communications, Cloud and Big Data Computing, Internet of People, and Smart World Congress (UIC/ATC/ScalCom/CBDCCom/IoP/SmartWorld)*, pp. 550–558, January 2016. doi: 10.1109/UIC-ATC-ScalCom-CBDCCom-IoP-SmartWorld.2016.0095. URL <https://ieeexplore.ieee.org/document/7816891>.
- Smith, B. The need for a Digital Geneva Convention, February 2017. URL <https://blogs.microsoft.com/on-the-issues/2017/02/14/need-digital-geneva-convention/>.
- Smith, B. How do we best govern AI?, May 2023. URL <https://blogs.microsoft.com/on-the-issues/2023/05/25/how-do-we-best-govern-ai/>.
- Tang, B. J., Chen, Q., Weiss, M. L., Frey, N., McDonald, J., Bestor, D., Yee, C., Arcand, W., Byun, C., Edelman, D., Hubbell, M., Jones, M., Kepner, J., Klein, A., Michaleas, A., Michaleas, P., Milechin, L., Mullen, J., Prout, A., Reuther, A., Rosa, A., Bowne, A., McEvoy, L., Li, B., Tiwari, D., Gadepally, V., and Samsi, S. The MIT Supercloud Workload Classification Challenge. In *2022 IEEE International Parallel and Distributed Processing Symposium Workshops (IPDPSW)*, pp. 708–714, May 2022. doi: 10.1109/IPDPSW55747.2022.00122. URL <http://arxiv.org/abs/2204.05839>. arXiv:2204.05839 [cs].

- Terai, M., Kashiwaki, R., and Shoji, F. Workload Classification and Performance Analysis using Job Metrics in the K computer. IPSJ SIG Technical Report 13, Information Processing Society of Japan, December 2017. URL https://ipsj.ixsq.nii.ac.jp/ej/?action=repository_uri&item_id=184893&file_id=1&file_no=1. Vol. 2017-HPC-162.
- The European High Performance Computing Joint Undertaking. Open Call to Support HPC-powered Artificial Intelligence (AI) Applications - European Commission, November 2023. URL https://eurohpc-ju.europa.eu/open-call-support-hpc-powered-artificial-intelligence-ai-applications-2023-11-28_en.
- The White House. Voluntary AI Commitments, September 2023a. URL <https://www.whitehouse.gov/wp-content/uploads/2023/09/Voluntary-AI-Commitments-September-2023.pdf>.
- The White House. Executive Order on the Safe, Secure, and Trustworthy Development and Use of Artificial Intelligence. Technical report, The White House, October 2023b. URL <https://www.whitehouse.gov/briefing-room/presidential-actions/2023/10/30/executive-order-on-the-safe-secure-and-trustworthy-development-and-use-of-artificial-intelligence/>.
- The White House. FACT SHEET: Biden-Harris Administration Secures Voluntary Commitments from Leading Artificial Intelligence Companies to Manage the Risks Posed by AI, July 2023c. URL <https://www.whitehouse.gov/briefing-room/statements-releases/2023/07/21/fact-sheet-biden-harris-administration-secures-voluntary-commitments-from-leading-artificial-intelligence-companies-to-manage-the-risks-posed-by-ai/>.
- The White House. G7 Hiroshima Leaders' Communiqué, May 2023d. URL <https://www.whitehouse.gov/briefing-room/statements-releases/2023/05/20/g7-hiroshima-leaders-communicue/>.
- Tirmazi, M., Barker, A., Deng, N., Haque, M. E., Qin, Z. G., Hand, S., Harchol-Balter, M., and Wilkes, J. Borg: the next generation. In *Proceedings of the Fifteenth European Conference on Computer Systems*, pp. 1–14, Heraklion Greece, April 2020. ACM. ISBN 978-1-4503-6882-7. doi: 10.1145/3342195.3387517. URL <https://dl.acm.org/doi/10.1145/3342195.3387517>.
- Trager, R., Harack, B., Reuel, A., Carnegie, A., Heim, L., Ho, L., Kreps, S., Lall, R., Larter, O., Ó hÉigeartaigh, S., Staffell, S., and Villalobos, J. J. International Governance of Civilian AI: A Jurisdictional Certification Approach. Whitepaper, Oxford Martin AI Governance initiative and Centre for the Governance of AI, August 2023. URL https://cdn.governance.ai/International_Governance_of_Civilian_AI_OMS.pdf.
- UK DSIT. Capabilities and risks from frontier AI: A discussion paper on the need for further research into AI risk. Technical report, DSIT UK, October 2023. URL <https://assets.publishing.service.gov.uk/media/65395abae6c968000daa9b25/frontier-ai-capabilities-risks-report.pdf>.
- UK DSIT and Donelan, M. Technology Secretary announces investment boost making British AI supercomputing 30 times more powerful, November 2023. URL <https://www.gov.uk/government/news/technology-secretary-announces-investment-boost-making-british-ai-supercomputing-30-times-more-powerful>.
- UK Government. AI Safety Summit 2023 - GOV.UK, February 2024. URL <https://www.gov.uk/government/topical-events/ai-safety-summit-2023>.
- UK Research and Innovation. £300 million to launch first phase of new AI Research Resource, November 2023. URL <https://www.ukri.org/news/300-million-to-launch-first-phase-of-new-ai-research-resource/>.
- US BIS and US DOC. Implementation of Additional Export Controls: Certain Advanced Computing Items; Supercomputer and Semiconductor End Use; Updates and Corrections, October 2023. URL <https://www.federalregister.gov/documents/2023/10/25/2023-23055/implementation-of-additional-export-controls-certain-advanced-computing-items-supercomputer-and>.
- U.S. National Science Foundation. Democratizing the future of AI R&D: NSF to launch National AI Research Resource pilot | NSF - National Science Foundation, January 2024. URL <https://new.nsf.gov/news/democratizing-future-ai-rd-nsf-launch-national-ai>.
- U.S. Securities and Exchange Commission. Retention of Records Relevant to Audits and Reviews, March 2003. URL <https://www.sec.gov/rules/2003/01/retention-records-relevant-audits-and-reviews>.

- Vailshery, L. S. Worldwide infrastructure as a service (IaaS) and platform as a service (PaaS) hyperscaler market share from 2020 to 2023, by vendor, February 2024. URL <https://www.statista.com/statistics/1202770/hyperscaler-iaas-paas-market-share/>.
- Vanian, J. HPE hacked by same Russian intelligence group that hit Microsoft, January 2024. URL <https://www.cnn.com/2024/01/24/hpe-hit-by-russian-intelligence-group-that-hacked-microsoft.html>.
- Ward, J. and Hu, K. US antitrust inquiry targets OpenAI and Anthropic's deals with Big Tech. *Reuters*, January 2024. URL <https://www.reuters.com/technology/ftc-launches-inquiry-into-generative-ai-investments-partnerships-2024-01-25/>.
- Weiss, M. L., McDonald, J., Bestor, D., Yee, C., Edelman, D., Jones, M., Prout, A., Bowne, A., McEvoy, L., Gadepally, V., and Samsi, S. An Evaluation of Low Overhead Time Series Preprocessing Techniques for Downstream Machine Learning, September 2022. URL <http://arxiv.org/abs/2209.05300>. arXiv:2209.05300 [cs].
- Weng, Q., Xiao, W., Yu, Y., Wang, W., Wang, C., He, J., Li, Y., Zhang, L., Lin, W., and Ding, Y. MLaaS in the wild: Workload analysis and scheduling in Large-Scale heterogeneous GPU clusters. In *19th USENIX symposium on networked systems design and implementation (NSDI 22)*, pp. 945–960, Renton, WA, April 2022. USENIX Association. ISBN 978-1-939133-27-4. URL <https://www.usenix.org/conference/nsdi22/presentation/weng>.
- Whittlestone, J. and Clark, J. Why and How Governments Should Monitor AI Development, August 2021. URL <http://arxiv.org/abs/2108.12427>. arXiv:2108.12427 [cs].
- Whittlestone, J., Avin, S., Heim, L., Anderljung, M., and Sastry, G. Response to the UK's Future of Compute Review. Technical report, Centre for the Governance of AI, March 2023. URL <https://www.governance.ai/research-paper/response-to-the-uks-future-of-compute-review>.
- Wikipedia contributors. Hardware performance counter, August 2023. URL https://en.wikipedia.org/w/index.php?title=Hardware_performance_counter&oldid=1169157291.
- Williams, S., Waterman, A., and Patterson, D. Roofline: An Insightful Visual Performance Model for Floating-Point Programs and Multicore Architectures, October 2008. URL <https://people.eecs.berkeley.edu/~kubitron/cs252/handouts/papers/RooflineVyNoYellow.pdf>.