

# Higher condensation theory

Liang Kong <sup>\*a,b,c</sup>, Zhi-Hao Zhang <sup>†d,a</sup>, Jiaheng Zhao <sup>‡e</sup>, and Hao Zheng <sup>§f,g</sup>

<sup>a</sup>Shenzhen Institute for Quantum Science and Engineering,  
Southern University of Science and Technology, Shenzhen, 518055, China

<sup>b</sup>International Quantum Academy, Shenzhen 518048, China

<sup>c</sup>Guangdong Provincial Key Laboratory of Quantum Science and Engineering,  
Southern University of Science and Technology, Shenzhen, 518055, China

<sup>d</sup>Wu Wen-Tsun Key Laboratory of Mathematics of Chinese Academy of Sciences,  
School of Mathematical Sciences,

University of Science and Technology of China, Hefei, 230026, China

<sup>e</sup>Academy of Mathematical and System Science, Chinese Academy of Sciences

<sup>f</sup>Institute for Applied Mathematics, Tsinghua University, Beijing, 100084, China

<sup>g</sup>Beijing Institute of Mathematical Sciences and Applications, Beijing 101408, China

## Abstract

In this work, we develop a unified theory of defect condensations for topological orders in all dimensions. This theory is mathematically based on higher categories, higher algebras and higher representations. Among many other things, we show that condensing a  $k$ -codimensional topological defect  $A$  in an  $n+1$ D (potentially anomalous) topological order  $C^{n+1}$  amounts to a  $k$ -step process. In the first step, we condense  $A$  along one of the transversal directions, thus obtaining a  $(k-1)$ -codimensional defect  $\Sigma A$ , which can be further condensed in one of the remaining transversal directions as the second step, so on and so forth. In the  $k$ -th step, condensing the 1-codimensional defect  $\Sigma^{k-1}A$  along the only transversal direction defines a phase transition to a new  $n+1$ D topological order  $D^{n+1}$  and a gapped domain wall  $M^n$ . We give precise mathematical descriptions of each step in above process, including the computation of the new phase. The  $k$ -codimensional defect  $A$  is condensable if it is equipped with the structure of a condensable  $E_k$ -algebra. We show that the condensed defect  $\Sigma A$  is naturally equipped with the structure of a condensable  $E_{k-1}$ -algebra, thus it can be further condensed, so on and so forth. The condensed phase  $D^{n+1}$  consists of all deconfined topological defects in  $C^{n+1}$ , which can be computed directly via higher representation theories. More precisely, a  $k$ -codimensional topological defect is deconfined if and only if it is equipped with a  $k$ -dimensional  $A$ -action, which defines the mathematical notion called an  $E_k$ -module over  $A$ . As a consequence, the category of topological defects of codimension  $k$  or higher in  $D^{n+1}$  can be identified with that of  $E_k$ -modules over  $A$ . The confined  $k$ -codimensional defects (confined to the wall  $M^n$ ) are the right modules over  $\Sigma^k A$ . When  $C^{n+1}$  is anomaly-free, the same phase transition, as a  $k$ -step process, can be alternatively defined by replacing the last two steps by a single step of condensing the  $E_2$ -algebra  $\Sigma^{k-2}A$  directly. The condensed phase  $D^{n+1}$  is determined by the category of  $E_2$ -modules over  $\Sigma^{k-2}A$ . When  $n=2$ , this modified last step is precisely a usual anyon condensation in a 2+1D topological order. We derive many new mathematical results physically along the way. Their proofs will appear in a mathematical companion of this paper. At the end of this work, we briefly discuss some questions, generalizations and applications that naturally arise or are inspired from our condensation theory such as higher Morita theory, factorization homology and the condensation theory of non-topological defects.

---

\*Email: [kongl@sustech.edu.cn](mailto:kongl@sustech.edu.cn)

†Email: [zzh31416@mail.ustc.edu.cn](mailto:zzh31416@mail.ustc.edu.cn)

‡Email: [zhaojiaheng171@mails.ucas.ac.cn](mailto:zhaojiaheng171@mails.ucas.ac.cn)

§Email: [haozheng@mail.tsinghua.edu.cn](mailto:haozheng@mail.tsinghua.edu.cn)

# Contents

<b>1</b>	<b>Introduction</b>	<b>4</b>
1.1	Motivations and historical remarks	4
1.2	Main results	5
1.3	Layout, conventions and notations	8
<b>2</b>	<b>Categories of topological defects</b>	<b>10</b>
2.1	Categories of topological defects	10
2.1.1	2+1D topological orders	10
2.1.2	Remote detectable principle	13
2.1.3	Boundary-bulk relation	16
2.2	Condensation completion	21
2.3	Higher algebras	26
2.3.1	Monoidal 1-categories as $E_1$ -algebras	26
2.3.2	Braided monoidal 1-categories as $E_2$ -algebras	28
2.3.3	$E_m$ -multi-fusion $n$ -categories	31
2.3.4	Condensable higher algebras	33
2.3.5	$E_m$ -center and $E_m$ -centralizer	35
<b>3</b>	<b>Condensations of 1-codimensional topological defects</b>	<b>37</b>
3.1	Particle condensations in 1+1D topological orders	37
3.1.1	Particle condensations I: algebraic bootstrap	37
3.1.2	Particle condensations II: geometric intuitions	40
3.1.3	Internal homs	42
3.1.4	Particle condensations III: geometric theory	44
3.2	Condensations of 1-codimensional defects in $n+1$ D	46
3.2.1	General theory	46
3.2.2	General examples	51
3.2.3	Examples in 2+1D	56
3.2.4	Examples in 3+1D	58
<b>4</b>	<b>Condensations of 2-codimensional topological defects</b>	<b>60</b>
4.1	Anyon condensations in 2+1D	60
4.1.1	Algebraic approach	60
4.1.2	Examples	64
4.1.3	Geometric approach	68
4.2	Condensations of 2-codimensional defects in $n+1$ D	70
4.2.1	General theory	71
4.2.2	Condensations in $\mathbf{1}^{n+1}$	75
4.2.3	Topological Morita equivalence and Witt equivalence	77
4.2.4	Examples in 3+1D	78
<b>5</b>	<b>Condensations of higher codimensional topological defects</b>	<b>80</b>
5.1	Particle condensations in 2+1D via a two-step process	80
5.1.1	General theory	80
5.1.2	Examples	84
5.2	Condensation of higher codimensional topological defects	85
5.2.1	General theory	85
5.2.2	General examples	88
5.2.3	Examples	89

<b>6</b>	<b>Generalizations and Applications</b>	<b>91</b>
6.1	Higher Morita theory . . . . .	91
6.1.1	Higher Morita equivalences . . . . .	91
6.1.2	Enveloping algebras . . . . .	93
6.2	Integrals and factorization homology . . . . .	96
6.3	Condensations of gapless liquid-like defects . . . . .	99
6.3.1	General theory . . . . .	99
6.3.2	An illustrating example in 2+1D . . . . .	101
6.4	Condensations as interactions . . . . .	102
<b>A</b>	<b>Appendix</b>	<b>105</b>
A.1	Proof of Theorem 4.1.11 . . . . .	105
A.2	Module Eilenberg-Watts calculus . . . . .	109
	<b>References</b>	<b>114</b>

# 1 Introduction

## 1.1 Motivations and historical remarks

In this work, we develop a unified mathematical theory of the condensations of topological defects in topological orders in all dimensions based on higher categories, higher algebras and higher representations. At the end of this work, we briefly discuss the generalization of our theory to the condensations of liquid-like gapless defects in topological orders or quantum liquids.

One of fundamental themes in modern theoretical physics is to establish a new paradigm of phases and phase transitions that can unify traditional spontaneous symmetry-breaking (SSB) orders with exotic new phases discovered since 1980's, including topological orders, symmetry protected/enriched topological (SPT/SET) orders [GW09, CLW11, CGLW13, CGW10] and even certain gapless quantum phases. In order to achieve this goal, it is important to reduce the problem to its simplest form. From a macroscopic point of view, topological orders are the simplest gapped quantum phases because they are gapped, at zero temperature and has no symmetry [Wen90] (see [Wen17, Wen19] for recent reviews). It is exactly this simplicity that led us to the first precise and complete macroscopic description of a 2+1D (spacetime dimension) topological order in terms of modular tensor categories [MS89, FRS89, FG90, Reh90, Kit06]. The macroscopic descriptions of other gapped quantum liquids were discovered much later and are much more complicated [BBCW19, LKW16, LKW17, KLWZZ20b, KLWZZ20a, KZ22b, KWZ22, XZ22]. Therefore, it is reasonable to first focus the study on the phase transitions among topological orders. It was known that many topological phase transitions among topological orders are driven by the condensations of topological defects [BSS02, BSS03], a process which were also viewed recently as the gauging of non-invertible symmetries (see for example [BT18, TW19, RSS23, LYW23] and references therein). Moreover, defect condensations can also be used to control or define the phase transitions among gapless quantum liquids [KZ21b, CJKYZ20, CW23, LY23, CJW22]. Therefore, the mathematical theory of the condensations of topological defects is an indispensable ingredient of the new paradigm of phase transitions.

Since both the experimental discovery of topological orders and the theoretical discovery of its macroscopic descriptions started in 2+1D, the first thoroughly studied defect condensations in topological orders is the anyon condensations in 2+1D topological orders. The program of studying anyon condensations in physics was initiated by Bais, Schroers, Slingerland in 2002 [BSS02, BSS03]. After some successful developments in special cases (see for example [BS09, BSH09, BSS11, KS11, FSV13, Lev13, BJQ13] and [Bur18] for a physical review), a rather complete theory of anyon condensations (or boson condensation) based on category theory was established in [Kon14]. This theory is based on many earlier mathematical works on algebras in braided fusion 1-categories [BEK99, KO02, FFRS06, DMNO13]. A detailed account of the historical developments of the anyon condensation theory before 2013 can be found in [Kon14, Section 1].

However, the anyon condensations do not tell a complete story of topological phase transitions between two 2+1D topological orders. A manifestation of this fact is that an anyon condensation from one 2+1D topological order to another one is not reversible. On the other hand, an experimental or lattice model realization of a phase transition is always reversible. The reason behind this incompleteness is because anyons do not cover all topological defects in a 2+1D topological order. Indeed, anyons are topological defects of codimension 2 (or 2-codimensional topological defects). There are non-trivial 1-codimensional topological defects in a 2+1D topological order [KK12]. These topological defects form a monoidal 2-category [KK12, KW14]. It turns out that all of these 1-codimensional topological defects can be obtained from anyons via condensations [CR16, Kon14], thus are called condensation descendants or condensed defects [KW14]. Mathematically, the process of finding all condensation descendants from a subset of defects (such as anyons) is called condensation completion (already conjectured in [KW14]). It was first introduced by Carqueville and Runkel in [CR16] for 2-categories under the name of “orbifold completion”. It was later thoroughly developed by Douglas and Reutter in [DR18] under the name

of “idempotent completion”, and was used there to give a mathematical definition of multi-fusion 2-category and a state-sum construction of 3+1D TQFT’s. Combining it with other known mathematical results, it becomes clear that the monoidal 2-category of topological defects of codimension 1 or higher in a 2+1D topological order is actually a fusion 2-category (see also [KLWZZ20b] for a detailed explanation). Condensation completion was generalized to higher categories By Gaiotto and Johnson-Freyd in [GJF19] under the name of “Karoubi completion” or “condensation completion”. The compatibility between condensation completion and boundary-bulk relation [KWZ15, KWZ17] was shown in [KTZ20b] for 3+1D Dijkgraaf-Witten theories, and was proved in general context by Johnson-Freyd in [JF22] (see [KZ22b] for a slightly different approach). This compatibility was also proposed in [KLWZZ20b] as general physical principle beyond topological orders (see also [KZ22b]). The theory of condensation completion was also generalized to gapless quantum liquids [KZ22b, KZ22c].

Although the condensation theory of topological defects was significantly advanced by the condensation completion theory, there are still a lot of important questions that are left unstudied. The condensation of a 1-codimensional topological defect is always reversible. It was essentially covered for 1+1D anomalous topological orders in [CR16, Kon14] and for higher dimensional cases in the condensation completion theory [GJF19] (see also a related work [LYW23] on gauging 1-codimensional symmetries). Unfortunately, these results are too brief and are lack of systematic constructions of examples. Moreover, it was not so clear what it means by condensing a  $k$ -codimensional topological defect for  $k > 1$  (except some limited cases [KW14, ZLZH<sup>+</sup>23, DX23]). The relation between the condensations of topological defects of different codimensions has not been studied, and systematic constructions of examples were not available in literature. Recently, the category theory of anyon condensations has driven a lot of works on the study of topological phase transitions in 1+1D [CJKYZ20, CW23, LY23, CJW22]. As we are entering a new era of studying topologically phase transitions, there are increasing demands to have a fully developed mathematical theory of condensations in higher dimensions.

The main goal of this work is to develop such a theory, i.e., a theory of the condensations of  $k$ -codimensional topological defects in a (potentially anomalous)  $n+1$ D topological order for  $1 \leq k < n$ . We show that this theory naturally leads us to the mathematical theory of higher algebras in higher monoidal categories and their higher representations. We also provide some systematic constructions of examples. The associated physical or mathematical ideas naturally generalizes to more general quantum phases. We briefly explain that at the end of this work.

## 1.2 Main results

In order to state the main results, we need first introduce some notations and mathematical notions. We want to keep it brief because a detailed and self-contained introduction is impossible for this section. All necessary mathematical notions are discussed in later sections.

Consider a (potentially anomalous)  $n+1$ D topological order  $C^{n+1}$ , where the superscript ‘ $n+1$ ’ represents the spacetime dimension. We want to define what we mean by condensing a  $k$ -codimensional topological defect  $A$  in  $C^{n+1}$ . This condensation produces a new topological order denoted by  $D^{n+1}$  and a gapped domain wall denoted by  $M^n$ . We denote the categories of topological defects of all codimensions in  $C^{n+1}$  (resp.  $D^{n+1}$ ) by  $\mathcal{C}$  (resp.  $\mathcal{D}$ ), which is an  $E_1$ -multi-fusion  $n$ -category [JF22, KZ22b]. The gapped domain wall  $M^n$  can be described by a pair  $(\mathcal{M}, m)$ , where  $\mathcal{M}$  is the category of all wall conditions and  $m$  is a distinguished wall condition. We define  $\Omega\mathcal{C}$ , called the looping of  $\mathcal{C}$ , by  $\Omega\mathcal{C} := \text{hom}_{\mathcal{C}}(\mathbb{1}_{\mathcal{C}}, \mathbb{1}_{\mathcal{C}})$  and set  $\Omega_m\mathcal{M} := \text{hom}_{\mathcal{M}}(m, m)$ . We define  $\Omega^k\mathcal{C} = \Omega(\Omega^{k-1}\mathcal{C})$  inductively. It is known that  $\Omega^{k-1}\mathcal{C}$  is  $E_k$ -multi-fusion  $(n-k+1)$ -category [KZ22b], which is a direct sum of indecomposable summands. We denote the summand of  $\Omega^{k-1}\mathcal{C}$  consisting of the tensor unit by  $\Sigma\Omega^k\mathcal{C}$ , which is called the delooping of  $\Omega^k\mathcal{C}$ . Mathematically, the delooping of an  $E_1$ -multi-fusion  $l$ -category  $\mathcal{A}$  can be defined by a one-point delooping followed by condensation completion [GJF19] (see a physical review in Section 2.2), and can be mathematically identified with the category  $\text{RMod}_{\mathcal{A}}((l+1)\text{Vec})$  of right separable  $\mathcal{A}$ -modules, or equivalently, right  $\mathcal{A}$ -modules in  $(l+1)\text{Vec}$  [GJF19], where  $n\text{Vec} := \Sigma^n\mathbb{C}$  [GJF19].

Now we summarize the main result of this work.

**Theorem<sup>ph</sup> 1.2.1.** A  $k$ -codimensional topological defect  $A$  in  $C^{n+1}$  is condensable if  $A$  is a condensable  $E_k$ -algebra in  $\Omega^{k-1}\mathcal{C}$ . By condensing  $A$ , we mean a  $k$ -step process explained below.

1. We first condense  $A$  along one of the transversal directions of  $A$ , thus obtaining a  $(k-1)$ -codimensional defect  $\Sigma A$  in  $\Sigma\Omega^{k-1}\mathcal{C} \subset \Omega^{k-2}\mathcal{C}$ . It turns out that  $\Sigma\Omega^{k-1}\mathcal{C}$  can be identified with  $\text{RMod}_{\Omega^{k-1}\mathcal{C}}((n-k+2)\text{Vec})$ , which can be viewed as a coordinate system of  $\Sigma\Omega^{k-1}\mathcal{C}$ . In this coordinate system,  $\Sigma A$  can be identified with the category  $\text{RMod}_A(\Omega^{k-1}\mathcal{C})$  of left  $A$ -modules in  $\Omega^{k-1}\mathcal{C}$ , i.e.  $\Sigma A = \text{RMod}_A(\Omega^{k-1}\mathcal{C})$ .
2. It turns out that  $\Sigma A$  is automatically a condensable  $E_{k-1}$ -algebra in  $\Sigma\Omega^{k-1}\mathcal{C}$  and, therefore, a condensable  $E_{k-1}$ -algebra in  $\Omega^{k-2}\mathcal{C}$ , which can be further condensed along one of the remaining transversal directions. So on and so forth.
3. In the  $(k-1)$ -th step, we obtain a 1-codimensional topological defect  $\Sigma^{k-1}A$ , which is automatically a condensable  $E_1$ -algebra in  $\mathcal{C}$ . By condensing  $\Sigma^{k-1}A$  in  $\mathcal{C}$  along the unique remaining transversal direction, we obtain a new topological order  $D^{n+1}$  and a gapped domain wall  $M^n$  such that

$$\mathcal{D} \simeq \text{Mod}_{\Sigma^{k-1}A}^{E_1}(\mathcal{C}), \quad \Omega_m \mathcal{M} \simeq \text{RMod}_{\Sigma^{k-1}A}(\mathcal{C}), \quad \text{and} \quad m = \Sigma^{k-1}A \in \mathcal{M},$$

where  $\text{Mod}_{\Sigma^{k-1}A}^{E_1}(\mathcal{C})$  denotes the category of  $E_1$ -modules over  $\Sigma^{k-1}A$  in  $\mathcal{C}$  and  $\text{RMod}_{\Sigma^{k-1}A}(\mathcal{C})$  denotes the category of right  $\Sigma^{k-1}A$ -module in  $\mathcal{C}$ . The category of topological defects of codimension  $k$  and higher in  $D^{n+1}$  is determined by the following canonical  $E_k$ -monoidal equivalence:

$$\Omega^{k-1}\mathcal{D} = \Omega^{k-1} \text{Mod}_{\Sigma^{k-1}A}^{E_1}(\mathcal{C}) \simeq \text{Mod}_A^{E_k}(\Omega^{k-1}\mathcal{C}),$$

where  $\text{Mod}_A^{E_k}(\Omega^{k-1}\mathcal{C})$  denotes the  $E_k$ -modules over  $A$  in  $\Omega^{k-1}\mathcal{C}$ .

4. For  $1 \leq i \leq k$ ,  $i$ -codimensional topological defects in  $\Omega^{i-1}\mathcal{C}$  move onto the wall according to the functor

$$L_i := - \otimes \Sigma^{k-i}A : \Omega^{i-1}\mathcal{C} \rightarrow \Omega_m^{i-1}\mathcal{M};$$

and those in  $D^{n+1}$  move onto the wall according to the functor

$$R_i := \Sigma^{k-i}A \otimes_{\Sigma^{k-i}A} - : \Omega^{i-1}\mathcal{D} \rightarrow \Omega_m^{i-1}\mathcal{M}.$$

5.  $C^{n+1}$  and  $D^{n+1}$  share the same gravitational anomaly. In other words, they are gapped boundaries of the same anomaly-free  $n+2$ D topological order as illustrated below.

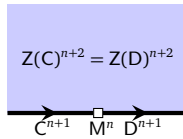

where  $Z(C)^{n+2}$  and  $Z(D)^{n+2}$  denote the bulk of  $C^{n+1}$  and  $D^{n+1}$ , respectively. Mathematically, it implies the following results.

$$\mathfrak{Z}_1(\mathcal{C}) \simeq \mathfrak{Z}_1(\text{Mod}_{\Sigma^{k-1}A}^{E_1}(\mathcal{C})), \quad (1.2.1)$$

$$\mathfrak{Z}_0(\text{RMod}_{\Sigma^{k-1}A}(\mathcal{C})) \simeq \text{Mod}_{\Sigma^{k-1}A}^{E_1}(\mathcal{C})^{\text{op}} \boxtimes_{\mathfrak{Z}_1(\mathcal{C})} \mathcal{C}, \quad (1.2.2)$$

$$\mathcal{D}^{\text{op}} \simeq \text{Mod}_{\Sigma^{k-1}A}^{E_1}(\mathcal{C})^{\text{op}} \simeq \mathfrak{Z}_1(\mathcal{C}, \mathfrak{Z}_0(\text{RMod}_{\Sigma^{k-1}A}(\mathcal{C}))), \quad (1.2.3)$$

where  $\mathfrak{Z}_1(-)$  is the  $E_1$ -center and  $\mathfrak{Z}_0(-)$  is the  $E_0$ -center (see Definition 2.3.15) and the superscript <sup>op</sup> is defined in Definition 2.3.3. Our convention of left and right is explained below Figure 3.

When all  $l$ -codimensional topological defects in  $C^{n+1}$  for  $l < k$  are all condensation descendants of  $k$ -codimensional topological defects, i.e.  $\mathcal{C} \simeq \Sigma^{k-1}\Omega^{k-1}\mathcal{C}$ , we can define the condensation process by condensing  $A$  directly along all  $k$ -transversal directions, thus defining a phase transition that reproduces the phase  $D^{n+1}$ . More precisely, we have the following results.

1. We have the following natural equivalences:

$$\mathcal{D} \simeq \text{Mod}_{\Sigma^{k-1}A}^{\text{E}_1}(\mathcal{C}) \simeq \mathfrak{Z}_1(\mathcal{C}, \mathfrak{Z}_0(\text{RMod}_{\Sigma^{k-1}A}(\mathcal{C})))^{\text{op}} \quad (1.2.4)$$

$$\mathcal{M} \simeq \text{RMod}_{\Sigma^{k-1}A}(\mathcal{C}) \simeq \Sigma^k \text{RMod}_A(\Omega^{k-1}\mathcal{C}), \quad (1.2.5)$$

where the first equivalence is a monoidal equivalence.

2. The  $k$ -codimensional topological defects in  $C^{n+1}$  and  $D^{n+1}$  move onto the wall according to the following functors:

$$L_k := - \otimes A : \Omega^{k-1}\mathcal{C} \rightarrow \Omega_m^{k-1}\mathcal{M}, \quad R_k := A \otimes_A - : \Omega^{k-1}\mathcal{D} \rightarrow \Omega_m^{k-1}\mathcal{M}.$$

both of which are  $E_k$ -central functors that can be lifted to an  $E_k$ -monoidal equivalence:

$$\text{Mod}_A^{\text{E}_k}(\Omega^{k-1}\mathcal{C})^{\text{op}} \simeq \mathfrak{Z}_k(\Omega^{k-1}\mathcal{C}, \mathfrak{Z}_{k-1}(\text{RMod}_A(\Omega^{k-1}\mathcal{C}))). \quad (1.2.6)$$

where  $\mathfrak{Z}_k(-, -)$  denotes the  $E_k$ -centralizer and  $\mathfrak{Z}_{k-1}(-)$  denote the  $E_{k-1}$ -center.

For readers convenience, we spell out a special case when  $C^{n+1}$  is anomaly-free.

**Corollary<sup>ph</sup> 1.2.2.** Let  $C^{n+1}$  be an anomaly-free topological order and  $A$  is a condensable  $k$ -codimensional topological defect in  $C^{n+1}$ . We can modify the  $k$ -step process of condensing  $A$  by combining the last two steps into a single step of condensing  $\Sigma^{k-2}A$  in  $\Omega\mathcal{C}$  directly in the remaining two transversal directions. Note that  $\Sigma^{k-2}A$  is automatically a condensable  $E_2$ -algebra in  $\Omega\mathcal{C}$ . This condensation reproduce the same condensed phase  $D^{n+1}$  and the same gapped domain wall  $M^n$  as explained below.

1. We have the following monoidal equivalences:

$$\Omega\mathcal{D} \simeq \text{Mod}_{\Sigma^{k-2}A}^{\text{E}_2}(\Omega\mathcal{C}) \quad \text{and} \quad \Omega_m\mathcal{M} \simeq \text{RMod}_{\Sigma^{k-2}A}(\Omega\mathcal{C}), \quad (1.2.7)$$

where the first one is a braided equivalence or an  $E_2$ -monoidal equivalence.

2. The 2-codimensional topological defects in  $C^{n+1}$  and  $D^{n+1}$  move onto the wall according to the following functors:

$$L_2 := - \otimes \Sigma^{k-2}A : \Omega\mathcal{C} \rightarrow \Omega_m\mathcal{M}, \quad R_2 := \Sigma^{k-2}A \otimes_{\Sigma^{k-2}A} - : \Omega\mathcal{D} \rightarrow \Omega_m\mathcal{M}.$$

both of which are central functors that can be lifted to an  $E_2$ -monoidal (or braided) equivalence:

$$\mathfrak{Z}_1(\text{RMod}_{\Sigma^{k-2}A}(\Omega\mathcal{C})) \simeq \Omega\mathcal{C} \boxtimes \text{Mod}_{\Sigma^{k-2}A}^{\text{E}_2}(\Omega\mathcal{C})^{\text{op}}.$$

or equivalently, an  $E_2$ -monoidal (or braided) equivalence:

$$\text{Mod}_{\Sigma^{k-2}A}^{\text{E}_2}(\Omega\mathcal{C})^{\text{op}} \simeq \mathfrak{Z}_2(\Omega\mathcal{C}, \mathfrak{Z}_1(\text{RMod}_{\Sigma^{k-2}A}(\Omega\mathcal{C}))).$$

3. Its compatibility to the  $k$ -step condensation leads the following equivalences:

$$\text{Mod}_{\Sigma^{k-1}A}^{\text{E}_1}(\mathcal{C}) \simeq \Sigma \text{Mod}_{\Sigma^{k-2}A}^{\text{E}_2}(\Omega\mathcal{C}) \quad \text{and} \quad \text{RMod}_{\Sigma^{k-1}A}(\mathcal{C}) \simeq \Sigma \text{RMod}_{\Sigma^{k-2}A}(\Omega\mathcal{C}), \quad (1.2.8)$$

where the first equivalence is a monoidal equivalence.

**Remark 1.2.3.** We provide some general constructions of condensable  $E_k$ -algebras in Section 3.2.2, 4.2.2, 5.2.2, and some concrete examples in Section 3.2.3, 3.2.4, 4.1.2, 4.2.4, 5.1.2 and 5.2.3. Moreover, we emphasize a geometric way to understand higher algebras and higher representations (see Section 2.3.1, 2.3.2 and 4.1.1, and a geometric way to construct these condensable  $E_k$ -algebras so that some computations can be carried out by purely geometrically intuitions (see Section 3.1.2, 3.1.2, 4.1.3, 4.2.1, 6.2 and 6.3.2).  $\diamond$

Above main results simply says that the mathematical theory of defect condensations is essentially the theory of higher algebras (e.g.,  $E_k$ -algebras) and higher representations (e.g.,  $E_k$ -modules). We explain many of these mathematical notions in details in later sections. However, the rigorous and complete mathematical definitions of these higher algebras or representations are too technical for this paper, which is aimed at physics oriented readers. A more mathematical treatment of this subject will appear in a mathematical companion of this paper [KZZZ24]. Therefore, in this work, we take a new strategy. Instead of a completely rigorous treatment, we provide an almost self-contained story, in which some mathematical complexity is replaced by physical principles and self-evident geometric or physical intuitions. One of the main goal of this work is to show that these geometric and physical intuitions, together with necessary physical principles, are so powerful that they allow us to build a self consistent and rather complete theoretical framework, in which many precise mathematical results can be derived as natural consequences. Moreover, this framework allows us to establish a precise correspondence between geometric or physical manipulations and algebraic computations. Once this correspondence is solidly established, we are able to do precise computations based on purely geometric intuitions. This leads us to a lot of new results that are not available in mathematical literature.

**Remark 1.2.4.** Even within this self-contained theoretical framework, it is still unavoidable to have mathematically technical parts. In order to control the complexity of mathematics in the main text, we move some mathematically technical or advanced results to Appendix.  $\diamond$

In this work, we mainly focus on the condensations of topological defects in topological orders. However, our theory naturally generalizes to situations beyond topological defects. In Section 6.3, we briefly discuss how our theory generalizes to the condensations of liquid-like gapless defects in topological orders and the condensations of quantum liquids, and provide an illustrating example. More detailed study of this generalization will appear elsewhere.

**Remark 1.2.5.** While we are preparing this paper, a short paper on the gauging of non-invertible symmetries by Longye Wang, Gen Yue and Tian Lan appeared [LYW23]. It is related to our work but not very directly, and is somewhat orthogonal to the content of this work.  $\diamond$

### 1.3 Layout, conventions and notations

**Layout:** In Section 2, we review the mathematical theory of topological defects in an  $n+1$ D topological orders based on the remote detectable principle, boundary-bulk relation and condensation complete principle. We also review the notions of  $E_m$ -multi-fusion  $n$ -categories and explain that an  $E_m$ -monoidal  $n$ -category can be viewed as an  $n$ -category equipped with a tensor product in each of  $n$  independent directions. We also introduce some notations along the way. In Section 3, we show that a phase transition from a topological order  $C^{n+1}$  to another  $D^{n+1}$  can be defined by the condensation of a 1-codimensional topological defects. In Section 4, we show that, when  $C^{n+1}$  is anomaly-free, the same condensation can be defined by condensing a 2-codimensional topological defect directly. In Section 5, we study the condensation of  $k$ -codimensional topological defects and give the main results of this work as summarized in this Section. In Section 6, we outline a few directions that this theory should be further developed or generalized, including a under-developed higher Morita theory, the relation to the theory of factorization homology, a generalization to a yet-to-be-developed condensation theory of (potentially gapless) quantum liquids and some applications.



**Conventions:** Throughout this work, we use  $n+1D$  to denote the spacetime dimension. We mainly use spacetime dimension in this work because the  $n+1D$  spacetime dimension matches with the  $n+1$ -levels of hierarchical structure of an  $n$ -category. However, almost all the illustrating pictures are drawn in the spatial dimensions because  $E_k$ -monoidal structure matches with the spatial dimension. For example, particles on a line in the spatial dimension can be fused in one spatial dimension, thus forming an  $E_1$ -fusion 1-category or simply a fusion 1-category.

Throughout this work, we use “Theorem<sup>ph</sup>” to highlight a physical result and use “Theorem” to represent a mathematical result.

**Notations:** In this work, we systematically introduce a lot of formal notations. For example, we denote a simple statement like: “ $\mathcal{A}$  is a fusion 1-category” by “ $\mathcal{A} \in \text{Alg}_{E_1}^c(2\text{Vec})$ ”. Although we are aware of the danger of turning physics oriented readers away, we do it for an important reason. We slowly introduce the formal language when we review the more familiar situations in lower dimensions (but often from a new perspective). Once the readers get used to the new formal language, they will start to appreciate the power of categorical language when we move on to higher dimensional theories. For example, a simple notation  $A \in \text{Alg}_{E_1}^c(\text{Mod}_A^{E_k}(\mathbb{C}))$  means a thousand words. Indeed, it summarizes incredible amount of structures, which were completely out of reach before the advent of this categorical language. Without such a powerful language, the higher condensation theory is simply impossible.

Most of the notations are introduced carefully when they first appear. However, we highlight a few important conventions on notations.

- We denote  $n+1D$  (potentially anomalous) topological orders by  $A^{n+1}, B^{n+1}, C^{n+1}, D^{n+1}, \dots$ , and denote their categories of all topological defects (of codimension 1 and higher) by  $\mathcal{A}, \mathcal{B}, \mathcal{C}, \mathcal{D}$ , respectively. We carefully distinguish  $A^{n+1}$  with  $\mathcal{A}$  simply because they have different meanings and play different roles in the category of topological orders.
- We use  $\text{Vec}$  to denote the category of finite dimensional vector spaces over the complex number field  $\mathbb{C}$ . It can be treated as the definition of the delooping of  $\mathbb{C}$ , i.e.,  $\Sigma\mathbb{C} := \text{Vec}$ .
- We use  $(n+1)\text{Vec}$ , which is defined by iterated deloopings  $\Sigma^{n+1}\mathbb{C}$  (see Section 2.2 for more details), to denote the category of separable  $n$ -categories. Intuitively, one can view a separable  $n$ -category  $\mathcal{S}$  as a “finite dimensional  $n$ -vector space”. We set  $\mathcal{S}^{\text{op}} := \mathcal{S}^{\text{op}1}$ , i.e., flipping all 1-morphisms.
- $\mathcal{B} \in \text{Alg}_{E_k}^c((n+1)\text{Vec})$  means that  $\mathcal{B}$  is a  $E_k$ -multi-fusion  $n$ -category, and, at the same time, a condensable  $E_k$ -algebra in  $(n+1)\text{Vec}$ .
- $A \in \text{Alg}_{E_k}^c(\mathcal{B})$  means that  $A$  is a condensable  $E_k$ -algebra in an  $E_k$ -fusion higher category  $\mathcal{B}$ .
- $\text{LMod}_A(\mathcal{B}), \text{RMod}_A(\mathcal{B}), \text{BMod}_A(\mathcal{B})$  and  $\text{Mod}_A^{E_k}(\mathcal{B})$  represent the categories of left  $A$ -modules, right  $A$ -modules,  $A$ - $A$ -bimodules and  $E_k$ - $A$ -modules in  $\mathcal{B}$ , respectively.

**Acknowledgements:** We would like to thank Tian Lan and Xiao-Gang Wen for help on references. LK and ZHZ are supported by NSFC (Grant No. 11971219) and by Guangdong Provincial Key Laboratory (Grant No. 2019B121203002) and by Guangdong Basic and Applied Basic Research Foundation (Grant No. 2020B1515120100). ZHZ is also supported by Wu Wen-Tsun Key Laboratory of Mathematics at USTC of Chinese Academy of Sciences. JHZ is partially supported by NSFC (Grant No.11571343). HZ is supported by NSFC under Grant No. 11871078 and by Startup Grant of Tsinghua University and BIMSA.

## 2 Categories of topological defects

In this section, we review the theory of topological defects in topological orders, which includes three important guiding principles: Remote Detectable Principle, Boundary-Bulk Relation and Condensation Completion Principle. They form a theoretical foundation of our higher condensation theory and are used throughout this work. Along the way, we introduce some important notions and notations that are used in this work.

### 2.1 Categories of topological defects

#### 2.1.1 2+1D topological orders

The study of topological defects in TQFT's or topological orders was initiated from that of the Wilson lines in 2+1D TQFT's [Wit89, RT91] and, around the same time, that of the anyons in 2+1D anomaly-free topological orders [MS89, FRS89, FG90, Reh90, Wen91]. We start from a review of the theory of anyons in a 2+1D anomaly-free topological order before we move onto the higher dimensional theory.

Consider a 2+1D anomaly-free topological order  $\mathcal{C}^3$ . It can have 2-codimensional topological defects, which are particle-like topological excitations in spatial dimension picture and are also called anyons or particles. In the spacetime picture, an anyon is also called a Wilson line, which is the world line of the anyon. It is possible to have 0D defects connecting two potentially different Wilson lines. Such a 0D defect, or a 3-codimensional defect, is also called an instanton. Anyons can be fused. More precisely, for two anyons  $a$  and  $b$ , their fusion is denoted by  $a \otimes b$ . Moreover, anyons can be braided. This amounts to a braiding isomorphism

$$c_{a,b} : a \otimes b \xrightarrow{\cong} b \otimes a.$$

The composed isomorphism ( $a \otimes b \xrightarrow{c_{a,b}} b \otimes a \xrightarrow{c_{b,a}} a \otimes b$ ) is called the double braiding, which amounts to an adiabatic move of the  $a$ -particle along a circle around the  $b$ -particle as illustrated in Figure 1. The complete set of anyons and instantons, together with the fusions and braidings among anyons, form a mathematical structure called a braided fusion 1-category<sup>1</sup> [MS89, FRS89, FG90, Reh90, Kit06] (see [KZ22a] for a recent review). We denoted this braided fusion 1-category by  $\Omega\mathcal{C}$ , a notation which represents the looping of  $\mathcal{C}$  and is explained later in (2.1.1). Moreover, the braidings of  $\Omega\mathcal{C}$  are required to be *non-degenerate* in the sense that the  $S$ -matrix, whose entries are the trace of double braidings of two simple objects, is non-degenerate [MS89, RT91] (see [Kit06] for a review). The simplest non-degenerate braided fusion 1-category is the category  $\text{Vec}$  of finite dimensional vector spaces over  $\mathbb{C}$ . It is precisely the category of anyons in the 2+1D trivial topological order, which is denoted by  $\mathbf{1}^3$ .

Concrete lattice models realizing non-chiral 2+1D topological orders (i.e. those admitting gapped boundaries), such as Kitaev's quantum double model [Kit03] and Levin-Wen models [LW05], were constructed. Anyons in these models were intensively studied and were shown to form a non-degenerate braided fusion 1-category [Kit03, KK12]. It was proposed in [Kit06] that a 2+1D topological order  $\mathcal{C}^3$  can be completely characterized by the data  $\Omega\mathcal{C}$  up to invertible topological orders, or equivalently, by a pair  $(\Omega\mathcal{C}, c)$ , where  $c$  is the chiral central charge. For example, a non-chiral 2+1D topological order can be described by the pair  $(\mathfrak{Z}_1(\mathcal{A}), 0)$  [LW05, KK12], where  $\mathcal{A}$  is a fusion 1-category and  $\mathfrak{Z}_1(\mathcal{A})$  is its Drinfeld center (which is a non-degenerate braided fusion 1-category [Mü03, DGNO10]). This proposal was soon accepted by the community.

However, this proposal became puzzling and questionable after a new discovery. In [KK12], it was shown explicitly via lattice model constructions that a non-chiral 2+1D topological order  $\mathcal{C}^3$  can have non-trivial 1-codimensional topological defects as depicted in Figure 1, and these defects, together with

<sup>1</sup>Actually, in physics,  $\Omega\mathcal{C}$  is necessarily a modular tensor category, which is a non-degenerate braided fusion 1-category, together with a ribbon structure. Moreover, unitarity is often assumed. We prefer to ignore both structures for simplicity and for the reason that the roles played by them in condensation theory are not essential. But we secretly assume the unitarity in all pictures.

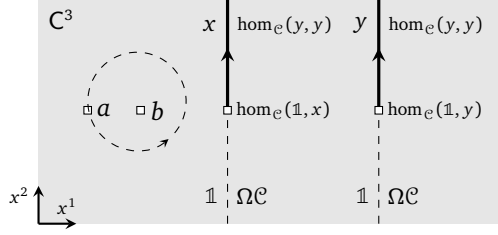

Figure 1: This picture illustrate some defects in a 2+1D topological order  $\mathcal{C}$  in spatial dimensions: two 1-codimensional defect  $x, y \in \mathcal{C}$ , a domain wall between  $\mathbb{1}$  and  $x$ , a domain wall between  $\mathbb{1}$  and  $y$  and two anyons  $a, b \in \Omega\mathcal{C}$ .

all higher codimensional topological defects form a monoidal 2-category  $\mathcal{C}$ . We explain the ingredients of this 2-category  $\mathcal{C}$  below.

- 0-morphisms (or objects) are 1-codimensional topological defects (i.e., string-like defects in the spatial dimension, or strings for simplicity);
- 1-morphisms are 2-codimensional topological defects, including those 2-codimensional topological defects that are domain walls between two (potentially non-trivial) 1-codimensional topological defects.
- 2-morphisms are 3-codimensional topological defects (i.e., instantons or 0D operators in space-time).

The tensor product of  $\mathcal{C}$  is given by the horizontal fusion of two 1-codimensional topological defects (e.g.,  $x \otimes y$  in Figure 1), and the tensor unit of  $\mathcal{C}$  is the trivial 1-codimensional topological defect, denoted by  $\mathbb{1}_e$ . Since a particle can be viewed as a domain wall between two trivial 1-codimensional defects, the category of particles in  $C^3$  is precisely given by the following 1-category:

$$\Omega\mathcal{C} := \text{hom}_{\mathcal{C}}(\mathbb{1}_e, \mathbb{1}_e), \quad (2.1.1)$$

which is called the looping of  $\mathcal{C}$ . We denote the full sub-2-category of  $\mathcal{C}$  consisting of a single object  $\mathbb{1}_e$  by  $B\Omega\mathcal{C}$ , which is called one-point delooping of  $\Omega\mathcal{C}$ , i.e.

$$B\Omega\mathcal{C} := \begin{array}{c} \Omega\mathcal{C} \\ \curvearrowright \\ \mathbb{1}_e \end{array} \quad (2.1.2)$$

Notice that  $B\Omega\mathcal{C}$  does not contain more information than  $\Omega\mathcal{C}$ .

**Remark 2.1.1.** We do not give a precise definition of a topological defect. Instead, we give a brief clarification. In this work, by a  $k$ -codimensional topological defect in  $C^{n+1}$ , we mean an anomalous  $(n - k + 1)$ D topological order (i.e., a gapped quantum liquid without symmetry). In other words, we assume a liquid-like property [KZ22b, KZ22c]. Physically, by ‘liquid-like’ we mean that the defect can be bent freely without any change and the fusions among such defects are well-defined. Mathematically, it means that the category of all such gapped liquid-like defects are well-defined and fully dualizable [Lur09]. Note that it was known that there are non-liquid quantum phases [Cha05, Haa11], which can be viewed as non-liquid-like defects in the higher dimensional trivial phase. In general, if we stack a  $k$ D topological defect with a gapped  $k$ D non-liquid, we obtain a gapped non-topological defect. Non-liquid-like defects are not dualizable in general. In this work, we ignore non-liquid gapped defects or domain walls completely. In particular, by a ‘gapped defect’, we always mean a topological defect unless we specified otherwise.  $\diamond$

When  $\Omega\mathcal{C} = \mathfrak{Z}_1(\mathcal{A})$  for a fusion 1-category  $\mathcal{A}$  and  $c = 0$ ,  $\mathcal{C}^3$  admits gapped boundaries. In this case, it was shown in [KK12] that a 1-codimensional topological defect in  $\mathcal{C}$  can be constructed in a generalized Levin-Wen models [LW05] based on the defining data of a finite semisimple  $\mathcal{A}$ - $\mathcal{A}$ -bimodule  $\mathcal{M}$ . By “finite semisimple”, we mean a 1-category that is equivalent to a finite direct sum of  $\text{Vec}$ . We denote the 2-category of finite semisimple 1-categories by  $2\text{Vec}$ . Then a finite semisimple  $\mathcal{A}$ - $\mathcal{A}$ -bimodule simply means an  $\mathcal{A}$ - $\mathcal{A}$ -bimodule in  $2\text{Vec}$ . We denote by  $\text{BMod}_{\mathcal{A}|\mathcal{A}}(2\text{Vec})$  the 2-category of  $\mathcal{A}$ - $\mathcal{A}$ -bimodules in  $2\text{Vec}$  (as objects), bimodule functors (as 1-morphisms) and bimodule natural transformations (as 2-morphisms). Then the main results in [KK12] says that  $\mathcal{C} = \text{BMod}_{\mathcal{A}|\mathcal{A}}(2\text{Vec})$ . The 2-category  $\text{BMod}_{\mathcal{A}|\mathcal{A}}(2\text{Vec})$  has a natural monoidal structure defined by the tensor product  $\boxtimes_{\mathcal{A}}$  (see [EGNO15] for a review) and the tensor unit  $\mathcal{A}$ . Moreover, we have  $\Omega\text{BMod}_{\mathcal{A}|\mathcal{A}}(2\text{Vec}) = \text{Fun}_{\mathcal{A}|\mathcal{A}}(\mathcal{A}, \mathcal{A}) \simeq \mathfrak{Z}_1(\mathcal{A}) = \Omega\mathcal{C}$  exactly as we want.

**Remark 2.1.2.** There is another way to look at the 1-codimensional topological defects in  $\mathcal{C}^3$ . By the folding trick, a 1-codimensional topological defect in  $\mathcal{C}^3$  can be viewed as a gapped boundary of the double-layered system  $\mathcal{C}^3 \boxtimes \overline{\mathcal{C}^3}$ . As a consequence, there is a one-to-one correspondence between the 1-codimensional topological defects in  $\mathcal{C}^3$  and indecomposable  $\Omega\mathcal{C}$ -modules (up to equivalences) [DMNO13, KK12].  $\diamond$

**Example 2.1.3.** We give three examples of  $\mathcal{C}$  that are frequently used in this work.

1. 2+1D trivial topological order  $\mathbf{1}^3$ : The 1-category of anyons is given by  $\text{Vec}$ . Since  $\mathbf{1}^3$  can be realized by Levin-Wen model defined by the trivial fusion 1-category  $\text{Vec}$ . The monoidal 2-category of all defects in  $\mathbf{1}^3$  can be identified with  $\text{BMod}_{\text{Vec}|\text{Vec}}(2\text{Vec}) \simeq 2\text{Vec}$ .
2. 2+1D  $\mathbb{Z}_2$  topological order  $\text{TC}^3$ : Since it is realizable by the 2+1D toric code model [Kit03], we denote it by  $\text{TC}^3$ . We denote the 2-category of topological defects in  $\text{TC}^3$  by  $\mathcal{TC}$ . In this case,  $\Omega\mathcal{TC}$  has four simple objects  $1, e, m, f$  and the following fusion rules:

$$e \otimes e \simeq m \otimes m \simeq f \otimes f \simeq 1, \quad f \simeq e \otimes m \simeq m \otimes e.$$

The double braiding between  $e$  and  $m$  is  $-1$ . The self-double-braidings of  $e$  and  $m$  are both trivial, and the self-double-braiding of  $f$  is  $-1$ . Mathematically,  $\Omega\mathcal{TC}$  can be identified with the Drinfeld center  $\mathfrak{Z}_1(\text{Rep}(\mathbb{Z}_2))$  of  $\text{Rep}(\mathbb{Z}_2)$ , where  $\text{Rep}(\mathbb{Z}_2)$  denote the category of finite dimensional representations of the  $\mathbb{Z}_2$  group. The fusion 2-category  $\mathcal{TC}$  can be obtained either by computing

$$\mathcal{TC} = \text{BMod}_{\text{Rep}(\mathbb{Z}_2)|\text{Rep}(\mathbb{Z}_2)}(2\text{Vec})$$

or by explicit constructions in the toric code model [KZ22a]. More precisely, there are six simple 1-codimensional topological defects  $\mathbb{1}, \text{dual}, \text{ss}, \text{sr}, \text{rs}, \text{rr}$  in  $\text{TC}^3$  with the fusion rules given in [KZ22a, Table 1].

3. 2+1D Ising topological order  $\text{Is}^3$ : We denote the 2-category of topological defects in  $\text{Is}^3$  by  $\mathcal{Is}$ . In this case, the 1-category  $\Omega\mathcal{Is}$  of anyons is the well known Ising braided fusion 1-category. It consists of three simple anyons  $1, \psi, \sigma$  with the commutative fusion rules  $\psi \otimes \psi = 1, \psi \otimes \sigma \simeq \sigma, \sigma \otimes \sigma \simeq \sigma \oplus \sigma$ . All its non-trivial braidings are given as follows:

$$\begin{aligned} \psi \otimes \psi &= 1 \xrightarrow{c_{\psi,\psi}=-1} 1 = \psi \otimes \psi; & \psi \otimes \sigma &= \sigma \xrightarrow{c_{\psi,\sigma}=e^{-\frac{\pi i}{2}}} \sigma = \sigma \otimes \psi; \\ \sigma \otimes \psi &= \sigma \xrightarrow{c_{\psi,\sigma}=e^{-\frac{\pi i}{2}}} \sigma = \psi \otimes \sigma; & \sigma \otimes \sigma &= 1 \oplus \psi \xrightarrow{c_{\sigma,\sigma}=e^{-\frac{\pi i}{8}} \oplus e^{\frac{3\pi i}{8}}} 1 \oplus \psi = \sigma \otimes \sigma. \end{aligned}$$

By a result in [FRS02] and [Kon14],  $\mathcal{Is}$  has no non-trivial 1-codimensional topological defect. Therefore, we obtain that  $\mathcal{Is} \simeq \text{B}\Omega\mathcal{Is}$  as monoidal 2-categories.  $\heartsuit$

This result in [KK12] makes the proposal in [Kit06] questionable because the characterization by the pair  $(\Omega^{\mathcal{C}}, c)$  does not contain any 1-codimensional topological defects except the trivial one.

$$\text{Does it mean that the characterization } (\Omega^{\mathcal{C}}, c) \text{ is incomplete?} \quad (2.1.3)$$

The work [KW14] was devoted to answer this question. In order to answer this question, one needs guidances from new physical principles.

### 2.1.2 Remote detectable principle

Since these new physics principles apply to topological orders in all dimensions, we explain them in an arbitrary dimension. We start from recalling some basic notions that are used throughout this work.

**Definition 2.1.4.** Let  $C^{n+1}$  be an  $n+1$ D topological order.

1.  $C^{n+1}$  is called *anomaly-free* if it can be realized by an  $n$ D gapped lattice model; it is called *anomalous* otherwise [KW14].
2.  $C^{n+1}$  is called *non-chiral* if  $C^{n+1}$  is anomaly-free and admits a gapped boundary; and is called *chiral* otherwise.

We denote the trivial  $n+1$ D topological order by  $\mathbf{1}^{n+1}$ . ■

Since an anomalous topological order  $C^{n+1}$  should be always realizable as a topological defect in a higher (but still finite) dimensional lattice model, by a dimensional reduction argument [KW14],  $C^{n+1}$  should be realizable as a gapped boundary of an  $n+2$ D anomaly-free topological order. Moreover, it was shown that this  $n+2$ D anomaly-free topological order is necessarily unique, and is called the *bulk* of  $C^{n+1}$ . We denoted it by  $Z(C)^{n+2}$ . Then the condition that  $C^{n+1}$  is anomaly-free can be mathematically expressed as

$$Z(C)^{n+2} = \mathbf{1}^{n+2}. \quad (2.1.4)$$

For an anomalous topological order  $C^{n+1}$ , we also have an interesting identity<sup>2</sup>:

$$Z(Z(C))^{n+2} = \mathbf{1}^{n+2}. \quad (2.1.5)$$

**Example 2.1.5.** When  $C^{n+1}$  is anomaly-free, then the trivial 1-codimensional topological defect  $\mathbb{1}_{\mathcal{C}}$  can be viewed as an anomalous  $n$ D topological order, denoted by  $C^n$  (i.e.,  $\mathbb{1}_{\mathcal{C}} = C^n$ ), and the trivial domain wall between  $C^{n+1}$  and  $C^{n+1}$ . We apply the folding trick such that  $C^n$  becomes a gapped boundary of a double-layered system as illustrated below:

$$\begin{array}{ccc} \begin{array}{c} \xrightarrow{C^{n+1}} \quad C^n \quad \xrightarrow{C^{n+1}} \\ \xrightarrow{x^1} \end{array} & \xrightarrow{\text{folding trick}} & \begin{array}{c} \overline{C^{n+1}} \\ \boxtimes \\ C^{n+1} \end{array} \end{array} \quad (2.1.6)$$

where  $\overline{C^{n+1}}$  represents the  $n+1$ D topological order obtained from  $C^{n+1}$  by folding and  $\boxtimes$  represents the stacking of two  $n+1$ D topological orders. In this work, we assume that a folding is done in the  $x^1$ -th spatial dimension and depicted as the horizontal direction in pictures. We obtain the following identity:

$$Z(C^n)^{n+1} = C^{n+1} \boxtimes \overline{C^{n+1}}. \quad (2.1.7)$$

♡

---

<sup>2</sup>This identity says that the bulk of a bulk is trivial. It is somewhat dual to the well-known statement in topology: the boundary of a boundary is empty, which leads to a homology theory. Therefore, we expect that the identity (2.1.5) should lead us to a non-trivial but yet-unknown cohomology theory.

Since a topological order is a macroscopic notion, in principle, it should be characterized by the complete set of macroscopic observables, which mainly consists of topological defects. Therefore, the anomaly-free condition of a topological order should be translated to a condition on its macroscopic observables.

Let  $C^{n+1}$  be an anomaly-free  $n+1$ D topological order. It can have topological defects of all codimensions. All possible topological defects in  $C^{n+1}$  form a monoidal  $n$ -category  $\mathcal{C}$ , in which  $k$ -morphisms are  $(k+1)$ -codimensional topological defects for  $0 \leq k \leq n$ ; when  $k = n$ , they are instantons (i.e., 0D defects or  $(n+1)$ -codimensional defects). The monoidal structure on  $\mathcal{C}$ , i.e., a fusion product  $\otimes$  in  $\mathcal{C}$ , is defined by the fusion of two 1-codimensional topological defects. The tensor unit is the trivial 1-codimensional topological defect, denoted by  $\mathbb{1}_e$ . When  $C^{n+1} = \mathbf{1}^{n+1}$ , we denote the  $\mathcal{C}$  in this case by  $n\text{Vec}$ . Note that this notation is compatible with Example 2.1.3. It is possible to give a precise mathematical definition of  $n\text{Vec}$  [GJF19]. We postpone this definition to Section 2.2.

We introduce some useful notations. For a  $k$ -morphism  $f$  in  $\mathcal{C}$ , we denote the identity morphism on  $f$  by  $1_f$ . Physically,  $1_f$  is the trivial  $(k+2)$ -codimensional defect on the  $(k+1)$ -codimensional defect  $f$ . We simplify the notation  $1_{1_f}$  to  $1_f^2$  and define  $1_f^k := 1_{1_f^{k-1}}$  inductively. We define  $\Omega^0 \mathcal{C} := \mathcal{C}$  and

$$\Omega_f \mathcal{C} := \text{hom}_{\mathcal{C}}(f, f), \quad \Omega \mathcal{C} = \Omega_{\mathbb{1}_e} \mathcal{C} := \text{hom}_{\mathcal{C}}(\mathbb{1}, \mathbb{1}), \quad \Omega^k \mathcal{C} := \Omega(\Omega^{k-1} \mathcal{C}) = \text{hom}_{\mathcal{C}}(\mathbb{1}_{\mathbb{1}}^{k-1}, \mathbb{1}_{\mathbb{1}}^{k-1}).$$

In particular,  $\Omega^{n-1} \mathcal{C}$  is the 1-category of particles. Note that an  $n$ -codimensional defect outside of  $\Omega^{n-1} \mathcal{C}$  is not called a particle because it is an end point of a non-trivial higher dimensional defect. Similarly,  $\Omega^{n-2} \mathcal{C}$  is the 2-category of strings. When  $C^{n+1} = \mathbf{1}^{n+1}$ , it is clear that we have

$$\Omega(n\text{Vec}) \simeq (n-1)\text{Vec}. \quad (2.1.8)$$

**Convention 2.1.6.** In this work, we endow the topological order  $C^{n+1}$  with a local coordinate system  $(x^1, x^2, \dots, x^n, x^{n+1} = t)$  such that the fusion product  $\otimes^i$  in  $\Omega^i \mathcal{C}$  as the fusion in the positive  $x^{i+1}$ -th direction (see (2.1.6)). In pictures, we always depicted the fusion of 1-codimensional (or lower-codimensional) topological defects in the horizontal direction. According to this convention, the  $n$ -category of all topological defects of  $\overline{C^{n+1}}$  is given by  $\mathcal{C}^{\text{op}}$ . It is the same category  $\mathcal{C}$  but equipped with a new fusion product  $(\otimes^1)^{\text{op}}$ , which is defined by  $a(\otimes^{\text{op}})b := b \otimes a$  for  $a, b \in \mathcal{C}$ . A better way to define  $\mathcal{C}^{\text{op}}$  is given in Definition 2.3.3.

**Remark 2.1.7.** We denote by  $\mathcal{T}^{\mathcal{O}^{n+1}}$  the  $(n+1)$ -category of anomaly-free  $n+1$ D topological orders (as objects), 1-codimensional gapped domain walls (as 1-morphisms), 2-codimensional gapped domain walls (as 2-morphisms), so on and so forth. Note that the full subcategory of  $\mathcal{T}^{\mathcal{O}^{n+1}}$  consisting of a single object  $C^{n+1}$  is precisely  $\text{B}\mathcal{C}$ , i.e. the one-point delooping of  $\mathcal{C}$ . Actually, the notion of a one point delooping is defined for any monoidal higher category  $\mathcal{A}$  as illustrated below.

$$\text{B}\mathcal{A} := \begin{array}{c} \mathcal{A} = \text{hom}_{\text{B}\mathcal{A}}(\bullet, \bullet) \\ \bullet \curvearrowright \bullet \end{array} \quad (2.1.9)$$

Note that the monoidal structure of  $\mathcal{A}$  is necessary for  $\text{B}\mathcal{A}$  to be well-defined because  $\text{hom}_{\text{B}\mathcal{A}}(\bullet, \bullet)$  has a monoidal structure defined by the composition of 1-morphisms.  $\diamond$

**Definition 2.1.8.** Given an  $n$ -category  $\mathcal{S}$ , we denote the category obtained from flipping all  $k$ -morphisms in  $\mathcal{S}$  by  $\mathcal{S}^{\text{op}^k}$  and that obtained from flipping both  $k$ -morphisms and  $l$ -morphisms by  $\mathcal{S}^{\text{op}^k, \text{op}^l}$ . For convenience, we abbreviate  $\mathcal{S}^{\text{op}^1}$  to  $\mathcal{S}^{\text{op}}$ .  $\blacksquare$

Now we are ready to state a guiding principle: Remote Detectable Principle, which translates the anomaly-free condition of  $C^{n+1}$  (recall (2.1.4)) to a condition on  $\mathcal{C}$ . The following principle was proposed

in [KW14] (preceded by a physical discussion of  $\Omega\mathcal{C}$  in  $n = 2$  cases in [Lev13]).

**Remote Detectable Principle:** In an anomaly-free topological order, a topological defect should be detectable by some topological defects via double braidings unless it is a condensation descendant of braiding-detectable topological defects. (2.1.10)

This principle immediately leads to some non-trivial consequences, which answer the question (2.1.3) completely.

1.  $n = 2$ :

- (a) In this case, only defects of codimension 2 (i.e. anyons) can be braided. If a simple anyon  $x$  has trivial double braidings with all anyons, by the Remote Detectable Principle,  $x$  must be the trivial particle, i.e.  $x = 1_{\mathbb{1}_c}$ . We can restate this result mathematically. For a braided fusion 1-category  $\mathcal{B}$ , we define its  $E_2$ -center  $\mathfrak{Z}_2(\mathcal{B})$  (also called Müger center) by the full subcategory consisting of objects with trivial double braidings with all objects in  $\mathcal{B}$ , i.e.,

$$\mathfrak{Z}_2(\mathcal{B}) := \{z \in \mathcal{B} \mid c_{z,b} \circ c_{b,z} = 1_{z \otimes b}, \forall b \in \mathcal{B}\}.$$

Using this language, the anomaly-free condition of  $C^3$  can be translated into the following condition:

$$\mathfrak{Z}_2(\Omega\mathcal{C}) \simeq \text{Vec}. \quad (2.1.11)$$

It turns out that this equivalence (2.1.11), viewed as an anomaly-free condition, is equivalent to the non-degeneracy condition of the  $S$ -matrix [Mü03] (see also [Lev13] for a physical discussion).

- (b) Note that 1-codimensional defects cannot be braided at all. Is that a violation of the principle? The solution of this contradiction was proposed in [KW14]. It says that if a topological defect is not detectable by braidings (including the not-braidable cases), it has to be a condensation descendant (or condensed defect), which means that it can be obtained from those braiding-detectable defects via condensations. Indeed, it was shown in [Kon14] that all 1-codimensional topological defects and those higher codimensional topological defects in  $C^3$  that are not in  $\Omega\mathcal{C}$  are the condensation descendants of those in  $\Omega\mathcal{C}$ . This result implies that all 1-codimensional defects can be obtained from the trivial 1-codimensional defect  $\mathbb{1}$  via condensations. It also means that all objects in  $\mathcal{C}$  are connected by 2-codimensional topological defects. In summary, we have answered the question (2.1.3). Namely, the pair  $(\Omega\mathcal{C}, c)$  indeed provides a complete mathematical characterization of an anomaly-free 2+1D topological order  $C^3$ , and all the missing topological defects can be recovered from those in  $\Omega\mathcal{C}$  via condensations.

2.  $n > 2$ :

- (a) Again all topological defects in  $\Omega\mathcal{C}$  are braidable and should be detectable via double braidings. As a consequence, if a simple  $k$ -codimensional defect for  $k \geq 2$  has trivial double braidings with all defects in  $\Omega\mathcal{C}$ , it must be the trivial  $k$ -codimensional topological defect  $1_{\mathbb{1}}^k$  or its condensation descendants. Note that in higher dimensions, the ‘trivial double braiding’ does not require the double braiding to be trivial on the nose, instead, it only requires the double braiding to be trivial up to higher isomorphisms. More explicitly, for  $a, b \in \Omega\mathcal{C}$ , the double braiding being trivial means that there is a higher isomorphism  $c_{b,a} \circ c_{a,b} \rightarrow 1_{a \otimes b}$  satisfying natural physical conditions. When  $n = 3$ , these conditions have been explicitly spelled out in [KTZ20b, Definition 3.10] (preceded by a definition in the semistrict<sup>3</sup> cases in

<sup>3</sup>Physical applications demand us to consider non-semistrict monoidal 2-categories.

[Cra98]) as the defining properties of the so-called sylleptic center, which is an  $E_2$ -center<sup>4</sup> and a 2-categorical generalization of the Müger center. In other words, when  $n = 3$ , Remote Detectable Principle simply says that the  $E_2$ -center  $\mathfrak{Z}_2(\Omega\mathcal{C})$  (or the sylleptic center) of  $\Omega\mathcal{C}$  is trivial. Here, being trivial means that it can be identified with the category of topological defects of codimension 2 and higher in the trivial 3+1D topological order  $\mathbf{1}^4$ , i.e.  $\mathfrak{Z}_2(\Omega\mathcal{C}) \simeq 2\text{Vec}$  (recall (2.1.8)). Therefore, for  $n \geq 2$ , we should have

$$\mathfrak{Z}_2(\Omega\mathcal{C}) \simeq (n-1)\text{Vec}. \quad (2.1.12)$$

- (b) Since all the other defects not in  $\Omega\mathcal{C}$ , including all non-trivial 1-codimensional defects, cannot be braided, they are necessarily the condensation descendents of  $\Omega\mathcal{C}$  or better  $B\Omega\mathcal{C}$  [KW14]. Namely, those defects not in  $B\Omega\mathcal{C}$  can all be obtained from those in  $B\Omega\mathcal{C}$  via condensations. In particular, all objects in  $\mathcal{C}$  are connected by 1-morphisms. When  $C^{n+1} = \mathbf{1}^{n+1}$ , we observe that the category  $n\text{Vec}$  of topological defects in  $\mathbf{1}^{n+1}$  contains only trivial  $k$ -codimensional defects for  $k \geq 1$  and their condensation descendents. We return to this observation and make it more mathematically precise in Section 2.2.

**Remark 2.1.9.** Above discussion applies to the case when  $C^{n+1}$  is anomaly-free. If  $C^{n+1}$  is anomalous, in general, 1-codimensional topological defects in  $C^{n+1}$  are not necessarily the condensation descendents of those in  $\Omega\mathcal{C}$ . It means that  $\mathcal{C}$  is disconnected in general when  $C^{n+1}$  is anomalous.  $\diamond$

**Remark 2.1.10.** Although  $\Omega\mathcal{C}$  has already encoded all the data in  $\mathcal{C}$  in the sense that the data is completable, as we will show later,  $\Omega\mathcal{C}$  does not provide a complete story of anyon condensation. For certain problems in condensation theory, it is necessary to consider  $\mathcal{C}$  instead (see Section 4).  $\diamond$

### 2.1.3 Boundary-bulk relation

There is an obvious question: can we use  $\mathcal{C}$  (instead of  $\Omega\mathcal{C}$ ) to give a mathematically equivalent characterization of the anomaly-free condition on  $C^{n+1}$ ? We show below how this question naturally leads us to a new guiding principle.

This question is already non-trivial when  $n = 1$ . In this case, only topological defects are particles and instantons, and they form a 1-category  $\mathcal{C}$ . Since particles can be fused along the 1-dimensional space,  $\mathcal{C}$  is a monoidal 1-category. By Remote Detectable Principle,  $\mathcal{C}$  can only contain the trivial particles. In other words,  $\mathcal{C}$  must be trivial, i.e.  $\mathcal{C} \simeq \text{Vec}$ . This is compatible with the fact that there is no non-trivial 1+1D topological order, proved first in a microscopic approach [CGW10]. In order to formulate the anomaly-free condition on  $\mathcal{C}$ , we need consider the case that  $C^2$  is anomalous, i.e.  $B^3 := Z(C)^3 \neq \mathbf{1}^3$ . This case can be physically realized in lattice model [KK12]. In this case,  $\mathcal{C}$  have non-trivial particles. The bulk particles move onto the boundary and become a boundary particle. This process defines a functor  $f : \Omega\mathcal{B} \rightarrow \mathcal{C}$ , which clearly preserves the fusion products. Mathematically, such a functor is called a monoidal functor. Moreover,  $f(a)$  can be half-braided with  $x \in \mathcal{C}$  as illustrated in Figure 2. This half-braiding structure endows the functor  $f$  with a structure called a central functor [Bez04, FSV13] (see also [KZ22a] for a physical review). This notion is defined by the property that the functor  $f$  can be factorized as the composition of two functors  $\Omega\mathcal{B} \rightarrow \mathfrak{Z}_1(\mathcal{C}) \rightarrow \mathcal{C}$ , where  $\mathfrak{Z}_1(\mathcal{C})$  is the  $E_1$ -center (or Drinfeld center) of  $\mathcal{C}$  and the second functor is the so-called forgetful functor. Then the condition that particles in  $\mathcal{C}$  can be detected by bulk particles via the half braidings [Lev13] can be mathematically reformulated precisely as the following condition [KK12, Kon14]:

$$\Omega\mathcal{B} \simeq \mathfrak{Z}_1(\mathcal{C}), \quad (2.1.13)$$

---

<sup>4</sup>The notion of  $E_2$ -center is a mathematically well-defined notion [Lur17]. Actually, all types of centers, such as usual center of an algebra, Drinfeld center, Müger center and left/right or full centers in 2D conformal field theories, are all universally defined by the same universal property but in different (higher) categories [Lur17, Ost03, Dav10a, KYZ21].



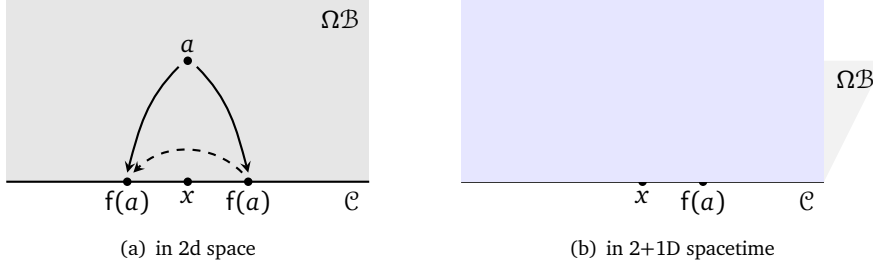

Figure 2: the half-braiding of  $f(a)$  with  $x$

which is also called boundary-bulk relation. In other words, the functor  $f : \Omega\mathcal{B} \rightarrow \mathcal{C}$  can be identified with the forgetful functor  $f : \mathfrak{Z}_1(\mathcal{C}) \rightarrow \mathcal{C}$ . As a consequence, the anomaly-free condition on  $\mathcal{C}^2$  can be translated to a condition on  $\mathcal{C}$  expressed as follows:

$$\mathfrak{Z}_1(\mathcal{C}) \simeq \text{Vec}. \quad (2.1.14)$$

Note that the only fusion 1-category solution of above equation is  $\mathcal{C} \simeq \text{Vec}$  [EGNO15]. This mathematical fact provides a categorical proof of the physical fact that there is no non-trivial 1+1D topological order [CGW10].

The boundary-bulk relation was later generalized to formulations other than (2.1.13) and to all dimensions and to quantum phases far beyond topological orders in [KWZ15, KWZ17, KZ22b]. In summary, it can be stated as follows.

**Boundary-Bulk Relation:** The bulk  $Z(\mathcal{C})^{n+2}$  is the center of a boundary  $\mathcal{C}^{n+1}$ .

(2.1.15)

The proof of this result is completely based on natural physical intuitions and an important notion of a morphism between topological orders [KWZ15, KWZ17]. We should regard (2.1.15) as a formal guiding principle, which leads to concrete predications when we replace  $Z(\mathcal{C})^{n+2}$  and  $\mathcal{C}^{n+1}$  by concrete categories of topological defects. For example, we should still have (2.1.13) for  $n > 1$ , i.e.,

$$\Omega\mathcal{B} \simeq \mathfrak{Z}_1(\mathcal{C}). \quad (2.1.16)$$

**Remark 2.1.11.** One should use the boundary-bulk relation with caution. Notice that both  $\Omega\mathcal{B}$  and  $\mathcal{C}$  give complete descriptions of defects in  $\mathcal{B}^{n+2}$  and  $\mathcal{C}^{n+1}$ , respectively. Here, by  $\Omega\mathcal{B}$  being complete, we mean that it is completable by condensations. This is a necessary condition in the applications of the boundary-bulk relation. If we do not respect this rule and apply it naively, we will have  $\Omega^2\mathcal{B} \simeq \mathfrak{Z}_2(\Omega\mathcal{C})$ , which is not true in general. Therefore, although the boundary-bulk relation (2.1.15) is clearly compatible with the anomaly-free condition on  $\Omega\mathcal{C}$  given in (2.1.12), we should not view (2.1.12) as a direct application of the boundary-bulk relation, but instead, a consequence of the condition (2.1.17).  $\diamond$

The boundary-bulk relation (2.1.16) immediately implies the following anomaly-free condition on  $\mathcal{C}$  generalizing (2.1.14) [KWZ15, JF22, KLWZZ20b] (see Remark 2.1.12):

$$\mathfrak{Z}_1(\mathcal{C}) \simeq n\text{Vec}, \quad (2.1.17)$$

where the definition of  $n\text{Vec}$  is given in Section 2.2. Since  $\Omega\mathcal{C}$  encodes all the information of  $\mathcal{C}$  up to condensation descendants, we expect that the two anomaly-free condition (2.1.12) and (2.1.17) are mathematically equivalent [KWZ15]. Based on a corrected definition of a multi-fusion  $n$ -category, this conjecture was proved by Johnson-Freyd in [JF22] (see also [KZ21a] for a different proof).

**Remark 2.1.12.** We give a historical remark on the conjecture (2.1.17). Although, in retrospect, (2.1.17) seems a natural guess, there is no mathematical evidence to support this guess beyond (2.1.14) in 2014–2015<sup>5</sup>. There are some natural questions that made the conjecture (2.1.17) questionable. The bulk  $Z(\mathcal{C})^{n+2}$  is needed simply because it fix the braiding non-detectability of  $C^{n+1}$  by the half-braidings between the bulk defects and the boundary defects. Therefore, one could view (2.1.17) as a reformulation of Remote Detectable Principle. On the one hand, condensation descendants do not play an essential role in braidings. It is possible that condensation descendants are not needed for boundary-bulk relation to hold. For example, replacing  $\mathcal{C}$  by  $B\Omega\mathcal{C}$  in (2.1.17) could be another possibility. On the other hand, the mathematical notion of center is universal (or maximal in some sense). It suggests that it might be reasonable to include condensation descendants for boundary-bulk relation to hold. In other words, the key question is whether the notion of center is compatible with condensation completion. Since  $\mathcal{C}$  is the maximal possible choice, it is called a maximal  $\text{BF}^{pre}$ -category instead of a (multi-)fusion higher category in [KW14]. The later term is reserved for the one that is compatible with the notion of center [KWZ15]. Although the notion of a fusion 2-category was officially introduced by Douglas and Reutter in [DR18] in 2018, the first evidence of the compatibility appeared in 2019 in [KTZ20b], where the  $E_1$ -center  $\mathfrak{Z}_1(2\text{Vec}_G^\omega)$  of  $2\text{Vec}_G^\omega$  was explicitly computed, and was shown to contain all topological defects of codimension 2 or higher in 3+1D Dijkgraaf-Witten theories, including all 2-codimensional condensation descendants. Then it becomes clear that the conjecture (2.1.17) is reasonable. In 2020, two independent works [JF22, KLWZZ20b] on this conjecture appeared within the same week on arXiv. In a beautiful work [JF22], Johnson-Freyd introduced the mathematical definition of a (multi-)fusion  $n$ -category and gave a very general proof of the equivalence between two anomaly-free conditions (2.1.12) and (2.1.17). This work is based on the theory of condensation completion in higher categories developed by Gaiotto and Johnson-Freyd in [GJF19]. This compatibility was proposed as a general principle in [KLWZZ20b] called *Condensation Completion Principle*, which also applies to gapped/gapless quantum liquids (including topological orders) [KZ18b, KZ20, KZ21b]. Some related results in low dimensions were also proved in [KLWZZ20b, DN21]. Different proofs of these results appeared later in [KZ22b].  $\diamond$

Notice that the boundary-bulk relation (2.1.16) only involves  $\Omega\mathcal{B}$ . It is natural to ask if it is possible to have a formulation of boundary-bulk relation in terms of  $\mathcal{B}$ ? Observe that if we include all 1-codimensional topological defects in  $B^{n+2}$ , then fusing a non-trivial 1-codimensional topological defect to the boundary  $C^{n+1}$  changes the boundary condition. Since  $B^{n+2}$  is anomaly-free, an 1-codimensional topological defects in  $B^{n+2}$  is necessarily a condensation descendant of the trivial 1-codimensional topological defect  $\mathbb{1}_{\mathcal{B}}$ , which do not change the boundary condition by fusion. It also means that a 1-codimensional topological defect in  $B^{n+2}$  is always connected to  $\mathbb{1}_{\mathcal{B}}$  by a  $nD$  gapped domain wall. Therefore, new boundary conditions obtained by fusing 1-codimensional topological defects in  $B^{n+2}$  with  $C^{n+1}$  are necessarily obtained from  $C^{n+1}$  via condensations and connected to  $C^{n+1}$  by a  $nD$  gapped domain wall. However, it is not true that all gapped boundaries of  $B^{n+2}$  can be connected to  $C^{n+1}$  by an  $nD$  gapped domain wall. For example, when  $B^{n+2} = \mathbf{1}^4$ , a chiral anomaly-free 2+1D topological order cannot connect to a non-chiral anomaly-free 2+1D topological order by a gapped domain wall, or equivalently, such a domain wall is necessarily gapless. We denote by  $\Sigma\mathcal{C}$  the  $(n+1)$ -category of all gapped boundary conditions of  $B^{n+2}$  that can be obtained from  $C^{n+1}$  via condensations. The notation  $\Sigma\mathcal{C}$  represents the condensation completion of  $B\mathcal{C}$  and is explained in Section 2.2. Applying the boundary-bulk relation again, we should expect  $\mathcal{B} \simeq \mathfrak{Z}_0(\Sigma\mathcal{C})$ , where  $\mathfrak{Z}_0(\Sigma\mathcal{C})$  is the  $E_0$ -center of  $\Sigma\mathcal{C}$  (explained in Section 2.3.5) and can be defined explicitly by  $\text{Fun}(\Sigma\mathcal{C}, \Sigma\mathcal{C})$ , i.e., the category of  $\mathbb{C}$ -linear functors from  $\Sigma\mathcal{C}$  to  $\Sigma\mathcal{C}$ . We summarize boundary-bulk relation below.

**Theorem<sup>ph</sup> 2.1.13 (Boundary-Bulk Relation).** Let  $B^{n+2}$  be a topological order with a gapped bound-

<sup>5</sup>Although an obvious thing to do is check if it is true for  $n = 2$  when  $\mathcal{C} = \text{BMod}_{\mathcal{A}|\mathcal{A}}(2\text{Vec})$ , how to compute this Drinfeld center was not known until years later.

ary  $C^{n+1}$ . We have

$$\Omega\mathcal{B} \simeq \mathfrak{Z}_1(\mathcal{C}), \quad (2.1.18)$$

$$\mathcal{B} \simeq \mathfrak{Z}_0(\Sigma\mathcal{C}) = \text{Fun}(\Sigma\mathcal{C}, \Sigma\mathcal{C}). \quad (2.1.19)$$

Moreover, these two formulations of boundary-bulk relation are necessarily equivalent. This equivalence immediately implies the following braided equivalence:

$$\mathfrak{Z}_1(\mathcal{C}) \simeq \Omega\mathfrak{Z}_0(\Sigma\mathcal{C}). \quad (2.1.20)$$

**Remark 2.1.14.** The result (2.1.20) was a mathematical fact proved in [Fra12, JF22, KZ22b].  $\diamond$

It turns out that (2.1.15) is only a part of more complete boundary-bulk relation [KWZ15, KZ21a], which is also very useful to our higher condensation theory. We review it now. Consider the physical configuration depicted in Figure 3, in which  $A^{n+1}, B^{n+1}, C^{n+1}$  are potentially anomalous simple topological orders;  $M^n$  and  $N^n$  are gapped domain walls.

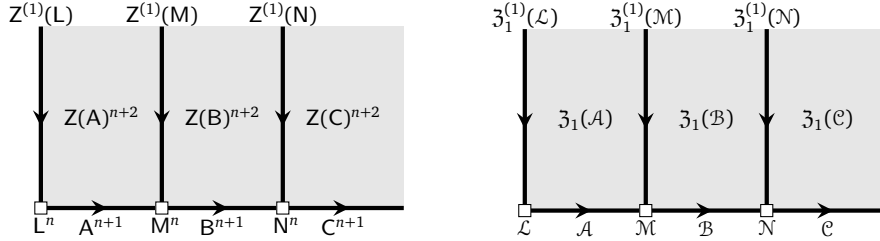

Figure 3: the functoriality of the boundary-bulk relation

The orientation of the  $Z(A)^{n+1}$  follows that in Figure 1 and that of  $A^{n+1}$  is the one induced from the bulk, and  $Z(A)^{n+2}$  is on the left side of  $A^{n+1}$ . There are two different ways to look at  $M^n$ .

1.  $M^n$  is a gapped defect junction of  $A^{n+1}, B^{n+1}$  and  $Z^{(1)}(M)^{n+1}$ .
2. When  $M^{n+1}$  is viewed as gapped domain wall between  $A^{n+1}$  and  $B^{n+1}$ , it is potentially anomalous in the sense that the  $n+1$ D topological order  $Z^{(1)}(M)^{n+1}$ , which can be viewed as the anomaly of  $M^{n+1}$  as a domain wall of  $A^{n+1}$  and  $B^{n+1}$ , can be non-trivial. In particular,  $Z^{(1)}(M)^{n+1}$  is uniquely determined by  $M^{n+1}$  [KWZ15] and is called the relative bulk of  $M^n$ . This fact also explains the notation.

For example, as a domain wall between  $Z(A)^{n+2}$  and  $Z(B)^{n+2}$ ,  $Z^{(1)}(M)^{n+1}$  can be non-invertible (thus non-trivial). Note that the bulk  $Z(M)^{n+1}$  of  $M^n$  is different from the relative bulk  $Z^{(1)}(M)^{n+1}$  of  $M^n$  but can be expressed in terms of the later as follows:

$$Z(M)^{n+1} = A^{n+1} \boxtimes_{Z(A)} Z^{(1)}(M)^{n+1} \boxtimes_{Z(B)} \overline{B^{n+1}},$$

where  $A^{n+1} \boxtimes_{Z(A)} Z^{(1)}(M)^{n+1}$  represents the fusion of  $A^{n+1}$  and  $Z^{(1)}(M)^{n+1}$  along  $Z(A)^{n+2}$ .

**Theorem<sup>ph</sup> 2.1.15 (Functoriality of Boundary-Bulk Relation [KWZ15]).** The boundary-bulk relation is functorial. More precisely, in the physical situation depicted in Figure 3, we have

$$Z^{(1)}(N)^{n+1} \boxtimes_{Z(B)} Z^{(1)}(M)^{n+1} = Z^{(1)}(M \boxtimes_B N)^{n+1}, \quad (2.1.21)$$

where  $\boxtimes_{Z(B)}$  means horizontally fuse  $Z^{(1)}(M)^{n+1}$  with  $Z^{(1)}(N)^{n+1}$  along  $Z(B)^{n+2}$ .

Mathematically, above result can be translated into a mathematical one. Note that, since  $A^{n+1}, B^{n+1}, C^{n+1}$  are simple, the associated categories of topological defects  $\mathcal{A}, \mathcal{B}, \mathcal{C}$  are indecomposable multi-fusion  $n$ -categories, and  ${}_{\mathcal{A}}\mathcal{M}_{\mathcal{B}}, {}_{\mathcal{B}}\mathcal{N}_{\mathcal{C}}$  are bimodules.

**Theorem 2.1.16** ([KWZ15, KZ18a, KZ21a]). The following assignment:

$$\mathcal{A} \mapsto \mathfrak{Z}_1(\mathcal{A}), \quad {}_{\mathcal{A}}\mathcal{M}_{\mathcal{B}} \mapsto \mathfrak{Z}_1^{(1)}(\mathcal{M}) := \text{Fun}_{\mathcal{A}|\mathcal{B}}(\mathcal{M}, \mathcal{M})$$

is functorial in the sense that the assignment respects the horizontal fusion:

$$\begin{aligned} \text{Fun}_{\mathcal{B}|\mathcal{C}}(\mathcal{N}, \mathcal{N}) \boxtimes_{\mathfrak{Z}_1(\mathcal{B})} \text{Fun}_{\mathcal{A}|\mathcal{B}}(\mathcal{M}, \mathcal{M}) &\xrightarrow{\cong} \text{Fun}_{\mathcal{A}|\mathcal{C}}(\mathcal{M} \boxtimes_{\mathcal{B}} \mathcal{N}, \mathcal{M} \boxtimes_{\mathcal{B}} \mathcal{N}) \\ g \boxtimes_{\mathfrak{Z}_1(\mathcal{B})} f &\mapsto f \boxtimes_{\mathcal{B}} g. \end{aligned} \quad (2.1.22)$$

The physical configuration associated to the boundary-bulk relation as depicted in Figure 3 suggests us to introduce some useful and important equivalence relations among topological orders.

**Definition 2.1.17.** For any three  $n+1$ D (potentially anomalous) topological order  $A^{n+1}, B^{n+1}, C^{n+1}$ ,

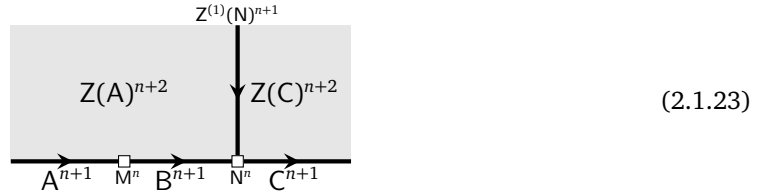

1.  $B^{n+1}$  and  $C^{n+1}$  are said to be *topologically connected* if  $N^n$  is gapped. (Note that any domain walls between  $Z(A)^{n+2}$  and  $Z(C)^{n+2}$  are gappable. Therefore, even though  $N^n$  is potentially gapless, its relative bulk  $Z(N)^{n+1}$  is always gapped.)
2.  $A^{n+1}$  and  $B^{n+1}$  are said to be *bulk-equivalent* if they share the same bulk (or gravitational anomaly), i.e.,  $Z(A)^{n+2} = Z(B)^{n+2}$ . Two bulk-equivalent topological orders  $A^{n+1}$  and  $B^{n+1}$  are said to be
  - (a) *topologically Morita equivalent* if they are bulk-equivalent and are connected by a gapped anomaly-free domain wall (e.g.,  $M^n$  in (2.1.23));
  - (b) *non-topologically Morita equivalent* if otherwise (i.e.,  $M^n$  must be gapless). ■

**Example 2.1.18.** We discuss some examples of above equivalences.

1. Any two 1+1D topological orders are topologically connected. If they are bulk-equivalent, then they are topologically Morita equivalent [KK12, Kon14].
2. Any two 2+1D anomaly-free topological orders  $A^3$  and  $B^3$  are bulk equivalent.
  - (a) If  $A^3$  and  $B^3$  are topologically Morita equivalent, then  $\Omega A$  and  $\Omega B$  are Witt equivalent [DMNO13]. The set of topologically Morita equivalence classes of 2+1D anomaly-free topological orders clearly form a group (see Remark 2.1.20).
  - (b) If  $\Omega A$  and  $\Omega B$  are not Witt equivalent, then  $A^3$  and  $B^3$  are non-topologically Morita equivalent. ♥
3. There are plenty examples of not topologically connected topological orders. For example, two gapped boundaries of two 3+1D Dijkgraaf-Witten theories, respectively, are not topologically connected in general. We give a general construction below.

- (a) There are three gapped boundaries of 3+1D  $\mathbb{Z}_2$  topological order associated to three Lagrangian algebras in the  $\mathfrak{Z}_1(2\text{Vec}_{\mathbb{Z}_2})$  constructed in [ZLZH<sup>+</sup>23]. These three boundary phases are topologically Morita equivalent.
- (b) Given two topologically Morita equivalent gapped boundaries  $A^3$  and  $B^3$  of a 3+1D topological order  $X^4$ . By stacking them with two anomaly-free 2+1D topological orders  $C^3$  and  $D^3$ , respectively, that are non-topologically Morita equivalent (i.e.,  $\Omega\mathcal{C}$  and  $\Omega\mathcal{D}$  are not Witt equivalent), we obtain a pair of non-topologically Morita equivalent gapped boundaries  $A^3 \boxtimes C^3$  and  $B^3 \boxtimes D^3$  of  $X^4$  that are not topologically connected. Moreover, any gapped boundaries that are topologically Morita equivalent to  $A^3 \boxtimes C^3$  are non-topological Morita equivalent to  $B^3 \boxtimes D^3$ . Moreover, they are not topologically connected.

We denote by  $\text{TM}^n(C^{n+1})$  the set of topologically Morita equivalence classes of gapped boundaries of a non-chiral simple topological order  $C^{n+1}$  (see Definition 2.2.6). For simplicity, we set  $\text{TM}^n := \text{TM}^n(\mathbf{1}^{n+1})$ . Let  $M^n$  be a gapped boundary of  $C^{n+1}$ . We denote the associated equivalence class by  $[M^n]$ . The naive stacking gives a well-defined map:

$$\begin{aligned} \text{TM}^n(B^{n+1}) \times \text{TM}^n(C^{n+1}) &\xrightarrow{\boxtimes} \text{TM}^n(B^{n+1} \boxtimes C^{n+1}) \\ ([X^n], [M^n]) &\mapsto [X^n \boxtimes M^n]. \end{aligned}$$

When  $B^{n+1} = \mathbf{1}^{n+1}$ , this map defines a  $\text{TM}^n$ -action on  $\text{TM}^n(C^{n+1})$ . When  $B^{n+1} = C^{n+1} = \mathbf{1}^{n+1}$ , this map defines an associative and commutative multiplication on  $\text{TM}^n$ .

**Theorem<sup>ph</sup> 2.1.19.**  $\text{TM}^n = (\text{TM}^n, \boxtimes, [\mathbf{1}^n])$  is an abelian group and  $[X^n]^{-1} = [\overline{X^n}]$  for any anomaly-free  $X^n$ .

**Remark 2.1.20.** When  $n = 3$ , we have  $\text{TM}^3 = \text{Witt}^3 \times \text{Inv}^3$ , where  $\text{Witt}^3$  is the usual Witt group [DMNO13] and  $\text{Inv}^3$  is the group of invertible 2+1D topological orders.  $\diamond$

In summary, we have given a physical description of the category of topological defects in an  $n+1$ D anomaly-free topological order  $C^{n+1}$ , and we show that the anomaly-free condition on  $C^{n+1}$  can be translated into a condition on  $\Omega\mathcal{C}$  (2.1.12) or a condition on  $\mathcal{C}$  (2.1.17). It is clear that, in order to move further, we need make the  $\Omega\mathcal{C}$ ,  $\mathcal{C}$ ,  $n\text{Vec}$  in these conditions (2.1.12) and (2.1.17) mathematically precise. This is the subject of the next subsection.

## 2.2 Condensation completion

For a topological order  $C^{n+1}$ , the process of completing  $B\Omega\mathcal{C}$  by its condensation descendants is called the *condensation completion* (or *Karoubi completion*) of  $B\Omega\mathcal{C}$  [CR16, DR18, GJF19]. More generally, for an arbitrary  $k$ -category  $\mathcal{A}$ , it is possible to define the Karoubi completion of  $\mathcal{A}$ , denoted by  $\text{Kar}(\mathcal{A})$ . This notion was first introduced in the  $k = 2$  cases by Carqueville and Runkel in [CR16], and was later thoroughly developed by Douglas and Reutter in [DR18], and was later generalized to all  $k$  by Gaiotto and Johnson-Frey in [GJF19]. In this subsection, we briefly review the basic ideas of condensation completion [GJF19] via a physical approach, and introduce the notions of separable  $n$ -categories [KZ22b] and multi-fusion  $n$ -categories [JF22, KZ22b].

In the previous subsection,  $\mathcal{C}$  is given priori and automatically condensation complete because it contains all possible topological defects in  $C^{n+1}$ , including all condensation descendants, by definition. We want to take a closer look at topological defects in  $C^{n+1}$ , especially when  $C^{n+1} = \mathbf{1}^{n+1}$ . We proceed by stating a result which is a consequence of a much stronger result: Theorem<sup>ph</sup> 3.2.9.

**Theorem<sup>ph</sup> 2.2.1** ([KW14, GJF19]). Given two  $k$ D topological defects  $A^k$  and  $B^k$  (or anomalous topological orders),  $B^k$  can be obtained from  $A^k$  via a condensation of higher codimensional topological defects in  $A^k$  if and only if they can be connected by a  $(k - 1)$ D gapped domain wall.

We show in Theorem<sup>ph</sup> 3.2.9 that the condensation in Theorem<sup>ph</sup> 2.2.1 can be defined by a gapped domain wall. Now we simply take it for granted. One immediate corollary is that  $B^k$  can be obtained from  $A^k$  via a condensation of higher codimensional defects living in  $A^k$  if and only if  $A^k$  can be obtained from  $B^k$  via a condensation of higher codimensional defects living in  $B^k$ . Therefore, any two  $k$ -morphisms  $f, g \in \mathcal{C}$ , the  $(n-k)$ -category  $\text{hom}_{\mathcal{C}}(f, g)$  is a direct sum of connecting full sub-categories. When  $C^{n+1}$  is anomaly-free, the monoidal  $n$ -category  $\mathcal{C}$  is connected. We used the following connected diagram to give an intuitive description of  $\mathcal{C}$ : for  $x \in \mathcal{C}$ ,

$$\begin{array}{ccc}
 \Omega\mathcal{C} & & \text{hom}_{\mathcal{C}}(x, x) \\
 \curvearrowright & \xrightarrow{\text{hom}_{\mathcal{C}}(\mathbb{1}, x)} & \curvearrowright \\
 \mathbb{1} & \xrightarrow{\hspace{2cm}} & x \\
 \xrightarrow{\text{hom}_{\mathcal{C}}(x, \mathbb{1})} & & 
 \end{array}$$

Since all objects in  $\mathcal{C}$  are condensation descendants of  $\mathbb{1}$ ,  $\mathcal{C}$  is the condensation completion of  $B\Omega\mathcal{C}$ , i.e.  $\mathcal{C} = \text{Kar}(B\Omega\mathcal{C})$ . It is worth pointing out that the notion of condensation or Karoubi completion can be defined for any higher category without any physical context [GJF19]. Recall that the one-point delooping is defined for any monoidal higher category  $\mathcal{A}$ . We define the delooping of  $\mathcal{A}$  by:

$$\Sigma\mathcal{A} := \text{Kar}(B\mathcal{A}). \quad (2.2.1)$$

Then we have  $\Sigma\Omega\mathcal{C} = \mathcal{C}$ . We set  $\Sigma\mathcal{C} := \text{Vec}$ .

**Theorem<sup>ph</sup> 2.2.2.**  $n\text{Vec} = \Sigma^n\mathcal{C}$ . Physically,  $n\text{Vec}$  is the category of topological defects in  $\mathbf{1}^{n+1}$ , consisting of all non-chiral topological orders of dimension  $nD$  and lower and gapped domain walls among them.

*Proof.* This follows immediately from the fact that  $n\text{Vec}$  contains only the trivial  $k$ -morphisms for  $k \geq 0$  and their condensation descendants, and, as we have shown earlier, this fact is a consequence of Remote Detectable Principle.  $\square$

**Example 2.2.3.** We can gain a better understanding of  $n\text{Vec}$  by working out  $n\text{Vec}$  for  $n = 2, 3$  explicitly.

- (1)  $2\text{Vec}$  is the 2-category of topological defects in  $\mathbf{1}^3$ . In Example 2.1.3, we have shown that it is precisely that 2-category of finite semisimple 1-categories or finite direct sums of  $\text{Vec}$ . Now we work it out from the point of view of condensation completion. The trivial defect in  $2\text{Vec}$  is precisely the trivial 1+1D topological order, particles in which form the trivial fusion 1-category  $\text{Vec}$ . Condensation completion demands us to add all the condensation descendants of the trivial 1+1D topological order. We can proceed in two slightly different but equivalent ways.
  - (a) The category of particles of each of these condensation descendants is necessarily a solution to the anomaly-free condition (2.1.14). All solutions are given by the indecomposable multi-fusion 1-category  $\text{Fun}(\mathcal{X}, \mathcal{X})$  for a finite semisimple 1-category  $\mathcal{X}$ . We see immediately that these condensation descendants form the 2-category  $2\text{Vec}$  because objects in  $2\text{Vec}$  are precisely finite semisimple 1-category  $\mathcal{X}$  and  $\text{hom}$  1-category in  $2\text{Vec}$  is precisely  $\text{Fun}(\mathcal{X}, \mathcal{X})$ .
  - (b) According [Kon14], a condensation in  $\mathbf{1}^2$  is defined by a separable algebra  $A$  in  $\text{Vec}$ . The category of particles in the condensed 1+1D phase is given by the 1-category of  $A$ - $A$ -bimodules in  $\text{Vec}$ , denoted by  $\text{BMod}_{A|A}(\text{Vec})$ . Then the condensation completion of the trivial 1+1D topological order can be identified with the 2-category of separable algebras in  $\text{Vec}$  (as objects), bimodules (as 1-morphisms) and bimodule maps (as 2-morphisms). Since a separable algebra  $A$  in  $\text{Vec}$  is nothing but a finite direct sum of matrix algebras,  $\text{BMod}_{A|A}(\text{Vec}) \simeq \text{Fun}(\mathcal{X}, \mathcal{X})$  for some  $\mathcal{X} \in 2\text{Vec}$ . Moreover,  $\mathcal{X}$  can be identified with  $\text{RMod}_A(\text{Vec})$ , which is the category of right  $A$ -modules in  $\text{Vec}$  and is invariant up to the Morita equivalence of  $A$ . Therefore, this 2-category is precisely  $2\text{Vec}$ .

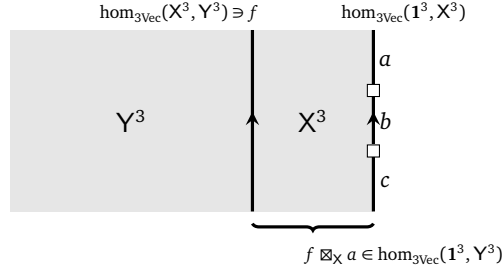

Figure 4: a domain wall  $f$  defines a functor  $f \boxtimes_X -$

In both cases, the finite semisimple 1-category  $\mathcal{X}$  (i.e.  $\mathcal{X} \in 2\text{Vec}$ ) pops out. Its physical means is the category of particles on the domain wall between  $1^2$  and one of its condensation descendants (say  $x$ ), i.e.  $\mathcal{X} = \text{hom}_{2\text{Vec}}(\text{Vec}, x)$ . It is easy to see that  $2\text{Vec} = \text{RMod}_{\text{Vec}}(2\text{Vec})$ , which is a special case of a more general fact (see Theorem 2.2.10).

- (2)  $3\text{Vec}$  is the monoidal 2-category of topological defects in  $1^4$ . The tensor unit  $\bullet = \mathbb{1}$  is the trivial 1-codimensional topological defect, which is precisely the trivial 2+1D topological order  $1^3$ , i.e.,  $\bullet = \mathbb{1} = 1^3$ . Its condensation descendants are precisely 2+1D non-chiral topological orders  $X^3$  (recall Definition 2.1.4). The 3-category  $3\text{Vec}$  is connected as shown by the following diagram.

$$\begin{array}{ccccc}
 \begin{array}{c} \curvearrowright \\ 1^3 \end{array} & \xrightarrow{\text{hom}_{3\text{Vec}}(1^3, X^3)} & \begin{array}{c} \mathcal{X} \\ \curvearrowright \\ X^3 \end{array} & \xrightarrow{\text{hom}_{3\text{Vec}}(X^3, Y^3)} & \begin{array}{c} \mathcal{Y} \\ \curvearrowright \\ X^3 \end{array} \\
 & \xleftarrow{\text{hom}_{3\text{Vec}}(X^3, 1^3)} & & \xleftarrow{\text{hom}_{3\text{Vec}}(Y^3, X^3)} & \\
 \end{array}$$

The 2-category  $\text{hom}_{3\text{Vec}}(1^3, X^3)$  is the 2-category of gapped boundary conditions of  $X^3$ . Its objects  $a, b, c, \dots$  are the labels for gapped boundaries of  $X^3$ , and the 1-category of morphisms  $\text{hom}_{3\text{Vec}}(a, a)$  is the category of particles on the boundary  $a$  and is a multi-fusion 1-category, and  $\text{hom}_{3\text{Vec}}(a, b) = \text{hom}_{3\text{Vec}}(b, a)^{\text{op}}$  is the category of particles on the 0+1D gapped domain wall connecting  $a$  and  $b$ . By Theorem<sup>ph</sup> 2.2.1, we obtain

$$\text{hom}_{3\text{Vec}}(1^3, X^3) = \begin{array}{ccc} \text{hom}_{3\text{Vec}}(a, a) & & \text{hom}_{3\text{Vec}}(b, b) \\ \curvearrowright & \xrightarrow{\text{hom}_{3\text{Vec}}(a, b)} & \curvearrowright \\ a & & b \\ & \xleftarrow{\text{hom}_{3\text{Vec}}(b, a)} & \end{array} = \Sigma \text{hom}_{3\text{Vec}}(a, a).$$

By (2.1.19), we obtain

$$\mathcal{X} \simeq \mathfrak{Z}_0(\Sigma \text{hom}_{3\text{Vec}}(a, a)) = \text{Fun}(\text{hom}_{3\text{Vec}}(1^3, X^3), \text{hom}_{3\text{Vec}}(1^3, X^3)). \quad (2.2.2)$$

Moreover, a gapped domain wall  $f \in \text{hom}_{3\text{Vec}}(X^3, Y^3)$  naturally defines a functor

$$\text{hom}_{3\text{Vec}}(1^3, X^3) \xrightarrow{f \boxtimes_X -} \text{hom}_{3\text{Vec}}(1^3, Y^3).$$

The physical meaning of this functor is illustrated in Figure 4. Conversely, we claim that any functor from  $\text{hom}_{3\text{Vec}}(1^3, X^3)$  to  $\text{hom}_{3\text{Vec}}(1^3, Y^3)$  should be realizable by such a domain wall, i.e.,

$$\text{hom}_{3\text{Vec}}(X^3, Y^3) = \text{Fun}(\text{hom}_{3\text{Vec}}(1^3, X^3), \text{hom}_{3\text{Vec}}(1^3, Y^3)). \quad (2.2.3)$$

There are two ways to prove this claim.

- (a) This claim follows from the so-called *Naturality Principle*, which says that if there is no physical law to forbid certain functors to be physically realizable (or occur physically), then all of them should be physically realizable. This principle is often used in bootstrap program such as rational CFT's [MS89] and anyon condensation [Kon14].
- (b) In this case, the precise mathematical definitions of the categories of boundary conditions of  $X^3$  and  $Y^3$  are known [JF22, KLWZZ20b, KZ22b] (or see [KZ22a] for a review). In this case, this claim is simply a mathematical fact, which follows immediately from [KZ18a, Theorem 3.2.3].

These two results (2.2.2) and (2.2.3) simply says that the same category  $3\text{Vec}$  can be equivalently defined by the following replacement:

$$\begin{aligned} X^3 &\mapsto \text{hom}_{3\text{Vec}}(\mathbf{1}^3, X^3), \\ \text{hom}_{3\text{Vec}}(X^3, Y^3) &\mapsto \text{Fun}(\text{hom}_{3\text{Vec}}(\mathbf{1}^3, X^3), \text{hom}_{3\text{Vec}}(\mathbf{1}^3, Y^3)). \end{aligned} \quad \heartsuit$$

This fact can be reformulated in more mathematical language. Let  $\text{Cat}_2^{\mathbb{C}}$  be the 3-category of  $\mathbb{C}$ -linear 2-categories [DR18]. This fact means that the following functor is fully faithful.

$$\text{hom}_{3\text{Vec}}(\bullet, -) : 3\text{Vec} \rightarrow \text{Cat}_2^{\mathbb{C}}$$

Let  $\text{Cat}_n^{\mathbb{C}}$  be the  $(n+1)$ -category of  $\mathbb{C}$ -linear  $n$ -categories. The following result was obtained in [KZ22b, Cor. 3.2].

**Theorem 2.2.4.** The functor  $\text{hom}_{(n+1)\text{Vec}}(\bullet, -) : (n+1)\text{Vec} \rightarrow \text{Cat}_n^{\mathbb{C}}$  is fully faithful.

*Proof.* All the arguments in Example 2.2.3 (2) automatically generalizes to  $(n+1)\text{Vec}$  except that the reference [KZ18a, Theorem 3.2.3] should be replaced by [KZ21a, Corollary 3.26, Remark 3.27].  $\square$

**Definition 2.2.5.** A *separable  $n$ -category* is a  $\mathbb{C}$ -linear  $n$ -category that lies in the essential image of  $\text{hom}_{(n+1)\text{Vec}}(\bullet, -)$ . Physically, a separable  $n$ -category is both the label of a non-chiral  $n+1$ D topological order  $X^n$  and, at the same time, the category of gapped boundary conditions of  $X^n$ . It also means that a separable  $n$ -category is condensation complete by definition.  $\blacksquare$

As a consequence, we can identify the category  $(n+1)\text{Vec}$  as the  $(n+1)$ -category of separable  $n$ -categories (as objects),  $\mathbb{C}$ -linear  $n$ -functors (as 1-morphisms),  $\mathbb{C}$ -linear  $n$ -natural transformations (as 2-morphisms), so on and so forth. When  $n=0$ , a separable 0-category is a finite dimensional vector space over  $\mathbb{C}$ ; when  $n=1$ , a separable 1-category is a finite semisimple 1-categories; when  $n=2$ , a separable 1-category is a finite semisimple 2-category [DR18].

By the folding trick, a gapped domain wall between two non-chiral topological order  $X^n$  and  $Y^n$  is automatically a gapped boundary of  $X^n \boxtimes \overline{Y^n}$ . For  $x, y \in n\text{Vec}$ , this means that  $\text{hom}_{n\text{Vec}}(x, y) \simeq \text{hom}_{n\text{Vec}}(\mathbb{1}, y \otimes x^R)$ , where  $x^R$  is the right dual of  $x$ . By Definition 2.2.5,  $\text{hom}_{n\text{Vec}}(x, y)$  is a separable  $(n-1)$ -category. It further implies that every hom space in a separable higher category is automatically separable.

**Definition 2.2.6.** A 0-morphism  $f$  in a separable 1-category  $\mathcal{A}$  is called *simple* if  $\text{hom}_{\mathcal{A}}(f, f) \simeq \mathbb{C}$ . A  $k$ -morphism  $g$  in a separable  $n$ -category  $\mathcal{B}$  is called *simple* if  $1_g$  is simple in  $\text{hom}_{\mathcal{B}}(g, g)$ .

Since a (potentially anomalous)  $n+1$ D topological order  $C^{n+1}$  is a 1-morphism in  $(n+2)\text{Vec}$ , the topological order  $C^{n+1}$  is called *simple or indecomposable* if the associated 1-morphism in  $(n+2)\text{Vec}$  is simple, and is called *composite* otherwise.  $\blacksquare$

**Remark 2.2.7.** A composite topological order is a very natural notion. They often occur in the dimensional reduction processes or the fusions within the category of topological orders. For example, a 2+1D



toric code model defined on a narrow strap with the smooth boundary condition on two sides, as quasi-1+1D system, defines the composite topological order  $1^2 \oplus 1^2$ . More discussion and examples of this notion can be found in [KZ22a].

When we discuss topological defects within a topological order  $C^{n+1}$ , it is convenient and helpful to assume that  $C^{n+1}$  is simple. Therefore, in the rest of this work, for convenience, by a topological order we always mean a simple (or indecomposable) topological order unless we specify otherwise. However, by a topological defect, we always means a potentially composite one.  $\diamond$

**Definition 2.2.8.** A multi-fusion  $n$ -category, or an  $E_1$ -multi-fusion  $n$ -category, is a condensation complete monoidal  $n$ -category  $\mathcal{A}$  such that  $\Sigma\mathcal{A}$  is a separable  $(n+1)$ -category. Physically, by definition, a multi-fusion  $n$ -category is necessarily the category of topological defects on a gapped boundary of a non-chiral topological order  $X^{n+2}$ . Such  $\mathcal{A}$  is a fusion  $n$ -category if  $\mathbb{1}_{\mathcal{A}}$  is simple.  $\blacksquare$

**Remark 2.2.9.** The notion of a (multi-)fusion 2-category was first introduced by Douglas and Reutter in [DR18]. That of a (multi-)fusion  $n$ -category was first introduced by Johnson-Freyd in [JF22]. Here we follow an approach given in [KZ22b].  $\diamond$

A separable  $n$ -category is a finite direct sum of indecomposable ones. An indecomposable separable  $n$ -category  $\mathcal{S}$  is illustrated by the following connected diagram (connected by 1-morphisms).

$$\begin{array}{ccc}
 \text{hom}_{\mathcal{S}}(a,a) & & \text{hom}_{\mathcal{S}}(b,b) \\
 \curvearrowright & \text{hom}_{\mathcal{S}}(a,b) & \curvearrowright \\
 a & \rightleftarrows & b \\
 & \text{hom}_{\mathcal{S}}(b,a) & 
 \end{array}
 \quad \forall a, b \in \mathcal{S}. \quad (2.2.4)$$

Note that  $\text{hom}_{\mathcal{S}}(a, a)$  and  $\text{hom}_{\mathcal{S}}(a, a)$  are indecomposable multi-fusion  $(n-1)$ -categories, which define physically the categories of topological defects on the gapped boundaries labeled by  $a$  and  $b$ , respectively. Since  $a$  and  $b$  are connected, two multi-fusion  $(n-1)$ -categories are necessarily Morita equivalent. Moreover,  $\text{hom}_{\mathcal{S}}(a, b)$  and  $\text{hom}_{\mathcal{S}}(b, a)$  are precisely the invertible bimodules that define the Morita equivalence. Physically,  $\text{hom}_{\mathcal{S}}(a, b)$  and  $\text{hom}_{\mathcal{S}}(b, a)$  are the category of wall conditions of gapped domain walls between  $a$  and  $b$ . In particular, we have the following monoidal equivalence:

$$\text{hom}_{\mathcal{S}}(b, b) \simeq \text{Fun}_{\text{hom}_{\mathcal{S}}(a,a)^{\text{op}}}(\text{hom}_{\mathcal{S}}(a, b), \text{hom}_{\mathcal{S}}(a, b)). \quad (2.2.5)$$

The physical meaning of this fact is illustrated in Figure 3, in which two gapped boundaries  $A^{n+1}$  and  $Z^{(1)}(\text{L})$  of the same anomaly-free topological order  $Z(A)^{n+2}$  are connected by a gapped domain wall  $L^n$ . By the functoriality of the boundary-bulk relation, we have  $\mathfrak{Z}_1^{(1)}(\mathcal{L}) := \text{Fun}_{\mathcal{A}^{\text{op}}}(\mathcal{L}, \mathcal{L})$ . By replacing  $b$  by  $b \oplus c$  in (2.2.5), we obtain a new equivalence:

$$\text{hom}_{\mathcal{S}}(b, c) \simeq \text{Fun}_{\text{hom}_{\mathcal{S}}(a,a)^{\text{op}}}(\text{hom}_{\mathcal{S}}(a, b), \text{hom}_{\mathcal{S}}(a, c)), \quad (2.2.6)$$

which simply says that,  $\forall a \in \mathcal{S}$ , we have

$$\mathcal{S} = \Sigma \text{hom}_{\mathcal{S}}(a, a) \simeq \text{RMod}_{\text{hom}_{\mathcal{S}}(a,a)}(n\text{Vec}). \quad (2.2.7)$$

This result provides a convenient and useful characterization of the delooping.

**Theorem 2.2.10 ([GJF19, KZ22b]).** For a multi-fusion  $n$ -category  $\mathcal{A}$ , we have  $\Sigma\mathcal{A} \simeq \text{RMod}_{\mathcal{A}}((n+1)\text{Vec})$  and the equivalence is defined by the functor  $\text{hom}_{\Sigma\mathcal{A}}(\bullet, -) : x \mapsto \text{hom}_{\Sigma\mathcal{A}}(\bullet, x)$ .

In a separable  $n$ -category, an object  $x \in \mathcal{S}$  is simple if and only if its identity 1-morphism  $1_x$  is a simple object in  $\text{hom}_{\mathcal{S}}(x, x)$ . In this case,  $\text{hom}_{\mathcal{S}}(x, x)$  is a fusion  $(n-1)$ -category. When  $x$  is not simple, it represents a composite defect or a composite boundary condition. In this case,  $\text{hom}_{\mathcal{S}}(x, x)$  is a multi-fusion  $n$ -category. If all direct summands in  $x$  all live in the same connecting component of  $\mathcal{S}$ ,

then  $\text{hom}_S(x, x)$  is an indecomposable multi-fusion  $n$ -category; otherwise,  $\text{hom}_S(x, x)$  is a direct sum of indecomposable multi-fusion  $n$ -category. As an illustrating example, when  $x = a \oplus b$  and  $a, b$  are simple and connected, then we have the following decomposition (see also (2.2.4)):

$$\text{hom}_S(x, x) = \begin{pmatrix} \text{hom}_S(a, a) & \text{hom}_S(a, b) \\ \text{hom}_S(b, a) & \text{hom}_S(b, b) \end{pmatrix}.$$

All indecomposable multi-fusion  $n$ -category is of such a matrix-type [KZ22b]. For an indecomposable multi-fusion  $n$ -category  $\mathcal{A}$ , the physical meaning of the number of simple direct summands of the tensor unit  $\mathbb{1}_{\mathcal{A}}$  is the ground state degeneracy of the associated topological order  $A^{n+1}$  defined on an  $n$ -sphere  $S^n$ . In other words, if  $\mathbb{1}_{\mathcal{A}}$  is not simple, then  $A^{n+1}$  is unstable. Composite and unstable defects are not only mathematically natural but also physically required in the study of topological orders. In some low dimensional topological orders, they can be explicitly constructed in lattice models (see for example [KK12, KZ22a]).

**Theorem<sup>ph</sup> 2.2.11** ([KWZ15, JF22]). Let  $C^{n+1}$  be an  $n+1$ D potentially anomalous topological order. The category  $\mathcal{C}$  of topological defects in  $C^{n+1}$  is a multi-fusion  $n$ -category.

1. If  $C^{n+1}$  is simple, then  $\mathcal{C}$  is a fusion  $n$ -category; if  $C^{n+1}$  is composite, then  $\mathcal{C}$  is a finite direct sum of indecomposable multi-fusion  $n$ -category; if  $C^{n+1}$  is the direct sum of topologically Morita equivalent simple topological orders, then  $\mathcal{C}$  is an indecomposable multi-fusion  $n$ -category.
2. If  $C^{n+1}$  is anomaly-free, then  $\mathfrak{Z}_1(\mathcal{C}) \simeq n\text{Vec}$ . If, in addition,  $C^{n+1}$  is simple, then  $\mathcal{C}$  is a connected separable  $n$ -category, i.e.  $\mathcal{C} = \Sigma\Omega\mathcal{C}$ , and we have  $\mathfrak{Z}_2(\Omega\mathcal{C}) \simeq (n-1)\text{Vec}$ .

**Remark 2.2.12.** We have reviewed the theory of condensation completion mainly in the spirits of [KW14, KWZ15, KLWZZ20b] instead of the more rigorous theory by Gaiotto and Johnson-Freyd [GJF19, JF22], which is not yet completely mathematically rigorous in the sense that no concrete model of weak  $n$ -categories is chosen and certain theory of colimits in higher categories was assumed. However, Gaiotto and Johnson-Freyd's theory has a lot of advantages, which allow us to proceed to answer many questions that are essentially orthogonal to higher coherence data [JF22, KZ22b, KZ21a].  $\diamond$

**Remark 2.2.13.** A few physical works on condensation completion in 2+1D appeared recently [KZ22a, XLWWC23, YWL24]. They contain some explicit calculations of the condensation completion of a few examples of 2+1D topological orders.  $\diamond$

## 2.3 Higher algebras

In this subsection, we explain the main idea of higher algebras in  $(n+1)\text{Vec}$  based on physical or geometric intuitions.

### 2.3.1 Monoidal 1-categories as $E_1$ -algebras

A potentially anomalous 1+1D topological order  $C^2$  can be realized as a gapped boundary of a 2+1D topological order  $Z(C)^3$  as depicted in Figure 5. It has non-trivial topological excitations or particle-like topological defects or particles for simplicity. These particles can be fused along the unique spatial dimension. Therefore, these particles, together with their fusion, form a fusion 1-category  $\mathcal{C}$  [KK12], in which 1-morphisms are instantons, i.e. 0D defect in spacetime. This result is well known. It is, however, only a part of a more complete story. We would like to sketch some key points in this more complete story (see also [KZ22a, Remark 3.4.19 & 3.4.66]) in order to introduce some important notions and notations that are useful later.

Consider a lattice model realization of the 2+1D topological order  $Z(C)^3$  with the gapped boundary  $C^2$ . Suppose two anyons  $a, b \in \mathcal{C}$  are realized in the model at two different sites  $r, s \in \mathbb{R}$ , respectively,

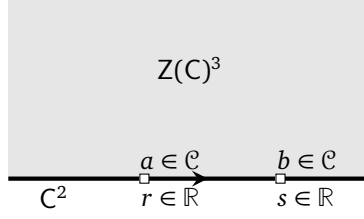

Figure 5: An anomalous topological order  $\mathcal{C}^2$  and its bulk  $Z(\mathcal{C})^3$

as depicted Figure 5. We chose the boundary line to be the real line. Recall that a particle is invariant under the action of local operators. Therefore, it represents a subspace of the total Hilbert space that are invariant under the net of local operators, and is more precisely defined as a superselection sector [HK64, Haa96]. The physical configuration depicted in Figure 5 already defines a fusion product  $a \otimes_{(r,s)} b$ , which can be viewed a subspace of the total Hilbert space. If we realize  $a, b$  in the same model but at different sites  $r', s'$ , then a different fusion product  $a \otimes_{(r',s')} b$  is realized as a different subspace of a potentially different total Hilbert space<sup>6</sup>. It means that there are infinitely many fusion products parameterized by the elements in the configuration space  $\{(r, s) \in \mathbb{R}^2 \mid r \neq s\}$ . An adiabatic move of  $(a, b)$  from  $(r, s)$  to  $(r', s')$  along a path  $\gamma$  in the configuration space defines a linear isomorphism:

$$T_{a,b}^\gamma : a \otimes_{(r,s)} b \xrightarrow{\cong} a \otimes_{(r',s')} b.$$

In mathematical language,  $T^\gamma := \{T_{a,b}^\gamma\}_{a,b \in \mathcal{C}} : \otimes_{(r,s)} \rightarrow \otimes_{(r',s')}$  defines a natural isomorphism. One of the defining properties of a topological order is the following principle:

**Adiabatic Principle:** if two paths  $\gamma_1$  and  $\gamma_2$  in the configuration space  $\{(r, s) \in \mathbb{R}^2 \mid r \neq s\}$  are homotopy equivalent, then  $T^{\gamma_1} = T^{\gamma_2}$ .

(2.3.1)

This property allows us to reduce the infinitely many fusion products  $\otimes_{(r,s)}$  to a two homotopically inequivalent fusion products  $\otimes := \otimes_{(-1,1)}$  and  $\otimes^{\text{op}} := \otimes_{(1,-1)}$ . It is clear that we have  $a \otimes^{\text{op}} b = b \otimes a$ .

We have sketched only some key ideas of a complete story, which is essentially the same as the mathematical proof of the fact that an  $E_1$ -algebra in the symmetric monoidal 2-category  $\text{Cat}_1$  is precisely a monoidal 1-category [SW03, Lur17, Fre17]. We have used the notation  $\text{Cat}_1$  to denote the category of 1-categories (as objects), functors (as 1-morphisms) and natural transformations (as 2-morphisms).  $\text{Cat}_1$  is symmetric monoidal with the tensor product given by the Cartesian product  $\times$  and the tensor unit given by the category with a single object  $\bullet$  and a single 1-morphism  $1_\bullet$ . The  $E_1$ -algebra (or an algebra over the  $E_1$ -operad) structure on  $\mathcal{A}$  consists of the infinitely many fusion products  $\otimes_{(r,s)}$  that are defined in 1-dimensional space, satisfying some natural conditions. It is different from that of a monoidal structure by definition. In  $\text{Cat}_1$ , they are equivalent due to the fact that there is no higher morphisms in  $\text{Cat}_1$  to catch the information of higher homotopy data in the  $E_1$ -operad [SW03, Lur17, Fre17]. In this work, we do not distinguish the 2-category of  $E_1$ -algebras,  $E_1$ -algebra homomorphisms and  $E_1$ -algebra 2-homomorphisms with that of monoidal categories, monoidal functors and monoidal natural transformations, and denote both categories by  $\text{Alg}_{E_1}(\text{Cat}_1)$ . Then the fact that  $\mathcal{A}$  is a monoidal 1-category can be easily summarized by a compact notation  $\mathcal{A} \in \text{Alg}_{E_1}(\text{Cat}_1)$ . From now on, we use the physical intuition of infinitely many fusion products freely whenever we talk about a 1+1D topological order  $\mathcal{A}^2$  or a monoidal 1-category  $\mathcal{A}$ .

<sup>6</sup>It depends on how one realize the defects. If we allow to introduce auxillary space localized around a site  $r$  for the realization of a particle at  $r$ , then total Hilbert spaces are different for anyon at different sites but isomorphic via adiabatic moves.

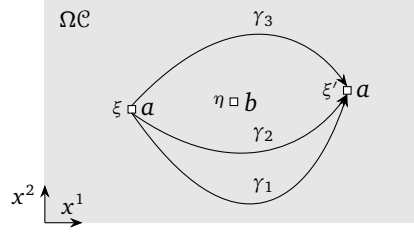

Figure 6: three paths in configuration space

For  $\mathcal{A} \in \text{Alg}_{\mathbb{E}_1}^c(\text{Cat}_1)$ , we can define the notion of a left/right  $\mathcal{A}$ -module in  $\text{Cat}_1$ , that of a module functor and that of a module natural transformation [Bén65, Ost03] (see [EGNO15] for a review). We denote the 2-category of left, right, bi- $\mathcal{A}$ -modules in  $\text{Cat}_1$  by  $\text{LMod}_{\mathcal{A}}(\text{Cat}_1)$ ,  $\text{RMod}_{\mathcal{A}}(\text{Cat}_1)$ ,  $\text{BMod}_{\mathcal{A}|\mathcal{A}}(\text{Cat}_1)$ , respectively.

### 2.3.2 Braided monoidal 1-categories as $E_2$ -algebras

For 2+1D topological order  $\mathbb{C}^3$ , its anyons form a braided monoidal category  $\Omega\mathbb{C}$ , which is usually defined by a tensor product  $\otimes$ , a tensor unit  $1_{\mathbb{1}}$ , the associators  $\alpha_{a,b,c} : a \otimes (b \otimes c) \rightarrow (a \otimes b) \otimes c$ , the left unitors  $l_a : 1_{\mathbb{1}} \otimes a \rightarrow a$ , the right unitors  $r_a : a \otimes 1_{\mathbb{1}} \rightarrow a$  and the braidings isomorphisms  $c_{a,b} : a \otimes b \rightarrow b \otimes a$  satisfying some natural conditions. In this subsection and the next, we reinterpret this structure in two seemingly different but equivalent ways that are ready to be generalized to higher dimensions.

In the first way, we go back to the physical intuition provided by the lattice model realizations of a 2+1D topological order. We mainly repeat the discussion in [KZ22a, Remark 3.4.19 & 3.4.66].

Suppose we have a lattice model realization of the 2+1D topological order  $\mathbb{C}^3$ , and suppose two anyons  $a, b \in \Omega\mathbb{C}$  are realized in the model at two different sites  $\xi, \eta \in \mathbb{R}^2 = \mathbb{C}$ , respectively, as depicted in Figure 6. Recall that an anyon is invariant under the action of local operators. Therefore, it represents a subspace of the total Hilbert space that are invariant under the net of local operators, which can be mathematically defined as superselection sectors [HK64, Haa96]. This physical configuration already defines a fusion product  $a \otimes_{(\xi, \eta)} b$ , which can be viewed as a subspace of the total Hilbert space. If we realize  $a, b \in \Omega\mathbb{C}$  in the same model but at different sites  $\xi', \eta'$ , then a different fusion product  $a \otimes_{(\xi', \eta')} b$  is realized as a different subspace of a potentially different total Hilbert space. Similar to 1+1D topological orders, it means that there are infinitely many fusion products parameterized by the elements in the configuration space  $\{(\xi, \eta) \in \mathbb{C}^2 \mid \xi \neq \eta\}$ . An adiabatic move of  $(a, b)$  from  $(\xi, \eta)$  to  $(\xi', \eta')$  along a path  $\gamma$  in the configuration space defines an isomorphism:

$$T_{a,b}^{\gamma} : a \otimes_{(\xi, \eta)} b \xrightarrow{\cong} a \otimes_{(\xi', \eta')} b.$$

In mathematical language,  $T^{\gamma} := \{T_{a,b}^{\gamma}\}_{a,b \in \Omega\mathbb{C}} : \otimes_{(\xi, \eta)} \rightarrow \otimes_{(\xi', \eta')}$  defines a natural isomorphism. Similar to 1+1D topological order, we have the following defining property of a 2+1D topological order:

**Adiabatic Principle:** if two paths  $\gamma_1$  and  $\gamma_2$  in the configuration space  $\{(\xi, \eta) \in \mathbb{C}^2 \mid \xi \neq \eta\}$  are homotopy equivalent, then  $T^{\gamma_1} = T^{\gamma_2}$ .

(2.3.2)

Again Adiabatic Principle allows us to reduce the infinitely many fusion products  $\otimes_{(\xi, \eta)}$  to a single fusion product  $\otimes := \otimes_{(-1,1)}$  and a braiding isomorphisms  $c_{a,b}$  defined by

$$a \otimes b \xrightarrow{c_{a,b} := T_{a,b}^{\gamma_+}} b \otimes a, \quad \gamma_+ := \{(e^{i(1-t)\pi}, e^{i(2-t)\pi}) \in \mathbb{C}^2 \mid t \in [0, 1]\}.$$

A physical work on adiabatic moves and braided monoidal structures can also be found in [KL20].

The point of this discussion is that, instead of strictly following the mathematical definition of a braided monoidal category, i.e. one tensor product plus braidings, we can return freely to above physical intuition of the infinitely many fusion products  $\otimes_{(\xi, \eta)}$  whenever we discuss the anyons in a 2+1D topological order. Importantly, we have only sketched some key points of a complete story, which is essentially equivalent to the proof of the well-known mathematical theorem that an  $E_2$ -algebra in the 2-category  $\text{Cat}_1$  of categories is equivalent to a braided monoidal 1-category [SW03, Lur17, Fre17]. We denote the category of  $E_2$ -algebras in  $\text{Cat}_1$  (or equivalently, braided monoidal 1-categories) by  $\text{Alg}_{E_2}(\text{Cat}_1)$ . Its 1-morphisms are  $E_2$ -algebra homomorphisms (or braided monoidal functors), and 2-morphisms are morphisms between two  $E_2$ -algebra homomorphisms (or braided monoidal natural transformations). Then the fact that  $\Omega\mathcal{C}$  is a braided 1-category can be simply represented by a compact notation  $\Omega\mathcal{C} \in \text{Alg}_{E_2}(\text{Cat}_1)$ .

Physically relevant braided monoidal 1-categories are braided fusion 1-categories. We rename a braided fusion 1-category  $\mathcal{A}$  as a condensable  $E_2$ -algebra in  $2\text{Vec}$  (see Section 2.3.4), denoted by  $\mathcal{A} \in \text{Alg}_{E_2}^c(2\text{Vec})$ , where  $\text{Alg}_{E_2}^c(2\text{Vec})$  is full subcategory of  $\text{Alg}_{E_2}(2\text{Vec})$  consisting of braided fusion 1-categories. By definition,  $\mathcal{A} \in \text{Alg}_{E_2}^c(2\text{Vec})$  if  $\Sigma^2\mathcal{A} \in 4\text{Vec}$ .

In the second way, we rederive the braiding structure from the monoidal structure of  $B\Omega\mathcal{C}$ . Since  $B\Omega\mathcal{C}$  is monoidal, its one point delooping  $B^2\Omega\mathcal{C}$  is a well defined 3-category, a fact which is equivalent to  $\Omega\mathcal{C}$  being braided monoidal. The 3-category  $B^2\Omega\mathcal{C}$  is sometimes called a 2-tuply monoidal 1-category (a list of proposed definitions of a weak n-category can be found in [Lei02]; see also the list in nLab). This result simply says that the braiding structure can be replaced by the fusion product in two independent directions as illustrated in the right half of Figure 7.

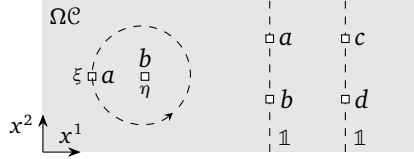

Figure 7: the idea of braiding and 2-tuply monoidal 1-category

- (1) Anyon  $a, b \in \Omega\mathcal{C}$  can be fused along the trivial string  $\mathbb{1}$  (i.e. vertically in Figure 7). We denote this fusion product in  $x^2$ -direction by  $a \otimes^2 b$ . Mathematically, this fusion is precisely the composition of two 1-morphisms  $a, b \in \text{hom}_{\mathcal{C}}(\mathbb{1}, \mathbb{1})$ :

$$\begin{aligned} \text{hom}_{\mathcal{C}}(\mathbb{1}, \mathbb{1}) \times \text{hom}_{\mathcal{C}}(\mathbb{1}, \mathbb{1}) &\xrightarrow{\circ} \text{hom}_{\mathcal{C}}(\mathbb{1}, \mathbb{1}) \\ (a, b) &\mapsto a \circ b = a \otimes^2 b. \end{aligned}$$

$1_{\mathbb{1}}$  is the unit of this fusion product, i.e.  $1_{\mathbb{1}} \otimes^2 a \simeq a \simeq a \otimes^2 1_{\mathbb{1}}$ .

- (2) There is another fusion product  $\otimes^1$  on  $\Omega\mathcal{C}$  defined by horizontally fusion two  $\mathbb{1}$ -strings in Figure 7. Mathematically, it comes from the fusion product of  $B\Omega\mathcal{C}$ .

$$\begin{aligned} \text{hom}_{\mathcal{C}}(\mathbb{1}, \mathbb{1}) \times \text{hom}_{\mathcal{C}}(\mathbb{1}, \mathbb{1}) &\xrightarrow{\otimes} \text{hom}_{\mathcal{C}}(\mathbb{1} \otimes \mathbb{1}, \mathbb{1} \otimes \mathbb{1}) \simeq \text{hom}_{\mathcal{C}}(\mathbb{1}, \mathbb{1}) \\ (a, c) &\mapsto a \otimes^1 c. \end{aligned}$$

It is obvious that  $1_{\mathbb{1}}$  is also the unit of the fusion product  $\otimes^1$ .

Physically, it is obvious that these two fusion products are compatible with each other. It means that the following diagram

$$\begin{array}{ccc}
\Omega\mathcal{C} \times \Omega\mathcal{C} \times \Omega\mathcal{C} \times \Omega\mathcal{C} & \xleftarrow{1 \times \tau \times 1} & \Omega\mathcal{C} \times \Omega\mathcal{C} \times \Omega\mathcal{C} \times \Omega\mathcal{C} \\
\downarrow \otimes^1 \times \otimes^1 & & \downarrow \otimes^2 \times \otimes^2 \\
\Omega\mathcal{C} \times \Omega\mathcal{C} & \xrightarrow{\delta} & \Omega\mathcal{C} \times \Omega\mathcal{C} \\
\searrow \otimes^2 & & \swarrow \otimes^1 \\
& \Omega\mathcal{C} & 
\end{array} \tag{2.3.3}$$

where  $\tau$  is defined by  $(b, c) \mapsto (c, b)$  for  $c, b \in \Omega\mathcal{C}$ , is commutative up to a natural isomorphism  $\delta$ . Equivalently, there is a natural isomorphism, for  $a, b, c, d \in \Omega\mathcal{C}$ ,

$$\delta_{a,b,c,d} : (a \otimes^1 b) \otimes^2 (c \otimes^1 d) \xrightarrow{\simeq} (a \otimes^2 c) \otimes^1 (b \otimes^1 d). \tag{2.3.4}$$

- By restricting to a special case, we obtain

$$a \otimes^2 d \simeq (a \otimes^1 1_{\perp}) \otimes^2 (1_{\perp} \otimes d) \xrightarrow{\delta_{a,1_{\perp},1_{\perp},d}} (a \otimes^2 1_{\perp}) \otimes^1 (1_{\perp} \otimes^2 d) \simeq a \otimes^1 d. \tag{2.3.5}$$

which says that two fusion products are isomorphic. If we use the physical intuition discussed in the first way. Without loss of generality, we can set  $\otimes^1 = \otimes_{(0,1)}$  and  $\otimes^2 = \otimes_{(0,i)}$ , then  $\delta_{a,1_{\perp},1_{\perp},d}$  can be defined physically by the isomorphism  $T_{a,d}^{\gamma}$ , where  $\gamma := \{(0, e^{i\frac{\pi}{2}(1-t)}) | t \in [0, 1]\}$ .

- By restricting to another special case, we recover the braiding isomorphism

$$\begin{aligned}
c_{b,c}^1 : b \otimes^1 c &\simeq (1_{\perp} \otimes^2 b) \otimes^1 (c \otimes^2 1_{\perp}) \xrightarrow{\delta_{1_{\perp},b,c,1_{\perp}}^{-1}} (1_{\perp} \otimes^1 c) \otimes^2 (b \otimes^1 1_{\perp}) \\
&\simeq (c \otimes^1 1_{\perp}) \otimes^2 (1_{\perp} \otimes^1 b) \xrightarrow{\delta_{c,1_{\perp},1_{\perp},d}} (c \otimes^2 1_{\perp}) \otimes^1 (1_{\perp} \otimes^1 b) \simeq c \otimes^1 b,
\end{aligned} \tag{2.3.6}$$

$$\begin{aligned}
c_{b,c}^2 : b \otimes^2 c &\simeq (1_{\perp} \otimes^1 b) \otimes^2 (c \otimes^1 1_{\perp}) \xrightarrow{\delta_{1_{\perp},b,c,1_{\perp}}} (1_{\perp} \otimes^2 c) \otimes^1 (b \otimes^2 1_{\perp}) \\
&\simeq (c \otimes^2 1_{\perp}) \otimes^1 (1_{\perp} \otimes^2 b) \xrightarrow{\delta_{c,1_{\perp},1_{\perp},d}^{-1}} (c \otimes^1 1_{\perp}) \otimes^2 (1_{\perp} \otimes^1 b) \simeq c \otimes^2 b,
\end{aligned} \tag{2.3.7}$$

where we have used the fact that  $1_{\perp}$  is the tensor unit of  $\otimes^1$  and  $\otimes^2$ . We leave it as an exercise to prove that the isomorphism defined in (2.3.6) and (2.3.7) satisfies the axioms of a braiding.

In summary, we have sketched a proof of the fact that a 1-category  $\mathcal{A}$  being braided monoidal if and only if  $B\mathcal{A}$  is well defined and monoidal, or equivalently,  $B^2\mathcal{A}$  is a well-define 3-category. In more concrete terms, we have shown that the braiding monoidal structure of  $\Omega\mathcal{C}$  can be equivalently encoded by two fusions in two independent directions and their compatibilities. Now we translate this compatibility into more formal mathematical language.

Recall that the category of  $E_1$ -algebras in  $\text{Cat}_1$  (i.e., monoidal 1-categories) by  $\text{Alg}_{E_1}(\text{Cat}_1)$ . Its 1-morphisms are  $E_1$ -algebra homomorphisms (i.e., monoidal functors), and 2-morphisms are morphisms between two  $E_1$ -algebra homomorphisms (i.e., monoidal natural transformations). Now the fact that the pair  $(\otimes^2, 1_{\perp})$  endows  $\Omega\mathcal{C}$  with a monoidal structure can be represented by the following notation:

$$(\Omega\mathcal{C}, \otimes^2, 1_{\perp}) \in \text{Alg}_{E_1}(\text{Cat}_1) \quad \text{or} \quad \Omega\mathcal{C} \in \text{Alg}_{E_1}(\text{Cat}_1) \text{ for simplicity.}$$

Moreover,  $\text{Alg}_{E_1}(\text{Cat}_1)$  is again symmetric monoidal with the same tensor product and the same tensor unit. In particular, we obtain  $\Omega\mathcal{C} \times \Omega\mathcal{C} \in \text{Alg}_{E_1}(\text{Cat}_1)$ . The monoidal structure on  $\Omega\mathcal{C} \times \Omega\mathcal{C}$  is defined

by the composed functor  $(\otimes^2 \times \otimes^2) \circ (1 \times \tau \times 1)$ . Then the compatibility condition (2.3.3) simply says that  $\otimes^1$  is an  $E_1$ -algebra homomorphism (or a monoidal functor). It means that  $\otimes^1 : \Omega\mathcal{C} \times \Omega\mathcal{C} \rightarrow \Omega\mathcal{C}$  is a 1-morphism in  $\text{Alg}_{E_1}(\text{Cat}_1)$ . Therefore,  $\otimes^1$  endows  $\Omega\mathcal{C}$  with a structure of an  $E_1$ -algebra in  $\text{Alg}_{E_1}(\text{Cat}_1)$ . In other words, we obtain

$$\Omega\mathcal{C} \in \text{Alg}_{E_1}(\text{Alg}_{E_1}(\text{Cat})). \quad (2.3.8)$$

This notation is heavily loaded. It means that  $\Omega\mathcal{C}$  has two multiplication maps  $\otimes^1$  and  $\otimes^2$ , and  $\otimes^1$  is a 1-morphism in  $\text{Alg}_{E_1}(\text{Cat})$ . What we have explained in this second way is actually a key fact

$$\text{Alg}_{E_2}(\text{Cat}_1) \simeq \text{Alg}_{E_1}(\text{Alg}_{E_1}(\text{Cat}_1)).$$

It is a well-known mathematical result that holds in more general context [Dun88, Lur17].

### 2.3.3 $E_m$ -multi-fusion $n$ -categories

We briefly review the notion of an  $E_m$ -multi-fusion  $n$ -category and some basic facts associated to it from [KZ22b, Section 3] and [KZ21a].

**Definition 2.3.1.** An  $E_1$ -monoidal  $n$ -category  $\mathcal{A}$  is a pair  $(\mathcal{A}, B\mathcal{A})$ , where  $B\mathcal{A}$  is the one-point delooping of  $\mathcal{A}$ . The identity 1-morphism  $1_\bullet$  is the tensor unit of  $\mathcal{A}$ . By induction, an  $E_m$ -monoidal  $n$ -category is a pair  $(\mathcal{A}, B\mathcal{A})$  such that  $B\mathcal{A}$  is an  $E_{m-1}$ -monoidal  $n$ -category. By abusing notation, we simply denote such an  $E_{m-1}$ -monoidal  $n$ -category by  $\mathcal{A}$ , i.e.

$$\mathcal{A} = (\mathcal{A}, B\mathcal{A}, B^2\mathcal{A}, \dots, B^m\mathcal{A}).$$

When  $m = 1$ ,  $\mathcal{A}$  is also referred to as a *monoidal  $n$ -category*; when  $m = 2$ ,  $\mathcal{A}$  is also referred to as a *braided monoidal  $n$ -category*.  $\blacksquare$

We adapt the following convention. Note that  $B^{m-1}\mathcal{A}$  is  $E_1$ -monoidal and is equipped with a tensor product  $\otimes^1$ ;  $B^{m-2}\mathcal{A}$  is  $E_2$ -monoidal and is equipped with two tensor products  $\otimes^1, \otimes^2$ ;  $\mathcal{A}$  is  $E_m$ -monoidal and is equipped with  $m$  tensor products  $\otimes^1, \dots, \otimes^m$ . We always use a coordinate system  $(x^1, x^2, \dots, x^n)$  for the  $n$ -spatial dimensions such that  $\otimes^i$  is the tensor product in the positive  $x^i$ -direction for  $i = 1, \dots, n$ .

**Example 2.3.2.** A symmetric monoidal 1-category is an  $E_3$ -algebra in  $\text{Cat}_1$ . It turns out that an  $E_3$ -algebra in  $\text{Cat}_1$  is automatically  $E_\infty$ -monoidal because  $\text{Cat}_1$  does not have higher morphisms to distinguish higher commutativities. If one consider symmetric monoidal 3-category  $\text{Cat}_2$  (i.e. the 3-category of 2-categories), then we obtain  $E_3$ -algebras in  $\text{Cat}_2$  that are not  $E_\infty$ . More precisely, in this case, a monoidal 2-category is an  $E_1$ -algebra in  $\text{Cat}_2$ ; a braided monoidal 2-category is an  $E_2$ -algebra in  $\text{Cat}_2$ ; a sylleptic monoidal 2-category is an  $E_3$ -algebra in  $\text{Cat}_2$ ; a symmetric monoidal 2-category is an  $E_4$ -algebra in  $\text{Cat}_2$ , which is automatically an  $E_\infty$ -algebra in  $\text{Cat}_2$ . In general, an  $E_{n+2}$ -monoidal  $n$ -category in  $\text{Cat}_n$  is automatically an  $E_\infty$ -algebra in  $\text{Cat}_n$ .  $\heartsuit$

An  $E_0$ -monoidal  $n$ -category  $\mathcal{A}$  is a pair  $(\mathcal{A}, \mathbb{1}_{\mathcal{A}})$ , where  $\mathcal{A}$  is an  $n$ -category and  $\mathbb{1}_{\mathcal{A}} \in \mathcal{A}$  is a distinguished object. An  $E_0$ -monoidal functor  $(\mathcal{A}, \mathbb{1}_{\mathcal{A}}) \rightarrow (\mathcal{B}, \mathbb{1}_{\mathcal{B}})$  is a functor  $f : \mathcal{A} \rightarrow \mathcal{B}$  such that  $f(\mathbb{1}_{\mathcal{A}}) = \mathbb{1}_{\mathcal{B}}$ . An  $E_0$ -monoidal (higher) natural transformation is a (higher) natural transformation that is trivial on the distinguished object. We use  $E_0\text{Cat}_n$  to denote the  $(n+1)$ -category of  $E_0$ -monoidal categories,  $E_0$ -monoidal functors and  $E_0$ -monoidal (higher) natural transformations. We set

$$\text{Fun}^{E_0}((\mathcal{A}, \mathbb{1}_{\mathcal{A}}), (\mathcal{B}, \mathbb{1}_{\mathcal{B}})) := \text{hom}_{E_0\text{Cat}_n}((\mathcal{A}, \mathbb{1}_{\mathcal{A}}), (\mathcal{B}, \mathbb{1}_{\mathcal{B}})),$$

which is (not full) subcategory of  $\text{Fun}(\mathcal{A}, \mathcal{B})$ . We use  $E_m\text{Cat}_n$  to denote the full  $(n+1)$ -subcategory  $E_0\text{Cat}_n$  consisting of all the iterated 1-point deloopings  $B^m\mathcal{C}$ . We set

$$\text{Fun}^{E_m}(\mathcal{A}, \mathcal{B}) := \text{Fun}^{E_0}(B^m\mathcal{A}, B^m\mathcal{B}).$$

**Definition 2.3.3.** For  $k > -m$ , we use  $\mathcal{A}^{\text{op}k}$  to denote the  $E_m$ -monoidal  $n$ -category obtained by reversing all the  $k$ -morphisms, i.e.,  $B^m(\mathcal{A}^{\text{op}k}) = (B^m \mathcal{A})^{\text{op}(k+m)}$ . We set  $\mathcal{A}^{\text{op}} := (B^m \mathcal{A})^{\text{op}1} = \mathcal{A}^{\text{op}(1-m)}$ . In other words,  $\mathcal{A}^{\text{op}}$  flips the fusion product  $\otimes^1$  to the opposite fusion product  $(\otimes^1)^{\text{op}}$  defined by  $a(\otimes^1)^{\text{op}} b := b \otimes^1 a$ . ■

We denote by  $\text{KarCat}_n^{\mathbb{C}}$  the  $(n+1)$ -category of condensation complete (or Karoubi complete)  $\mathbb{C}$ -linear  $n$ -categories ( $\mathbb{C}$ -linear functors, etc) [JF22, KZ22b]. It is also a symmetric monoidal  $(n+1)$ -category [JF22]. Its tensor product, denoted by  $\boxtimes$ , is defined by

$$\text{Fun}_{\mathbb{C}}(\mathcal{A} \boxtimes \mathcal{B}, -) \simeq \text{Fun}_{\mathbb{C}}(\mathcal{A}, \text{Fun}_{\mathbb{C}}(\mathcal{B}, -)),$$

where  $\text{Fun}_{\mathbb{C}}(\cdot)$  denotes the category of  $\mathbb{C}$ -linear  $n$ -functors. Its tensor unit is  $n\text{Vec} := \Sigma^n \mathbb{C}$ . We denote by  $E_m \text{KarCat}_n^{\mathbb{C}}$  the  $(n+1)$ -category of  $E_m$ -monoidal  $n$ -categories,  $E_m$ -monoidal functors,  $E_m$ -monoidal (higher) natural transformations, etc.

**Definition 2.3.4 ([KZ22b]).** An  $E_m$ -multi-fusion  $n$ -category  $\mathcal{A}$  is a condensation-complete  $\mathbb{C}$ -linear  $E_m$ -monoidal  $n$ -category, i.e.,  $\mathcal{A} \in E_m \text{KarCat}_n^{\mathbb{C}}$ , such that  $\Sigma^m \mathcal{A}$  is a separable  $(n+m)$ -category, i.e.,  $\Sigma^m \mathcal{A} \in (n+m+1)\text{Vec}$ . It is called *connected* if  $\mathcal{A}$  is indecomposable separable  $n$ -category. If the tensor unit  $\mathbb{1}_{\mathcal{A}}$  is simple, then  $\mathcal{A}$  is called an  $E_m$ -fusion  $n$ -category. An  $E_m$ -fusion 0-category is just  $\mathbb{C}$ . ■

**Remark 2.3.5.** If  $\mathcal{A}$  is also  $E_{\infty}$ -monoidal, it means that  $\Sigma^m \mathcal{A}$  can be defined for all  $m$ . In this case,  $\Sigma^m \mathcal{A}$  is also  $E_{\infty}$ -monoidal. For example, symmetric fusion 1-categories are  $\text{Rep}(G)$  or  $\text{Rep}(G, z)$  for a finite group  $G$ . Then  $\Sigma^m \text{Rep}(G)$  and  $\Sigma^m \text{Rep}(G, z)$  are  $E_{\infty}$ -monoidal for all  $m$ . ◇

**Theorem 2.3.6 ([KZ22b]).** Let  $\mathcal{A}$  be a  $\mathbb{C}$ -linear condensation-complete  $E_m$ -monoidal  $n$ -category for  $m \geq 1$ . If  $\Sigma \mathcal{A}$  is a separable  $(n+1)$ -category, then  $\mathcal{A}$  is an  $E_m$ -multi-fusion  $n$ -category.

**Corollary 2.3.7 ([KZ22b]).** If  $\mathcal{A}$  is an  $E_m$ -multi-fusion  $n$ -category for  $n \geq 1$ , then  $\Omega \mathcal{A}$  is an  $E_{m+1}$ -multi-fusion  $(n-1)$ -category.

**Proposition 2.3.8 ([KZ22b]).** If  $\mathcal{A}$  is an indecomposable multi-fusion  $n$ -category, then we have

1.  $\mathcal{A} \simeq \oplus_{i,j} \mathcal{A}_{i,j}$ , where  $\mathcal{A}_{i,j} := e_i \otimes \mathcal{A} \otimes e_j$  and  $e_i$  are simple summands of  $\mathbb{1}_{\mathcal{A}}$ , i.e.  $\mathbb{1}_{\mathcal{A}} = \oplus_i e_i$ ;
2.  $\Sigma \mathcal{A} = \Sigma \mathcal{A}_{ii}$  and  $\mathcal{A}_{ii}$  is a fusion  $n$ -category;
3. the canonical  $\mathcal{A}_{ii}$ - $\mathcal{A}_{kk}$ -bimodule map  $\mathcal{A}_{ij} \boxtimes_{\mathcal{A}_{jj}} \mathcal{A}_{jk} \rightarrow \mathcal{A}_{ik}$  induced from the tensor product functor is an equivalence;
4. The  $\mathcal{A}_{ii}$ - $\mathcal{A}_{jj}$ -bimodule  $\mathcal{A}_{ij}$  is the inverse of the  $\mathcal{A}_{jj}$ - $\mathcal{A}_{ii}$ -bimodule  $\mathcal{A}_{ji}$ .

**Remark 2.3.9.** This definition of a multi-fusion 1-category is equivalent to the usual definition, i.e., a  $\mathbb{C}$ -linear monoidal 1-category satisfying the following properties.

- (1) *Rigidity:* Every particle  $x$  has a right dual particle  $x^R$ , together with a creation morphism  $b_x^R : \mathbb{1} \rightarrow x^R \otimes x$  and an annihilation morphism  $d_x : x \otimes x^R \rightarrow \mathbb{1}$ , satisfying some natural conditions; and a left dual particle  $x^L$ , together with a creation morphism  $b_x^L : \mathbb{1} \rightarrow x \otimes x^L$  and an annihilation morphism  $d_x^L : x^L \otimes x \rightarrow x$ , satisfying some natural conditions (see [EGNO15] for a review).
- (2) *Separability:*  $\mathcal{A}$  is a separable 1-category, i.e., a finite direct sum of  $\text{Vec}$ , or equivalently, an object in  $2\text{Vec}$  (recall Example 2.2.3).

Both properties follow immediately from the fact  $\Sigma \mathcal{A} = \text{RMod}_{\mathcal{A}}(2\text{Vec})$  is a separable 2-category and the fully-dualizability of  $3\text{Vec}$ . Conversely, a multi-fusion 1-category  $\mathcal{A}$  in the usual sense satisfies the condition that  $\Sigma \mathcal{A} \simeq \text{RMod}_{\mathcal{A}}(2\text{Vec})$  is a separable 2-category [DR18]. ◇



### 2.3.4 Condensable higher algebras

We have seen that an  $E_m$ -multi-fusion  $n$ -category is an  $E_m$ -algebra in  $(n+1)\text{Vec}$ . It turns out that they are also condensable (or separable) in a sense that we want to explain now. However, the mathematical theory of condensable (or separable) higher algebras in higher categories is very rich and highly non-trivial. It is beyond this work. We will develop such a theory in [KZZZ24]. In this work, we only briefly sketch some facts that are useful to later sections and provide some intuitions.

A 0-category is defined by a set. A 0-condensation is an equality between objects of a 0-category.

**Definition 2.3.10.** For two objects  $X$  and  $Y$  in a weak  $n$ -category  $\mathcal{C}$ , an  $n$ -condensation of  $X$  onto  $Y$ , denoted by  $X \twoheadrightarrow Y$ , is a pair of 1-morphism  $f : X \rightarrow Y$  and  $g : Y \rightarrow X$ , together with an  $(n-1)$ -condensation  $f g \twoheadrightarrow \text{id}_Y$ , i.e.

$$X \twoheadrightarrow Y := \{f : X \rightarrow Y : g, \quad f g \twoheadrightarrow \text{id}_Y\}$$

The object  $Y$  is called a condensate of  $X$ . A condensation is an  $n$ -condensation for some  $n$ . ■

**Example 2.3.11.** Let us unravel the definition in a few lower dimensional cases.

1. When  $n = 1$ ,  $\mathcal{C}$  is a 1-category. In this case, a 1-condensation is a pair of 1-morphisms  $f : X \rightarrow Y$  and  $g : Y \rightarrow X$  such that  $f g = \text{id}_Y$ . As a consequence,  $p := g f$  is an idempotent, i.e.  $p^2 = p$ .
2. When  $n = 2$ ,  $\mathcal{C}$  is a 2-category. A 2-condensation in  $\mathcal{C}$  is a pair of 1-morphisms  $f : X \rightarrow Y$  and  $g : Y \rightarrow X$  such that  $f g \twoheadrightarrow \text{id}_Y$  is a 1-condensation, i.e. there is a pair of 2-morphism  $i : f g \rightarrow \text{id}_Y$  and  $j : \text{id}_Y \rightarrow f g$  such that  $i j = \text{id}_{\text{id}_Y}$ .
  - (a) Let  $\mathcal{A}$  be a multi-fusion category, and let  $\text{LMod}_{\mathcal{A}}(2\text{Vec})$  be the 2-category of left finite semisimple  $\mathcal{A}$ -modules. Note that

$$\Omega_{\mathcal{A}}(\text{LMod}_{\mathcal{A}}(2\text{Vec})) = \text{Fun}_{\mathcal{A}}(\mathcal{A}, \mathcal{A}) \simeq \mathcal{A}^{\text{op}} \tag{2.3.9}$$

♡

Let  $A = (A, \mu_A, \eta_A)$  be an algebra in  $\mathcal{A}$ , where  $\mu_A : A \otimes A \rightarrow A$  is the multiplication and  $\eta_A : \mathbb{1}_{\mathcal{A}} \rightarrow A$  is the unit. Then  $\mathcal{M} := \text{RMod}_{\mathcal{A}}(\mathcal{A}) \in \text{LMod}_{\mathcal{A}}(2\text{Vec})$ . Now we would like to construct a 2-condensation  $\mathcal{A} \twoheadrightarrow \mathcal{M}$  when the algebra  $A$  is separable. It means that we should construct

$$f : \mathcal{A} \rightarrow \mathcal{M}, \quad g : \mathcal{M} \rightarrow \mathcal{A}, \quad i : f g \rightarrow \text{id}_{\mathcal{M}}, \quad j : \text{id}_{\mathcal{M}} \rightarrow f g$$

- $f = - \otimes A : \mathcal{A} \rightarrow \mathcal{M}$  defines a 1-morphism in  $\text{LMod}_{\mathcal{A}}(2\text{Vec})$ .
- $g = [A, -] : \mathcal{M} \rightarrow \mathcal{A}$  is precisely the forgetful functor and is automatically a left  $\mathcal{A}$ -module functor, and, at the same time, the right adjoint of  $f$ .
- $f g = [A, -] \otimes A$  is equipped with an evaluation 2-morphism

$$f g = [A, -] \otimes A \xrightarrow{i=\text{ev}} \text{id}_{\mathcal{M}},$$

i.e.  $\text{ev}_M = \mu_M : M \otimes A \rightarrow M$ , which is nothing but the right  $A$ -action on  $M$ . Note that  $i$  is a 1-morphism in  $\text{Fun}_{\mathcal{A}}(\mathcal{M}, \mathcal{M})$ .

- We need a natural transformation  $j : \text{id}_{\mathcal{M}} \rightarrow [A, -] \otimes A$  splitting  $i$  in  $\text{Fun}_{\mathcal{A}}(\mathcal{M}, \mathcal{M})$ . By [KZ17, Theorem 4.10], this condition is equivalent to the condition that  $A$  is separable algebra in  $\mathcal{A}$  in the usual sense, i.e.,  $\mu_A : A \otimes A \rightarrow A$  splits as  $A$ - $A$ -bimodules.
- (b) Using [GJF19, Proposition 3.1.5], a separable algebra  $A$  in  $\mathcal{A}^{\text{op}}$  can be defined as  $A = u^R \circ u$ , where  $u : \mathcal{A} \rightarrow \mathcal{M} \in \text{LMod}_{\mathcal{A}}(2\text{Vec})$  extends to a 2-condensation in  $2\text{Vec}$  and  $u^R$  is the right adjoint of  $u$ . This idea can be used to define a separable higher algebra in a higher multi-fusion categories. We will show that elsewhere.

The precise definition of a condensable  $E_m$ -algebra in an  $E_m$ -multi-fusion  $n$ -category will be given elsewhere. We only provide a working definition that provides some physical intuitions here. Roughly speaking, there is a morphism  $\mu_A^i : A \otimes A \rightarrow A$  of an  $E_m$ -algebra that defines the multiplication in the  $i$ th independent direction for  $i = 1, 2, \dots, m$ . All of them are compatible in the sense that  $\mu_A := \mu_A^1 \simeq \mu_A^i$  (see Section 4.1.1 for more discussion). It has a right adjoint  $\mu_A^R$ , and both  $\mu_A$  and  $\mu_A^R$  intertwine the  $m$ -dimensional  $A$ -actions. If  $\mu_A$  is an  $n$ -morphism, its right adjoint is not defined. In this case, for conveniences and physical applications, we assume that top two morphisms form a  $*$ -category. In particular, the space of  $n$ -morphisms are Hilbert space and  $f^*$  is defined for each  $n$ -morphisms  $f$ .<sup>7</sup> We set  $\mu_A^R = \mu_A^*$ . Since  $A$  plays the role of the vacuum in the condensed phase, we need impose a stability condition of the vacuum as explained in [Kon14] for the  $m = 1, 2$  and  $n = 1$  cases. More explicitly, it means that  $\mu_A \circ \mu_A^R = \text{id}_A$  when  $m = 1, 2$  and  $n = 1$ , and it can be generalized to higher dimensions.

**Definition 2.3.12.** In an  $E_m$ -multi-fusion  $n$ -category  $\mathcal{A}$ , a condensable (or separable)  $E_m$ -algebra  $A$  is an  $E_m$ -algebra  $A$  equipped with a condensation  $\mu_A \circ \mu_A^R \rightarrow \text{id}_A$  in  $\text{Mod}_A^{E_m}(\mathcal{A})$  (i.e., modules equipped with  $m$ -dimensional  $A$ -actions explained later), where  $\mu_A^R$  is the right adjoint of the multiplication 1-morphism  $\mu_A : A \otimes A \rightarrow A$ . It is called *simple* if  $\eta_A : \mathbb{1}_{\mathcal{A}} \rightarrow A$  is simple for  $n > 1$  and  $\text{hom}(\mathbb{1}_{\mathcal{A}}, A) \simeq \mathbb{C}$  for  $n = 1$ . It is called *indecomposable* if  $A$  is not a direct sum of two algebras. ■

**Example 2.3.13.** When  $m = 1$  and  $n = 2$ , above definition is the same as the notion of a separable algebra in [Dé23, DX23]. According to [Dé23, DX23], the following statements are true.

1. Condensable  $E_1$ -algebras in  $2\text{Vec}$  are precisely multi-fusion 1-categories, simple ones are fusion 1-categories, and indecomposable ones are indecomposable multi-fusion 1-categories.
2. Condensable  $E_2$ -algebras in  $2\text{Vec}$  are precisely  $E_2$ -multi-fusion 1-categories or braided multi-fusion 1-categories. Simple ones are  $E_2$ -fusion 1-categories or braided fusion 1-categories.
3. Condensable  $E_3$ -algebras in  $2\text{Vec}$  are symmetric multi-fusion 1-categories, which is automatically  $E_\infty$ -monoidal.
4. Condensable  $E_2$ -algebras in  $\mathfrak{Z}_1(2\text{Vec}_G)$  for a finite group  $G$  are exactly  $G$ -crossed braided multi-fusion 1-categories.
5. Let  $\mathcal{B}$  be an  $E_2$ -fusion 1-category. A braided multi-fusion 1-category equipped with a braided functor from  $\mathcal{B}$  is a condensable  $E_2$ -algebra in the  $E_2$ -fusion 2-category  $\mathfrak{Z}_1(\text{RMod}_{\mathcal{B}}(2\text{Vec}))$ . ♡

We will show elsewhere that an  $E_m$ -multi-fusion  $n$ -category  $\mathcal{A}$  is a condensable  $E_m$ -algebra in  $(n + 1)\text{Vec}$  when we develop the mathematical theory of condensable or separable  $E_m$ -algebras in an  $E_m$ -multi-fusion category. In this work, we simply take it for granted. Moreover, for  $m > 1$ , indecomposable condensable  $E_m$ -algebras in  $(n + 1)\text{Vec}$  are precisely  $E_m$ -fusion  $n$ -categories, which are automatically simple. For  $m = 1$ , indecomposable condensable  $E_1$ -algebras in  $(n + 1)\text{Vec}$  are indecomposable multi-fusion  $n$ -categories. We denote the category of condensable  $E_m$ -algebras in  $\mathcal{A}$  by  $\text{Alg}_{E_m}^c(\mathcal{A})$ . We denote the statement that  $A$  is a condensable  $E_m$ -algebra  $A$  in  $\mathcal{A}$  by  $A \in \text{Alg}_{E_m}^c(\mathcal{A})$ . Then we also have  $\mathcal{A} \in \text{Alg}_{E_m}^c((n + 1)\text{Vec})$ . As we have explained in Section 2.3.2, by iterating the same argument, we obtain

$$\text{Alg}_{E_m}^c(\mathcal{A}) \simeq \text{Alg}_{E_1}^c(\text{Alg}_{E_{m-1}}^c(\mathcal{A})).$$

Moreover, from Example 2.3.11, we see that a condensable  $E_1$ -algebra  $A$  in a multi-fusion 1-category can always be realized by an internal hom  $[A, A]$  (see Section 3.1.3 for a brief introduction of this notion). This fact can be generalized to condensable  $E_m$ -algebras in  $E_m$ -multi-fusion  $n$ -categories. We will develop the theory elsewhere. In this work, we simply take it for granted that all internal homs naturally constructed are separable higher algebras, and vice versa. We also take it for granted that the higher

<sup>7</sup>In this case, we have  $g^R = g^L = g^*$  for all  $k$ -morphisms  $g$  [KWZ15, Proposition A.7].

representation theory of condensable  $E_m$ -algebras in an  $E_m$ -multi-fusion  $n$ -category is compatible with condensation complete. In particular, all the categories of  $E_k$ -modules appear in this work are separable. The special case for  $m = n = 2$  was proved in [DX23]. We treat general cases elsewhere.

**Remark 2.3.14.** For physics oriented readers, it is helpful and harmless to ignore the subtleness in the definition of separability and take it for granted that all physically natural algebras or higher monoidal categories are automatically condensable or separable and unitary. Indeed, in all pictures, when we illustrate the physical intuitions, the unitarity is automatically assumed to avoid the framing anomalies. Under the unitary assumption, the left and right duals of a topological defect  $x$  are the same, i.e.,  $x^R = x^L = x^*$ , which should be viewed as the anti-defect of  $x$ .  $\diamond$

### 2.3.5 $E_m$ -center and $E_m$ -centralizer

We review some useful results on  $E_m$ -centralizer and  $E_m$ -centers from [KZ21a]. They are useful later. If a physical oriented reader find it too abstract, it can be ignored because the most parts of the work can be read without knowing these notions.

**Definition 2.3.15.** For  $\mathcal{A}, \mathcal{B} \in E_m \text{KarCat}_n^{\mathbb{C}}$  and a  $\mathbb{C}$ -linear  $E_m$ -monoidal functor  $F : \mathcal{A} \rightarrow \mathcal{B}$ , the  $E_m$ -centralizer of  $F$  is the universal condensation-complete  $\mathbb{C}$ -linear  $E_m$ -monoidal  $n$ -category  $\mathfrak{Z}_m(F)$  equipped with a unital action  $G : \mathfrak{Z}_m(F) \boxtimes \mathcal{A} \rightarrow \mathcal{B}$ , i.e. a  $\mathbb{C}$ -linear  $E_m$ -monoidal functor exhibiting the following diagram commutative (up to equivalences).

$$\begin{array}{ccc} & \mathfrak{Z}_m(F) \boxtimes \mathcal{A} & \\ \mathbb{1}_{\mathfrak{Z}_m(F) \boxtimes \mathcal{A}} \nearrow & & \searrow G \\ \mathcal{A} & \xrightarrow{F} & \mathcal{B} \end{array}$$

For convenience, when  $F$  is clear from the context, we also denote  $\mathfrak{Z}_m(F)$  by  $\mathfrak{Z}_m(\mathcal{A}, \mathcal{B})$ . When  $F = \text{id}_{\mathcal{A}}$ , then  $\mathfrak{Z}_m(\mathcal{A}) := \mathfrak{Z}_m(\text{id}_{\mathcal{A}}) = \mathfrak{Z}_m(\mathcal{A}, \mathcal{A})$  defines the  $E_m$ -center of  $\mathcal{A}$ .  $\blacksquare$

**Remark 2.3.16.** We spell out the universal property of  $\mathfrak{Z}_m(F)$  more explicitly. If  $\mathcal{X} \in E_m \text{KarCat}_n^{\mathbb{C}}$  is equipped with a unital action  $H : \mathcal{X} \boxtimes \mathcal{A} \rightarrow \mathcal{B}$  (i.e., exhibiting the bottom triangle in the following diagram commutative),

$$\begin{array}{ccc} & \mathfrak{Z}_m(F) \boxtimes \mathcal{A} & \\ \mathbb{1}_{\mathfrak{Z}_m(F) \boxtimes \mathcal{A}} \nearrow & \exists! f \boxtimes \text{id}_{\mathcal{A}} \uparrow & \searrow G \\ \mathcal{X} \boxtimes \mathcal{A} & & \mathcal{B} \\ \mathbb{1}_{\mathcal{X} \boxtimes \mathcal{A}} \nearrow & & \searrow H \\ \mathcal{A} & \xrightarrow{F} & \mathcal{B} \end{array} \quad (2.3.10)$$

then there is a unique  $\mathbb{C}$ -linear  $E_m$ -monoidal functor  $f : \mathcal{X} \rightarrow \mathfrak{Z}_m(F)$  rendering above diagram commutative.  $\diamond$

**Example 2.3.17.** For  $F : \mathcal{A} \rightarrow \mathcal{B}$ ,  $\mathfrak{Z}_0(F) = \mathfrak{Z}_0(\mathcal{A}, \mathcal{B}) = (\text{Fun}(\mathcal{A}, \mathcal{B}), F)$  because giving a unital action  $\mathcal{C} \boxtimes \mathcal{A} \rightarrow \mathcal{B}$  is equivalent to giving a  $\mathbb{C}$ -linear functor  $\mathcal{C} \rightarrow \text{Fun}(\mathcal{A}, \mathcal{B})$  that maps  $\mathbb{1}_{\mathcal{C}}$  to  $F$ .  $\heartsuit$

**Example 2.3.18.** For  $\mathcal{A} \in \text{Alg}_{E_1}^{\mathbb{C}}((n+1)\text{Vec})$  and  $\mathcal{M} \in \text{LMod}_{\mathcal{A}}((n+1)\text{Vec})$ , by definition,  $\mathcal{M}$  is equipped with a monoidal functor  $F : \mathcal{A} \rightarrow \mathfrak{Z}_0(\mathcal{M})$ . We have

$$\mathfrak{Z}_1(F) = \mathfrak{Z}_1(\mathcal{A}, \mathfrak{Z}_0(\mathcal{M})) \simeq \text{Fun}_{\mathcal{A}}(\mathcal{M}, \mathcal{M}). \quad (2.3.11)$$

In fact, given a unital action  $\mathcal{X} \boxtimes \mathcal{A} \rightarrow \mathfrak{Z}_0(\mathcal{M})$  is equivalent to giving a  $\mathbb{C}$ -linear monoidal functor  $\mathcal{X} \rightarrow \text{Fun}_{\mathcal{A}}(\mathcal{M}, \mathcal{M})$ . We provide a physical meaning of (2.3.18) as illustrated below.

$$\begin{array}{c}
\boxed{Z(\mathcal{A})^{n+2} = Z(\mathcal{B})^{n+2}} \\
\hline
\begin{array}{ccc}
\longrightarrow & \square & \longrightarrow \\
\mathcal{A}^{n+1} & \mathcal{M}^n & \mathcal{B}^{n+1}
\end{array}
\end{array}
\quad
\begin{array}{l}
\mathcal{M}^n = (\mathcal{M}, m), \quad m \in \mathcal{M}, \\
\mathcal{B}^{\text{op}} = \text{Fun}_{\mathcal{A}}(\mathcal{M}, \mathcal{M}) \simeq \mathfrak{Z}_1(\mathcal{A}, \mathfrak{Z}_0(\mathcal{M})), \\
\mathcal{A} = \text{Fun}_{\mathcal{B}^{\text{op}}}(\mathcal{M}, \mathcal{M}) \simeq \mathfrak{Z}_1(\mathcal{B}^{\text{op}}, \mathfrak{Z}_0(\mathcal{M})),
\end{array}
\tag{2.3.12}$$

where the categories of all topological defects in two simple  $n+1$ D topological order  $\mathcal{A}^{n+1}$  and  $\mathcal{B}^{n+1}$  are the fusion  $n$ -category  $\mathcal{A}$  and  $\mathcal{B}$ , respectively, and the gapped domain wall  $\mathcal{M}^n$ , as we show later, can be described by a pair  $(\mathcal{M}, m)$ , where  $\mathcal{M} \in \text{BMod}_{\mathcal{A}|\mathcal{B}}((n+1)\text{Vec})$  is the category of wall conditions and  $m$  is an object in  $\mathcal{M}$  specifying a wall condition. When  $\mathcal{A} = n\text{Vec}$ ,  $\mathcal{M} \in (n+1)\text{Vec}$ , if  $F : n\text{Vec} \rightarrow \mathfrak{Z}_0(\mathcal{M})$  is the tensor unit of  $\mathfrak{Z}_0(\mathcal{M})$ , we obtain  $\mathfrak{Z}_1(F) \simeq \mathfrak{Z}_0(\mathcal{M})$ .  $\heartsuit$

**Proposition 2.3.19.** Let  $F : \mathcal{A} \rightarrow \Omega\mathcal{B}$  be a  $\mathbb{C}$ -linear  $E_m$ -monoidal functor for  $\mathcal{A} \in E_m \text{KarCat}_n^{\mathbb{C}}$  and  $\mathcal{B} \in E_{m-1} \text{KarCat}_n^{\mathbb{C}}$ . We have

$$\mathfrak{Z}_m(\mathcal{A}, \Omega\mathcal{B}) \simeq \Omega \mathfrak{Z}_{m-1}(\Sigma\mathcal{A}, \mathcal{B}). \tag{2.3.13}$$

**Theorem 2.3.20.** Let  $F : \mathcal{A} \rightarrow \mathcal{B}$  be a  $\mathbb{C}$ -linear  $E_m$ -monoidal functor for  $\mathcal{A}, \mathcal{B} \in E_m \text{KarCat}_n^{\mathbb{C}}$ . For  $0 \leq k \leq m$ ,  $F$  induces canonically a functor  $\Sigma^k F : \Sigma^k \mathcal{A} \rightarrow \Sigma^k \mathcal{B}$ . We have

$$\mathfrak{Z}_m(F) = \mathfrak{Z}_m(\mathcal{A}, \mathcal{B}) = \Omega^k \mathfrak{Z}_{m-k}(\Sigma^k \mathcal{A}, \Sigma^k \mathcal{B}) = \Omega^m (\text{Fun}(\Sigma^m \mathcal{A}, \Sigma^m \mathcal{B}), \Sigma^m F). \tag{2.3.14}$$

As a special case, we have

$$\mathfrak{Z}_m(\mathcal{A}) \simeq \Omega \mathfrak{Z}_{m-1}(\Sigma\mathcal{A}) \simeq \Omega^m \mathfrak{Z}_0(\Sigma^m \mathcal{A}) \simeq \Omega^m \text{Fun}(\Sigma^m \mathcal{A}, \Sigma^m \mathcal{A}). \tag{2.3.15}$$

**Example 2.3.21.** When  $m = 1$ , we obtain

$$\mathfrak{Z}_1(\mathcal{A}, \mathcal{B}) = \Omega(\text{Fun}(\Sigma\mathcal{A}, \Sigma\mathcal{B}), F) \simeq \text{Fun}_{\mathcal{A}|\mathcal{B}}(\mathcal{B}, \mathcal{B}) \simeq \text{Fun}_{\mathcal{A}|\mathcal{B}}(\mathcal{A}, \mathcal{B}).$$

**Corollary 2.3.22.** If  $\mathcal{A}, \mathcal{B} \in \text{Alg}_{E_m}^{\mathbb{C}}((n+1)\text{Vec})$  and  $F : \mathcal{A} \rightarrow \mathcal{B}$  is  $\mathbb{C}$ -linear  $E_m$ -monoidal, then  $\mathfrak{Z}_m(F) = \mathfrak{Z}_m(\mathcal{A}, \mathcal{B}) \in \text{Alg}_{E_m}^{\mathbb{C}}((n+1)\text{Vec})$ .

**Definition 2.3.23.** We introduce the following notions.

1. An  $E_1$ -multi-fusion  $n$ -category  $\mathcal{A}$  is called *non-degenerate* if  $\mathfrak{Z}_1(\mathcal{A}) \simeq n\text{Vec}$ . Let  $\mathcal{A}$  be non-degenerate. For  $A \in \text{Alg}_{E_1}^{\mathbb{C}}(\mathcal{A})$ ,  $A$  is called *Lagrangian* if  $\text{Mod}_A^{E_1}(\mathcal{A}) \simeq n\text{Vec}$ .
2. An  $E_2$ -fusion  $n$ -category  $\mathcal{B}$  is called *non-degenerate* if  $\mathfrak{Z}_2(\mathcal{B}) \simeq n\text{Vec}$ . Let  $\mathcal{B}$  be non-degenerate, For  $B \in \text{Alg}_{E_2}^{\mathbb{C}}(\mathcal{B})$ ,  $B$  is called *Lagrangian* if  $\text{Mod}_B^{E_2}(\mathcal{B}) \simeq n\text{Vec}$ .

**Remark 2.3.24.** An multi-fusion  $n$ -category  $\mathcal{C}$  is non-degenerate if and only if  $\mathcal{C}$  as a  $\mathbb{C}$ - $\mathbb{C}$ -bimodule is closed, i.e., the canonical monoidal functor  $\mathcal{C} \boxtimes \mathcal{C}^{\text{op}} \rightarrow \text{Fun}(\mathcal{C}, \mathcal{C})$  is an equivalence. The  $E_1$ -center of a direct sum of two multi-fusion  $n$ -categories is the direct sum of the  $E_1$ -centers of the summands. Moreover, the  $E_1$ -center of an indecomposable multi-fusion  $n$ -category is an  $E_2$ -fusion  $n$ -category. Therefore, a non-degenerate multi-fusion  $n$ -category is automatically indecomposable.  $\diamond$

### 3 Condensations of 1-codimensional topological defects

In this section, we study the condensations of 1-codimensional topological defects. We start from reviewing theory of the particle condensations in 1+1D (potentially anomalous) topological orders.

#### 3.1 Particle condensations in 1+1D topological orders

##### 3.1.1 Particle condensations I: algebraic bootstrap

In this subsection, we briefly review the bootstrap arguments in [Kon14] that leads to the particle condensation theory for potentially anomalous 1+1D topological orders.

Consider a 1+1D (potentially anomalous) topological order  $\mathcal{C}^2$  as depicted in only the spatial dimension in Figure 8. Its particles form a fusion 1-category  $\mathcal{C}$  (recall Remark 2.2.7). Now we consider a particle condensation happening in a large but connected region and producing a new 1+1D topological order  $\mathcal{D}^2$ , whose particles form a new fusion 1-category  $\mathcal{D}$  (see Figure 8), and two gapped domain wall  $M^1$  and  $\overline{M}^1$ , where  $\overline{M}^1$  can be viewed as the time reversal of  $M$ . The bulk  $Z(\mathcal{C})^2$  remains unchanged.

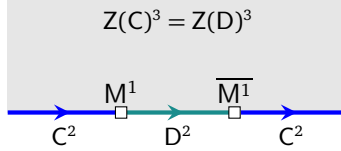

Figure 8: a condensation in the topological order  $\mathcal{C}^2$

Since  $\mathcal{D}^2$  is obtained from a condensation of  $\mathcal{C}^2$ , particles in  $\mathcal{D}$  necessarily come from those in  $\mathcal{C}$ , i.e.  $\text{ob}(\mathcal{D}) \subset \text{ob}(\mathcal{C})$ . The hom space  $\text{hom}_{\mathcal{C}}(a, b)$  for  $a, b \in \mathcal{C}$  encodes the information of how many independent channels of fusing or splitting  $a$  into  $b$ . It is clear that the fusion-splitting channels between particles in  $\mathcal{D}$  necessarily come from those between particles in  $\mathcal{C}$ , i.e.  $\text{hom}_{\mathcal{D}}(a, b) \subset \text{hom}_{\mathcal{C}}(a, b)$ . As a consequence,  $\mathcal{D}$  is necessarily a sub-category of  $\mathcal{C}$ , i.e.  $\mathcal{D} \subset \mathcal{C}$ . In particular, the vacuum or the trivial particle in  $\mathcal{D}$  is necessarily a (composite) particle  $A \in \mathcal{C}$ .

A particle condensation is triggered by introducing interactions among particles. For example, for  $a, b \in \mathcal{D} \subset \mathcal{C}$ , the consequence of introducing interactions between particles is that a sub-Hilbert space of the Hilbert space associated to  $a \otimes_{\mathcal{C}} b$  becomes energy favorable. This sub-Hilbert space gives a physical definition of the fusion product  $a \otimes_{\mathcal{D}} b$  in the condensed phase  $\mathcal{D}$ . In other words, the condensation process produces a family of projections (called condensation maps):

$$a \otimes_{\mathcal{C}} b \xrightarrow{P_{a,b}} a \otimes_{\mathcal{D}} b, \quad \forall a, b \in \mathcal{D}.$$

In particular, we have the following condensation maps:

$$\begin{aligned} \mu_A : A \otimes_{\mathcal{C}} A &\xrightarrow{P_{AA}} A \otimes_{\mathcal{D}} A \simeq A. \\ \forall x \in \mathcal{D}, \quad \mu_x^L : A \otimes_{\mathcal{C}} x &\xrightarrow{P_{Ax}} A \otimes_{\mathcal{D}} x \simeq x, \quad \mu_x^R : x \otimes_{\mathcal{C}} A \xrightarrow{P_{xA}} x \otimes_{\mathcal{D}} A \simeq x. \end{aligned}$$

Moreover, since the vacuum in  $\mathcal{C}$  should condense into the vacuum in  $\mathcal{D}$ , we expect to have a morphism  $\eta_A : \mathbb{1}_{\mathcal{C}} \rightarrow A$ . The triple  $(A, \mu_A, \eta_A)$  defines an algebra or an  $E_1$ -algebra in  $\mathcal{C}$  and the triple  $(x, \mu_x^L, \mu_x^R)$  defines an  $A$ - $A$ -bimodule in  $\mathcal{C}$ . Moreover,  $\mu_A$  splits as an  $A$ - $A$ -bimodule map due to a natural condition on the stability of the vacuum of the condensed phase  $\mathcal{D}^2$  [Kon14]. Namely, there exists an  $A$ - $A$ -bimodule map  $e_A : A \rightarrow A \otimes A$  such that  $\mu_A \circ e_A = \text{id}_A$ , which is the defining condition of a condensable (or separable)  $E_1$ -algebra in  $\mathcal{C}$ . In the unitary case,  $e_A$  can be chosen to be  $\mu_A^\dagger$  and  $A$  is naturally a special  $\dagger$ -Frobenius algebra.

**Remark 3.1.1.** As we explained in Section 2.3.1,  $\mathcal{C} \in \text{Alg}_{E_1}(2\text{Vec})$  and there are infinite number of tensor products  $\otimes_{(r,s)}$  on  $\mathcal{C}$ , which can be reduced to a single fusion product  $\otimes$  (and  $\otimes^{\text{op}}$ ) due to the Adiabatic Principle (2.3.1). Therefore, there is also infinitely many multiplication maps  $A \otimes_{(r,s)} A \rightarrow A$ , which endows  $A$  with the structure of an  $E_1$ -algebra in  $\mathcal{C}$ . In this case, an  $E_1$ -algebra in  $\mathcal{C}$  is precisely an associative algebra in  $\mathcal{C}$ . We use  $\text{Alg}_{E_1}^c(\mathcal{C})$  to denote condensable  $E_1$ -algebras in  $\mathcal{C}$ .

Similarly, the infinitely many  $A$ -action on  $x \in \mathcal{D}$ :  $x \otimes_{(r,s)} A \rightarrow x$  endows  $A$  with a structure of an  $E_1$ - $A$ -module. In this case, an  $E_1$ - $A$ -module in  $\mathcal{C}$  is precisely an  $A$ - $A$ -bimodule in  $\mathcal{C}$ . We denote the 1-category of  $E_1$ - $A$ -modules (as objects) and  $E_1$ - $A$ -modules maps (as 1-morphisms) by  $\text{Mod}_A^{E_1}(\mathcal{C})$ , which can be identified with  $\text{BMod}_{AA}(\mathcal{C})$ , i.e.  $\text{Mod}_A^{E_1}(\mathcal{C}) = \text{BMod}_{AA}(\mathcal{C})$ .  $\diamond$

**Theorem<sup>ph</sup> 3.1.2 ([Kon14]).** Using some obvious physical intuitions and certain stability arguments, one can easily derive the following results.

- (1) The triple  $(A, \mu_A, \eta_A)$  defines a condensable  $E_1$ -algebra in  $\mathcal{C}$ .
- (2) For  $x \in \mathcal{D}$ , the triple  $(x, \mu_x^L, \mu_x^R)$  defines an  $A$ - $A$ -bimodule in  $\mathcal{C}$ .
- (3)  $\mathcal{D} = \text{Mod}_A^{E_1}(\mathcal{C})$ , where  $\text{Mod}_A^{E_1}(\mathcal{C}) = \text{BMod}_{AA}(\mathcal{C})$  is the category of  $A$ - $A$ -bimodules or  $E_1$ - $A$ -modules in  $\mathcal{C}$  (as objects) and intertwiners (as 1-morphisms). The fusion product  $\otimes_{\mathcal{D}}$  can be identified with the relative tensor product  $\otimes_A$ , i.e.  $\otimes_{\mathcal{D}} = \otimes_A$ , and  $\mathbb{1}_{\mathcal{D}} = A$ .

If, in addition,  $\dim \text{hom}_{\mathcal{C}}(\mathbb{1}_{\mathcal{C}}, A) = 1$ ,  $A$  is called simple. When  $A$  is simple,  $\text{Mod}_A^{E_1}(\mathcal{C})$  is a fusion 1-category; otherwise, it is an indecomposable multi-fusion 1-category, which means that  $\mathcal{D}^2$  is a composite topological order.

The gapped domain wall  $M^1$  can also support particles. These particles form a separable 1-category  $\mathcal{M}$ . Since particles in  $\mathcal{C}$  can fuse onto the wall from left and particles in  $\mathcal{D}$  can fuse onto the wall from right,  $\mathcal{M}$  is necessarily a left  $\mathcal{C}$ -module and a right  $\mathcal{D}$ -module. More precisely, a left  $\mathcal{C}$ -module is a category  $\mathcal{M}$  equipped with a left  $\mathcal{C}$ -action functor  $\odot : \mathcal{C} \times \mathcal{M} \rightarrow \mathcal{M}$  that is unital and associative, i.e. there exist the following natural isomorphisms:

$$\mathbb{1}_{\mathcal{C}} \odot x \simeq x, \quad a \odot (b \odot x) \simeq (a \otimes_{\mathcal{C}} b) \odot x, \quad \forall a, b \in \mathcal{C}, x \in \mathcal{M},$$

where we have used the following notation  $\odot(a, x) := a \odot x$ , satisfying some physically natural conditions (see [EGNO15] for a review). A right  $\mathcal{D}$ -module is similar. Moreover, the two side actions on  $\mathcal{M}$  are obviously commutative. This means that there are natural isomorphisms

$$a \odot (x \odot d) \simeq (a \odot x) \odot d, \quad \forall a \in \mathcal{C}, x \in \mathcal{M}, d \in \mathcal{D},$$

satisfying some natural conditions. These data and conditions are the defining data and axioms of a  $\mathcal{C}$ - $\mathcal{D}$ -bimodule category. In summary,  $\mathcal{M}$  is a  $\mathcal{C}$ - $\mathcal{D}$ -bimodule in  $2\text{Vec}$ . However,  $\mathcal{M}$  does not catch the complete information of  $M$ . The physical domain wall  $M$  must specify a particle  $m \in \mathcal{M}$  (as a wall condition) such that fusing particles in  $\mathcal{C}$  (or  $\mathcal{D}$ ) onto the wall gives a well defined map  $\mathcal{C} \rightarrow \mathcal{M}$  defined by  $a \mapsto a \odot m$  for  $a \in \mathcal{C}$ , and a well define map  $\mathcal{D} \rightarrow \mathcal{M}$  defined by  $d \mapsto m \odot d$  for  $d \in \mathcal{D}$ . Therefore, the physical domain wall  $M$  can be mathematically described by a pair  $(\mathcal{M}, m)$ . Such a pair defines a so-called  $E_0$ -algebra in the symmetric monoidal 2-category  $2\text{Vec}$  [Lur17]. A morphism between two  $E_0$ -algebras  $(\mathcal{M}, m)$  and  $(\mathcal{M}', m')$  is a functor  $f : \mathcal{M} \rightarrow \mathcal{M}'$ , together with a morphism  $g : f(m) \rightarrow m'$ . We denote the category of  $E_0$ -algebras in  $2\text{Vec}$  by  $\text{Alg}_{E_0}(2\text{Vec})$ .

**Remark 3.1.3.** Similar to Remark 3.1.1, there are infinitely many  $\mathcal{C}$ -action on  $\mathcal{M}$  given by  $\odot_{(r,s)} : \mathcal{C} \times \mathcal{M} \rightarrow \mathcal{M}$  for  $r, s \in \mathbb{R}$  and  $r \neq s$ . When  $\mathcal{C} = \mathcal{D}$ , the category  $\mathcal{M}$  is naturally equipped with the structure of an  $E_1$ - $\mathcal{C}$ -module, i.e.  $\mathcal{M} \in \text{Mod}_{\mathcal{C}}^{E_1}(2\text{Vec}) = \text{BMod}_{\mathcal{C}\mathcal{C}}(2\text{Vec})$ .  $\diamond$

Since the domain wall  $M^1$  is also created from a particle condensation of  $\mathcal{C}^2$ , the particles and the fusion-splitting channels in  $\mathcal{M}$  should all come from  $\mathcal{C}$ . In other words,  $\mathcal{M}$  must be a subcategory of  $\mathcal{C}$ . Moreover, the condensation again produces a condensation map  $x \otimes A \rightarrow x \circlearrowleft A \simeq x$ , which clearly defines a right  $A$ -module structure on  $x$ . Note that an  $A$ - $A$ -module in  $\mathcal{C}$  is clearly a deconfined particle living in  $\mathcal{D}$ , while a right  $A$ -module in  $\mathcal{C}$  defines a particle that is necessarily confined to the domain wall. Therefore, we obtain  $\mathcal{M} = \text{RMod}_A(\mathcal{C})$ , where  $\text{RMod}_A(\mathcal{C})$  denotes the category of right  $A$ -modules in  $\mathcal{C}$  as objects and intertwiners (of the  $A$ -action) as morphisms. As a consequence, we have  $a \circlearrowleft x := a \otimes x$  and  $x \circlearrowleft d := x \otimes_A d$  for  $x \in \mathcal{M}$ ,  $a \in \mathcal{C}$  and  $d \in \mathcal{D}$ . If we do not specify any particle in the condensed phase in  $\mathcal{D}$ , any site in the  $D^2$ -phase naturally has the trivial particle  $\mathbb{1}_{\mathcal{D}} = A$  on it. Similarly, if we do not specify a particle on the wall  $M^1$ , then the trivial particle  $A$  naturally lives on it. Therefore, we should have  $M^1 = (\text{RMod}_A(\mathcal{C}), A)$ .

For the other wall  $\overline{M}^1$ , by the similar reason, we should expect that the category of particles on this wall is given by  $\mathcal{M}^{\text{op}} = \text{LMod}_A(\mathcal{C})$ . As a  $\mathcal{D}$ - $\mathcal{C}$ -bimodule  $\mathcal{M}^{\text{op}}$ , the action is defined by  $d \circlearrowleft m \circlearrowleft c := c^* \circlearrowleft m \circlearrowleft d^*$ , where we have used convention  $d^* = d^L = d^R$  as in the unitary case to avoid framing issues.

We summarize the result below.

**Theorem<sup>ph</sup> 3.1.4 ([Kon14]).** The gapped domain wall  $M$  can be mathematically characterized by the pair  $(\mathcal{M}, A)$ , where  $\mathcal{M} = \text{RMod}_A(\mathcal{C})$  and  $m \in \mathcal{M}$ .

- (1) Particles in  $\mathcal{C}$  move to the wall  $M$  according to the map  $a \mapsto a \otimes A, \forall a \in \mathcal{C}$ ;
- (2) particles in  $\mathcal{D}$  move to the wall  $M$  according to the map  $d \mapsto A \otimes_A d = d, \forall d \in \mathcal{D}$ .

We also have  $\overline{M} = (\mathcal{M}^{\text{op}}, A)$ , where  $\mathcal{M}^{\text{op}} \simeq \text{LMod}_A(\mathcal{C})$ . When  $A$  is simple,  $\mathcal{M} = \text{RMod}_A(\mathcal{C})$  is an indecomposable left  $\mathcal{C}$ -module; otherwise, it is a direct sum of indecomposable left  $\mathcal{C}$ -modules.

**Example 3.1.5.** Let  $G$  be a finite group. There is a gapped boundary of the 2+1D  $G$ -gauge theory whose topological defects form the fusion 1-category  $\text{Rep}(G)$  (when  $G = \mathbb{Z}_2$ , this is the smooth boundary of the toric code model). The classification of condensable  $E_1$ -algebras in  $\text{Rep}(G)$  is given by Ostrik [Ost03]. A condensable  $E_1$ -algebra in  $\text{Rep}(G)$  is a separable algebra  $A$  in  $\text{Vec}$  equipped with a  $G$ -action  $G \rightarrow \text{Aut}(A)$  satisfying the connected condition. The Morita classes of  $E_1$ -condensable algebras in  $\text{Rep}(G)$  are classified by pairs  $(H, \alpha)$ , where  $H \subseteq G$  is a subgroup and  $\alpha \in Z^2(H; U(1))$  is a 2-cocycle. Two Morita classes corresponding to  $(H, \alpha)$  and  $(K, \beta)$  are equal if and only if there exists an element  $g \in G$  such that  $gHg^{-1} = K$  and  $[\alpha] = [g^*\beta] \in H^2(H; U(1))$ , where  $g^*: Z^2(K; U(1)) \rightarrow Z^2(H; U(1))$  is the pullback morphism induced by the conjugation of  $g$ . The Morita classes of  $E_1$ -condensable algebras correspond to indecomposable finite semisimple  $\text{Rep}(G)$ -modules, which are the category  $\text{Rep}(H, \alpha)$  of finite-dimensional  $\alpha$ -twisted projective  $H$ -representations. Therefore, for any nonzero projective representation  $V \in \text{Rep}(H, \alpha)$ , the internal hom

$$[V, V]_{\text{Rep}(G)} = \text{Ind}_H^G \text{End}(V)$$

is a  $E_1$ -condensable algebra in  $\text{Rep}(G)$ , and its Morita class is the one corresponding to  $(H, \alpha)$ .

There is another gapped boundary of the 2+1D  $G$ -gauge theory whose topological defects form a fusion category  $\text{Vec}_G$  (when  $G = \mathbb{Z}_2$ , this is the rough boundary of the toric code model). A condensable  $E_1$ -algebra in  $\text{Vec}_G$  is a separable algebra  $A$  in  $\text{Vec}$  equipped with a  $G$ -grading such that the trivial component  $A_e = \mathbb{C}$  is trivial. The condensable  $E_1$ -algebras in  $\text{Vec}_G$  are given by the twisted group algebras  $\mathbb{C}[H, \alpha]$  equipped with the obvious  $G$ -grading, where  $H \subseteq G$  is a subgroup and  $\alpha \in Z^2(H; U(1))$  is a 2-cocycle. Two  $E_1$ -condensable algebras  $\mathbb{C}[H, \alpha]$  and  $\mathbb{C}[K, \beta]$  are Morita equivalent if and only if there exists an element  $g \in G$  such that  $gHg^{-1} = K$  and  $[\alpha] = [g^*\beta] \in H^2(H; U(1))$ , where  $g^*: Z^2(K; U(1)) \rightarrow Z^2(H; U(1))$  is the pullback morphism induced by the conjugation of  $g$ .  $\heartsuit$

**Example 3.1.6.** Consider gapped boundaries of 2+1D finite gauge theories. One can see that all gapped boundaries can be obtained by condensing certain connected separable algebra  $A \in \text{Rep}(G)$  in the special gapped boundary with  $\mathcal{C} = \text{Rep}(G)$ . We give a few explicit examples below.

1. When we condense  $A = \text{Fun}(G)$  in the gapped boundary associated to  $\text{Rep}(G)$ , we obtain the condensed boundary associated to  $\text{BMod}_{A|A}(\text{Rep}(G)) \simeq \text{Vec}_G$ , and the gapped domain wall  $\mathcal{M} = \text{RMod}_A(\text{Rep}(G)) \simeq \text{Vec}$ . When  $G = \mathbb{Z}_2$ , this condensation defines a boundary phase transition from the smooth boundary to the rough boundary.<sup>8</sup>
2. When we condense  $A = \text{Fun}(G/H)$  for a subgroup  $H < G$  in the gapped boundary associated to  $\text{Rep}(G)$ , we obtain the condensed boundary associated to

$$\text{BMod}_{A|A}(\text{Rep}(G)) \simeq \text{Fun}(\text{Vec}_{G/H}, \text{Vec}_{G/H})^G,$$

where  $\text{Fun}(\text{Vec}_{G/H}, \text{Vec}_{G/H})^G$  denotes the  $G$ -equivariantization of  $\text{Fun}(\text{Vec}_{G/H}, \text{Vec}_{G/H})$  [XZ22].<sup>9</sup>

**Example 3.1.7.** The topological defects on the trivial 1-codimensional topological defect in the 2+1D  $\mathbb{Z}_2$ -gauge theory form a fusion category  $\mathfrak{Z}_1(\text{Rep}(\mathbb{Z}_2))$ . By condensing simple condensable  $E_1$ -algebras in  $\mathfrak{Z}_1(\text{Rep}(\mathbb{Z}_2))$ , we obtain all simple 1-codimensional topological defects, which are simple objects in the fusion 2-category  $\Sigma\mathfrak{Z}_1(\text{Rep}(\mathbb{Z}_2))$ . This fusion 2-category has six simple objects, denoted by unit, dual, rr, rs, sr, ss [KZ22a].

Since  $\mathfrak{Z}_1(\text{Rep}(\mathbb{Z}_2)) \simeq \text{Vec}_{\mathbb{Z}_2 \times \mathbb{Z}_2}$ , the condensable  $E_1$ -algebras in  $\mathfrak{Z}_1(\text{Rep}(\mathbb{Z}_2))$  are classified by subgroups of  $\mathbb{Z}_2 \times \mathbb{Z}_2$  and the corresponding cohomology groups. We denote the simple objects in  $\mathfrak{Z}_1(\text{Rep}(\mathbb{Z}_2))$  by  $\mathbb{1}, e, m, f$ .

1. The tensor unit  $\mathbb{1}$  is a condensable  $E_1$ -algebra. By condensing  $\mathbb{1}$  we obtain the trivial domain wall unit.
2. There are three subgroups of  $\mathbb{Z}_2 \times \mathbb{Z}_2$  which are isomorphic to  $\mathbb{Z}_2$ . Since  $H^2(\mathbb{Z}_2; U(1)) = 0$  is trivial, there are three corresponding condensable  $E_1$ -algebra  $\mathbb{1} \oplus e, \mathbb{1} \oplus m, \mathbb{1} \oplus f$ . By condensing them we obtain the domain walls rr, ss, dual respectively.
3. Since  $H^2(\mathbb{Z}_2 \times \mathbb{Z}_2; U(1)) \simeq \mathbb{Z}_2$ , there are two condensable  $E_1$ -algebra structures on the object  $\mathbb{1} \oplus e \oplus m \oplus f$ . By condensing them we obtain the domain walls rs and sr respectively.  $\heartsuit$

**Example 3.1.8.** Recall the Ising fusion category  $\mathcal{J}_s$  in Example 2.1.3. According to [FRS02], all condensable  $E_1$ -algebras  $A$  in  $\mathcal{J}_s$  are Morita equivalent to the trivial  $E_1$ -algebras  $\mathbb{1}$ . More explicitly, one can show that they are the internal hom algebras:  $[x, x] = x \otimes x^*, \forall x \in \mathcal{J}_s$  (see Section 3.1.3 for a brief introduction of this notion). As a consequence, we have  $\text{BMod}_{A|A}(\mathcal{J}_s) \simeq \mathcal{J}_s$  for all condensable  $E_1$ -algebras  $A$ . In other words, all condensations in  $\mathcal{J}_s$ , viewed as a boundary phase of the 2+1D double Ising topological order, only produces the same and unique boundary phase of the 2+1D double Ising topological order. This fact is compatible with the fact that there is only one Lagrangian algebra in the double Ising braided fusion 1-category.  $\heartsuit$

### 3.1.2 Particle condensations II: geometric intuitions

We provide a physical intuition of a particle condensation. The condensation from the 1+1D anomalous topological order  $C^2$  to  $D^2$  can be achieved by

- (1) first proliferating the  $D^2$ -phases inside the  $C^2$ -phase as illustrated below in spatial dimensions;

$$\begin{array}{ccccccccccc} & & M^1 & & \overline{M}^1 & & M^1 & & \overline{M}^1 & & M^1 & & \overline{M}^1 & & \\ & & \blacksquare & & \blacksquare & & \blacksquare & & \blacksquare & & \blacksquare & & \blacksquare & & \\ \xrightarrow{C^2} & & \xrightarrow{D^2} & & \xrightarrow{C^2} & & \xrightarrow{D^2} & & \xrightarrow{C^2} & & \xrightarrow{D^2} & & \xrightarrow{C^2} & & \end{array} \quad (3.1.1)$$

<sup>8</sup>Applying the so-called topological Wick rotation [KZ22b], this condensation also defines the spontaneous symmetry-breaking from the symmetric phase to the symmetry-broken phase in the 1+1D Ising chain [KWZ22].

<sup>9</sup>Applying topological Wick rotation, this condensation defines the spontaneous symmetry-breaking from the symmetric phase to the symmetry-partially-broken (from  $G$ -symmetry to  $H$ -symmetry) phase in a 1+1D spin chain [XZ22].



- (2) then shrinking each black line segment  $\overline{M}^1 \boxtimes_{\mathcal{C}} M^1$  to a particle in  $\mathcal{D}^2$ ;
- (3) then annihilating this particle, i.e. mapping it to the trivial particle  $\mathbb{1}_{\mathcal{D}}$  in  $\mathcal{D}^2$ .

As a consequence, the entire 1d (spatial dimension) line turn into a green line.

Notice that shrinking a green line segment in (3.1.1), i.e.  $M \boxtimes_{\mathcal{D}} \overline{M}$  defines a particle  $A \in \mathcal{C}$ . The step (2) and (3) simply produces a morphism  $\mu_A : A \otimes_{\mathcal{C}} A \rightarrow A$ . Moreover, we should have a canonical map  $\eta_A : \mathbb{1}_{\mathcal{C}} \rightarrow A$ , which creates the green line out of nothing. This map makes the proliferating possible in the first place. Since the physical meanings of 1-morphisms  $\mu_A$  and  $\eta_A$  are instantons, we drew these instantons in the following spacetime pictures.

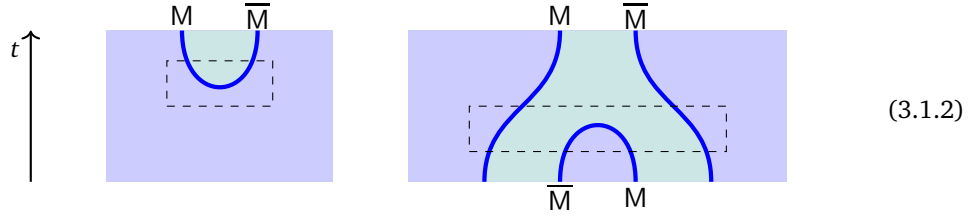

Then the following identities of 1-morphisms in  $\mathcal{C}$ :

$$\mu_A \circ (\mu_A \otimes \text{id}_A) = \mu_A \circ (\text{id}_A \otimes \mu_A), \quad \mu_A \circ (\eta_A \otimes \text{id}_A) = \text{id}_A = \mu_A \circ (\text{id}_A \otimes \eta_A)$$

holds by the obvious physical intuitions. For example, the first identity simply says that first running the procedure (2) and (3) to a blue line the first, then running the same procedures to the blue line next to it makes no difference to running in the opposite order. As a consequence, the triple  $(A, \mu_A, \eta_A)$  should define a condensable  $E_1$ -algebra in  $\mathcal{C}$ , which defines the fusion of two green lines into one.

**Remark 3.1.9.** In the unitary case, by turning the pictures in (3.1.2) upside down, we obtain the counit  $\epsilon_A$  and comultiplication  $\Delta_A = \mu_A^\dagger$ :

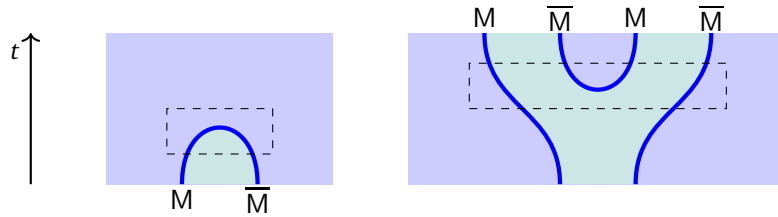

which is co-unital and co-associative. Moreover,  $(A, \mu_A, \eta_A, \Delta_A, \epsilon_A)$  defines a Frobenius algebra. Moreover, we should expect that  $m_A \circ \Delta_A = \text{id}_A$ , i.e.  $A$  is a special Frobenius algebra in  $\mathcal{C}$  [FRS02].  $\diamond$

A particle  $d \in \mathcal{D}$  in the condensed phase  $\mathcal{D}$  produces a particle in  $\mathcal{C}$  by viewed the green line segment decorated by  $d \in \mathcal{D}$  as a particle in  $\mathcal{C}$  as illustrated below.

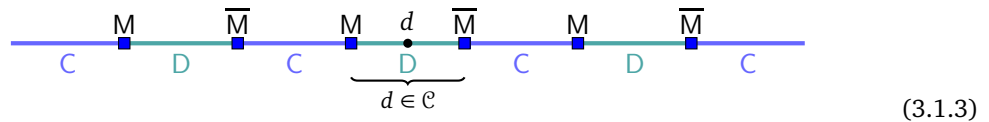

When  $d = \mathbb{1}_{\mathcal{D}}$ , this particle is  $\mathbb{1}_{\mathcal{D}} = A \in \mathcal{C}$ . Note that  $A$  is precisely  $\mathbb{1}_{\mathcal{D}}$  viewed as an object in  $\mathcal{C}$  because  $\mathcal{D} \subset \mathcal{C}$ . Therefore, for general  $d \in \mathcal{D}$ , we expect that this particle is precisely the same particle  $d$  viewed

as an object in  $\mathcal{C}$ . Then it is clear that procedures (2) and (3) define an  $A$ - $A$ -bimodule structure on the particle  $d \in \mathcal{C}$ . Therefore, we have recovered the same result  $\mathcal{D} = \text{BMod}_{A|A}(\mathcal{C})$ .

As we have shown in Section 3.1.1, the gapped domain wall  $M^1$  can also support particles, which form a separable 1-category  $\mathcal{M}$ . First,  $m \in \mathcal{M}$ ,  $m$  is necessarily an object in  $\mathcal{C}$ . Secondly,  $m$  is necessarily a right  $A$ -module. This suggest that  $\mathcal{M} = \text{RMod}_A(\mathcal{C})$ . The fact that the green line shrink to the particle in  $\mathcal{C}$  and the fact that the blue line shrink to a particle in  $\mathcal{D}$  simply suggests that

$$\mathcal{M}^{\text{op}} \boxtimes_{\mathcal{C}} \mathcal{M} \simeq \mathcal{D}, \quad \mathcal{M} \boxtimes_{\mathcal{D}} \mathcal{M}^{\text{op}} \simeq \mathcal{C}$$

as  $\mathcal{D}$ - $\mathcal{D}$ -bimodule categories and  $\mathcal{C}$ - $\mathcal{C}$ -bimodule categories, respectively. It means that  $\mathcal{M} = \text{RMod}_A(\mathcal{C})$  should be an invertible  $\mathcal{C}$ - $\mathcal{D}$ -bimodule that defines the Morita equivalence between  $\mathcal{C}$  and  $\mathcal{D} = \text{BMod}_{A|A}(\mathcal{C})$ . It is indeed true as a well-known mathematical fact. It is also clear that particles from two sides of  $M^1$  move onto the domain wall  $M$  according to  $a \mapsto a \otimes A$  and  $d \mapsto A \otimes_A d$  for  $a \in \mathcal{C}, d \in \mathcal{D}$ . Therefore, we have recovered the results in Theorem<sup>ph</sup> 3.1.2 and 3.1.4 via a geometric approach.

In physics, a phase transition can always go backwards by tuning the coupling constant of certain interactions in the opposite direction. Particle condensations in 1+1D topological orders are also reversible. More precisely,

- (1) one can view Figure 3.1.1 as a process of proliferating  $C^2$ -phase segments inside a large  $D^2$ -phase;
- (2) then shrink the green line segment to a particle in  $C^2$ -phase;
- (3) then annihilating this particle, i.e. mapping it to the trivial particle  $1_{\mathcal{C}}$  in  $C^2$ .

In this way, we obtain a particle condensation in  $D^2$  that reproduces the  $C^2$ -phase. In other words, by interchanging the role played by  $C^2$  and  $D^2$ , we obtain the reversed process. More precisely, by shrinking each blue line segment  $\overline{M} \boxtimes_{\mathcal{C}} M$  to a particle in  $D^2$ , we obtain a condensable particle in  $D^2$ . More precisely, this particle is automatically equipped with a structure of condensable  $E_1$ -algebra  $B$  in  $\mathcal{D}$ , thus defines a particle condensation in  $\mathcal{D}$ . Moreover, we must have  $\mathcal{C} = \text{BMod}_{B|B}(\mathcal{D})$  and  $\mathcal{M} = \text{LMod}_B(\mathcal{D})$ .

### 3.1.3 Internal homs

The physical intuitions described in Section 3.1.2 can be made mathematically precise. As a consequence, mathematical precise results match with the physical intuitions perfectly. These mathematical precise results rely heavily on an important categorical notion called an *internal hom*, which is very important to the condensation theory and to all QFTs as well (see [Dav10a, DKR15, KYZ21] and Remark 3.1.15). For this reason, we first review this notion (see more details in the book [EGNO15]).<sup>10</sup>

**Definition 3.1.10 ([Ost03]).** Let  $\mathcal{C}$  be a multi-fusion 1-category and  $\mathcal{M}$  be a separable left  $\mathcal{C}$ -module<sup>11</sup>, i.e. a category equipped with a (unital and associative)  $\mathcal{C}$ -action  $\odot : \mathcal{C} \times \mathcal{M} \rightarrow \mathcal{M}$ . For  $x, y \in \mathcal{M}$ , the internal hom  $[x, y]_{\mathcal{C}}$  is an object uniquely determined by the following isomorphisms:

$$\text{hom}_{\mathcal{M}}(a \odot x, y) \simeq \text{hom}_{\mathcal{C}}(a, [x, y]_{\mathcal{C}}), \quad \forall a \in \mathcal{C}, x, y \in \mathcal{M} \quad (3.1.4)$$

that are natural in the variable  $a$ , i.e. the following diagram:

$$\begin{array}{ccc} \text{hom}_{\mathcal{M}}(a' \odot x, y) & \xrightarrow{\simeq} & \text{hom}_{\mathcal{C}}(a', [x, y]_{\mathcal{C}}) \\ \downarrow - \circ (h \circ \text{id}_x) & & \downarrow - \circ h \\ \text{hom}_{\mathcal{M}}(a \odot x, y) & \xrightarrow{\simeq} & \text{hom}_{\mathcal{C}}(a, [x, y]_{\mathcal{C}}) \end{array}$$

<sup>10</sup>Although it is very tempting to suggest physics oriented readers to skip this subsection for their first reading, we want to emphasize that the notion of internal hom is so important and natural that it is precisely the mathematical structure needed to catch many physical intuitions. Since it is so basic, natural and important to QFT's, we are sure that it will become one of the most basic concepts in physics and a powerful tool for the physicists in the next generation.

<sup>11</sup>Our assumptions on  $\mathcal{C}$  and  $\mathcal{M}$  guarantee the existence of the internal homs.

is commutative for all  $h : a \rightarrow a'$ . We sometimes abbreviate  $[x, y]_{\mathcal{C}}$  to  $[x, y]$  for simplicity.  $\blacksquare$

There is a distinguished morphism  $\text{ev} : [x, y]_{\mathcal{C}} \otimes x \rightarrow y$  in  $\mathcal{M}$  defined by the preimage of  $\text{id}_{[x, y]_{\mathcal{C}}}$  under the isomorphism in (3.1.4). It allows us to give an equivalent definition of the internal hom via its universal property. Both definitions are useful and important in this work.

**Definition 3.1.11.** The internal hom can be equivalently defined by a pair  $([x, y]_{\mathcal{C}}, \text{ev})$ , where  $\text{ev} : [x, y]_{\mathcal{C}} \otimes x \rightarrow y$  is a morphism in  $\mathcal{M}$ , such that it is terminal among all such pairs. That is, given another pair  $(F, f)$ , where  $F \in \mathcal{C}$  and  $f : F \otimes x \rightarrow y$  is a morphism in  $\mathcal{M}$ , there exists a unique morphism  $g : F \rightarrow [x, y]_{\mathcal{C}}$  such that  $\text{ev} \circ (g \otimes \text{id}_x) = f$ . This universal property is often expressed by the following commutative diagram:

$$\begin{array}{ccc}
 & [x, y]_{\mathcal{C}} \otimes x & \\
 \exists! g \otimes \text{id}_x \nearrow & & \searrow \text{ev} \\
 F \otimes x & \xrightarrow{f} & y
 \end{array} \tag{3.1.5}$$

where the notation ‘ $\exists$ ’ represents ‘exists’ and the notation ‘ $!$ ’ represents ‘unique’.  $\blacksquare$

**Example 3.1.12.** We give two most useful examples, which also tell us how to compute internal homs.

1. when  $\mathcal{M} = \mathcal{C}$  and  $\otimes = \otimes_{\mathcal{C}}$ , we have  $[x, y]_{\mathcal{C}} = y \otimes_{\mathcal{C}} x^L$ ;
2. when  $\mathcal{M} = \text{RMod}_A(\mathcal{C})$  and  $\otimes = \otimes_{\mathcal{C}}$ , we have  $[x, y]_{\mathcal{C}} = (x \otimes_A y^R)^L$  [Ost03]. It includes the first case as a special case when  $A = \mathbb{1}_{\mathcal{C}}$ .  $\heartsuit$

**Remark 3.1.13.** The internal homs define an internal hom functor  $[-, -]_{\mathcal{C}} : \mathcal{M}^{\text{op}} \otimes \mathcal{M} \rightarrow \mathcal{C}$ , i.e.  $(x, y) \mapsto [x, y]_{\mathcal{C}}$ . As a consequence, the isomorphisms in (3.1.4) are natural in all three variables  $a, x, y$ . Moreover, the internal hom can be equivalently defined by stating that  $[x, -] : \mathcal{M} \rightarrow \mathcal{C}$  is the right adjoint of the functor  $- \otimes x : \mathcal{C} \rightarrow \mathcal{M}$ .  $\diamond$

What is remarkable about the internal hom is that, by the universal property of the internal hom  $[x, z]$ , there is a distinguished morphism

$$[y, z] \otimes_{\mathcal{C}} [x, y] \xrightarrow{\text{ev}} [x, z] \tag{3.1.6}$$

determined by the composed morphism:  $[y, z] \otimes ([x, y] \otimes x) \xrightarrow{\text{id}_{[y, z]} \otimes_{\mathcal{C}} \text{ev}} [y, z] \otimes y \xrightarrow{\text{ev}} z$  and the universal property. Moreover, we have a canonical morphism  $\eta : \mathbb{1}_{\mathcal{C}} \rightarrow [x, x]$  defined by  $\mathbb{1}_{\mathcal{C}} \otimes x \simeq x$ .

**Lemma 3.1.14.** The triple  $([x, x], \text{ev}, \eta)$  defines an  $E_1$ -algebra in  $\mathcal{C}$ ; the pair  $([x, y], \text{ev})$ , where  $\text{ev} : [x, y] \otimes_{\mathcal{C}} [x, x] \rightarrow [x, y]$ , defines a right  $[x, x]$ -module structure on  $[x, y]$ ; and  $[x, y]$  is naturally a  $[y, y]$ - $[x, x]$ -bimodule.

**Remark 3.1.15.** Internal homs play very important role in QFT's. For example, in 1+1D rational CFT's, all modular-invariant bulk CFT's, boundary CFT's and defect or wall CFT's are internal homs. More precisely, given a rational vertex operator algebra (VOA)  $V$ , i.e.  $\mathcal{C} = \text{Mod}_V$  is a modular tensor category (MTC) [MS89, Hua08]. A category of boundary conditions preserving the chiral symmetry  $V$  is defined by an indecomposable separable left  $\mathcal{C}$ -module  $\mathcal{M}$ , i.e. each object in  $\mathcal{M}$  represents a boundary condition preserving the chiral symmetry  $V$ .

1. The 0+1D boundary CFT associated to the boundary condition  $x \in \mathcal{M}$  is precisely the internal hom  $[x, x]_{\mathcal{C}}$ . The algebraic structure defined by the triple  $([x, x], \text{ev}, \eta)$  precisely encodes the mathematical structure of OPE among boundary fields [FRS02, HK04, KR09, DKR15].

2. The 0D domain wall between two boundary CFT's associated to the boundary conditions  $x$  and  $y$  is given by the internal hom  $[x, y]_{\mathcal{C}}$  [FFRS07, DKR15]. The morphism defined in (3.1.6) precisely encode the most general OPE between two fields living in two domain walls.
3. The modular-invariant bulk CFT is again the internal hom  $[\text{id}_{\mathcal{M}}, \text{id}_{\mathcal{M}}]_{\mathfrak{Z}_1(\mathcal{C})}$  but living in  $\mathfrak{Z}_1(\mathcal{C})$  (i.e. the Drinfeld center of  $\mathcal{C}$ ) [FRS02, KR09, Dav10a], where  $\text{id}_{\mathcal{M}} \in \text{Fun}_{\mathcal{C}}(\mathcal{M}, \mathcal{M})$  is the identity functor, and  $\text{Fun}_{\mathcal{C}}(\mathcal{M}, \mathcal{M})$  is the category of  $\mathcal{C}$ -module functors from  $\mathcal{M}$  to  $\mathcal{M}$  and, at the same time, a left  $\mathfrak{Z}_1(\mathcal{C})$ -module defined by  $(z \circ F)(-) := z \circ F(-)$  for  $z \in \mathfrak{Z}_1(\mathcal{C})$  and  $F \in \text{Fun}_{\mathcal{C}}(\mathcal{M}, \mathcal{M})$ . This internal hom  $[\text{id}_{\mathcal{M}}, \text{id}_{\mathcal{M}}]_{\mathfrak{Z}_1(\mathcal{C})}$  is automatically a Lagrangian algebra in  $\mathfrak{Z}_1(\mathcal{C})$  [KR09, DMNO13].

### 3.1.4 Particle condensations III: geometric theory

Now we provide the precise mathematical foundation and calculation behind the physical intuitions discussed in Section 3.1.2.

Again, the condensation from the 1+1D anomalous topological order  $\mathcal{C}^2$  to  $\mathcal{D}^2$  can be achieved by the following procedures.

- (1) First, proliferate the  $\mathcal{D}^2$ -phases inside the  $\mathcal{C}^2$ -phase with  $\mathcal{M} = (\mathcal{M}, m)$  and  $\overline{\mathcal{M}} = (\mathcal{M}^{\text{op}}, m)$  for some  $m \in \mathcal{M}$  as illustrated in the picture (3.1.1).
- (2) Secondly, shrink the black line  $\overline{\mathcal{M}} \boxtimes_{\mathcal{C}} \mathcal{M}$  to a particle in  $\mathcal{D}^2$ . By [KZ18a, Proposition 2.2.7], this particle can be explicitly computed as the image of  $m \boxtimes_{\mathcal{C}} m$  the following equivalences:

$$\begin{aligned} \mathcal{M}^{\text{op}} \boxtimes_{\mathcal{C}} \mathcal{M} &\simeq \text{Fun}_{\mathcal{C}}(\mathcal{M}, \mathcal{M}) \simeq \mathcal{D}^{\text{op}} \\ m \boxtimes_{\mathcal{C}} m &\mapsto [m, -]_{\mathcal{C}} \circ m \end{aligned} \quad (3.1.7)$$

where  $[m, -]_{\mathcal{C}} : \mathcal{M} \rightarrow \mathcal{C}$  is the functor defined by  $[m, -]_{\mathcal{C}}(m') := [m, m']_{\mathcal{C}} \in \mathcal{C}$  for  $m' \in \mathcal{M}$  and  $[m, m']_{\mathcal{C}}$  is the internal hom (recall Remark 3.1.13).

- (3) Thirdly, map this particle in  $\mathcal{D}$  to the trivial particle  $\mathbb{1}_{\mathcal{D}} \in \mathcal{D}$ . Since  $\mathcal{D}^{\text{op}} \simeq \text{Fun}_{\mathcal{C}}(\mathcal{M}, \mathcal{M})$  is defined by  $d \mapsto - \circ d$ ,  $\mathbb{1}_{\mathcal{D}}$  is mapped to  $- \circ \mathbb{1}_{\mathcal{D}} \simeq \text{id}_{\mathcal{M}} \in \text{Fun}_{\mathcal{C}}(\mathcal{M}, \mathcal{M})$ . Therefore, mapping it to  $\mathbb{1}_{\mathcal{D}}$  is just the canonical natural transformation between two  $\mathcal{C}$ -module functors:

$$\text{ev} : [m, -] \circ m \rightarrow \text{id}_{\mathcal{M}} \quad (3.1.8)$$

After these three procedures, the entire 1d line turn into a green line, thus defines the condensation.

Again shrinking a green line segment in (3.1.1), i.e.  $\mathcal{M} \boxtimes_{\mathcal{D}} \overline{\mathcal{M}}$ , defines a particle  $A \in \mathcal{C}$ , which can explicitly computed as in the following picture.

$$\begin{array}{c} m \in \mathcal{M} \quad m \in \mathcal{M}^{\text{op}} \\ \text{---} \text{---} \text{---} \text{---} \text{---} \\ \mathcal{C} \quad \mathcal{D} \end{array} = \begin{array}{c} A = [m, m] \in \mathcal{C} \\ \text{---} \text{---} \text{---} \\ \mathcal{C} \end{array} \quad (3.1.9)$$

Mathematically, it is given by the canonical equivalence  $\mathcal{M} \boxtimes_{\mathcal{D}} \mathcal{M}^{\text{op}} \simeq \mathcal{C}$  defined by  $x \boxtimes_{\mathcal{D}} y \mapsto [x, y]_{\mathcal{C}}^*$ .

Moreover, according to (3.1.7) and (3.1.8), the procedure (2) and (3) defines a morphism  $\mu_A : A \otimes A \rightarrow A$  as the following composed map:

$$[m, m] \otimes [m, m] \simeq [m, [m, m] \circ m] \xrightarrow{[m, \text{ev}_m]} [m, m], \quad (3.1.10)$$

where the first ' $\simeq$ ' is due to the canonical isomorphism  $a \otimes [x, y] \simeq [x, a \otimes y]$  [Ost03]. It turns out that the composed map (3.1.10) coincides with the canonical morphism  $[m, m] \otimes [m, m] \rightarrow [m, m]$  defined by the universal property of the internal hom.

We have a canonical morphism from  $\eta : \mathbb{1}_{\mathcal{C}} \rightarrow [m, m]$ , which can be defined physically in two steps.

1. In the first step, we simply factorizes  $\mathbb{1}_{\mathcal{C}}$  as follows:

$$\begin{array}{c} \mathbb{1}_{\mathcal{C}} \\ \text{---} \\ \mathcal{C} \end{array} = \int_{x \in \mathcal{M}}^{\mathcal{D}} \begin{array}{c} x \in \mathcal{M} \quad x \in \mathcal{M}^{\text{op}} \\ \text{---} \\ \mathcal{C} \quad \mathcal{D} \end{array}$$

That is, the canonical equivalence  $\mathcal{C} \simeq \mathcal{M} \boxtimes_{\mathcal{D}} \mathcal{M}^{\text{op}}$  maps  $\mathbb{1}_{\mathcal{C}}$  to an object  $\int_{x \in \mathcal{M}}^{\mathcal{D}} x \boxtimes_{\mathcal{D}} x$  in  $\mathcal{M} \boxtimes_{\mathcal{D}} \mathcal{M}^{\text{op}}$ , where the integral defines a limit (called ‘end’) in the category  $\mathcal{C}$ . In Appendix A.2, we explain this notion as a generalization of the classical Eilenberg-Watts calculus. That  $\mathbb{1}_{\mathcal{C}} \mapsto \int_{x \in \mathcal{M}}^{\mathcal{D}} x \boxtimes_{\mathcal{D}} x$  in  $\mathcal{M} \boxtimes_{\mathcal{D}} \mathcal{M}^{\text{op}}$  is explained in Example A.2.12. Physically, it means that one can always split a black line by inserting a green line segment, then all possible particles  $x \in \mathcal{M}$ ,  $x \in \mathcal{M}^{\text{op}}$  are accumulating at two ends in pairs. Such a pair of particles can be viewed as a pair of boundary conditions at the two ends of the green line segment. By integrating all these possible boundary conditions, we simply recover the trivial particle in  $\mathcal{C}$ . This step is completely invertible.

2. In the second step, we define  $\eta$  by ‘projecting out’ all the  $x$ -components for  $x \neq m$ . Mathematically, this ‘projection’ is precisely the defining morphism  $\int_{x \in \mathcal{M}}^{\mathcal{D}} x \boxtimes_{\mathcal{D}} x \rightarrow m \boxtimes_{\mathcal{D}} m$  of the limit. It turns out that such physically defined morphism  $\eta$  is precisely the one defined by the universal property of the internal hom  $[m, m]$ .

**Example 3.1.16.** It is helpful to look at a special case  $\mathcal{D} = \mathcal{C} = \mathcal{M}$ . In this case, we have (see also Example A.2.10)

$$\int_{x \in \mathcal{M}}^{\mathcal{D}} x \boxtimes_{\mathcal{D}} x = \int_{x \in \mathcal{C}}^{\mathcal{C}} x \otimes x^* \simeq \mathbb{1}_{\mathcal{C}}.$$

If we already know that  $\mathcal{D}^2$  and  $\mathcal{M}^1$  are obtained from  $\mathcal{C}^2$  by condensing a condensable  $E_1$ -algebra  $A \in \mathcal{C}$ . In this case, we have  $\mathcal{D} = \text{BMod}_{A|A}(\mathcal{C})$ ,  $\mathcal{M} = \text{RMod}_A(\mathcal{C})$ ,  $\mathcal{M}^{\text{op}} = \text{LMod}_A(\mathcal{C})$  and  $\mathcal{M} = (\mathcal{M}, A)$ .

1. The bulk-to-wall map  $\mathcal{C} \rightarrow \mathcal{M}$  is  $a \mapsto a \otimes A, \forall a \in \mathcal{C}$ . Its right adjoint functor is  $[A, -] : \mathcal{M} \rightarrow \mathcal{C}$  is precisely the forgetful functor  $f : \text{RMod}_A(\mathcal{C}) \rightarrow \mathcal{C}$  defined by  $x \mapsto x$  by forgetting the  $A$ -module structure on  $x$ . Therefore,  $[A, A]_{\mathcal{C}} = A$ .
2. The  $d$ -particle in  $\mathcal{D}^2$ , as depicted in (3.1.3), becomes the particle  $[A, d \otimes_A A] = d$  in  $\mathcal{C}$ . This assignment  $\mathcal{D} \ni d \mapsto d \in \mathcal{C}$  is precisely the forgetful functor  $f : \text{RMod}_A(\mathcal{C}) \rightarrow \mathcal{C}$ .

Very importantly, what we have shown is that the data on the wall  $\mathcal{M}^1 = (\mathcal{M}, m)$ , which should be viewed as a boundary condition, uniquely determines a condensation. This is compatible with the usual physical intuition that a condensation can be constructed by proliferating the green line segments with a chosen boundary condition on the wall  $\mathcal{M}^1$ . Moreover, in (3.1.9), the choice of the object  $m \in \mathcal{M}$  is arbitrary. A different choice  $m'$  simply produces a different condensable  $E_1$ -algebra  $A' = [m', m']^{\text{op}}$ , which defines a ‘new’ condensation. However, this ‘new’ condensation does not produce a new condensed phase. This is because  $A$  and  $A'$  are Morita equivalent, i.e.  $\text{RMod}_A(\mathcal{C}) \simeq \mathcal{M} \simeq \text{RMod}_{A'}(\mathcal{C})$ . As a consequence, we have, in  $\text{Alg}_{E_1}^{\mathcal{C}}(2\text{Vec})$ ,

$$\text{BMod}_{A|A}(\mathcal{C}) \simeq \text{Fun}_{\mathcal{C}}(\text{RMod}_A(\mathcal{C}), \text{RMod}_A(\mathcal{C}))^{\text{op}} \simeq \text{Fun}_{\mathcal{C}}(\text{RMod}_{A'}(\mathcal{C}), \text{RMod}_{A'}(\mathcal{C}))^{\text{op}} \simeq \text{BMod}_{A'|A'}(\mathcal{C}).$$

In other words,  $\mathcal{D}$  is irrelevant to the choice of  $m \in \mathcal{M}$ . It only depends on  $\mathcal{M}$  as  $\mathcal{D} \simeq \text{Fun}_{\mathcal{C}}(\mathcal{M}, \mathcal{M})^{\text{op}}$  in  $\text{Alg}_{E_1}^{\mathcal{C}}(2\text{Vec})$ . Note that an equivalence  $\mathcal{M} \simeq \text{RMod}_A(\mathcal{C})$  provides a way of labeling objects in  $\mathcal{M}$ , and should be viewed as a coordinate system on  $\mathcal{M}$ . An equivalence  $\mathcal{M} \simeq \text{RMod}_{A'}(\mathcal{C})$  provides a different coordinate system on  $\mathcal{M}$  (i.e. a relabeling of objects in  $\mathcal{M}$ ). Similarly,  $\text{BMod}_{A|A}(\mathcal{C})$  and  $\text{BMod}_{A'|A'}(\mathcal{C})$  provide two different coordinate systems on  $\mathcal{D}$ .

The reserved process, a particle condensation in the  $\mathcal{D}^2$ -phase that reproduces the  $\mathcal{C}^2$ -phase as the condensed phase, can also be made mathematically precise.

**Theorem<sup>ph</sup> 3.1.17.** By shrinking the black line segment in the  $D^2$ -phase, we obtain a particle in the  $D^2$ -phase, which is precisely the internal hom algebra  $[m, m]_{\mathcal{D}} \in \mathcal{D}$  as illustrated in the following picture.

$$\begin{array}{c} m \in \mathcal{M}^{\text{op}} \quad m \in \mathcal{M} \\ \text{---} \text{---} \text{---} \text{---} \text{---} \text{---} \\ \mathcal{D} \quad \mathcal{C} \quad \mathcal{D} \end{array} = \begin{array}{c} B = [m, m]_{\mathcal{D}} \in \mathcal{D} \\ \text{---} \text{---} \text{---} \text{---} \\ \mathcal{D} \quad \mathcal{D} \end{array}$$

By condensing  $B \in \mathcal{D}$ , we obtain  $\mathcal{C} \simeq \text{BMod}_{B|B}(\mathcal{D})$  and  $\mathcal{M} \simeq \text{LMod}_B(\mathcal{D})$ . Particles in  $\mathcal{D}$  move to the wall  $\mathcal{M}$  according to the functor  $B \otimes - : \mathcal{D} \rightarrow \mathcal{M}$ , and particles in  $\mathcal{C}$  move to the wall  $\mathcal{M}$  according to the functor  $- \otimes_B B : \mathcal{C} \rightarrow \mathcal{M}$ .

**Lemma 3.1.18.** If we have already known that  $\mathcal{D} = \text{BMod}_{A|A}(\mathcal{C})$  and  $\mathcal{M} = (\mathcal{M} = \text{RMod}_A(\mathcal{C}), m)$ , then

- (1)  $B = [m, m]_{\mathcal{D}} = m^R \otimes m \in \mathcal{D}$ ;
- (2)  $\mathcal{C} \simeq \text{BMod}_{B|B}(\mathcal{D})$  and  $\mathcal{M} \simeq \text{LMod}_B(\mathcal{D})$ .

*Proof.* (1). It follows from  $\text{hom}_{\mathcal{M}}(x \odot d, y) = \text{hom}_{\mathcal{M}}(x \otimes_A d, y) \simeq \text{hom}_{\mathcal{D}}(d, x^R \otimes y)$ .

(2). Proved in [EGNO15]. The key idea is to check that the functor  $m^R \otimes - \otimes m : \mathcal{C} \rightarrow \text{BMod}_{B|B}(\mathcal{D})$  defines a monoidal equivalence.  $\square$

In summary, all data appeared in Section 3.1.2 become explicit and mathematically precise. It is quite amazing that these precise data automatically make all the physical intuitions works as mathematical facts. What is even more amazing is that this beautiful coincidence of physical intuitions and precise mathematical results holds in all dimensions.

## 3.2 Condensations of 1-codimensional defects in $n+1D$

The mathematical theory of 1-codimensional defects in higher dimensions was studied in [GJF19, LYW23].

### 3.2.1 General theory

The physical intuition of particle condensations in 1+1D potentially anomalous topological orders automatically carries over to the condensations of 1-codimensional topological defects in potentially anomalous  $n+1D$  topological orders.

Let  $C^{n+1}$  be a potentially anomalous  $n+1D$  simple topological order. The category  $\mathcal{C}$  of topological defects in  $C^{n+1}$  is a fusion  $n$ -category (recall Theorem<sup>ph</sup> 2.2.11). More explicitly, a condensation of a (composite) 1-codimensional topological defect in a potentially anomalous  $n+1D$  topological order  $C^{n+1}$  that produces a new phase  $D^{n+1}$  (see Remark 3.2.1), can be achieved by

- (1) first proliferating the  $D^{n+1}$ -phases inside the  $C^{n+1}$ -phase as illustrated Figure 9, where the domain wall  $M^n$  is assumed to be gapped;
- (2) then shrinking each blue region  $\overline{M} \boxtimes_{\mathcal{C}} M$  to a 1-codimensional topological defect in  $D^{n+1}$ ;
- (3) then annihilating this defect, i.e. mapping it to the trivial 1-codimensional topological defect  $\mathbb{1}_{\mathcal{D}}$  in  $D^{n+1}$ .

As a consequence, the entire phase  $C^{n+1}$  turn into a new phase  $D^{n+1}$ , which we assume to be indecomposable.

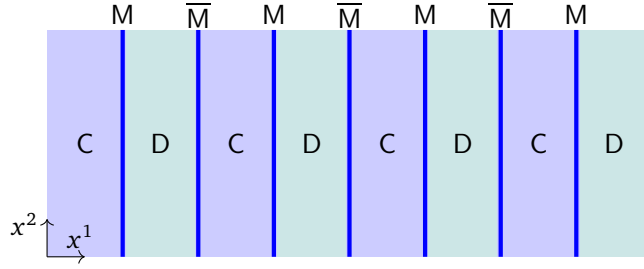

Figure 9: Condensation of 1-codimensional topological defects in  $C^{n+1}$

**Remark 3.2.1.** Such a condensation produces a new phase  $D^{n+1}$  that share the same gravitational anomaly with  $C^{n+1}$  as illustrated below.

$$Z(C)^{n+2} = Z(D)^{n+2}$$

Therefore, one can also view this condensation as a purely boundary phase transition of  $Z(C)^{n+2}$ . We assume that the domain wall  $M^n$  is gapped just for convenience. One can see that if the domain wall  $M^n$  is gapless, the argument is completely parallel. This defines a condensation of non-topological defects in  $C^{n+1}$ , which is beyond the setting of this section. We postpone it to the last section.  $\diamond$

One can see that condensing a 1-codimensional topological defect in an  $n+1$ D topological order is completely parallel to that in a  $1+1$ D topological order. We simply summarize the result below.

**Theorem<sup>ph</sup> 3.2.2.** A condensation of a 1-codimensional topological defect in an  $n+1$ D topological order  $C^{n+1}$  can be mathematically described as follows:

1. Since the condensed phase  $D^{n+1}$  is condensed from  $C$ , the multi-fusion  $n$ -category  $\mathcal{D}$  is necessarily a sub-2-category of  $\mathcal{C}$ . The trivial 1-codimensional topological defect  $\mathbb{1}_{\mathcal{D}}$  in  $\mathcal{D}$  corresponds to a non-trivial 1-codimensional topological defect  $A \in \mathcal{C}$ , which is precisely the defect obtained by shrinking a green strap in Figure 9 to a 1-codimensional topological defect in  $C^{n+1}$ .
2. The  $A$ -defect is naturally equipped with the structure of an algebra in  $\mathcal{C}$  with the unit 1-morphism  $\eta_A$  and the multiplication 1-morphism  $\mu_A$  defined by the following pictures in spatial dimensions<sup>12</sup>.

$$(3.2.1)$$

<sup>12</sup>Note that pictures (3.2.1) and (3.1.2) in order to warn readers that the physical meanings of these two sets of pictures have very different physical meanings.

Since the physical meaning of a 1-morphism in  $\mathcal{C}$  is a 2-codimensional topological defect, both  $\eta_A$  and  $\mu_A$  are defined by the 2-codimensional topological defects encircled by the dashed boxes in above picture. It is clear that we should have the associativity and the unital “properties” of  $\mu_A$  and  $\eta_A$ . However, for  $n > 1$ , these “properties” are more than properties because higher morphisms (i.e., higher codimensional defects) are needed as defining data. For example, we should have the following 2-isomorphisms

$$\mu_A \circ (\mu_A \otimes \text{id}_A) \xrightarrow{\cong} \mu_A \circ (\text{id}_A \otimes \mu_A), \quad \mu_A \circ (\eta_A \otimes \text{id}_A) \xrightarrow{\cong} \text{id}_A = \mu_A \circ (\text{id}_A \otimes \eta_A).$$

If  $n = 2$ , these 2-isomorphisms should satisfy a pentagon condition and a triangle condition (see [Dé23] for a precise mathematical definitions and see also [ZLZH<sup>+</sup>23]); if  $n > 2$ , there should be a 3-isomorphism associated to each pentagon and one associated to each triangle, so on and so forth. Our description here is mainly descriptive instead of being precise. A formal theory to take care all the higher coherence data can be found in [Lur17]. The higher coherence data can also be more efficiently encoded by internal homs as we show in Theorem 3.2.9. Moreover, we require such algebra to be condensable.

3. Similar to the particle condensations in 1+1D topological orders, 1-codimensional topological defects in  $\mathcal{D}^{n+1}$  are precisely  $A$ - $A$ -modules or  $E_1$ - $A$ -modules in  $\mathcal{C}$  (see [Dé23, ZLZH<sup>+</sup>23] for mathematical definitions for  $n = 2$ ), i.e.  $\mathcal{D} = \text{Mod}_A^{E_1}(\mathcal{C})$  (recall Remark 3.1.1), which is an indecomposable multi-fusion  $n$ -category. If  $A$  is simple, then  $\mathcal{D} = \text{Mod}_A^{E_1}(\mathcal{C})$  is a fusion  $n$ -category.

4.  $\mathcal{M}^n$  can be described by a pair  $(\mathcal{M}, m)$ , where  $\mathcal{M}$  is a separable  $n$ -category given by  $\text{RMod}_A(\mathcal{C})$  and  $m = A$  is an object in  $\mathcal{M} = \text{RMod}_A(\mathcal{C})$  representing a 1-codimensional defect on the wall. The pair  $(\mathcal{M}, m)$  can be viewed as an  $E_0$ -algebra in  $(n+1)\text{Vec}$ .

5. Topological defects in  $\mathcal{C}^{n+1}$  move onto the  $\mathcal{M}^n$ -wall according to the left bulk-to-wall map (or functor)

$$L := - \otimes A : \mathcal{C} \rightarrow \mathcal{M} = \text{RMod}_A(\mathcal{C}) \quad \text{defined by } a \mapsto a \otimes A. \quad (3.2.2)$$

Topological defects in  $\mathcal{D}^{n+1}$  move onto the  $\mathcal{M}^n$ -wall according to the right bulk-to-wall map (or functor)

$$R := A \otimes_A - : \mathcal{D} \rightarrow \mathcal{M} = \text{RMod}_A(\mathcal{C}) \quad \text{defined by } d \mapsto A \otimes_A d. \quad (3.2.3)$$

6. Note that the right adjoint  $L^R$  of the functor  $L = - \otimes A : \mathcal{C} \rightarrow \mathcal{M} = \text{RMod}_A(\mathcal{C})$  is the internal hom functor  $[A, -]$  (see Definition 3.2.6), which, in this case, is precisely the forgetful functor  $f : \text{RMod}_A(\mathcal{C}) \rightarrow \mathcal{C}$  by forgetting the right  $A$ -module structure, i.e.

$$L^R = [A, -] = f.$$

In particular, the condensable  $E_1$ -algebra can be recovered as  $L^R(A) = [A, A] = A$ .

7. This condensation preserves the gravitational anomaly (recall Remark 3.2.1), i.e.,  $Z(\mathcal{C})^{n+2} = Z(\mathcal{D})^{n+2}$ . In other words,  $\mathcal{C}^{n+1}$  and  $\mathcal{D}^{n+1}$  are topologically Morita equivalent. Mathematically, it means that we have the following braided equivalence:

$$\mathfrak{Z}_1(\mathcal{C}) \simeq \mathfrak{Z}_1(\text{Mod}_A^{E_1}(\mathcal{C})).$$

**Remark 3.2.3.** When  $\mathcal{C}^{n+1} = \mathbf{1}^{n+1}$ , Theorem<sup>ph</sup> 3.2.2 (see also Theorem<sup>ph</sup> 3.2.9) is precisely a reformulation of the layer constructions of the  $n+1$ D topological order  $\mathcal{D}^{n+1}$  from the trivial  $n+1$ D topological order  $\mathbf{1}^{n+1}$ . In this sense, general condensations can be viewed as layer constructions on a non-trivial background phase  $\mathcal{C}^{n+1}$ . Notice that such (generalized) layer constructions can only create a new phase  $\mathcal{D}^{n+1}$  that connects to  $\mathcal{C}^{n+1}$  by a gapped domain wall. When  $\mathcal{C}^{n+1} = \mathbf{1}^{n+1}$ , all non-chiral  $n+1$ D topological orders can be obtained from the condensations of 1-codimensional topological defects in  $\mathbf{1}^{n+1}$ .  $\diamond$



Then the boundary-bulk relation [KWZ15, KWZ17] immediately gives the following mathematical corollary.

**Corollary 3.2.4.** Let  $\mathcal{C}$  be an indecomposable multi-fusion  $n$ -category,  $A \in \text{Alg}_{E_1}^c(\mathcal{C})$ ,  $\mathcal{D} = \text{Mod}_A^{E_1}(\mathcal{C})$  and  $\mathcal{M} = \text{RMod}_A(\mathcal{C})$ . We have a natural monoidal equivalence (with an illustration of its physical meaning):

$$\begin{array}{c}
 \mathfrak{Z}_1(\mathcal{C}) \simeq \mathfrak{Z}_1(\mathcal{D}) \\
 \hline
 \mathcal{C} \xrightarrow{\quad} \mathcal{M} \xrightarrow{\quad} \mathcal{D}
 \end{array}
 \quad
 \phi : \text{Mod}_A^{E_1}(\mathcal{C})^{\text{op}} \boxtimes_{\mathfrak{Z}_1(\mathcal{C})} \mathcal{C} \xrightarrow{\simeq} \mathfrak{Z}_0(\text{RMod}_A(\mathcal{C})). \quad (3.2.4)$$

or equivalently, we have

$$\text{Mod}_A^{E_1}(\mathcal{C})^{\text{op}} \simeq \mathfrak{Z}_1(\mathcal{C}, \mathfrak{Z}_0(\text{RMod}_A(\mathcal{C}))). \quad (3.2.5)$$

**Remark 3.2.5.** Corollary<sup>ph</sup> 3.2.4 generalizes [DMNO13, Corollary 3.30]. When  $n = 2$  and  $\mathfrak{Z}_1(\mathcal{C}) \simeq 2\text{Vec}$ , taking looping on both sides and applying the formula (2.3.13) and Theorem 5.1.3, we obtain [DMNO13, Corollary 3.30].  $\diamond$

**Definition 3.2.6.** Let  $\mathcal{A}$  be a  $\mathbb{C}$ -linear monoidal  $n$ -category and  $\mathcal{M}$  be a  $\mathbb{C}$ -linear left  $\mathcal{A}$ -module. The internal hom  $[x, y]$  for  $x, y \in \mathcal{M}$ , if exists, is defined to be the object of  $\mathcal{A}$  representing the functor  $\text{hom}_{\mathcal{M}}(- \odot x, y) : \mathcal{A}^{\text{op}} \rightarrow \text{Cat}_{n-1}^{\mathbb{C}}$ . That is,

$$\text{hom}_{\mathcal{A}}(-, [x, y]) \simeq \text{hom}_{\mathcal{M}}(- \odot x, y). \quad (3.2.6)$$

We say that  $\mathcal{M}$  is *enriched* in  $\mathcal{A}$  if  $[x, y]$  exists for all  $x, y \in \mathcal{M}$ .  $\blacksquare$

**Remark 3.2.7.** We want to point out that the equivalence (or better adjoint equivalence for physical applications) in (3.2.6) is a defining data of the internal hom. The higher isomorphisms in the definition of the equivalence determine the higher isomorphisms in the definition of the algebraic structure on the internal hom.  $\diamond$

**Proposition 3.2.8 ([KZ21a]).** For a multi-fusion  $n$ -category  $\mathcal{A}$ , every separable left  $\mathcal{A}$ -module (i.e. a left  $\mathcal{A}$ -module in  $(n+1)\text{Vec}$ ) is enriched in  $\mathcal{A}$ .

The next result provide explicit constructions of condensable  $E_1$ -algebras in  $\mathcal{C}$  via internal homs.

**Theorem<sup>ph</sup> 3.2.9.** Given two  $n+1$ D topologically Morita equivalent (potentially composite) simple topological orders  $\mathcal{C}^{n+1}$  and  $\mathcal{D}^{n+1}$  connected by a gapped domain wall  $\mathcal{M}^n$  with a specified boundary condition  $m \in \mathcal{M}$ , i.e.  $\mathcal{M}^n = (\mathcal{M}, m)$ .

$$\begin{array}{c}
 \mathcal{Z}(\mathcal{C})^{n+2} \simeq \mathcal{Z}(\mathcal{D})^{n+2} \\
 \hline
 \mathcal{C}^{n+1} \xrightarrow{\quad} \mathcal{M}^n \xrightarrow{\quad} \mathcal{D}^{n+1}
 \end{array}$$

We have the following results.

- (1)  $\mathcal{M} \in \text{BMod}_{\mathcal{C}|\mathcal{D}}((n+1)\text{Vec})$  and the defining bimodule structure on  $\mathcal{M}$  induces a monoidal equivalence:

$$\mathcal{D}^{\text{op}} \boxtimes_{\mathfrak{Z}_1(\mathcal{C})} \mathcal{C} \xrightarrow{\simeq} \mathfrak{Z}_0(\mathcal{M}) = \text{Fun}(\mathcal{M}, \mathcal{M}); \quad (3.2.7)$$

or equivalently,

$$\mathcal{D}^{\text{op}} \simeq \text{Fun}_{\mathcal{C}}(\mathcal{M}, \mathcal{M}) \simeq \mathfrak{Z}_1(\mathcal{C}, \mathfrak{Z}_0(\mathcal{M})). \quad (3.2.8)$$

- (2) By shrinking a  $D^{n+1}$ -phase strap in the  $C^{n+1}$ -phase, we obtain a 1-codimensional topological defect in  $C^{n+1}$ , which means, in particular,  $\mathcal{M} \boxtimes_{\mathcal{D}} \mathcal{M}^{\text{op}} \simeq \mathcal{C}$  as  $\mathcal{C}$ - $\mathcal{C}$ -bimodules. This 1-codimensional topological defect in  $C^{n+1}$  is given by the internal hom algebra  $[m, m]_{\mathcal{C}}$  in  $\mathcal{C}$ , which is automatically a condensable  $E_1$ -algebra in  $\mathcal{C}$ .

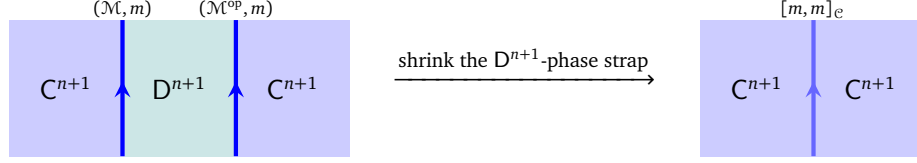

We have  $\mathcal{M} \simeq \text{RMod}_{[m, m]_{\mathcal{C}}}(\mathcal{C})$  and  $\mathcal{D} \simeq \text{Mod}_{[m, m]_{\mathcal{C}}}^{E_1}(\mathcal{C})$ . Moreover, all condensable  $E_1$ -algebras in  $\mathcal{C}$  arise as  $[m, m]_{\mathcal{C}}$  for some  $\mathcal{D}, \mathcal{M}, m$ .

- (3) We can reverse the process. By shrinking a  $C^{n+1}$ -phase strap in the  $D^{n+1}$ -phase, we obtain a 1-codimensional topological defect in  $D^{n+1}$ , which means, in particular,  $\mathcal{M}^{\text{op}} \boxtimes_{\mathcal{C}} \mathcal{M} \simeq \mathcal{D}$  as  $\mathcal{D}$ - $\mathcal{D}$ -bimodules. This 1-codimensional topological defect in  $\mathcal{D}$  is given by the internal hom algebra  $[m, m]_{\mathcal{D}}$  in  $\mathcal{D}$ , which is automatically a condensable  $E_1$ -algebra in  $\mathcal{D}$ .

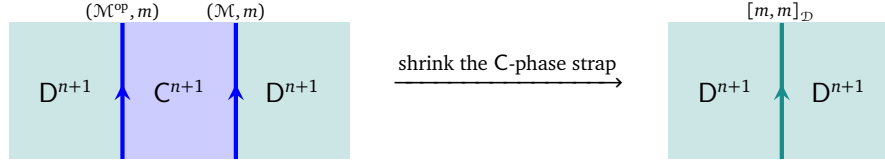

We have  $\mathcal{M} \simeq \text{LMod}_{[m, m]_{\mathcal{D}}}(\mathcal{D})$  and  $\mathcal{C} \simeq \text{Mod}_{[m, m]_{\mathcal{D}}}^{E_1}(\mathcal{D})$ . Moreover, all condensable  $E_1$ -algebras in  $\mathcal{D}$  arise as  $[m, m]_{\mathcal{D}}$  for some  $\mathcal{C}, \mathcal{M}, m$ .

In particular, two  $n+1$ D topological orders topologically Morita equivalent if and only if they can be obtained from each other by condensing a topological defect of codimension 1 (recall Theorem<sup>ph</sup> 2.2.1).

**Remark 3.2.10.** It is also illuminating to rewrite the results in terms of  $\Omega\mathcal{C}$  and  $\Omega\mathcal{D}$  because they determine  $\mathcal{C}$  and  $\mathcal{D}$ , respectively, by delooping. Note that  $\Omega\mathcal{C}$  and  $\Omega\mathcal{D}$  are non-degenerate braided fusion  $(n-1)$ -categories. All topological defects of codimension 1 and higher on a gapped domain wall form a closed multi-fusion  $\Omega\mathcal{D}$ - $\Omega\mathcal{C}$ -bimodule  $\mathcal{X}$ , i.e. a multi-fusion  $(n-1)$ -category equipped with a braided equivalence  $\phi_{\mathcal{X}} : \Omega\mathcal{D}^{\text{op}} \boxtimes \Omega\mathcal{C} \rightarrow \mathfrak{Z}_1(\mathcal{X})$ . We obtain the unique closed  $\mathcal{C}$ - $\mathcal{D}$ -bimodule  $\mathcal{M}$  as  $\Sigma\mathcal{X}$ , i.e.  $\mathcal{M} \simeq \Sigma\mathcal{X}$ . Moreover, the condition that  $\mathcal{X}$  is closed multi-fusion  $\Omega\mathcal{C}$ - $\Omega\mathcal{D}$ -bimodule is equivalent to the condition that  $\Sigma\mathcal{X}$  is the unique closed  $\mathcal{C}$ - $\mathcal{D}$ -bimodule  $\mathcal{M}$  mainly because  $\Sigma\mathfrak{Z}_1(\mathcal{X}) \simeq \mathfrak{Z}_0(\Sigma\mathcal{X})$  [JF22, KLWZZ20b, KZ22b]. Note that  $\Sigma\mathcal{X}$  is precisely the separable  $n$ -category of all possible gapped wall conditions between  $C^{n+1}$  and  $D^{n+1}$ . An object  $m \in \mathcal{M}$  represents a single gapped domain wall and  $\text{hom}_{\mathcal{M}}(m, m)$  is the multi-fusion  $(n-1)$ -category of topological defects of codimension 1 and higher on the  $m$ -wall.  $\diamond$

**Remark 3.2.11.** Similar to the 1+1D cases, once we fixed the domain wall  $M$  by a pair  $(\mathcal{M}, m)$  (so is its time reversal  $\bar{M} = (\mathcal{M}^{\text{op}}, m)$ ), then the condensation process is uniquely fixed with the condensable algebra defined by the internal hom algebra<sup>13</sup>  $[m, m]_{\mathcal{C}} \in \mathcal{C}$ . Different choices of  $m$  define different condensations microscopically. But the macroscopic result of the condensation, i.e. the condensed phase, is the same. Different  $m$ 's give different equivalences  $\mathcal{D} \simeq \text{Mod}_{[m, m]_{\mathcal{C}}}^{E_1}(\mathcal{C})$  and  $\mathcal{M} \simeq \text{RMod}_{[m, m]_{\mathcal{C}}}(\mathcal{C})$ , which provide different relabelings of the objects in  $\mathcal{D}$  and  $\mathcal{M}$ .  $\diamond$

<sup>13</sup>In 2-categories, the internal hom algebra is automatically equipped with not only the unit and associativity 1-morphisms but also necessary 2-morphisms, which are automatically included as the defining data of the universal property of the internal hom in 2-categories.

**Remark 3.2.12.** A 1-codimensional topological defect  $d \in \mathcal{D}$  in the condensed phase  $\mathcal{D}^{n+1}$  1-codimensional topological defect in  $\mathcal{C}$  as illustrated below.

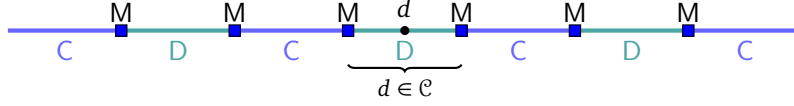

When  $d = \mathbb{1}_{\mathcal{D}}$ , this 1-codimensional topological defect is  $\mathbb{1}_{\mathcal{D}} = A \in \mathcal{C}$ . Note that  $A$  is precisely  $\mathbb{1}_{\mathcal{D}}$  viewed as an object in  $\mathcal{C}$  because  $\mathcal{D} \subset \mathcal{C}$ . Therefore, for general  $d \in \mathcal{D}$ , we expect that this 1-codimensional topological defect is given by  $[A, d]_{\mathcal{C}}$ . When  $\mathcal{D} = \text{Mod}_A^{\mathbb{E}_1}(\mathcal{C})$  and  $\mathcal{M} = \text{RMod}_A(\mathcal{C})$ ,  $[A, -] : \text{RMod}_A(\mathcal{C}) \rightarrow \mathcal{C}$  is precisely the forgetful functor.  $\diamond$

From a single  $C^{n+1}$ , one can obtain all  $\mathcal{D}^{n+1}$  that admit a gapped domain wall with (i.e., topologically Morita equivalent to)  $C^{n+1}$ . In particular, all anomaly-free non-chiral  $n+1$ D topological orders can be obtained by condensing 1-codimensional topological defects in  $\mathbf{1}^{n+1}$ , or equivalently, by condensing condensable  $E_1$ -algebras in  $n\text{Vec}$ . We generalize it to more general situations.

**Theorem<sup>ph</sup> 3.2.13.** Any gapped boundary of an  $n+1$ D topological order  $C^{n+1}$  can be obtained from a single gapped boundary  $M^n$  by first stacking an anomaly-free  $n$ D topological order  $X^n$  to  $M^n$  then condensing a 1-codimensional topological defect in  $M^n \boxtimes X^n$ .

*Proof.* Let  $M^n$  and  $N^n$  be two gapped boundaries of  $C^{n+1}$ . We set  $X^n := \overline{M^n} \boxtimes_{C^{n+1}} N^n$ . Since  $M^n \boxtimes \overline{M^n}$  is connected to  $C^n$  (i.e. the trivial 1-codimensional topological defect in  $C^{n+1}$ ) by the gapped domain wall  $M^{n-1}$  (recall Example 2.1.5:  $M^{n-1}$  is the trivial 1-codimensional topological defect in  $M^n$ ), then  $M^{n-1} \boxtimes_{C^n} N^{n-1}$  defines a gapped domain wall between

$$M^n \boxtimes X^n = M^n \boxtimes (\overline{M^n} \boxtimes_{C^{n+1}} N^n) = (M^n \boxtimes \overline{M^n}) \boxtimes_{C^{n+1}} N^n$$

and  $C^n \boxtimes_{C^{n+1}} N^n = N^n$ .  $\square$

**Remark 3.2.14.** Theorem<sup>ph</sup> 3.2.13 automatically covers the same result for the gapped domain walls between two topological orders because a wall is a boundary by the folding trick.  $\diamond$

**Remark 3.2.15.** Recall Theorem<sup>ph</sup> 2.1.19, the set  $\text{TM}^n$  of topologically Morita equivalence classes of  $n$ D anomaly-free topological orders form an abelian group. Theorem<sup>ph</sup> 3.2.13 simply says that the  $\text{TM}^n$ -action on  $\text{TM}^n(C^{n+1})$  is transitive.  $\diamond$

### 3.2.2 General examples

In this subsection, we provide some general examples, in which  $\mathcal{C}$  and  $\mathcal{M}$  are equipped with concrete coordinate systems such that the condensable  $E_1$ -algebra  $[m, m]_{\mathcal{C}}$  in  $\mathcal{C}$  can be determined explicitly.

(1).  $C^{n+1} = \mathcal{D}^{n+1} = \mathbf{1}^{n+1}$ : It turns out that this seemingly “trivial” case can have non-trivial condensations. In this case, a gapped domain wall  $M^n$  between  $C^{n+1}$  and  $\mathcal{D}^{n+1}$  is nothing but an anomaly-free  $n$ D topological order. Again,  $M^n = (\mathcal{M}, m)$ , where  $\mathcal{M}$  is a separable  $n$ -category,  $m$  is a distinguished object in  $\mathcal{M}$  and labels the  $n$ D anomaly-free topological order  $M^n$  as a boundary condition of  $\mathbf{1}^{n+1}$ . By boundary-bulk relation, we must have

$$\mathfrak{Z}_0(\mathcal{M}, m) = \text{Fun}(\mathcal{M}, \mathcal{M}) \simeq n\text{Vec}. \quad (3.2.9)$$

As a consequence,  $\mathcal{M}$  is necessarily indecomposable (actually invertible in  $(n+1)\text{Vec}$  by [KZ21a, Corollary 2.10]). The category of topological defects on  $M^n$  is  $\Omega_m \mathcal{M}$ , which is an indecomposable multi-fusion

$(n-1)$ -category. Since  $\mathcal{M}$  is indecomposable, we have  $\mathcal{M} = \Sigma\Omega_m\mathcal{M}$ . By boundary-bulk relation, we have  $\mathfrak{Z}_1(\Omega_m\mathcal{M}) \simeq (n-1)\text{Vec}$ , which is also an immediate consequence of (3.2.9) and  $\mathcal{M} = \Sigma\Omega_m\mathcal{M}$ .

Note that the equivalence  $\mathcal{M} = \Sigma\Omega_m\mathcal{M} \simeq \text{RMod}_{\Omega_m\mathcal{M}}(n\text{Vec})$  provides a coordinate system that allows us to identify the condensable  $E_1$ -algebra  $[m, m]_{\mathcal{C}}$  in  $\mathcal{C}$  explicitly. Indeed, in this coordinate system  $m = \Omega_m\mathcal{M} \in \text{RMod}_{\Omega_m\mathcal{M}}(n\text{Vec})$ , and the left bulk-to-wall functor can be rewritten as follows.

$$L_1 = - \circledast m = - \otimes \Omega_m\mathcal{M} : n\text{Vec} \rightarrow \text{RMod}_{\Omega_m\mathcal{M}}(n\text{Vec}),$$

which is illustrated in the following picture.

$$\begin{array}{ccc} \mathbf{1}^{n+1} & & \mathbf{1}^{n+1} \\ & \nearrow & \\ n\text{Vec} & \xrightarrow{L_1 = - \circledast m} & \mathcal{M} \\ & \searrow & \\ a \mapsto a \otimes \Omega_m\mathcal{M} & & \end{array} \quad \begin{array}{c} \mathcal{M} = \Sigma\Omega_m\mathcal{M} = \text{RMod}_{\Omega_m\mathcal{M}}(n\text{Vec}) \\ m = \Omega_m\mathcal{M} \in \text{RMod}_{\Omega_m\mathcal{M}}(n\text{Vec}) \end{array}$$

Then its right adjoint functor is precisely the forgetful functor, i.e.,

$$L_1^R = f : \text{RMod}_{\Omega_m\mathcal{M}}(n\text{Vec}) \rightarrow n\text{Vec}.$$

Therefore,  $L_1^R(\Omega_m\mathcal{M}) = [\Omega_m\mathcal{M}, \Omega_m\mathcal{M}]_{n\text{Vec}} = \Omega_m\mathcal{M}$  is precisely the condensable  $E_1$ -algebra in  $n\text{Vec}$  that defines the condensation. Note that, in the case, the internal hom  $[m, m]_{\mathcal{C}}$  is not no longer an abstract nonsense. It is the indecomposable multi-fusion  $(n-1)$ -category  $\Omega_m\mathcal{M}$ , which is precisely a condensable  $E_1$ -algebra in  $\mathcal{C} = n\text{Vec}$ . By Theorem<sup>ph</sup> 3.2.9, we obtain

$$\mathcal{D} = n\text{Vec} \simeq \text{Mod}_{\Omega_m\mathcal{M}}^{E_1}(n\text{Vec}), \quad \mathcal{M} \simeq \text{RMod}_{\Omega_m\mathcal{M}}(n\text{Vec}),$$

where the second equivalence is tautological and can be viewed as a consistence check, but the first monoidal equivalence is non-trivial mathematically. We reformulate this result mathematically.

**Proposition 3.2.16.** A non-degenerate multi-fusion  $n$ -category  $\mathcal{A}$  is automatically a Lagrangian  $E_1$ -algebra in  $(n+1)\text{Vec}$  (recall Definition 2.3.23), i.e.,

$$\text{Mod}_{\mathcal{A}}^{E_1}((n+1)\text{Vec}) \simeq (n+1)\text{Vec}. \quad (3.2.10)$$

**Remark 3.2.17.** The subscript of  $L_1$  represents that it is left bulk-to-wall map of 1-codimensional topological defects. We denote the left bulk-to-wall map of  $k$ -codimensional topological defects by  $L_k : \Omega^{k-1}\mathcal{C} \rightarrow \Omega^{k-1}\mathcal{M}$  and the right bulk-to-wall map of  $k$ -codimensional topological defect by  $R_k : \Omega^{k-1}\mathcal{D} \rightarrow \Omega^{k-1}\mathcal{M}$ .  $\diamond$

**Remark 3.2.18.** Proposition 3.2.16 is the mathematical formulation of the physical fact that condensing an anomaly-free  $nD$  topological order  $M^n$ , viewed as 1-codimensional topological defects in the trivial phase  $\mathbf{1}^{n+1}$ , reproduces the trivial phase  $\mathbf{1}^{n+1}$ , and gapped domain wall of this condensation is precisely the anomaly-free  $nD$  topological order.  $\diamond$

(2).  $C^{n+1} = \mathbf{1}^{n+1} \neq D^{n+1}$ : In this case, the discussion is completely parallel to the previous case. In particular,  $\mathcal{M}$  is a separable  $n$ -category and  $\Omega_m\mathcal{M}$  is a multi-fusion  $(n-1)$ -category. If  $m$  is non-zero in each connected component of  $\mathcal{M}$ , then we obtain

$$\mathcal{D} \simeq \text{Mod}_{\Omega_m\mathcal{M}}^{E_1}(n\text{Vec}) \simeq \text{Fun}(\mathcal{M}, \mathcal{M})^{\text{op}} \simeq \mathfrak{Z}_0(\mathcal{M}, m)^{\text{op}}, \quad \mathcal{M} \simeq \text{RMod}_{\Omega_m\mathcal{M}}(n\text{Vec}).$$

We reformulate the associated mathematical result as a generalization of Proposition 3.2.16.

**Proposition 3.2.19.** Let  $\mathcal{A}$  be a multi-fusion  $n$ -category. It can be viewed as a condensable  $E_1$ -algebra in  $(n+1)\text{Vec}$ . We have

$$\text{Mod}_{\mathcal{A}}^{E_1}((n+1)\text{Vec})^{\text{op}} \simeq \mathfrak{Z}_0(\Sigma\mathcal{A}). \quad (3.2.11)$$

If  $\mathcal{A}$  is indecomposable multi-fusion, then [KZ22b]

$$\text{Mod}_{\mathcal{A}}^{E_1}((n+1)\text{Vec})^{\text{op}} \simeq \mathfrak{Z}_0(\Sigma\mathcal{A}) \simeq \Sigma\mathfrak{Z}_1(\mathcal{A}). \quad (3.2.12)$$

(3).  $Z(\mathbb{C})^{n+2} = \mathbf{1}^{n+2}$ : We further assume that  $C^{n+1}$  is simple. In this case,  $\mathcal{C} = \Sigma\Omega\mathcal{C} = \text{RMod}_{\Omega\mathcal{C}}(n\text{Vec})$  provides a concrete coordinate system to the non-degenerate fusion  $n$ -category  $\mathcal{C}$ . The fusion product in this coordinate system is defined by  $\mathcal{K} \otimes^1 \mathcal{L} := \mathcal{K} \boxtimes_{\Omega\mathcal{C}} \mathcal{L}$  as depicted in the following picture.

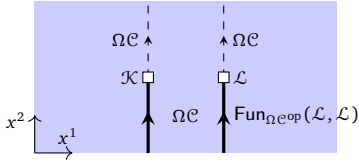

The right  $\Omega\mathcal{C}$ -module structures and tensor product:

$$\begin{aligned} (1). \quad & \mathcal{K} \times \Omega\mathcal{C} \xrightarrow{\circ} \mathcal{K}; \quad (k, a) \mapsto k \otimes^2 a; \\ (2). \quad & \mathcal{L} \times \Omega\mathcal{C} \xrightarrow{\circ} \mathcal{L}; \quad (l, a) \mapsto l \otimes^2 a; \\ (3). \quad & \boxtimes_{\Omega\mathcal{C}} : \mathcal{K} \times \mathcal{L} \rightarrow \mathcal{K} \boxtimes_{\Omega\mathcal{C}} \mathcal{L}, \quad (k, l) \mapsto k \boxtimes_{\Omega\mathcal{C}} l. \end{aligned} \quad (3.2.13)$$

In this case, it is possible to classify all the condensable  $E_1$ -algebras in  $\mathcal{C}$  via the following equivalence<sup>14</sup>:

$$\text{Alg}_{E_1}^{\mathcal{C}}(\text{RMod}_{\Omega\mathcal{C}}(n\text{Vec})) \simeq \text{LMod}_{\Omega\mathcal{C}}(\text{Alg}_{E_1}^{\mathcal{C}}(n\text{Vec})). \quad (3.2.14)$$

More explicitly, an object  $\mathcal{A} \in \text{LMod}_{\Omega\mathcal{C}}(\text{Alg}_{E_1}^{\mathcal{C}}(n\text{Vec}))$  is precisely a multi-fusion  $(n-1)$ -category  $\mathcal{A}$  equipped with a central functor  $\Omega\mathcal{C} \rightarrow \mathcal{A}$  (i.e., equipped with a braided monoidal functor  $\phi : \Omega\mathcal{C} \rightarrow \mathfrak{Z}_1(\mathcal{A})$ ), or equivalently, a multi-fusion  $(n-1)$ -category  $\mathcal{A}$  equipped with a monoidal action functor  $\odot : \Omega\mathcal{C} \times \mathcal{A} \rightarrow \mathcal{A}$  that defines the structure of left  $\Omega\mathcal{C}$ -module on  $\mathcal{A}$ .

For  $\mathcal{A} \in \text{RMod}_{\Omega\mathcal{C}}(\text{Alg}_{E_1}^{\mathcal{C}}(n\text{Vec}))$ , we can condense it and obtain

$$\mathcal{D} \simeq \text{Mod}_{\mathcal{A}}^{E_1}(\mathcal{C}), \quad \mathcal{M} \simeq \text{RMod}_{\mathcal{A}}(\mathcal{C}) \simeq \text{RMod}_{\mathcal{A}}(n\text{Vec}), \quad m = \mathcal{A} \in \text{RMod}_{\mathcal{A}}(\mathcal{C}),$$

where the last “ $\simeq$ ” is due to the fact that the right  $\Omega\mathcal{C}$ -action factors through the right  $\mathcal{A}$ -action. Moreover, we have

$$\Omega_m \mathcal{M} = \text{hom}_{\text{RMod}_{\mathcal{A}}(\mathcal{C})}(\mathcal{A}, \mathcal{A}) \simeq \text{Fun}_{\mathcal{A}^{\text{op}}}(\mathcal{A}, \mathcal{A}) \simeq \mathcal{A}.$$

It means that  $\mathcal{A}$  is precisely the category of topological defects on the gapped wall  $(\mathcal{M}, \mathcal{A})$  between  $C^{n+1}$  and some  $D^{n+1}$ . This fact reveals the geometric relation between  $\Omega\mathcal{C}, \mathcal{A}, \Omega\mathcal{D}$  as illustrated in the following picture.

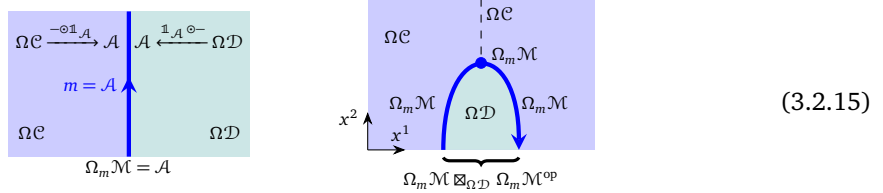

**Remark 3.2.20.** Although there is a natural right  $\Omega\mathcal{C}$ -action on  $\Omega_m \mathcal{M}^{\text{op}}$ , it means that  $\Omega_m \mathcal{M}^{\text{op}}$  is an object in  $\mathcal{C} = \text{RMod}_{\Omega\mathcal{C}}(n\text{Vec})$ . However, it does not mean that  $\Omega_m \mathcal{M}^{\text{op}}$  is an algebra in  $\text{RMod}_{\Omega\mathcal{C}}(n\text{Vec})$  because the monoidal structure in  $\Omega_m \mathcal{M}^{\text{op}}$  (i.e., the particle fusions) is not necessarily the same as the algebraic structure on a defect in  $\mathcal{C}$ . Using the second picture in (3.2.15), it is easy to check that the algebraic structure on  $\Omega_m \mathcal{M} \in \text{Alg}_{E_1}^{\mathcal{C}}(\mathcal{C})$  coincides with the monoidal structure of  $\Omega_m \mathcal{M}$ . This provides a physical explanation of the equivalence (3.2.14).  $\diamond$

<sup>14</sup>The proof of this equivalence is essentially tautological. See the proof for the  $n=2$  case in [BJS21] and the same proof works for general  $n$ .

By choosing different  $\mathcal{M}, m, \mathcal{D}$ 's, we recover all possible condensations. It means that we can reverse the story. More explicitly, given  $M^n = (\mathcal{M}, m)$ , where  $\mathcal{M}$  is a separable  $n$ -category and  $\Omega_m \mathcal{M}$  is a multi-fusion  $(n-1)$ -category. We assume that  $m$  is non-zero in each indecomposable left  $\mathcal{C}$ -submodule of  $\mathcal{M}$ . By moving 2-codimensional topological defects in  $C^{n+1}$  onto the wall  $M^n$ , we obtain an action  $\Omega \mathcal{C} \times \Omega_m \mathcal{M} \rightarrow \Omega_m \mathcal{M}$ , which is automatically monoidal, i.e.,  $\Omega_m \mathcal{M}$  is monoidal and the monoidal structure is compatible with the  $\Omega \mathcal{C}$ -action. As a consequence, we have

$$\Omega_m \mathcal{M} \in \text{LMod}_{\Omega \mathcal{C}}(\text{Alg}_{E_1}^{\mathcal{C}}(n\text{Vec})) \simeq \text{Alg}_{E_1}^{\mathcal{C}}(\text{RMod}_{\Omega \mathcal{C}}(n\text{Vec})).$$

In other words,  $\Omega_m \mathcal{M}$  is a condensable  $E_1$ -algebra in  $\mathcal{C} = \Sigma \Omega \mathcal{C}$ . Moreover,  $[m, m]_{\mathcal{C}}$  can be identified with  $\Omega_m \mathcal{M}$ , and we have

$$\mathcal{D} \simeq \text{Mod}_{\Omega_m \mathcal{M}}^{E_1}(\mathcal{C}), \quad \mathcal{M} \simeq \text{RMod}_{\Omega_m \mathcal{M}}(\mathcal{C}) \simeq \text{RMod}_{\Omega_m \mathcal{M}}(n\text{Vec}).$$

In this case, we also have  $\mathcal{D}^{\text{op}} \simeq \text{Mod}_{\Omega_m \mathcal{M}}^{E_1}(\mathcal{C})^{\text{op}} \simeq \mathfrak{Z}_1(\mathcal{C}, \mathfrak{Z}_0(\text{RMod}_{\Omega_m \mathcal{M}}(\mathcal{C})))$ . We summarize the key point in this case in the following theorem.

**Theorem<sup>ph</sup> 3.2.21.** When  $C^{n+1}$  is anomaly-free and simple, all condensable  $E_1$ -algebras in the fusion  $n$ -category  $\mathcal{C} = \Sigma \Omega \mathcal{C}$  are given by a multi-fusion  $(n-1)$ -category  $\mathcal{A}$  equipped with a braided monoidal functor  $\phi : \Omega \mathcal{C} \rightarrow \mathfrak{Z}_1(\mathcal{A})$ . Moreover, we have the following equivalence of categories:

$$\text{Alg}_{E_1}^{\mathcal{C}}(\text{RMod}_{\Omega \mathcal{C}}(n\text{Vec})) \simeq \text{LMod}_{\Omega \mathcal{C}}(\text{Alg}_{E_1}^{\mathcal{C}}(n\text{Vec})). \quad (3.2.16)$$

By condensing  $\mathcal{A}$  in  $\mathcal{C}$ , we obtain a condensed phase  $D^{n+1}$  and a gapped domain wall  $M^n$  such that

$$\mathcal{D} \simeq \text{Mod}_{\mathcal{A}}^{E_1}(\mathcal{C}), \quad \mathcal{M} \simeq \text{RMod}_{\mathcal{A}}(\mathcal{C}) \simeq \text{RMod}_{\mathcal{A}}(n\text{Vec}) = \Sigma \mathcal{A}, \quad m = \mathcal{A}.$$

If  $\phi$  is an equivalence, then  $\mathcal{A}$  is “Lagrangian” in the sense that  $D^{n+1} = \mathbf{1}^{n+1}$ .

(4).  $C^{n+1} = Z(\mathcal{B})^{n+1}$ : In this case,  $C^{n+1}$  is anomaly-free and non-chiral, and admits a gapped boundary  $B^n$ , which is assumed to be simple. Then  $C^{n+1}$  is also simple. Therefore, this case is just a special case of (3). However, in this case,  $\mathcal{C}$  has another natural coordinate system given by

$$\mathcal{C} = \text{BMod}_{\mathcal{B}^{\text{op}}|\mathcal{B}}(n\text{Vec}) \simeq \text{BMod}_{\mathcal{B}|\mathcal{B}}(n\text{Vec})^{\text{op}},$$

where  $\mathcal{B}$  is the fusion  $(n-1)$ -category of all topological defects in  $B^n$ . A condensable  $E_1$ -algebra in  $\mathcal{C}$  is precisely a multi-fusion  $(n-1)$ -category  $\mathcal{A}^{\text{op}}$  equipped with a monoidal functor  $\psi : \mathcal{B} \rightarrow \mathcal{A}$ . By condensing the condensable  $E_1$ -algebra  $\mathcal{A}^{\text{op}}$  in  $\mathcal{C}$ , we obtain the condensed phase  $D^{n+1}$  and  $M^n$  as follows:

$$\mathcal{D} = \text{Mod}_{\mathcal{A}^{\text{op}}}^{E_1}(\mathcal{C}) \simeq \text{Mod}_{\mathcal{A}^{\text{op}}}^{E_1}(n\text{Vec}), \quad (3.2.17)$$

$$(\mathcal{M}, m) = (\text{LMod}_{\mathcal{A}}(\mathcal{C}), \mathcal{A}) = (\text{BMod}_{\mathcal{A}|\mathcal{B}}(n\text{Vec}), \mathcal{A}), \quad (3.2.18)$$

where the first “ $\simeq$ ” is due to the fact that the  $\mathcal{B}$ -module structure factors through the monoidal functor  $\psi$ . As a consequence, we obtain

$$\Omega \mathcal{D} \simeq \mathfrak{Z}_1(\mathcal{A}), \quad \Omega_m \mathcal{M} \simeq \text{Fun}_{\mathcal{A}|\mathcal{B}}(\mathcal{A}, \mathcal{A}). \quad (3.2.19)$$

Note that, according to [KZ18a, Theorem 3.2.3][KZ22b],  $\text{Fun}_{\mathcal{B}|\mathcal{A}^{\text{op}}}(\mathcal{A}, \mathcal{A})$  is precisely the closed  $\Omega \mathcal{D}^{\text{op}}$ - $\Omega \mathcal{C}$ -bimodule that defines alternatively the monoidal functor  $\psi : \mathcal{B}^{\text{op}} \rightarrow \mathcal{A}^{\text{op}}$  as the following composed functor (with an illustration of its physical meaning).

$$\begin{array}{c} \overbrace{\mathcal{B}^{\text{op}} \xrightarrow{\text{Fun}_{\mathcal{A}|\mathcal{B}}(\mathcal{A}, \mathcal{A})} \mathcal{B}^{\text{op}}}^{\mathcal{A}^{\text{op}}} \\ \uparrow \text{Fun}_{\mathcal{A}|\mathcal{B}}(\mathcal{A}, \mathcal{A}) \\ \mathcal{B}^{\text{op}} \xrightarrow{\text{Fun}_{\mathcal{A}|\mathcal{B}}(\mathcal{A}, \mathcal{A})} \mathcal{B}^{\text{op}} \boxtimes_{\mathfrak{Z}_1(\mathcal{B})} \text{Fun}_{\mathcal{A}|\mathcal{B}}(\mathcal{A}, \mathcal{A}) \simeq \text{Fun}_{\mathcal{A}}(\mathcal{A}, \mathcal{A}) \simeq \mathcal{A}^{\text{op}}. \end{array} \quad (3.2.20)$$

**Example 3.2.22.** For  $\mathcal{X} \in \text{LMod}_{\mathcal{B}}(n\text{Vec})$ , the canonical monoidal functor  $\mathcal{B} \rightarrow \mathfrak{Z}_0(\mathcal{X}) = \text{Fun}(\mathcal{X}, \mathcal{X})$  defines an condensable  $E_1$ -algebra  $\mathfrak{Z}_0(\mathcal{X})^{\text{op}}$  in  $\mathcal{C} = \text{BMod}_{\mathcal{B}|\mathcal{B}}(n\text{Vec})^{\text{op}}$ .  $\heartsuit$

**Remark 3.2.23.** It is very illuminating to see the connection between the two coordinate systems in this case. By [KLWZZ20b], these two coordinate systems  $\mathcal{C} = \text{RMod}_{\Omega\mathcal{C}}(n\text{Vec})$  and  $\mathcal{C} = \text{BMod}_{\mathcal{B}^{\text{op}}|\mathcal{B}^{\text{op}}}(n\text{Vec})$  are related by the following monoidal equivalence:

$$\text{RMod}_{\Omega\mathcal{C}}(n\text{Vec}) \xrightarrow{\simeq} \text{BMod}_{\mathcal{B}^{\text{op}}|\mathcal{B}^{\text{op}}}(n\text{Vec})$$

$$\mathcal{K} \mapsto \mathcal{K} \boxtimes_{\mathfrak{Z}_1(\mathcal{B})} \mathcal{B}.$$

Using this equivalence, we immediately see that the relation between  $\Omega_m \mathcal{M} \in \text{Alg}_{E_1}^{\mathcal{C}}(\text{RMod}_{\Omega\mathcal{C}}(n\text{Vec}))$  and its corresponding condensable  $E_1$ -algebra  $\mathcal{A}^{\text{op}} \in \text{Alg}_{E_1}^{\mathcal{C}}(\text{BMod}_{\mathcal{B}^{\text{op}}|\mathcal{B}^{\text{op}}}(n\text{Vec}))$  is precisely the one illustrated in the picture in (3.2.20).  $\diamond$

This result provides a powerful tool to construct condensable 1-codimensional topological defects in a non-chiral topological order, or equivalently, condensable  $E_1$ -algebra in a fusion  $n$ -category obtained from the delooping of a non-degenerate and non-chiral braided fusion  $(n-1)$ -category. We state it as a mathematical theorem.

**Theorem 3.2.24.** For a non-chiral simple topological order  $\mathcal{C}^{n+1} = Z(\mathcal{B})^{n+1}$ , all indecomposable condensable  $E_1$ -algebras in the fusion  $n$ -category  $\mathcal{C} = \text{BMod}_{\mathcal{B}|\mathcal{B}}(n\text{Vec})^{\text{op}}$  can be constructed systematically as follows. Let  $\mathcal{P}$  be a fusion  $(n-1)$ -category and  $\mathcal{X} \in \text{BMod}_{\mathcal{B}|\mathcal{P}}(n\text{Vec})$ . Then we have a canonical monoidal functor from  $\mathcal{B}$  to an indecomposable multi-fusion  $n$ -category  $\mathcal{A} := \text{Fun}_{\mathcal{P}^{\text{op}}}(\mathcal{X}, \mathcal{X})$ :

$$\mathcal{B} \rightarrow \text{Fun}_{\mathcal{B}|\mathcal{P}}(\mathcal{X}, \mathcal{X}) \boxtimes_{\mathfrak{Z}_1(\mathcal{B})} \mathcal{B} \simeq \text{Fun}_{\mathcal{P}^{\text{op}}}(\mathcal{X}, \mathcal{X}) = \mathcal{A},$$

which defines an indecomposable condensable  $E_1$ -algebra  $\mathcal{A}^{\text{op}}$  in  $\text{BMod}_{\mathcal{B}|\mathcal{B}}(n\text{Vec})^{\text{op}}$ . The physical meaning of each data is illustrated in the following picture.

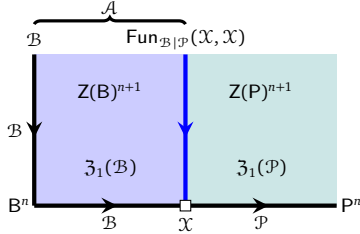

Two definitions of the same algebra in  $\mathcal{C}$  :

- (1) the monoidal functor  $\mathcal{B} \rightarrow \mathcal{A}$  defines  $\mathcal{A}^{\text{op}} \in \text{Alg}_{E_1}^{\mathcal{C}}(\text{BMod}_{\mathcal{B}|\mathcal{B}}(n\text{Vec})^{\text{op}})$ ;
- (2) the central functor  $\mathfrak{Z}_1(\mathcal{B}) \rightarrow \text{Fun}_{\mathcal{B}|\mathcal{P}}(\mathcal{X}, \mathcal{X})^{\text{op}}$  defines  $\text{Fun}_{\mathcal{B}|\mathcal{P}}(\mathcal{X}, \mathcal{X})^{\text{op}} \in \text{Alg}_{E_1}^{\mathcal{C}}(\text{RMod}_{\mathfrak{Z}_1(\mathcal{B})}(n\text{Vec}))$ .

By condensing  $\mathcal{A}^{\text{op}}$  in  $\mathcal{C}$ , we obtain the condensed topological order  $\mathcal{D}^{n+1} = Z(\mathcal{P})^{n+1}$  with

$$\mathcal{D} \simeq \text{Mod}_{\mathcal{A}^{\text{op}}}^{E_1}(\mathcal{C}) \simeq \Sigma \mathfrak{Z}_1(\mathcal{P})$$

and a gapped domain wall

$$\mathcal{M}^n = (\mathcal{M}, m) \simeq (\text{BMod}_{\mathcal{A}|\mathcal{B}}(n\text{Vec}), \mathcal{A}), \quad \Omega_m \mathcal{M} = \text{Fun}_{\mathcal{A}|\mathcal{B}}(\mathcal{A}, \mathcal{A}) \simeq \text{Fun}_{\mathcal{B}|\mathcal{P}}(\mathcal{X}, \mathcal{X})^{\text{op}}.$$

Moreover, all indecomposable condensable  $E_1$ -algebras in  $\mathcal{C} = \text{BMod}_{\mathcal{B}|\mathcal{B}}(n\text{Vec})^{\text{op}}$  arise in this way.

If we fix the condensed phase to be  $Z(\mathcal{P})^{n+1}$  and ask how many indecomposable condensable  $E_1$ -algebras in  $\mathcal{C}$  that produces the condensed phase  $Z(\mathcal{P})^{n+1}$ , then all of them are of the form  $\text{Fun}_{\mathcal{P}^{\text{op}}}(\mathcal{X}, \mathcal{X})^{\text{op}}$  in  $\text{BMod}_{\mathcal{B}|\mathcal{B}}(n\text{Vec})$  for some  $\mathcal{X} \in \text{BMod}_{\mathcal{B}|\mathcal{P}}(n\text{Vec})$ .<sup>15</sup> Moreover, if  $\mathcal{P} = (n-1)\text{Vec}$ , then the canonical monoidal functor  $\mathcal{B} \rightarrow \text{Fun}(\mathcal{X}, \mathcal{X})$  for  $\mathcal{X} \in \text{LMod}_{\mathcal{B}}(n\text{Vec})$  define all ‘‘Lagrangian’’ condensable  $E_1$ -algebras in  $\mathcal{C}$ .

<sup>15</sup>All such condensable  $E_1$ -algebras are called  $\text{Mod}^{E_1}$ -equivalent (see Definition 6.1.1).

### 3.2.3 Examples in 2+1D

**Example 3.2.25.** When  $\mathcal{C}^3$  is the trivial 2+1D topological order, we have  $\mathcal{C} = 2\text{Vec}$ . There are infinitely many simple condensable  $E_1$ -algebras in  $2\text{Vec}$ . Indeed, simple condensable  $E_1$ -algebras in  $2\text{Vec}$  are fusion 1-categories [D 23]. By condensing a fusion 1-category  $\mathcal{A} \in 2\text{Vec}$ , we obtain the new 2+1D non-chiral simple topological order  $\mathcal{D}^3$  such that  $\mathcal{D} \simeq \text{Mod}_{\mathcal{A}}^{E_1}(2\text{Vec}) \simeq \Sigma \mathfrak{Z}_1(\mathcal{A})$ , and a gapped domain wall  $\mathcal{M}^2 = (\mathcal{M}, \mathcal{A})$  such that  $\mathcal{M} = \text{RMod}_{\mathcal{A}}(2\text{Vec})$  and  $\Omega_{\mathcal{A}}\mathcal{M} = \mathcal{A}$ . Hence, all non-chiral 2+1D simple topological orders can be obtained in this way. If  $\mathcal{A}$  is an indecomposable multi-fusion  $n$ -category, the same construction works but does not produce extra condensed phases.  $\heartsuit$

**Example 3.2.26.** The topological defects in the 2+1D  $\mathbb{Z}_2$ -gauge theory form a fusion 2-category  $\mathcal{TC}$ , which can be identified with the 2-category  $\text{RMod}_{\mathfrak{Z}_1(\text{Rep}(\mathbb{Z}_2))}(2\text{Vec})$ . By [BJS21] (or Theorem 3.2.21), a condensable  $E_1$ -algebra in  $\mathcal{TC}$  are precisely multi-fusion left  $\mathfrak{Z}_1(\text{Rep}(\mathbb{Z}_2))$ -modules, i.e., a multi-fusion categories  $\mathcal{A}$  equipped with a braided functors  $\mathfrak{Z}_1(\text{Rep}(\mathbb{Z}_2)) \rightarrow \mathfrak{Z}_1(\mathcal{A})$ . Here we list some examples.

1. The fusion category  $\mathfrak{Z}_1(\text{Rep}(\mathbb{Z}_2))$  equipped with the identity functor  $\text{id}_{\mathfrak{Z}_1(\text{Rep}(\mathbb{Z}_2))}$ , which should be viewed as a central functor, defines a condensable  $E_1$ -algebra  $\mathfrak{Z}_1(\text{Rep}(\mathbb{Z}_2))$  in the coordinate system  $\mathcal{TC} = \text{RMod}_{\mathfrak{Z}_1(\text{Rep}(\mathbb{Z}_2))}(2\text{Vec})$ . It is the tensor unit of  $\mathcal{TC}$ .
2. The fusion category  $\text{Rep}(\mathbb{Z}_2)$  equipped with the central functor  $f : \mathfrak{Z}_1(\text{Rep}(\mathbb{Z}_2)) \rightarrow \text{Rep}(\mathbb{Z}_2)$  defines a condensable  $E_1$ -algebra  $\text{Rep}(\mathbb{Z}_2)^{\text{op}} = \text{Rep}(\mathbb{Z}_2)$  in  $\text{RMod}_{\mathfrak{Z}_1(\text{Rep}(\mathbb{Z}_2))}(2\text{Vec})$ . It corresponds to the 1-codimensional defect  $ss$  in  $\mathcal{TC}$ . We have  $\text{Mod}_{\text{Rep}(\mathbb{Z}_2)}^{E_1}(\Sigma \mathfrak{Z}_1(\text{Rep}(\mathbb{Z}_2))) \simeq 2\text{Vec}$ , which means that the condensed 2+1D topological order is trivial. This condensation defined by  $ss$  is the same as the anyon condensation defined by  $\mathbb{1} \oplus m$ . Therefore,  $ss$  can be viewed as a ‘‘Lagrangian’’ condensable  $E_1$ -algebra in  $\mathcal{TC}$ .
3. The fusion category  $\text{Vec}_{\mathbb{Z}_2}$  is equipped with the canonical equivalence  $\mathfrak{Z}_1(\text{Rep}(\mathbb{Z}_2)) \rightarrow \mathfrak{Z}_1(\text{Vec}_{\mathbb{Z}_2})$ . It defines a condensable  $E_1$ -algebra  $\text{Vec}_{\mathbb{Z}_2}^{\text{op}} = \text{Vec}_{\mathbb{Z}_2}$ , corresponding to the 1-codimensional defect  $rr$  in  $\mathcal{TC}$ . We have  $\text{Mod}_{\text{Vec}_{\mathbb{Z}_2}}^{E_1}(\Sigma \mathfrak{Z}_1(\text{Rep}(\mathbb{Z}_2))) \simeq 2\text{Vec}$ , which means that the condensed topological order is trivial. This condensation defined by  $rr$  is the same as the anyon condensation defined by  $\mathbb{1} \oplus e$ . Therefore, this condensable  $E_1$ -algebra  $\text{Vec}_{\mathbb{Z}_2}$  is also ‘‘Lagrangian’’.
4. As we will review in Example 4.1.7, the following object

$$A := \mathbb{1} \boxtimes \mathbb{1} \oplus \psi \boxtimes \psi \in \Omega \mathcal{J}s \boxtimes \Omega \mathcal{J}s^{\text{op}} \simeq \mathfrak{Z}_1(\Omega \mathcal{J}s)$$

has a canonical structure of a simple commutative separable algebra in  $\mathfrak{Z}_1(\Omega \mathcal{J}s)$ . Then fusion 1-category  $\mathcal{K} := \text{RMod}_A(\mathfrak{Z}_1(\Omega \mathcal{J}s))^{\text{op}}$  is naturally a condensable  $E_1$ -algebra in  $\mathcal{TC}$ . The category  $\mathcal{K}$  has six simple objects  $1, e, m, f, \chi_{\pm}$  (see Example 4.1.7). Condensing  $\mathcal{K}$  in  $\mathcal{TC}$  produces the condensed phase  $\mathcal{D}^3$ , which is precisely the 2+1D double Ising topological order, i.e.,

$$\text{Mod}_{\mathcal{K}}^{E_1}(\mathcal{TC}) \simeq \mathcal{J}s \boxtimes \mathcal{J}s^{\text{op}},$$

and a gapped domain wall  $\mathcal{M}^2 = (\mathcal{M}, m) = (\text{RMod}_{\mathcal{K}}(\mathcal{TC}), \mathcal{K}) = (\text{RMod}_{\mathcal{K}}(2\text{Vec}), \mathcal{K})$ .

**Example 3.2.27.** We can choose a different coordinate system for  $\mathcal{TC}$ . Indeed, by [KK12],  $\mathcal{TC}$  can be identified with the fusion 2-category  $\text{BMod}_{\text{Rep}(\mathbb{Z}_2)|\text{Rep}(\mathbb{Z}_2)}(2\text{Vec})^{\text{op}}$ . A condensable  $E_1$ -algebra in  $\mathcal{TC}$  is precisely a fusion 1-category  $\mathcal{B}^{\text{op}}$  equipped with a monoidal functor  $\text{Rep}(\mathbb{Z}_2) \rightarrow \mathcal{B}$ . Here we list some examples:

1. The fusion category  $\text{Rep}(\mathbb{Z}_2)$  equipped with the identity functor  $\text{Rep}(\mathbb{Z}_2) \rightarrow \text{Rep}(\mathbb{Z}_2)$  is a condensable  $E_1$ -algebra. It is the tensor unit of  $\mathcal{TC}$ .



2. The fusion category  $\text{Vec}$  equipped with the forgetful functor  $\text{Rep}(\mathbb{Z}_2) \rightarrow \text{Vec}$  is a ‘‘Lagrangian’’  $E_1$ -algebra, which corresponds to the 1-codimensional topological defect  $rr$  in  $\mathcal{TC}$ .

3. The multi-fusion category  $\text{Fun}(\text{Rep}(\mathbb{Z}_2), \text{Rep}(\mathbb{Z}_2))^{\text{op}}$  equipped with the canonical embedding

$$\text{Rep}(\mathbb{Z}_2) \rightarrow \text{Fun}(\text{Rep}(\mathbb{Z}_2), \text{Rep}(\mathbb{Z}_2))$$

is a ‘‘Lagrangian’’  $E_1$ -algebra, which corresponds to the 1-codimensional topological defect  $ss$  in  $\mathcal{TC}$ .

4. We set  $\mathcal{K} := \text{RMod}_A(\mathfrak{Z}_1(\Omega\mathcal{J}_s))$ . There is a canonical monoidal functor

$$\text{Rep}(\mathbb{Z}_2) \rightarrow \mathcal{K} \boxtimes_{\mathfrak{Z}_1(\text{Rep}(\mathbb{Z}_2))} \text{Rep}(\mathbb{Z}_2) =: \mathcal{A}$$

defines a condensable  $E_1$ -algebra  $\mathcal{A}^{\text{op}}$  in  $\mathcal{TC} = \text{BMod}_{\text{Rep}(\mathbb{Z}_2)|\text{Rep}(\mathbb{Z}_2)}(2\text{Vec})^{\text{op}}$ . Condensing  $\mathcal{A}^{\text{op}}$  produces the condensed topological order  $Z(\text{Is})^3$ :

$$\mathcal{J}_s \boxtimes \mathcal{J}_s^{\text{op}} \simeq \text{Mod}_{\mathcal{A}^{\text{op}}}^{E_1}(\mathcal{TC}),$$

and the gapped domain wall  $M^2$  such that (using (3.2.18) and (3.2.19))

$$(\mathcal{M}, m) = (\text{BMod}_{\mathcal{A}|B}(n\text{Vec}), \mathcal{A}) \simeq (\Sigma\mathcal{K}^{\text{op}}, \mathcal{K}).$$

The physical meaning of above data is depicted in the following picture.

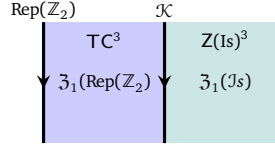

**Example 3.2.28.** Consider 2+1D finite gauge theory  $\text{GT}_G^3$  for a finite group  $G$ . We provide some examples of condensable  $E_1$ -algebras in  $\mathcal{GT}_G^3$  in two coordinate systems.

1.  $\mathcal{GT}_G^3 = \text{RMod}_{\mathfrak{Z}_1(\text{Rep}(G))}(2\text{Vec})$ :

(a) Consider a simple condensable  $E_2$ -algebra  $A$  in  $\mathfrak{Z}_1(\text{Rep}(G))$ . Such algebras have been classified by Davydov in [Dav10b] (see Example 4.1.6). The central functor

$$-\otimes A : \mathfrak{Z}_1(\text{Rep}(G)) \rightarrow \text{RMod}_A(\mathfrak{Z}_1(\text{Rep}(G)))$$

defines a condensable  $E_1$ -algebra  $B := \text{RMod}_A(\mathfrak{Z}_1(\text{Rep}(G)))$  in  $\text{RMod}_{\mathfrak{Z}_1(\text{Rep}(G))}(2\text{Vec})$ . By condensing it, we obtain a new 2+1D topological order  $\mathcal{D}^3$  and a gapped domain wall  $M^2$  given by

$$\begin{aligned} \mathcal{D} &\simeq \text{Mod}_B^{E_1}(\Sigma\mathfrak{Z}_1(\text{Rep}(G))) \simeq \Sigma(\text{Mod}_A^{E_2}(\mathfrak{Z}_1(\text{Rep}(G)))) \\ (\mathcal{M}, m) &\simeq (\text{RMod}_B(\Sigma\mathfrak{Z}_1(\text{Rep}(G))), B) \simeq (\Sigma B, B). \end{aligned} \quad \heartsuit$$

- i. When  $A = \mathbb{1}_{\mathfrak{Z}_1(\text{Rep}(G))}$ ,  $-\otimes A \simeq \text{id}_{\mathfrak{Z}_1(\text{Rep}(G))}$  defines the trivial condensable  $E_1$ -algebra  $\mathbb{1}_{\mathcal{GT}_G^3}$ , which defines a trivial condensation.
- ii. The group algebra  $A = \mathbb{C}[G]$  can be viewed as a Lagrangian  $E_2$ -algebra in  $\mathfrak{Z}_1(\text{Vec}_G) \simeq \mathfrak{Z}_1(\text{Rep}(G))$  (see Example 4.1.6). In this case, the central functor  $-\otimes A$  can be identified with the canonical central functor: the forgetful functor  $\mathfrak{Z}_1(\text{Rep}(G)) \rightarrow \text{Rep}(G)$ , which defines a Lagrangian  $E_1$ -algebra  $\text{Rep}(G)$  in  $\mathcal{GT}_G^3$ . By condensing it, we obtain  $\mathbb{1}^3$  as the condensed phase and a gapped boundary  $M^2$  such that  $(\mathcal{M}, m) \simeq (2\text{Rep}(G), \mathbb{1})$ .

iii. The algebra  $\text{Fun}(G)$  is a Lagrangian  $E_2$ -algebra in  $\mathfrak{Z}_1(\text{Vec}_G) \simeq \mathfrak{Z}_1(\text{Rep}(G))$  (see Example 4.1.6). In this case, the central functor  $-\otimes A$  can be identified with the central functor  $\mathfrak{Z}_1(\text{Rep}(G)) \simeq \mathfrak{Z}_1(\text{Vec}_G) \xrightarrow{f} \text{Vec}_G$ , which defines a Lagrangian  $E_1$ -algebra in  $\mathcal{G}\mathcal{T}_G^3$ . By condensing it, we obtain  $\mathbf{1}^3$  as the condensed phase and a gapped boundary  $M^2$  such that  $(\mathcal{M}, m) \simeq (\Sigma\text{Vec}_G, \text{Vec}_G)$ .

(b) We can condense a condensable  $E_1$ -algebra in  $\mathcal{G}\mathcal{T}_G^3$  to obtain any 2+1D simple non-chiral topological orders as shown in Theorem 3.2.24. We give a concrete example.

i. Let  $G_1$  and  $G_2$  be two finite groups and  $H$  a subgroup of both  $G_1$  and  $G_2$ . By restriction, we obtain two monoidal functors  $\text{Rep}(G_1) \rightarrow \text{Rep}(H)$  and  $\text{Rep}(G_2) \rightarrow \text{Rep}(H)$ . Therefore,  $\text{Rep}(H)$  is a  $\text{Rep}(G_1)$ - $\text{Rep}(G_2)$ -bimodule. As a consequence, there is a natural central functor  $\mathfrak{Z}_1(\text{Rep}(G_1)) \rightarrow \mathcal{K} := \text{Fun}_{\text{Rep}(G_1)|\text{Rep}(G_2)}(\text{Rep}(H), \text{Rep}(H))$ , which defines a condensable  $E_1$ -algebra  $\mathcal{K}$  in  $\mathcal{G}\mathcal{T}_{G_1}^3$ . By condensing the 1-codimensional topological defect  $\mathcal{K}$  in  $\text{RMod}_{\mathfrak{Z}_1(\text{Rep}(G_1))}(\text{2Vec})$ , we obtain the  $\text{GT}_{G_2}^3$  as the condensed 2+1D phase.

2.  $\mathcal{G}\mathcal{T}_G^3 = \text{BMod}_{\text{Rep}(G)|\text{Rep}(G)}(\text{2Vec})^{\text{op}}$ :

**Remark 3.2.29.** The Levin-Wen model [LW05] can be viewed as a physical way to realize the condensation defined by condensing a simple condensable  $E_1$ -algebra  $\mathcal{A}$  in  $\text{2Vec}$  (i.e.,  $\mathcal{A}$  is a fusion 1-category).  $\diamond$

### 3.2.4 Examples in 3+1D

We have already seen condensations of 1-codimensional topological defects in  $\mathbf{1}^4$  in Section 3.2.2. In this subsection, we provide some examples in 3+1D finite gauge theories based on Theorem 3.2.24.

**Example 3.2.30.** For any fusion 2-categories  $\mathcal{C}$ , we have  $\mathcal{C} \simeq \mathcal{C} \boxtimes \text{2Vec}$ . Therefore, there are infinitely number of condensable  $E_1$ -algebras in any fusion 2-categories  $\mathcal{C}$ .  $\heartsuit$

**Example 3.2.31.** We denote the 3+1D  $G$ -gauge theory for a finite group  $G$  by  $\text{GT}_G^4$ . Then its category of topological defects is  $\mathcal{G}\mathcal{T}_G^4$  has the following coordinate system:

$$\mathcal{G}\mathcal{T}_G^4 = \text{BMod}_{\text{2Rep}(G)|\text{2Rep}(G)}(\text{3Vec})^{\text{op}},$$

where  $\Omega\mathcal{G}\mathcal{T}_G^4 = \mathfrak{Z}_1(\text{2Vec}_G)$  [KTZ20b].

1. Let  $\psi : \text{2Rep}(G) \rightarrow \text{2Vec}$  be the canonical fiber functor naturally induces from the forgetful functor  $f : \text{Rep}(G) \rightarrow \text{Vec}$  via delooping. Then  $\text{2Vec}^{\text{op}} = \text{2Vec}$  is a condensable  $E_1$ -algebra in  $\text{BMod}_{\text{2Rep}(G)|\text{2Rep}(G)}(\text{3Vec})^{\text{op}}$ . By condensing it, we obtain the trivial phase  $D^4 = \mathbf{1}^4$  and a gapped boundary  $M^3$  with

$$(\mathcal{M}, m) = (\text{RMod}_{\text{2Rep}(G)}(\text{3Vec}), \text{2Vec}), \quad \Omega_m \mathcal{M} = \text{Fun}_{\text{2Rep}(G)}(\text{2Vec}, \text{2Vec}) \simeq \text{2Vec}_G.$$

This condensation of 1-codimensional topological defect  $\text{2Vec} \in \mathcal{G}\mathcal{T}_G^4$  is equivalent to a condensation of 3-codimensional topological defect (i.e., a particle)  $\text{Fun}(G) \in \text{Rep}(G) \simeq \Omega^2\mathcal{G}\mathcal{T}_G^4$ . When  $G = \mathbb{Z}_2$ , this particle is precisely the  $e$ -particle in 3+1D toric code model [HZW05, KTZ20a, ZLZH<sup>+</sup>23]. When  $G = \mathbb{Z}_2$  the boundary  $M^3$  is called the rough boundary [ZLZH<sup>+</sup>23], which can also be obtained by condensing the  $\mathbb{1}_c$ -string [ZLZH<sup>+</sup>23].

2. Let  $\psi : \text{2Rep}(G) \rightarrow \mathcal{A} = \text{Fun}(\text{2Rep}(G), \text{2Rep}(G))$  be the canonical monoidal functor defined by the left multiplication  $x \otimes -$ . Then  $\mathcal{A}^{\text{op}}$  is a condensable  $E_1$ -algebra in  $\text{BMod}_{\text{2Rep}(G)|\text{2Rep}(G)}(\text{3Vec})^{\text{op}}$ . By condensing it, we obtain the trivial phase  $D^4 = \mathbf{1}^4$  and a gapped boundary  $M^3$  with

$$(\mathcal{M}, m) = (\text{RMod}_{\text{2Rep}(G)|\mathcal{A}}(\text{3Vec}), \mathcal{A}), \\ \Omega_m \mathcal{M} = \text{Fun}_{\text{2Rep}(G)|\mathcal{A}}(\mathcal{A}, \mathcal{A}) \simeq \text{2Rep}(G).$$

When  $G = \mathbb{Z}_2$ , this gapped boundary of  $\text{GT}_G^4$  is called the smooth boundary [KTZ20a], which can also be obtained from condensing  $m$ -string or the Lagrangian  $E_2$ -algebra  $1 \oplus m$  in  $\mathfrak{Z}_1(2\text{Vec}_G)$  [ZLZH<sup>+</sup>23]. Note that  $\mathcal{A}^{\text{op}}$  is a Lagrangian  $E_1$ -algebra in  $\mathcal{G}\mathcal{T}_G^4$ .

Since  $\mathfrak{Z}_1(2\text{Vec}_G)$  has a non-trivial braided auto-equivalence  $\alpha$  [ZLZH<sup>+</sup>23], we can twist  $\psi$  by  $\alpha$  as follows:

$$\begin{aligned} \psi^\alpha : 2\text{Rep}(G) &\rightarrow 2\text{Rep}(G) \boxtimes_{\mathfrak{Z}_1(2\text{Vec}_G)} \mathfrak{Z}_1(2\text{Vec}_G) \boxtimes_{\mathfrak{Z}_1(2\text{Vec}_G)} 2\text{Rep}(G) \\ &\xrightarrow{\text{id} \boxtimes_{\mathfrak{Z}_1(2\text{Vec}_G)} \psi \boxtimes_{\mathfrak{Z}_1(2\text{Vec}_G)} \text{id}} 2\text{Rep}(G) \boxtimes_{\mathfrak{Z}_1(2\text{Vec}_G)} \mathfrak{Z}_1(2\text{Vec}_G) \boxtimes_{\mathfrak{Z}_1(2\text{Vec}_G)} 2\text{Rep}(G) \simeq \mathcal{A}. \end{aligned}$$

Then  $\psi^\alpha$  endows a different algebraic structure on  $\mathcal{A}$  denoted by  $\mathcal{A}^\alpha$ . By condensing  $\mathcal{A}^\alpha$ , we obtained the condensed phase  $D^4 = \mathbf{1}^4$  and the so-called twist smooth boundary of  $\text{GG}_G^4$  [ZLZH<sup>+</sup>23].

3. By [KTZ20b], there is a canonical braided monoidal embedding  $\psi : 2\text{Rep}(G) \rightarrow \mathfrak{Z}_1(2\text{Vec}_G^\omega)$  for  $\omega \in H^4(G, U(1))$ . Therefore,  $\mathfrak{Z}_1(2\text{Vec}_G^\omega) \in \text{Alg}_{E_1}^c(\text{BMod}_{2\text{Rep}(G)|2\text{Rep}(G)}(3\text{Vec}))$ . By condensing it, we obtain the double- $\text{GT}_G^4$  phase as the condensed topological order  $D^4$ , i.e.,

$$\mathcal{D} \simeq \mathfrak{Z}_1(2\text{Vec}_G^\omega) \boxtimes \mathfrak{Z}_1(2\text{Vec}_G^\omega)^{\text{op}}$$

as fusion 2-categories, and a gapped domain wall  $M^3$  such that

$$(\mathcal{M}, m) = (\text{RMod}_{2\text{Rep}(G)|\mathfrak{Z}_1(2\text{Vec}_G^\omega)}(3\text{Vec}), \mathfrak{Z}_1(2\text{Vec}_G^\omega)).$$

This gapped domain wall was not known before. ♡

**Remark 3.2.32.** Using the conjecture on  $\mathfrak{Z}_1(n\text{Vec}_G^\omega)$  in [KTZ20b], above examples in  $\text{GT}_G^4$  can be generalized to  $n+1$ D finite gauge theories  $\text{GT}_G^{n+1}$  tautologically. ◇

## 4 Condensations of 2-codimensional topological defects

In previous section, we have seen that a condensation of 1-codimensional topological defects defines a phase transition from  $C^{n+1}$  to a new phase  $D^{n+1}$ , where both phase  $C^{n+1}$  and  $D^{n+1}$  are potentially anomalous  $n+1$ D topological orders. When we restrict to the case both  $C^{n+1}$  and  $D^{n+1}$  are anomaly-free, both categories of topological defects  $\mathcal{C}$  and  $\mathcal{D}$  are determined by  $\Omega\mathcal{C}$  and  $\Omega\mathcal{D}$ , respectively. In this case, it is possible to define a condensation in  $C^{n+1}$  by condensing a 2-codimensional topological defect in  $\Omega\mathcal{C}$  directly. When  $n = 2$ , such a condensation is precisely what is known as an anyon condensation (or boson condensation) defined in the non-degenerate braided fusion 1-category  $\Omega\mathcal{C}$  [Kon14]. When  $C^{n+1}$  is anomalous, it is still possible to define a condensation of 2-codimensional topological defect  $A$  by first condensing it to a condensed defect  $\Sigma A$  of codimension 1 followed by a condensation of  $\Sigma A$ . We study this two-step condensation in Section 5.

In this section, we first review the theory of anyon condensations in 2+1D with some new details and from some new perspectives that are ready to be generalized to higher dimensions.

### 4.1 Anyon condensations in 2+1D

We first review the main results in the algebraic (or bootstrap) approach developed in [Kon14] but emphasizing a new perspective of higher algebras and higher representations and introduce necessary new notations along the way, then we discuss a geometric approach, which can be generalized automatically to higher dimensions.

#### 4.1.1 Algebraic approach

We sketch a rederivation of the main results in [Kon14] but from a new perspective explained in Section 2.3.2. Assume that an anyon condensation occurs in a disk-like region within the 2+1D topological order  $C^3$  as depicted in Figure 10. We denote the condensed topological order by  $D^3$ . We denote the gapped domain wall by  $M^2$ . Topological particles in  $M^2$  form a fusion 1-category  $\mathcal{M}$ .

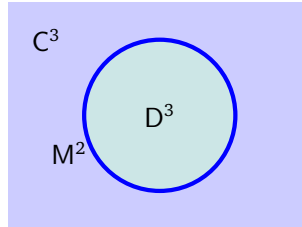

Figure 10: an anyon condensation in  $C^3$  depicted in the spatial dimension

It is possible to derive a precise relation among  $\Omega\mathcal{C}, \Omega\mathcal{D}, \mathcal{M}$  from natural physical intuitions [Kon14].

1. Anyons in  $D^3$  come from those in  $C^3$ . In other words, an anyon in  $D^3$  is automatically an anyon in  $C^3$ , i.e.  $\text{ob}(\Omega\mathcal{D}) \subset \text{ob}(\Omega\mathcal{C})$ . All fusion-splitting channels among anyons in  $\Omega\mathcal{D}$  come from those in  $\Omega\mathcal{C}$ , i.e.  $\text{hom}_{\Omega\mathcal{D}}(x, y) \subset \text{hom}_{\Omega\mathcal{C}}(x, y)$  for  $x, y \in \text{ob}(\Omega\mathcal{D})$ . As a consequence,  $\Omega\mathcal{D}$  is a sub-category of  $\Omega\mathcal{C}$ .
2. The trivial particle  $1_{\mathbb{1}_{\mathcal{D}}}$  in  $\mathcal{D}$ , i.e. the tensor unit of  $\Omega\mathcal{D}$ , is a non-trivial particle  $A$  in  $\Omega\mathcal{C}$  unless the condensation is trivial.

3. Similar to 1+1D cases, particle condensation is triggered by introducing interactions among particles. For  $a, b \in \Omega\mathcal{D} \subset \Omega\mathcal{C}$ , a sub-Hilbert space  $a \otimes_{\Omega\mathcal{D}} b$  of the Hilbert space associated to  $a \otimes_{\Omega\mathcal{C}} b$  becomes energy favorable due to the interaction. In other words, the condensation process produces a family of projections (called condensation maps):

$$a \otimes_{\Omega\mathcal{C}} b \xrightarrow{P_{a,b}} a \otimes_{\Omega\mathcal{D}} b, \quad \forall a, b \in \Omega\mathcal{D}.$$

In particular, we have the following special condensation maps:

$$\begin{aligned} \mu_A : A \otimes_{\Omega\mathcal{C}} A &\xrightarrow{P_{AA}} A \otimes_{\Omega\mathcal{D}} A \simeq A. \\ \forall x \in \Omega\mathcal{D}, \quad \mu_x^L : A \otimes_{\Omega\mathcal{C}} x &\xrightarrow{P_{A,x}} A \otimes_{\Omega\mathcal{D}} x \simeq x, \quad \mu_x^R : x \otimes_{\Omega\mathcal{C}} A \xrightarrow{P_{x,A}} x \otimes_{\Omega\mathcal{D}} A \simeq x. \end{aligned}$$

Moreover, since the trivial anyon  $1_{\mathbb{1}_e}$  in  $\Omega\mathcal{C}$  should condense into the trivial anyon in  $\Omega\mathcal{D}$ , we expect to have a morphism  $\eta_A : 1_{\mathbb{1}_e} \rightarrow A$ .

4. Similar to the 1+1D cases, the triple  $(A, \mu_A, \eta_A)$  defines a separable algebra in  $\Omega\mathcal{C}$  satisfying a new property:  $A$  is commutative. We do not repeat the reason provided for this commutativity in [Kon14]. Instead, we provide a new proof from the perspective of Section 2.3.2. Consider the physical configuration depicted left picture in Figure 11. By the same arguments in 1+1D case, there are two algebraic structures on  $A$ . One algebraic structure is defined for the horizontal fusion product  $\otimes^1$ , i.e.  $\mu_A^1 : A \otimes^1 A \rightarrow A$ . The other is defined for the vertical fusion product  $\otimes^2$ , i.e.  $\mu_A^2 : A \otimes^2 A \rightarrow A$ . The following diagram should be automatically commutative.

$$\begin{array}{ccc} (A \otimes^1 A) \otimes^2 (A \otimes^1 A) & \xrightarrow[\simeq]{\delta_{A,A,A,A}} & (A \otimes^2 A) \otimes^1 (A \otimes^2 A) \\ \mu_A^1 \otimes^2 \mu_A^1 \downarrow & & \downarrow \mu_A^2 \otimes^1 \mu_A^2 \\ A \otimes^2 A & & A \otimes^1 A \\ & \searrow \mu_A^2 & \swarrow \mu_A^1 \\ & A & \end{array} \quad (4.1.1)$$

Notice that  $(\mu_A^2 \otimes^1 \mu_A^2) \circ \delta_{A,A,A,A}$  defines an algebraic structure on  $A \otimes^1 A$  and  $(\mu_A^1 \otimes^2 \mu_A^1) \circ \delta_{A,A,A,A}^{-1}$  defines an algebraic structure on  $A \otimes^2 A$ . Then above commutativity diagram simply says that both morphisms  $\mu_A^2 : A \otimes^2 A \rightarrow A$  and  $\mu_A^1 : A \otimes^1 A \rightarrow A$  are algebra homomorphisms.

The unit morphism  $\eta_A : 1_{\mathbb{1}_e} \rightarrow A$  is the same for both algebraic structures. We obtain a commutative diagram:

$$\begin{array}{ccc} 1_{\mathbb{1}_e} \otimes^1 1_{\mathbb{1}_e} & \xrightarrow{\eta_A \otimes^1 1} & A \otimes^1 1_{\mathbb{1}_e} & \xrightarrow{1 \otimes \eta_A} & A \otimes^1 A \\ \simeq \downarrow & & \downarrow \simeq & & \swarrow \mu_A^1 \\ 1_{\mathbb{1}_e} & \xrightarrow{\eta_A} & A & & \end{array}$$

where the commutativity of the left square is due to the naturalness of the vertical  $\simeq$  and that of the right triangle is due to the unit property of  $(A, \mu_A^1, \eta_A)$ . Then the commutativity of the outer diagram means that  $\eta_A : 1_{\mathbb{1}_e} \rightarrow (A, \mu_A^1, \eta_A)$  is an algebraic homomorphism. Similarly, one can show that  $\eta_A : 1_{\mathbb{1}_e} \rightarrow (A, \mu_A^2, \eta_A)$  is also an algebra homomorphism.

In summary, both  $\mu_A^2 : A \otimes^2 A \rightarrow A$  and  $\eta_A$  are morphisms in  $\text{Alg}_{E_1}(\Omega\mathcal{C})$ . Therefore,  $(A, \mu_A^2, \eta_A)$  defines an algebra in  $\text{Alg}_{E_1}(\Omega\mathcal{C})$ . In other words,  $A \in \text{Alg}_{E_1}(\text{Alg}_{E_1}(\Omega\mathcal{C})) =: \text{Alg}_{E_2}(\Omega\mathcal{C})$ . This fact automatically implies the compatibility between  $\mu_A^1$  and  $\mu_A^2$  and the commutativity of  $A$ . Indeed,



Figure 11: a deconfined particle  $x$  as an  $E_2$ - $A$ -module in  $\Omega\mathcal{C}$

by composing the diagram (4.1.1) with the unit morphism  $\eta_A : 1_{\mathbb{1}} \rightarrow A$  that are compatible with (2.3.5) and (2.3.6), we obtain two commutative diagrams:

$$\begin{array}{ccc}
 A \otimes^2 A & \xrightarrow{\simeq} & A \otimes^1 A \\
 \mu_A^2 \searrow & & \swarrow \mu_A^1 \\
 & A & 
 \end{array}
 \qquad
 \begin{array}{ccc}
 A \otimes^1 A & \xrightarrow{\simeq} & A \otimes^1 A \\
 \mu_A^1 \searrow & & \swarrow \mu_A^1 \\
 & A & 
 \end{array}
 \tag{4.1.2}$$

where the ‘ $\simeq$ ’ in the first diagram is defined in (2.3.5), and the ‘ $\simeq$ ’ in the second diagram is precisely the braiding defined in (2.3.6).

Moreover, we require the commutative algebra  $A$  to be separable. This condition is a stability condition of the vacuum  $A$  [Kon14]. But one can also say that it is a requirement for  $\Omega\mathcal{D}$  to be a separable 1-category. If  $\mathcal{D}^3$  is simple, then  $A$  must be simple, i.e.,  $\dim \text{hom}_{\mathcal{C}}(1_{\mathbb{1}_{\mathcal{C}}}, A) = 1$ . A commutative separable algebra in  $\Omega\mathcal{C}$  is called a *condensable  $E_2$ -algebra* in  $\Omega\mathcal{C}$ . Such an algebra is also equipped naturally with a Frobenius algebra structure (see [FRS02, Kon14]). We use the notation  $A \in \text{Alg}_{E_2}^{\mathcal{C}}(\Omega\mathcal{C})$  to represent the statement that  $A$  is a condensable  $E_2$ -algebra in  $\Omega\mathcal{C}$ .

- Anyons in  $\Omega\mathcal{D}$  are deconfined particles, which are necessarily endowed with a 2-dimensional action of the trivial particle  $1_{\mathbb{1}_{\mathcal{D}}} = A$  in  $\Omega\mathcal{D}$ . Mathematically, it amounts to say that anyons in  $\Omega\mathcal{D}$  are  $E_2$ - $A$ -modules (or local  $A$ -modules) in  $\Omega\mathcal{C}$ . We explain this fact from the perspective of Section 2.3.2.

Consider the physical configuration depicted the right picture in Figure 11. The deconfined particle  $x$  is equipped with  $A$ -actions from both the horizontal directions  $\mu_x^{\rightarrow} : A \otimes^1 x \rightarrow x$  and  $\mu_x^{\leftarrow} : A \otimes^1 x \rightarrow x$  and from the vertical directions  $\mu_x^{\uparrow} : A \otimes^2 x \rightarrow x$  and  $\mu_x^{\downarrow} : x \otimes^2 A \rightarrow x$ . Moreover, this four actions are compatible with each other in the sense that they commute. We give an example of this commutativity in the following commutative diagram:

$$\begin{array}{ccc}
 A \otimes^2 (A \otimes^1 x) & \xrightarrow{\simeq} & A \otimes^1 (A \otimes^2 x) \\
 1_A \otimes^2 \mu_A^{\rightarrow} \downarrow & & \downarrow \mu_A^{\uparrow} \\
 A \otimes^2 x & & A \otimes^1 x \\
 \mu_x^{\uparrow} \searrow & & \swarrow \mu_x^{\rightarrow} \\
 & x & 
 \end{array}$$

where the ‘ $\simeq$ ’ is canonically determined by  $\delta_{A, A, A, 1_{\mathbb{1}_{\mathcal{C}}}}$  (recall (2.3.4)). Now we view  $x, A \otimes^2 x, x \otimes^2 A$  as objects in  $\text{Mod}_A^{E_1}(\Omega\mathcal{C})$  due to their  $E_1$ - $A$ -module (or  $A$ - $A$ -bimodule) structure defined by two mutually commutative actions:  $\mu_A^{\rightarrow}$  and  $\mu_A^{\leftarrow}$ . Then this compatibility of four  $A$ -actions on  $x$  means

that both  $\mu_A^\uparrow : A \otimes^2 x \rightarrow x$  and  $\mu_A^\downarrow : x \otimes^2 A \rightarrow x$  are morphisms in  $\text{Mod}_A^{E_1}(\Omega\mathcal{C})$ . As a consequence, we conclude that  $x \in \text{Mod}_A^{E_1}(\text{Mod}_A^{E_1}(\Omega\mathcal{C}))$ . Such a module  $x$ , i.e. equipped with a 2-dimensional  $A$ -actions, is called an  $E_2$ - $A$ -module. We simply define

$$\text{Mod}_A^{E_2}(\Omega\mathcal{C}) := \text{Mod}_A^{E_1}(\text{Mod}_A^{E_1}(\Omega\mathcal{C})). \quad (4.1.3)$$

It is routine to check that an  $E_2$ -module is precisely a local  $A$ -module in the usual sense [KO02]. We omit details. But the key point is that the following diagram

$$\begin{array}{ccccc}
 & & x \otimes^2 A & & \\
 & \nearrow \simeq & \downarrow \mu_x^\downarrow & \searrow \simeq & \\
 A \otimes^1 x & \xrightarrow{\mu_A^\rightarrow} & x & \xleftarrow{\mu_A^\leftarrow} & x \otimes^1 A \\
 & \nwarrow \simeq & \uparrow \mu_A^\uparrow & \swarrow \simeq & \\
 & & A \otimes^2 x & & 
 \end{array} \quad (4.1.4)$$

where all ' $\simeq$ ' are defined by (2.3.5) or its inverse. The composition of adjacent two such ' $\simeq$ 's defines a braiding as in (2.3.6) and (2.3.7).

6. If the commutativity of the diagram in (4.1.4) does not hold, this non-commutativity causes a strong interference effect around the  $x$ -particle that confines the particle. Such confined particles are necessarily confined to the gapped domain wall  $M^2$  between  $C^3$  and  $D^3$ . As a consequence, particles on the wall  $M^2$  form a multi-fusion 1-category  $\mathcal{M} = \text{RMod}_A(\Omega\mathcal{C})$ , which is fusion if  $D^3$  is simple.

In summary, we obtain the following results.

**Theorem<sup>ph</sup> 4.1.1** ([Kon14]). If an anyon condensation in a 2+1D simple anomaly-free topological order  $C^3$  produces a simple condensed phase  $D^3$  and a gapped domain wall  $M^2$  (see Figure 10 and the picture below).

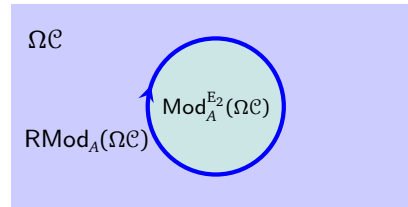

1. The vacuum particle in  $\Omega\mathcal{D}$  can be identified with a simple condensable  $E_2$ -algebra  $A$  in  $\Omega\mathcal{C}$ . Moreover,  $\Omega\mathcal{D}$  consists of all deconfined particles and can be identified with the category  $\text{Mod}_A^{E_2}(\Omega\mathcal{C})$  of  $E_2$ - $A$ -modules (or equivalently, local  $A$ -modules) in  $\mathcal{C}$ , i.e.,  $\Omega\mathcal{D} = \text{Mod}_A^{E_2}(\Omega\mathcal{C})$ .
2. Particles on the wall  $M^2$  include all confined and deconfined particles, and can be identified with the fusion 1-category  $\mathcal{M} = \text{RMod}_A(\Omega\mathcal{C})$ .
3. Anyons in  $\Omega\mathcal{C}$  move to the wall according to the central functor<sup>16</sup>  $-\otimes A : \Omega\mathcal{C} \rightarrow \text{RMod}_A(\Omega\mathcal{C})$  defined by  $x \mapsto x \otimes A$  for all  $x \in \Omega\mathcal{C}$ .
4. Anyons in  $\Omega\mathcal{D}$  move to the wall according to the embedding  $\text{Mod}_A^{E_2}(\Omega\mathcal{C}) \hookrightarrow \text{RMod}_A(\Omega\mathcal{C})$ , then can move out to the  $D^3$ -side freely.

<sup>16</sup>Being a central functor means that  $-\otimes A$  factors through a braided monoidal functor  $g : \Omega\mathcal{C} \rightarrow \text{RMod}_A(\Omega\mathcal{C})$ , i.e. it coincides with the composed functor  $\Omega\mathcal{C} \xrightarrow{g} \mathfrak{Z}_1(\text{RMod}_A(\Omega\mathcal{C})) \xrightarrow{f} \text{RMod}_A(\Omega\mathcal{C})$ , where  $f$  is the forgetful functor.

If  $A$  is also Lagrangian, i.e.  $(\dim A)^2 = \dim(\Omega\mathcal{C})$  [KR09, DMNO13], we have  $\Omega\mathcal{D} = \text{Mod}_A^{\text{E}_2}(\Omega\mathcal{C}) \simeq \text{Vect}$  [DMNO13]<sup>17</sup>. In this case,  $M^2$  is a gapped boundary of  $C^3$  and consists of all confined particles and deconfined particles.

**Remark 4.1.2.** Different from the condensation of 1-codimensional defects (recall Theorem<sup>ph</sup> 3.1.17), such defined anyon condensation process can not be reversed mathematically. More precisely, there is no condensable  $E_2$ -algebra in  $\Omega\mathcal{D}$  such that its condensation in  $D^3$  reproduces  $C^3$ . The simplest way to see this fact is through the following formula of quantum dimensions:

$$\dim \text{Mod}_A^{\text{E}_2}(\Omega\mathcal{C}) = \frac{\dim \Omega\mathcal{C}}{(\dim A)^2}. \quad (4.1.5)$$

Since  $\dim A > 1$  if  $A \neq \mathbb{1}_e$ , a non-trivial particle condensation in  $\Omega\mathcal{C}$  always reduces the quantum dimension. Therefore, there is no way to find a condensable  $E_2$ -algebra in  $\Omega\mathcal{D}$  to reproduce  $\Omega\mathcal{C}$ . On the other hand, the reserved phase transition is always possible physically. This problem is due to the fact that  $\Omega\mathcal{C}$  does not contain all topological defects in  $C^3$ .  $\diamond$

#### 4.1.2 Examples

**Example 4.1.3.** Take  $C^3$  to be the 2+1D  $\mathbb{Z}_2$  topological order, which is realizable by the 2+1D toric code model [Kit03]. In this case, the category of particles in  $C^3$  is  $\Omega\mathcal{C} = \mathfrak{Z}_1(\text{Rep}(\mathbb{Z}_2))$ , which is the Drinfeld center of  $\text{Rep}(\mathbb{Z}_2)$ . It contains four simple anyons  $\mathbb{1}, e, m, f$  with the fusion rule

$$e \otimes e \simeq m \otimes m \simeq f \otimes f \simeq \mathbb{1}, \quad f \simeq e \otimes m \simeq m \otimes e.$$

The double braiding of  $e$  with  $m$  is  $-1$ . The self-braiding of  $e$  and  $m$  are trivial, and the self-braiding of  $f$  is  $-1$ . There are two nontrivial condensable  $E_2$ -algebra  $A_e = \mathbb{1} \oplus e$  and  $A_m = \mathbb{1} \oplus m$ , both of which are Lagrangian.

1. The multiplication of  $A_e$  is given by

$$A_e \otimes A_e = \mathbb{1} \otimes \mathbb{1} \oplus e \otimes e \oplus \mathbb{1} \otimes e \oplus e \otimes \mathbb{1} = (\mathbb{1} \oplus \mathbb{1}) \oplus (e \oplus e) \xrightarrow{(\mathbb{1} \oplus \mathbb{1}) \oplus (\mathbb{1} \oplus \mathbb{1})} \mathbb{1} \oplus e = A_e,$$

and the unit of  $A_e$  is  $\mathbb{1} \xrightarrow{1 \oplus 0} \mathbb{1} \oplus e = A_e$ . It is separable because the following morphism is an  $A_e$ - $A_e$ -bimodule map:

$$A_e = \mathbb{1} \oplus e \xrightarrow{\begin{pmatrix} 1/2 \\ 1/2 \end{pmatrix} \oplus \begin{pmatrix} 1/2 \\ 1/2 \end{pmatrix}} (\mathbb{1} \oplus \mathbb{1}) \oplus (e \oplus e) = \mathbb{1} \otimes \mathbb{1} \oplus e \otimes e \oplus \mathbb{1} \otimes e \oplus e \otimes \mathbb{1} = A_e \otimes A_e.$$

Since  $\dim \mathfrak{Z}_1(\text{Rep}(\mathbb{Z}_2)) = 4$  and  $\dim A_e = 2$ ,  $A_e$  is Lagrangian, i.e.  $\text{Mod}_{A_e}^{\text{E}_2}(\Omega\mathcal{C}) \simeq \text{Vec}$ . Condensing  $A_e$  produces the trivial 2d topological order and a gapped 1d boundary of  $C$ , which is called the rough boundary [BK98]. There are two simple anyons on the rough boundary, which correspond to two simple right  $A_e$ -modules: one is  $A_e$  itself, and the other one is the free module  $M_e := m \otimes A_e = f \otimes A_e$ . The fusion rule is given by  $M_e \otimes_{A_e} M_e \simeq A_e$  and the associator is trivial. Hence  $\text{RMod}_{A_e}(\mathfrak{Z}_1(\text{Rep}(\mathbb{Z}_2))) \simeq \text{Rep}(\mathbb{Z}_2)$ . The right module  $M_e$  is not local because the double braiding of  $e$  and  $m$  is  $-1$ . Thus  $A_e$  itself is the only simple local  $A_e$ -module.

2. Similarly, the multiplication of  $A_m$  is given by

$$A_m \otimes A_m = \mathbb{1} \otimes \mathbb{1} \oplus m \otimes m \oplus \mathbb{1} \otimes m \oplus m \otimes \mathbb{1} = (\mathbb{1} \oplus \mathbb{1}) \oplus (m \oplus m) \xrightarrow{(\mathbb{1} \oplus \mathbb{1}) \oplus (\mathbb{1} \oplus \mathbb{1})} \mathbb{1} \oplus m = A_m,$$

<sup>17</sup>This fact follows immediately from the formula (4.1.5) of quantum dimensions.



and the unit of  $A_m$  is  $\mathbb{1} \xrightarrow{1 \oplus 0} \mathbb{1} \oplus m = A_m$ . Again  $A_m$  is Lagrangian. Condensing  $A_m$  gives the trivial phase and also produces a gapped boundary of the 2+1D  $\mathbb{Z}_2$  topological order, which is called the smooth boundary. There are two simple anyons on the smooth boundary, which correspond to two simple right  $A_m$ -modules: one is  $A_m$  itself, and the other one is the free module  $M_m := e \otimes A_m = f \otimes A_m$ . The fusion rule is given by  $M_m \otimes_{A_m} M_m \simeq A_m$  and the associator is trivial. Hence  $\text{RMod}_{A_m}(\mathfrak{Z}_1(\text{Rep}(\mathbb{Z}_2))) \simeq \text{Vec}_{\mathbb{Z}_2}$ . The right module  $A_m$  is local but  $M_m$  is not.  $\heartsuit$

**Example 4.1.4.** Anyons in the 2+1D twisted  $\mathbb{Z}_2$  topological order (realizable by the double semion model) form the non-degenerate braided fusion 1-category  $\mathfrak{Z}_1(\text{Vec}_{\mathbb{Z}_2}^\omega)$ , which is the Drinfeld center of  $\text{Vec}_{\mathbb{Z}_2}^\omega$ . Here  $\omega \in Z^3(\mathbb{Z}_2; U(1))$  represents the nontrivial cohomology class in  $H^3(\mathbb{Z}_2; U(1)) \simeq \mathbb{Z}_2$ . More explicitly we take  $\omega(1, 1, 1) = -1$  and  $\omega(a, b, c) = 1$  if one of  $a, b, c$  is 0.

There are four simple anyons  $\mathbb{1}, s, \bar{s}, s\bar{s}$  in  $\mathfrak{Z}_1(\text{Vec}_{\mathbb{Z}_2}^\omega)$  with the fusion rule

$$s \otimes s \simeq \bar{s} \otimes \bar{s} \simeq \mathbb{1}, \quad s\bar{s} \simeq s \otimes \bar{s} \simeq \bar{s} \otimes s.$$

The double braiding of  $s$  and  $\bar{s}$  is trivial. The self-braiding of  $s$  is  $i$ , the self-braiding of  $\bar{s}$  is  $-i$ , and the self-braiding of  $s\bar{s}$  is 1.

There is only one nontrivial condensable  $E_2$ -algebra  $A = \mathbb{1} \oplus s\bar{s}$ . The multiplication is given by

$$A \otimes A = \mathbb{1} \otimes \mathbb{1} \oplus s\bar{s} \otimes s\bar{s} \oplus \mathbb{1} \otimes s\bar{s} \oplus s\bar{s} \otimes \mathbb{1} = (\mathbb{1} \oplus \mathbb{1}) \oplus (s\bar{s} \oplus s\bar{s}) \xrightarrow{(1 \ 1) \oplus (1 \ 1)} \mathbb{1} \oplus s\bar{s} = A.$$

Condensing  $A$  produces a gapped boundary of the twisted  $\mathbb{Z}_2$  topological order. There are two simple anyons on this boundary corresponding to two simple right  $A$ -modules: one is  $A$  itself, and the other is the free module  $M_s := s \otimes A = \bar{s} \otimes A$ . The fusion rule is given by  $M_s \otimes_A M_s \simeq A$  but the associator is non-trivial. We have  $\text{RMod}_A(\mathfrak{Z}_1(\text{Vec}_{\mathbb{Z}_2}^\omega)) \simeq \text{Vec}_{\mathbb{Z}_2}^\omega$ . The right module  $M_s$  is not a local module because the double braiding of  $s$  and  $s\bar{s}$  is  $i$ .  $\heartsuit$

**Example 4.1.5.** A 2+1D topological order  $\mathcal{C}^3$  is called *abelian* if for every simple anyon  $x$  there is an anyon  $x^*$  satisfying  $x \otimes x^* \simeq \mathbb{1} \simeq x^* \otimes x$ . Thus the category  $\Omega\mathcal{C}$  of anyons is *pointed* in the sense that every simple object is invertible under the tensor product. In other words, the simple anyons form a finite abelian group under the fusion, denoted by  $G$ . Then for every  $x, y \in G$  we define  $q(x) \in U(1)$  to be the self-braiding of  $x$  and  $b(x, y) \in U(1)$  to be the double braiding of  $x$  with  $y$ . Then we have

$$b(x, y) = \frac{q(xy)}{q(x)q(y)}$$

and  $b: G \times G \rightarrow U(1)$  is a bi-character, i.e.,  $b(xy, z) = b(x, z)b(y, z)$  for all  $x, y, z \in G$ . We say that  $q: G \rightarrow U(1)$  is a *quadratic form* and  $(G, q)$  is a *metric group*. The pointed braided fusion category  $\Omega\mathcal{C}$  is completely determined by the metric group  $(G, q)$  consisting of simple anyons and self-braidings.

The condensable  $E_2$ -algebras in  $\Omega\mathcal{C}$  are classified by subgroups  $H \subseteq G$  such that  $q(x) = 1$  for all  $x \in H$ . Such a subgroup is called an *isotropic subgroup*. We denote the corresponding algebra by  $A_H$ . The multiplication of  $A_H$  is given by

$$A_H \otimes A_H = \bigoplus_{g, h \in H} g \otimes h \xrightarrow{\delta_{gh, k} \cdot \phi(g, h)} \bigoplus_{k \in H} k = A_H$$

for some 2-cochain  $\phi \in C^2(G; U(1))$  such that  $d\phi$  coincides with the associator of simple anyons in  $H$ . Indeed, the associator of simple anyons in  $H$  must be a coboundary by the isotropic condition. All simple right  $A_H$ -modules are free modules, i.e., of the form  $x \otimes A_H$  for some  $x \in G$ . Two simple modules  $x \otimes A_H$  and  $y \otimes A_H$  are isomorphic if and only if  $x$  and  $y$  lie in the same coset of  $H$  in  $G$ , i.e.,  $x^{-1}y \in H$ . The fusion rule simple right  $A_H$ -modules is given by the multiplication of the quotient group  $G/H$ . Therefore, the

fusion category  $\text{RMod}_{A_H}(\Omega\mathcal{C})$  is a pointed fusion category with the group of simple objects being  $G/H$ . The associator can be found in [DS18, Theorem A.1.4]. A simple right  $A_H$ -module  $x \otimes_{A_H}$  is local if and only if  $x$  has trivial double braiding with all  $y \in H$ . We define  $H^\perp := \{x \in G \mid b(x, y) = 1, \forall y \in H\}$ . Then the local  $A_H$ -modules form a pointed modular tensor category with the group of simple objects being  $H^\perp/H$ , and the self-braiding is the restriction of  $q$  on  $H^\perp/H$ . Hence  $A_H$  is Lagrangian if and only if  $H^\perp = H$ . A subgroup  $H \subseteq G$  is called *Lagrangian* if  $H = H^\perp$ . Lagrangian algebras in  $\Omega\mathcal{C}$  one-to-one correspond to Lagrangian subgroups of  $G$ .

Both the 2+1D  $\mathbb{Z}_2$  topological order and twisted  $\mathbb{Z}_2$  topological order are abelian topological orders (see Example 4.1.3 and Example 4.1.4).

1. The  $\mathbb{Z}_2$  topological order corresponds to  $G = \mathbb{Z}_2 \times \mathbb{Z}_2$  and  $q(a, b) = (-1)^{ab}$ . There are two nontrivial isotropic subgroup generated by  $(1, 0) = e$  and  $(0, 1) = m$ , and both of them are Lagrangian.
2. The twisted  $\mathbb{Z}_2$  topological order corresponds to  $G = \mathbb{Z}_2 \times \mathbb{Z}_2$  and  $q(a, b) = i^{a^2 - b^2}$ . The only nontrivial isotropic subgroup is generated by  $(1, 1) = s\bar{s}$  and it is Lagrangian.  $\heartsuit$

**Example 4.1.6.** Let  $G$  be a finite group. Anyons in the 2+1D  $G$ -gauge theory (realizable by the Kitaev's quantum double model [Kit03]) form a non-degenerate braided fusion 1-category  $\mathfrak{Z}_1(\text{Vec}_G) \simeq \mathfrak{Z}_1(\text{Rep}(G))$ , which is the Drinfeld center of  $\text{Vec}_G$  or  $\text{Rep}(G)$ . An object in  $\mathfrak{Z}_1(\text{Vec}_G)$  is a finite-dimensional  $G$ -graded vector space  $V = \bigoplus_{g \in G} V_g$  equipped with a  $G$ -action  $\rho: G \rightarrow \text{GL}(V)$  such that  $\rho(g)(V_h) \subseteq V_{ghg^{-1}}$  for all  $g, h \in G$ . The condensable  $E_2$ -algebras in  $\mathfrak{Z}_1(\text{Vec}_G)$  are completely classified by Davydov in [Dav10b]. We list some examples here.

1. Let  $\text{Fun}(G)$  be the space of  $\mathbb{C}$ -valued functions on  $G$ . We equipped  $\text{Fun}(G)$  with the left translation  $G$ -action:

$$(g \triangleright f)(h) := f(g^{-1}h), \quad g, h \in G, f \in \text{Fun}(G).$$

We can also equip  $\text{Fun}(G)$  with the right translation  $G$ -action, but these two  $G$ -representations are isomorphic. Then we equip  $\text{Fun}(G)$  with the  $G$ -grading concentrating on the trivial degree, i.e.,

$$\text{Fun}(G)_g = \begin{cases} \text{Fun}(G), & g = e, \\ 0, & g \neq e. \end{cases}$$

Then  $\text{Fun}(G)$  can be viewed as an object in  $\mathfrak{Z}_1(\text{Vec}_G)$ . It is also a condensable  $E_2$ -algebra in  $\mathfrak{Z}_1(\text{Vec}_G)$  with the point-wise multiplication:

$$(f \cdot f')(g) := f(g)f'(g), \quad f, f' \in \text{Fun}(G), g \in G.$$

Let  $\delta_g \in \text{Fun}(G)$  be the delta function on  $g \in G$ . Then  $\{\delta_g\}_{g \in G}$  is a basis of  $\text{Fun}(G)$  and the multiplication is given by  $\delta_g \cdot \delta_h = \delta_{g,h}\delta_g$ . The simple right  $\text{Fun}(G)$ -modules are  $\{M_g\}_{g \in G}$  where  $M_g$  is the same as  $\text{Fun}(G)$  as  $G$ -representations but equipped with the different  $G$ -grading:

$$\delta_h \in (M_g)_{hgh^{-1}}, \quad g, h \in G.$$

In particular,  $M_e$  is the regular  $\text{Fun}(G)$ -modules. The fusion rule is  $M_g \otimes_{\text{Fun}(G)} M_h \simeq M_{gh}$  and the fusion category  $\text{RMod}_{\text{Fun}(G)}(\mathfrak{Z}_1(\text{Vec}_G))$  is equivalent to  $\text{Vec}_G$ . The only local  $\text{Fun}(G)$ -module is  $\text{Fun}(G)$  itself. Thus  $\text{Fun}(G) \in \mathfrak{Z}_1(\text{Vec}_G)$  is a Lagrangian algebra.

2. For any subgroup  $H \subseteq G$ , the space  $\text{Fun}(G/H)$  of  $\mathbb{C}$ -valued functions on the coset space  $G/H$  equipped with the left translation  $G$ -action, the trivial  $G$ -grading and the point-wise multiplication is a condensable  $E_2$ -algebra. The modular tensor category of local  $\text{Fun}(G/H)$ -modules is equivalent to  $\mathfrak{Z}_1(\text{Vec}_H)$ , and the fusion category of right  $\text{Fun}(G/H)$ -modules is equivalent to the  $E_1$ -centralizer of  $\text{Vec}_H$  in  $\text{Vec}_G$ . Two algebras  $\text{Fun}(G/H)$  and  $\text{Fun}(G/K)$  are isomorphic if and only if two subgroups  $H$  and  $K$  are conjugate to each other in  $G$ .

3. Let  $\mathbb{C}[G]$  be group algebra of  $G$ . It has a basis  $\{\tau_g\}_{g \in G}$  with the multiplication defined by  $\tau_g \cdot \tau_h = \tau_{gh}$  for all  $g, h \in G$ . We equip  $\mathbb{C}[G]$  with the canonical  $G$ -grading that  $\tau_g \in \mathbb{C}[G]_g$  and the conjugation  $G$ -action that  $g \triangleright \tau_h := \tau_{ghg^{-1}}$ . Then  $\mathbb{C}[G]$  is a condensable  $E_2$ -algebra in  $\mathfrak{Z}_1(\text{Vec}_G)$ . Note that the multiplication of  $\mathbb{C}[G]$  is not commutative in  $\text{Vec}$  when  $G$  is non-abelian, but is commutative in  $\mathfrak{Z}_1(\text{Vec}_G)$  because the self-braiding of  $\mathbb{C}[G]$  in  $\mathfrak{Z}_1(\text{Vec}_G)$  is nontrivial due to the conjugation  $G$ -action. Every simple right  $\mathbb{C}[G]$ -module is isomorphic to  $V \otimes \mathbb{C}[G]$  for some irreducible  $G$ -representation  $V$ , viewed as an object in  $\mathfrak{Z}_1(\text{Vec}_G)$  with the  $G$ -grading concentrating on the trivial degree. The fusion category  $\text{RMod}_{\mathbb{C}[G]}(\mathfrak{Z}_1(\text{Vec}_G))$  is equivalent to  $\text{Rep}(G)$ . The only local  $\mathbb{C}[G]$ -module is  $\mathbb{C}[G]$  itself. Thus  $\mathbb{C}[G] \in \mathfrak{Z}_1(\text{Vec}_G)$  is a Lagrangian algebra.
4. For any  $\alpha \in Z^2(G; U(1))$ , the twisted group algebra  $\mathbb{C}[G, \alpha]$  is generated by  $\{\tau_g\}_{g \in G}$  subject to the relation that  $\tau_g \cdot \tau_h = \alpha(g, h)\tau_{gh}$  for all  $g, h \in G$ . We equip  $\mathbb{C}[G, \alpha]$  with the canonical  $G$ -grading and the conjugation  $G$ -action:

$$g \triangleright \tau_h = \frac{\alpha(g, h)}{\alpha(ghg^{-1}, g)} \tau_{ghg^{-1}}.$$

Then  $\mathbb{C}[G, \alpha] \in \mathfrak{Z}_1(\text{Vec}_G)$  is a Lagrangian algebra and we still have  $\text{RMod}_{\mathbb{C}[G, \alpha]}(\mathfrak{Z}_1(\text{Vec}_G)) \simeq \text{Rep}(G)$ .

5. The Lagrangian algebras in  $\mathfrak{Z}_1(\text{Vec}_G)$  are classified by pairs  $(H, \alpha)$ , where  $H \subseteq G$  is a subgroup and  $\alpha \in Z^2(H; U(1))$  is a 2-cocycle. We denote the corresponding algebra by  $A_{H, \alpha}$ . It is the induced representation of the twisted group algebra:

$$A_{H, \alpha} = \text{Ind}_H^G \mathbb{C}[H, \alpha].$$

Two Lagrangian algebras  $A_{H, \alpha}$  and  $A_{K, \beta}$  are isomorphic if and only if there exists an element  $g \in G$  such that  $gHg^{-1} = K$  and  $[\alpha] = [g^* \beta] \in H^2(H; U(1))$ , where  $g^*: Z^2(K; U(1)) \rightarrow Z^2(H; U(1))$  is the pullback morphism induced by the conjugation of  $g$ .

6. When  $G$  is abelian, we can give a more explicit construction of the Lagrangian algebras  $A_{H, \alpha}$ . In this case  $\mathfrak{Z}_1(\text{Vec}_G)$  is pointed, and the corresponding metric group is  $(G \times \hat{G}, \chi)$ , where  $\hat{G} := \text{Hom}(G; U(1))$  is the dual group of  $G$  and  $\chi(g, \phi) := \phi(g)$ . Given a 2-cocycle  $\alpha \in Z^2(G; U(1))$ , its anti-symmetrization  $\alpha_a$  is defined by

$$\alpha_a(g, h) := \frac{\alpha(g, h)}{\alpha(h, g)}, \quad g, h \in G.$$

The cocycle condition implies that  $\alpha_a: G \times G \rightarrow U(1)$  is a bi-character. We denote the space of anti-symmetric bi-characters on  $G$  by  $\text{Alt}^2(G; U(1))$ . Then  $\alpha \mapsto \alpha_a$  defines a group homomorphism  $Z^2(G; U(1)) \rightarrow \text{Alt}^2(G; U(1))$ . Moreover, if  $\alpha$  is a coboundary, then  $\alpha_a$  is trivial. Hence we get a group homomorphism  $H^2(G; U(1)) \rightarrow \text{Alt}^2(G; U(1))$ . Indeed, this is an isomorphism because every symmetric 2-cocycle must be a coboundary. The Lagrangian subgroups of  $(G \times \hat{G}, \chi)$  are parametrized by  $(H, [\alpha])$ , where  $H \subseteq G$  is a subgroup and  $[\alpha] \in H^2(H; U(1))$ . The corresponding Lagrangian subgroup of  $(G \times \hat{G}, \chi)$  is

$$L_{H, [\alpha]} := \{(h, \phi) \in G \times \hat{G} \mid h \in H, \phi|_H = \alpha_a(h, -)\}.$$

This gives all Lagrangian algebras in  $\mathfrak{Z}_1(\text{Vec}_G)$ . ♡

**Example 4.1.7.** A very classical example of anyon condensation is the condensation from double Ising to toric code. It was first studied by Bais and Slingerland in [BS09]. The complete details of this example has been worked out in [CJKYZ20]. We briefly summarize the result below. The object

$$A = \mathbb{1} \boxtimes \mathbb{1} \oplus \psi \boxtimes \psi \in \Omega\mathcal{J}s \boxtimes \Omega\mathcal{J}s^{\text{op}} \simeq \mathfrak{Z}_1(\Omega\mathcal{J}s)$$

has a canonical structure of a condensable  $E_2$ -algebra in  $\mathfrak{Z}_1(\Omega\mathcal{J}s)$ . It can be explicitly defined (see for example [CJKYZ20, Example 7]). There are six simple right  $A$ -modules in  $\Omega\mathcal{J}s$ :

$$\begin{aligned} 1 &:= A, & e &:= (\sigma \boxtimes \sigma), & m &:= (\sigma \boxtimes \sigma)^{\text{tw}}, & f &:= (\psi \boxtimes \mathbb{1}) \otimes A, \\ \chi_+ &:= (\mathbb{1} \boxtimes \sigma) \otimes A, & \chi_- &:= (\sigma \boxtimes \mathbb{1}) \otimes A, \end{aligned} \quad (4.1.6)$$

among which  $1, e, m, f$  are  $E_2$ - $A$ -modules (or local  $A$ -modules) and  $\chi_{\pm}$  are non-local  $A$ -modules. Moreover, the fusion and braiding structures on  $1, e, m, f$  are the same as those on the 4 simple anyons in the 2+1D toric model, i.e.  $\text{Mod}_A^{\mathbb{E}_2}(\mathfrak{Z}_1(\Omega\mathcal{J}s)) \simeq \mathfrak{Z}_1(\text{Rep}(\mathbb{Z}_2))$ .  $\heartsuit$

**Remark 4.1.8.** Some examples of anyon condensations from para-fermions to finite gauge theories can be found in [LY23].  $\diamond$

### 4.1.3 Geometric approach

Now we take a geometric approach towards to the anyon condensation theory in (2+1)D. The physical or geometric intuitions behind it naturally generalize to higher dimensions.

The setup is the same one given in Figure 10. Recall that the anyon condensation is determined by a condensable  $E_2$ -algebra  $A$  in  $\Omega\mathcal{C}$ , and we have  $\Omega\mathcal{D} \simeq \text{Mod}_A^{\mathbb{E}_2}(\Omega\mathcal{C})$ ,  $\Omega_m\mathcal{M} \simeq \text{RMod}_A(\Omega\mathcal{C})$ . We show that the algebra  $A$  can be constructed geometrically. We start from recalling a known result.

**Lemma 4.1.9.** Let  $\Omega\mathcal{C}, \Omega\mathcal{D}$  be non-degenerate braided fusion categories and  $\Omega_m\mathcal{M}$  a closed multi-fusion  $\Omega\mathcal{C}$ - $\Omega\mathcal{D}$ -bimodule. We have canonical monoidal equivalences

$$\Omega_m\mathcal{M} \boxtimes_{\Omega\mathcal{D}} \Omega_m\mathcal{M}^{\text{rev}} \xrightarrow{\simeq} \text{Fun}_{\Omega\mathcal{C}}(\Omega_m\mathcal{M}, \Omega_m\mathcal{M}), \quad x \boxtimes_{\Omega\mathcal{D}} y \mapsto x \otimes - \otimes y \quad (4.1.7)$$

$$\Omega_m\mathcal{M} \boxtimes_{\Omega\mathcal{C}} \Omega_m\mathcal{M}^{\text{rev}} \xrightarrow{\simeq} \text{Fun}_{\Omega\mathcal{D}}(\Omega_m\mathcal{M}, \Omega_m\mathcal{M}), \quad x \boxtimes_{\Omega\mathcal{C}} y \mapsto x \otimes - \otimes y. \quad (4.1.8)$$

This Lemma says that if we squeeze  $\Omega_m\mathcal{M}$  and  $\Omega_m\mathcal{M}^{\text{rev}}$  along  $\Omega\mathcal{C}$  in the following physical configuration,

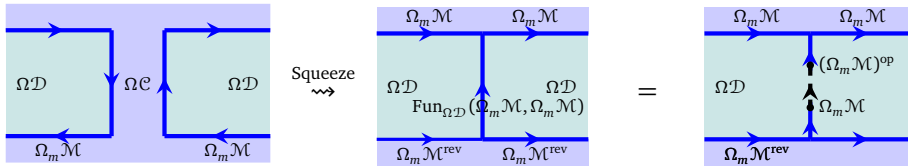

we obtain a domain wall whose particles form the fusion 1-category  $\text{Fun}_{\Omega\mathcal{D}}(\Omega_m\mathcal{M}, \Omega_m\mathcal{M})$ . The “=” is due to the equivalence  $\text{Fun}_{\Omega\mathcal{D}}(\Omega_m\mathcal{M}, \Omega_m\mathcal{M}) \simeq \Omega_m\mathcal{M}^{\text{op}} \boxtimes_{\Omega\mathcal{D}} \Omega_m\mathcal{M}$ , which maps  $\text{id}_{\Omega_m\mathcal{M}}$  to  $\int_{x \in \mathcal{M}}^{\Omega\mathcal{D}} x^R \boxtimes_{\Omega\mathcal{D}} x$ . The notation  $\int_{x \in \mathcal{M}}^{\Omega\mathcal{D}}$  is called an ‘ $\Omega\mathcal{D}$ -module end’ and is explained in Example A.2.12 in Appendix A.2. The domain wall  $\text{Fun}_{\Omega\mathcal{D}}(\Omega_m\mathcal{M}, \Omega_m\mathcal{M})$  without specifying a particle on it can be understood as the particle is trivial. Then we obtain the following physically equivalent configurations.

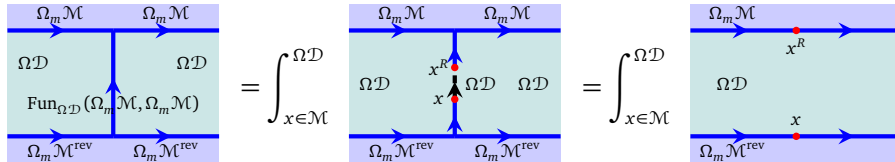

Now we show that the condensable  $E_2$ -algebra  $A$  can be constructed geometrically as a  $D^3$ -bubble in  $C^3$  as illustrated below.

$$A = \begin{array}{c} \square \\ \uparrow \\ \Omega\mathcal{D} \\ \square \\ \Omega\mathcal{C} \end{array}$$

Viewed from far away, the bubble shrink to a particle in  $\Omega\mathcal{C}$ , it was shown in [AKZ17] that this particle is precisely  $A$  as an object in  $\Omega\mathcal{C}$ . However, the algebraic structure on the bubble has not been constructed. We do that now. The multiplication morphisms  $\mu_A : A \otimes A \rightarrow A$  can be defined geometrically by fusing two such bubbles into one bubble as follows.

$$A \otimes A = \begin{array}{c} \square \quad \square \\ \uparrow \quad \uparrow \\ \Omega\mathcal{D} \quad \Omega\mathcal{D} \\ \square \quad \square \\ \Omega\mathcal{C} \end{array} = \int_{x \in \Omega_m \mathcal{M}}^{\Omega\mathcal{C}} \begin{array}{c} x^R \\ \square \\ \Omega\mathcal{D} \\ \square \\ x \\ \Omega\mathcal{C} \end{array} \xrightarrow{\mu_A} \begin{array}{c} \square \\ \uparrow \\ \Omega\mathcal{D} \\ \square \\ \Omega\mathcal{C} \end{array} \quad (4.1.9)$$

where the arrow is defined by the canonical projection  $\int_{x \in \Omega_m \mathcal{M}}^{\Omega\mathcal{C}} x^R \boxtimes_{\Omega\mathcal{D}} x \rightarrow 1_m \boxtimes_{\Omega\mathcal{D}} 1_m$ . In the rest of this subsection, we show that this algebraic structure on  $A$  coincides with that of  $[1_m, 1_m]_{\Omega\mathcal{C}}$ . We first recall an old result but give a new proof.

**Lemma<sup>ph</sup> 4.1.10** ([AKZ17]). For  $d \in \Omega\mathcal{D}$  and  $y \in \Omega_m \mathcal{M}$ , the following bubble defines a particle in  $\Omega\mathcal{C}$  given by  $[1_m, d \odot y]_{\Omega\mathcal{C}} \in \Omega\mathcal{C}$ .

$$[1_m, d \odot y]_{\Omega\mathcal{C}} = \begin{array}{c} \Omega\mathcal{C} \\ \square \\ \uparrow \\ \square \\ \uparrow \\ \bullet \quad \bullet \\ d \quad y \\ \square \\ \Omega\mathcal{C} \end{array}$$

*Proof.* First squeeze the bubble vertically to a line then horizontally to a point. We obtain

$$\begin{array}{c} \Omega\mathcal{C} \\ \square \\ \uparrow \\ \square \\ \uparrow \\ \bullet \quad \bullet \\ d \quad y \\ \square \\ \Omega\mathcal{C} \end{array} = \begin{array}{c} \Omega\mathcal{C} \\ 1_m \xrightarrow{\quad} d \odot y \\ \text{Fun}_{\Omega\mathcal{C}}(\Omega_m \mathcal{M}, \Omega_m \mathcal{M}) \\ \square \end{array} = \begin{array}{c} \Omega\mathcal{C} \\ \bullet \\ [1_m, d \odot y]_{\Omega\mathcal{C}} \end{array}$$

The second “=” is due to the monoidal equivalence  $(\Omega_m \mathcal{M})^{\text{op}} \boxtimes_{\mathcal{E}} \Omega_m \mathcal{M} \simeq \text{Fun}_{\mathcal{E}}(\Omega_m \mathcal{M}, \Omega_m \mathcal{M}) \simeq \Omega\mathcal{C}$ , which maps  $1_m \boxtimes_{\mathcal{E}} y$  to

$$[-, 1_m]_{\mathcal{E}}^R \odot y \mapsto \int_{x \in \Omega_m \mathcal{M}}^{\mathcal{E}} [x, [1_m]_{\mathcal{E}}^R \odot y]_{\Omega\mathcal{D}} \simeq \int_{\mathcal{E}}^{x \in \Omega_m \mathcal{M}} [x, 1_m] \odot x, y]_{\Omega\mathcal{C}} \simeq [1_m, y]_{\Omega\mathcal{C}}. \quad \square$$

**Theorem 4.1.11.** The algebraic structure on  $A$  defined in (4.1.9) coincides with that on  $[1_m, 1_m]_{\Omega\mathcal{C}}$ .

*Proof.* We only sketch the idea of the proof and leave the remaining details to Appendix A.1. The algebraic structure on the internal hom  $[1_m, 1_m]_{\Omega\mathcal{C}}$  follows from the universal property of the internal hom. This universal construction, however, is not physical or geometrical. In order to find a proof, it is enough to find a geometric construction of the algebraic structure on  $[1_m, 1_m]_{\Omega\mathcal{C}}$  and compare it with (4.1.9).

The idea is that we rewrite the internal hom as follows:

$$[1_m, 1_m]_{\Omega\mathcal{C}} = [1_m, -]_{\Omega\mathcal{C}}(1_m) = L_2^R(1_m),$$

where  $L_2^R = [1_m, -]_{\Omega\mathcal{C}}$  is precisely the right adjoint of the functor  $L_2 := - \odot 1_m : \Omega\mathcal{C} \rightarrow \Omega_m\mathcal{M}$  by the definition of internal hom (see Definition 3.1.10). Note that  $L$  has a clear physical meaning, i.e., moving bulk anyons to the wall, and is called bulk-to-wall map. Its right adjoint functor  $L^R$  also has a clear physical meaning as a physical process of creating a bubble from the wall  $M^2$  to the bulk of  $C^3$  as illustrated below.

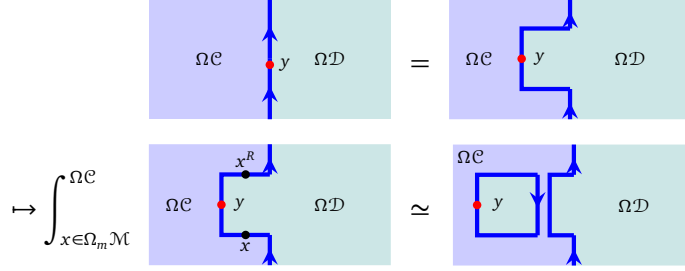

The algebraic structure on  $[1_m, 1_m]_{\Omega\mathcal{C}} = L^R(1_m)$  is defined in terms of the defining data of the adjoint pair  $L_2$  and  $L_2^R$  as follows.

$$L_2^R(1_m) \otimes L_2^R(1_m) \rightarrow L_2^R L_2(L_2^R(1_m) \otimes L_2^R(1_m)) \simeq L_2^R(L_2 L_2^R(1_m) \otimes L_2 L_2^R(1_m)) \rightarrow L_2^R(1_m). \quad (4.1.10)$$

It remains to show that the morphism (4.1.10) coincides with the one defined in (4.1.9). We postpone it to Appendix A.1.  $\square$

**Remark 4.1.12.** It is worth mentioning that, all the above analysis do not rely on the fact that  $D^3$  is obtained from  $C^3$  via a particle condensation, so it applies to any Witt equivalent phases. In general cases, the algebra we obtained by creating  $D^3$ -bubbles (taking internal homs) is a condensable algebra in  $\Omega\mathcal{C}$ , but condensing this algebra to do result in the original phase  $D^3$ . For example, in the same setting as Figure 10, we create a  $C^3$ -bubble in  $D^3$ , which is the trivial particle in  $\Omega\mathcal{D}$ , i.e.,

Clearly, condensing this algebra (vacuum in  $\Omega\mathcal{D}$ ) does not produce  $C^3$  as the condensed phase.  $\diamond$

**Remark 4.1.13.** Rolling up the domain wall  $M^2$  (to the  $D^3$ -side) over a full circle creates a bubble in  $C^3$ , which turns out to be a condensable  $E_2$ -algebra in  $\Omega\mathcal{C}$ . This physical process naturally generalizes to higher dimension cases, in which one can roll up potentially higher codimensional defects over higher dimensional spheres or other manifolds. We will use this intuition without a proof. To write down such a proof explicitly is a non-trivial task. However, it should be parallel to the discussion in this subsection.  $\diamond$

## 4.2 Condensations of 2-codimensional defects in $n+1D$

In this subsection, we discuss the theory of the condensations of 2-codimensional topological defects in  $n+1D$  anomaly-free simple topological orders. The setup of the question remains the same as the 2+1D cases. More precisely, consider a condensation of 2-codimensional topological defect occurring in an  $n+1D$  anomaly-free simple topological order  $C^{n+1}$ . It creates a new simple topological order  $D^{n+1}$ , which is also anomaly-free, and a gapped domain wall  $M^n$  as depicted in Figure 12.

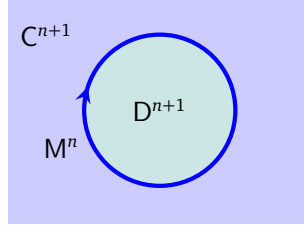
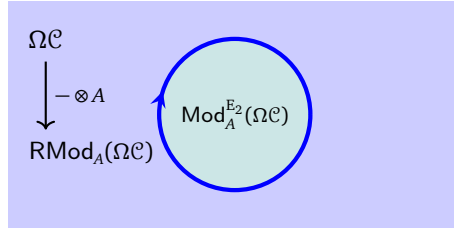

Figure 12: a condensation of 2-codimensional topological defect in  $C^{n+1}$

#### 4.2.1 General theory

The bootstrap analysis in  $n+1$ D is possible and is similar to the 2+1D cases. However, it becomes much harder in higher dimensions due to the complexity of the higher coherence relations. Instead, we use the geometric intuition of anyon condensation in an anomaly-free 2+1D topological orders, which generalizes to that of condensations of 2-codimensional topological defects in an anomaly-free  $n+1$ D topological order tautologically.

**Theorem<sup>ph</sup> 4.2.1.** If an  $n+1$ D anomaly-free simple topological order  $D^{n+1}$  and a gapped domain wall  $M^n$  are obtained from an anomaly-free and simple  $C^{n+1}$  via a condensation of 2-codimensional topological defect (see Figure 12 and the picture below).



1. The trivial 2-codimensional topological defect  $1_{\mathbb{1}_D}$  in  $\Omega D$  can be identified with a simple condensable  $E_2$ -algebra  $A$  in  $\Omega\mathcal{C}$ . Moreover,  $\Omega D$  consists of all deconfined topological defects of codimension 2 and can be identified with the category  $\text{Mod}_A^{E_2}(\Omega\mathcal{C})$  of  $E_2$ - $A$ -modules (or equivalently, local  $A$ -modules) in  $\mathcal{C}$ , i.e.,  $\Omega D = \text{Mod}_A^{E_2}(\Omega\mathcal{C})$ .
2. Topological defects on the wall  $M^n$  include all confined and deconfined 1-codimensional defects, and can be identified with the fusion 1-category  $\text{RMod}_A(\Omega\mathcal{C})$ .
3. Defects in  $\Omega\mathcal{C}$  move to the wall according to the central functor<sup>18</sup>  $L_2 := -\otimes A: \Omega\mathcal{C} \rightarrow \text{RMod}_A(\Omega\mathcal{C})$  defined by  $x \mapsto x \otimes A$  for all  $x \in \Omega\mathcal{C}$ .
4. Defects in  $\Omega D$  move to the wall according to the canonical embedding  $R_2: \text{Mod}_A^{E_2}(\Omega\mathcal{C}) \hookrightarrow \text{RMod}_A(\Omega\mathcal{C})$ , then they can move out to the  $D^{n+1}$ -side freely.

The condensable  $E_2$ -algebra  $A$  in  $\Omega\mathcal{C}$  is called Lagrangian if  $\text{Mod}_A^{E_2}(\Omega\mathcal{C}) \simeq \text{Vect}$ . In this case,  $M^n$  becomes a gapped boundary of  $C^{n+1}$  and consists of all confined and deconfined defects.

<sup>18</sup>Being a central functor means that  $-\otimes A$  factors through a braided monoidal functor  $g: \Omega\mathcal{C} \rightarrow \mathfrak{Z}_1(\text{RMod}_A(\Omega\mathcal{C}))$ , i.e. it coincides with the composed functor  $\Omega\mathcal{C} \xrightarrow{g} \mathfrak{Z}_1(\text{RMod}_A(\Omega\mathcal{C})) \xrightarrow{f} \text{RMod}_A(\Omega\mathcal{C})$ , where  $f$  is the forgetful functor.

**Remark 4.2.2.** If a topological defect is confined (resp. deconfined), then its condensation descendants is also confined (resp. deconfined). This results seems physically natural. A rigorous proof of the  $n = 2$  case was given in [DX23]. We will provide a mathematical proof when we develop the theory of separable higher algebras elsewhere.  $\diamond$

**Theorem<sup>ph</sup> 4.2.3.** By the folding trick, we obtain the following boundary-bulk relation:

$$\Omega\mathcal{C} \boxtimes \text{Mod}_A^{E_2}(\mathcal{C})^{\text{op}} \simeq \mathfrak{Z}_1(\text{RMod}_A(\Omega\mathcal{C})).$$

It result is equivalent to another result:

$$\text{Mod}_A^{E_2}(\mathcal{C})^{\text{op}} \simeq \mathfrak{Z}_2(\Omega\mathcal{C}, \mathfrak{Z}_1(\text{RMod}_A(\Omega\mathcal{C}))), \quad (4.2.1)$$

which is ready to be generalized to higher algebras and higher representations (see Corollary 5.2.7).

Let  $C^{n+1}$  and  $D^{n+1}$  be any two  $n+1$ D (potentially anomalous and composite) topological orders connected by a gapped domain wall  $M^n = (\mathcal{M}, m)$ , where  $\mathcal{M}$  is a separable  $n$ -category and a  $\mathcal{C}$ - $\mathcal{D}$ -bimodule and  $m$  is an object in  $\mathcal{M}$  represents a distinguished gapped wall condition.

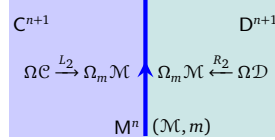

There is a canonical functor  $L_2 : \Omega\mathcal{C} \rightarrow \Omega_m\mathcal{M}$  from the category  $\Omega\mathcal{C}$  of topological defects of codimension 2 and higher in  $C^{n+1}$  to that of topological defects on  $M^n$ , which is defined simply by moving topological defects in  $C^{n+1}$  onto  $M^n$ . Similarly, there is also a canonical functor  $R_2 : \Omega\mathcal{D} \rightarrow \Omega_m\mathcal{M}$ . It is clear that these two functors are both monoidal (i.e. preserving the fusion product). We denote their right adjoint functor by  $L_2^R$  and  $R_2^R$ , respectively.

By rolling up the right half (i.e.  $M^n$  and  $D^{n+1}$ ) in the spatial dimension, we obtain a solid cylinder  $D^1 \times \mathbb{R}^{n-1}$  with the interior filled with the  $D^{n+1}$ -phase and the boundary  $S^1 \times \mathbb{R}^{n-1}$  cylinder decorated by  $M^n$ . Similarly, we can roll up the left half to obtain a solid cylinder in  $D^{n+1}$ -phase as illustrated below.

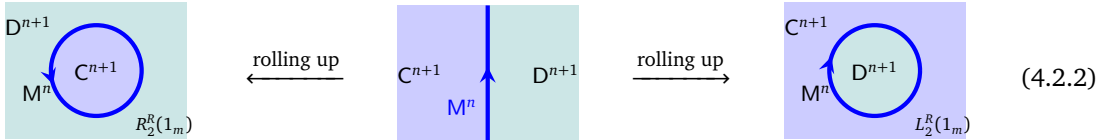

Viewed from far away, these two solid cylinders become two 2-codimensional topological defects in  $C^{n+1}$  and  $D^{n+1}$ , respectively. The next result tells us how to compute these defects.

**Theorem<sup>ph</sup> 4.2.4.** Such obtained 2-codimensional topological defects in  $C^{n+1}$  and  $D^{n+1}$  are given by

$$L_2^R(1_m) = [1_m, 1_m]_{\Omega\mathcal{C}} \in \Omega\mathcal{C}, \quad R_2^R(1_m) = [1_m, 1_m]_{\Omega\mathcal{D}} \in \Omega\mathcal{D}, \quad (4.2.3)$$

both of which are condensable  $E_2$ -algebra in  $\Omega\mathcal{C}$  and  $\Omega\mathcal{D}$ , respectively. Moreover, all condensable  $E_2$ -algebra in  $\Omega\mathcal{C}$  can be obtained in this way by properly choosing  $D^{n+1}$  and  $M^n$ .

*Proof.* We sketch a proof. Note that  $\Omega\mathcal{C}$  acts on  $\Omega_m\mathcal{M}$  in the obvious way. We denote the action functor by  $\odot : \Omega\mathcal{C} \times \Omega_m\mathcal{M} \rightarrow \Omega_m\mathcal{M}$ . Therefore, the internal hom is well defined [KZ22b, Proposition 3.27]. Moreover, the action  $\odot$  preserves the fusion product, i.e.  $\odot$  is monoidal. By the universal property of the center, this action factors through the canonical action  $\mathfrak{Z}_1(\Omega_m\mathcal{M}) \times \Omega_m\mathcal{M} \rightarrow \Omega_m\mathcal{M}$ . Equivalently, 2-codimensional topological defects in  $C^{n+1}$  can be half-braided with 1-codimensional topological defects



in  $M^n$ . This half-braiding structure upgrades the action  $\odot$  to an action  $\odot : \text{Alg}_{E_1}^c(\Omega\mathcal{C}) \times \text{Alg}_{E_1}^c(\Omega_m\mathcal{M}) \rightarrow \text{Alg}_{E_1}^c(\Omega_m\mathcal{M})$ . As a consequence, the internal hom  $[1_m, 1_m]_{\Omega\mathcal{C}} \in \text{Alg}_{E_1}^c(\text{Alg}_{E_1}^c(\Omega\mathcal{C})) = \text{Alg}_{E_2}^c(\Omega\mathcal{C})$ .

For  $A \in \text{Alg}_{E_2}^c(\Omega\mathcal{C})$ , let  $D^{n+1}$  and  $M^n$  be the condensed phase and gapped domain wall obtained by condensing  $A$  (as in Theorem<sup>ph</sup> 4.2.1), i.e.,  $\Omega_m\mathcal{M} = \text{RMod}_A(\Omega\mathcal{C})$  and  $\Omega\mathcal{D} = \text{Mod}_A^{E_2}(\Omega\mathcal{C})$ . In this case,  $L_2 = - \otimes A$  and  $L_2^R = [A, -]$ , where  $[A, -]$  is the forgetful functor  $f : \text{RMod}_A(\Omega\mathcal{C}) \rightarrow \Omega\mathcal{C}$ . Therefore, in this case, we obtain

$$L_2^R(1_m) = [1_m, 1_m]_{\Omega\mathcal{C}} = A \in \Omega\mathcal{C}; \quad R_2^R(1_m) = [1_m, 1_m]_{\Omega\mathcal{D}} = 1_{\mathbb{1}_{\mathcal{D}}} \in \Omega\mathcal{D}. \quad (4.2.4)$$

Therefore, all condensable  $E_2$ -algebras in  $\Omega\mathcal{C}$  arise in this way.  $\square$

In general, condensing  $L_2^R(1_m)$  in  $\Omega\mathcal{C}$  does not give  $\Omega\mathcal{D}$ , and condensing  $R_2^R(1_m)$  in  $\Omega\mathcal{D}$  does not give  $\Omega\mathcal{C}$ . We give two examples.

1. Let  $C^3$  be the  $\mathbb{Z}_2$  topological order and  $D^3$  be the double semion topological order and  $M^2$  be any gapped domain wall. Then  $L_2^R(1_m) = 1_{\mathbb{1}_e}$  and  $R_2^R(1_m) = 1_{\mathbb{1}_{\mathcal{D}}}$  are both trivial.
2. When  $C^{n+1}$  and  $D^{n+1}$  are both anomaly-free and simple, if  $D^{n+1}$  and  $M^n$  are obtained from  $C^{n+1}$  by condensing a non-trivial condensable  $E_2$ -algebra  $A \in \Omega\mathcal{C}$ , then this condensation is not reversible. Namely, condensing  $R_2^R(1_m) = 1_{\mathbb{1}_{\mathcal{D}}} \in \Omega\mathcal{D}$  does not give the  $C^{n+1}$ -phase.

This phenomenon is very different from the condensation of 1-codimensional topological defects (recall Theorem<sup>ph</sup> 3.2.9). The reason is that all 1-codimensional topological defects are missing from  $\Omega\mathcal{C}$ . If we use  $A \in \Omega\mathcal{C}$  to define a condensed 1-codimensional topological defects, denoted by  $\Sigma A$  in  $\mathcal{C}$ , then the condensation of  $\Sigma A$  in  $\mathcal{C}$  is reversible. We discuss this phenomenon in Section 5.1.

A special case is very important to us. If  $D^{n+1} = \mathbf{1}^{n+1}$  is obtained from  $C^{n+1}$  by condensing  $A \in \text{Alg}_{E_2}^c(\Omega\mathcal{C})$ , then  $A$  is a Lagrangian algebra in  $\Omega\mathcal{C}$ ,  $M^n$  is a gapped boundary of  $C^{n+1}$  (i.e.  $C^{n+1}$  is non-chiral). Therefore, we obtain a map:

$$\{\text{Lagrangian algebras in } \Omega\mathcal{C}\} \xrightarrow{\phi} \{\text{gapped boundaries of } C^{n+1}\}.$$

In this case,  $C^{n+1} = Z(M)^{n+1}$  catches all the information of the gravitational anomaly of the gapped boundary  $M^n$  [KW14, KWZ15]. The non-degenerate braided fusion  $(n-1)$ -category  $\Omega\mathcal{C}$ , as the center of  $\Omega_m\mathcal{M}$ , is maximal (or universal) in a precise sense. Therefore, the internal hom  $[1_m, 1_m]_{\Omega\mathcal{C}}$  is again maximal by the universal property of the internal hom. Therefore, it is natural to expect that it can recover  $M^n$ . We state the following natural result without giving a proof.

**Theorem<sup>ph</sup> 4.2.5.** When  $C^{n+1}$  is anomaly-free and simple,  $\phi$  is bijective and its inverse  $\phi^{-1}$  is defined by

$$M^n = (\mathcal{M}, m) \mapsto L_2^R(1_m) = [1_m, 1_m]_{\Omega\mathcal{C}}. \quad (4.2.5)$$

**Remark 4.2.6.** In a general situation, two arbitrary anomaly-free simple  $n+1$ D topological orders  $C^{n+1}$  and  $D^{n+1}$  connected by a gapped domain wall. The information of  $M^n$  can be encoded in the internal hom  $[1_m, 1_m]_{\Omega\mathcal{C} \boxtimes \Omega\mathcal{D}^{\text{op}}}$ , which is a Lagrangian algebra in  $\mathfrak{F}_1(\Omega_m\mathcal{M})$ . While the following two condensable  $E_2$ -algebras:

$$[1_m, 1_m]_{\Omega\mathcal{C}} = [1_m, 1_m]_{\Omega\mathcal{C} \boxtimes \Omega\mathcal{D}^{\text{op}}} \cap \Omega\mathcal{C} \quad \text{and} \quad [1_m, 1_m]_{\Omega\mathcal{D}} = [1_m, 1_m]_{\Omega\mathcal{C} \boxtimes \Omega\mathcal{D}^{\text{op}}} \cap \Omega\mathcal{D}^{\text{op}}$$

encode only some incomplete information of the domain wall  $M^n$ .  $\diamond$

**Remark 4.2.7.** Both the domain and the codomain of  $\phi$  are infinite sets for  $n > 2$ . For example, stacking a gapped boundary of  $C^{n+1}$  with an anomaly-free  $n$ D topological order gives another gapped boundaries.  $\diamond$

Since the rolling-up process plays a very important role in our theory, we would like to introduce some useful notations that are inspired by the theory of factorization homology (see for example [Lur17, AF15, AFT17, AFT16, AFR18, AKZ17, AF20]). Note that, in the first picture in (4.2.2), one can view  $\Omega\mathcal{C}$  as observables living in the interior of the solid cylinder  $D^2 \times \mathbb{R}^{n-2}$  (in spatial dimension), i.e.,

$$\text{Obs}(\mathring{D}^2 \times \mathbb{R}^{n-2}) = \Omega\mathcal{D}.$$

Since  $\Omega\mathcal{C}$  is an  $E_2$ -algebra in  $n\text{Vec}$ . It makes perfect sense to integrate it over the 2-manifold  $\mathring{D}^2$ . Similarly,  $\Omega_m\mathcal{M}$  describes the observable living on the boundary of the solid cylinder, i.e.,

$$\text{Obs}(\partial D^2 \times \mathbb{R}^{n-2}) = \Omega_m\mathcal{M}.$$

Since  $\Omega_m\mathcal{M}$  is monoidal, i.e. an  $E_1$ -algebra in  $n\text{Vec}$ , it makes perfect sense to integrate it along the 1-manifold  $\partial D^2$ . By integrating all the observables on the solid cylinder, we obtain

$$\begin{aligned} \text{Obs}(D^2 \times \mathbb{R}^{n-2}) &= \int_{D^2 \times \mathbb{R}^{n-2}} (\text{Obs}(\mathring{D}^2 \times \mathbb{R}^{n-2}), \text{Obs}(\partial D^2 \times \mathbb{R}^{n-2})) \\ &= \int_{D^2 \times \mathbb{R}^{n-2}} (\Omega\mathcal{D}|_{\mathring{D}^2 \times \mathbb{R}^{n-2}}, \Omega_m\mathcal{M}|_{\partial D^2 \times \mathbb{R}^{n-2}}) = (\Omega\mathcal{C}, L_2^R(1_m)). \end{aligned}$$

However, from the physical point of view, choosing  $\Omega\mathcal{D}$  and  $\Omega_m\mathcal{M}$  instead of the complete data  $\mathcal{D}$  and  $(\mathcal{M}, m)$  is based on certain conventions of throwing away certain topological defects. Although it is possible to make the convention or rule explicitly, it is much more convenient to simply set:

$$\text{Obs}(\mathring{D}^2 \times \mathbb{R}^{n-2}) := \mathcal{D}, \quad \text{Obs}(\partial D^2 \times \mathbb{R}^{n-2}) := (\mathcal{M}, m).$$

Then we have

$$\text{Obs}(D^2 \times \mathbb{R}^{n-2}) = \int_{D^2 \times \mathbb{R}^{n-2}} (\mathcal{D}|_{\mathring{D}^2 \times \mathbb{R}^{n-2}}, (\mathcal{M}, m)|_{\partial D^2 \times \mathbb{R}^{n-2}}) = (\mathcal{C}, \mathbb{1}_{\mathcal{C}}, L_2^R(1_m)), \quad (4.2.6)$$

where the triple  $(\mathcal{C}, \mathbb{1}_{\mathcal{C}}, L_2^R(1_m))$ , i.e., a separable  $n$ -category  $\mathcal{C}$ , together with a distinguished 0-morphism  $\mathbb{1}_{\mathcal{C}} \in \mathcal{C}$  and a distinguished 1-morphism  $L_2^R(1_m) \in \Omega_{\mathbb{1}_{\mathcal{C}}}\mathcal{C}$ , can be viewed as an  $E_{-1}$ -algebra object in  $(n+1)\text{Vec}$  [KWZ15].

**Remark 4.2.8.** Note that there are extra consistency in our convention in (4.2.6). More precisely,  $\mathcal{D} \in \text{Alg}_{E_1}^{\mathcal{C}}((n+1)\text{Vec})$  and  $(\mathcal{M}, m) \in \text{Alg}_{E_0}^{\mathcal{C}}((n+1)\text{Vec})$ . Integrating them over a 2-manifold and a 1-manifold, respectively, amount to reduce the level of commutativity by 2 and 1, respectively. As a consequence, both cases give  $E_{-1}$ -algebras after the integration. More generally, one can view

$$(\mathcal{A}, a_1, a_2, a_3, \dots, a_k) \in \text{Alg}_{E_{-k+1}}^{\mathcal{C}}((n+1)\text{Vec}),$$

where  $\mathcal{A}$  is a separable  $n$ -category,  $a_1 \in \mathcal{A}$  is a 0-morphism,  $a_2 \in \Omega_{a_1}\mathcal{A}$  is a 1-morphism,  $a_3 \in \Omega_{a_2}(\Omega_{a_1}\mathcal{A})$  is a 2-morphism,  $a_k \in \Omega_{a_{k-1}}(\dots\Omega_{a_2}(\Omega_{a_1}\mathcal{A})\dots)$  is a  $(k-1)$ -morphism [KWZ15]. This notation is quite useful when we study the integration of  $\mathcal{D}$  and  $(\mathcal{M}, m)$  over  $D^k \times \mathbb{R}^{n-k}$  in next section. We suspect that our theory is related to the so-called  $\beta$ -version of factorization homology [AFT17, AFT16, AFR18].  $\diamond$

**Remark 4.2.9.** The notations introduced in (4.2.6) are used later. Although we introduced the integral notation heuristically, it turns out that this integral has a mathematical foundation, which is called factorization homology [Lur17, AF15] (see [AF20] for a recent review). We hope to clarify this point in future publications.  $\diamond$

### 4.2.2 Condensations in $\mathbf{1}^{n+1}$

When  $C^{n+1} = D^{n+1} = \mathbf{1}^{n+1}$ , a gapped domain wall  $M^n$  is simply an anomaly-free  $nD$  topological order  $M^n = (\mathcal{M}, m)$ , where  $\mathcal{M}$  is an indecomposable separable  $n$ -category and  $m$  is a distinguished object in  $\mathcal{M}$  that labels the anomaly-free  $nD$  topological order. The multi-fusion  $(n-1)$ -category  $\Omega_m \mathcal{M}$  is the category of topological defects in the  $nD$  topological order labeled by  $m$ . All objects in  $\mathcal{M}$  label anomaly-free  $nD$  topological orders that are all topologically Morita equivalent. Mathematically,  $\Omega_m \mathcal{M}$  and  $\Omega_{m'} \mathcal{M}$  are Morita equivalent for  $m, m' \in \mathcal{M}$ , and we have  $\mathcal{M} = \Sigma \Omega_m \mathcal{M}$ . Since  $M^n$  is anomaly-free, if we further assume that  $m$  is simple, then  $\Omega_m \mathcal{M}$  is a fusion  $(n-1)$ -category and  $\Omega_m^2 \mathcal{M}$  is a non-degenerate braided fusion  $(n-2)$ -category, i.e.,  $\mathfrak{Z}_2(\Omega_m^2 \mathcal{M}) \simeq (n-2)\text{Vec}$ . Moreover, we have

$$\Omega_m \mathcal{M} = \Sigma \Omega_m^2 \mathcal{M} = \text{RMod}_{\Omega_m^2 \mathcal{M}}((n-1)\text{Vec}),$$

which provides a coordinate system for  $\Omega_m \mathcal{M}$  that are very useful for computation.

Recall that all 2-codimensional topological defect in  $\mathbf{1}^{n+1}$  form the trivial braided fusion  $(n-1)$ -category  $(n-1)\text{Vec}$ . In this case, note that the first level of the left bulk-to-wall functor  $L_1 : \mathcal{C} \rightarrow \mathcal{M}$  is defined by  $- \odot m$ , where  $\odot$  denotes the natural  $\mathcal{C}$ -action (of 1-codimensional topological defects) on  $\mathcal{M}$ . We also have the second level of left bulk-to-wall map that maps 2-codimensional topological defects in  $\mathbf{1}^{n+1}$  to  $M^n$  defined as follows:

$$\begin{array}{ccc} (n-1)\text{Vec} & \xrightarrow{L_2 = - \boxtimes \Omega_m^2 \mathcal{M}} & \Omega_m \mathcal{M} = \text{RMod}_{\Omega_m^2 \mathcal{M}}((n-1)\text{Vec}) \\ a & \mapsto & a \odot 1_m = a \odot \Omega_m^2 \mathcal{M}. \end{array}$$

Its physical meaning is illustrated below.

$$\begin{array}{ccc} \mathbf{1}^{n+1} & & \mathbf{1}^{n+1} \\ & \searrow & \\ (n-1)\text{Vec} & \xrightarrow{L_2 = - \boxtimes \Omega_m^2 \mathcal{M}} & \Omega_m \mathcal{M} = \text{RMod}_{\Omega_m^2 \mathcal{M}}((n-1)\text{Vec}) \\ & & \downarrow \\ & & 1_m = \Omega_m^2 \mathcal{M} \in \text{RMod}_{\Omega_m^2 \mathcal{M}}((n-1)\text{Vec}) \end{array}$$

The right adjoint  $L_2^R$  of  $L_2$  is precisely the forgetful functor  $f : \text{RMod}_{\Omega_m^2 \mathcal{M}}((n-1)\text{Vec}) \rightarrow (n-1)\text{Vec}$ . Therefore, we obtain  $L_2^R(1_m) = \Omega_m^2 \mathcal{M} \in \text{Alg}_{E_2}^c((n-1)\text{Vec})$ . Moreover, by Theorem<sup>ph</sup> 4.2.5,  $L_2^R(1_m)$  is a Lagrangian algebra in  $(n-1)\text{Vec}$ , i.e.  $\text{Mod}_{\Omega_m^2 \mathcal{M}}^{E_2}((n-1)\text{Vec}) \simeq (n-1)\text{Vec}$ . This result can be reformulated as a mathematical result.

**Proposition 4.2.10.** A non-degenerate braided fusion  $n$ -category  $\mathcal{A}$  is automatically a Lagrangian algebra in  $(n+1)\text{Vec}$  (recall Definition 2.3.23), i.e.

$$\text{Mod}_{\mathcal{A}}^{E_2}((n+1)\text{Vec}) \simeq (n+1)\text{Vec}.$$

**Remark 4.2.11.** When  $n = 2$ , above result was proved in mathematical literature [DN21, JF22, DX23]. $\diamond$

**Remark 4.2.12.** Recall Proposition 3.2.16 and Remark 3.2.18, Proposition 4.2.10 is the second mathematical reformulation of the fact that condensing an anomaly-free  $nD$  topological order in the trivial  $n+1D$  topological order  $\mathbf{1}^{n+1}$  reproduces  $\mathbf{1}^{n+1}$ . More precisely,

1. When an anomaly-free  $nD$  simple topological order  $M^n$  is viewed as a 1-codimensional topological defect in  $\mathbf{1}^{n+1}$ , we can condense it to obtain  $\mathbf{1}^{n+1}$  as the condensed phase and a gapped domain wall, which is nothing but  $M^n$  characterized by the pair  $(\mathcal{M}, m)$ . Mathematically, it amounts to condense the simple condensable  $E_1$ -algebra  $\Omega_m \mathcal{M}$  in  $n\text{Vec}$ .

2. When we rollup an anomaly-free  $n$ D topological order  $M^n$  in one direction, it becomes a cylinder  $S^1 \times \mathbb{R}^{n-2}$  in spatial  $n$ -dimensions  $\mathbb{R}^n$ . By shrinking the size of  $S^1$ , it becomes a 2-codimensional topological defects in  $\mathbf{1}^{n+1}$ . As an object in  $(n-1)\text{Vec}$ , it is precisely the non-degenerate braided fusion  $(n-1)$ -category  $\Omega_m^2 \mathcal{M}$ , which is automatically a Lagrangian  $E_2$ -algebra in  $(n-1)\text{Vec}$ . By condensing this 2-codimensional topological defects, we obtain  $\mathbf{1}^{n+1}$  as the condensed phase.

Note that the second reformulation is possible because  $\Omega_m^2 \mathcal{M}$  gives a complete characterization of all topological defects  $M^n$  up to condensation descendants.  $\diamond$

**Theorem<sup>ph</sup> 4.2.13.** Given an anomaly-free non-chiral simple  $n+1$ D topological order  $C^{n+1}$  and an anomaly-free  $n$ D topological order  $M^n$ . If  $A$  is a Lagrangian algebra in  $\Omega\mathcal{C}$ , then  $A \boxtimes \Omega_m^2 \mathcal{M} \in \Omega\mathcal{C} \boxtimes (n-1)\text{Vec} \simeq \Omega\mathcal{C}$  is also a Lagrangian algebra in  $\Omega\mathcal{C}$ . Moreover, we can obtain all Lagrangian algebras in  $\Omega\mathcal{C}$  from a single one by the following three-step process:

- (1) First, stacking an anomaly-free  $n$ D topological order  $M^n$  to a given gapped boundary  $X^n$  of  $C^{n+1}$ , we obtain a new gapped boundary  $X^n \boxtimes M^n$  of  $C^{n+1}$ ;
- (2) Secondly, condense  $X^n \boxtimes M^n$  to a new gapped boundary  $Y^n$ ;
- (3) Thirdly, rolling up the boundary  $Y^n$  to a 2-codimensional topological defect  $A_Y$  in  $C^{n+1}$ , it gives a Lagrangian algebra in  $\Omega\mathcal{C}$ .

All Lagrangian algebras in  $\Omega\mathcal{C}$  arise in this way from a single gapped boundary  $X^n$ .

**Remark 4.2.14.** One has to treat the rolling up process with caution. It is possible to switch the order the second step and the third step, i.e., obtaining  $A_Y$  from  $A_{X \boxtimes M}$  by a condensation restricted on the 2-codimensional topological defect. It is because the rolling up process indeed maps a gapped domain wall between  $X^n \boxtimes M^n$  and  $Y^n$  to a gapped domain wall between  $A_{X \boxtimes M}$  and  $A_Y$ . However, such obtained condensations on  $A_{X \boxtimes M}$  belongs to a very limited sub-family of all possible condensations. A generic condensations on  $A_{X \boxtimes M}$  does not produce a new Lagrangian algebra at all. Also notice that the rolling up process sometimes maps a gapless domain wall between two gapped boundaries to a gappable domain wall between two 2-codimensional topological defects. For example, by rolling up a 1+1D anomaly-free rational CFT, we obtain a gapless 0+1D defect in  $\mathbf{1}^3$  that is gappable.  $\diamond$

We have seen that condensing a Lagrangian algebra  $\mathcal{A}$  in  $(n-1)\text{Vec}$ , i.e. a non-degenerate braided fusion  $(n-2)$ -category produce the same trivial phase  $\mathbf{1}^{n+1}$  as the condensed phase. If  $\mathcal{A}$  is not Lagrangian, i.e., a (degenerate) braided fusion  $(n-2)$ -category. We obtain a condensed phase  $D^{n+1}$  and a gapped domain wall  $M^n = (\mathcal{M}, m)$  such that

$$\Omega\mathcal{D} \simeq \text{Mod}_{\mathcal{A}}^{E_2}((n-1)\text{Vec}) \quad \text{and} \quad \Omega_m \mathcal{M} \simeq \text{RMod}_{\mathcal{A}}((n-1)\text{Vec}) = \Sigma\mathcal{A}.$$

Note that we have  $\mathcal{D} = \Sigma\Omega\mathcal{D}$  and  $\mathcal{M} = \Sigma\Omega_m \mathcal{M} = \Sigma^2\mathcal{A}$ . By the boundary-bulk relation, we obtain

$$\begin{aligned} \text{Mod}_{\mathcal{A}}^{E_2}((n-1)\text{Vec}) &\simeq \mathfrak{Z}_1(\text{RMod}_{\mathcal{A}}((n-1)\text{Vec})^{\text{op}}) \simeq \mathfrak{Z}_1(\text{LMod}_{\mathcal{A}}((n-1)\text{Vec})). \\ \mathcal{D} = \Sigma \text{Mod}_{\mathcal{A}}^{E_2}((n-1)\text{Vec}) &\simeq \mathfrak{Z}_0((\mathcal{M}, m)) = \text{Fun}(\Sigma^2\mathcal{A}, \Sigma^2\mathcal{A}) \simeq \text{BMod}_{\Sigma\mathcal{A}|\Sigma\mathcal{A}}(n\text{Vec}). \end{aligned} \quad (4.2.7)$$

One can see immediately that  $D^{n+1}$  can be obtained from  $C^{n+1}$  by condensing 1-codimensional topological defect  $\Sigma\mathcal{A}$ , which is a condensable  $E_1$ -algebra in  $(n+2)\text{Vec}$ . We restudy this phenomenon in details in Section 5. We summarize above results as a mathematical result.

**Theorem 4.2.15.** For a braided fusion  $(n-2)$ -category  $\mathcal{A}$ , we have

$$\text{Mod}_{\mathcal{A}}^{E_2}((n-1)\text{Vec})^{\text{op}} \simeq \mathfrak{Z}_1(\text{RMod}_{\mathcal{A}}((n-1)\text{Vec})), \quad (4.2.8)$$

$$\Sigma \text{Mod}_{\mathcal{A}}^{E_2}((n-1)\text{Vec})^{\text{op}} \simeq \text{Fun}(\Sigma^2\mathcal{A}, \Sigma^2\mathcal{A}) \simeq \text{BMod}_{\Sigma\mathcal{A}|\Sigma\mathcal{A}}(n\text{Vec}). \quad (4.2.9)$$

**Remark 4.2.16.** The  $n = 1$  case of (4.2.8) was first proved in [DN21].  $\diamond$

**Theorem 4.2.17.** In this case, we have  $L^R(1_m) = L^R(\mathcal{A}) = [\mathcal{A}, \mathcal{A}]_{(n-1)\text{Vec}} = \mathcal{A}$ , or equivalently,

$$\int_{\mathbb{D}^2 \times \mathbb{R}^{n-2}} (\mathcal{D}|_{\mathbb{D}^2 \times \mathbb{R}^{n-2}}, (\mathcal{M}, m)|_{\partial \mathbb{D}^2 \times \mathbb{R}^{n-2}}) = (n\text{Vec}, \mathbb{1}, \mathcal{A}). \quad (4.2.10)$$

**Remark 4.2.18.** Similar to Section 3.2.2, one can also discuss general examples of the condensation of 2-codimensional topological defects. We postpone it to Section 5.2.2 as a special case of the condensations of  $k$ -codimensional topological defects.  $\diamond$

### 4.2.3 Topological Morita equivalence and Witt equivalence

We first recall a result from [KW14, Proposition 4] on topological Morita equivalence (recall Definition 2.1.17).

**Proposition<sup>ph</sup> 4.2.19 ([KW14]).** Two anomaly-free  $n+1$ D topological order  $C^{n+1}$  and  $D^{n+1}$  are topologically Morita equivalent if and only if there exist two  $n$ D topological orders  $P^n$  and  $Q^n$  such that

$$C^{n+1} \boxtimes Z(P)^{n+1} = D^{n+1} \boxtimes Z(Q)^{n+1}. \quad (4.2.11)$$

*Proof.* ( $\Rightarrow$ ). If  $C^{n+1}$  and  $D^{n+1}$  are topologically Morita equivalent, then they can be connected by a gapped anomaly-free domain wall  $M^n$ . By the folding trick, we have  $Z(M)^{n+1} = C^{n+1} \boxtimes \overline{D^{n+1}}$ . Then we obtain

$$C^{n+1} \boxtimes Z(D^n)^{n+1} = C^{n+1} \boxtimes \overline{D^{n+1}} \boxtimes D^{n+1} = Z(M)^{n+1} \boxtimes D^{n+1}.$$

( $\Leftarrow$ ). By Theorem 4.2.5,  $A_{\mathcal{P}} = [\mathbb{1}_{\mathcal{P}}, \mathbb{1}_{\mathcal{P}}]_{\mathfrak{Z}_1(\mathcal{P})}$  is a Lagrangian algebra in  $\mathfrak{Z}_1(\mathcal{P})$ , and  $A_{\mathcal{Q}} = [\mathbb{1}_{\mathcal{Q}}, \mathbb{1}_{\mathcal{Q}}]_{\mathfrak{Z}_1(\mathcal{Q})}$  is a Lagrangian algebra in  $\mathfrak{Z}_1(\mathcal{Q})$ . By condensing the condensable  $E_2$ -algebra  $A_1 = \mathbb{1}_{\mathcal{P}} \boxtimes A_{\mathcal{P}} \in \Omega\mathcal{C}\boxtimes\mathfrak{Z}_1(\mathcal{P})$ , we obtain  $C^{n+1}$  as the condensed phase connected to the  $C^{n+1} \boxtimes Z(P)^{n+1}$  by a gapped domain wall  $M_1^n$ . Similarly, by condensing the condensable  $E_2$ -algebra  $A_2 = \mathbb{1}_{\mathcal{D}} \boxtimes A_{\mathcal{Q}} \in \Omega\mathcal{D} \boxtimes \mathfrak{Z}_1(\mathcal{Q})$ , we obtain  $D^{n+1}$  as the condensed phase connected to the  $D^{n+1} \boxtimes Z(Q)^{n+1}$ -phase by a gapped domain wall  $M_2^n$ .

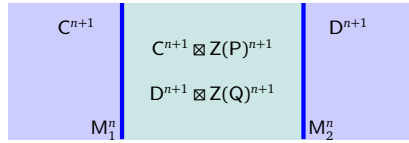

By our assumption (4.2.11) and fusing  $M_1^n$  with  $M_2^n$  along  $C^{n+1} \boxtimes Z(P)^{n+1} = D^{n+1} \boxtimes Z(Q)^{n+1}$ , we obtain an (anomaly-free) gapped domain wall between  $C^{n+1}$  and  $D^{n+1}$ .  $\square$

Similar to anyon condensation in 2+1D, in general, two arbitrary anomaly-free topological orders  $C^{n+1}$  and  $D^{n+1}$  connected by an anomaly-free gapped domain wall  $M^n$  cannot be obtained from each other via condensing 2-codimensional topological defects. However, one can prove a slightly weaker result as in 2+1D [DMNO13].

**Corollary<sup>ph</sup> 4.2.20.** If two anomaly-free  $n+1$ D topological order  $C^{n+1}$  and  $D^{n+1}$  are topologically Morita equivalent (i.e., admitting a gapped anomaly-free domain wall), then there exists the third anomaly-free  $n+1$ D topological order  $A^{n+1}$  such that  $C^{n+1}$  and  $D^{n+1}$  can be obtained from  $A^{n+1}$  via two different condensations of 2-codimensional topological defects.

*Proof.* It follows from above Lemma by choosing  $A^{n+1} = C^{n+1} \boxtimes Z(P)^{n+1} = D^{n+1} \boxtimes Z(Q)^{n+1}$ .  $\square$

**Remark 4.2.21.** When  $n = 2$ , it was proved in [DMNO13] there exists an anomaly-free  $n+1$ D topological order  $\mathcal{B}^{n+1}$  such that  $\mathcal{B}^{n+1}$  can be obtained from both  $\mathcal{C}^{n+1}$  and  $\mathcal{D}^{n+1}$  via condensations of 2-codimensional topological defects. It is natural to ask if it is true for  $n > 2$ . We hope to explore this question in the future.  $\diamond$

The following definition generalizes the Witt equivalence for non-degenerate braided fusion 1-categories, introduced in [DMNO13], to higher categories.

**Definition 4.2.22.** Two non-degenerate braided fusion  $n$ -categories  $\mathcal{A}$  and  $\mathcal{B}$  are called *Witt equivalent* if there exist two fusion  $n$ -categories  $\mathcal{P}$  and  $\mathcal{Q}$  and a braided equivalence:

$$\mathcal{A} \boxtimes \mathfrak{Z}_1(\mathcal{P}) \simeq \mathcal{B} \boxtimes \mathfrak{Z}_1(\mathcal{Q}).$$

The physical result Proposition<sup>ph</sup> 4.2.19 immediately implies the following mathematical result.

**Corollary 4.2.23.** Two non-degenerate braided fusion  $n$ -categories  $\mathcal{A}$  and  $\mathcal{B}$  are Witt equivalent if and only if there exists a fusion  $n$ -category  $\mathcal{M}$  and braided equivalence:

$$\mathcal{A} \boxtimes \mathcal{B}^{\text{op}} \simeq \mathfrak{Z}_1(\mathcal{M}).$$

**Corollary 4.2.24.** Two non-degenerate braided fusion  $n$ -categories  $\mathcal{A}$  and  $\mathcal{B}$  are Witt equivalent if and only if there exists a third non-degenerate braided fusion  $n$ -category  $\mathcal{C}$  and  $A, B \in \text{Alg}_{\mathbb{E}_2}^c(\mathcal{C})$  such that

$$\mathcal{A} \simeq \text{Mod}_A^{\mathbb{E}_2}(\mathcal{C}) \quad \text{and} \quad \mathcal{B} \simeq \text{Mod}_B^{\mathbb{E}_2}(\mathcal{C}).$$

**Remark 4.2.25.** When  $n = 2$ , in each Witt class, there is a smallest one called *anisotropic*. For  $n > 2$ , it is not clear if it is true. However, it is possible generalize this notion for  $n > 2$ . A non-degenerate braided fusion  $n$ -category  $\mathcal{B}$  is called *anisotropic* if only condensable  $\mathbb{E}_2$ -algebra in  $\mathcal{B}$  are of form  $\mathbb{1}_{\mathcal{B}} \boxtimes A \in \mathcal{B} \boxtimes n\text{Vec} \simeq \mathcal{B}$ , where  $A$  is a condensable  $\mathbb{E}_2$ -algebra in  $n\text{Vec}$ . We leave the further study of this notion to the future.  $\diamond$

#### 4.2.4 Examples in 3+1D

We have already seen the condensations of 2-codimensional topological defects in  $1^4$ . In this subsection, we provide some examples in 3+1D  $\mathbb{Z}_2$ -gauge theory.

**Example 4.2.26.** Consider 3+1D  $\mathbb{Z}_2$  gauge theory  $\mathcal{G}\mathcal{T}_{\mathbb{Z}_2}^4$ . Then  $\Omega\mathcal{G}\mathcal{T}_{\mathbb{Z}_2}^4$  is a nondegenerate braided fusion 2-category and we have  $\Omega\mathcal{G}\mathcal{T}_{\mathbb{Z}_2}^4 \simeq \mathfrak{Z}_1(2\text{Rep}(\mathbb{Z}_2)) \simeq \mathfrak{Z}_1(2\text{Vec}_{\mathbb{Z}_2})$ . This braided fusion 2-category was studied in [KTZ20b] and via the 3+1D toric code model in [KTZ20a]. We use the notation in [KTZ20a, ZLZH<sup>+</sup>23]. There are 4 simple objects  $\mathbb{1}, \mathbb{1}_c, m, m_c$  in  $\Omega\mathcal{G}\mathcal{T}_{\mathbb{Z}_2}^4$  with the fusion rule

$$m \otimes m \simeq \mathbb{1}, \quad \mathbb{1}_c \otimes \mathbb{1}_c \simeq \mathbb{1}_c \oplus \mathbb{1}_c, \quad m \otimes \mathbb{1}_c \simeq \mathbb{1}_c \otimes m \simeq m_c.$$

The hom categories are depicted in the following diagram:



We also denote the simple objects in the hom categories in the following diagram:

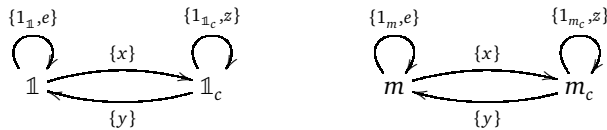



## 5 Condensations of higher codimensional topological defects

In this section, we present the general theory of condensations of  $k$ -codimensional topological defects in an  $n+1$ D topological order. We first study the relation between particle condensations and string condensations in 2+1D, then we generalize it to higher dimensions.

### 5.1 Particle condensations in 2+1D via a two-step process

In 2+1D, 1-codimensional defects are strings and 2-codimensional defects are particles. In Section 3.2 and 3.2.3, we have studied the string condensation in 2+1D; in Section 4.1, we have studied the particle (or anyon) condensation in 2+1D. In this subsection, we study their relation, which can be generalized to higher dimensions.

#### 5.1.1 General theory

In this subsection, we study the relation between particle condensations and string condensations in a 2+1D anomaly-free simple topological orders  $\mathcal{C}^3$ . In this case, there is a natural coordinate system of  $\mathcal{C}$ , i.e.,  $\mathcal{C} = \Sigma\Omega\mathcal{C} = \text{RMod}_{\Omega\mathcal{C}}(2\text{Vec})$ .

Consider a particle condensation in  $\mathcal{C}^3$  defined by a simple condensable  $E_2$ -algebra  $A$  in  $\Omega\mathcal{C}$ . It produces a condensed 2+1D topological order  $\mathcal{D}^3$  and a gapped domain wall  $\mathcal{M}^2 = (\mathcal{M}, m)$  such that  $\Omega\mathcal{D} \simeq \text{Mod}_A^{E_2}(\Omega\mathcal{C})$  and  $\Omega_m\mathcal{M} = \text{RMod}_A(\Omega\mathcal{C})$ . Now we show that the same phase transition can be realized in a different way, which splits into two steps.

1. In the first step, we condense the particle  $A$  along a line in space. It produces a condensed string denoted by  $\Sigma A$ . In this step, one can forget about the  $E_2$ -algebra structure on  $A$  but only remember its  $E_1$ -algebra structure. Recall Section 3.1.1 [Kon14], condensing  $A$  on a line produces a condensed string, particles on which form the fusion 1-category  $\text{Mod}_A^{E_1}(\mathcal{C})$ , i.e.

$$\text{hom}_{\mathcal{C}}(\Sigma A, \Sigma A) \simeq \text{Mod}_A^{E_1}(\mathcal{C}).$$

However, this result does not tell us what  $\Sigma A$  is as an object in  $\mathcal{C}$ . In order to determine  $\Sigma A \in \mathcal{C}$ , we first choose a coordinate system given by  $\mathcal{C} = \text{RMod}_{\Omega\mathcal{C}}(2\text{Vec})$ , then we show that  $\Sigma A$  can be identified with  $\text{RMod}_A(\Omega\mathcal{C})$  as an object in  $\text{RMod}_{\Omega\mathcal{C}}(2\text{Vec})$ .

- (a) First, we have already shown in Theorem<sup>ph</sup> 3.2.21 that  $\text{RMod}_A(\Omega\mathcal{C}) \in \text{Alg}_{E_1}^{\mathcal{C}}(\text{RMod}_{\Omega\mathcal{C}}(2\text{Vec})) \simeq \text{LMod}_{\Omega\mathcal{C}}(\text{Alg}_{E_1}^{\mathcal{C}}(2\text{Vec}))$  because the functor  $-\otimes A : \Omega\mathcal{C} \rightarrow \text{RMod}_A(\Omega\mathcal{C})$  is a central functor.
- (b) It remains to show that  $\Sigma A$  can be identified with  $\text{RMod}_A(\Omega\mathcal{C})$  as an object in  $\mathcal{C} = \text{RMod}_{\Omega\mathcal{C}}(2\text{Vec})$ . One can see this directly from the following picture:

$$\begin{array}{ccc} \text{RMod}_A(\Omega\mathcal{C}) \boxtimes_{\Omega\mathcal{D}} \text{RMod}_A(\Omega\mathcal{C})^{\text{op}} \simeq \text{Mod}_A^{E_1}(\Omega\mathcal{C}) & & \Sigma A \\ \begin{array}{c} \text{RMod}_A(\Omega\mathcal{C}) \quad \Omega\mathcal{D} \quad \Omega\mathcal{C} \\ \uparrow \quad \downarrow \\ \text{RMod}_A(\Omega\mathcal{C}) \\ \downarrow \\ \Omega\mathcal{C} \end{array} & \rightsquigarrow & \begin{array}{c} \Sigma A \\ \uparrow \\ \text{hom}_{\mathcal{C}}(\Sigma A, \Sigma A) \simeq \text{Mod}_A^{E_1}(\mathcal{C}) \\ \bullet \\ \Sigma A = \text{RMod}_A(\Omega\mathcal{C}) = \text{hom}_{\mathcal{C}}(\mathbb{1}_{\mathcal{C}}, \Sigma A) \\ \downarrow \\ \Omega\mathcal{C} \end{array} \end{array} \quad (5.1.1)$$

where the green region shrink horizontally to the condensed string  $\Sigma A$ , and the wall between two colored region has particles which form a fusion 1-category given by  $\text{RMod}_A(\Omega\mathcal{C})$ . We recover the multi-fusion 1-category of particles on the condensed string by the following equivalences:

$$\text{RMod}_A(\Omega\mathcal{C}) \boxtimes_{\Omega\mathcal{D}} \text{RMod}_A(\Omega\mathcal{C})^{\text{op}} \simeq \text{RMod}_A(\Omega\mathcal{C}) \boxtimes_{\text{Mod}_A^{E_2}(\Omega\mathcal{C})} \text{LMod}_A(\Omega\mathcal{C}) \simeq \text{Mod}_A^{E_1}(\Omega\mathcal{C}),$$



where we have used the natural equivalence  $\text{RMod}_A(\Omega\mathcal{C}) \simeq \text{LMod}_A(\Omega\mathcal{C})^{\text{op}}$  defined by  $x \mapsto x^R = x^*$  in the first ‘ $\simeq$ ’ and the second ‘ $\simeq$ ’ is a mathematical fact (see for example [KZ18a]). Remember  $\text{hom}_{\mathcal{C}}(x, y), \forall x, y \in \mathcal{C}$  are physical observables in spacetime, but the label of a string can not be observed directly in spacetime. However, one can identify an object  $x \in \mathcal{C}$  in the coordinate system  $\mathcal{C} = \text{RMod}_{\Omega\mathcal{C}}(2\text{Vec})$  with  $\text{hom}_{\mathcal{C}}(\Omega\mathcal{C}, x)$  because  $\text{hom}_{\text{RMod}_{\Omega\mathcal{C}}(2\text{Vec})}(\Omega\mathcal{C}, x) \simeq x$  in  $\text{RMod}_{\Omega\mathcal{C}}(2\text{Vec})$ . From the physical configuration depicted in (5.1.1), we immediately obtain

$$\Sigma A \simeq \text{hom}_{\mathcal{C}}(\Omega\mathcal{C}, \Sigma A) \simeq \text{RMod}_A(\Omega\mathcal{C}) \in \text{RMod}_{\Omega\mathcal{C}}(2\text{Vec}) = \mathcal{C},$$

because  $\text{hom}_{\mathcal{C}}(\Omega\mathcal{C}, \Sigma A)$  is precisely the observables living the domain wall between the trivial 1-codimensional topological defect  $\mathbb{1}_{\mathcal{C}} = \Omega\mathcal{C}$  and  $\Sigma A$ .

From now on, for simplicity, we set  $\Sigma A := \text{RMod}_A(\Omega\mathcal{C}) \in \text{RMod}_{\Omega\mathcal{C}}(2\text{Vec}) = \mathcal{C}$  and, at the same time,  $\Sigma A$  is also the abstract label of the condensed defect if we do not choose any coordinate system.

2. In the second step, we condense  $\Sigma A$ . We have already shown in Theorem<sup>ph</sup> 3.2.21 that  $\Sigma A$  is a condensable  $E_1$ -algebra in  $\mathcal{C}$ . This fact can also be viewed in another way. Since the  $\Sigma A$ -string can be obtained by shrinking the green region horizontally as depicted in (5.1.1), by our theory of the condensations of 1-codimensional topological defects (Theorem<sup>ph</sup> 3.2.2 and 3.2.9), the  $\Sigma A$ -string has a canonical structure of a condensable  $E_1$ -algebra in  $\mathcal{C}$ . The algebraic structure on  $\Sigma A$  is defined in (3.2.1). In this argument, the  $E_2$ -algebra structure on  $A$  is implicitly used. Moreover, this algebraic structure on  $\Sigma A$  coincides with the monoidal structure on  $\text{RMod}_A(\Omega\mathcal{C})$ . Therefore, we can further condensing the  $\Sigma A$ -string thus produces a new phase. It is physically obvious that this new phase is precisely  $D^3$ , In other words, we obtain

$$\mathcal{D} \simeq \text{Mod}_{\Sigma A}^{E_1}(\mathcal{C}). \quad (5.1.2)$$

It immediately implies the following equivalences:

$$\text{Mod}_{\Sigma A}^{E_1}(\mathcal{C}) \simeq \Sigma \text{Mod}_A^{E_2}(\Omega\mathcal{C}), \quad (5.1.3)$$

$$\Omega \text{Mod}_{\Sigma A}^{E_1}(\mathcal{C}) \simeq \text{Mod}_A^{E_2}(\Omega\mathcal{C}). \quad (5.1.4)$$

where the first equivalence is a monoidal equivalence and the second one is a braided monoidal equivalence. Note that (5.1.4) is an immediate consequence of (5.1.3). The gapped domain wall  $M^2$  between  $C^3$  and  $D^3$  can be described the pair

$$(\text{RMod}_{\Sigma A}(\mathcal{C}), \Sigma A).$$

The multi-fusion 1-category of particles on this domain wall is given by

$$\text{hom}_{\text{RMod}_{\Sigma A}(\mathcal{C})}(\Sigma A, \Sigma A) \simeq \text{Fun}_{\text{RMod}_A(\Omega\mathcal{C})^{\text{op}}}(\text{RMod}_A(\Omega\mathcal{C}), \text{RMod}_A(\Omega\mathcal{C})) \simeq \text{RMod}_A(\Omega\mathcal{C}),$$

where the first ‘ $\simeq$ ’ is due to the fact that a functor intertwining the  $\Sigma A$ -action automatically intertwines the  $\Omega\mathcal{C}$ -action, which is defined via the monoidal functor  $-\otimes A : \Omega\mathcal{C} \rightarrow \text{RMod}_A(\Omega\mathcal{C})$ .

Note that the monoidal equivalences in (5.1.3) summarize precisely the relation between the direct condensation of a 2-codimensional topological defect  $A$  and that of the 1-codimensional topological defect  $\Sigma A$ .

All of above arguments automatically generalize to higher codimensional defects except a key point, which deserves to be reinvestigated. We see the key point here is to argue that  $\Sigma A$  is automatically a condensable  $E_1$ -algebra in  $\mathcal{C}$  if  $A$  is a condensable  $E_2$ -algebra in  $\Omega\mathcal{C}$ . We have used the physical or geometric intuition established in Theorem<sup>ph</sup> 3.2.2 and 3.2.9 (in particular, (3.2.1)). Unfortunately, this

physical or geometric intuition stops to make sense for higher codimensional topological defects because  $k$ -codimensional topological defects for  $k > 2$  do not give a complete mathematical characterization of a topological order. Whenever we want to apply the geometric intuition of a topological order  $C^{n+1}$  we should automatically include all topological defects of codimension 1 or higher if  $C^{n+1}$  is anomalous; or include all topological defect of codimension (at least) 2 or higher if  $C^{n+1}$  is anomaly-free. Therefore, in order to generalize this key point to higher codimensional defects, we need more fundamental arguments that are ready to be generalized.

Now we explain mathematically why  $\Sigma A$  is a condensable  $E_1$ -algebra in  $\mathcal{C}$ . First, recall that  $\otimes^2$  represents the fusion product in the vertical direction (see Figure 7 and 11), and  $(\Omega\mathcal{C}, \otimes^2)$  is monoidal. Therefore, it makes sense to talk about the 1-category  $\text{Alg}_{E_1}(\Omega\mathcal{C})$  using  $\otimes^2$ . It turns out that the second tensor product  $\otimes^1$  on  $\Omega\mathcal{C}$  (i.e., the horizontal fusion) endow both triples

$$(\text{Alg}_{E_1}(\Omega\mathcal{C}), \otimes^1, 1_{\mathbb{1}_{\mathcal{C}}}) \quad \text{and} \quad (\text{RMod}_{\Omega\mathcal{C}}(2\text{Vec}), \boxtimes_{\Omega\mathcal{C}}, \Omega\mathcal{C})$$

with the structure of a monoidal 1-category and a monoidal 2-category, respectively. We explain this fact below.

1. The tensor product in  $\text{Alg}_{E_1}(\Omega\mathcal{C})$  is given by the tensor product  $\otimes^1$  in  $\Omega\mathcal{C}$ . For  $A, B \in \text{Alg}_{E_1}(\Omega\mathcal{C})$ ,  $A \otimes^1 B$  is a well-defined  $E_1$ -algebra in  $\Omega\mathcal{C}$  with the algebraic structure defined as follows:

$$(A \otimes^1 B) \otimes^2 (A \otimes^1 B) \xrightarrow{\delta_{A,A,B,B}} (A \otimes^2 A) \otimes^1 (B \otimes^2 B) \xrightarrow{\mu_A \mu_B} A \otimes^1 B.$$

2. A right  $\Omega\mathcal{C}$ -module  $X$  with a right  $\Omega\mathcal{C}$ -action  $\odot : X \times \Omega\mathcal{C} \rightarrow X$  is automatically a left  $\Omega\mathcal{C}$ -module with the left  $\Omega\mathcal{C}$ -action defined by  $a \odot x := x \odot a$  for  $a \in \Omega\mathcal{C}, x \in X$ . This is a well-defined left  $\Omega\mathcal{C}$ -module due to the existence of the braiding in  $\Omega\mathcal{C}$  as shown below:

$$a \odot (b \odot x) := (x \odot b) \odot a \simeq x \odot (b \otimes^1 a) \xrightarrow{1_x c_{b,a}^1} x \odot (a \otimes^1 b) = (a \otimes^1 b) \odot x.$$

where the braiding  $c_{b,a}^1$  is defined in (2.3.6).

Note that there is a functor

$$\Sigma(-) = \text{RMod}_-(\Omega\mathcal{C}) : \text{Alg}_{E_1}(\Omega\mathcal{C}) \rightarrow \text{RMod}_{\Omega\mathcal{C}}(2\text{Vec}) = \mathcal{C} \quad (5.1.5)$$

defined by

$$\begin{array}{ccc} A & \longrightarrow & \text{RMod}_A(\Omega\mathcal{C}) \\ f \downarrow & & \downarrow -\otimes_{A_f} B \\ B & \longrightarrow & \text{RMod}_B(\Omega\mathcal{C}) \end{array}$$

where  ${}_f B$  is the  $A$ - $B$ -bimodule with the right  $A$ -module structure defined by the algebra map  $f : A \rightarrow B$ . One can show that  $\text{RMod}_-(\Omega\mathcal{C}) : \text{Alg}_{E_1}(\Omega\mathcal{C}) \rightarrow \text{RMod}_{\Omega\mathcal{C}}(2\text{Vec})$  is a monoidal functor with two defining 1-morphisms defined as follows:

$$1_{\mathbb{1}_{\mathcal{C}}} \mapsto \text{RMod}_{1_{\mathbb{1}_{\mathcal{C}}}}(\Omega\mathcal{C}) \simeq \Omega\mathcal{C}; \quad \text{RMod}_A(\Omega\mathcal{C}) \boxtimes_{\Omega\mathcal{C}} \text{RMod}_B(\Omega\mathcal{C}) \simeq \text{RMod}_{A \otimes B}(\Omega\mathcal{C}).$$

We give a construction of this equivalence. The functor  $\text{RMod}_A(\Omega\mathcal{C}) \boxtimes \text{RMod}_B(\Omega\mathcal{C}) \xrightarrow{F} \text{RMod}_{A \otimes B}(\Omega\mathcal{C})$  defined by  $m \boxtimes n \rightarrow m \otimes^1 n$ , where the  $A \otimes^1 B$ -action on  $m \otimes^1 n$  is defined as follows:

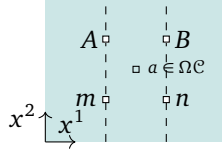

$$(m \otimes^1 n) \otimes^2 (A \otimes^1 B) \xrightarrow{\delta_{m,n,A,B}} (m \otimes^2 A) \otimes^1 (n \otimes^2 B) \xrightarrow{\mu_m \mu_n} m \otimes^1 n.$$

From above picture, it is clear that this functor  $F$  is  $\Omega\mathcal{C}$ -balanced, i.e.,  $(m \otimes^1 a) \otimes^1 n \simeq m \otimes^1 (a \otimes^1 n)$ . Therefore, it induces a functor  $G : \text{RMod}_A(\Omega\mathcal{C}) \boxtimes_{\Omega\mathcal{C}} \text{RMod}_B(\Omega\mathcal{C}) \rightarrow \text{RMod}_{A \otimes B}(\Omega\mathcal{C})$ , which is clearly monoidal. By that we mean, for  $m, m' \in \text{RMod}_A(\Omega\mathcal{C})$  and  $n, n' \in \text{RMod}_B(\Omega\mathcal{C})$ ,

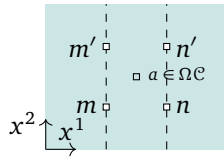

$$\begin{aligned} & G(m \boxtimes_{\Omega\mathcal{C}} n) \otimes^2 (G(m' \boxtimes_{\Omega\mathcal{C}} n')) \\ &= (m \otimes^1 n) \otimes^2 (m' \otimes^1 n') \xrightarrow{\delta_{m,n,m',n'}} (m \otimes^2 m') \otimes^1 (n \otimes^2 n) \\ &= G((m \otimes^1 m') \boxtimes_{\Omega\mathcal{C}} (n \otimes^1 n')). \end{aligned}$$

This functor  $G$  endows the functor  $\Sigma(-) : \text{Alg}_{E_1}(\Omega\mathcal{C}) \rightarrow \text{RMod}_{\Omega\mathcal{C}}(2\text{Vec})$  with a lax-monoidal functor structure<sup>19</sup>.

Since a lax-monoidal functor maps  $E_1$ -algebras to  $E_1$ -algebras, it means that the functor  $\text{RMod}_-(\Omega\mathcal{C})$  can be lifted to a functor

$$\begin{aligned} \text{RMod}_-(\Omega\mathcal{C}) : \text{Alg}_{E_2}(\Omega\mathcal{C}) = \text{Alg}_{E_1}(\text{Alg}_{E_1}(\Omega\mathcal{C})) &\rightarrow \text{Alg}_{E_1}(\text{RMod}_{\Omega\mathcal{C}}(2\text{Vec})), \\ A &\mapsto \Sigma A = \text{RMod}_A(\Omega\mathcal{C}). \end{aligned} \quad (5.1.6)$$

Since the separability is defined by 1-morphisms and identities in  $\text{Alg}_{E_1}(\Omega\mathcal{C})$ , they are mapped to 1-morphisms and identities in  $\text{RMod}_{\Omega\mathcal{C}}(2\text{Vec})$ . As a consequence, we obtain a restriction of the functor  $\text{RMod}_-(\Omega\mathcal{C})$  on the subcategory  $\text{Alg}_{E_2}^c(\Omega\mathcal{C})$ :

$$\begin{aligned} \Sigma(-) = \text{RMod}_-(\Omega\mathcal{C}) : \text{Alg}_{E_2}^c(\Omega\mathcal{C}) &\rightarrow \text{Alg}_{E_1}^c(\text{RMod}_{\Omega\mathcal{C}}(2\text{Vec})) = \text{Alg}_{E_1}^c(\mathcal{C}). \\ A &\mapsto \Sigma A = \text{RMod}_A(\Omega\mathcal{C}). \end{aligned} \quad (5.1.7)$$

We summarize above result as a mathematical theorem.

**Proposition 5.1.1.** For a braided fusion 1-category  $\mathcal{B}$ , there is a well-defined functor

$$\Sigma(-) : \text{Alg}_{E_2}^c(\mathcal{B}) \rightarrow \text{Alg}_{E_1}^c(\Sigma\mathcal{B}) \quad \text{defined by} \quad A \mapsto \Sigma A = \text{RMod}_A(\mathcal{B}).$$

**Remark 5.1.2.** The functor  $\Sigma : \text{Alg}_{E_2}^c(\mathcal{B}) \rightarrow \text{Alg}_{E_1}^c(\Sigma\mathcal{B})$  is not surjective in general. This fact is equivalent to the fact that two Witt equivalent non-degenerate braided fusion categories cannot be obtained from each other via anyon condensations; however, they can be obtained from each via condensations of 1-codimensional topological defects.  $\diamond$

When  $\mathcal{C}^3$  is anomalous, the condensation of a 2-codimension topological defect  $A \in \text{Alg}_{E_2}^c(\Omega\mathcal{C})$  is defined by first condensing it on a line to produce a 1-codimensional topological defect  $\Sigma A$ ; then condensing  $\Sigma A$ . In this case, the equivalence (5.1.3) is not true in general because  $\Omega\mathcal{C}$  does not have the

<sup>19</sup>Actually, it is possible to show that  $G$  is an equivalence such that the functor (5.1.5) is a monoidal functor. But we do not need this stronger result here.

complete information of  $\mathcal{C}$  and some 1-codimensional topological defects in  $\mathcal{C}$  are not condensation descendants of  $\Omega\mathcal{C}$ . However, the equivalence (5.1.4), i.e.,  $\Omega \text{Mod}_{\Sigma A}^{\mathbb{E}_1}(\mathcal{C}) \simeq \text{Mod}_A^{\mathbb{E}_2}(\Omega\mathcal{C})$  remains correct because this equivalence is simply a reformulation of the natural physical intuition that all 2-codimensional topological defects in the condensed (also anomalous) phase  $D^3$  can only come from  $\Omega\mathcal{C}$  as deconfined 2-codimensional topological defects, i.e. as  $E_2$ - $A$ -modules in  $\Omega\mathcal{C}$ . Moreover,  $C^3$  and  $D^3$  should share the same gravitational anomaly, i.e.,  $Z(C)^4 = Z(D)^4$ . We summarize and reformulate above results as mathematical results.

**Theorem 5.1.3.** Let  $\mathcal{C}$  be a fusion 2-category,  $A \in \text{Alg}_{E_2}^c(\Omega\mathcal{C})$  and  $\Sigma A = \text{RMod}_A(\Omega\mathcal{C})$ . Then we have  $\Sigma A \in \text{Alg}_{E_1}^c(\mathcal{C})$  and a natural braided equivalence:

$$\Omega \text{Mod}_{\Sigma A}^{\mathbb{E}_1}(\mathcal{C}) \simeq \text{Mod}_A^{\mathbb{E}_2}(\Omega\mathcal{C}). \quad (5.1.8)$$

**Theorem 5.1.4.** Let  $\mathcal{B}$  be a non-degenerate braided fusion 1-category,  $A \in \text{Alg}_{E_2}^c(\mathcal{B})$  and  $\Sigma A = \text{RMod}_A(\mathcal{B})$ . We have a natural monoidal equivalence:

$$\text{Mod}_{\Sigma A}^{\mathbb{E}_1}(\Sigma\mathcal{B}) \simeq \Sigma \text{Mod}_A^{\mathbb{E}_2}(\mathcal{B}). \quad (5.1.9)$$

**Remark 5.1.5.** When  $A$  is a condensable  $E_1$ -algebra in a fusion 2-fusion  $\mathcal{C}$ ,  $\Sigma A \in \Sigma\mathcal{C}$ . We have

$$\Omega_{\Sigma A} \Sigma\mathcal{C} = \text{Fun}_{\mathcal{C}^{\text{op}}}(\text{RMod}_A(\mathcal{C}), \text{RMod}_A(\mathcal{C})) \simeq \text{Mod}_A^{\mathbb{E}_1}(\mathcal{C}). \quad (5.1.10)$$

When  $A$  is a condensable  $E_2$ -algebra in braided fusion 2-category  $\mathcal{B}$ ,  $\Sigma A \in \text{Alg}_{E_1}^c(\Sigma\mathcal{B})$ . We can repeat the argument to obtain  $\Sigma^2 A := \text{RMod}_{\Sigma A}(\Sigma\mathcal{B}) \in \Sigma^2\mathcal{B}$ . Then we obtain

$$\Omega_{\Sigma^2 A}^2(\Sigma^2\mathcal{B}) = \Omega \text{Mod}_{\Sigma A}^{\mathbb{E}_1}(\Sigma\mathcal{B}) \simeq \text{Mod}_A^{\mathbb{E}_2}(\mathcal{B}). \quad (5.1.11)$$

The canonical equivalence (5.1.11) provides us a convenient way to understand, compute or even define alternatively the category  $\text{Mod}_A^{\mathbb{E}_2}(\mathcal{B})$ , which was defined in (4.1.3).  $\diamond$

## 5.1.2 Examples

**Example 5.1.6.** Let us consider the 2+1D  $\mathbb{Z}_2$  topological order  $\text{TC}^3$ , whose 2-category of topological defects is  $\mathcal{TC}$ . In this case,  $\Omega\mathcal{TC} = \mathfrak{Z}_1(\text{Rep}(\mathbb{Z}_2))$  is a non-degenerate braided fusion 1-category with four simple objects  $1, e, m, f$ , where  $1, e$  generate the sub-fusion category  $\text{Rep}(\mathbb{Z}_2)$ . By [KZ22a], there are six simple strings  $\mathbb{1}, \text{dual}, \text{ss}, \text{sr}, \text{rs}, \text{rr}$  in  $\text{TC}^2$  with the fusion rules given in [KZ22a, Table 1].

1.  $A_e = 1 \oplus e$  is a condensable  $E_2$ -algebra in  $\Omega\mathcal{TC}$ . If we condense  $A_e$  along a line, we obtain the condensed string  $\text{rr} = \Sigma A_e \in \mathcal{C}$ . As we have shown in Example 3.2.26, this string  $\text{rr}$  is a condensable  $E_1$ -algebra that can be further condensed to create the rough boundary of  $\text{TC}^3$ .
2.  $A_m = 1 \oplus m$  is a condensable  $E_2$ -algebra in  $\Omega\mathcal{TC}$ . If we condense it along a line, we obtain a condensed string  $\text{ss}$ . As we have shown in Example 3.2.26, this string  $\text{ss}$  has a canonical structure of a condensable  $E_1$ -algebra in  $\mathcal{C}$  that can be further condensed to create the smooth boundary of  $\text{TC}^3$ .

**Example 5.1.7.** The anyon condensation from double Ising to toric code was explained in Example 4.1.7. Now we reconstruct this phase transition in two steps. Recall that  $A = \mathbb{1} \boxtimes \mathbb{1} \oplus \psi \boxtimes \psi \in \Omega\mathcal{Is} \boxtimes \Omega\mathcal{Is}^{\text{op}} \simeq \mathfrak{Z}_1(\Omega\mathcal{Is})$  is a condensable  $E_2$ -algebra in  $\mathfrak{Z}_1(\Omega\mathcal{Is})$ . We have  $\Sigma A = \text{RMod}_A(\mathfrak{Z}_1(\Omega\mathcal{Is}))$ . By further condensing  $\Sigma A$  in  $\Sigma\mathfrak{Z}_1(\Omega\mathcal{Is}) = \mathcal{Is} \boxtimes \mathcal{Is}^{\text{op}}$ , we obtain

$$\text{Mod}_{\Sigma A}^{\mathbb{E}_1}(\Sigma\mathfrak{Z}_1(\Omega\mathcal{Is})) \simeq \Sigma\mathfrak{Z}_1(\text{Rep}(\mathbb{Z}_2)),$$

which implies that the condensed phase is the  $\mathbb{Z}_2$  topological order.

## 5.2 Condensation of higher codimensional topological defects

### 5.2.1 General theory

Consider a (potentially anomalous)  $n+1$ D simple topological order  $\mathcal{C}^{n+1}$ . The category of all topological defects  $\mathcal{C}$  is a fusion  $n$ -category. By definition, for  $k \geq 1$ , the category  $\Omega^{k-1}\mathcal{C}$  of topological defects of codimension  $k$  or higher is an  $E_k$ -fusion  $(n-k+1)$ -category, and  $\Sigma\Omega^{k-1}\mathcal{C}$  is indecomposable separable  $(n-k+2)$ -category and is the full subcategory of  $\Omega^{k-2}\mathcal{C}$  consisting of only the connecting component of the tensor unit  $1_{\mathbb{1}}^{k-2}$  in  $\Omega^{k-2}\mathcal{C}$ .

We denote the composition of  $k$ -morphisms in  $B\mathcal{C}$  by  $\otimes^k$ . For  $1 \leq i \leq k$ , similar to the discussion in Section 2.3.2,  $\otimes^i$  also represents the fusion product of two  $k$ -codimensional topological defects along the  $x^i$ -direction. For  $1 \leq i, j \leq k$ , if we want to discuss the fusion among  $k$ -codimensional topological defects along the  $x^i$ -direction and the  $x^j$ -direction, we often use the following picture in the  $(x^i, x^j)$ -plane:

where  $a, b, c, d \in \Omega^{k-1}\mathcal{C}$  and other directions of these  $k$ -codimensional defects  $a, b, c, d$  are assumed to lie in the normal direction of above plane. By restricting to the  $(x^i, x^j)$ -plane, we see that these  $k$ -codimensional topological defects form is equipped with the following isomorphism

$$(a \otimes^i c) \otimes^j (b \otimes^i d) \xrightarrow[\simeq]{\delta_{a,b,c,d}^{(i,j)}} (a \otimes^j b) \otimes^i (c \otimes^j d) \quad (5.2.2)$$

that defines the  $E_2$ -monoidal structure. These fusion products  $\otimes^i$  for  $1 \leq i \leq k$  define the  $k$ -dimensional multiplication of  $k$ -codimensional topological defects and, therefore, define the  $E_k$ -fusion category structure on  $\Omega^{k-1}\mathcal{C}$ .

**Lemma<sup>ph</sup> 5.2.1.** Let  $\mathcal{B}$  be an  $E_k$ -multi-fusion  $n$ -category. The assignment  $A \mapsto \Sigma A = \text{RMod}_A(\mathcal{B})$  defines a functor:

$$\Sigma(-) := \text{RMod}_-(\mathcal{B}) : \text{Alg}_{E_k}^c(\mathcal{B}) \rightarrow \text{Alg}_{E_{k-1}}^c(\Sigma\mathcal{B}).$$

*Proof.* Since  $\mathcal{B}$  is  $E_k$ -monoidal, it has fusion products  $\otimes^i$  in  $i$ -th independent direction for  $1 \leq i \leq k$ . We have shown in Section 5.1.1 that  $\Sigma(-) : \text{Alg}_{E_1}^c(\mathcal{B}) \rightarrow \Sigma\mathcal{B}$ , defined as follows:

$$\begin{array}{ccc} A & \longrightarrow & \text{RMod}_A(\mathcal{B}) \\ f \downarrow & & \downarrow -\otimes_{A^f} \mathcal{B} \\ B & \longrightarrow & \text{RMod}_B(\mathcal{B}) \end{array}$$

is a well-defined functor. For  $1 \leq i < k$ , each tensor product  $\otimes^i$  endows  $\text{Alg}_{E_1}^c(\mathcal{B})$  with a monoidal structure denoted by  $(\text{Alg}_{E_1}^c(\mathcal{B}), \otimes^i)$ , and also endows  $\text{RMod}_A(\mathcal{B})$  with a monoidal structure denoted by  $(\text{RMod}_A(\mathcal{B}), \otimes^i)$ . Restricting to the  $(x^i, x^k)$ -plane, we have already shown in Section 5.1.1 that  $\Sigma : (\text{Alg}_{E_1}^c(\mathcal{B}), \otimes^i) \rightarrow (\Sigma\mathcal{B}, \otimes^i)$  is a lax-monoidal functor, which maps algebras in  $(\text{Alg}_{E_1}^c(\mathcal{B}), \otimes^i)$  to algebras in  $(\Sigma\mathcal{B}, \otimes^i)$ . Since  $\Sigma$  preserves the monoidal structure in all  $i$ -th directions for  $1 \leq i < k$ , it preserves the  $E_{k-1}$ -monoidal structures on  $\text{Alg}_{E_1}^c(\mathcal{B})$  and  $\Sigma\mathcal{B}$ .  $\square$

Now we are ready to state one of the main results of this work, which is a natural consequence of all the previous discussion in this work.

**Theorem<sup>ph</sup> 5.2.2.** A (potentially composite)  $k$ -codimensional topological defect  $A \in \Omega^{k-1}\mathcal{C}$  is condensable if it is equipped with the structure of a condensable  $E_k$ -algebra in  $\Omega^{k-1}\mathcal{C}$ . The condensed phase  $D^{n+1}$  can be obtained by the following procedure.

1. Condense the defect  $A$  along one of the transversal direction  $x^k$ .<sup>20</sup> This produces a  $(k-1)$ -codimensional topological defect  $\Sigma A \in \Sigma\Omega^{k-1}\mathcal{C} \hookrightarrow \Omega^{k-2}\mathcal{C}$ . If we use the coordinate system  $\Sigma\Omega^{k-1}\mathcal{C} = \text{RMod}_{\Omega^{k-1}\mathcal{C}}((n-k+2)\text{Vec})$ , the object  $\Sigma A$  can be identified with the object  $\text{RMod}_A(\Omega^{k-1}\mathcal{C})$  in  $\text{RMod}_{\Omega^{k-1}\mathcal{C}}((n-k+2)\text{Vec})$ .
2.  $\Sigma A$  has a natural structure of a condensable  $E_{k-1}$ -algebra in  $\Sigma\Omega^{k-1}\mathcal{C}$  or in  $\Omega^{k-2}\mathcal{C}$ . Therefore, one can condense  $\Sigma A$  along one of the remaining transversal direction  $x^{k-1}$  to produce a  $(k-2)$ -codimensional topological defect  $\Sigma^2 A$ .
3. Repeat above process until  $\Sigma^{k-1}A$ , which is a condensable  $E_1$ -algebra in  $\mathcal{C}$ . By condensing  $\Sigma^{k-1}A$  in  $\mathcal{C}$  along the only remaining transversal direction  $x^1$ , we obtain a new phase  $D^{n+1}$  and a gapped domain wall  $M^n = (\mathcal{M}, m)$  such that

$$\mathcal{D} \simeq \text{Mod}_{\Sigma^{k-1}A}^{E_1}(\mathcal{C}) \quad \text{and} \quad \mathcal{M} = \text{RMod}_{\Sigma^{k-1}A}(\mathcal{C}), \quad m = \Sigma^{k-1}A. \quad (5.2.3)$$

If  $C^{n+1}$  is anomaly-free, then one can alternatively terminate the process at  $\Sigma^{k-2}A$ , which is a condensable  $E_2$ -algebra in  $\Omega\mathcal{C}$ . More precisely, we can condense  $\Sigma^{k-2}A \in \text{Alg}_{E_2}^c(\Omega\mathcal{C})$  directly to obtain the same new phase  $D^{n+1}$  and the same gapped domain wall such that

$$\Omega\mathcal{D} \simeq \text{Mod}_{\Sigma^{k-2}A}^{E_2}(\Omega\mathcal{C}) \quad \text{and} \quad \Omega_m\mathcal{M} = \text{RMod}_{\Sigma^{k-2}A}(\Omega\mathcal{C}). \quad (5.2.4)$$

The consistency of two approaches immediately implies the following natural equivalences:

$$\Sigma \text{Mod}_{\Sigma^{k-2}A}^{E_2}(\Omega\mathcal{C}) \simeq \text{Mod}_{\Sigma^{k-1}A}^{E_1}(\mathcal{C}) \quad \text{and} \quad \Sigma \text{RMod}_{\Sigma^{k-2}A}(\Omega\mathcal{C}) \simeq \text{RMod}_{\Sigma^{k-1}A}(\mathcal{C}), \quad (5.2.5)$$

where the first equivalence is a monoidal equivalence.

When  $C^{n+1}$  is anomalous, the condensable  $E_k$ -algebra  $A$  in  $\Omega^{k-1}\mathcal{C}$  does not directly determines the phase transition. However, it determines some partial data of the condensed phase directly.

1. Since all (deconfined) topological defects of codimension  $k$  or higher in the condensed phase  $D^{n-1}$  necessarily come from those in  $\Omega^{k-1}\mathcal{C}$ , and they are necessarily the  $E_k$ -modules over  $A$ , we must have the following  $E_k$ -monoidal equivalence:

$$\text{Mod}_A^{E_k}(\Omega^{k-1}\mathcal{C}) \simeq \Omega^{k-1} \text{Mod}_{\Sigma^{k-1}A}^{E_1}(\mathcal{C}). \quad (5.2.6)$$

2. Topological defects living on the gapped domain wall  $M^n$  are confined topological defects. Those  $k$ -codimensional topological defect on  $M^n$ , i.e., objects in  $\Omega_m^{k-1}\mathcal{M}$ , are necessarily originated from those in  $\Omega^{k-1}\mathcal{C}$ . Recall that a deconfined  $k$ -codimensional defect need support an  $A$ -action in all  $k$ -dimensions (with two mutually-opposite directions in each dimension). If we drop the  $A$ -action in one single direction, the associated topological defect is not deconfined. On the other hand, the minimal requirement for a topological defect to survive on the wall  $M^n$  is that it should support an  $A$ -action at least from one single direction (see further discussion in Remark 5.2.3). Therefore, those defects in  $\Omega_m^{k-1}\mathcal{M}$  are necessarily right  $A$ -modules in  $\Omega^{k-1}\mathcal{C}$ , i.e.,

$$\text{RMod}_A(\Omega^{k-1}\mathcal{C}) \simeq \Omega^{k-1} \text{RMod}_{\Sigma^{k-1}A}(\mathcal{C}). \quad (5.2.7)$$

---

<sup>20</sup>It means that we first proliferate the defect  $A$  along the transversal direction  $x^k$ , then introduce interactions among these defect, or equivalently, introduce condensation maps.

**Remark 5.2.3.** The condition for an object in  $\Omega^{k-1}\mathcal{C}$  to live on the wall  $M^n$  is that it supports an  $A$ -action from at least a single direction. It can support  $A$ -actions from other directions. When it does not support  $A$ -actions in all  $2k$  directions in all  $k$ -dimensions, say the  $A$ -action in one direction in the  $x^k$ -dimension is dropped, even though one can still define an  $A$ -action in this direction using the other  $A$ -action in the  $x^k$ -dimension via a braiding in  $(x^i, x^k)$ -plane, this  $A$ -action depends on the paths of the braidings. The incompatibility of different paths causes a strong interference that triggers the confinement. At the same time, one can also see that  $(k-1)$ -codimensional defects in  $\Omega_m^{k-1}\mathcal{M}$  can have different levels of confinement. More precisely, assume the domain wall  $M^n$  is defined by the hyperplane defined by  $x^k = x_0^k$  in space. Then all  $(k-1)$ -codimensional defects in  $\Omega_m^{k-1}\mathcal{M}$  are confined in the  $x^k$ -dimension. For  $1 \leq i < k$ , if a  $(k-1)$ -codimensional defect in  $\Omega_m^{k-1}\mathcal{M}$  supports an two-side  $A$ -action in the  $x^i$ -dimension that are compatible with the  $A$ -action in one of the  $x^k$ -direction, then it is deconfined in the  $x^i$ -dimension.  $\diamond$

We summarize and reformulate above results as mathematical results.

**Theorem 5.2.4.** Let  $\mathcal{C}$  be a fusion  $n$ -category and  $A \in \text{Alg}_{E_k}^{\mathcal{C}}(\Omega^{k-1}\mathcal{C})$ . For  $1 \leq i \leq k$ , we set  $\Sigma^0 A := A$  and define inductively

$$\Sigma^i A = \text{RMod}_{\Sigma^{i-1}A}(\Omega^{k-i}\mathcal{C}).$$

Then  $\Sigma^i A \in \text{Alg}_{E_{k-i}}^{\mathcal{C}}(\Omega^{k-i-1}\mathcal{C})$ , and there is a natural  $E_{k-i}$ -monoidal equivalence:

$$\text{Mod}_{\Sigma^i A}^{E_{k-i}}(\Omega^{k-i-1}\mathcal{C}) \simeq \Omega^{k-i-1} \text{Mod}_{\Sigma^{k-1}A}^{E_1}(\mathcal{C}). \quad (5.2.8)$$

If  $\mathcal{C} = \Sigma^{k-1}\Omega^{k-1}\mathcal{C}$ , i.e., topological defects outside  $\Omega^{k-1}\mathcal{C}$  are all condensation descendants of those in  $\Omega^{k-1}\mathcal{C}$ , then we have the following stronger results.

1. It is natural to ask if all deconfined topological defects outside  $\Omega^{k-1}\mathcal{D}$  are also condensation descendants of those in  $\Omega^{k-1}\mathcal{D}$ . It turns out that this is not correct because, in general,  $\mathcal{D}$  or  $\Omega\mathcal{D}$  is not connected even though  $\mathcal{C}$  is connected. We give an example of this fact. Consider  $A = \text{Rep}(G) \in 2\text{Vec} = \Omega^2\mathcal{C}$ , then  $\Sigma A = 2\text{Rep}(G)$ . In this case, we have  $\text{Mod}_{\Sigma A}^{E_2}(3\text{Vec}) \simeq \mathfrak{F}_1(3\text{Rep}(G))$ , which is not indecomposable as a separable 3-category [KTZ20b].
2. All confined topological defects of codimension on the gapped domain wall are necessarily condensation descendants of those in  $\Omega_m^{k-1}(\mathcal{M})$ . Therefore, we obtain the following natural equivalence:

$$\Sigma^{k-1} \text{RMod}_A(\Omega^{k-1}\mathcal{C}) \simeq \text{RMod}_{\Sigma^{k-1}A}(\mathcal{C}). \quad (5.2.9)$$

Note that (5.2.7) is an immediate consequence of (5.2.9), respectively.

We reformulate (5.2.9) as mathematical results below.

**Theorem 5.2.5.** Let  $\mathcal{B}$  be an  $E_k$ -fusion  $n$ -category and  $A \in \text{Alg}_{E_k}^{\mathcal{C}}(\mathcal{B})$ . We set  $\Sigma^0 A = A$  and, for  $1 \leq i < k$ , we define inductively  $\Sigma^i A = \text{RMod}_{\Sigma^{i-1}A}(\Sigma^{i-1}\mathcal{B})$ . We have a natural  $E_{k-i}$ -monoidal equivalence:

$$\text{Mod}_A^{E_k}(\mathcal{B}) \simeq \Omega^i \text{Mod}_{\Sigma^i A}^{E_{k-i}}(\Sigma^i \mathcal{B}). \quad (5.2.10)$$

Moreover, we have a natural  $E_{k-1-i}$ -monoidal equivalence and an  $E_{k-1}$ -monoidal equivalence, respectively, given as follows:

$$\Sigma^i \text{RMod}_A(\mathcal{B}) \simeq \text{RMod}_{\Sigma^i A}(\Sigma^i \mathcal{B}), \quad \text{RMod}_A(\mathcal{B}) \simeq \Omega^i \text{RMod}_{\Sigma^i A}(\Sigma^i \mathcal{B}). \quad (5.2.11)$$

**Remark 5.2.6.** When  $i = k$ , (5.2.10) still make sense and can be viewed as the definition of  $E_0$ -modules over an  $E_0$ -algebra.  $\diamond$

The following result generalizes the equivalence (3.2.5).





However, it is not true that condensing  $[1_m^k, 1_m^k]_{\Omega^k \mathcal{C}}$  can recover the gapped domain wall  $M^n$ . In general,  $\text{RMod}_{[1_m^k, 1_m^k]_{\Omega^k \mathcal{C}}}(\Omega^k \mathcal{C})$  is only a sub-fusion category of  $\Omega_m^k \mathcal{M}$ . However, if  $\mathcal{C} = \Sigma^k \Omega^k \mathcal{C}$  and  $M^n$  is obtained from the condensation of  $A \in \text{Alg}_{\mathbb{E}_{k+1}}^{\mathcal{C}}(\Omega^k \mathcal{C})$ , then we must have  $A = [1_m^k, 1_m^k]_{\Omega^k \mathcal{C}}$ .  $\diamond$

The basic idea behind all explicit constructions of condensable  $E_k$ -algebras in an  $E_k$ -fusion  $n$ -category  $\mathcal{B}$  is to find a nice coordinate system for  $\mathcal{B}$ . For example, assume  $\mathcal{B} = \Sigma \mathfrak{Z}_k(\mathcal{A})$  for an  $E_k$ -fusion  $(n-1)$ -category  $\mathcal{A}$ . In this case, we have

$$\Sigma \mathfrak{Z}_k(\mathcal{A}) = \text{RMod}_{\mathfrak{Z}_k(\mathcal{A})}(n\text{Vec}) \simeq \Sigma \Omega \text{Mod}_{\mathcal{A}}^{E_k}(n\text{Vec}), \quad (5.2.13)$$

Indeed, note that  $\mathfrak{Z}_k(\mathcal{A}) \simeq \text{Fun}_{\mathcal{A}}^{E_k}(\mathcal{A}, \mathcal{A}) \simeq \Omega(\text{Mod}_{\mathcal{A}}^{E_k}(n\text{Vec}))$ , which is a mathematical fact follows directly from the universal property of the  $E_k$ -center  $\mathfrak{Z}_k(-)$  (see [Lur17, Fra12]). Note that a simple condensable  $E_k$ -algebra in  $\text{Mod}_{\mathcal{A}}^{E_k}(n\text{Vec})$  is precisely an  $E_k$ -fusion  $(n-1)$ -category  $\mathcal{P}$  equipped with an  $E_k$ -monoidal functor  $\phi : \mathcal{A} \rightarrow \mathcal{P}$ . Therefore, a condensable  $E_k$ -algebra in  $\mathcal{B}$  is precisely an  $E_k$ -fusion  $(n-1)$ -category  $\mathcal{P}$  lying in  $\Sigma \Omega \text{Mod}_{\mathcal{A}}^{E_k}(n\text{Vec})$  and equipped with an  $E_k$ -monoidal functor  $\phi : \mathcal{A} \rightarrow \mathcal{P}$ .

**Example 5.2.11.** Let  $\mathcal{A}$  be an  $E_k$ -fusion  $(n-1)$ -category. Then the canonical  $E_k$ -monoidal functor  $\mathcal{A} \rightarrow \mathfrak{Z}_k(\mathcal{A})$  defines an condensable  $E_k$ -algebra in  $\Sigma \mathfrak{Z}_k(\mathcal{A})$ . This example includes Example 3.2.22 as a special case when  $k = 1$ .  $\heartsuit$

### 5.2.3 Examples

**Example 5.2.12.** In the 3+1D  $\mathbb{Z}_2$ -gauge theory  $\text{GT}_{\mathbb{Z}_2}^4$ , condensing the  $e$ -particles amounts to the following procedure.

1. We first condensing the  $e$ -particle along a line, we obtain the  $\mathbb{1}_c$ -string. Mathematically, it amounts to condense the condensable  $E_3$ -algebra  $A_e = \mathbb{1}_{\mathbb{1}} \oplus e$  in  $\Omega^2 \mathcal{T}\mathcal{C} = \text{Rep}(\mathbb{Z}_2)$ . The  $\mathbb{1}_c$ , as an object in  $2\text{Rep}(G)$ , can be identified with  $\Sigma A_e = \text{RMod}_{A_e}(\text{Rep}(\mathbb{Z}_2)) \simeq \text{Vec}$  in  $2\text{Rep}(\mathbb{Z}_2) = \text{RMod}_{\text{Rep}(\mathbb{Z}_2)}(2\text{Vec})$ .
2. Then we condense the  $\mathbb{1}_c$ -string as a condensable  $E_2$ -algebra in  $\Omega \mathcal{G}\mathcal{T}_{\mathbb{Z}_2}^4 = \mathfrak{Z}_1(2\text{Vec}_{\mathbb{Z}_2})$ , we obtain the trivial phase  $\mathbf{1}^4$  as the condensed phase and the rough boundary, topological defects on which form a fusion 2-category  $2\text{Vec}_{\mathbb{Z}_2}$ .
3. One can also condense  $\mathbb{1}_c$  along a hyperplane in 3-dimensional space and produces a topological defect  $\Sigma \mathbb{1}_c$ , which is a condensable  $E_1$ -algebra in  $\mathcal{G}\mathcal{T}_{\mathbb{Z}_2}^4$ . Now we condense  $\Sigma \mathbb{1}_c$ . We obtain again the trivial phase  $\mathbf{1}^4$  as the condensed phase and the same rough boundary of  $\text{GT}_{\mathbb{Z}_2}^4$ .  $\heartsuit$

**Example 5.2.13.** For  $n \geq 2$ , in the  $n+1$ D  $G$ -gauge theory  $\text{GT}_G^{n+1}$ ,  $\mathcal{G}\mathcal{T}_G$  is a fusion  $n$ -category with a trivial  $\mathfrak{Z}_1$ -center. Its particles form a symmetric fusion 1-category  $\Omega^{n-1} \mathcal{G}\mathcal{T}_G = \text{Rep}(G)$ . The commutative algebra  $A = \text{Fun}(G)$  of all  $\mathbb{C}$ -valued functions on  $G$  is an  $E_n$ -algebra in  $\Omega^{n-1} \mathcal{G}\mathcal{T}_G = \text{Rep}(G)$ . As a composed particle,  $\text{Fun}(G)$  can be condensed. More precisely, by condensing the  $\text{Fun}(G)$ -particles, we mean the following procedures.

1. We first condensing the  $\text{Fun}(G)$ -particle along a line, we obtain a string  $\Sigma A$ , which is precisely  $\text{Vec} = \text{RMod}_A(\text{Rep}(G))$  in  $2\text{Rep}(G) \subset \Omega^{n-2} \mathcal{G}\mathcal{T}_G$ . Note that the right  $\text{Rep}(G)$ -module on  $\text{Vec}$  is induced from the forgetful functor  $f : \text{Rep}(G) \rightarrow \text{Vec}$ , which is monoidal. Note that all the  $G$ -symmetry is broken in this condensation, or equivalently, or all particles (i.e.,  $G$ -symmetry charges) are condensed.
2. We further condense the  $\Sigma A$ -string and repeat the procedure. In the last step, we condense  $\Sigma^{n-1} A$  as a condensable  $E_1$ -algebra in  $\mathcal{G}\mathcal{T}_G$ . It produces the trivial phase  $\mathbf{1}^{n+1}$  as the condensed phase. This is just a reformulation of the physical fact that when we breaking the  $G$ -symmetry completely

in the trivial SPT order  $\text{GT}_G^{n+1}$ , we obtain the trivial topological order  $\mathbf{1}^{n+1}$  [KLWZZ20b]. This condensation also produces a gapped domain wall  $M^n$ , topological defects on which form the fusion  $n$ -category  $n\text{Vec}_G$ .

## 6 Generalizations and Applications

In this work, we have developed a general theory of the condensations of topological defects in higher dimensions. In this section, we show that this theory leads to many new interesting questions, generalizations, applications and outlooks. We want to emphasize that this work is not an end of condensation theory but a beginning of a much richer theory in both mathematics and physics. For example, the natural questions in condensations lead us to a general higher Morita theory; the physical intuition of integrating local observables to a global leads us to a more general theory of factorization homology; the generalization to non-topological (i.e. gapless) liquid-like defects leads us a more complete theory of condensation. In this section, we can only scratch the surfaces of these directions but leave the thorough development to future publications.

### 6.1 Higher Morita theory

In this subsection, we study some questions that naturally arise from the physics of condensations. The most basic question is when two condensations produce the same condensed phase or the same condensed defect.

#### 6.1.1 Higher Morita equivalences

Given a topological order  $C^{n+1}$  and two condensations defined by  $A, B \in \text{Alg}_{E_1}^c(\mathcal{C})$ , it is natural to ask when they produce the same condensed phase  $D^{n+1}$ . We formulate the question in more mathematical terms.

**Definition 6.1.1.** Let  $\mathcal{B} \in \text{Alg}_{E_1}^c((n+1)\text{Vec})$  and  $A, B \in \text{Alg}_{E_1}^c(\mathcal{B})$ .

- For  $\mathcal{M} \in \text{Mod}_{\mathcal{B}}^{E_1}((n+1)\text{Vec})$ ,  $A$  and  $B$  are called *Mod $^{E_1}(\mathcal{M})$ -equivalent* if  $\text{Mod}_A^{E_1}(\mathcal{M}) \simeq \text{Mod}_B^{E_1}(\mathcal{M})$  in  $\text{Alg}_{E_1}^c((n+1)\text{Vec})$ . When  $\mathcal{M} = \mathcal{B}$ , we abbreviate this equivalence to *Mod $^{E_1}$ -equivalence*.
- For  $\mathcal{N} \in \text{LMod}_{\mathcal{B}}((n+1)\text{Vec})$ ,  $A$  and  $B$  are called *LMod $(\mathcal{N})$ -equivalent* if  $\text{LMod}_A(\mathcal{N}) \simeq \text{LMod}_B(\mathcal{N})$  in  $(n+1)\text{Vec}$ . When  $\mathcal{N} = \mathcal{B}$ , we abbreviate this equivalence to *LMod-equivalence*, which is just the usual Morita equivalence. The definition of a *RMod $(\mathcal{P})$ -equivalence* for  $\mathcal{P} \in \text{RMod}_{\mathcal{B}}((n+1)\text{Vec})$  is similar.

**Example 6.1.2.** Recall that topologically Morita equivalent topological orders can be obtained from each other via condensations of 1-codimensional topological defects. Therefore, for fusion  $n$ -category  $\mathcal{C}$  with a trivial  $E_1$ -center, there is a one-to-one correspondence between the  $\text{Mod}^{E_1}$ -equivalence classes of simple condensable  $E_1$ -algebras in  $\mathcal{C}$  and the isomorphic classes of non-degenerate braided fusion  $(n-1)$ -categories within the Witt class of  $[\Omega\mathcal{C}]$ .  $\heartsuit$

**Example 6.1.3.** Recall Theorem 3.2.24, for a fixed  $\mathcal{P}$ , all the condensable  $E_1$ -algebras  $\text{Fun}_{\text{pop}}(\mathcal{X}, \mathcal{X})$  in  $\mathcal{C} = \text{BMod}_{\mathcal{B}|\mathcal{B}}(n\text{Vec})$  for  $\mathcal{X} \in \text{BMod}_{\mathcal{B}|\mathcal{P}}(n\text{Vec})$  are all  $\text{Mod}^{E_1}$ -equivalent.  $\heartsuit$

**Proposition 6.1.4.** If  $A$  and  $B$  are LMod-equivalence, then they are  $\text{Mod}^{E_1}$ -equivalent.

*Proof.* When  $A$  and  $B$  are LMod-equivalent, set  $\mathcal{M} = \text{LMod}_A(\mathcal{B}) \simeq \text{LMod}_B(\mathcal{B})$ . We have  $\text{Mod}_A^{E_1}(\mathcal{B}) \simeq \text{Fun}_{\mathcal{B}}(\mathcal{M}, \mathcal{M})^{\text{op}} \simeq \text{Mod}_B^{E_1}(\mathcal{B})$ .  $\square$

**Remark 6.1.5.** Conversely,  $\text{Mod}^{E_1}$ -equivalence does not imply LMod-equivalence. We give an example. For  $\mathcal{B} = \text{Rep}(\mathbb{Z}_2)$  and  $A = \mathbb{1}, B = \mathbb{1} \oplus e \in \text{Alg}_{E_1}^c(\text{Rep}(\mathbb{Z}_2))$ , we have

$$\text{LMod}_A(\text{Rep}(\mathbb{Z}_2)) \simeq \text{Rep}(\mathbb{Z}_2), \quad \text{LMod}_B(\text{Rep}(\mathbb{Z}_2)) \simeq \text{Vec}.$$

On the other hand, we have  $\text{Mod}_A^{\mathbb{E}_1}(\text{Rep}(\mathbb{Z}_2)) \simeq \text{Vec}_{\mathbb{Z}_2} \simeq \text{Fun}_{\text{Rep}(\mathbb{Z}_2)}(\text{Vec}, \text{Vec}) \simeq \text{Mod}_B^{\mathbb{E}_1}(\text{Rep}(\mathbb{Z}_2))$ . One of the key reasons for this example to exist is that the  $\mathbb{E}_1$ -center of  $\text{Rep}(\mathbb{Z}_2)$  (or  $\text{Vec}_{\mathbb{Z}_2}$ ) has a braided auto-equivalence. If we forbid this possibility, it is likely to find an equivalence of these two notions. We give an example in the next proposition.  $\diamond$

**Proposition 6.1.6.** If  $\mathcal{B}$  is non-degenerate, then  $A$  and  $B$  are  $\text{LMod}$ -equivalent if and only if they are  $\text{Mod}^{\mathbb{E}_1}$ -equivalent.

**Remark 6.1.7.** The discrepancy between these two equivalences can be viewed as a sign of the anomaly of  $\mathcal{B}$ . Moreover, this discrepancy encodes the anomaly quantitatively.  $\diamond$

We generalize the equivalences in Definition 6.1.1 to  $\mathbb{E}_k$ -algebras.

**Definition 6.1.8.** Let  $\mathcal{B} \in \text{Alg}_{\mathbb{E}_k}^c((n+1)\text{Vec})$  and  $A, B \in \text{Alg}_{\mathbb{E}_k}^c(\mathcal{B})$ .

1. For  $\mathcal{M} \in \text{Mod}_{\mathcal{B}}^{\mathbb{E}_k}((n+1)\text{Vec})$ ,  $A$  and  $B$  are called  $\text{Mod}^{\mathbb{E}_k}(\mathcal{M})$ -equivalent if

$$\text{Mod}_A^{\mathbb{E}_k}(\mathcal{M}) \simeq \text{Mod}_B^{\mathbb{E}_k}(\mathcal{M}) \quad \in \text{Alg}_{\mathbb{E}_k}^c((n+1)\text{Vec}).$$

When  $\mathcal{M} = \mathcal{B}$ , we abbreviate ‘ $\text{Mod}^{\mathbb{E}_k}(\mathcal{B})$ -equivalent’ to ‘ $\text{Mod}^{\mathbb{E}_k}$ -equivalent’.

2. For  $l < k$  and  $\mathcal{N} \in \text{LMod}_{\mathcal{B}}(\text{Alg}_{\mathbb{E}_l}^c(n+1)\text{Vec})$ ,  $A$  and  $B$  are called  $\text{LMod}(\mathcal{N})$ - $\mathbb{E}_l$ -equivalent if

$$\text{LMod}_A(\mathcal{N}) \simeq \text{LMod}_B(\mathcal{N}) \quad \in \text{Alg}_{\mathbb{E}_l}^c((n+1)\text{Vec}).$$

When  $\mathcal{N} = \mathcal{B} \in \text{LMod}_{\mathcal{B}}(\text{Alg}_{\mathbb{E}_{k-1}}^c(n+1)\text{Vec})$ , we abbreviate the  $\text{LMod}(\mathcal{N})$ - $\mathbb{E}_{k-1}$ -equivalence to  $\text{LMod}$ - $\mathbb{E}_{k-1}$ -equivalence. We denote  $\Sigma A(\mathcal{N}) := \text{LMod}_A(\mathcal{N})$  and  $\Sigma A(\mathcal{B}) = \Sigma A$ .

3. Recall that  $\Sigma \mathcal{B} = \text{RMod}_{\mathcal{B}}((n+1)\text{Vec}) \in \text{Alg}_{\mathbb{E}_{k-1}}^c((n+2)\text{Vec})$  and  $\Sigma A \in \text{Alg}_{\mathbb{E}_{k-1}}^c(\Sigma \mathcal{B})$ . We define  $\Sigma^p A$  for  $p > 1$  iteratively as  $\Sigma^p A = \text{LMod}_{\Sigma^{p-1} A}(\Sigma^{p-1} \mathcal{B}) \in \text{Alg}_{\mathbb{E}_{k-p}}^c(\Sigma^p \mathcal{B})$ . Then  $A$  and  $B$  are called  $k$ -Morita equivalent if  $\Sigma^k A \simeq \Sigma^k B$  in  $\Sigma^k \mathcal{B}$ .  $\blacksquare$

**Example 6.1.9.** We give an example of  $k$ -Morita equivalence when  $\mathcal{B} = n\text{Vec}$ . We spell out the  $k$ -Morita equivalence in this case more explicitly.

- Two  $\mathbb{E}_k$ -multi-fusion  $n$ -categories  $\mathcal{A}$  and  $\mathcal{B}$  are called  $k$ -Morita equivalent if  $\Sigma^k \mathcal{A} \simeq \Sigma^k \mathcal{B}$  as separable  $(n+k)$ -categories.

This  $k$ -Morita equivalence generalizes the usual Morita equivalence and Witt equivalence.

1. When  $k = 1$ , 1-Morita equivalence is precisely the usual Morita equivalence.
2. When  $k = 2$  and both  $\mathcal{A}$  and  $\mathcal{B}$  are nondegenerate, the 2-Morita equivalence is precisely the usual Witt equivalence [JF22, KZ22b]. The advantage of the notion of 2-Morita equivalence is that it also works for (not nondegenerate) braided fusion categories.

The  $k$ -Morita equivalence is clearly a well-defined equivalence relation. We denote the  $k$ -Morita equivalence class associated to  $\mathcal{A}$  by  $[\mathcal{A}]_k$ .  $\heartsuit$

**Example 6.1.10.** Let  $\mathcal{B}$  be a non-degenerate braided fusion 1-category. Then all Lagrangian algebras in  $\mathcal{B}$  are  $\text{Mod}^{\mathbb{E}_2}$ -equivalent by definition. It is an interesting question to work out when two condensable  $\mathbb{E}_2$ -algebra in  $\mathcal{B}$  are  $\text{Mod}^{\mathbb{E}_2}$ -equivalent.  $\heartsuit$

**Remark 6.1.11.** When  $\mathcal{B}$  is non-degenerate, the functor  $\Sigma(-) : \text{Alg}_{E_2}^c(\mathcal{B}) \rightarrow \text{Alg}_{E_1}^c(\Sigma\mathcal{B})$  induces a bijection from the set of  $\text{Mod}^{E_2}$ -equivalence classes of condensable  $E_2$ -algebras in  $\Omega\mathcal{C}$  to the set of  $\text{Mod}^{E_1}$ -equivalence classes of 2-condensable  $E_1$ -algebras in  $\mathcal{C}$ .  $\diamond$

**Lemma 6.1.12.** For  $\mathcal{A} \in \text{Alg}_{E_k}^c((n+1)\text{Vec})$  and  $A \in \text{Alg}_{E_k}^c(\mathcal{A})$ ,  $\mathcal{A}$  and  $\text{Mod}_A^{E_k}(\mathcal{A})$  are  $k$ -Morita equivalent.

*Proof.* It is obviously true for  $k = 1$ . For  $k > 1$ , we have

$$\Sigma^k \text{Mod}_A^{E_k}(\mathcal{A}) = \Sigma^k \Omega^{k-1} \text{Mod}_{\Sigma^{k-1}A}^{E_1}(\Sigma^{k-1}\mathcal{A}) \simeq \Sigma^k \Omega^k \Sigma \text{Mod}_{\Sigma^{k-1}A}^{E_1}(\Sigma^{k-1}\mathcal{A}) \simeq \Sigma^k \Omega^k \Sigma \Sigma^{k-1}\mathcal{A} \simeq \Sigma^k \mathcal{A}.$$

**Proposition 6.1.13.** For  $\mathcal{A}, \mathcal{B} \in \text{Alg}_{E_k}^c((n+1)\text{Vec})$ , if  $\mathcal{A}$  and  $\mathcal{B}$  are  $k$ -Morita equivalent, then  $\mathfrak{Z}_k(\mathcal{A}) \simeq \mathfrak{Z}_k(\mathcal{B})$  in  $\text{Alg}_{E_{k+1}}^c((n+1)\text{Vec})$ .

*Proof.* We have  $E_{k+1}$ -monoidal equivalences:  $\mathfrak{Z}_k(\mathcal{A}) \simeq \Omega^k \mathfrak{Z}_0(\Sigma^k \mathcal{A}) \simeq \Omega^k \mathfrak{Z}_0(\Sigma^k \mathcal{B}) \simeq \mathfrak{Z}_k(\mathcal{B})$ .  $\square$

The following Lemma is a result in [Lur17, Fra12] reformulated in the world of separable  $n$ -categories.

**Lemma 6.1.14.** For  $\mathcal{A} \in \text{Alg}_{E_k}^c((n+1)\text{Vec})$ , we have

$$\mathfrak{Z}_m(\mathcal{A}) \simeq \text{hom}_{\text{Mod}_{\mathcal{A}}^{E_k}((n+1)\text{Vec})}(\mathcal{A}, \mathcal{A}) \in \text{Alg}_{E_{k+1}}^c((n+1)\text{Vec}).$$

**Proposition 6.1.15.** For  $\mathcal{A}, \mathcal{B} \in \text{Alg}_{E_k}^c((n+1)\text{Vec})$ , if  $\mathcal{A}$  and  $\mathcal{B}$  are  $\text{Mod}^{E_k}$ -equivalent, then  $\mathfrak{Z}_k(\mathcal{A}) \simeq \mathfrak{Z}_k(\mathcal{B})$ .

**Proposition 6.1.16.** For  $\mathcal{B} \in \text{Alg}_{E_k}^c((n+1)\text{Vec})$  and  $A, B \in \text{Alg}_{E_k}^c(\mathcal{B})$ , if  $A, B \in \text{Alg}_{E_k}^c(\mathcal{B})$  are  $k$ -Morita equivalent, then they are  $\text{Mod}^{E_k}$ -equivalent.

*Proof.* It follows from  $\text{Mod}_A^{E_k}(\mathcal{B}) \simeq \Omega^{k-1} \text{Mod}_{\Sigma^{k-1}A}^{E_1}(\Sigma^{k-1}\mathcal{B}) \simeq \Omega^{k-1} \text{Mod}_{\Sigma^{k-1}B}^{E_1}(\Sigma^{k-1}\mathcal{B}) \simeq \text{Mod}_B^{E_k}(\mathcal{B})$ , where the second ‘ $\simeq$ ’ is a consequence of the assumption  $\Sigma^k A \simeq \Sigma^k B$  in  $\Sigma^k \mathcal{B}$  and Proposition 6.1.4.  $\square$

## 6.1.2 Enveloping algebras

In order to study the  $\text{Mod}^{E_k}$ -equivalence among  $E_k$ -algebras, it is beneficial to introduce an  $\text{Mod}^{E_k}$ -invariant, which is called the enveloping algebra  $U_A$  of an  $E_k$ -algebra  $A \in \text{Alg}_{E_k}^c(\mathcal{C})$  for an  $E_k$ -fusion  $n$ -category  $\mathcal{C}$  such that  $\text{Mod}_A^{E_k}(\mathcal{C}) \simeq \text{LMod}_{U_A}(\mathcal{C})$ . This notion allows us to reduce the problem of studying  $\text{Mod}^{E_k}$ -equivalence to that of studying usual Morita equivalence.

Let us start from the  $k = 1$  case. Let us first recall an  $E_1$ -algebra  $A$  in  $\text{Vec}$  is just an ordinary  $\mathbb{C}$ -algebra. An  $A$ - $A$ -bimodule is the same as a left  $A \otimes_{\mathbb{C}} A^{\text{op}}$ -module. Therefore,  $U_A = A \otimes_{\mathbb{C}} A^{\text{op}}$ . However, this construction does not generalize to  $A \in \text{Alg}_{E_1}^c(\mathcal{C})$  naively because  $\mathcal{C}$  is only monoidal without braidings.

In order to find the proper definition, we first look at the physical meaning behind the data  $A$  and  $\mathcal{C}$ . When  $k = 1$ , the fusion  $n$ -category  $\mathcal{C}$  is the category of topological defects of an  $n+1$ D topological order, which has potentially non-trivial gravitational anomaly  $Z(\mathcal{C})^{n+2}$  as illustrated in Figure 13 (a), where  $x \in \text{Mod}_A^{E_1}(\mathcal{C})$  and only 1-spatial-dimension (the horizontal direction) is shown and the remaining  $(n-1)$ -spatial-dimensions are orthogonal to the paper. Since the remaining dimensions do not appear in our discussion. Without loss of generality, we can simply assume  $n = 1$ . Since 1-codimensional topological defects in  $Z(\mathcal{C})^{n+2}$  change the boundary condition, we only consider 2-codimensional topological defects in  $Z(\mathcal{C})^{n+2}$ . They form a braided fusion  $n$ -category given by the Drinfeld center  $\mathfrak{Z}_1(\mathcal{C})$  of  $\mathcal{C}$  by boundary-bulk relation [KWZ15, KWZ17].

The shaded region is  $D^1 \times \mathbb{R}$ , where  $D^1$  is an oriented closed 1-disk and its oriented boundary is a 0-sphere, i.e.  $\partial D^1 = \partial D_+^1 \cup \partial D_-^1 = S^0 = \{+, -\}$ . Notice that the macroscopic observables in the interior

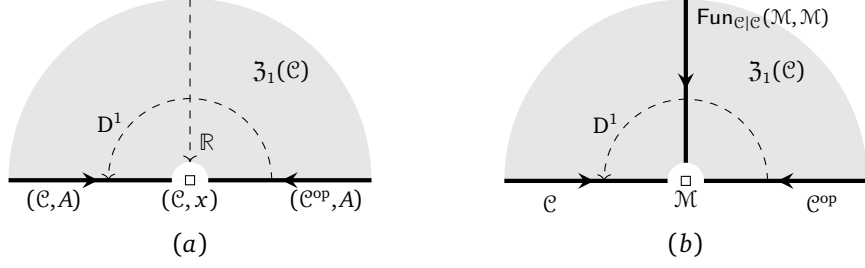

Figure 13: Physical intuition of the enveloping algebras of  $\mathcal{C}$  and  $A \in \text{Alg}_{E_1}^c(\mathcal{C})$

of the shaded region (i.e.  $\mathring{D}^1 \times \mathbb{R}$ ) is given by  $\mathfrak{Z}_1(\mathcal{C})$ . We denote this fact by  $\text{Obs}(\mathring{D}^1 \times \mathbb{R}) = \mathfrak{Z}_1(\mathcal{C})$ . Similarly, we have  $\text{Obs}(\partial D_+^1 \times \mathbb{R}) = \mathcal{C}$  and  $\text{Obs}(\partial D_-^1 \times \mathbb{R}) = \mathcal{C}^{\text{op}}$ , which should be viewed as observables living in an open neighborhood of  $\partial D_{\pm} \times \mathbb{R}$ . One can summarize all the observables living in the shaded region  $D^1 \times \mathbb{R}$  by integrating them over the whole region [AKZ17]. More explicitly, we have

$$\begin{aligned} \text{Obs}(D^1 \times \mathbb{R}) &= \int_{D^1 \times \mathbb{R}} (\text{Obs}(\mathring{D}^1 \times \mathbb{R}), \text{Obs}(\partial D_+^1 \times \mathbb{R}), \text{Obs}(\partial D_-^1 \times \mathbb{R})) \\ &= \int_{D^1 \times \mathbb{R}} (\mathfrak{Z}_1(\mathcal{C})|_{\mathring{D}^1 \times \mathbb{R}}, \mathcal{C}|_{\partial D_+^1 \times \mathbb{R}}, \mathcal{C}^{\text{op}}|_{\partial D_-^1 \times \mathbb{R}}) := \mathcal{C} \boxtimes_{\mathfrak{Z}_1(\mathcal{C})} \mathcal{C}^{\text{op}}, \end{aligned} \quad (6.1.1)$$

where  $\boxtimes_{\mathfrak{Z}_1(\mathcal{C})}$  is the relative tensor product over  $\mathfrak{Z}_1(\mathcal{C})$ . One way to see why  $\mathcal{C} \boxtimes_{\mathfrak{Z}_1(\mathcal{C})} \mathcal{C}^{\text{op}}$  is qualified to be called the ‘global observable’ is to show that  $\text{Obs}(\mathring{D}^1 \times \mathbb{R})$ ,  $\text{Obs}(\partial D_+ \times \mathbb{R})$ ,  $\text{Obs}(\partial D_- \times \mathbb{R})$  naturally map into the global one. Indeed, one can define these three maps explicitly and precisely below.

$$\begin{aligned} \mathcal{C} &\rightarrow \mathcal{C} \boxtimes_{\mathfrak{Z}_1(\mathcal{C})} \mathcal{C}^{\text{op}}, & \mathfrak{Z}_1(\mathcal{C}) &\rightarrow \mathcal{C} \boxtimes_{\mathfrak{Z}_1(\mathcal{C})} \mathfrak{Z}_1(\mathcal{C}) \boxtimes_{\mathfrak{Z}_1(\mathcal{C})} \mathcal{C}^{\text{op}} \simeq \mathcal{C} \boxtimes_{\mathfrak{Z}_1(\mathcal{C})} \mathcal{C}^{\text{op}}, & \mathcal{C}^{\text{op}} &\rightarrow \mathcal{C} \boxtimes_{\mathfrak{Z}_1(\mathcal{C})} \mathcal{C}^{\text{op}} \\ a &\mapsto a \boxtimes_{\mathfrak{Z}_1(\mathcal{C})} \mathbb{1}_{\mathcal{C}}, & z &\mapsto \mathbb{1}_{\mathcal{C}} \boxtimes_{\mathfrak{Z}_1(\mathcal{C})} z \boxtimes_{\mathfrak{Z}_1(\mathcal{C})} \mathbb{1}_{\mathcal{C}}, & b &\mapsto \mathbb{1}_{\mathcal{C}} \boxtimes_{\mathfrak{Z}_1(\mathcal{C})} b \end{aligned}$$

Moreover, all three maps preserve the  $E_1$ -algebraic structure of three observables algebras. In other words, they are all monoidal functors as required by the obvious physical intuitions.

Therefore, it is clear that the two-side  $A$ -action on  $x$  is the same as the left  $A \boxtimes A$ -action on  $x$  through the following three logical steps:

1.  $A \boxtimes A$  is an  $E_1$ -algebra in  $\mathcal{C} \boxtimes \mathcal{C}^{\text{op}}$ .
2. There are two canonical monoidal functors:

$$\begin{aligned} \mathcal{C} \boxtimes \mathcal{C}^{\text{op}} &\xrightarrow{\boxtimes_{\mathfrak{Z}_1(\mathcal{C})}} \mathcal{C} \boxtimes_{\mathfrak{Z}_1(\mathcal{C})} \mathcal{C}^{\text{op}} \xrightarrow{\simeq} \text{Fun}(\mathcal{C}, \mathcal{C}) \\ a \boxtimes b &\mapsto a \boxtimes_{\mathfrak{Z}_1(\mathcal{C})} b \mapsto a \otimes - \otimes b, \end{aligned} \quad (6.1.2)$$

where the relative tensor product  $\mathcal{C} \boxtimes_{\mathfrak{Z}_1(\mathcal{C})} \mathcal{C}^{\text{op}}$  amounts to closing fan in Figure 13 and the equivalence ‘ $\simeq$ ’ is due to the boundary-bulk relation [KWZ15, KWZ17]. Therefore,  $A \boxtimes A$  is mapped to an  $E_1$ -algebra in  $\text{Fun}(\mathcal{C}, \mathcal{C})$ .

3.  $\text{Fun}(\mathcal{C}, \mathcal{C})$  acts on  $\mathcal{C}$  canonically. Therefore,  $A \boxtimes A$  acts on  $x \in \mathcal{C}$  canonically. More precisely, by (6.1.2), this action  $(A \boxtimes A) \otimes x := A \otimes x \otimes A$  is precisely the correct two-side  $A$ -action.

Therefore, the correct definition of  $U_A$  is  $A \boxtimes A \in \mathcal{C} \boxtimes \mathcal{C}^{\text{op}}$ .

**Remark 6.1.17.** Note that the fusion product  $\otimes$  in the category  $\mathcal{C} \boxtimes_{\mathfrak{Z}_1(\mathcal{C})} \mathcal{C}^{\text{op}}$  is defined by

$$(a \boxtimes_{\mathfrak{Z}_1(\mathcal{C})} b) \otimes (a' \boxtimes_{\mathfrak{Z}_1(\mathcal{C})} b') := (a \otimes_{\mathcal{C}} a') \boxtimes_{\mathfrak{Z}_1(\mathcal{C})} (b' \otimes_{\mathcal{C}} b').$$

Geometrically, it says that, by integrating over  $D^1$ , the fusion product along this  $D^1$ -direction in  $\mathfrak{Z}_1(\mathcal{C})$  has been integrated out, and no longer makes sense after the integration. However, the fusions along the  $\mathbb{R}$ -direction remains a well-defined fusion product. By ignoring the fusion products in  $\mathcal{C}, \mathfrak{Z}_1(\mathcal{C}), \mathcal{C}^{\text{op}}$  in the  $\mathbb{R}$ -direction, it makes sense to integrate over  $D^1$  only. Moreover, in  $2\text{Vec}$ , we have

$$\int_{D^1 \times \mathbb{R}} (\mathfrak{Z}_1(\mathcal{C})|_{\partial D^1 \times \mathbb{R}}, \mathcal{C}|_{\partial D^1 \times \mathbb{R}}, \mathcal{C}^{\text{op}}|_{\partial D^1 \times \mathbb{R}}) = \int_{D^1} (\mathfrak{Z}_1(\mathcal{C})|_{\partial D^1}, \mathcal{C}|_{\partial D^1}, \mathcal{C}^{\text{op}}|_{\partial D^1}).$$

Since remembering the fusion product in the  $\mathbb{R}$ -direction in the right hand side causes no confusion, we agree that above identity holds in  $\text{Alg}_{E_1}((n+1)\text{Vec})$  as well. We use them interchangeably.  $\diamond$

Before we give the official definition of  $U_A$ , we first discuss the meaning of  $\mathcal{C} \boxtimes \mathcal{C}^{\text{op}}$ . Since  $\mathcal{C}$  is an  $E_1$ -algebra in  $(n+1)\text{Vec}$ , mathematically, an  $\mathcal{C}$ - $\mathcal{C}$ -module is precisely a left  $\mathcal{C} \boxtimes \mathcal{C}^{\text{op}}$ -module. This mathematical fact has a nice physical meaning as shown in Remark 6.1.18. Therefore,  $\mathcal{C} \boxtimes \mathcal{C}^{\text{op}}$  is precisely the enveloping algebra of  $\mathcal{C}$ .

**Remark 6.1.18.** The physical meaning of a  $\mathcal{C}$ - $\mathcal{C}$ -bimodule  $\mathcal{M}$  is a the category of all wall conditions on a gapped domain wall  $M^n$  between  $C^{n+1}$  and  $C^{n+1}$  as illustrated in Figure 13 (b). Moreover, this wall uniquely determines a relative bulk or a relative gravitational anomaly  $Z^{(1)}(M)^{n+1}$  such that the category of topological defects on it is given by  $\text{Fun}_{\mathcal{C}|\mathcal{C}}(\mathcal{M}, \mathcal{M})$  (recall Figure 3) [KWZ15, KZ21a]. By definition, to say  $\mathcal{M}$  is a  $\mathcal{C}$ - $\mathcal{C}$ -bimodule is equivalent to say there is a monoidal functor from  $f : \mathcal{C} \boxtimes \mathcal{C}^{\text{op}}$  to  $\text{Fun}(\mathcal{M}, \mathcal{M})$ , which is precisely a morphism from  $C^{n+1} \boxtimes \overline{C^{n+1}}$  to  $Z(M)^{n+1}$ . By the definition of a morphism between topological order [KWZ15, KWZ17], this morphism is precisely defined by the domain wall  $Z^{(1)}(M)^{n+1}$  between  $Z(C)^{n+2}$  and  $Z(C)^{n+2}$  (see also [KZ18a, KZ21a]).  $\diamond$

We summarize above discussion in the following mathematical definition and Lemma.

**Definition 6.1.19.** For  $\mathcal{C} \in \text{Alg}_{E_1}^c(2\text{Vec})$ , we define its enveloping algebra  $U_{\mathcal{C}}$  in  $(n+1)\text{Vec}$  as follows:

$$U_{\mathcal{C}} := \int_{S^0} \mathcal{C} := \mathcal{C} \boxtimes \mathcal{C}^{\text{op}} \in \text{Alg}_{E_1}^c((n+1)\text{Vec}). \quad (6.1.3) \quad \blacksquare$$

where  $S^0$  denotes the 0-sphere consisting of two points, i.e.  $S^0 = \{+, -\}$ . For  $A \in \text{Alg}_{E_1}^c(\mathcal{C})$ , we define the enveloping algebra  $U_A$  of  $A$  as follows:

$$U_A := \int_{S^0} A = A \boxtimes A \in \text{Alg}_{E_1}^c(U_{\mathcal{C}}).$$

**Remark 6.1.20.** One can also view the pair  $(\mathcal{C}, A)$  as an  $E_1$ -algebra [Str12] and its enveloping algebra is also defined by a pair  $U_{(\mathcal{C}, A)} := (U_{\mathcal{C}}, U_A) = \int_{S^0} (\mathcal{C}, A)$ .  $\diamond$

Since  $\mathcal{C}$  is naturally a left  $U_{\mathcal{C}}$ -module, it makes sense to talk about a left  $U_A$ -module in  $\mathcal{C}$ . More precisely, a left  $U_A$ -module in  $\mathcal{C}$  is an object  $x \in \mathcal{C}$  equipped with a unital left  $U_A$ -action  $\mu_x : U_A \otimes x \rightarrow x$  satisfying the usual left unit and associativity properties of a left module. Moreover, the category  $\text{LMod}_{U_A}(\mathcal{C})$  of left  $U_A$ -modules in  $\mathcal{C}$  is well-defined. The following Lemma is tautological.

**Lemma 6.1.21.** We have  $\text{Mod}_{\mathcal{C}}^{E_1}((n+1)\text{Vec}) \simeq \text{LMod}_{U_{\mathcal{C}}}((n+1)\text{Vec})$  and

$$\text{Mod}_A^{E_1}(\mathcal{C}) \simeq \text{LMod}_{U_A}(\mathcal{C}).$$

Since  $\text{Alg}_{E_k}^c(-) = \text{Alg}_{E_1}^c(\text{Alg}_{E_{k-1}}^c(-))$  and  $\text{Mod}^{E_k}(-) = \text{Mod}^{E_1}(\text{Mod}^{E_{k-1}}(-))$  and the  $i$ -th multiplication or  $i$ -th action occurs in  $i$ -th spatial direction that is orthogonal to the  $j$ -th direction for  $i \neq j$ , the generalization to  $E_k$ -algebra is straightforward.

**Definition 6.1.22.** For  $\mathcal{C} \in \text{Alg}_{\mathbb{E}_k}^c((n+1)\text{Vec})$  and  $A \in \text{Alg}_{\mathbb{E}_k}^c(\mathcal{C})$ , we define the enveloping algebra  $U_{(\mathcal{C},A)}^{\mathbb{E}_k}$  of  $(\mathcal{C},A)$  as follows:

$$U_{(\mathcal{C},A)}^{\mathbb{E}_k} = \int_{S^k} (\mathcal{C},A) = (U_{\mathcal{C}}^{\mathbb{E}_k}, U_A^{\mathbb{E}_k}) = \left( \int_{S^k} \mathcal{C}, \int_{S^k} A \right).$$

**Proposition 6.1.23.** We have  $\mathcal{C} \in \text{Mod}_{\mathbb{E}_k}^{\mathbb{E}_k}((n+1)\text{Vec}) \simeq \text{LMod}_{U_{\mathcal{C}}^{\mathbb{E}_k}}((n+1)\text{Vec})$  and

$$\text{Mod}_A^{\mathbb{E}_k}(\mathcal{C}) \simeq \text{LMod}_{U_A^{\mathbb{E}_k}}(\mathcal{C}).$$

As a consequence, two  $A, B \in \text{Alg}_{\mathbb{E}_k}^c(\mathcal{C})$  are  $\text{Mod}_{\mathbb{E}_k}^{\mathbb{E}_k}$ -equivalent if and only if  $U_A^{\mathbb{E}_k}, U_B^{\mathbb{E}_k} \in \text{Alg}_{\mathbb{E}_1}^c(U_{\mathcal{C}}^{\mathbb{E}_k})$  are  $\text{LMod}(\mathcal{C})$ -equivalent.

## 6.2 Integrals and factorization homology

The study of dimensional reduction process in topological orders is deeply related to the mathematical theory of factorization homology as shown for 2+1D anomaly-free topological orders in [AKZ17]. However, in general anomalous and higher dimensional settings, it is somewhat different from the usual theory (the so-called  $\alpha$ -version) of factorization homology [Lur17, AF20] (see Remark 6.2.2). It might be closer to the so-called  $\beta$ -version of factorization homology developed in [AFT17, AFT16, AFR18]. We hope to clarify this point in the future. In this subsection, we only briefly discuss some results of integrating physical observables that follow directly from physical intuitions.

Consider two  $n+1$ D topologically Morita equivalent topological orders  $C^{n+1}$  and  $D^{n+1}$  connected by a gapped domain wall  $M^n$ . We specify the wall condition by a pair  $(\mathcal{M}, m)$ , where the separable  $n$ -category  $\mathcal{M}$  is the category of wall conditions and the distinguished object  $m \in \mathcal{M}$  specifies a single wall condition.

Topological defects of codimension  $k$  in  $C^{n+1}$  can be fused with a defect (of the same dimension) on the wall and become topological defects on the wall. This fusion defines an action

$$\odot : \Omega^{k-1} \mathcal{C} \times \Omega_m^{k-1} \mathcal{M} \rightarrow \Omega_m^{k-1} \mathcal{M} \quad (6.2.1)$$

$$(a, x) \mapsto a \odot x. \quad (6.2.2)$$

Note that the category  $\Omega^{k-1} \mathcal{C}$  is  $\mathbb{E}_k$ -monoidal and the category  $\Omega_m^{k-1} \mathcal{M}$  is  $\mathbb{E}_{k-1}$ -monoidal. The functor  $\odot$  is  $\mathbb{E}_{k-1}$ -monoidal. We can define internal homs associated to this action, i.e.  $\forall x, y \in \Omega_m^{k-1} \mathcal{M}$ ,

$$\text{hom}_{\Omega_m^{k-1} \mathcal{M}}(a \odot x, y) \simeq \text{hom}_{\Omega^{k-1} \mathcal{C}}(a, [x, y]_{\Omega^{k-1} \mathcal{C}}).$$

When  $x = y$ , the internal hom  $[x, x]_{\Omega^{k-1} \mathcal{C}} \in \text{Alg}_{\mathbb{E}_1}^c(\Omega^{k-1}(\mathcal{C}))$ . Moreover, we have

$$[1_m^{k-1}, 1_m^{k-1}]_{\Omega^{k-1} \mathcal{C}} \in \text{Alg}_{\mathbb{E}_k}^c(\Omega^{k-1}(\mathcal{C})).$$

This action functor  $\odot$  naturally induces the following bulk-to-wall map (recall  $1_m^0 = m$ ):

$$L_k := - \odot 1_m^{k-1} : \Omega^{k-1} \mathcal{C} \rightarrow \Omega_m^{k-1} \mathcal{M}, \quad (6.2.3)$$

which is again  $\mathbb{E}_{k-1}$ -monoidal. We illustrate two examples of  $L_k$  in the following picture.

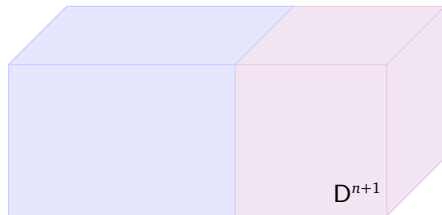

bulk to wall maps :

$$\Omega^2 \mathcal{C} \xrightarrow{L_3 = - \odot 1_m^2} \Omega_m^2 \mathcal{M},$$

$$\Omega \mathcal{C} \xrightarrow{L_2 = - \odot 1_m} \Omega_m \mathcal{M},$$

$$\mathcal{C} \xrightarrow{L_1 = - \odot m} \mathcal{M}.$$



Note that the right adjoint functor of  $L_k$  is given by  $L_k^R = [1_m^{k-1}, -]_{\Omega_m^{k-1}\mathcal{M}} : \Omega_m^{k-1}\mathcal{M} \rightarrow \Omega^{k-1}\mathcal{C}$ .

By rolling up the  $M^n$  and  $D^{n+1}$  along  $N^k \times \mathbb{R}^{n+1-k}$ , where  $N^k$  is a  $k$ -dimensional compact manifold, we obtain a  $k$ -codimensional topological defect in  $C^{n+1}$  as depicted below.

$$\int_{N^k \times \mathbb{R}^{n+1-k}} (\mathcal{D}^{n+1}|_{\dot{M}^k \times \mathbb{R}^{n+1-k}}, M^n|_{\partial N^k \times \mathbb{R}^{n+1-k}}) := \text{[Diagram of a blue cube labeled } C^{n+1} \text{]} \quad (6.2.4)$$

**Theorem<sup>ph</sup> 6.2.1.** Let  $C^{n+1}$  and  $D^{n+1}$  be two topologically Morita equivalent  $n+1$ D topological orders connected by an anomaly-free gapped domain wall  $M^n = (\mathcal{M}, m)$  and  $m \in \mathcal{M}$ . We have

$$\begin{aligned} \int_{D^k \times \mathbb{R}^{n+1-k}} (\mathcal{D}^{n+1}|_{\dot{D}^k \times \mathbb{R}^{n+1-k}}, M^n|_{\partial D^k \times \mathbb{R}^{n+1-k}}) &:= \int_{D^k \times \mathbb{R}^{n+1-k}} (\mathcal{D}|_{\dot{D}^k \times \mathbb{R}^{n+1-k}}, (\mathcal{M}, m)|_{\partial D^k \times \mathbb{R}^{n+1-k}}) \\ &= (\Omega^{k-1}\mathcal{C}, [1_m^{k-1}, 1_m^{k-1}]_{\Omega^{k-1}\mathcal{C}}) = (\mathcal{C}, \mathbb{1}_{\mathcal{C}}, \dots, 1_{\mathbb{1}_{\mathcal{C}}}^{k-2}, [1_m^{k-1}, 1_m^{k-1}]_{\Omega^{k-1}\mathcal{C}}). \end{aligned} \quad (6.2.5)$$

When  $N^k = D^k$ , let  $P := \int_{D^k \times \mathbb{R}^{n+1-k}} (\mathcal{D}^{n+1}|_{\dot{D}^k \times \mathbb{R}^{n+1-k}}, M^n|_{\partial D^k \times \mathbb{R}^{n+1-k}})$ . Then higher codimensional topological defects living on the defect  $P$  form a multi-fusion higher category  $\Omega_P\mathcal{C}$  given by

$$\Omega_P\mathcal{C} = \text{hom}_{\Omega^{k-1}\mathcal{C}}([1_m^{k-1}, 1_m^{k-1}]_{\Omega^{k-1}\mathcal{C}}, [1_m^{k-1}, 1_m^{k-1}]_{\Omega^{k-1}\mathcal{C}}). \quad (6.2.6)$$

**Remark 6.2.2.** Our theory of integral is different from the usual theory of factorization homology [Lur17, AF15], which was also called the alpha version of factorization homology (see [AF20] for a review). For example, all  $(n-k)$ -dimensional topological defects in  $M^n$  form the category  $\Omega_m^k\mathcal{M}$ , which is an  $E_k$ -fusion  $(n-k)$ -category; and all  $(n-k)$ -dimensional topological defects in  $D^{n+1}$  form the category  $\Omega^k\mathcal{D}$ , which is an  $E_{k+1}$ -fusion  $(n-k)$ -category. By the usual theory of factorization homology [Lur17, AF20], the following factorization homology

$$\int_{D^k \times \mathbb{R}^{n+1-k}} (\Omega^k\mathcal{D}|_{\dot{D}^k \times \mathbb{R}^{n+1-k}}, \Omega_m^k\mathcal{M}|_{\partial D^k \times \mathbb{R}^{n+1-k}})$$

is well-defined in the usual sense (see also [AKZ17]). There is a natural  $E_1$ -monoidal functor

$$\int_{D^k \times \mathbb{R}^{n+1-k}} (\Omega^k\mathcal{D}|_{\dot{D}^k \times \mathbb{R}^{n+1-k}}, \Omega_m^k\mathcal{M}|_{\partial D^k \times \mathbb{R}^{n+1-k}}) \longrightarrow \text{hom}_{\Omega^{k-1}\mathcal{C}}([1_m^{k-1}, 1_m^{k-1}]_{\Omega^{k-1}\mathcal{C}}, [1_m^{k-1}, 1_m^{k-1}]_{\Omega^{k-1}\mathcal{C}}),$$

which, in general, is not an equivalence. This non-equivalence is a very common phenomenon, which says that integrating local observables living on each stratum over a stratified manifold  $N$  only produces parts of the global observables on  $N$  because certain non-local observables become local when we shrink the size of  $M$ . This phenomenon was called *spatial fusion anomaly* appeared for topological defects of codimension 2 or higher in [KZ20, KZ21b]. Interestingly, this anomaly vanishes for the fusions of 1-codimensional gapped domain walls among anomaly-free topological orders [AKZ17, KZ20, KZ21a, KZ21b].  $\diamond$

**Example 6.2.3.** Consider an anomaly-free simple 2+1D topological order  $X^3$ , i.e.  $\Omega X$  is a non-degenerate braided fusion 1-category.

1. By rolling up a 2+1D topological order  $X^3$  along a circle  $S^1$ , we obtain a 2-codimensional topological defect (i.e. a string-like defect) in  $\mathbf{1}^4$ ;

$$\int_{S^1 \times \mathbb{R}^2} X^3 = (2\text{Vec}, \Omega X).$$

2. By rolling up  $X^3$  along a 2-sphere  $S^2$ , we obtain a 3-codimensional topological defect (i.e. a particle-like defect) in  $\mathbf{1}^4$ .

$$\int_{S^2 \times \mathbb{R}^1} X^3 = (\text{Vec}, \text{hom}_{\Omega X}(1_{\mathbb{1}_X}, 1_{\mathbb{1}_X})) \simeq (\text{Vec}, \mathbb{C}).$$

This result is compatible with the alpha version of factorization homology [AKZ17]. This is due to a general principle that the fusions of 1-codimensional topological defects are free of the spatial fusion anomaly [KZ21b].

3. By rolling up  $X^3$  along a 2-torus  $S^1 \times S^1$ , or equivalently, rolling up  $\int_{S^1 \times \mathbb{R}^2} X^3$  along  $S^1$ , we obtain a 3-codimensional topological defect (i.e. a particle-like defect) in  $\mathbf{1}^4$ .

$$\int_{S^1 \times S^1 \times \mathbb{R}^1} X^3 = (\text{Vec}, \text{hom}_{\text{Fun}(\Omega X, \Omega X)}(\text{id}_{\mathbb{1}_X}, \text{id}_{\mathbb{1}_X})) \simeq (\text{Vec}, \text{hom}_{\Omega X}(1_{\mathbb{1}_X}, \bigoplus_{i \in \text{Irr}(\Omega X)} i \otimes i^R)).$$

Again this result is compatible with the alpha version of factorization homology [AKZ17] for the same reason.

**Example 6.2.4.** Consider the 3+1D  $\mathbb{Z}_2$  topological order  $C^4 = \text{GT}_{\mathbb{Z}_2}^4$  and  $D^4 = \mathbf{1}^4$ .

1. Let  $M^3$  be the (twist) smooth boundary of  $\text{GT}_{\mathbb{Z}_2}^4$ , i.e.  $M^3 = (2\text{Rep}(\mathbb{Z}_2), \mathbb{1}_{2\text{Rep}(\mathbb{Z}_2)})$ . We have

$$\begin{aligned} \int_{D^2 \times \mathbb{R}^2} (3\text{Vec}|_{\mathbb{D}^2 \times \mathbb{R}^2}, (2\text{Rep}(\mathbb{Z}_2), \mathbb{1}_{2\text{Rep}(\mathbb{Z}_2)})|_{\partial D^2 \times \mathbb{R}^2}) &= (\Omega \mathcal{C}, \mathbb{1}_{\mathbb{1}_e} \oplus m), \\ \int_{D^3 \times \mathbb{R}^1} (3\text{Vec}|_{\mathbb{D}^3 \times \mathbb{R}^1}, (2\text{Rep}(\mathbb{Z}_2), \mathbb{1}_{2\text{Rep}(\mathbb{Z}_2)})|_{\partial D^3 \times \mathbb{R}^1}) &= (\Omega^2 \mathcal{C}, \mathbb{1}_{\mathbb{1}_e}^2), \\ \int_{D^2 \times S^1 \times \mathbb{R}^1} (3\text{Vec}|_{\mathbb{D}^2 \times S^1 \times \mathbb{R}^1}, (2\text{Rep}(\mathbb{Z}_2), \mathbb{1}_{2\text{Rep}(\mathbb{Z}_2)})|_{\partial D^2 \times S^1 \times \mathbb{R}^1}) &= \int_{S^1} \mathbb{1}_{\mathbb{1}_e} \oplus m = (\Omega^2 \mathcal{C}, \mathbb{1}_{\mathbb{1}_e}^2 \oplus \mathbb{1}_{\mathbb{1}_e}^2), \end{aligned}$$

where  $\mathbb{1}_{\mathbb{1}_e} \oplus m$  is precisely the Lagrangian algebra in  $\Omega \mathcal{T}\mathcal{C}$  that determines the (twist) smooth boundary; the second identity follows from the fact that the left hand side amounts to a line segment of the  $(\mathbb{1}_{\mathbb{1}_e} \oplus m)$ -string; the third identity follows from the fact that an  $m$ -loop gives the trivial particle  $\mathbb{1}_{\mathbb{1}_e}^2$  [KTZ20a].

2. Let  $M^3$  be the rough boundary of  $\text{GT}_{\mathbb{Z}_2}^4$ ,  $M^3 = (2\text{Vec}_{\mathbb{Z}_2}, \mathbb{1}_{2\text{Vec}_{\mathbb{Z}_2}})$ . We have

$$\begin{aligned} \int_{D^2 \times \mathbb{R}^2} (3\text{Vec}|_{\mathbb{D}^2 \times \mathbb{R}^2}, (2\text{Vec}_{\mathbb{Z}_2}, \mathbb{1}_{2\text{Vec}_{\mathbb{Z}_2}})|_{\partial D^2 \times \mathbb{R}^2}) &= (\Omega \mathcal{C}, \mathbb{1}_c), \\ \int_{D^3 \times \mathbb{R}^1} (3\text{Vec}|_{\mathbb{D}^3 \times \mathbb{R}^1}, (2\text{Vec}_{\mathbb{Z}_2}, \mathbb{1}_{2\text{Vec}_{\mathbb{Z}_2}})|_{\partial D^3 \times \mathbb{R}^1}) &= (\Omega^2 \mathcal{C}, \mathbb{1}_{\mathbb{1}_e}^2 \oplus e), \\ \int_{D^2 \times S^1 \times \mathbb{R}^1} (3\text{Vec}|_{\mathbb{D}^2 \times S^1 \times \mathbb{R}^1}, (2\text{Vec}_{\mathbb{Z}_2}, \mathbb{1}_{2\text{Vec}_{\mathbb{Z}_2}})|_{\partial D^2 \times S^1 \times \mathbb{R}^1}) &= \int_{S^1} \mathbb{1}_c = (\Omega^2 \mathcal{C}, \mathbb{1}_{\mathbb{1}_e}^2 \oplus e), \end{aligned}$$

where  $\mathbb{1}_c$  is the Lagrangian algebra that determines the rough boundary; the second identity follows from the fact that the left hand side amounts to a line segment of the  $\mathbb{1}_c$ -string; the third identity follows from the fact that an  $\mathbb{1}_c$ -loop gives the particle  $\mathbb{1}_{\mathbb{1}_e}^2 \oplus e$  [KTZ20a, Eq. (4.6)].  $\heartsuit$

Note that the pair  $(\mathcal{M}, m)$  only specifies a very special wall condition. The most general wall condition  $M^n$  can be defined by a stratified  $n$ -disk with each  $p$ -codimensional stratum labeled by a  $p$ -morphism in  $\mathcal{M}$  for  $0 \leq p \leq n$ . In particular, we can label different 0-codimensional strata (i.e.  $n$ -cells) by different 0-morphisms in  $\mathcal{M}$ . We would like to know how to compute the  $k$ -codimensional defect in  $C^{n+1}$  obtained by rolling up  $M^n$  with such a general wall condition along  $M^i \times \mathbb{R}^{n+1-i}$  as long as all strata glue properly. At the current stage, the explicit computation in such a general setup is not available. In the remaining of this subsection, we provide some explicit examples in the case  $C^{n+1} = D^{n+1}$  and  $M^n = C^n$ .

**Proposition<sup>ph</sup> 6.2.5.** Let  $X^{n+1-l}$  be an  $l$ -codimensional topological defect in  $C^{n+1}$ . For  $l \leq k < n+1$ , we have a canonical action  $\odot : \Omega^{k-1}\mathcal{C} \times \Omega_X^{k-l}(\mathcal{C}) \rightarrow \Omega_X^{k-l}(\mathcal{C})$ , which is an  $E_{k-l}$ -monoidal functor. By rolling up  $X$  along  $S^{k-l} \times \mathbb{R}^{n+1-k}$ , we obtain a  $k$ -codimensional topological defect  $\int_{S^{k-l} \times \mathbb{R}^{n+1-k}} X$  given as follows:

$$\int_{S^{k-l} \times \mathbb{R}^{n+1-k}} X = (\Omega^{k-1}\mathcal{C}, [1_X^{k-l}, 1_X^{k-l}]_{\Omega^{k-1}\mathcal{C}}), \quad (6.2.7)$$

where  $[1_X^{k-l}, 1_X^{k-l}]_{\Omega^{k-1}\mathcal{C}} \in \text{Alg}_{E_{k-l+1}}^{\mathcal{C}}(\Omega^{k-1}\mathcal{C})$  and, when  $k = l$ , we have  $[1_X^{k-l}, 1_X^{k-l}]_{\Omega^{k-1}\mathcal{C}} = X \otimes X^R$ .

**Example 6.2.6.** In 2+1D  $\mathbb{Z}_2$  topological order  $\text{TC}^3$ , there are six simple 1-codimensional topological defects  $\mathbb{1}, \text{ss}, \text{sr}, \text{rr}, \text{rs}$ , dual and four simple 2-codimensional topological defects  $1_{\mathbb{1}}, m, e, f$ . Then we have

$$\int_{S^1 \times \mathbb{R}^2} X = \begin{cases} (\mathfrak{Z}_1(\text{Rep}(\mathbb{Z}_2)), 1_{\mathbb{1}}) & \text{if } X = \mathbb{1}, \text{ dual;} \\ (\mathfrak{Z}_1(\text{Rep}(\mathbb{Z}_2)), 1_{\mathbb{1}} \oplus m) & \text{if } X = \text{ss}, \text{ sr;} \\ (\mathfrak{Z}_1(\text{Rep}(\mathbb{Z}_2)), 1_{\mathbb{1}} \oplus e) & \text{if } X = \text{rr}, \text{ rs.} \end{cases}$$

**Remark 6.2.7.** If we select a slightly more general wall condition, more precisely, we specify an  $(n-1)$ -dimensional topological defect  $m_1 \in \Omega_m \mathcal{M}$  on the wall and an  $(n-1)$ -dimensional topological defect  $d \in \Omega \mathcal{D}$ , then, by rolling up the wall along  $S^1 \times \mathbb{R}^{n-1}$ , we obtain the following formula (recall Theorem<sup>ph</sup> 4.1.10).

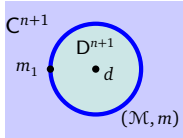

$$\int_{D^2 \times \mathbb{R}^{n-2}} ((\mathcal{D}, d)|_{\mathfrak{D}^2 \times \mathbb{R}^{n-2}}, (\mathcal{M}, m, m_1)|_{\partial D^2 \times \mathbb{R}^{n-2}}) = (\Omega \mathcal{C}, [1_m, m_1 \odot d]_{\Omega \mathcal{C}}).$$

Moreover,  $[1_m, - \odot -]$  is a well-defined functor, which maps  $\Omega_m \mathcal{M} \times \Omega \mathcal{D} \rightarrow \Omega \mathcal{C}$ . In other words, this rolling up process is functorial and  $[1_m, - \odot -]$  also tells us how to obtain the higher codimensional topological defect in  $\Omega \mathcal{C}$  resulting from rolling up higher codimensional defects in  $\Omega_m \mathcal{M}$  and  $\Omega \mathcal{D}$ .  $\diamond$

### 6.3 Condensations of gapless liquid-like defects

In this subsection, we sketch a generalization of condensation theory to gapless liquid-like defects. We leave a detailed study to future publications.

#### 6.3.1 General theory

Let  $C^{n+1}$  be an  $n+1$ D topological order. It can have gapless defects. For example, for  $C^3$ , by stacking a 2-dimensional topological defect with a 1+1D anomaly-free gapless phase, we obtain a gapless 1-codimensional defect in  $C^3$ . We give another example. Consider two  $k$ -codimensional simple topological defects  $X$  and  $Y$  in  $C^{n+1}$  connected by a  $(k+1)$ -codimensional topological defect. By proliferating  $Y$  within  $X$ , we can construct a  $(n+1-k)$ D phase transition from  $X$  to  $Y$  (without altering  $C^{n+1}$ ). At the

critical point of the phase transition, the gap (in a neighborhood of the defect) is the closed, thus we obtain a  $k$ -codimensional gapless defect in  $C^{n+1}$ .

A general gapless defect can be really wild. In general, the fusions among general defects are not well-defined. Therefore, we limit ourselves to a special class of non-topological defects, which we call *liquid-like* defects [KZ22b, KZ22c]. By ‘liquid-like’, we mean that the defect is ‘soft’ enough so that it can be bent freely without altering the defect. Physically, it means that such a defect should be transparent to energy-momentum tensor. Such an  $n$ -dimensional liquid-like defect can also be viewed as an anomalous  $nD$  quantum phase, which was named an (anomalous) *quantum liquid*. The mathematical theory of quantum liquids was developed in [KZ22b, KZ22c]. In particular, a quantum liquid  $X^{n+1}$  can be described by a pair  $(X^{\text{lqs}}, X^{\text{top}})$ , where

- $X^{\text{lqs}}$  summarize the dynamical data (called *local quantum symmetry*), a mathematical theory of which was developed in [KZ22c];
- $X^{\text{top}}$  summarize all the topological (or categorical) data (called *topological skeleton*).

The fusion of the topological skeletons of two quantum liquids is well-defined. It is natural to conjecture that the fusion of local quantum symmetry is well-defined and is compatible with that of the topological skeletons. A theory to make sense of this conjecture was developed in [KZ22c]. We do not want to go to the details. But simply take it for granted that the fusions among quantum liquids are well-defined. It also means that the category of all gapped and gapless liquid-like defects in a topological order is well-defined. Mathematically, the softness of the liquid-like defects simply means that the category of such defects is fully dualizable.

**Example 6.3.1.** A 1+1D rational conformal field theory can be viewed as a 1-codimensional liquid-like defect in  $1^3$ . In a general 2+1D topological order  $C^3$ , we can stack a 1-codimensional topological defect with a 1+1D RCFT to obtain a 1-codimensional liquid-like defect in  $C^3$ . For 2+1D  $\mathbb{Z}_2$  topological order  $TC^3$ , it has two gapped boundaries: the smooth boundary and the rough boundary. In [CJKYZ20], an explicit purely boundary phase transition was constructed via lattice model, and the critical point, viewed as a gappable gapless boundary of  $TC^3$ , was shown to be liquid-like.  $\heartsuit$

Given an  $n+1D$  topological order  $C^{n+1}$ , we denote the category of all liquid-like defects by  $\hat{\mathcal{C}}$ . It was shown that this category is monoidal, fully dualizable and condensation complete [KZ22b, KZ22c]. Note that when  $C^{n+1} = \mathbf{1}^{n+1}$ , it was shown that  $\hat{\mathcal{C}}$  is equivalent to  $\bullet/(n+2)\text{Vec}$  [KZ22b, KZ22c]<sup>21</sup>. We will leave a mathematically detailed study of condensations in  $\hat{\mathcal{C}}$  or  $\bullet/(n+2)\text{Vec}$  elsewhere. Instead, we give a heuristic discussion of condensations in  $\hat{\mathcal{C}}$ .

We expect that the condensation theory of liquid-like defects in  $\hat{\mathcal{C}}$  is completely parallel to that in  $\mathcal{C}$ . In particular, by condensing a  $k$ -codimensional liquid-like defect in  $\hat{\mathcal{C}}$ , we mean a multiple-step process.

1. We first condense a condensable  $E_k$ -algebra  $A$  in one of the transversal directions. We obtain a  $(k-1)$ -codimensional liquid-like defect  $\Sigma A$ , which is automatically a condensable  $E_{k-1}$ -algebra in  $\Omega^{k-1}\hat{\mathcal{C}}$ .
2. We repeat the process  $(k-1)$ -times and obtain a 1-codimensional liquid-like defect  $\Sigma^{k-1}A$ , which is automatically a condensable  $E_1$ -algebra in  $\hat{\mathcal{C}}$ . It can be further condensed to give a new phase  $D^{n+1}$  such that  $\hat{\mathcal{D}} \simeq \text{Mod}_{\Sigma^{k-1}A}^{E_1}(\hat{\mathcal{C}})$  and a potentially gapless wall  $M^n = (\hat{\mathcal{M}}, m)$  such that  $\hat{\mathcal{M}} \simeq \text{RMod}_A(\hat{\mathcal{C}})$  and  $m = A$ .
3. Alternatively, one can condense the condensable  $E_2$ -algebra  $\Sigma^{k-2}A$  in  $\Omega\hat{\mathcal{C}}$  directly to obtain the condensed phase  $D^{n+1}$  such that  $\Omega\hat{\mathcal{D}} \simeq \text{Mod}_{\Sigma^{k-2}A}^{E_2}(\Omega\hat{\mathcal{C}})$  and  $\Omega_m\hat{\mathcal{M}} \simeq \text{RMod}_{\Sigma^{k-2}A}(\Omega\hat{\mathcal{C}})$ .

---

<sup>21</sup>We ignore the unitarity here.

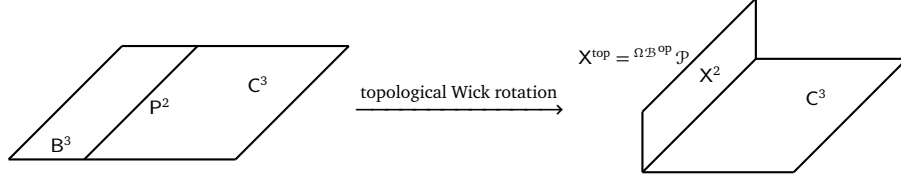

Figure 14: the idea of topological Wick rotation

Since any topological order can have a gapped or gapless liquid-like boundary, one can obtain any topological order by a condensation in the trivial phase.

The mathematical theory of condensation of gapless liquid-like defects are incredibly rich. It relies on some not-yet developed mathematical theory of enriched (higher) categories. In the next subsection, avoiding mathematical details, we give an illustrating example in 2+1D based on the physical intuition of topological Wick rotation [KZ20, KZ21b].

### 6.3.2 An illustrating example in 2+1D

The mathematical theory of gapped/gapless boundaries of 2+1D topological orders was developed in [KZ18b, KZ20, KZ21b]. We do not need the complete theory but the physical intuition provided by the so-called topological Wick rotation as illustrated in Figure 14. More precisely, the left picture depicts a gapped domain wall  $P^2$  between two anomaly-free 2+1D simple topological order  $C^3$  and  $B^3$  in the spatial dimension. The 2-codimensional topological defects in  $B^3$  (resp.  $C^3$ ) form a non-degenerate braided fusion 1-category  $\Omega B$  (resp.  $\Omega C$ ). For convenience, we also assume  $P^2 = (\mathcal{P}, p)$  is simple. Then the 1-codimensional topological defects in  $P^2$  form a fusion 1-category  $\Omega_p \mathcal{P}$ . We have a canonical braided equivalence  $\Omega B^{\text{op}} \boxtimes \Omega C \simeq \mathfrak{Z}_1(\Omega_p \mathcal{P})$ . The canonical action of  $\Omega B^{\text{op}}$  on  $\Omega_p \mathcal{P}$  defines an enriched fusion category  ${}^{\Omega B^{\text{op}}} \Omega_p \mathcal{P}$  via the so-called canonical construction [MP17]. It turns out that the topological skeleton  $X^{\text{top}} = \mathcal{X}$  of a gapless boundary  $X^2$  of a 2+1D topological  $C^3$  is precisely given by an enriched fusion category  $\mathcal{X} = {}^{\Omega B^{\text{op}}} \Omega_p \mathcal{P}$ . This suggests that the topological skeleton of the gapless boundary  $X^2$  can be obtained by rotating the 2+1D phase  $B^3$  to the time direction as a fictional phase in spacetime as depicted in the second picture in Figure 14. This fictional phase can be viewed as a bookkeeping device for the combination of  $\Omega B^{\text{op}}$  with  $\mathcal{P}$  to form an  $\Omega B^{\text{op}}$ -enriched fusion category  ${}^{\Omega B^{\text{op}}} \Omega_p \mathcal{P}$ . Actually, it suggests something much deeper than a bookkeeping device as shown already in [KZ18b] that it led a powerful formula for computing the fusion of gapless domain walls [KZ18b, Eq. 5.3] and a generalization of holographic duality to higher dimensions [KZ20, KZ21b, KZ22b]. From now on, we take it for granted that the second picture in Figure 14 represents a gapless boundary  $X^2$  of  $C^3$ .

Similar to Section 4.1.3, by rolling up the gapless boundary  $X^2$ , we obtain a 2-codimensional liquid-like defect in  $\hat{\Omega C}$ .

$$A = \int_{S^1} \mathcal{X} = \int_{S^1} {}^{\Omega B^{\text{op}}} \Omega_p \mathcal{P} = \int_{C^3} \int_{P^2} \int_{B^3} {}^{\Omega B^{\text{op}}} \Omega_p \mathcal{P} \in \hat{\Omega C}. \quad (6.3.1)$$

Similar to the discussion in Section 4.1.3, this liquid-like defect is an internal hom  $[\mathbb{1}_{\mathcal{X}}, \mathbb{1}_{\mathcal{X}}]_{\hat{\Omega C}}$ . The internal hom is again defined by the natural action  $\odot : \hat{\Omega C} \times \mathcal{X} \rightarrow \mathcal{X}$ , i.e.

$$\text{hom}_{\mathcal{X}}(a \odot x, y) \simeq \text{hom}_{\hat{\Omega C}}(a, [x, y]_{\hat{\Omega C}}).$$

Therefore,  $A = [\mathbb{1}_X, \mathbb{1}_X]_{\Omega\hat{\mathcal{C}}}$  has a canonical structure of a condensable  $E_2$ -algebra in  $\hat{\mathcal{C}}$ . The geometric meaning of this algebraic structure was explained in details in [KZ21b, Section 6.2, Remark 6.3] as a natural<sup>22</sup> geometric fusion of two such ‘cylinders’ depicted in (6.3.1). From the geometric construction of this multiplication, it is clear that  $A$  is an  $E_2$ -algebra in  $\Omega\hat{\mathcal{C}}$ .

Notice that a defect in  $X$  also defines an object in  $\Omega\hat{\mathcal{C}}$  as illustrated below:

$$\int_{S^1} (X, x) = \begin{array}{c} \text{Cylinder} \\ \text{C}^3 \\ x \in X \end{array} \in \Omega\hat{\mathcal{C}}. \quad (6.3.2)$$

The same geometric fusion of two cylinders defined in [KZ21b, Section 6.2] defines an  $A$ -action on  $\int_{S^1} (X, x)$ . As a consequence,  $\int_{S^1} (X, x)$  is only a right  $A$ -module (not bimodule nor  $E_2$ -module) in  $\Omega\hat{\mathcal{C}}$ . Geometrically, it is clear that such a right  $A$ -module is an  $E_2$ - $A$ -module if and only if  $x \in X$  can be moved into the trivial phase  $\mathbf{1}^3$ . However, the only simple 2-codimensional liquid-like defect is the trivial particle. We obtain  $\text{Mod}_A^{E_2}(\Omega\hat{\mathcal{C}}) \simeq \text{Vec}$ . We summarize all the results in this subsection in the following theorem.

**Theorem<sup>ph</sup> 6.3.2.** A gapless boundary  $X^2$  of an anomaly-free 2+1D topological order  $C^{n+1}$  can be obtained by condensing a liquid-like defect  $A := \int_{S^1} X$ , which is an  $E_2$ -algebra in  $\hat{\mathcal{C}}$ . Moreover, we have

$$X \simeq \text{RMod}_A(\Omega\hat{\mathcal{C}}), \quad \text{Mod}_A^{E_2}(\Omega\hat{\mathcal{C}}) \simeq \text{Vec}.$$

One can also condense  $A$  along a line in space. As a consequence, we obtain a condensed 1-codimensional liquid-like defect  $\Sigma A = X^2 \boxtimes \bar{X}^2 \in \hat{\mathcal{C}}$ , which can be graphically represented by the following picture.

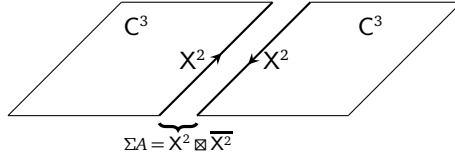

By condensing  $\Sigma A$  in  $\hat{\mathcal{C}}$ , we again obtain  $\mathbf{1}^3$  as the condensed phase and a gapless boundary, which is precisely  $X^2$ .

**Remark 6.3.3.** If the cylinder-like defect depicted in (6.3.1) and (6.3.2) has a non-trivial interior, then some non-trivial defect  $x \in X$  in (6.3.2) can be moved into the interior and becomes an  $E_2$ - $A$ -module. In this case, the condensed phase  $D^3$  is non-trivial and we have  $\Omega\hat{\mathcal{D}} = \text{Mod}_A^{E_2}(\Omega\hat{\mathcal{C}})$ .  $\diamond$

**Remark 6.3.4.** Although this illustrating example is about the condensation in a 2+1D topological order with a gapless liquid-like boundary, it tautologically generalizes to higher dimensional topological orders with gapless liquid-like boundaries (or domain walls) because topological Wick rotation also applies to gapless liquid-like boundaries of higher dimensional topological orders [KZ20, KLWZZ20b, KLWZZ20a, KZ22b].  $\diamond$

## 6.4 Condensations as interactions

We have shown that the condensation theory is essentially about higher algebras and higher representations, the mathematical theory of which is far from been developed. In this subsection, we discuss some physical or philosophical enlightenments from such a general theory of condensations.

<sup>22</sup>There is no unnatural choice involved in the geometric definition of the fusion of two cylinders depicted in (6.3.1).

Physically, if we reduce the condensation to its simplest form, it is nothing but a way to select a sub-Hilbert space from a Hilbert space as emphasized in [Kon14]. For example, consider the tensor product of two spins spaces  $V$ 's, i.e.

$$V \otimes_{\mathbb{C}} V \simeq V_0 \oplus V_0^{\perp}, \quad (6.4.1)$$

which is quantum mechanical system instead of a quantum many-body system. Introducing an interaction between these two spin spaces amounts to introducing a projector to the subspace  $V_0$ , which is more energy favorable than  $V_0^{\perp}$ . Although condensation is a term applying to quantum many-body systems, we can view an interaction between two spin spaces, or more generally, an interaction among a few spin spaces, as a condensation in a quantum few-body system.

When we have a chain of spin spaces  $\otimes_{i \in \mathbb{Z}} V$ , by introducing mutually commuting local interactions (MCLI) (or condensation) among adjacent spins, we obtain a 1+1D lattice model (see Remark 6.4.1). We refer to this type of lattice models by *MCLI lattice models*. If a MCLI lattice model realizes a quantum phase  $C^2$ , it is reasonable to say that this lattice model realize a condensation from the trivial phase  $\mathbf{1}^2$  to  $C^2$ . This point of view automatically generalizes to all dimensions. Namely, a MCLI lattice model realization of a quantum phase  $C^{n+1}$  is precisely a physical realization of a condensation from the trivial phase  $\mathbf{1}^{n+1}$  to  $C^{n+1}$  (see Remark 6.4.1). In other words, a MCLI lattice model and a condensation are essentially the same thing.

**Remark 6.4.1.** Our condensation theory is based on condensation maps, which are mutually commuting projectors. Therefore, it only applies to lattice models with mutually commuting local interactions (or condensation). On the other hand, a MCLI lattice model construction is already more general than what is covered in this work because the quantum phase  $C^{n+1}$  can also be a non-liquid phase (see [Cha05, SSWC18, SSC19, VHF16, Wen20] and references therein). A quantum liquid can be viewed as a quantum phase satisfying certain finite properties because fully dualizability condition is a finiteness condition. Therefore, when  $C^{n+1}$  is a quantum liquid, we can view a condensation from  $\mathbf{1}^{n+1}$  to  $C^{n+1}$  as a finite-type condensation; when  $C^{n+1}$  is a quantum non-liquid, the associated condensation is a infinite-type condensation. We hope to give a precise mathematical definition of a finite-type or infinite-type condensation in the future. If we allow condensations of infinite-type, then the trivial phase  $\mathbf{1}^{n+1}$  can already be viewed as a ‘theory of everything’.  $\diamond$

This unification of these terminologies or ideas leads us to many natural generalizations of previous ideas. We give some examples.

1. An  $n+1$ D MCLI lattice model can be viewed as first introducing interactions in  $n$ D followed by a layer construction. In other words, higher dimensional MCLI lattice models are layer constructions of lower dimensional MCLI lattice models.
2. It also suggests that, for a quantum phase  $C^{n+1}$ , there is a universal construction of a ‘MCLI lattice model’ that can realize  $C^{n+1}$ . The idea is illustrated in Figure 15. Each square depicts an  $n+1$ D quantum phase  $C^{n+1}$  surrounded by a (potentially gapless) boundary phase  $X^n$ . Such a square should be viewed as a generalized local spin space  $V$ , which is clearly infinite dimensional. Note that some local degrees of freedom in  $V$  are those on the “local boundary”  $X^n$  and others are those in the  $C^{n+1}$ -phase. We define the interaction between two adjacent squares simply by introducing an interactions between the local degrees of freedom in  $V$  that belong to the “local boundaries” of two adjacent squares such that this interaction defines a condensation that erases the local boundary and connects the interior of two squares.
3. Since the notion of condensation is defined not only from  $\mathbf{1}^{n+1}$  to  $C^{n+1}$  but from  $B^{n+1}$  to  $C^{n+1}$ , we should also have a notion of a *lattice model over a background phase  $B^{n+1}$* , which realizes a new phase  $C^{n+1}$  and, at the same time, a condensation from  $B^{n+1}$  to  $C^{n+1}$ . Moreover, the condensation process defined by first proliferating  $C^{n+1}$ -phase-islands within the  $B^{n+1}$ -phase then introducing proper interactions among  $C^{n+1}$ -phase-islands immediately leads us to a universal construction of

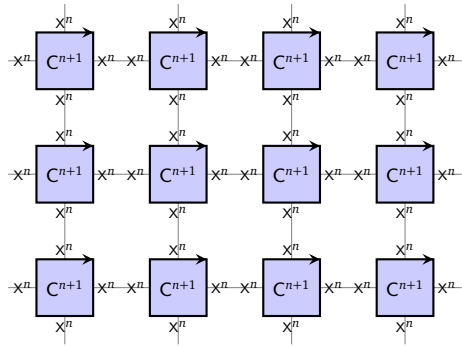

Figure 15: the construction of a universal MCLI lattice model

a MCLI lattice model over the background phase  $B^{n+1}$  that realizes the phase  $C^{n+1}$ . An illustration of this construction can be achieved by filled ‘white empty background’ in Figure 15 with a color for the  $B^{n+1}$ .



## A Appendix

### A.1 Proof of Theorem 4.1.11

It remains to show that the morphism (4.1.10) coincides with the one defined in (4.1.9). The morphism (4.1.10) is defined via the composition of a series of morphisms. We consider a more general condition by replacing the object  $1_m$  by arbitrary object  $x, y$  in  $\Omega_m \mathcal{M}$ . The morphism we need to study is provided by the following composition

$$L_2^R(x) \otimes L_2^R(y) \rightarrow L_2^R(L_2(L_2^R(x) \otimes L_2^R(y))) \simeq L_2^R(L_2 L_2^R(x) \otimes L_2 L_2^R(y)) \rightarrow L_2^R(x \otimes y) \quad (\text{A.1.1})$$

We examine the geometric meaning of each morphism appearing in the above composition. It turns out that the geometric meaning of (A.1.1) is the fusion of two bubbles.

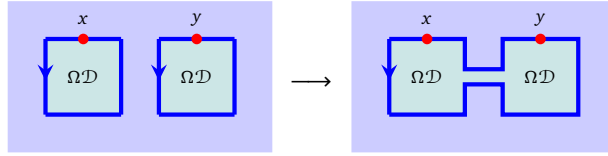

As a result, by taking  $x, y = 1_m$ , we recover the morphism (4.1.9).

Before we start, we analyse the geometric meaning of the unit and counit of the adjunction  $L_2 \dashv [1_m, -]$ , which are used throughout the proof. Recall that, the bulk-to-wall map  $L_2 : \Omega \mathcal{C} \rightarrow \Omega_m \mathcal{M}$  means we move a point-like excitation  $a$  in  $\Omega \mathcal{C}$  next to the gapped domain wall  $\Omega_m \mathcal{M}$ , so that we can view  $a$  as an excitation on  $\Omega_m \mathcal{M}$ , and we denote it by  $L_2(a)$ .

- Unit of the adjunction  $\eta : \text{id}_{\Omega \mathcal{C}} \Rightarrow [1_m, L_2(-)] = L_2^R L_2(-) = - \otimes L_2^R(1_m)$ :

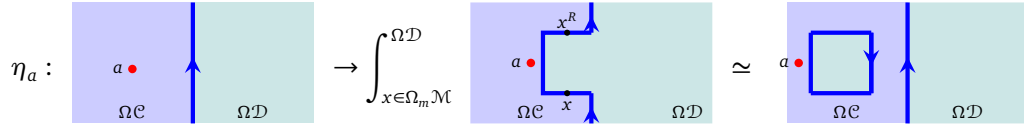

- Counit of the adjunction  $\varepsilon : L_2 L_2^R(-) L_2([1_m, -]) \Rightarrow \text{id}_{\Omega_m \mathcal{M}}$ :

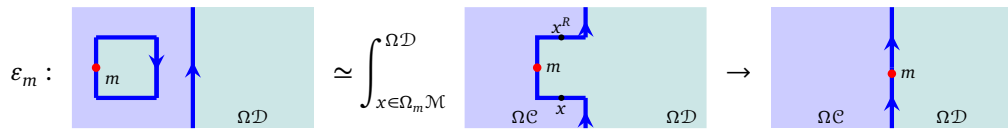

Then we need to analyze the geometric meaning of following morphisms, whose composition gives rise to (A.1.1).

1. The first morphism is a component of the unit  $\eta$ . It is given by

$$\eta_{L_2^R(x) \otimes L_2^R(y)} : L_2^R(x) \otimes L_2^R(y) \rightarrow L_2^R(L_2(L_2^R(x) \otimes L_2^R(y))) \quad (\text{A.1.2})$$

2. The second morphism

$$L_2^R(L_2(L_2^R(x) \otimes L_2^R(y))) \simeq L_2^R(L_2(L_2^R(x)) \otimes L_2(L_2^R(y))) \quad (\text{A.1.3})$$

only exploits the monoidal structure of  $L_2$ , hence is geometrically trivial. We omit this morphism in our geometric analysis.

3. The third morphism is given by

$$L_2^R(\varepsilon_x \otimes \varepsilon_y) : L_2^R(L_2(L_2^R(x)) \otimes L_2(L_2^R(y))) \rightarrow L_2^R(x \otimes y)$$

We study the morphism inside  $L_2^R(-)$ , that is, the tensor product of two components of  $\varepsilon$ :

$$\varepsilon_x \otimes \varepsilon_y : L_2(L_2^R(x)) \otimes L_2(L_2^R(y)) \rightarrow x \otimes y. \quad (\text{A.1.4})$$

The analysis of the morphism (A.1.4) occupies the main space of this appendix.

The geometric meaning of the morphism (A.1.2) is:

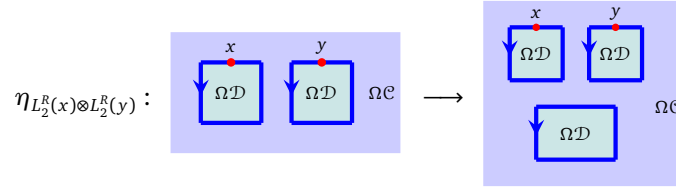

The geometric meaning of the morphism (A.1.4) is:

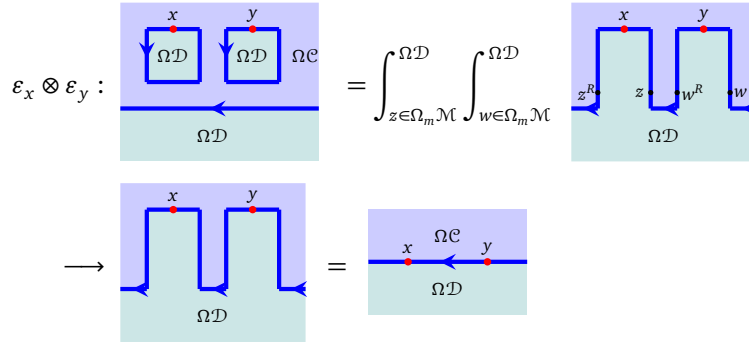

To proceed, let us note that there is a canonical isomorphism:

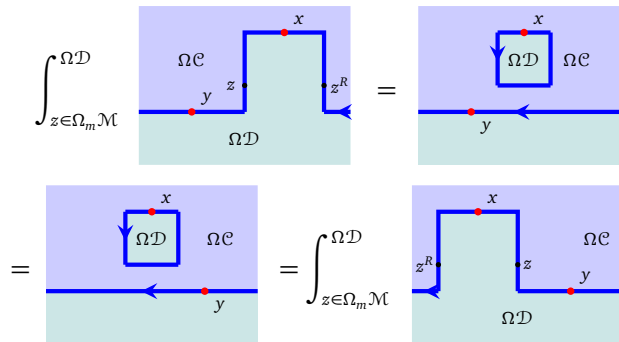

Algebraically, this means that the object  $\int_{z \in \Omega_m \mathcal{M}}^{\Omega \mathcal{D}} z^R \otimes x \otimes z$  is equipped with a half braiding  $\beta$  whose components are  $\int_{z \in \Omega_m \mathcal{M}}^{\Omega \mathcal{D}} z^R \otimes x \otimes z \otimes y \simeq y \otimes (\int_{z \in \Omega_m \mathcal{M}}^{\Omega \mathcal{D}} z^R \otimes x \otimes z) \simeq \int_{z \in \Omega_m \mathcal{M}}^{\Omega \mathcal{D}} y \otimes z^R \otimes x \otimes z$ . The mathematical details of the construction of the half-braiding are postponed to the next appendix, see Example A.2.15 and Example A.2.16.

Now we would like to show that, the morphism  $\varepsilon_x \otimes \varepsilon_y$  is equal to the following morphism:

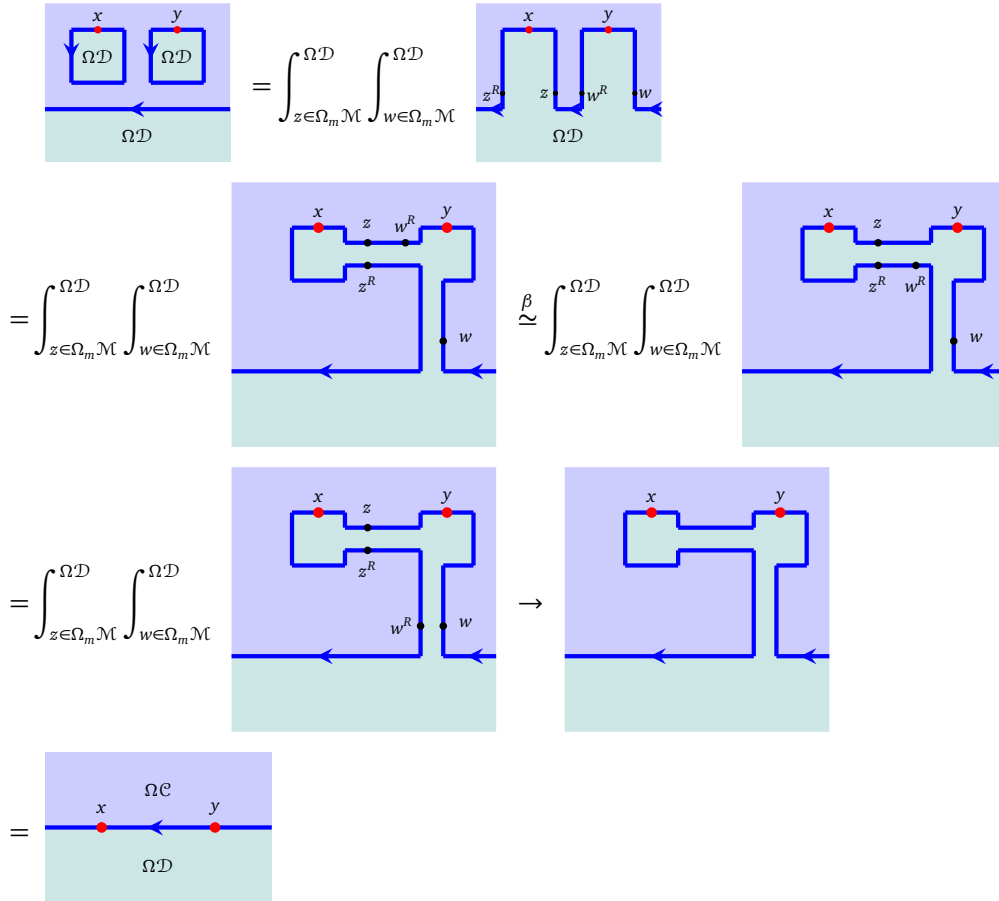

Mathematically, this amounts to the commutativity of the following diagram

$$\begin{array}{ccc}
 \int_{z \in \Omega_m \mathcal{M}} z^R \otimes x \otimes z \otimes \int_{w \in \Omega_m \mathcal{M}} w^R \otimes y \otimes w & \longrightarrow & \int_{w \in \Omega_m \mathcal{M}} w^R \otimes \left( \int_{z \in \Omega_m \mathcal{M}} z^R \otimes x \otimes z \right) \otimes y \otimes w \\
 \downarrow \pi_{1_m} \otimes \pi_{1_m} & & \downarrow \pi_{1_m} \\
 x \otimes y & \xrightarrow{=} & \int_{w \in \Omega_m \mathcal{M}} w^R \otimes x \otimes y \otimes w \\
 & & \downarrow \pi_{1_m} \\
 & & x \otimes y
 \end{array}$$

This commutativity can be demonstrated by considering the following diagram:

$$\begin{array}{ccccc}
 \int_{z \in \Omega_m \mathcal{M}} z^R \otimes x \otimes z \otimes \int_{w \in \Omega_m \mathcal{M}} w^R \otimes y \otimes w & \longrightarrow & \int_{w \in \Omega_m \mathcal{M}} w^R \otimes \int_{z \in \Omega_m \mathcal{M}} z^R \otimes x \otimes z \otimes y \otimes w & & \\
 \downarrow & & \downarrow & \searrow & \\
 \int_{z \in \Omega_m \mathcal{M}} z^R \otimes x \otimes z \otimes 1_m \otimes y \otimes 1_m & \longrightarrow & 1_m \otimes \int_{z \in \Omega_m \mathcal{M}} z^R \otimes x \otimes z \otimes y \otimes 1_m & & \int_{w \in \Omega_m \mathcal{M}} w^R \otimes x \otimes y \otimes w \\
 \downarrow & & \downarrow & \nearrow & \\
 x \otimes y & \longrightarrow & x \otimes y & & 
 \end{array}$$

The upper square commutes due to the definition of the upper horizontal arrow. The middle horizontal morphism is the half-braiding with the tensor unit  $1_m$  and so is trivial, hence the lower square commutes. The right triangle commutes trivially.

As a result, the morphism  $L_2^R(\varepsilon_x \otimes \varepsilon_y)$  can be depicted as (where we use the “tunnels” between bubbles to indicate the way we fuse bubbles):

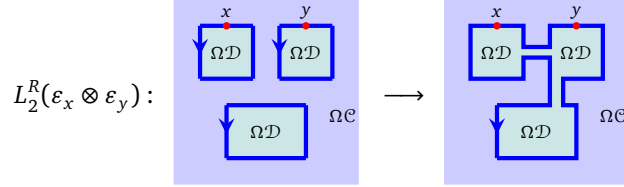

Summarizing the above analysis, the composed morphism (A.1.1) can be written as the composition of the following maps:

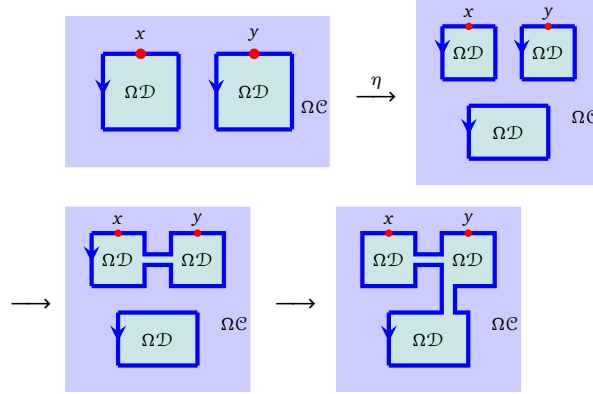

By the naturality of  $\eta$  we may rewrite the above map as

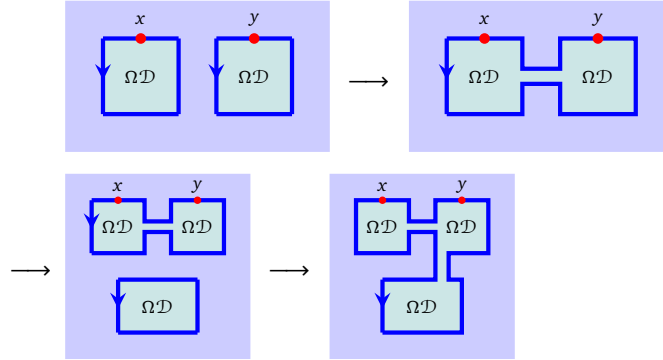

Note that the composition of the last two maps is just identity, by the zig-zag equation of adjunction:

$$\text{id} : L_2^R(x \otimes y) \rightarrow L_2^R(x \otimes y) \otimes L_2^R(1_m) = L_2^R(L_2 L_2^R(x \otimes y)) \xrightarrow{L_2^R(\varepsilon_{x \otimes y})} L_2^R(x \otimes y)$$

Finally, we see that the morphism  $L_2^R(x) \otimes L_2^R(y) \rightarrow L_2^R(x \otimes y)$  is given by fusion of two bubbles:

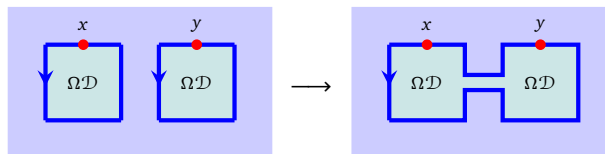

This completes the proof of Theorem 4.1.11.

## A.2 Module Eilenberg-Watts calculus

In this section, we develop a relative version of classical Eilenberg-Watts calculus. All categories we consider in this appendix are finite 1-categories, i.e. linear categories that are equivalent to the category of finite dimensional modules over some finite dimensional algebra  $A$ .

**Convention A.2.1 (Convention for duality).** Our convention for left/right duality is different from that in [DR18, Lur17]. For  $\mathcal{C}$  a monoidal category and  $x \in \mathcal{C}$  an object, a left dual of  $x$  consists of a triple  $(x^L, \text{ev}_x, \text{coev}_x)$  where  $x^L \in \mathcal{C}$  is an object,  $\text{coev}_x : \mathbb{1}_{\mathcal{C}} \rightarrow x \otimes x^L$  is the coevaluation map and  $\text{ev}_x : x^L \otimes x \rightarrow \mathbb{1}_{\mathcal{C}}$  is the evaluation map. The (co)evaluation maps are required to satisfy the zig-zag equation. A right dual of  $x$  is a left dual in  $\mathcal{C}^{\text{rev}}$ .

**Notation A.2.2.** Let  $\mathcal{C}$  be a finite tensor category and  $\mathcal{M}$  is a left  $\mathcal{C}$ -module, whose module structure is denoted by  $\odot : \mathcal{C} \times \mathcal{M} \rightarrow \mathcal{M}$ . Rigidity of  $\mathcal{C}$  induces two right  $\mathcal{C}$ -module structures over  $\mathcal{M}^{\text{op}}$ , defined in the following way:

- The module structure

$$\odot^L : \mathcal{M}^{\text{op}} \times \mathcal{C} \rightarrow \mathcal{M}^{\text{op}}, \quad (m, c) \mapsto c^L \odot m.$$

For simplicity, we denote the right  $\mathcal{C}$ -module structure by  $\mathcal{M}^{\text{op}L}$ .

- The module structure

$$\odot^R : \mathcal{M}^{\text{op}} \times \mathcal{C} \rightarrow \mathcal{M}^{\text{op}}, \quad (m, c) \mapsto c^R \odot m.$$

For simplicity, we denote the right  $\mathcal{C}$ -module structure by  $\mathcal{M}^{\text{op}R}$ .

**Notation A.2.3.** Let  $\mathcal{C}$  be a finite tensor category and  $\mathcal{M}, \mathcal{N}$  be finite left  $\mathcal{C}$ -modules. We use  $\text{Fun}_{\mathcal{C}}^L(\mathcal{M}, \mathcal{N})$  to denote the finite category of left exact  $\mathcal{C}$ -module functors from  $\mathcal{M}$  to  $\mathcal{N}$ . Similarly, we use  $\text{Fun}_{\mathcal{C}}^R(\mathcal{M}, \mathcal{N})$  to denote the finite category of right exact  $\mathcal{C}$ -module functors from  $\mathcal{M}$  to  $\mathcal{N}$ . For two  $\mathcal{C}$ -module functors  $(F, \eta_F), (G, \eta_G)$  in  $\text{Fun}_{\mathcal{C}}(\mathcal{M}, \mathcal{N})$ , we write  $\text{Nat}_{\mathcal{C}}(F, G)$  for the vector space of  $\mathcal{C}$ -module natural transformations from  $F$  to  $G$ .

**Definition A.2.4.** Let  $\mathcal{C}$  be a finite tensor category and  $\mathcal{M}$  a left  $\mathcal{C}$ -module. We equip  $\mathcal{M}^{\text{op}}$  with the right  $\mathcal{C}$ -module structure  $\mathcal{M}^{\text{op}L}$ . Let  $(F, e) : \mathcal{M}^{\text{op}L} \times \mathcal{M} \rightarrow \mathcal{D}$  be a balanced  $\mathcal{C}$ -module functor with  $e$  being the balancing natural isomorphism. The  $\mathcal{C}$ -module end of  $F$  is a pair  $(\int_{x \in \mathcal{M}}^{\mathcal{C}} F(x, x), \pi)$  with  $\int_{x \in \mathcal{M}}^{\mathcal{C}} F(x, x) \in \mathcal{D}$  an object and  $\pi : \Delta_{\int_{x \in \mathcal{M}}^{\mathcal{C}} F(x, x)} \xrightarrow{\bullet\bullet} F$  is a dinatural transformation such that the following diagram is commutative:

$$\begin{array}{ccc} \int_{x \in \mathcal{M}}^{\mathcal{C}} F(x, x) & \xrightarrow{\pi_m} & F(m, m) \\ \pi_{c^L \odot m} \downarrow & & \downarrow \text{coev}_c \\ F(c^L \odot m, c^L \odot m) & \xrightarrow{e_{m, c, c^L \odot m}} & F(m, c \odot c^L \odot m) \end{array}$$

and the pair  $(\int_{x \in \mathcal{M}}^{\mathcal{C}} F(x, x), \pi)$  is terminal among all such pairs. ■

This is a dual notion defined as follows:

**Definition A.2.5.** Let  $\mathcal{C}$  be a finite tensor category and  $\mathcal{M}$  a left  $\mathcal{C}$ -module. We equip  $\mathcal{M}^{\text{op}}$  with the right  $\mathcal{C}$ -module structure  $\mathcal{M}^{\text{op}R}$ . Let  $(F, e) : \mathcal{M}^{\text{op}R} \times \mathcal{M} \rightarrow \mathcal{D}$  be a balanced  $\mathcal{C}$ -module functor with  $e$  being the balancing natural isomorphism. The  $\mathcal{C}$ -module coend of  $F$  is a pair  $(\int_{x \in \mathcal{M}}^{\mathcal{C}} F(x, x), \pi)$  with

$\int_{\mathcal{C}}^{x \in \mathcal{M}} F(x, x) \in \mathcal{D}$  an object and  $\pi : F \overset{\bullet\bullet}{\dashrightarrow} \Delta_{\int_{\mathcal{C}}^{x \in \mathcal{M}} F(x, x)}$  a dinatural transformation, such that the following diagram is commutative:

$$\begin{array}{ccc} F(m, (c \otimes c^R) \odot m) & \longrightarrow & F(c^R \odot m, c^R \odot m) \\ \downarrow \text{ev}_{c^R} & & \downarrow \\ F(m, m) & \longrightarrow & \int_{\mathcal{C}}^{x \in \mathcal{M}} F(x, x) \end{array}$$

and the pair  $(\int_{\mathcal{C}}^{x \in \mathcal{M}} F(x, x), \pi)$  is initial among all such pairs.  $\blacksquare$

**Remark A.2.6.** The  $\mathcal{C}$ -module end may be written as the following equalizer:

$$\int_{m \in \mathcal{M}}^{\mathcal{C}} F(m, m) \simeq \text{Eq}(\int_{m \in \mathcal{M}} F(m, m) \xrightarrow[f]{g} \int_{m \in \mathcal{M}} \int_{c \in \mathcal{C}} F(m, c \odot c^L \odot m))$$

Componentwisely,  $f$  and  $g$  can be written respectively as (we choose the component labelled by  $d \in \mathcal{C}$  and  $n \in \mathcal{M}$ )

$$f_{d,n} = \int_{m \in \mathcal{M}} F(m, m) \xrightarrow{\pi_n} F(n, n) \rightarrow F(n, d \otimes d^L \odot n)$$

and

$$g_{d,n} = \int_{m \in \mathcal{M}} F(m, m) \xrightarrow{\pi_{d^L \odot n}} F(d^L \odot n, d^L \odot n) \simeq F(n, d^L \otimes d \odot n).$$

where we use the balancing structure of  $F$  in the last step. Dually the  $\mathcal{C}$ -module coend may be written as a coequalizer of two coends.  $\diamond$

The following lemma generalizes the familiar formula for usual ends:

**Lemma A.2.7.** Let  $\mathcal{M}, \mathcal{N}$  be left  $\mathcal{C}$ -modules where  $\mathcal{C}$  is a finite tensor category. Let  $(F, \eta^F), (G, \eta^G) \in \text{Fun}_{\mathcal{C}}(\mathcal{M}, \mathcal{N})$  be  $\mathcal{C}$ -module functors. Then  $\int_{m \in \mathcal{M}}^{\mathcal{C}} \text{hom}_{\mathcal{N}}(F(m), G(m)) \simeq \text{Nat}_{\mathcal{C}}(F, G)$ . Note that the functor  $\text{hom}_{\mathcal{N}}(F(-), G(-)) : \mathcal{M}^{\text{oplL}} \times \mathcal{M} \rightarrow \text{Vec}$  is equipped with a canonical balancing structure.

*Proof.* Take  $\alpha \in \text{Nat}_{\mathcal{C}}(F, G)$  and  $\pi_m(\alpha) = \alpha_m$  be its component at  $m$ . Then the commutativity of the following diagram

$$\begin{array}{ccc} \text{Nat}_{\mathcal{C}}(F, G) & \xrightarrow{\pi_m} & \text{hom}_{\mathcal{N}}(F(m), G(m)) \\ \pi_{c^L \odot m} \downarrow & & \downarrow \\ \text{hom}_{\mathcal{N}}(F(c^L \odot m), G(c^L \odot m)) & \xrightarrow{e_{m, c^L \odot m}} & \text{hom}_{\mathcal{N}}(F(m), G(c \odot c^L \odot m)) \end{array}$$

is equivalent to be commutativity of the following diagram

$$\begin{array}{ccc} c^L \odot F(m) & \xrightarrow{c^L \odot \alpha_m} & c^L \odot G(m) \\ \downarrow \eta_{c^L, m}^F & & \downarrow \eta_{c^L, m}^G \\ F(c^L \odot m) & \xrightarrow{\alpha_{c^L \odot m}} & G(c^L \odot m) \end{array}$$

The following lemma is a simple corollary of the enriched Yoneda Lemma, which will be useful in our proof of Lemma A.2.9.

**Lemma A.2.8.** Let  $\mathcal{M}, \mathcal{N}$  be left  $\mathcal{C}$ -modules and  $(K, \eta^K) \in \text{Fun}_{\mathcal{C}}(\mathcal{M}, \mathcal{N})$  is a  $\mathcal{C}$ -module functor. There is a canonical isomorphism of vector spaces for each  $y \in \mathcal{M}, z \in \mathcal{N}$ :

$$\text{Nat}_{\mathcal{C}}([y, -], [z, K(-)]) \simeq \text{hom}_{\mathcal{N}}(z, K(y)).$$

Similarly we have

$$\text{Nat}_{\mathcal{C}}([- , y], [K(-), z]) \simeq \text{hom}_{\mathcal{N}}(K(y), z).$$

**Lemma A.2.9 (Yoneda and co-Yoneda Lemma via (co)ends).** Let  $(G, \eta^G) \in \text{Fun}_{\mathcal{C}}(\mathcal{M}, \mathcal{N})$ , then there is a canonical isomorphism of  $\mathcal{C}$ -module functors:

$$G(-) \simeq \int_{\mathcal{C}}^{x \in \mathcal{M}} [x, -] \odot G(x), \quad G(-) \simeq \int_{x \in \mathcal{M}}^{\mathcal{C}} [-, x]^R \odot G(x) \quad (\text{A.2.1})$$

*Proof.*

$$\begin{aligned} \text{hom}\left(\int_{\mathcal{C}}^{x \in \mathcal{M}} [x, y] \odot G(x), z\right) &\simeq \int_{x \in \mathcal{M}}^{\mathcal{C}} \text{hom}_{\mathcal{N}}([x, y] \odot G(x), z) \\ &\simeq \int_{x \in \mathcal{M}}^{\mathcal{C}} \text{hom}_{\mathcal{C}}([x, y], [G(x), z]) \\ &\simeq \text{Nat}_{\mathcal{C}}([- , y], [G(-), z]) \\ &\simeq \text{hom}_{\mathcal{N}}(G(y), z). \end{aligned}$$

**Example A.2.10.** Let us regard  $\mathcal{C}$  as a regular left  $\mathcal{C}$ -module. In this case the internal hom is easily computed as

$$[x, y] = y \otimes x^L$$

Applying the Yoneda lemma A.2.9 to the identity functor  $\text{id} : \mathcal{C} \rightarrow \mathcal{C}$  (which is equipped with a canonical  $\mathcal{C}$ -module functor structure), we have

$$y \simeq \int_{x \in \mathcal{C}}^{\mathcal{C}} [y, x]^R \otimes x \simeq \int_{x \in \mathcal{C}} y \otimes x^R \otimes x, \quad \mathbb{1}_{\mathcal{C}} \simeq \int_{x \in \mathcal{C}} x^R \otimes x. \quad (\text{A.2.2})$$

**Theorem A.2.11 (Generalized Eilenberg-Watts calculus).** Let  $\mathcal{C}$  be a finite tensor category. We use  $\text{Fun}_{\mathcal{C}}^R(\mathcal{M}, \mathcal{N})$  to denote the category of right exact  $\mathcal{C}$ -module functors from  $\mathcal{M}$  to  $\mathcal{N}$  and  $\text{Fun}_{\mathcal{C}}^L(\mathcal{M}, \mathcal{N})$  the category of left exact ones. Then there are pairs of adjoint equivalences:

$$\begin{aligned} \Phi^l : \mathcal{M}^{\text{op|R}} \boxtimes_{\mathcal{C}} \mathcal{N} &\rightarrow \text{Fun}_{\mathcal{C}}^L(\mathcal{M}, \mathcal{N}), \quad x \boxtimes_{\mathcal{C}} y \mapsto [x, -] \odot y \\ \Psi^l : \text{Fun}_{\mathcal{C}}^L(\mathcal{M}, \mathcal{N}) &\rightarrow \mathcal{M}^{\text{op|R}} \boxtimes_{\mathcal{C}} \mathcal{N}, \quad F \mapsto \int_{\mathcal{C}}^{m \in \mathcal{M}} m \boxtimes_{\mathcal{C}} F(m). \end{aligned}$$

and

$$\begin{aligned} \Phi^r : \mathcal{M}^{\text{op|L}} \boxtimes_{\mathcal{C}} \mathcal{N} &\rightarrow \text{Fun}_{\mathcal{C}}^R(\mathcal{M}, \mathcal{N}), \quad x \boxtimes_{\mathcal{C}} y \mapsto [-, x]^R \odot y \\ \Psi^r : \text{Fun}_{\mathcal{C}}^R(\mathcal{M}, \mathcal{N}) &\rightarrow \mathcal{M}^{\text{op|L}} \boxtimes_{\mathcal{C}} \mathcal{N}, \quad F \mapsto \int_{m \in \mathcal{M}}^{\mathcal{C}} m \boxtimes_{\mathcal{C}} F(m). \end{aligned}$$

**Example A.2.12.** Let  $\mathcal{C}$  be a braided fusion category,  $\mathcal{M}$  be a multi-fusion category and  $L : \mathcal{C} \rightarrow \mathcal{M}$  be a central functor.  $L$  equips  $\mathcal{M}$  with a structure of left  $\mathcal{C}$ -module in a manifest way. According to Theorem A.2.11, there is an equivalence  $\Psi^r : \text{Fun}_{\mathcal{C}}(\mathcal{M}, \mathcal{M}) \simeq \mathcal{M}^{\text{op|L}} \boxtimes_{\mathcal{C}} \mathcal{M}$ , which sends a functor  $F$  to

$\int_{m \in \mathcal{M}}^{\mathcal{C}} m \boxtimes F(m)$ . In particular,  $\Psi^r$  sends the identity functor  $\text{id}_{\mathcal{M}}$  to  $\int_{m \in \mathcal{M}}^{\mathcal{C}} m \boxtimes m$ . Taking the equivalence of right  $\mathcal{C}$ -modules

$$\begin{aligned} \mathcal{M}^{\text{opl}L} &\simeq \mathcal{M}^{\text{rev}}, \\ m &\mapsto m^R \end{aligned}$$

into consideration, we obtain a composed equivalence:

$$\text{Fun}_{\mathcal{C}}(\mathcal{M}, \mathcal{M}) \simeq \mathcal{M}^{\text{opl}L} \boxtimes_{\mathcal{C}} \mathcal{M} \simeq \mathcal{M}^{\text{rev}} \boxtimes_{\mathcal{C}} \mathcal{M},$$

which sends the identity functor  $\text{Id}_{\mathcal{M}}$  to:

$$\text{id}_{\mathcal{M}} \mapsto \int_{m \in \mathcal{M}}^{\mathcal{C}} m \boxtimes_{\mathcal{C}} m \mapsto \int_{m \in \mathcal{M}}^{\mathcal{C}} m^R \boxtimes_{\mathcal{C}} m. \quad (\text{A.2.3})$$

This image of  $\text{id}_{\mathcal{M}}$  is used in Section 4.1.3 and Section A.1. ♡

To give a proof of Theorem A.2.11, we first summarize the following results from [KZ18a], Corollary 2.2.6 and Proposition 2.2.7.

**Theorem A.2.13.** Let  $\mathcal{M}$  and  $\mathcal{N}$  be left  $\mathcal{C}$ -modules.  $x, x' \in \mathcal{M}$  and  $y, y' \in \mathcal{N}$ .

(1) There is a natural isomorphism

$$\text{hom}_{\mathcal{M}^{\text{opl}L} \boxtimes_{\mathcal{C}} \mathcal{N}}(x \boxtimes_{\mathcal{C}} y, x' \boxtimes_{\mathcal{C}} y') \simeq \text{hom}_{\mathcal{C}}(1, [y, y'] \otimes [x', x])$$

(2) The formula  $x \boxtimes_{\mathcal{C}} y \mapsto y \boxtimes_{\mathcal{C}} x$  determines an equivalence  $\mathcal{M}^{\text{opl}R} \boxtimes_{\mathcal{C}} \mathcal{N} \simeq (\mathcal{N}^{\text{opl}L} \boxtimes_{\mathcal{C}} \mathcal{M})^{\text{op}}$

(3) The functor  $x \boxtimes_{\mathcal{C}} y \mapsto [x, -] \odot y$  determines an equivalence between  $\mathcal{M}^{\text{opl}R} \boxtimes_{\mathcal{C}} \mathcal{N}$  and  $\text{Fun}_{\mathcal{C}}^L(\mathcal{M}, \mathcal{N})$ ; similarly, the functor  $x \boxtimes_{\mathcal{C}} y \mapsto [-, x]^R \odot y$  determines an equivalence between  $\mathcal{M}^{\text{opl}L} \boxtimes_{\mathcal{C}} \mathcal{N} \simeq \text{Fun}_{\mathcal{C}}^R(\mathcal{M}, \mathcal{N})$ .

*Proof of Theorem A.2.11.* According to Theorem A.2.13 (3),  $\Phi^l$  is an equivalence. It suffices to show that  $\Psi^l$  is the left adjoint functor of  $\Phi^l$ . This follows from the following computation:

$$\begin{aligned} \text{Nat}_{\mathcal{C}}(F, [x, -] \odot y) &\simeq \int_{m \in \mathcal{M}}^{\mathcal{C}} \text{hom}_{\mathcal{N}}(F(m), [x, m] \odot y) \\ &\simeq \int_{m \in \mathcal{M}}^{\mathcal{C}} \text{hom}_{\mathcal{C}}(1, [x, m] \otimes [F(m), y]) \simeq \int_{m \in \mathcal{M}}^{\mathcal{C}} \text{hom}_{\mathcal{N}^{\text{opl}L} \boxtimes_{\mathcal{C}} \mathcal{M}}(y \boxtimes_{\mathcal{C}} x, F(m) \boxtimes_{\mathcal{C}} m) \\ &\simeq \int_{m \in \mathcal{M}}^{\mathcal{C}} \text{hom}_{(\mathcal{N}^{\text{opl}L} \boxtimes_{\mathcal{C}} \mathcal{M})^{\text{op}}}(F(m) \boxtimes_{\mathcal{C}} m, y \boxtimes_{\mathcal{C}} x) \\ &\simeq \text{hom}_{\mathcal{M}^{\text{opl}R} \boxtimes_{\mathcal{C}} \mathcal{N}}\left(\int_{\mathcal{C}}^{m \in \mathcal{M}} m \boxtimes_{\mathcal{C}} F(m), x \boxtimes_{\mathcal{C}} y\right). \end{aligned}$$

The first isomorphism follows from Lemma A.2.9; the second isomorphism is routine; the third isomorphism follows from Theorem A.2.13 (1); the fourth isomorphism is trivial and the last isomorphism follows from Theorem A.2.13 (2).

In a similar manner, we can show that  $\Psi^r$  is right adjoint to  $\Phi^r$ . □

**Example A.2.14.** Let  $\mathcal{C}$  and  $\mathcal{D}$  be Morita equivalent finite tensor categories and  ${}_{\mathcal{C}}\mathcal{M}_{\mathcal{D}}$  be the invertible module. It is well-known that there is a canonical equivalence of monoidal categories:

$$u : \mathcal{D}^{\text{op}} \rightarrow \text{Fun}_{\mathcal{C}}(\mathcal{M}, \mathcal{M}), \quad d \mapsto - \odot d.$$



Now we are able to write down the quasi-inverse(right adjoint) of  $u$ :

$$u^R : \text{Fun}_{\mathcal{C}}(\mathcal{M}, \mathcal{M}) \rightarrow \mathcal{D}^{\text{op}}, \quad F \mapsto \int_{m \in \mathcal{M}}^{\mathcal{C}} [m, F(m)]_{\mathcal{D}^{\text{op}}} \quad (\text{A.2.4})$$

which follows from the following easy calculation:

$$\begin{aligned} \text{hom}_{\mathcal{D}}(d, \int_{m \in \mathcal{M}}^{\mathcal{C}} [m, F(m)]_{\mathcal{D}^{\text{op}}}) &\simeq \int_{m \in \mathcal{M}}^{\mathcal{C}} \text{hom}_{\mathcal{D}}(d, [m, F(m)]_{\mathcal{D}^{\text{op}}}) \\ &\simeq \text{Nat}_{\mathcal{C}}(- \circ d, F(-)). \end{aligned} \quad \heartsuit$$

**Example A.2.15.** Let  $\mathcal{C}, \mathcal{D}$  be non-degenerate braided fusion categories,  $\mathcal{M}$  be a closed multi-fusion  $\mathcal{C}$ - $\mathcal{D}$ -bimodule. Let  $F : \mathcal{C} \rightarrow \mathcal{M}$  be the central functor, whose central structure is witnessed by the braided tensor functor  $\tilde{F} : \mathcal{C} \rightarrow \mathfrak{Z}_1(\mathcal{M})$ . Given  $m \in \mathcal{M}$ , we define  $T(m)$  to be the  $\mathcal{C}$ -module end

$$T(m) := \int_{x \in \mathcal{M}}^{\mathcal{C}} x^R \otimes m \otimes x$$

Note that the central structure of  $F$  is indispensable for the definition. When  $m$  varies, the assignments  $m \mapsto T(m)$  can be extended to a functor  $T : \mathcal{M} \rightarrow \mathcal{M}$  which actually defines a comonad over  $\mathcal{M}$ . Let us look at the Eilenberg-Moore category (i.e. the category of comodules) of this comonad. The Eilenberg-Moore category of this comonad consists of pairs  $(m, \delta_m)$  where  $m \in \mathcal{M}$  and  $\delta_m$  is a half braiding of  $m$  subject to the extra property that  $(m, \delta_m)$  should lie in the double centralizer of the essential image of  $\tilde{F} : \mathcal{C} \rightarrow \mathfrak{Z}_1(\mathcal{M})$ , where  $\tilde{F}$  is the lift of  $F$ . As a result, the Eilenberg-Moore category of  $T$  is nothing but  $\mathcal{D}$ .  $\heartsuit$

**Example A.2.16.** The  $\mathcal{C}$ -module end  $\int_{x \in \mathcal{M}}^{\mathcal{C}} x^R \otimes m \otimes x \in \mathcal{M}$  defined in Example A.2.15 is equipped with a canonical half-braiding  $\gamma$ :

$$\gamma_y : y \otimes \int_{x \in \mathcal{M}}^{\mathcal{C}} x^R \otimes m \otimes x = \int_{x \in \mathcal{M}}^{\mathcal{C}} y \otimes x^R \otimes m \otimes x \simeq \int_{x \in \mathcal{M}}^{\mathcal{C}} x^R \otimes m \otimes x \otimes y.$$

$\gamma_y$  is induced by the universal property of  $\mathcal{C}$ -module end. Let  $\kappa_a$  be the morphism defined by the following composition

$$\kappa_a : \int_{x \in \mathcal{M}}^{\mathcal{C}} x^R \otimes m \otimes x \otimes y \xrightarrow{\pi_{a \otimes y^L}} (a \otimes y^L)^R \otimes m \otimes a \otimes y^L \otimes y \xrightarrow{\text{id} \otimes \text{coev}_y} y \otimes a^R \otimes m \otimes a.$$

for each  $a \in \mathcal{M}$ . All these  $\kappa_a$  can be organized into a single morphism

$$\int_{x \in \mathcal{M}}^{\mathcal{C}} x^R \otimes m \otimes x \otimes y \rightarrow \int_{a \in \mathcal{M}}^{\mathcal{C}} y \otimes a^R \otimes m \otimes a = y \otimes \int_{a \in \mathcal{M}}^{\mathcal{C}} a^R \otimes m \otimes a.$$

In a similar manner, one can construct a morphism

$$\gamma_y : y \otimes \int_{a \in \mathcal{M}}^{\mathcal{C}} a^R \otimes m \otimes a \rightarrow \int_{x \in \mathcal{M}}^{\mathcal{C}} x^R \otimes m \otimes x \otimes y.$$

The two morphisms are inverse to each other, giving rise to the desired half-braiding.  $\heartsuit$

## References

- [AF15] David Ayala and John Francis. *Factorization homology of topological manifolds*. Journal of Topology, 8(4):1045–1084, 2015. [arXiv:1206.5522](#).
- [AF20] David Ayala and John Francis. *A factorization homology primer*. In *Handbook of Homotopy Theory*, pages 39–101. Chapman and Hall/CRC, 2020. [arXiv:1903.10961](#).
- [AFR18] David Ayala, John Francis, and Nick Rozenblyum. *Factorization homology I: Higher categories*. Advances in Mathematics, 333:1042–1177, 2018. [arXiv:1504.04007](#).
- [AFT16] David Ayala, John Francis, and Hiro Lee Tanaka. *Factorization homology of stratified spaces*. Selecta Mathematica, 23(1):293–362, 2016. [arXiv:1409.0848](#).
- [AFT17] David Ayala, John Francis, and Hiro Lee Tanaka. *Local structures on stratified spaces*. Advances in Mathematics, 307:903–1028, 2017. [arXiv:1409.0501](#).
- [AKZ17] Yinghua Ai, Liang Kong, and Hao Zheng. *Topological orders and factorization homology*. Advances in Theoretical and Mathematical Physics, 21(8):1845–1894, 2017. [arXiv:1607.08422](#).
- [BBCW19] Maissam Barkeshli, Parsa Bonderson, Meng Cheng, and Zhenghan Wang. *Symmetry fractionalization, defects, and gauging of topological phases*. Physical Review B, 100(11), 2019. [arXiv:1410.4540](#).
- [BEK99] Jens Böckenhauer, David E. Evans, and Yasuyuki Kawahigashi. *On  $\alpha$ -induction, chiral generators and modular invariants for subfactors*. Communications in Mathematical Physics, 208(2):429–487, 1999. [arXiv:math/9904109](#).
- [Bén65] Jean Bénabou. *Catégories relatives*. Comptes Rendus Hebdomadaires des Séances de l’Académie des Sciences, Paris, 256:3824–3827, 1965.
- [Bez04] Roman Bezrukavnikov. *On tensor categories attached to cells in affine Weyl groups*. In *Representation Theory of Algebraic Groups and Quantum Groups*. Mathematical Society of Japan, 2004. [arXiv:math/0010089](#).
- [BJQ13] Maissam Barkeshli, Chao-Ming Jian, and Xiao-Liang Qi. *Theory of defects in abelian topological states*. Physical Review B, 88(23), 2013. [arXiv:1305.7203](#).
- [BJS21] Adrien Brochier, David Jordan, and Noah Snyder. *On dualizability of braided tensor categories*. Compositio Mathematica, 157(3):435–483, 2021. [arXiv:1804.07538](#).
- [BK98] S. B. Bravyi and A. Yu. Kitaev. *Quantum codes on a lattice with boundary*. arXiv preprint, 1998. [arXiv:quant-ph/9811052](#).
- [BS09] F. A. Bais and J. K. Slingerland. *Condensate-induced transitions between topologically ordered phases*. Physical Review B, 79(4), 2009. [arXiv:0808.0627](#).
- [BSH09] F. A. Bais, J. K. Slingerland, and S. M. Haaker. *Theory of topological edges and domain walls*. Physical Review Letters, 102(22), 2009. [arXiv:0812.4596](#).
- [BSS02] F. A. Bais, B. J. Schroers, and J. K. Slingerland. *Broken quantum symmetry and confinement phases in planar physics*. Physical Review Letters, 89(18), 2002. [arXiv:hep-th/0205117](#).
- [BSS03] Alexander F Bais, Bernd J Schroers, and Joost K Slingerland. *Hopf symmetry breaking and confinement in (2+1)-dimensional gauge theory*. Journal of High Energy Physics, 2003(05):068–068, 2003. [arXiv:hep-th/0205114](#).

- [BSS11] F. J. Burnell, Steven H. Simon, and J. K. Slingerland. *Condensation of achiral simple currents in topological lattice models: Hamiltonian study of topological symmetry breaking*. Physical Review B, 84(12), 2011. [arXiv:1104.1701](#).
- [BT18] Lakshya Bhardwaj and Yuji Tachikawa. *On finite symmetries and their gauging in two dimensions*. Journal of High Energy Physics, 2018(3), 2018. [arXiv:1704.02330](#).
- [Bur18] F.J. Burnell. *Anyon condensation and its applications*. Annual Review of Condensed Matter Physics, 9(1):307–327, 2018. [arXiv:1706.04940](#).
- [CGLW13] Xie Chen, Zheng-Cheng Gu, Zheng-Xin Liu, and Xiao-Gang Wen. *Symmetry protected topological orders and the group cohomology of their symmetry group*. Physical Review B, 87(15), 2013. [arXiv:1106.4772](#).
- [CGW10] Xie Chen, Zheng-Cheng Gu, and Xiao-Gang Wen. *Local unitary transformation, long-range quantum entanglement, wave function renormalization, and topological order*. Physical Review B, 82(15), 2010. [arXiv:1004.3835](#).
- [Cha05] Claudio Chamon. *Quantum glassiness in strongly correlated clean systems: An example of topological overprotection*. Physical Review Letters, 94(4), 2005. [arXiv:cond-mat/0404182](#).
- [CJKYZ20] Wei-Qiang Chen, Chao-Ming Jian, Liang Kong, Yi-Zhuang You, and Hao Zheng. *Topological phase transition on the edge of two-dimensional  $\mathbb{Z}_2$  topological order*. Physical Review B, 102(4), 2020. [arXiv:1903.12334](#).
- [CJW22] Arkya Chatterjee, Wenjie Ji, and Xiao-Gang Wen. *Emergent generalized symmetry and maximal symmetry-topological-order*. arXiv preprint, 2022. [arXiv:2212.14432](#).
- [CLW11] Xie Chen, Zheng-Xin Liu, and Xiao-Gang Wen. *Two-dimensional symmetry-protected topological orders and their protected gapless edge excitations*. Physical Review B, 84(23), 2011. [arXiv:1106.4752](#).
- [CR16] Nils Carqueville and Ingo Runkel. *Orbifold completion of defect bicategories*. Quantum Topology, 7(2):203–279, 2016. [arXiv:1210.6363](#).
- [Cra98] Sjoerd E. Crans. *Generalized centers of braided and sylleptic monoidal 2-categories*. Advances in Mathematics, 136(2):183–223, 1998.
- [CW23] Arkya Chatterjee and Xiao-Gang Wen. *Holographic theory for continuous phase transitions: Emergence and symmetry protection of gaplessness*. Physical Review B, 108(7):075105, 2023. [arXiv:2205.06244](#).
- [Dav10a] Alexei Davydov. *Centre of an algebra*. Advances in Mathematics, 225(1):319–348, 2010. [arXiv:0908.1250](#).
- [Dav10b] Alexei Davydov. *Modular invariants for group-theoretical modular data. I*. Journal of Algebra, 323(5):1321–1348, 2010. [arXiv:0908.1044](#).
- [DGNO10] Vladimir Drinfeld, Shlomo Gelaki, Dmitri Nikshych, and Victor Ostrik. *On braided fusion categories I*. Selecta Mathematica, 16(1):1–119, 2010. [arXiv:0906.0620](#).
- [DKR15] Alexei Davydov, Liang Kong, and Ingo Runkel. *Functoriality of the center of an algebra*. Advances in Mathematics, 285:811–876, 2015. [arXiv:1307.5956](#).

- [DMNO13] Alexei Davydov, Michael Müger, Dmitri Nikshych, and Victor Ostrik. *The Witt group of non-degenerate braided fusion categories*. Journal für die reine und angewandte Mathematik (Crelles Journal), 2013(677), 2013. [arXiv:1009.2117](#).
- [DN21] Alexei Davydov and Dmitri Nikshych. *Braided picard groups and graded extensions of braided tensor categories*. Selecta Mathematica, 27(4), 2021. [arXiv:2006.08022](#).
- [DR18] Christopher L. Douglas and David J. Reutter. *Fusion 2-categories and a state-sum invariant for 4-manifolds*. arXiv preprint, 2018. [arXiv:1812.11933](#).
- [DS18] Alexei Davydov and Darren A. Simmons. *Third cohomology and fusion categories*. Homology, Homotopy and Applications, 20(1):275–302, 2018. [arXiv:1704.02401](#).
- [Dun88] Gerald Dunn. *Tensor product of operads and iterated loop spaces*. Journal of Pure and Applied Algebra, 50(3):237–258, 1988.
- [DX23] Thibault D. Décoppet and Hao Xu. *Local modules in braided monoidal 2-categories*. arXiv preprint, 2023. [arXiv:2307.02843](#).
- [Dé23] Thibault D. Décoppet. *Rigid and separable algebras in fusion 2-categories*. Advances in Mathematics, 419:108967, 2023. [arXiv:2205.06453](#).
- [EGNO15] Pavel Etingof, Shlomo Gelaki, Dmitri Nikshych, and Victor Ostrik. *Tensor categories*. American Math. Soc, Providence, RI, 2015.
- [FFRS06] Jürg Fröhlich, Jürgen Fuchs, Ingo Runkel, and Christoph Schweigert. *Correspondences of ribbon categories*. Advances in Mathematics, 199(1):192–329, 2006. [arXiv:math/0309465](#).
- [FFRS07] Jürg Fröhlich, Jürgen Fuchs, Ingo Runkel, and Christoph Schweigert. *Duality and defects in rational conformal field theory*. Nuclear Physics B, 763(3):354–430, 2007. [arXiv:hep-th/0607247](#).
- [FG90] J. Fröhlich and F. Gabbiani. *Braid statistics in local quantum theory*. Reviews in Mathematical Physics, 02(03):251–353, 1990.
- [Fra12] John Francis. *The tangent complex and Hochschild cohomology of  $E_n$ -rings*. Compositio Mathematica, 149(3):430–480, 2012. [arXiv:1104.0181](#).
- [Fre17] Benoit Fresse. *Homotopy of Operads and Grothendieck–Teichmüller Groups: Parts 1 and 2*, volume 217 of *Mathematical Surveys and Monographs*. American Mathematical Society, 2017.
- [FRS89] K. Fredenhagen, K. H. Rehren, and B. Schroer. *Superselection sectors with braid group statistics and exchange algebras*. Communications In Mathematical Physics, 125(2):201–226, 1989.
- [FRS02] Jürgen Fuchs, Ingo Runkel, and Christoph Schweigert. *TFT construction of RCFT correlators I: partition functions*. Nuclear Physics B, 646(3):353–497, 2002. [arXiv:hep-th/0204148](#).
- [FSV13] Jürgen Fuchs, Christoph Schweigert, and Alessandro Valentino. *Bicategories for boundary conditions and for surface defects in 3-d TFT*. Communications in Mathematical Physics, 321(2):543–575, 2013. [arXiv:1203.4568](#).
- [GJF19] Davide Gaiotto and Theo Johnson-Freyd. *Condensations in higher categories*. arXiv preprint, 2019. [arXiv:1905.09566](#).

- [GW09] Zheng-Cheng Gu and Xiao-Gang Wen. *Tensor-entanglement-filtering renormalization approach and symmetry-protected topological order*. Physical Review B, 80(15), 2009. [arXiv:0903.1069](#).
- [Haa96] Rudolf Haag. *Local Quantum Physics*. Springer Berlin Heidelberg, 1996.
- [Haa11] Jeongwan Haah. *Local stabilizer codes in three dimensions without string logical operators*. Physical Review A, 83(4), 2011. [arXiv:1101.1962](#).
- [HK64] Rudolf Haag and Daniel Kastler. *An algebraic approach to quantum field theory*. Journal of Mathematical Physics, 5(7):848–861, 1964.
- [HK04] Yi-Zhi Huang and Liang Kong. *Open-string vertex algebras, tensor categories and operads*. Communications in Mathematical Physics, 250(3):433–471, 2004. [arXiv:math.QA/0308248](#).
- [Hua08] Yi-Zhi Huang. *Rigidity and modularity of vertex tensor categories*. Communications in Contemporary Mathematics, 10(supp01):871–911, 2008. [arXiv:math/0502533](#).
- [HZW05] Alioscia Hamma, Paolo Zanardi, and Xiao-Gang Wen. *String and membrane condensation on three-dimensional lattices*. Physical Review B, 72(3), 2005. [arXiv:cond-mat/0411752](#).
- [JF22] Theo Johnson-Freyd. *On the classification of topological orders*. Communications in Mathematical Physics, 2022. [arXiv:2003.06663](#).
- [Kit03] Alexei Kitaev. *Fault-tolerant quantum computation by anyons*. Annals of Physics, 303(1):2–30, 2003. [arXiv:quant-ph/9707021](#).
- [Kit06] Alexei Kitaev. *Anyons in an exactly solved model and beyond*. Annals of Physics, 321(1):2–111, 2006. [arXiv:cond-mat/0506438](#).
- [KK12] Alexei Kitaev and Liang Kong. *Models for gapped boundaries and domain walls*. Communications in Mathematical Physics, 313(2):351–373, 2012. [arXiv:1104.5047](#).
- [KL20] Kyle Kawagoe and Michael Levin. *Microscopic definitions of anyon data*. Physical Review B, 101(11), 2020. [arXiv:1910.11353](#).
- [KLWZZ20a] Liang Kong, Tian Lan, Xiao-Gang Wen, Zhi-Hao Zhang, and Hao Zheng. *Algebraic higher symmetry and categorical symmetry: A holographic and entanglement view of symmetry*. Physical Review Research, 2(4), 2020. [arXiv:2005.14178](#).
- [KLWZZ20b] Liang Kong, Tian Lan, Xiao-Gang Wen, Zhi-Hao Zhang, and Hao Zheng. *Classification of topological phases with finite internal symmetries in all dimensions*. Journal of High Energy Physics, 2020(9), 2020. [arXiv:2003.08898](#).
- [KO02] Alexander Kirillov, Jr. and Viktor Ostrik. *On a  $q$ -analogue of the McKay correspondence and the ADE classification of  $\hat{\mathfrak{sl}}_2$  conformal field theories*. Advances in Mathematics, 171(2):183–227, 2002. [arXiv:math/0101219](#).
- [Kon14] Liang Kong. *Anyon condensation and tensor categories*. Nuclear Physics B, 886:436–482, 2014. *Erratum and addendum: “Anyon condensation and tensor categories” [Nucl. Phys. B 886 (2014) 436–482]*. Nuclear Physics B, 973:115607, 2021. See a corrected version in, [arXiv:1307.8244](#).
- [KR09] Liang Kong and Ingo Runkel. *Cardy algebras and sewing constraints, I*. Communications in Mathematical Physics, 292(3):871–912, 2009. [arXiv:0807.3356](#).

- [KS11] Anton Kapustin and Natalia Saulina. *Topological boundary conditions in abelian Chern-Simons theory*. Nuclear Physics B, 845(3):393–435, 2011. [arXiv:math.QA/1008.0654](#).
- [KTZ20a] Liang Kong, Yin Tian, and Zhi-Hao Zhang. *Defects in the 3-dimensional toric code model form a braided fusion 2-category*. Journal of High Energy Physics, 2020(78), 2020. [arXiv:2009.06564](#).
- [KTZ20b] Liang Kong, Yin Tian, and Shan Zhou. *The center of monoidal 2-categories in 3+1D Dijkgraaf-Witten theory*. Advances in Mathematics, 360:106928, 2020. [arXiv:1905.04644](#).
- [KW14] Liang Kong and Xiao-Gang Wen. *Braided fusion categories, gravitational anomalies, and the mathematical framework for topological orders in any dimensions*. arXiv preprint, 2014. [arXiv:1405.5858](#).
- [KWZ15] Liang Kong, Xiao-Gang Wen, and Hao Zheng. *Boundary-bulk relation for topological orders as the functor mapping higher categories to their centers*. arXiv preprint, 2015. [arXiv:1502.01690](#).
- [KWZ17] Liang Kong, Xiao-Gang Wen, and Hao Zheng. *Boundary-bulk relation in topological orders*. Nuclear Physics B, 922:62–76, 2017. [arXiv:1702.00673](#).
- [KWZ22] Liang Kong, Xiao-Gang Wen, and Hao Zheng. *One dimensional gapped quantum phases and enriched fusion categories*. Journal of High Energy Physics, 2022(3), 2022. [arXiv:2108.08835](#).
- [KYZ21] Liang Kong, Wei Yuan, and Hao Zheng. *Pointed Drinfeld center functor*. Communications in Mathematical Physics, 381(3):1409–1443, 2021. [arXiv:1912.13168](#).
- [KZ17] Liang Kong and Hao Zheng. *Semisimple and separable algebras in multi-fusion categories*. arXiv preprint, 2017. [arXiv:1706.06904](#).
- [KZ18a] Liang Kong and Hao Zheng. *The center functor is fully faithful*. Advances in Mathematics, 339:749–779, 2018. [arXiv:1507.00503](#).
- [KZ18b] Liang Kong and Hao Zheng. *Gapless edges of 2d topological orders and enriched monoidal categories*. Nuclear Physics B, 927:140–165, 2018. [arXiv:1705.01087](#).
- [KZ20] Liang Kong and Hao Zheng. *A mathematical theory of gapless edges of 2d topological orders. Part I*. Journal of High Energy Physics, 2020(2), 2020. [arXiv:1905.04924](#).
- [KZ21a] Liang Kong and Hao Zheng. *Categories of quantum liquids II*. arXiv preprint, 2021. [arXiv:2107.03858](#).
- [KZ21b] Liang Kong and Hao Zheng. *A mathematical theory of gapless edges of 2d topological orders. Part II*. Nuclear Physics B, 966:115384, 2021. [arXiv:1912.01760](#).
- [KZ22a] Liang Kong and Zhi-Hao Zhang. *An invitation to topological orders and category theory*. arXiv preprint, 2022. [arXiv:2205.05565](#).
- [KZ22b] Liang Kong and Hao Zheng. *Categories of quantum liquids I*. Journal of High Energy Physics, 2022(8), 2022. [arXiv:2011.02859](#).
- [KZ22c] Liang Kong and Hao Zheng. *Categories of quantum liquids III*. arXiv preprint, 2022. [arXiv:2201.05726](#).
- [KZZZ24] Liang Kong, Zhi-Hao Zhang, Jiaheng Zhao, and Hao Zheng. *Separable algebras in higher fusion categories*. In preparation, 2024.

- [Lei02] Tom Leinster. *A survey of definitions of  $n$ -category*. Theory and Applications of Categories, 10(1):1–70, 2002. [arXiv:math/0107188](#).
- [Lev13] Michael Levin. *Protected edge modes without symmetry*. Physical Review X, 3(2), 2013. [arXiv:1301.7355](#).
- [LKW16] Tian Lan, Liang Kong, and Xiao-Gang Wen. *Modular extensions of unitary braided fusion categories and 2+1D topological/SPT orders with symmetries*. Communications in Mathematical Physics, 351(2):709–739, 2016. [arXiv:1602.05936](#).
- [LKW17] Tian Lan, Liang Kong, and Xiao-Gang Wen. *Classification of  $(2+1)$ -dimensional topological order and symmetry-protected topological order for bosonic and fermionic systems with on-site symmetries*. Physical Review B, 95(23), 2017. [arXiv:1602.05946](#).
- [Lur09] Jacob Lurie. *Higher Topos Theory*. Princeton University Press, 2009. [arXiv:math/0608040](#).
- [Lur17] Jacob Lurie. *Higher Algebra*. Book online, 2017. <http://www.math.harvard.edu/~lurie/papers/HA.pdf>.
- [LW05] Michael A. Levin and Xiao-Gang Wen. *String-net condensation: A physical mechanism for topological phases*. Physical Review B, 71(4), 2005. [arXiv:cond-mat/0404617](#).
- [LY23] Yalei Lu and Holiverse Yang. *The boundary phase transitions of the 2+1D  $\mathbb{Z}_N$  topological order via topological Wick rotation*. Journal of High Energy Physics, 2023(10), 2023. [arXiv:2208.01572](#).
- [LYW23] Tian Lan, Gen Yue, and Longye Wang. *Gauging of generalized symmetry*. arXiv preprint, 2023. [arXiv:2312.15958](#).
- [MP17] Scott Morrison and David Penneys. *Monoidal categories enriched in braided monoidal categories*. International Mathematics Research Notices, 2019(11):3527–3579, 2017. [arXiv:1701.00567](#).
- [MS89] Gregory Moore and Nathan Seiberg. *Classical and quantum conformal field theory*. Communications in Mathematical Physics, 123(2):177–254, 1989.
- [Mü03] Michael Müger. *From subfactors to categories and topology II: The quantum double of tensor categories and subfactors*. Journal of Pure and Applied Algebra, 180(1-2):159–219, 2003. [arXiv:math/0111205](#).
- [Ost03] Victor Ostrik. *Module categories, weak Hopf algebras and modular invariants*. Transformation Groups, 8(2):177–206, 2003. [arXiv:math/0111139](#).
- [Reh90] Karl-Henning Rehren. *Braid group statistics and their superselection rules*. In *The Algebraic Theory of Superselection Sectors*, pages 333–355. World Scientific, 1990.
- [RSS23] Konstantinos Roumpedakis, Sahand Seifnashri, and Shu-Heng Shao. *Higher gauging and non-invertible condensation defects*. Communications in Mathematical Physics, 401(3):3043–3107, 2023. [arXiv:2204.02407](#).
- [RT91] N. Reshetikhin and V.G. Turaev. *Invariants of 3-manifolds via link polynomials and quantum groups*. Inventiones Mathematicae, 103(1):547–597, 1991.
- [SSC19] Wilbur Shirley, Kevin Slagle, and Xie Chen. *Universal entanglement signatures of foliated fracton phases*. SciPost Physics, 6(1), 2019. [arXiv:1803.10426](#).

- [SSWC18] Wilbur Shirley, Kevin Slagle, Zhenghan Wang, and Xie Chen. *Fracton models on general three-dimensional manifolds*. Physical Review X, 8(3):031051, 2018. [arXiv:1712.05892](#).
- [Str12] Ross Street. *Monoidal categories in, and linking, geometry and algebra*. Bulletin of the Belgian Mathematical Society - Simon Stevin, 19(5), 2012. [arXiv:1201.2991](#).
- [SW03] Paolo Salvatore and Nathalie Wahl. *Framed discs operads and Batalin-Vilkovisky algebras*. The Quarterly Journal of Mathematics, 54(2):213–231, 2003.
- [TW19] Ryan Thorngren and Yifan Wang. *Fusion category symmetry I: Anomaly in-flow and gapped phases*. arXiv preprint, 2019. [arXiv:1912.02817](#).
- [VHF16] Sagar Vijay, Jeongwan Haah, and Liang Fu. *Fracton topological order, generalized lattice gauge theory, and duality*. Physical Review B, 94(23):235157, 2016. [arXiv:1603.04442](#).
- [Wen90] Xiao-Gang Wen. *Topological orders in rigid states*. International Journal of Modern Physics B, 04(02):239–271, 1990.
- [Wen91] Xiao-Gang Wen. *Non-Abelian statistics in the fractional quantum Hall states*. Physical Review Letters, 66(6):802–805, 1991.
- [Wen17] Xiao-Gang Wen. *Colloquium : Zoo of quantum-topological phases of matter*. Reviews of Modern Physics, 89(4), 2017. [arXiv:1610.03911](#).
- [Wen19] Xiao-Gang Wen. *Choreographed entanglement dances: Topological states of quantum matter*. Science, 363(6429):eaal3099, 2019. [arXiv:1906.05983](#).
- [Wen20] Xiao-Gang Wen. *Systematic construction of gapped nonliquid states*. Physical Review Research, 2(3):033300, 2020. [arXiv:2002.02433](#).
- [Wit89] Edward Witten. *Quantum field theory and the Jones polynomial*. Communications in Mathematical Physics, 121(3):351–399, 1989.
- [XLWWC23] Wenjie Xi, Tian Lan, Longye Wang, Chenjie Wang, and Wei-Qiang Chen. *On a class of fusion 2-category symmetry: condensation completion of braided fusion category*. arXiv preprint, 2023. [arXiv:2312.15947](#).
- [XZ22] Rongge Xu and Zhi-Hao Zhang. *Categorical descriptions of 1-dimensional gapped phases with abelian onsite symmetries*. arXiv preprint, 2022. [arXiv:2205.09656](#).
- [YWL24] Gen Yue, Longye Wang, and Tian Lan. *Condensation completion and defects in 2+1d topological orders*. arXiv preprint, 2024. [arXiv:2402.19253](#).
- [ZLZH<sup>+</sup>23] Jiaheng Zhao, Jia-Qi Lou, Zhi-Hao Zhang, Ling-Yan Hung, Liang Kong, and Yin Tian. *String condensations in 3+1D and Lagrangian algebras*. Advances in Theoretical and Mathematical Physics, 27(2), 2023. [arXiv:2208.07865](#).