

# Towards Data-center Level Carbon Modeling and Optimization for Deep Learning Inference

Shixin Ji  
University of Pittsburgh, USA  
shixin.ji@pitt.edu

Zhuoping Yang  
University of Pittsburgh, USA  
zhuoping.yang@pitt.edu

Xingzhen Chen  
University of Pittsburgh, USA  
xingzhen.chen@pitt.edu

Jingtong Hu  
University of Pittsburgh, USA  
jthu@pitt.edu

Yiyu Shi  
University of Notre Dame, USA  
yshi4@nd.edu

Alex K. Jones  
University of Pittsburgh, USA  
akjones@pitt.edu

Peipei Zhou  
University of Pittsburgh, USA  
peipei.zhou@pitt.edu

## Abstract

Recently, the increasing need for computing resources has led to the prosperity of data centers, which poses challenges to the environmental impacts and calls for improvements in data center provisioning strategies. In this work, we show a comprehensive analysis based on profiling a variety of deep-learning inference applications on different generations of GPU servers. Our analysis reveals several critical factors which can largely affect the design space of provisioning strategies including the hardware embodied cost estimation, application-specific features, and the distribution of carbon cost each year, which prior works have omitted. Based on the observations, we further present a first-order modeling and optimization tool for data center provisioning and scheduling and highlight the importance of environmental impacts from data center management.

## 1 Introduction

Datacenters have become a significant source of energy consumption globally. Although they currently consume approximately 1% of energy consumption worldwide [33], estimates have them reaching or exceeding 10% globally in the next five to ten years [9]. This has raised concerns about the greenhouse gas (GHG) resulting from powering these datacenters. However, considerable effort is being explored to address this concern by powering data centers using renewable energy sources [26]. In fact, data centers may prove to be highly effective at harnessing renewable energy, which can be prone to periodic or even unpredictable peaks in troughs [10]. Through renewable energy over-provisioning, data centers can obtain sufficient energy even at moderate to low generation periods and can absorb energy overruns by computing low-priority jobs using periods of high energy generation.

Until recent, a series of studies and tools have been proposed to quantify the GHG emissions, as well as to gain insights into system upgrading and system design. Also, a lot

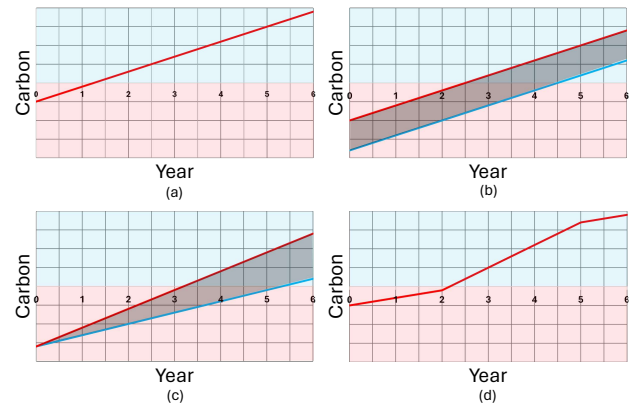

**Figure 1.** The effects of considering 3 key insights over the carbon estimation model (a): 1. considering the whole system and the data uncertainty will lead to a larger embodied carbon cost (b), 2. specifying different workloads running on the system will lead to various operational carbon costs (c), 3. applying the depreciation model enables more flexibility and fine-grained control of data centers’ carbon (d).

of discussions have been made around the tradeoffs between carbon cost in the manufacturing phase and the usage phase, i.e. the embodied carbon cost and the operational carbon cost. However, our experiments and analysis reveal there are important aspects that prior work omitted discussion, which could affect the scale of the quantified GHG emission, and can further change the space of optimization and upgrade decisions.

As shown in the Figure 1, we summarize our findings into three main key points: the estimation of embodied cost, the characteristics of applications, and the distribution of embodied carbon cost in the lifetime:

**“To be (a whole system), or not to be, that is the question”, i.e., we should take a whole system view, not a single device view, in the embodied cost estimation:**

Prior carbon cost estimation tools, such as Greenchip [24, 25] and ACT [20], usually use the processor parts in a computing system to represent the whole system. In other words, these works give estimations of “partial systems”. Such methods could be applicable in scenarios, e.g., the edge devices. However, our analysis reveals that in the data center scenarios, the peripheral components like the main board take a non-negligible proportion of the carbon cost. Omitting these components can cause a gap of up to 7.5x underestimation of carbon cost in certain situations. Moreover, our analysis of about 100 server product carbon footprint reports from main server vendors (Dell, HP, Lenovo) and hardware manufacturers in the market shows the data uncertainty of the reported carbon cost, which poses challenges to the data-driven approach for carbon cost estimation of the datacenter server system.

**“The newer, the better” is not always true and we should consider the characteristics of applications:** Hardware provisioning, including datacenter servers upgrading, i.e., replacing the existing devices with newer ones, is an important topic in data center management. However, when comparing strategies of whether to keep the existing devices or upgrade to new devices, prior works usually omit one critical factor in their discussions: the applications running on the devices. We apply Nvidia Triton, an industrial AI inference server framework and profile a variety of AI inference applications on three generations of server systems with different generations of GPUs.<sup>1</sup> Our experiments demonstrate that the throughput gain of upgrading devices for different deep learning inference applications can vary a lot, leading up to a 6.15x difference between the shortest and longest break-even time of carbon costs.

**Understanding carbon depreciation, i.e., the distribution of embodied carbon cost in the lifetime, is important:** The awareness of environmental protection has led to the concept of “carbon budget”, which calls for a more advanced view of the carbon emissions in computing activities. Currently, some works have been proposed to quantify the carbon cost of certain tasks, whereas their consideration of the embodied carbon cost is simplified. For example, when estimating the carbon cost of large language models (LLM), their carbon cost modeling distributes the overall embodied carbon cost evenly into the typical lifetime of accelerators. In this work, we show that by applying the depreciation model - the model used for financial budgets - to the carbon costs,

<sup>1</sup>We choose to study deep learning inference workloads based on the facts that: (1) artificial intelligence (AI) and deep learning (DL) workloads contribute a significant portion of the growth of the datacenter infrastructure; (2) DL inference contributes a significant portion among the total DL workloads including both inference and training. This is partly reflected in Nvidia’s fourth quarter of the fiscal year 2024 earnings call, in which Nvidia reported that the inference was estimated to be 40% of datacenter revenues in F24 [30]. We will perform a similar analysis for DL training workloads in our future work.

the design space of data center provisioning will change in certain cases, and the best design choice can be different.

We summarize the main contributions of this work as follows:

- We propose a first-order estimation approach by combining the traditional predictive carbon estimation methods and the carbon footprint reports from hardware manufacturers and vendors. We also give the reference value of empirical parameters to get the server system carbon from the single CPU or GPU device carbon based on our analysis and experiments (Section 3).
- We first summarize the current state-of-the-art server carbon footprint reports from mainstream vendors including HP, Dell, and Lenovo. Based on the analysis of these reports, we are the first to point out the existing gap between embodied costs of computing systems and the reports from prior works (Section 4).
- We profile ten different AI inference workloads using the industrial AI inference framework. Based on the profile results, we provide a comprehensive analysis of the influence of applications on the data centers’ sustainability analysis (Section 5).
- We first introduce the depreciation model, a mature method in the asset management area into the data center sustainability analysis, showing the opportunity for policies pushing datacenter users/managers towards using/provisioning systems in a more sustainable way (Section 6).

## 2 Related Work

### 2.1 The Growing Awareness of Sustainability and Corporate Sustainability Efforts from Manufacturers and Vendors

The growing awareness of sustainability and carbon footprints has significantly impacted various aspects of society, from individual lifestyle choices to corporate strategies and government policies. Companies like Apple [11], Google [19], Dell [15], HP [21], and Lenovo [27], among others, have begun to report the carbon footprints of their products. These reports revealed one important fact, i.e., even with nonrenewable energy consumption, the GHG emissions are dominated by manufacturing the device in the whole life cycle. Upstream in the information and communication technologies (ICT) supply chain, semiconductor manufacturers such as TSMC and SK Hynix also disclose their reports of corresponding technology nodes while other vendors such as Intel and Samsung report more aggregated data. These chip manufacturers have started to **outstrip** automakers in terms of their annual GHG emissions. TSMC reaches nearly 9 t CO<sub>2</sub>e in 2019, whereas General Motors hovered around 8 t CO<sub>2</sub>e until 2016 and dropped to 6 metric t CO<sub>2</sub>e in 2019 [14].

## 2.2 Carbon Cost Quantifying and Estimation Tools

Academic research efforts have made considerable progress over the last decade to estimate or profile the hardware systems’ carbon cost and use the profiling information to guide the design toward sustainable systems. Earlier works in the 2000s focused on the operation carbon cost of computing systems [12, 18, 32], which is consistent with industry emphasis on reducing the energy consumption and such a method provided significant cost savings as datacenters started to become prevalent. In more recent years, with seminal work starting about a decade ago [22] noting that the embodied costs are consuming more and more of the overall carbon footprints in a product’s lifetime, consequentially requiring more attention. Life Cycle Assessment (LCA) is a common method to quantitatively evaluate the GHG emissions of computing systems throughout their whole lifetime.

Other than the LCA tools, more carbon cost estimation and analysis approaches are proposed to derive insights into designing sustainable computing systems. Greenchip [24, 25] is the earliest predictive estimation tool to comprehensively understand the environmental impact of computing systems. Greenchip is based on dynamic LCA (DLCA) which is required to understand systems like datacenters, which vary considerably over time and have considered aspects of maintenance that play a significant role in the carbon footprint [13]. This tool takes architecture specifications and semiconductor technology fabrication nodes as inputs, using a simulator to estimate the cost in the operation phase and the hardware configurations to estimate the cost in the manufacturing phase. Greenchip has been expanded to include major system components of processors, memory, and solid-state storage, and integrates notions of reliability, and sources of energy production to compare different system architectures on performance, energy, and sustainability metrics. More recently, ACT [20] is a system modeling tool that is built, like Greenchip, with lower-level data from industry fabs’ but with a focus to massage system level parameters to better calibrate to technology companies’ LCA reports and can estimate systems with different types of system-on-chip (SoC) and storage devices.

Based on these carbon cost estimation tools, more studies are conducted to gain insights into more specific domains. [28] utilizes similar approaches as ACT, and integrates the modeling of embodied and operational carbon to understand the environmental impact of high-performance computing (HPC) systems. [16] focuses on CPU designs and estimates the carbon cost efficiency of a series of different processor mechanisms. [17] performs a task-centralized carbon cost analysis and gives an estimation of the carbon cost in the training and inference phases of large language models. Moreover, more methods including task offloading, chiplet systems, are proposed in designing a more sustainable system. For example, GreenScale [23] proposes an application

scheduling mechanism, utilizing the various carbon intensities in different locations to reach a lower overall operational carbon cost. REFRESH [35] poses the opportunity to save carbon by building new FPGA chiplet systems by reusing the decommissioned old FPGA chips and extending their lifetime.

## 3 Methodology

Modeling the carbon cost of a given computing system comprehensively requires taking the whole life cycle of the system into account. Typically, there are 4 main phases in the lifetime of electronic devices: manufacturing, transportation, operational use, and end-of-life (EOL) processing. Among these phases, the manufacturing and operational use phases usually take a dominant proportion in carbon costs, which usually take more than 97% of the overall cost as reported by the server vendors. In this work, as a first-order estimation, we consider the embodied carbon cost  $C_e$ , the operational carbon cost  $C_o$ , and the overall carbon cost  $C_{all}$  as their combination.

$$C_{all} = C_e + C_o \quad (1)$$

### 3.1 Embodied Carbon Cost Modeling

It has become a trend that the embodied carbon costs have been taking more and more proportion of the overall cost of various computing systems, e.g., servers, desktops, laptops, and phones. For edge devices, the embodied carbon cost can take up to 86% as reported by [11, 19, 34]. For data center servers, this rate is around 10% to 60% as reported by the server vendors.

In this work, inspired by prior works like Greenchip [24, 25] and ACT [20], we also assume that for a functional circuit chip such as a CPU or a GPU, the embodied carbon cost  $C_{chip}$  is mainly proportional to its chip area. As shown in Equation 2, the coefficient cost per area ( $CPA$ ) is related to multiple factors including the manufacturing process, the gas and chemical emissions, the materials, and yields in the chip fabrication phase.

$$C_{chip} = CPA \cdot Area_{chip} \quad (2)$$

For storage devices like HDD, SSD, and main memory DRAM, we use their capacity, together with the coefficient cost per capacity ( $CPC$ ) reported by manufacturers and vendors to estimate the embodied carbon cost.

$$C_{mem} = CPC \cdot Capacity_{chip} \quad (3)$$

Moreover, the packaging of integrated circuits (IC) also causes a carbon footprint, where each IC package takes about 150 g CO<sub>2</sub>e carbon cost. We thus model the carbon cost of packaging  $C_{package}$  (unit: kg CO<sub>2</sub>e) as below:

$$C_{package} = 0.15 \cdot \#IC_{package} \quad (4)$$

Using the  $C_{chip} + C_{mem} + C_{package}$ , we can estimate the carbon cost of most of the IC components in a computing system. However, important components in a typical server system, including the printed wiring boards (PWB), riser cards, chassis, and power supply units (PSU) should also be included. Unfortunately, these components are not as well-studied as the IC components and prior works fail to consider those. In this work, we use an additional coefficient  $(1 + P)$  to scale up the IC carbon cost to represent the system carbon cost more accurately.

$$C_e = (1 + P) \cdot (C_{chip} + C_{mem} + C_{package}) \quad (5)$$

Here  $P$  stands for the effect of peripheral components. In Section 4.1, we show that  $P$  is much larger than 0 due to several reasons. In fact, the coefficient can go up to 7.6 in certain server setups.

### 3.2 Operational Carbon Cost Modeling

Operational carbon cost is also very important. The operational carbon cost of one computing system in a period is related to (1) its energy consumption and (2) the carbon intensity ( $CI$ ), which represents how much carbon cost is needed to produce a unit of energy.

$$C_o = Energy \cdot CI \quad (6)$$

The energy consumption of one system is related to its power, which can vary within a certain duration. Generally, the energy consumption of one system can be represented as  $\sum P_i \cdot t_i$ , where  $P_i$  and  $t_i$  represent the system power consumption and elapsed time in different time frames. In this work, for simplicity, we assume the systems have 2 modes, i.e., activated mode and idle, and denote the utilization ( $util$ ) as the proportion of activated mode. In the life cycle assessment report of Dell server R740 [7], the  $util$  is assumed as 0.3.

$$Energy = P_{act} \cdot util \cdot T + P_{idle} \cdot (1 - util) \cdot T \quad (7)$$

As for the carbon intensity, we utilize the carbon reports from [31]. We use  $CI = 0.395, 0.234, 0.438, 0.188$  kgCO<sub>2</sub>e/kWh for the carbon intensity in four different states, Arizona (AZ), California (CA), Texas (TX), and New York (NY), respectively.

### 3.3 Experimental Setup

We perform our experiments on four computing systems, which are equipped with GPUs and CPUs of three different generations. The GPUs and CPUs of the systems are listed in Table 1. The three GPUs are Nvidia V100, A10G, and RTX5000Ada. They are released in the same time gap (three years) and have a similar thermal design power (TDP). For the CPUs, the die sizes of Intel Xeon Gold 6346 and AMD EPYC 7R32 are not reported by the vendors. In order to estimate the embodied cost, we use the die size of 660 mm<sup>2</sup> as an estimation, this is based on the observation that these

**Table 1.** Three generations of GPUs and corresponding CPUs equipped in the three generations of servers.

Type	Name	Node	Die Size	TDP	Date
GPU	NVIDIA V100	12nm	815mm <sup>2</sup>	300W	2017
GPU	NVIDIA A10G	8nm	628mm <sup>2</sup>	300W	2021
GPU	NVIDIA RTX5000Ada	5nm	609mm <sup>2</sup>	250W	2023
CPU	Xeon E5 2686 v4	14nm	456mm <sup>2</sup>	145W	2016
CPU	AMD EPYC 7R32	7nm	N/A	280W	2020
CPU	Intel Xeon Gold 6346	10nm	N/A	205W	2021

**Table 2.** Details of the four studied server systems. Three are public datacenter servers and one is a local datacenter server. CPU number is the ratio of the CPU threads (e.g., allocated vCPUs in public data center, or actual CPU in local data center) of the total CPU resources within a chip.

No.	Server	CPU	CPU Num	GPU	GPU Num
1	AWS p3.2xlarge	Xeon E5 -2686 v4	0.22*	NVIDIA V100	1
2	AWS G5.2xlarge	AMD EPYC 7R32	0.083*	NVIDIA A10G	1
3	AWS G5.16xlarge	AMD EPYC 7R32	0.67*	NVIDIA A10G	1
4	Local	Intel Xeon Gold 6346	1	NVIDIA RTX5000Ada	1

CPUs have similar package sizes, thus the chip sizes are also limited.

The server details, including the type, and the number of the CPU and GPU, of studied systems are shown in Table 2. Among them, three are public datacenter servers in Amazon Web Service (AWS) and one is a local datacenter server, with the latest Ada architecture GPU Nvidia RTX5000Ada.

In terms of the software, we utilize the NVIDIA Triton [3] framework to execute the AI inference workloads. As a server framework, Triton contains a web server to process requests from the clients and a model inference worker where models are executed in a containerized manner. The configuration parameters of the Triton server could affect the inference throughput, and these parameters include (1) the batch size of the model; (2) the number of instances, i.e., the number of a certain model running in parallel; and (3) concurrency: the number of requests processed by the web server together. To fully utilize the GPU systems, we leverage the Triton model analyzer [4] to search for the configuration that yields the highest throughput for a model. The model analyzer will

**Table 3.** Details of different deep learning models.

App.	Task	Param.	App.	Task	Param.
DenseNet	CV	7.98M	VGG19	CV	143.65M
ResNet50	CV	25.56M	Bert-1	NLP	340M
Resnet 50-local	CV	25.56M	OPT-2.7B	LLM	2.7B
Resnet 101	CV	44.55M	Falcon-7B	LLM	7B
Bert-b	NLP	110M	Persimmon-8B	LLM	8B

execute a brute search of batch size and number of instances, increasing the GPU utilization.

We study ten representative models including computer vision (CV) models, transformer-based natural language processing models (NLP), and GPT-based large language models (LLM) and deploy them onto the Triton framework, as shown in Table 3. The CV models are from PyTorch Hub [6] and the NLP/LLM models are from Hugging face [2]. When deploying the model, we mainly use the Python backend of Triton.

## 4 Towards Accurate Embodied Carbon Analysis

In this section, we show the missing points that the state-of-the-art approaches omitted to discuss. We first compare the report of the popular tools, ACT [20] tool and the PAIA [5] tool, a commercial LCA tool widely used by server vendors to generate carbon footprint reports, to demonstrate the non-negligible portion of carbon cost from the peripheral components within the whole computing system. Then we summarize the data uncertainty of the key data resources of sustainability analysis, and the reports of the manufacturers and vendors. To demonstrate the effects of these factors, a case study is set up to show the difference between before vs. after considering these factors.

### 4.1 The Carbon Cost of Peripheral Components

By comparing and analyzing the two reported carbon cost from ACT [20] and PAIA [7] for the Dell R740 server, we show that the peripheral devices contribute a considerable proportion to the overall carbon cost.

The Dell R740 rack server is equipped with a mainboard installed with 2x Intel Xeon 6152 CPUs, 8x 3.84TB SSDs (SSD1), 1x 400GB SSD (SSD2), and 12x 32GB DRAM. The server also contains 3 riser cards (devices for adding more expansion cards to the mother board, such as the PCIE slot), an HDD controller, an ethernet, and an Ethernet controller, as well as PSUs, fans, and chassis.

As shown in Figure 5, we break down the reports from the two tools. The part with the largest gap is the **CPU vs. mainboard** pair, where a **7.6x** gap exists between the two reports (23.14 vs. 175.3). In these parts, for the CPU alone, a roughly 2x gap exists, and another 5.6x carbon cost comes from the other part of the mainboard which ACT omitted to discuss, including the mainboard printed wiring board

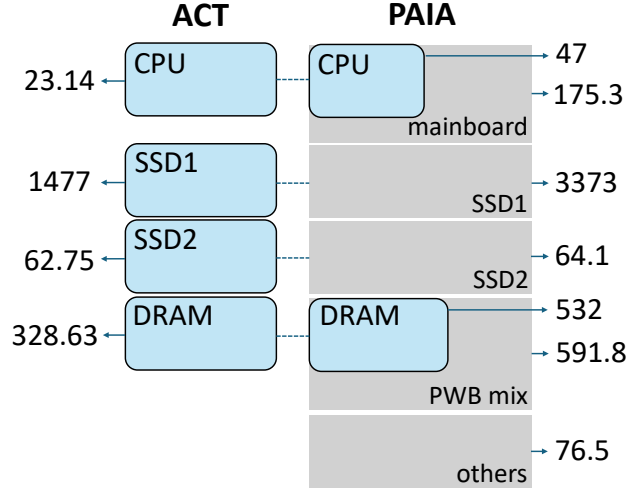

**Figure 2.** The comparison between reports of ACT and PAIA for the same Dell R740 server setup. Carbon cost in the figure are using kg CO<sub>2</sub>e as unit.

(PWB) (108.68 kg CO<sub>2</sub>e), connectors (7.36 kg CO<sub>2</sub>e), and the transportation in the manufacturing phase (12.80 kg CO<sub>2</sub>e).

For the storage and memory devices including SSDs and DRAMs, there exists a 2.3x and 1.61x gap for SSD1 and DRAM, For the SSD2, the two tools made a similar estimation.

ACT also ignored the riser cards, HDD controller, ethernet, and ethernet controller, which are reported by Dell in the **PWB mix** category, as well as the power supply unit (PSU), chassis, and fans, which are represented in the **others** category in 5. These 2 groups of components take 136.3 kg CO<sub>2</sub>e, reaching 77% of the mainboard’s carbon cost.

In total, there is a 2.26x gap when comparing ACT’s report to Dell’s PAIA report. To be noted, in this server setup, there are in total 32TB of SSDs, leading to a dominant proportion of embodied carbon cost. In other GPU servers, when the SSD and DRAM sizes are not that large to support the accelerated tasks, the gap between the ACT tool and the PAIA tool can be larger. In an extreme case, i.e., a CPU-dominate system, where SSD and DRAM’s effects are ignored, we can have an upper bound of the  $(1 + P)$  as 13.4, which is an order of magnitude difference. If we consider more realistic systems when using the setup of Dell R740 in Dell’s carbon footprint report [8], a reference value of  $(1 + P)$  can be used as 6.81. In this setup, the server has only 1.6TB HDD and 32GB DRAM, and We use  $CPC = 1.3g\ CO_2e/GB$ , which is from the manufacturers’ report.

For GPU devices, the vendors don’t report a detailed carbon cost breakdown. Based on the assumption that the GPU chip and its peripheral components share the same pattern as the CPU, in this work, we have an assumption of the  $(1 + P)$  in GPU devices as 7.6.



## 4.2 Data Uncertainty in the Reports

Compared with the prior works of predictive carbon cost estimation tools, training a statistic model on top of the manufacturers’ and vendors’ reports is another way to create an accurate end-to-end model. However, our study reveals one challenge: the data uncertainty across these reports. We collect all the available carbon footprint reports from current server vendors including Dell, HP, and Lenovo, the largest three server vendors in the global server market, which provide in total of 96 different reports from their corresponding official websites [15, 21, 27]. These reports contain servers released ranging from 2014 to 2022. We also compare these carbon footprint reports from server vendors with other reports by the SSD vendors and manufacturers. By analyzing the vendor reports, we summarize three sources of data uncertainty.

First, the GHG emissions of certain components are not always available. Among the three vendors, HP reports the most detailed server configurations to generate the carbon footprint reports including the number of CPUs, number of cores per CPU, main memory sizes (GB), and storage sizes including SSD size and HDD size. However, reports from other vendors miss some important categories such as the number of cores per CPU, SSD size, or CPU memory size.

The second data uncertainty comes from the inconsistency of certain components in the computing systems even within the same vendor. An example is the different trendlines of Lenovo’s SSD and HDD reports. The quantities, i.e., the number of HDDs have a nice linear relationship to their embodied carbon cost, in which  $R^2 = 0.998$ . However, the  $R^2$  of SSD quantities and corresponding carbon cost is only 0.061, suggesting that there is no linear relationship regarding all the points as a whole. As shown in Figure 3, after manually dividing the points into 2 groups, the  $R^2$  of each group increased to 0.974 and 0.192 each, suggesting that Lenovo probably used 2 or more kinds of SSDs with different capacities or types. As a result, it is hard to figure out the exact carbon cost if the storage sizes/types are not specified.

The third source of data uncertainty is the inconsistency of embodied carbon cost reports across vendors. During the analysis, we found that the servers from different vendors but with similar configurations can have huge differences in the reported embodied carbon cost. For example, both released in 2021, the carbon cost of Lenovo SR670v2 with 2x CPUs, 6x SSDs, and no DRAM information specified, has the reported carbon cost of 7613 kg CO<sub>2</sub>e. However, the HP ProLiant DL380 gen10 plus performance configuration with 2x 32core CPUs, 24x 1.6T SSDs, and 1024GB DRAMs, has the reported value of 3880 kg CO<sub>2</sub>e. If such pairs are used to train a statistic model with only currently provided configurations, it will probably produce a negative co-efficiency for parameters like SSD sizes, which generates faulty modeling results. In addition, some reports from hardware vendors are

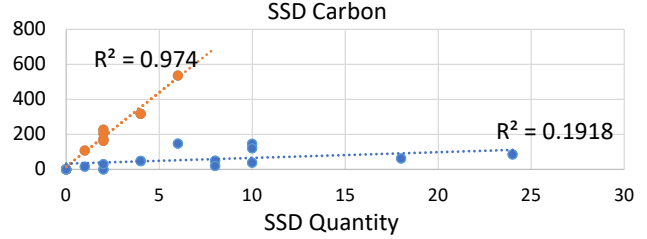

**Figure 3.** Two distinct trendlines of SSD carbon (kg CO<sub>2</sub>e) vs. SSD quantity.

also incompatible with reports from manufacturers, for example, Dell reports a *CPC* of SSD in their LCA report of R740 as 0.101kgCO<sub>2</sub>e/GB, whereas Seagate reports their *CPC* of SSD as 0.006kgCO<sub>2</sub>e/GB [1].

## 4.3 Break-even Analysis with a Higher and More Accurate Embodied Cost

When the embodied cost of a computing system is scaled up, one result is that when considering upgrading systems, the immediate “carbon tax”, i.e., embodied carbon, for buying the new system will be larger. As a newer system usually has a better power efficiency, this “tax” from upgrading will be filled by the gain from operational carbon cost saving year by year gradually.

It seems that there will always be one day when newer systems outperform old ones in terms of sustainability, however, this is not true. In fact, we must consider the lifetime of devices. If the break-even time, i.e., how long it takes for the strategies of upgrading or not upgrading to reach the same total carbon cost amount, is longer than the planned lifetime, then this break-even time in the carbon cost will never happen.

Explicitly, we consider a “partial” upgrade from system 3 to system 4, where we only consider upgrading the mainboards, including, CPU and GPU, PWB, and reusing the HDDs and SSDs. The server’s utilization is set to 0.3 and the carbon intensity is set to 0.188 kgCO<sub>2</sub>e/kWh, which represents the carbon intensity of NY state in the US. Also, we take throughput improvement into consideration, i.e., we scale the number of servers within two systems by matching the same throughput. For example, in Persimmon-8B model, system 4 reaches a 1.16x higher throughput than system 3. Therefore, we will scale the number of servers in system 3 by 1.16x, which will lead to an increase in the embodied carbon cost and yearly operational carbon cost.

Figure 4 shows the carbon cost gain of upgrading system 3 to system 4 under different assumptions of scaling factor  $(1 + P)$ . When the  $(1 + P)$  is set to 1, the break-even time is 0.56 years, and the original carbon tax is -37 kg CO<sub>2</sub>e, which is from the prior works [20, 29]. As we use more accurate server system carbon modeling by increasing  $(1 + P)$ , the intercept, i.e., the carbon tax is bigger. When we set the

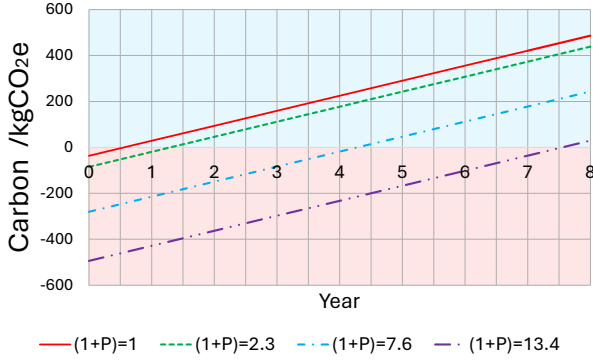

**Figure 4.** The break-even analysis result of upgrading system 3 to system 4, under different assumptions of the value of  $(1 + P)$ , i.e., the carbon cost of the whole system to the cost of CPU(s) and GPU(s).

**Table 4.** Throughput Improvement of different application groups

Improvement	Overall	CV	NLP	LLM
System 1 to 2	1.15	1.32	0.94	1.11
System 3 to 4	1.72	1.74	1.70	1.26

$(1 + P)$  to 2.3, which is the gap between the overall reported value of ACT and Dell’s LCA report, the break-even time increases to 1.29 years. When the  $(1+P)$  is set to 7.6, the break-even time is 4.28 years, which is larger than the estimated server lifetime of 4 years in Dell’s report. When the  $(1 + P)$  is set to the upper bound mentioned in 4.1, the estimated 494 kg CO<sub>2</sub>e of embodied cost leads to a break-even time of 7.55 years, almost 60% more than the typical lifetime of electronic devices, which is 5 years [29].

This case also applies if we also choose to upgrade memory devices in this system. Take SSD as an example, according to Seagate’s report, the estimated yearly energy consumption of SSDs is 0.86 kWh/TB, while the yearly energy consumption of system 4 using the above setup is 277.3 kW h. As a result, when considering the SSDs, the initial gap of the break-even analysis will become larger, while the operational carbon remains almost the same. This could lead to an even longer break-even time than estimated in Figure 4.

## 5 Effect of Various Applications

In this section, we discuss the effect of different applications in the data center provisioning. As shown in Table 4, we list the profile results of our model, which suggests a huge variance among different applications.

In the profile of all four systems, we divide them into 2 groups, i.e., Group1: system 1 compared with system 2, and Group2: system 3 compared with system 4. This partition is to ensure fairness in the CPU parts: both system 1 and system 2 contain 4 physical CPU cores (8 threads), while

system 3 and system 4 contain 32 CPU cores(64 threads). We also divide the applications into CV and NLP categories, the CV applications are of the CNN architecture, while the NLP applications use the attention mechanism. Especially, as Large-language models are becoming popular in recent years, we deployed and profiled 3 LLMs: the OPT-2.7B, Falcon-7B, and the Persimmon-8B . We also analyze these 3 models together, denoted as the LLM applications.

Overall, the average throughput improvements of all profiled applications are 1.15x for Group 1 and 1.72x for Group 2, and there exists a obvious variance among improvements on different applications. In Group 1, the improvements of CV and LLM applications are 1.32x and 1.11x, respectively. Whereas the improvement on the NLP applications are only 0.94x, which is counterintuitive. And In Group 2, the improvements of CV and NLP applications are 1.74x and 1.70x, but the improvement for LLM applications is only 1.26x. Specifically, the most throughput gain of 2.35x happens in Group 2 on the bert-b application, where system 3 yields 19.5 inference/second, and system 4 yields 45.9 inference/second. On the other hand, the least positive improvement comes from the Falcon-7B at Group 1, where system 1 and 2 only achieve 2.1 and 2.2 inference/second, respectively.

For the counterintuitive phenomena in our profiling, we believe there are multiple reasons, and make a discussion in 5.4.

### 5.1 Effect of Different Throughput Improvements

At the data center level, when considering upgrading devices, an important benchmark is throughput-matching, which means we need to consider the gain and cost after normalization with throughput. In this work, for simplicity, when comparing 2 systems, we scale up the system with smaller throughputs as a whole and ensure the two systems have the same throughput. As a result, the embodied cost and operational cost of the weaker system will also be scaled up, leading to a potential affection on the break-even analysis.

Under the throughput-matching principle, the scaling factor is completely determined by the throughput improvement, so that the application running on the system can also influence the break-even time in hardware provisioning.

As shown in the Figure 5, we conduct the break-even analysis of 2 groups, i.e. system 1 to system 2 and system 3 to system 4. For simplicity, only the carbon cost of the mainboard parts (including PWBs and CPUs) and the GPUs are taken into account. In the embodied cost estimation, we set  $(1+P)$  as 7.6 and in the operational cost estimation, we set the working power  $P_{act}$  as the TDP of corresponding devices and idle power  $P_{idle}$  as 10% TDP. In addition, the utilization and carbon intensity are set to 0.3 and 0.188 kgCO<sub>2</sub>e/kWh, respectively.

For the mix of all applications, the break-even time is 3.3 years for upgrading system 1 to system 2, and 1.2 years for upgrading system 3 to 4, which is smaller than the typical

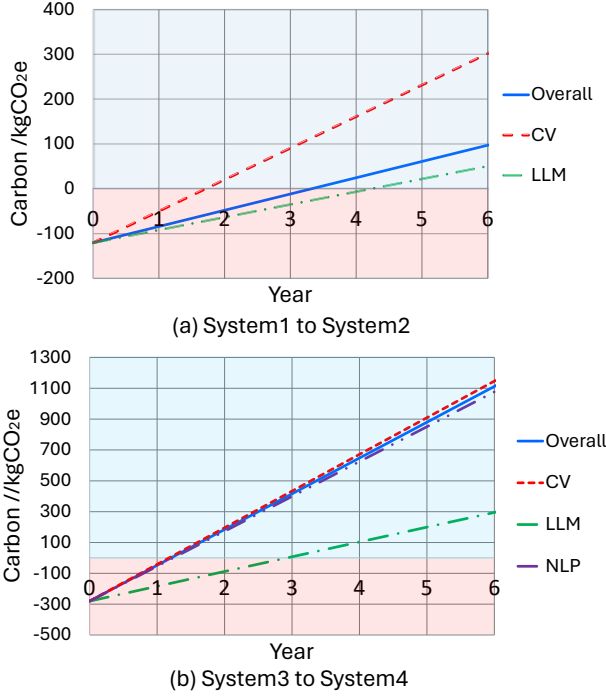

**Figure 5.** The break-even analysis results of upgrading 2 groups of systems, under the assumption of different targeted application groups. In (a), since the throughput improvement of LLM group is only 0.94, it will never break-even.

lifetime of electronic devices. And when it comes to different applications, the break-even time varies. Especially, the break-even time of upgrading system 1 to system 2 on LLM applications is 4.22 years. Such a break-even time goes over the estimation of the typical server lifetime of Dell, which is 4 years. This indicates that in the break-even analysis, when different applications are considered, the final choice of upgrading or not may change due to the applications.

## 5.2 Effect of Power Usage

Besides the throughput improvement, the varying working power of a computing system also affects the provisioning choices. For accelerators like GPUs, their working power is related to different parts such as the DRAM, different kinds of processing units, as well as the caches. As a result, for certain tasks especially the small ones, it can be hard to reach the TDP as some GPU components easily get saturated, while others remain stranded.

We observe such power variance when profiling different applications. To demonstrate this, we select 2 representative applications, OPT-2.7B and ResNet-101 to perform break-even analysis. This analysis uses the same setup as mentioned in Section 5.1, except that we compare the difference when either using the TDP or the runtime power as the working power.

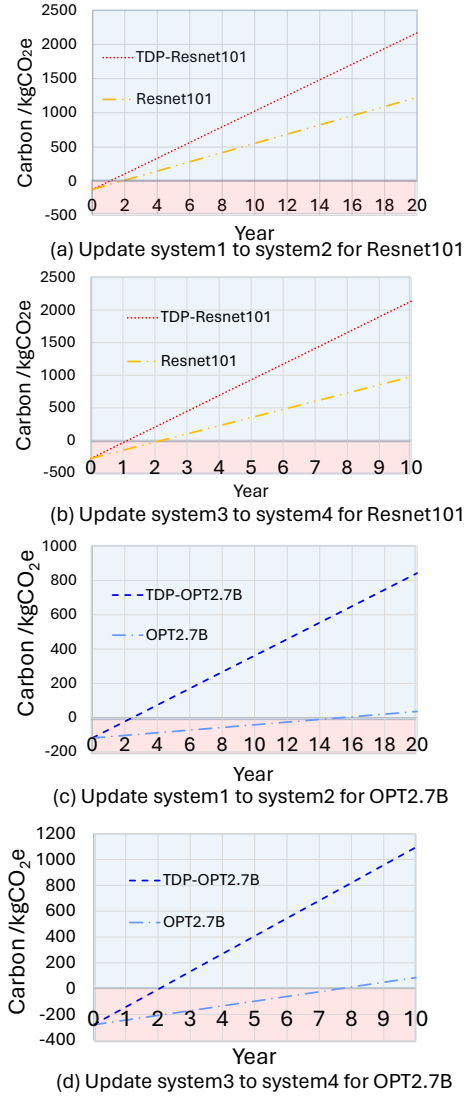
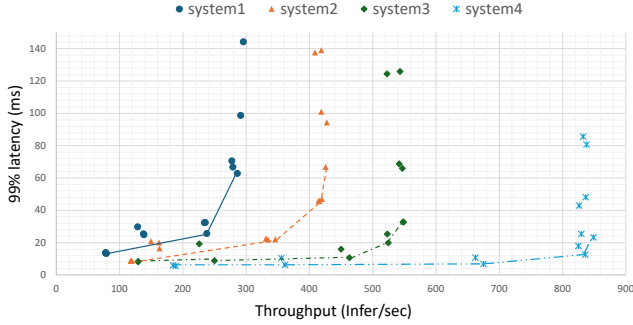

**Figure 6.** Break-even analysis of upgrading 2 groups of systems running the ResNet 101 and OPT-2.7B applications, under different assumptions of working power  $P_{act}$ .

The results of the break-even analysis are shown in Figure 6, where the lines named with "TDP" are the results using GPUs' TDP as the  $P_{act}$ , while the others use the measured power. In our experiments, we find that the utilization of CPUs in each system is usually larger than 90%, so we still use the TDP for CPUs.

In general, using the measured power will lead to a longer break-even time, since the measured power is smaller than TDP, thus the differences on the energy consumption and the operational carbon cost across systems also decrease.





**Figure 7.** The throughput-latency tradeoff and Pareto front of 4 systems running ResNet50 application.

As a result, it will take more time for the upgraded system to "catch up" with the old one. For instance, when targeted at OPT-2.7B, the scaled TDP of system1 and system2 are 390.5 and 322.4 W, so the yearly operational carbon gain of upgrading is 112.15 kg CO<sub>2</sub>e. However, the measured GPU powers in inference are 116.2 and 163W for V100 and A10G GPUs, resulting in a yearly operational carbon gain of about 10 kg CO<sub>2</sub>e, which leads to an extremely large break-even time.

### 5.3 Throughput-latency Tradeoff

Throughput is not the only criterion of a computing system, in certain cases, we may have requirements for the latency of tasks. In this work, by modifying the concurrency, we're able to generate a group of latency-throughput pairs of one system running one application.

Figure 7 shows the throughput-99%latency tradeoff of all 4 systems running the Resnet-50 model, where data points with latencies surpassing 150 ms are omitted from the explicit viewpoint.

By showing the Pareto front of the tradeoffs, we are able to analyze the throughput improvement under different latency requirements. In the pair of system 1 and system 2, when there's no constraint on latency, the throughput improvement is 1.46x, while when a 20-ms deadline applies, the improvement goes up to 2.08x. In the pair of systems 3 and 4, the trend is similar: after adding a deadline of 15 ms, the throughput improvement goes from 1.55 to 1.80. In conclusion, our profile shows that under a tight latency constraint, the newer GPU systems can have an even higher throughput gain than the situations with loose latency constraints.

### 5.4 Threats to Validity

We acknowledge that as real computing systems are very complicated, our profile on these systems cannot reflect the actual situations of all data center systems. Also, when performing the data center provisioning, the GPU is not the only consideration for selecting candidates, and the throughput is not the only criterion for normalization, either.

In an actual computing system executing a pipeline, the GPU's computation capability is not the only bottleneck, CPUs, memory, and the other parts of the GPU can bound one system's overall performance. For instance, to execute the pipeline of a Bert model, it takes both the CPU for pre-processing such as tokenization, and the GPU for model inference. In our experiment, when comparing system 2 and system 3, which only differs from the CPU number, for the bert-l application, system 3 with 32 CPU cores achieves a 2.67x improvement over system 2 with 4 CPU cores. As a comparison, the two systems reach almost the same throughput for the large language models Persimmon-8B and Falcon-7B.

Moreover, the Triton framework contains a web server, which utilizes the CPUs to process the requests from clients. As a result, when the CPU is not enough, all of the inference servers will be slowed down. In the profile of the resnet50-local application, where the request and response are just empty packages, we observe a throughput gain of 1.18x between systems 2 and 3. Also, after increasing the CPU core number, the throughput of resnet50, which has the common request and response package size, reaches the same throughput as the resnet50-local. This proves the existence of the overhead caused by Triton web server.

The GPU memory can bound the system, too. In the experiments of system 1, the deployment of Persimmon-8B failed in our experiment due to the lack of memory, in such cases, it could be a must for the data center owners to upgrade the device as long as running such tasks is required.

In addition, it's worthwhile to consider the software part of the computing systems. For instance, in our experiment, we use the Python backend of Triton, which treats the inference of different models as running Python scripts, which usually requires more frequent participation of CPUs compared with other backends like the onnx and the TensorRT, which is optimized for AI inference. By transferring to these backends, throughput and latency improvement are expected to happen in all the systems. Other software optimization techniques like quantization can also influence the break-even time. Since the Nvidia GPUs after the Turing architectures are equipped with tensor cores which are optimized especially for low-precision computations, the A10G GPUs and the RTX5000Ada GPUs may obtain more gains than the V100 GPUs.

## 6 Distribution of Embodied Costs

In this section, with the introduction of depreciation models in the financial and assets management domain, we show the opportunity to manage the "assets of carbon" in a fine-grained manner by revealing the new design spaces and choices brought by the depreciation models.

Generally, the depreciation models are used to represent the obsolescence or expiration of physical assets, to reflect their real value in the useful life.

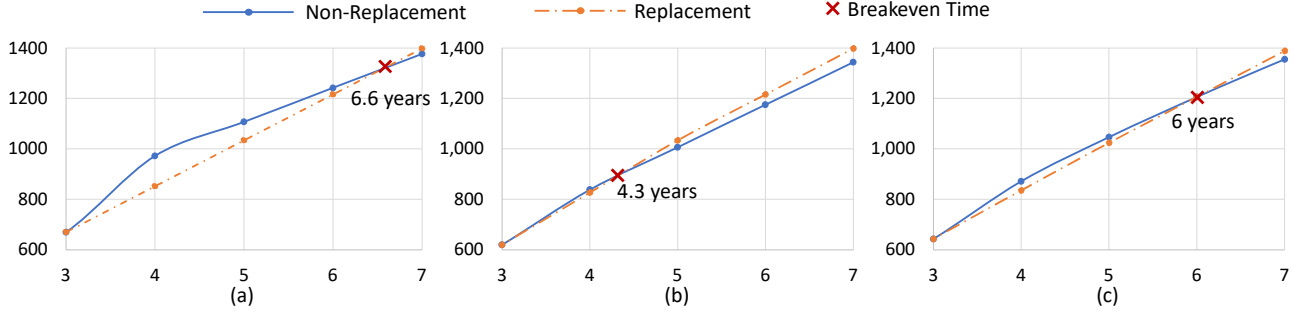

**Figure 8.** The total carbon cost of a hypothetical data center with 2 different strategies, under the assumptions of (a) no depreciation model used; (b) linear depreciation model, and (c) DDB depreciation model.

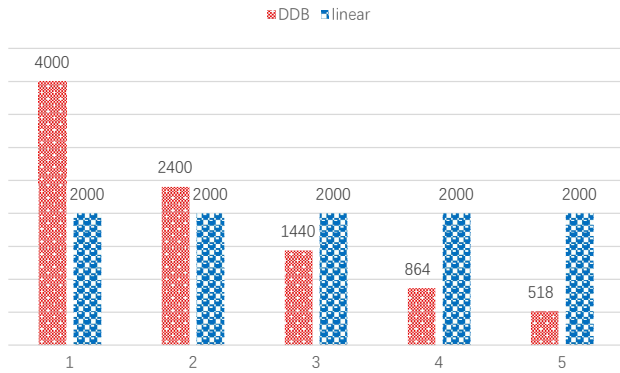

**Figure 9.** The comparison of cost distribution in a 5-year lifetime of DDB and linear depreciation models. Assuming the total embodied carbon cost are 10000 k]gCO<sub>2</sub>e and the estimated lifetime is 5 years.

### 6.1 Quantify Embodied Carbon Cost per Task

As the awareness of sustainability grows, more users are eager to quantify the environmental impact of their actions, and academic and industrial organizations are also willing to exhibit their efforts of saving the carbon. However, in recent studies, the approach of quantifying the embodied carbon cost per task is not as mature as the estimation for operational carbon cost. Like the use of other physical assets, one intuitive thought could be that using the new GPUs should have different environmental impacts from using the old, “second-hand” GPUs. Whereas in current works, the embodied carbon cost is simply distributed evenly across the lifetime. By applying the depreciation models, The earlier years in a system’s life time can come with a higher embodied cost. As shown in Figure 9, with a system whose total embodied carbon cost of 10,000 k]gCO<sub>2</sub>e and estimated life time of 5 years, under the traditional(linear) model, the embodied carbon costs of each year are the same 2000 k]gCO<sub>2</sub>e. On the other hand, under the double-declining balance (DDB) depreciation model, the carbon cost of the first 2 years are

4000 and 2400 k]gCO<sub>2</sub>e each, which is 2x and 1.2x more than the linear model.

Consider a more realistic case, suppose in the year 2023, a user needs to decide between the A10G GPU system and the RTX5000Ada GPU system for the inference of DenseNet. For simplicity, we only discuss the GPU part. The total embodied costs of A10G and RTX5000Ada are 108.3 and 168.4 kg CO<sub>2</sub>e each, while the yearly operational carbon costs are 179.5 and 289.9 kg CO<sub>2</sub>e. Under the principle of throughput-matching, a scaling factor of 1.75 is to be applied to the carbon cost of A10G system.

Assuming the lifetime of both GPUs is 5 years, if we simply use the linear model to distribute the embodied costs, the embodied costs for A10G and RTX5000Ada in 2023 are 21.66 and 33.68 kg CO<sub>2</sub>e, respectively. The normalized overall carbon costs in 2023 are thus 355.6 and 323.6 kg CO<sub>2</sub>e. It seems that the RTX5000Ada systems are more environmental-friendly, however, this model doesn’t consider the fact that the A10G GPUs were released in 2020, and are used for 3 years typically.

To represent the gap of used years, we apply a double-declining balance (DDB) method to the embodied carbon costs, where the lifetime is set to 5 years and the remaining value is set to 0. Under this model, the embodied carbon cost of RTX5000Ada in 2023 increases to 67.36kg CO<sub>2</sub>e, whereas the cost of A10G decreases to 17.90 kg CO<sub>2</sub>e. As a result, the total carbon costs for the A10G and RTX5000Ada models are 332.0 and 357.3 kg CO<sub>2</sub>e. That is to say, by utilizing the depreciation model, we can flip the choice of 2 systems in terms of carbon cost.

### 6.2 Opportunity for Service Providers

In the traditional data center provisioning analysis, the embodied carbon cost of the new devices is considered as an immediate payment, which is not convenient for quantifying the overall carbon cost of tasks in the data center. By using the double-declining balance (DDB) method to distribute the embodied carbon costs into devices’ lifetime, we can smooth the overall carbon cost curve of a data center over years,

as well as show flexibility by showing different break-even times.

Consider running Persimmon-8B inference on the A10G and RTX5000Ada GPUs, after the normalization of throughput matching, the 2 GPUs have the embodied carbon cost of 124 and 167 kg CO<sub>2</sub>e and the yearly operational carbon cost of 182 and 135 kg CO<sub>2</sub>e, respectively. In an actual data center, the upgrading from A10G to RTX5000Ada can not happen at the very beginning, according to Table 1, this upgrading choice should happen at the beginning of the fourth year after the A10G is released.

For this hypothetical data center, we model the total carbon cost each year of upgrading and non-upgrading strategies under 3 setups, as shown in figure 8. In this figure, subfigure (a) represents the traditional case, where an immediate carbon cost is applied to the replacement strategy. In subfigures (b) and (c), where the depreciation model of linear and DDB methods applies, the curve is smooth as the embodied carbon is also distributed each year.

By using different assumptions, we can also find a shift in the break-even time. Without a depreciation model, the break-even time is 6.6 years whereas with a linear model, this time can be reduced to 4.3 years. Thus, the introduction of the depreciation model also enables flexibility to adjust the estimation to the future under different situations.

## 7 Conclusion

In this paper, we discuss three critical points in the carbon cost quantification of the data center area: the consideration of the whole system, the specifying of different workloads running on computing systems, and the distribution of embodied cost in the lifetime. By holistically collecting and studying the carbon footprint reports from the market-leading server vendors, we point out the missing points of prior works in considering a whole computing system. Based on our analysis, we also propose a first-order carbon cost estimation approach by integrating traditional predictive tools and data-driven models. Based on a comprehensive profile of 10 representative applications conducted on the industrial AI inference framework, we give an analysis of the influence of software applications on the data centers' sustainability. We are the first to introduce a different depreciation model to the data center sustainability analysis, revealing the chance for a more sustainable, flexible, and fine-grained data center management.

## References

- [1] Esg environment, social, and governance at seagate. [Available Online] <https://www.seagate.com/esg/planet/product-sustainability/>.
- [2] Hugging face. [Available Online] <https://huggingface.co/>.
- [3] Nvidia triton inference server. [Available Online] <https://developer.nvidia.com/triton-inference-server>.
- [4] Nvidia triton inference server model analyzer. [Available Online] [https://github.com/triton-inference-server/model\\_analyzer/tree/main](https://github.com/triton-inference-server/model_analyzer/tree/main).
- [5] Product attributes to impact algorithm. [Available Online] <https://paia.mit.edu/>.
- [6] Pytorch hub. [Available Online] <https://pytorch.org/hub/>.
- [7] Life Cycle Assessment of Dell R740. [Available Online] [https://www.delltechnologies.com/asset/en-us/products/servers/technical-support/Full\\_LCA\\_Dell\\_R740.pdf](https://www.delltechnologies.com/asset/en-us/products/servers/technical-support/Full_LCA_Dell_R740.pdf), 2019.
- [8] Poweredge r740. [Available Online] [https://i.dell.com/sites/csdocuments/CorpComm\\_Docs/en/carbon-footprint-poweredger740.pdf](https://i.dell.com/sites/csdocuments/CorpComm_Docs/en/carbon-footprint-poweredger740.pdf), 2019.
- [9] Electricity, 2023. <https://www.iea.org/energy-system/electricity>.
- [10] Harnessing solar energy via globally-distributed data centers, 2023. <https://www.sysnet.ucsd.edu/~yig004/files/netzero23-abstract.pdf>.
- [11] Apple, Inc. Product environmental reports. [Available Online] <https://www.apple.com/in/environment/>, 2023.
- [12] Luiz André Barroso and Urs Hölzle. The case for energy-proportional computing. *Computer*, 40(12):33–37, 2007.
- [13] William O. Collinge, Amy E. Landis, Alex K. Jones, Laura A. Schaefer, and Melissa M. Bilec. Dynamic life cycle assessment: framework and application to an institutional building. *The International Journal of Life Cycle Assessment*, 18(3), 2013.
- [14] Alan Crawford, Ian King, and Debby Wu. The chip industry has a problem with its giant carbon footprint. April 2021. [Available Online] <https://www.bloomberg.com/news/articles/2021-04-08/the-chip-industry-has-a-problem-with-its-giant-carbon-footprint>.
- [15] Dell, Inc. Product environmental reports. [Available Online] <https://www.dell.com/en-us/dt/corporate/social-impact/advancing-sustainability/climate-action/product-carbon-footprints.htm>, 2023.
- [16] Lieven Eeckhout. Focal: A first-order carbon model to assess processor sustainability. 2024.
- [17] Ahmad Faiz, Sotaro Kaneda, Ruhan Wang, Rita Osi, Parteek Sharma, Fan Chen, and Lei Jiang. Llmcarbon: Modeling the end-to-end carbon footprint of large language models. *arXiv preprint arXiv:2309.14393*, 2023.
- [18] Xiaobo Fan, Wolf-Dietrich Weber, and Luiz Andre Barroso. Power provisioning for a warehouse-sized computer. *ACM SIGARCH computer architecture news*, 35(2):13–23, 2007.
- [19] Google. Product environmental reports. [Available Online] <https://sustainability.google/reports/>, 2023.
- [20] Udit Gupta, Mariam Elgamal, Gage Hills, Gu-Yeon Wei, Hsien-Hsin S. Lee, David Brooks, and Carole-Jean Wu. Act: Designing sustainable computer systems with an architectural carbon modeling tool. In *Proceedings of the 49th Annual International Symposium on Computer Architecture*, page 784–799. Association for Computing Machinery, 2022.
- [21] Hewlett Packard Enterprise (HPE), Inc. Product environmental reports. [Available Online] [https://www.hpe.com/psnow/doc/a50002945enw.pdf?jumpid=in\\_pdfviewer-psnow](https://www.hpe.com/psnow/doc/a50002945enw.pdf?jumpid=in_pdfviewer-psnow), 2023.
- [22] Alex K. Jones, Yiran Chen, William O. Collinge, Haifeng Xu, Laura A. Schaefer, Amy E. Landis, and Melissa M. Bilec. Considering fabrication in sustainable computing. In *2013 IEEE/ACM International Conference on Computer-Aided Design (ICCAD)*, pages 206–210, 2013.
- [23] Young Geun Kim, Udit Gupta, Andrew McCrabb, Yonglak Son, Valeria Bertacco, David Brooks, and Carole-Jean Wu. Greenscale: Carbon-aware systems for edge computing. *arXiv preprint arXiv:2304.00404*, 2023.
- [24] Donald Kline, Nikolas Parshook, Xiaoyu Ge, Erik Brunvand, Rami Melhem, Panos K Chrysanthis, and Alex K Jones. Holistically evaluating the environmental impacts in modern computing systems. In *2016 Seventh International Green and Sustainable Computing Conference (IGSC)*, pages 1–8. IEEE, 2016.
- [25] Donald Kline, Nikolas Parshook, Xiaoyu Ge, Erik Brunvand, Rami Melhem, Panos K. Chrysanthis, and Alex K. Jones. Greenchip: A tool for evaluating holistic sustainability of modern computing systems. *Sustainable Computing: Informatics and Systems*, 22:322–332, 2019.

- [26] Soongeol Kwon. Ensuring renewable energy utilization with quality of service guarantee for energy-efficient data center operations. *Applied Energy*, 276:115424, 2020.
- [27] Lenovo, Inc. Product environmental reports. [Available Online] <https://www.lenovo.com/us/en/compliance/eco-declaration/>, 2023.
- [28] Baolin Li, Rohan Basu Roy, Daniel Wang, Siddharth Samsi, Vijay Gadeppally, and Devesh Tiwari. Toward sustainable hpc: Carbon footprint estimation and environmental implications of hpc systems. In *Proceedings of the International Conference for High Performance Computing, Networking, Storage and Analysis*, pages 1–15, 2023.
- [29] Baolin Li, Rohan Basu Roy, Daniel Wang, Siddharth Samsi, Vijay Gadeppally, and Devesh Tiwari. Toward sustainable hpc: Carbon footprint estimation and environmental implications of hpc systems. In *Proceedings of the International Conference for High Performance Computing, Networking, Storage and Analysis, SC '23*, New York, NY, USA, 2023. Association for Computing Machinery.
- [30] Nvidia. Nvidia investor presentation february 2024. In *Nvidia Presentations*, 2024. [Available Online] [https://s201.q4cdn.com/141608511/files/doc\\_financials/2024/q4/NVDA-F4Q24-Quarterly-Presentation-FINAL.pdf](https://s201.q4cdn.com/141608511/files/doc_financials/2024/q4/NVDA-F4Q24-Quarterly-Presentation-FINAL.pdf).
- [31] Sébastien Ollivier, Sheng Li, Yue Tang, Stephen Cahoon, Ryan Caginpal, Chayanika Chaudhuri, Peipei Zhou, Xulong Tang, Jingtong Hu, and Alex K Jones. Sustainable ai processing at the edge. *IEEE Micro*, 43(1):19–28, 2022.
- [32] Karthick Rajamani and Charles Lefurgy. On evaluating request-distribution schemes for saving energy in server clusters. In *2003 IEEE International Symposium on Performance Analysis of Systems and Software. ISPASS 2003.*, pages 111–122. IEEE, 2003.
- [33] L Varro and G Kamiya. 5 ways big tech could have big impacts on clean energy transitions, 2021. <https://www.iea.org/commentaries/5-ways-big-tech-could-have-big-impacts-on-clean-energy-transitions>.
- [34] Jaylen Wang, Udit Gupta, and Akshitha Sriraman. Peeling back the carbon curtain: Carbon optimization challenges in cloud computing. In *Proceedings of the 2nd Workshop on Sustainable Computer Systems, HotCarbon '23*, 2023.
- [35] Peipei Zhou, Jinming Zhuang, Stephen Cahoon, Yue Tang, Zhuoping Yang, Xingzhen Chen, Yiyu Shi, Jingtong Hu, and Alex K Jones. Refresh fpgas: Sustainable fpga chiplet architectures. *arXiv preprint arXiv:2312.02991*, 2023.