

Dynamics of the Non-equilibrium spin Boson Model: A Benchmark of master equations and their validity

Gerardo Suárez,* Marcin Łobejko, and Michał Horodecki
*International Centre for Theory of Quantum Technologies,
University of Gdansk, 80-308 Gdansk, Poland*

(Dated: March 8, 2024)

In recent years, there has been tremendous focus on identifying whether effective descriptions of open quantum systems such as master equations, provide the correct steady state in the long time limit. The correct steady state is usually not known, however it can be approximated by means of the Mean Force Hamiltonian up to some fixed order [1, 2], the reaction coordinate mapping or other pseudo-mode like approaches [3, 4]. A few years ago a controversy arose concerning the thermalization of master equations, namely, whether steady state coherences actually arise in systems with composite interactions or if they are some artifact caused by nonpositivity [5–7] of the effective description, in this manuscript we confirm the existence of such steady state coherences in numerically exact dynamics, and see reminiscences of it in a CPTP map, while the steady state coherence seems to be real its oscillatory character seems to be an artifact of second order approximations, indicating that rather than being steady state coherences as one may think, the equilibrium state of the system is not diagonal in the basis of the system Hamiltonian. This paper also shows evidence than comparing Hamiltonian corrections calculated from the mean force approach and the quasi-steady states of dynamical equations may be deceiving, as dynamics may not tend to the state with the correction as shown in this paper

I. INTRODUCTION

Open quantum systems usually reach a steady state due to their interaction with their environment, when we consider the environment to be in a thermal state. The standard Markovian master approach indicates that our system reaches an equilibrium in a thermal state with the temperature of the bath. Depending on whether we consider Lamb-shift terms or not the equilibrium state will be the energy gap of the bare Hamiltonian, meaning the original Hamiltonian. Completely ignoring dressing effects, or if we include it then the frequency will be renormalized, but again the equilibrium state will be a Gibbs state of the system Hamiltonian (renormalized or not). Other approaches, however, lead to steady states that are not necessarily the Gibbs state of the system Hamiltonian, a fact that has been studied extensively and for a long time in the literature [1, 8–11]. Recently, there was a controversy surrounding consequences of this fact, the controversy was due to the so called steady state coherences present in the Redfield equation, which as their name states are coherences that persist during the open system evolution, they were presented in [6] the results of that paper however were obtained for the Redfield equation which is not completely positive, so it was argued later than this effect may come from lack of complete positivity [7] rather than being a true effect. In this paper we aim to contribute to this discussion by showing that such a similar effect is also found in a CPTP map, this map is another form of modeling Non-Markovian open

quantum system dynamics known as the cumulant equation or the refined weak coupling [12, 13]. Which shows oscillations in the coherences for long times, similar to those reported for the Redfield equation in [6]. Notice that in the previously mentioned reference they are associated with Lamb-shift while for this CPTP map, they are rather related to slow convergence to the steady state.

We present analytical calculations for the cumulant equation when orthogonal interactions are involved, and a way to obtain them via linear maps, we believe this formulation proves useful for analytical calculations, specially when one approximates the decay rates as proposed in [14]. This alternate formulation to solve the cumulant equation also provides with a simple way of separating the transient from the asymptotic dynamics of the system, which we believe may be useful for certain situations, it also allows for an straight forward way to write this equation in a master equation form.

We then show that while not oscillating those steady state coherences are present if we solve the dynamics exactly, in this paper we do this by means of the hierarchical equations of motion (HEOM) [15], using the recent Qutip BoFiN implementation [16]. This translates into the fact that the steady state is not diagonal in the basis of the system Hamiltonian, a fact that has consequences for the efficiencies of quantum machines [4].

We also recover simpler models for the cumulant equation from our general model, for the typical spin boson the treatment differs from Rivas [12] in that we shall present a compact, simple equation for the dynamics as opposed to the formulas provided there. We argue that this form of the cumulant equation is easier to simulate as well as more transparent, which allows one to draw conclusions from the equations more easily. For the pure

* gerardo.suarez@phdstud.ug.edu.pl

dephasing model we show that the cumulant equation matches the exact solution, as does time convolution-second order master equation but not Bloch-Redfield (BR) [17]. Code to reproduce to simulate the cumulant equation in general has been made available by the authors in [18], the examples include the cumulant equation simulated in the form described in this paper.

Finally we discuss the role of Lamb-shift on the cumulant equation dynamics, we discuss on the dilemma of neglecting Lamb-shift and compare the dynamics and steady state when it's present or not to the exact dynamics. We shall also expose that the discussion about Lamb-shift is more complicated in the non-Markovian regime and conclude on possible paths to adequate renormalization. It may also be argued that such Lamb-shift that does not simply shift the energy of the system but rather has implications in its dynamics (because it does not commute with the system Hamiltonian) appears because we shouldn't simply start for an arbitrary initial state but need to take into account the state preparation procedure, which will modify the dynamics accordingly [19]. In this paper we don't consider such situation and study dynamics from an arbitrary initial product state.

Table 1 : Steady state of composite interactions



Steady-state coherences arise when composite interactions are in place, meaning there is an interaction that is both parallel and orthogonal to the system Hamiltonian $H_S = \frac{\omega\sigma_z}{2}$ the figure above illustrates the different cases that rise in a spin-boson model depending on the interaction Hamiltonian H_I

- The first figure shows the case in which we have an interaction that is orthogonal to H_S , the system is driven to a Gibbs state at the temperature of the bath. No steady state coherences are generated.
- The second one shows an interaction that is neither orthogonal nor parallel to H_S but that instead is made of a composition of both orthogonal and parallel components, in this setting steady state coherences are generated
- The third one illustrates H_S parallel to the interaction. In this case, the populations of the system are not driven towards the Gibbs state at the bath's temperature, only coherences evolve and they go towards zero.

II. THE CUMULANT EQUATION FOR A MODEL WITH COMPOSITE INTERACTIONS

The system of interest in this paper is a spin with composite interactions to a bosonic bath, for generality we will consider the most general Hamiltonian we can get for a simple spin boson model which is given by:

$$H = \underbrace{\frac{\omega_0}{2}\sigma_z}_{H_S} + \underbrace{\sum_k w_k a_k^\dagger a_k}_{H_B} + \underbrace{\sum_k g_k (f_1\sigma_x + f_2\sigma_y + f_3\sigma_z)(a_k + a_k^\dagger)}_{H_I} \quad (1)$$

The main model in this paper is the cumulant equation [12–14] whose derivation is included in this manuscript as an appendix for completeness. In general the cumulant equation is determined by the exponential of the map:

$$\mathcal{K}_t[\rho_S^{(0)}] = -i[\Lambda(t), \rho_S^{(0)}] + \mathcal{D}(\rho) \quad (2)$$

where

$$\mathcal{D}(\rho) = \sum_{\omega, \omega'} \sum_{\alpha, \beta} \Gamma_{\alpha\beta}(\omega, \omega', t) \left(A_\alpha(\omega') \rho_S^{(0)} A_\beta^\dagger(\omega) - \frac{1}{2} \{ A_\beta^\dagger(\omega) A_\alpha(\omega'), \rho_S^{(0)} \} \right). \quad (3)$$

Here

$$\Gamma_{\alpha, \beta}(w, w', t) = \int_0^t dt_1 \int_0^t dt_2 e^{i(\omega t_1 - w' t_2)} \mathcal{C}_{\alpha, \beta}(t_1, t_2) \quad (4)$$

with

$$\mathcal{C}_{\alpha, \beta}(t_1, t_2) = \langle B_\beta(t_1) B_\alpha(t_2) \rangle \quad (5)$$

and

$$\Lambda(t) = \sum_{w, w'} \sum_{\alpha, \beta} \xi_{\alpha, \beta}(w, w', t) A_\alpha^\dagger(w) A_\beta(w') \quad (6)$$

with

$$\xi_{\alpha, \beta}(w, w', t) = \iint_0^t \frac{dt_1}{2i} dt_2 \text{sgn}(t_1 - t_2) e^{i(\omega t_1 - w' t_2)} \mathcal{C}_{\beta, \alpha}(t_1, t_2). \quad (7)$$

The dynamics of our state is then simply given by:

$$\rho(t) = e^{\mathcal{K}_t}[\rho_S^{(0)}] \quad (8)$$

In general, however it can be rewritten in another way which we find more transparent and easier to work with for semi-analytical calculations [12, 14]. Let us choose

to represent our density matrix for SU(N) following the prescription by [20]:

$$\rho = \frac{\mathbb{I}}{N} + \frac{1}{2} \sum_{l=1}^{N-1} \lambda_l w_l \quad (9)$$

Where

$$\begin{aligned} \lambda_l &= \text{Tr}[w_l \rho] \quad (10) \\ w_l &= -\sqrt{\frac{2}{l(l+1)}} (P_{1,1} + P_{2,2} + \dots + P_{l,l} + lP_{l+1,l+1}) \quad (11) \end{aligned}$$

As the map is linear we can in general write its action on the density matrix as linear transformation

$$\mathcal{K}_t[\rho] = (M \frac{\vec{w}}{2} + \vec{r}) \cdot \vec{\lambda} \quad (12)$$

Which can be easily exponentiated and yields (see Appendix, eq. (A51)):

$$\rho(t) = \frac{\mathbb{I}}{2} + (e^M - \mathbb{I})M^{-1}\vec{r} \cdot \vec{w} + e^M \frac{\vec{\lambda}}{2} \cdot \vec{w} \quad (13)$$

In fact the expression (13) not only works for the exponential of a the cumulant generator but the exponential of any linear map.

III. CUMULANT EQUATION FOR A SPIN BOSON MODEL WITH COMPOSITE INTERACTIONS

From (1) we may decompose the H_I part into the bath operators and the following jump operators:

$$A(\omega_0) = \bar{f}\sigma_-, \quad A(-\omega_0) = f\sigma_+, \quad A(0) = f_3\sigma_z \quad (14)$$

$$M = \begin{pmatrix} -|f|^2\Gamma & -2f_1\xi_z - \text{Im}(\Gamma_z^+) & 2f_2\xi_z + \text{Re}(\Gamma_z^+) \\ -\text{Im}(\Gamma_z^+) + 2f_1\xi_z & -\left(\frac{|f|^2}{2}\Gamma + 2f_3^2\Gamma_{zz} + \text{Re}(f^2\Gamma_{-+})\right) & |f|^2\xi - \text{Im}(f^2\Gamma_{-+}) \\ \text{Re}(\Gamma_z^+) - 2f_2\xi_z & -\left(|f|^2\xi + \text{Im}(f^2\Gamma_{-+})\right) & -\frac{|f|^2}{2}\Gamma - 2f_3^2\Gamma_{zz} + \text{Re}(f^2\Gamma_{-+}) \end{pmatrix} \quad (21)$$

IV. DYNAMICS OF THE SYSTEM WHEN LAMB-SHIFT IS NEGLECTED

In this section, we compare our model which was computed using the cumulant equation with other more established approaches in the literature. This section serves as bench-mark of our Non-Markovian equation in different scenarios. Since Lamb-shift itself is usually neglected

where $f = f_1 - if_2$, then from the linear coupling to the bosonic operators one obtains:

$$\begin{aligned} \Gamma(\omega, \omega', t) &= t^2 \int_0^\infty d\nu e^{i\frac{\omega-\omega'}{2}t} J(\nu) \left[(n_\nu + 1) \text{sinc}\left(\frac{(\omega-\nu)t}{2}\right) \right. \\ &\times \left. \text{sinc}\left(\frac{(\omega'-\nu)t}{2}\right) + n_\nu \text{sinc}\left(\frac{(\omega+\nu)t}{2}\right) \text{sinc}\left(\frac{(\omega'+\nu)t}{2}\right) \right] \quad (15) \end{aligned}$$

$$\begin{aligned} \xi(\omega, \omega', t) &= \frac{t^2}{2\pi} \int_{-\infty}^\infty d\phi \text{sinc}\left(\frac{\omega-\phi}{2}t\right) \text{sinc}\left(\frac{\omega'-\phi}{2}t\right) \\ &\times P.V \int_0^\infty d\nu J(\nu) \left[\frac{n(\nu)+1}{\phi-\nu} + \frac{n(\nu)}{\phi+\nu} \right] \quad (16) \end{aligned}$$

where n_ν is the Bose-Einstein distribution

$$n_\nu = \frac{1}{e^{\beta\nu} - 1} \quad (17)$$

For convenience let us introduce the following notation: from now on the functions dependence on time will not be written explicitly and their frequency dependence will be labeled as subindices, for example $\Gamma_{\omega, \omega'} = \Gamma(\omega, \omega', t)$ we will further simplify the notation by replacing the explicit frequencies as $\omega_0 \rightarrow -, -\omega_0 \rightarrow +, 0 \rightarrow z$, such that $\Gamma(\omega_0, 0, t) = \Gamma_{-z}$, using this we may finally write the cumulant equation evolution for this model as:

$$\rho(t) = \frac{\mathbb{I}}{2} + (e^M - \mathbb{I})M^{-1}\vec{r} \cdot \vec{\sigma} + e^M \frac{\vec{x}}{2} \cdot \vec{\sigma} \quad (18)$$

where

$$\vec{x} = \begin{pmatrix} \langle \sigma_z(0) \rangle \\ \langle \sigma_x(0) \rangle \\ \langle \sigma_y(0) \rangle \end{pmatrix} \quad \vec{r} = \begin{pmatrix} |f|^2 \frac{\Gamma_{++} - \Gamma_{--}}{2} \\ -\text{Im}(\Gamma_z^+) \\ \text{Re}(\Gamma_z^+) \end{pmatrix} \quad (19)$$

$$(20)$$

Where M is given by (21)

in the approaches considered in literature, this benchmark should be relevant. In a later section we will see how the Lamb-shift correction affects the accuracy of the cumulant equation. A similar benchmark can be found in [21] where the focus is on the regime of validity of the several equations studied in that paper, here we focus both on the regime of validity and on which equation is better at which regime, while the conclusions found in that paper are correct here we indicate that there is

more to the story as we see that the cumulant equation or refined weak coupling is typically more faithful to the exact dynamics in its regime of validity. This fact combined with the cumulant equation being a CPTP map make it a good alternative to simulate open quantum systems in the weak coupling regime, specially with respect to the several efforts to make the Bloch-Redfield equation completely positive [22–24]

From this section forward all simulations shown in plots have

$$\rho(0) = \begin{pmatrix} 0.5 & 0.5 \\ 0.5 & 0.5 \end{pmatrix} \quad (22)$$

as the initial state and

$$J(\omega) = \frac{2\lambda\omega\gamma}{\gamma^2 + \omega^2} \quad (23)$$

as the spectral density

A. Pure Dephasing and the conundrum of reproducing exact results at second order

If we want to recover a pure dephasing model, it suffices to set $f = 0$ for which our linear transformation becomes

$$\begin{pmatrix} a' \\ b' \\ c' \end{pmatrix} = \underbrace{\begin{pmatrix} 0 & 0 & 0 \\ 0 & -2f_3^2\Gamma_{zz} & 0 \\ 0 & 0 & -2f_3^2\Gamma_{zz} \end{pmatrix}}_M \begin{pmatrix} a \\ b \\ c \end{pmatrix} \quad (24)$$

In this case, the dynamics are easily solvable as Eq. (A51) becomes

$$\rho(t) = \frac{\mathbb{I}}{2} + \vec{\sigma}^T e^{M t} \vec{a} = \begin{pmatrix} a + \frac{1}{2} & e^{-2f_3^2\Gamma_{zz}}(b - ic) \\ e^{-2f_3^2\Gamma_{zz}}(b + ic) & \frac{1}{2} - a \end{pmatrix} \quad (25)$$

From this, we can see the dynamics doesn't induce any change on the diagonal, namely there are no energy exchanges between the system and environment, the interaction simply kills coherences for this sort of evolution as it is expected. For longer times Γ_{zz} increases with t then the steady state is simply given by

$$\rho_{steady} = \begin{pmatrix} a + \frac{1}{2} & 0 \\ 0 & \frac{1}{2} - a \end{pmatrix} \quad (26)$$

Notice we would have the exact same solution if we had considered Lamb-shift, from Eq. (A1) we can see that Lamb-shift plays no role in this scenario as it is proportional to the identity. As a matter of fact, the cumulant equation for this model is equivalent to the exact

solution. Let us consider the exact solution for a pure dephasing model as described by [25, 26] the coherences decay according to

$$\rho_{12}(t) = e^{-\gamma(t)} \rho_{12}(0) \quad (27)$$

where

$$\gamma(t) = 4 \int_0^\infty d\omega J(\omega) \coth\left(\frac{\beta\omega}{2}\right) \left(\frac{1 - \cos(\omega t)}{\omega^2}\right) \quad (28)$$

For comparison let us quickly rewrite this. Note that $\cos(\omega t) = 1 - 2 \sin\left(\frac{\omega t}{2}\right)^2$ such that we may write:

$$\gamma(t) = 2t^2 \int_0^\infty d\omega J(\omega) \coth\left(\frac{\beta\omega}{2}\right) \text{sinc}\left(\frac{\omega t}{2}\right)^2 \quad (29)$$

While substituting directly in Eq. (15) results in

$$\Gamma_{zz} = t^2 \int_0^\infty d\nu J(\nu) \text{sinc}\left(\frac{\nu t}{2}\right)^2 (2n_\nu + 1) \quad (30)$$

$$\Gamma_{zz} = t^2 \int_0^\infty d\nu J(\nu) \text{sinc}\left(\frac{\nu t}{2}\right)^2 \coth\left(\frac{\beta\nu}{2}\right) \quad (31)$$

By simple comparison we see that $\gamma(t) = 2\Gamma_{zz}$ and that coherences are decaying in the same way, indicating that the cumulant equation is exact for pure dephasing. The cumulant is not the only equation that has this feat the time convolution-less master equation (TCL) at second order (Redfield [27, 28]) is also exact for this model [17] but the commonly used Bloch-Redfield master equation [16, 27, 29] which we compare to cumulant through this paper does not, this example shows a clear, simple scenario where we can see the superiority of the cumulant equation against similar approaches like Bloch-Redfield. On the other hand, it is a map, rather than an integral-differential equation like the TCL beating it in simplicity but still being able to produce exact solutions. This is remarkable given that this is independent of the coupling and it is indeed a conundrum that even for arbitrary strong coupling we are able to produce the exact dynamics with just a second-order expansion.

In Fig. 1 we can see a contour plot that shows the minimum fidelity the BR equation has for a given set of parameters, we can see that the area where it works with high fidelity is rather restricted, which is understandable given that it is only meant to operate in the weak coupling limit, still the cumulant equation which was derived in the weak coupling limit holds, showing a clear advantage to study dephasing scenarios.

In this setting even the simplest equation, namely the Davies-Gorini-Kossakowski-Sudarshan-Lindblad (Davies-GKLS) master equation is in good agreement with the exact solution, the TCL and cumulant equation exhibit an advantage as they match the exact solution whereas Bloch-Redfield does not.

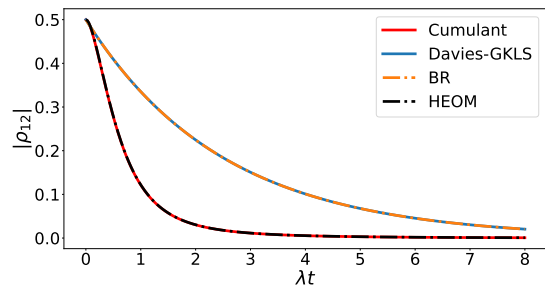

(a) Absolute value of the coherence in pure dephasing evolution

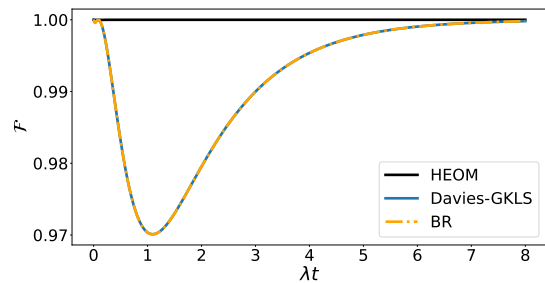

(b) Fidelity to the exact for the different approaches under pure dephasing evolution, cumulant is excluded as it matches the exact solution

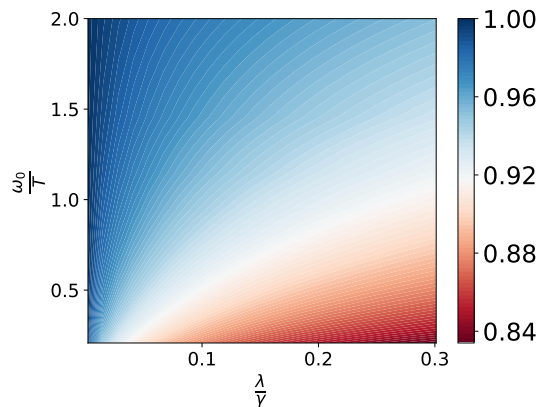

(c) Fidelity of the Davies-GKLS and Bloch-Redfield equation for a wide range of parameters

FIG. 1: In figures (a) and (c) The dynamics for the pure dephasing model are shown, it corresponds to $f_1 = f_2 = 0$ and $f_3 = 1$, for this comparison the parameters for the simulation taken were $\frac{\omega_0}{T} = 4, \frac{\lambda}{\gamma} = \frac{1}{4}, \gamma = 5\omega_0$. We can see HEOM has converged to the analytical exact solution, it should be mentioned that it required $N_k = 8$ matsubara exponents, and 8 ADOS,

Thus the computational effort is significant when compared with the cumulant equation, futhermore at lower temperatures, more exponents may be needed, and the ADOS may not be enough, thus resulting in higher computational effort.

B. The standard Spin Boson Model

The standard spin boson model [12, 27] can be recovered from (1) by making make $f_3 = f_2 = 0$, The linear transformation giving rise to the cumulant equation dynamics is then given by:

$$M = \begin{pmatrix} -\Gamma & 0 & 0 \\ 0 & -\frac{\Gamma}{2} + \text{Re}(\Gamma_{-+}) & -(\text{Im}(\Gamma_{-+}) + \xi) \\ 0 & \xi - \text{Im}(\Gamma_{-+}) & -\frac{\Gamma}{2} - \text{Re}(\Gamma_{-+}) \end{pmatrix} \quad (32)$$

$$\vec{r} = \begin{pmatrix} \frac{\Gamma_{++} - \Gamma_{--}}{2} \\ 0 \\ 0 \end{pmatrix} \quad (33)$$

The evolution of the system is obtained from (18) easily, in particular one remarkable fact is that since the matrix M rank is 2 this allows us to obtain analytical expressions for its exponential easily, providing a way to get analytical answers for the spin boson model out of this Non-Markovian description.

Another advantage of this form of the evolution is that we may separate the asymptotic dynamics from the memory dependent one, as we know that $e^M \rightarrow 0$ as $t \rightarrow \infty$ for this model as the real part of its eigenvalues are always negative

Therefore, if we only aim at knowing the steady state of the system then it suffices to look at the non-vanishing terms of (18) in the long time limit, which results in :

$$\rho_{steady} = -\vec{\sigma} \cdot M^{-1} \vec{r} = \vec{\sigma} \cdot \begin{pmatrix} \frac{\Gamma_{++} - \Gamma_{--}}{2\Gamma} \\ 0 \\ 0 \end{pmatrix} \quad (34)$$

$$= \frac{\Gamma_{++} - \Gamma_{--}}{2\Gamma} \sigma_z. \quad (35)$$

This can obtain analytically in the long time limit, substituting the adequate time dependent coefficients into Eq. (15):

$$\Gamma_{--} + \Gamma_{++} = t^2 \int_0^\infty d\omega J(\omega) \coth\left(\frac{\omega}{2T}\right) \left(\text{sinc}^2\left(\frac{(\omega - \omega_0)t}{2}\right) + \text{sinc}^2\left(\frac{(\omega + \omega_0)t}{2}\right) \right) \quad (36)$$

$$\Gamma_{++} - \Gamma_{--} = t^2 \int_0^\infty d\omega J(\omega) \left(\text{sinc}^2\left(\frac{(\omega - \omega_0)t}{2}\right) - \text{sinc}^2\left(\frac{(\omega + \omega_0)t}{2}\right) \right) \quad (37)$$

Since we only care about the steady state of the system at this point we may take the limit of $t \rightarrow \infty$ which greatly simplifies the analysis as the limit of the time-dependent function as :

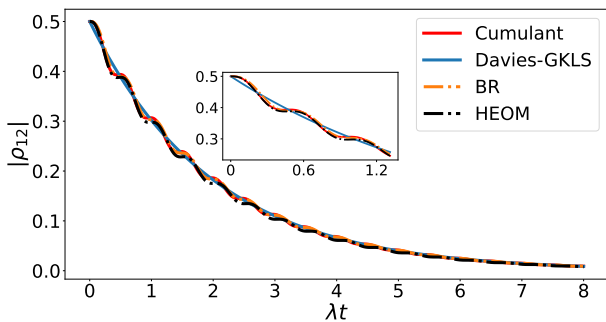

(a) Absolute value of coherence for the different approaches

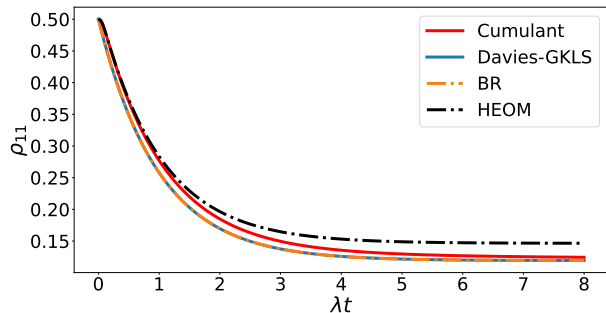

(b) Evolution of the populations for each of the different approaches

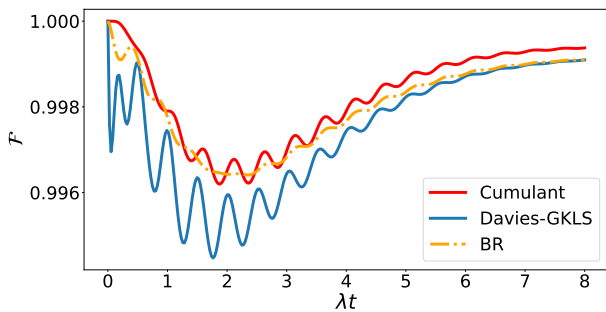

(c) Fidelity with respect to the HEOM method

FIG. 2: The dynamics for the spin boson model are shown, it corresponds to $f_3 = f_2 = 0$ and $f_1 = 1$, for the plots shown $\frac{\omega_0}{T} = 2, \frac{\lambda}{\gamma} = 0.01, \gamma = 5\omega_0$.

$$\lim_{t \rightarrow \infty} t^2 \text{sinc}^2 \left(\frac{(\omega - \omega_0)t}{2} \right) = 2\pi t \delta(\omega - \omega_0) \quad (38)$$

Thus we have

$$\rho_{steady} = -\frac{\Gamma_{--} - \Gamma_{++}}{2\Gamma} \sigma_z \quad (39)$$

$$= \frac{\int_0^\infty d\omega J(\omega) (\delta(\omega - \omega_0) - \delta(\omega + \omega_0))}{2 \int_{-\infty}^\infty d\omega J(\omega) \coth\left(\frac{\omega}{2T}\right) \delta(\omega - \omega_0)} \sigma_z \quad (40)$$

$$= \frac{1}{2} \left(\frac{J(\omega_0) - J(-\omega_0)}{J(\omega_0) \coth\left(\frac{\beta\omega_0}{2}\right)} \right) \sigma_z \quad (41)$$

When the KMS relation is satisfied for a bosonic bath, the spectral density needs to be an odd function, otherwise, KMS is violated, and we may not have a stationary state [30, 31] which explains the apparent need for an odd function in Eq. (39) to obtain the expected result. Assuming KMS then one obtains:

$$\rho_{steady} = \tanh\left(\frac{\beta\omega_0}{2}\right) \sigma_z \quad (42)$$

Thus the steady state is just Gibbs state to bare Hamiltonian which we know to be the correct steady state of the system up to second order [1, 8] as off-diagonal corrections vanish for orthogonal couplings in the spin boson model. Regarding the true evolution, we know that indeed there are no steady state coherences [1, 8, 32] in this scenario, but there are corrections to populations that are a consequence of $\mathcal{O}(\lambda^4)$ effects, so we see that in this case the cumulant equation does not reproduce properly the properties of the stationary state. Let us however remark here that corrections for populations can be derived from so called quasi-steady state computed perturbatively from cumulant equation (see Ref. [1]) and that other master equations (Davies-GKLS and Bloch-Redfield) fail in the same way. As we see in Fig. 2 initially the populations are better described by cumulant than the other master equations, which can be considered as a trace of the mentioned corrections of [1].

Since in our linear map the dynamics of populations and the dynamics of coherences are decoupled this allows one to exponentiate the matrix from Eq. (32) without making any sort of assumption, which in turn allows us to write the evolution of the population and coherences compactly, since we are neglecting the Non-Markovian Lambshift in this section, the analytical solution becomes even simpler, we obtain:

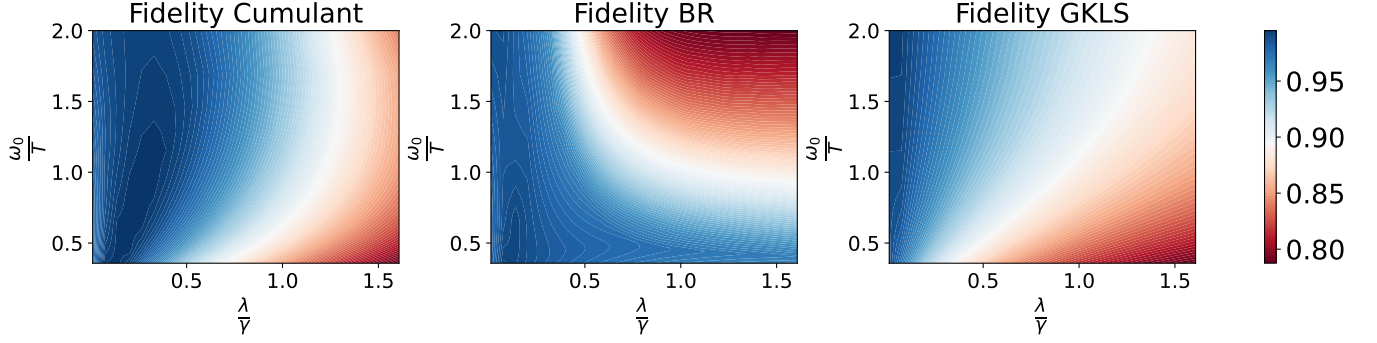

(a) Minimum fidelity of all master equations against HEOM

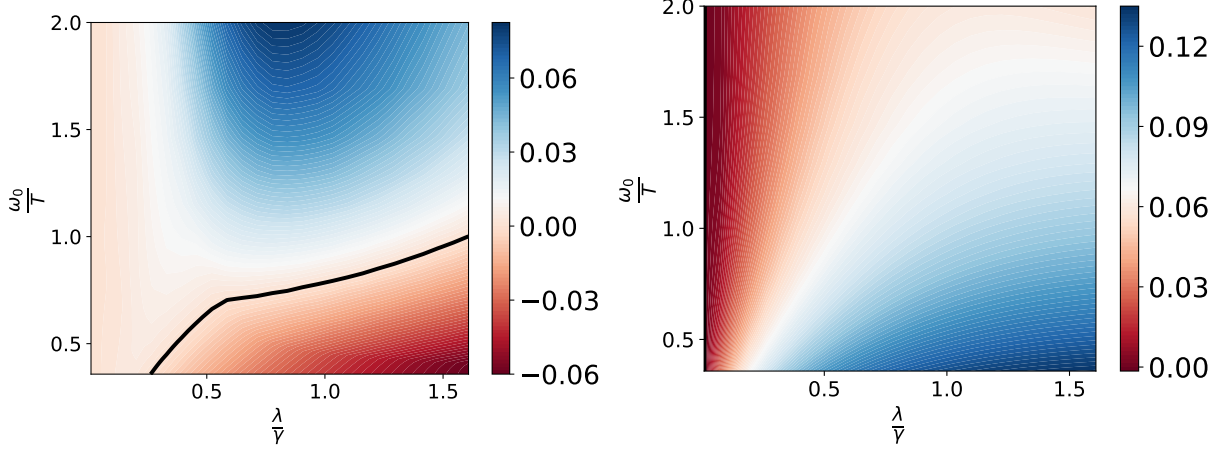

(b) Difference in minimum fidelity between the cumulant equation and the Bloch Redfield equation, the black line divides the region where the difference is positive (cumulant has higher minimum fidelity) and where it is negative

(c) Difference in minimum fidelity between the cumulant equation and the Davies-GKLS equation, the cumulant equation is a better description for all chosen parameters, which can be seen because the difference is always positive

FIG. 3: These plots show the minimum fidelity between the numerically exact solution (HEOM) and the different master equations. Bare in mind that the black line that divides the regime where cumulant is better than Bloch-Redfield, may change shape for different values of γ with respect to ω_0 . here we have chosen $\gamma = \omega_0$ however in general we see that the cumulant equation is a better description at small $\frac{\lambda}{\gamma}$ and low temperature, while Bloch Redfield is better in the opposite regime

$$\langle \sigma_z(t) \rangle = e^{-\Gamma(t)} \langle \sigma_z(0) \rangle + \frac{(e^{-\Gamma(t)} - 1)(\Gamma_{++}(t) - \Gamma_{--}(t))}{\Gamma(t)} \quad (43)$$

$$\langle \sigma_+(t) \rangle = \frac{e^{-|\Gamma_{-+}| - \frac{\Gamma}{2}} (\Gamma_{-+} \langle \sigma_-(0) \rangle) (e^{2|\Gamma_{-+}|} - 1) + \langle \sigma_+(0) \rangle (e^{2|\Gamma_{-+}|} + 1) |\Gamma_{-+}|}{2|\Gamma_{-+}|} \quad (44)$$

$$\langle \sigma_-(t) \rangle = \frac{e^{-|\Gamma_{-+}| - \frac{\Gamma}{2}} (\Gamma_{+-} \langle \sigma_+(0) \rangle) (e^{2|\Gamma_{-+}|} - 1) + \langle \sigma_-(0) \rangle (e^{2|\Gamma_{-+}|} + 1) |\Gamma_{-+}|}{2|\Gamma_{-+}|} \quad (45)$$

In terms of the dynamics one can see that the cumulant equation is the most favorable approximate descrip-

tion for the parameters chosen in Fig. 2. As we are in the weak coupling regime, we can see a pretty good agreement with the exact dynamics even for the simplest equation, namely, the Davies-GKLS. Still the cumulant equation is a better description in early and long times when compared to the other master equations presented here, it is also as good as Bloch-Redfield in intermediate times, this indicates higher orders of the cumulant equation might be worth pursuing in the same way the TCL equation is often written down.

C. The Composite interaction case

In the previous two sections we recovered models for which the cumulant equation has been studied in the literature, the difference so far has been on how to solve the cumulant dynamics [12] and the comparison to other master equations, however we believe our way of solving might prove useful for analytical calculations, specially when approximation of the integrals will be used in the same spirit as in [14, 33, 34].

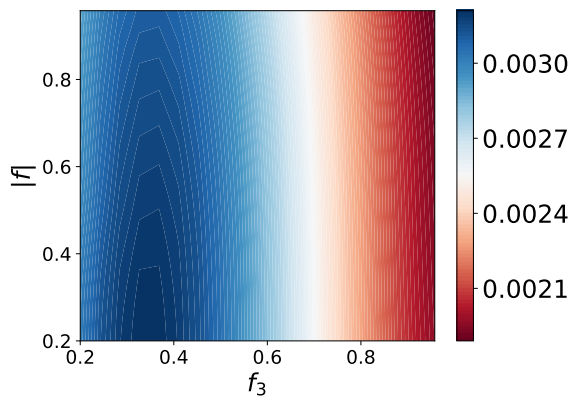

(a) Cumulant vs Davies-GKLS

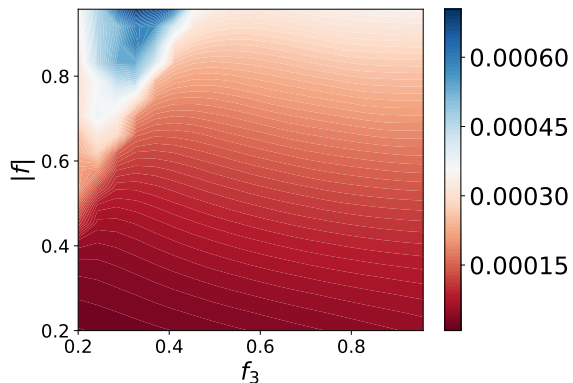

(b) Cumulant vs Bloch-Redfield

FIG. 4: These plots show the different in minimum fidelity between the standard master equations and the cumulant equation, for the simulations we fixed $\frac{\omega_0}{T} = 2$, $\frac{\lambda}{\gamma} = 0.01$

A first attempt in this direction was put forward in [14], our results are now bench-marked with respect to other approaches, showing agreement and even advantage. In this section we extend these models by including additional couplings, which is sometimes called the Non-equilibrium spin-Boson model [35], see appendix B to see how Hamiltonian (1) is related to this model. In the case of composite interactions the matrix is rank 3, which makes analytical expressions complicated as they depend on a cubic root, and therefore it's hard to get Eq. (18) in a compact form unless approximations are done on the integrals. The result of the dynamics can be observed in the Fig. 5.

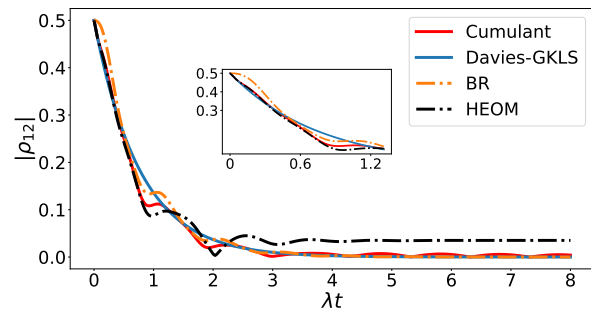

(a) Absolute value of coherence for the different approaches

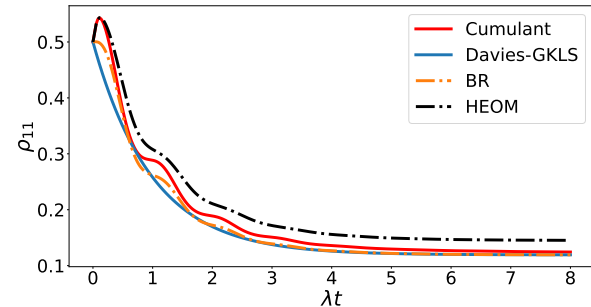

(b) Evolution of populations for the different approaches considered

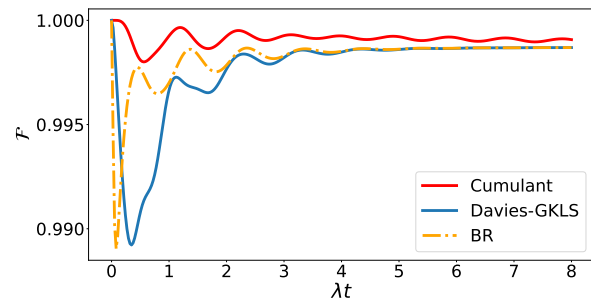

(c) Fidelity with respect to HEOM for each of the methods considered

FIG. 5: The dynamics for the spin boson model are shown, it corresponds to $f_2 = 0$ and $f_3 = f_1 = 1$, for the plots shown $\frac{\omega_0}{T} = 2$, $\frac{\lambda}{\gamma} = 0.01$.

We can see that in this case the cumulant equation has an advantage over the more standard Bloch-Redfield equation while the advantage is small. The fact that the cumulant equation can reproduce better the early time populations is the main source of its advantage with respect to the Bloch-Redfield equation. While it loses this advantage in time, as it is closer in populations while it slowly goes to the bare Gibbs state it has a better fidelity until reaching the steady state. Notice that small oscillations in coherence remain in the cumulant equation

while the other master equations have already reached a fixed value. This is due to the slow decay of the cumulant equation to the Davies-GKLS steady state, as we have mentioned this gives a reminiscence of the steady state coherences as they are long lived.

One may wonder if the parameters chosen above namely equal $f_1 = f_3$ played a role in the superiority of the cumulant equation, Fig. 4 shows that this is not the case by showing the difference in minimum fidelities over a range of different $|f|$ and f_3

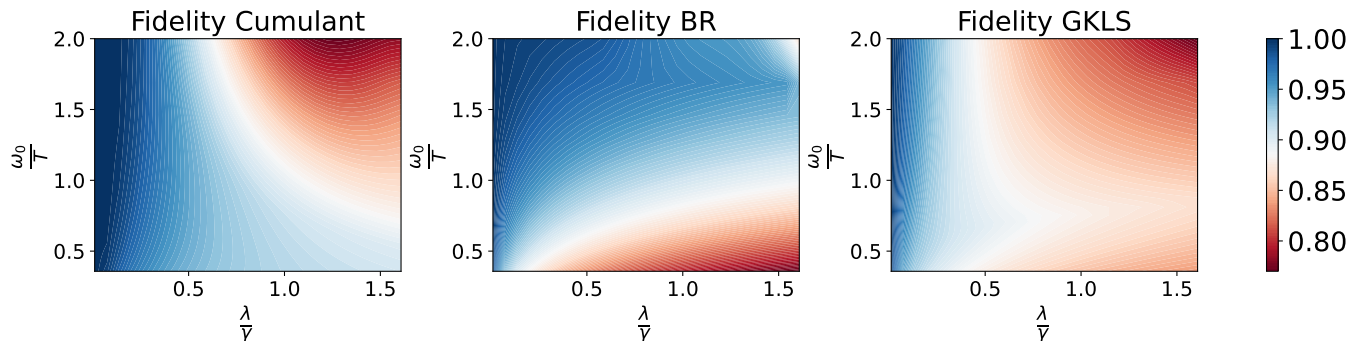

(a) Minimum fidelity of all master equations against HEOM

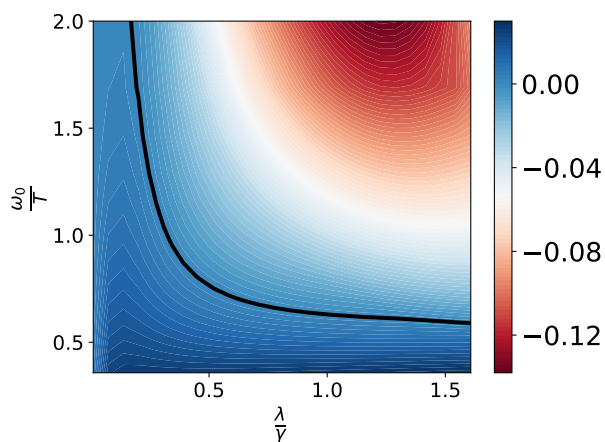

(b) Difference in minimum fidelity between the cumulant equation and the Bloch Redfield equation, the black line divides the region where the difference is positive (cumulant has higher minimum fidelity) and where it is negative

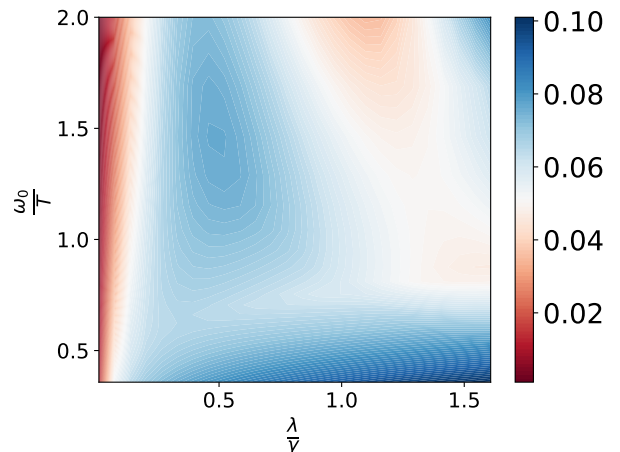

(c) Difference in minimum fidelity between the cumulant equation and the Davies-GKLS equation, the cumulant equation is a better description for all chosen parameters, which can be seen because the difference is always positive

FIG. 6: These plots show the minimum fidelity between the numerically exact solution (HEOM) and the different master equations. Bare in mind that the black line that divides the regime where cumulant is better than Bloch-Redfield, may change shape for different values of γ with respect to ω_0 , however in general we see that the cumulant equation is a better description at small $\frac{\lambda}{\gamma}$ and low temperature, while Bloch-Redfield is better in the opposite regime, bare in mind that master equations are not supposed to be used for such strong couplings, so the cumulant equation or refined weak coupling still shows an advantage over the region of interest

In this section we observed that the Bloch-Redfield equation regime of validity seems to be larger than that of the cumulant equation/refined weak coupling as mentioned in [21], bare in mind that the cumulant equation is a more faithful description when $\frac{\lambda}{\gamma} \ll 1$ which corresponds to the weak coupling regime where master equations are valid descriptions.

V. THE EFFECT ON LAMB-SHIFT ON THE CUMULANT EQUATION

Most work on open quantum systems that has been done with master equations neglects Lamb-shift corrections [25, 31, 36–39]. One of the main reasons people give for neglecting it, is that it is usually small (or that its effect is small which follows from this). However, this does not make sense as this is a cut-off dependent quantity and might diverge in general. Another, stronger argument is that if the shift occurs in the Hamiltonian part it must also occur in the dissipative part, otherwise there is some kind of inconsistency in the equation. People who advocate for the latter argument say that one should take the physical (already dressed/Lamb-shifted) Hamiltonian and derive the master equation in its interaction picture where no Lamb-shift exists, this would amount to having a master equation where Lamb-shift is neglected, however its interpretation is different, for a more in-depth discussion see [32]. This argument is at least solid and justifies neglecting Lamb-shift when it commuted with the original system Hamiltonian or when it is time independent as it is a constant shift so the rotation maps a time independent problem to a time independent problem. In the opposite case such a rotation would map a time independent problem into a time dependent one, so taking a time independent Hamiltonian in this renormalized picture does not make sense or at the very least needs further justification.

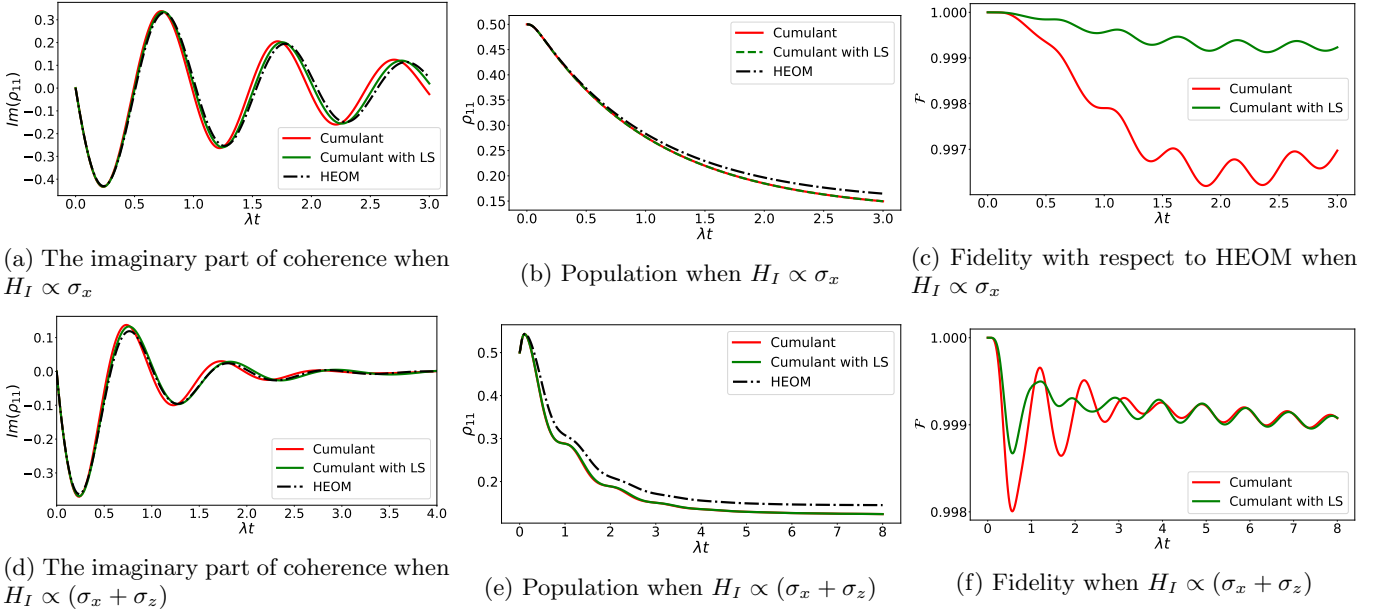

FIG. 7: The dynamics for the spin boson model are shown, it corresponds to $f_3 = f_2 = 0$ and $f_1 = 1$, for the plots shown $\frac{\omega_0}{T} = 2, \frac{\lambda}{\gamma} = 0.01$ and $\gamma = 5\omega_0$.

While Lamb shift can always be seen as a constant drift in the case for Markovian master equations it may not always be true when dealing with Non-Markovian master equations, as it may not always commute with the Hamiltonian of the system. In particular, for this simple model it is not the case as was shown in [1, 6]. This happens when we have composite interactions and it may be the reason master for which equations show the so-called steady state coherences. The fact that the the numerically exact solution (HEOM) exhibiths such a steady state coherence may point to the direction that Lamb-shift does indeed make the master equation more faithful and therefore one should indeed shift.

When it comes to the cumulant equation Lamb-shift, as far as we are aware of its effect on dynamics has not been studied elsewhere (in [12] Lamb-shift is calculated but its effects on dynamics are not observed or discussed). Here we see, that it may be beneficial to use the time dependent Lamb-shift as one gets a higher fidelity at the expense of more computation time. However, we may notice that the main effect of the Lamb-shift is to have a better description

of the coherences, as the Lamb-shift correction makes the coherence be in sync with the numerically exact solution. Its effects on populations is negligible though, so when looking at longer time scales using the Lamb-shift correction may not be worth it, as the cumulant equation will slowly converge to the steady state solution of the Davies-GKLS equation. On short and intermediate time scales we can see an improvement by using the Lamb-shift correction on average, however at certain times our fidelity is slightly reduced due to amplitude mismatch in some cases, as it can be seen from the Fig. 7d. The findings of this paper seem to indicate that Lamb-shift is indeed beneficial to the descriptions of dynamics, however the improvement it obtains for the system is small, it remains an open question whether it can have a big impact on other systems.

VI. CONCLUSIONS

We have revisited the study of the spin boson model in the cumulant/refined weak coupling approach and proposed an alternative approach to solve it by using the fact that the superoperator acts as a linear map. This allows us to come up with a simple analytical answer when contrasted with the previous studies in the literature. We have also extended the literature by studying the so called non-equilibrium spin boson model, and shown that in the weak coupling regime the cumulant equation corresponds better to the true dynamics than other popular approaches such as the Bloch-Redfield equation, showing that the cumulant equation is a good candidate to study dynamics in this regime. This regime is the most important one for this model as it corresponds to a charge qubit (see Appendix B).

One big part of the advantage of the cumulant equation is that it picks up a correction to the diagonal of the density matrix in finite time which slowly vanishes. Therefore it is overall quite good for a pretty long time.

On the other hand, cumulant equation exhibit slowly dying oscillations of coherences. In [6, 7] such oscillations were also observed under Bloch-Redfield master equation, yet they were not dying. They looked like steady ones, but this was the effect of second order expansion. For longer times this is not anymore valid, and the oscillations have been also slowly dying. It was argued in [7] that the presence of these is due to violation of complete positivity. However we now see that the completely positive cumulant equation also exhibit such oscillations, and therefore we believe that it may be instead a feature of the master equations based on Born approximation. We thus believe that higher orders of the cumulant expansion might cure this.

Overall, the cumulant equation provides a useful tool for the study of open systems in the weak coupling regime, especially when time dynamics rather than steady state is considered. Our form of its solution allows one to separate the transient dynamics from the steady state dynamics in a convenient fashion, that may prove useful in the study of quantum heat engines.

ACKNOWLEDGMENTS

We thank Luis Cort-Barrada, Marek Winczewski, Neill Lambert and Paul Menczel for extensive discussions and valuable suggestions. This work was supported by the International Research Agendas Programme (IRAP) of the Foundation for Polish Science (FNP), with structural funds from the European Union (EU). GS acknowledges the support by the Polish National Science Centre grant OPUS-21 (No: 2021/41/B/ST2/03207). MH is supported by the QuantERA II Programme (No 2021/03/Y/ST2/00178, acronym ExTRaQT) that has received funding from the European Union's Horizon 2020.

Appendix A: Derivation of The cumulant equation for the non equilibrium spin boson model

Let us first find the Lamb-shift which is given by:

$$\Lambda(t) = \sum_{\omega, \omega'} \xi(\omega, \omega', t) A^\dagger(\omega) A(\omega')$$

After expanding the sum this becomes

$$\Lambda(t) = \frac{|f|^2}{2} (\xi_{++} + \xi_{--}) + \frac{|f|^2}{2} (\xi_{++} - \xi_{--}) \sigma_z + \bar{f} f_3 (\xi_{-z} - \xi_{z+}) \sigma_- + f f_3 (\xi_{z-} - \xi_{+z}) \sigma_+ + f_3^2 \xi_{zz} \quad (\text{A1})$$

As anything commutes with the identity one may drop that term, as well as rewrite this in terms of σ_x, σ_y , but first:

$$\xi(\omega, \omega', t) = \frac{t^2}{4\pi} \int_{-\infty}^{\infty} d\phi \operatorname{sinc}\left(\frac{\omega - \phi}{2}t\right) \operatorname{sinc}\left(\frac{\omega' - \phi}{2}t\right) P.V \int_0^{\infty} d\nu \left[\frac{\gamma(\nu)}{\phi - \nu} + \frac{\gamma(-\nu)}{\phi + \nu} \right] \quad (\text{A2})$$

From there we can see that the terms where one omega is zero are the same, namely $\xi(\omega, 0, t) = \xi(0, \omega', t)$ using that:

$$\Lambda(t) = \frac{|f|^2}{2} (\xi_{++} - \xi_{--}) \sigma_z + \bar{f} f_3 (\xi_{-z} - \xi_{z+}) \sigma_- + f f_3 (\xi_{z-} - \xi_{+z}) \sigma_+ \quad (\text{A3})$$

$$= \frac{|f|^2}{2} (\xi_{++} - \xi_{--}) \sigma_z + f_3 (\xi_{z-} - \xi_{z+}) (f_1 \sigma_x + f_2 \sigma_y) \quad (\text{A4})$$

Now we define:

$$R = \sum_{\omega, \omega'} R_{\omega, \omega'} \quad (\text{A5})$$

$$R_{\omega, \omega'} = \Gamma(\omega, \omega', t) \left(A(\omega') \cdot A^\dagger(\omega) - \frac{\{A^\dagger(\omega) A(\omega'), \cdot\}}{2} \right) \quad (\text{A6})$$

we will now use sub-indices to refer to omegas $- = \omega, + = -\omega, z = 0$ using that notation we may write [40]:

$$\mathcal{Z}[\rho] = -i \left(\frac{|f|^2}{2} (\xi_{--} - \xi_{++}) [\sigma_z, \rho] + f_3 (\xi_{z+} - \xi_{z-}) (f_1 [\sigma_x, \rho] + f_2 [\sigma_y, \rho]) \right) + R[\rho] \quad (\text{A7})$$

However we may write a qubit density matrix as:

$$\rho = \frac{1}{2} + b\sigma_x + c\sigma_y + d\sigma_z$$

Since that map acts linearly one may find it on each operator separately, to this quickly let us compute the action of $R_{\omega, \omega'}$ on each operator:

- The identity:

$$\begin{aligned} R_{++}[I] &= -\Gamma_{--} |f|^2 \sigma_z & R_{+-}[I] &= 0 & R_{z+}[I] &= 2\Gamma_{z-} \bar{f} f_3 \sigma_- \\ R_{-+}[I] &= 0 & R_{--}[I] &= \Gamma_{++} |f|^2 \sigma_z & R_{z-}[I] &= -2\Gamma_{z+} f f_3 \sigma_+ \\ R_{+z}[I] &= 2\Gamma_{-z} f_3 f \sigma_+ & R_{-z}[I] &= -2\Gamma_{+z} f_3 \bar{f} \sigma_- & R_{zz}[I] &= 0 \end{aligned} \quad (\text{A8})$$

- σ_z

$$\begin{aligned} R_{++}[\sigma_z] &= -\Gamma_{--} |f|^2 \sigma_z & R_{+-}[\sigma_z] &= 0 & R_{z+}[\sigma_z] &= \Gamma_{z-} \bar{f} f_3 \sigma_- \\ R_{-+}[\sigma_z] &= 0 & R_{--}[\sigma_z] &= -\Gamma_{++} |f|^2 \sigma_z & R_{z-}[\sigma_z] &= \Gamma_{z+} f f_3 \sigma_+ \\ R_{+z}[\sigma_z] &= \Gamma_{-z} f f_3 \sigma_+ & R_{-z}[\sigma_z] &= \Gamma_{+z} f f_3 \sigma_- & R_{zz}[\sigma_z] &= 0 \end{aligned} \quad (\text{A9})$$

- σ_x

$$\begin{aligned} R_{++}[\sigma_x] &= -\Gamma_{--} |f|^2 \frac{\sigma_x}{2} & R_{+-}[\sigma_x] &= \Gamma_{+-} \bar{f}^2 \sigma_- & R_{z+}[\sigma_x] &= \Gamma_{z-} \bar{f} f_3 \frac{\sigma_x}{2} \\ R_{-+}[\sigma_x] &= \Gamma_{-+} f^2 \sigma_+ & R_{--}[\sigma_x] &= -\Gamma_{++} |f|^2 \frac{\sigma_x}{2} & R_{z-}[\sigma_x] &= \Gamma_{z+} f f_3 \frac{\sigma_x}{2} \\ R_{+z}[\sigma_x] &= \Gamma_{-z} f_3 f \frac{\sigma_x}{2} & R_{-z}[\sigma_x] &= \Gamma_{+z} f_3 f \frac{\sigma_x}{2} & R_{zz}[\sigma_x] &= -\Gamma_{zz} 2f_3^2 \sigma_x \end{aligned} \quad (\text{A10})$$

- σ_y

$$\begin{aligned} R_{++}[\sigma_y] &= -|f|^2 \frac{\sigma_y}{2} & R_{+-}[\sigma_y] &= -i \bar{f}^2 \sigma_- & R_{z+}[\sigma_y] &= \bar{f} f_3 \frac{-i\sigma_x}{2} \\ R_{-+}[\sigma_y] &= i f^2 \sigma_+ & R_{--}[\sigma_y] &= -|f|^2 \frac{\sigma_y}{2} & R_{z-}[\sigma_y] &= \bar{f} f_3 \left(\frac{-i\sigma_x}{2} \right) \\ R_{+z}[\sigma_y] &= f_3 f \left(\frac{i\sigma_x}{2} \right) & R_{-z}[\sigma_y] &= f_3 f \left(\frac{i\sigma_x}{2} \right) & R_{zz}[\sigma_y] &= -2f_3^2 \sigma_y \end{aligned} \quad (\text{A11})$$

Using those we can compute the action of R, so we finally have:

$$R[I] = |f|^2 (\Gamma_{++} - \Gamma_{--}) \sigma_z + (\Gamma_{-z} f f_3 - \Gamma_{+z} f_3 \bar{f} + \Gamma_{z-} f_3 \bar{f} - \Gamma_{z+} f f_3) \sigma_x + i (\Gamma_{-z} f f_3 + \Gamma_{+z} f_3 \bar{f} - \Gamma_{z-} f_3 \bar{f} - \Gamma_{z+} f f_3) \sigma_y \quad (\text{A12})$$

$$R[\sigma_z] = -|f|^2 (\Gamma_{--} + \Gamma_{++}) \sigma_z + i f_3 \left(\frac{\Gamma_{-z} f}{2} - \frac{\Gamma_{+z} \bar{f}}{2} - \frac{\Gamma_{z-} \bar{f}}{2} + \frac{\Gamma_{z+} f}{2} \right) \sigma_y + f_3 \left(\frac{\Gamma_{-z} f}{2} + \frac{\Gamma_{+z} \bar{f}}{2} + \frac{\Gamma_{z-} \bar{f}}{2} + \frac{\Gamma_{z+} f}{2} \right) \sigma_x \quad (\text{A13})$$

$$R[\sigma_x] = f_3 \left(\frac{\Gamma_{-z} f}{2} + \frac{\Gamma_{+z} \bar{f}}{2} + \frac{\Gamma_{z-} \bar{f}}{2} + \frac{\Gamma_{z+} f}{2} \right) \sigma_z + i \left(\frac{\Gamma_{-+} f^2}{2} - \frac{\Gamma_{+-} \bar{f}^2}{2} \right) \sigma_y \quad (\text{A14})$$

$$+ \left(\frac{\Gamma_{-+} f^2}{2} + \frac{\Gamma_{+-} \bar{f}^2}{2} - 2\Gamma_{zz} f_3^2 - \left(\frac{\Gamma_{--}}{2} + \frac{\Gamma_{++}}{2} \right) |f|^2 \right) \sigma_x \quad (\text{A15})$$

$$R[\sigma_y] = \left(-\frac{\Gamma_{-+} f^2}{2} - \frac{\Gamma_{+-} \bar{f}^2}{2} - 2\Gamma_{zz} f_3^2 + \left(-\frac{\Gamma_{--}}{2} - \frac{\Gamma_{++}}{2} \right) |f|^2 \right) \sigma_y \quad (\text{A16})$$

$$+ i \left(f_3 \left(\frac{\Gamma_{-z} f}{2} - \frac{\Gamma_{+z} \bar{f}}{2} - \frac{\Gamma_{z-} \bar{f}}{2} + \frac{\Gamma_{z+} f}{2} \right) \sigma_z + \left(\frac{\Gamma_{-+} f^2}{2} - \frac{\Gamma_{+-} \bar{f}^2}{2} \right) \sigma_x \right) \quad (\text{A17})$$

However, we can see from the definition that $\Gamma_{zw} = \overline{\Gamma_{wz}}$ so the expressions can be written as:

$$R[I] = |f|^2 (\Gamma_{++} - \Gamma_{--}) \sigma_z + 2 \operatorname{Re} (f_3 f (\Gamma_{-z} - \Gamma_{z+})) \sigma_x - 2 \operatorname{Im} (f_3 f (\Gamma_{-z} - \Gamma_{z+})) \sigma_y \quad (\text{A18})$$

$$R[\sigma_z] = -|f|^2 (\Gamma_{--} + \Gamma_{++}) \sigma_z - \operatorname{Im} (f_3 f (\Gamma_{-z} + \Gamma_{z+})) \sigma_y + \operatorname{Re} (f_3 f (\Gamma_{-z} + \Gamma_{z+})) \sigma_x \quad (\text{A19})$$

$$R[\sigma_x] = \left(\operatorname{Re} (\Gamma_{-+} f^2) - 2\Gamma_{zz} f_3^2 - \left(\frac{\Gamma_{--}}{2} + \frac{\Gamma_{++}}{2} \right) |f|^2 \right) \sigma_x + \operatorname{Re} (f_3 f (\Gamma_{-z} + \Gamma_{z+})) \sigma_z - \operatorname{Im} (\Gamma_{-+} f^2) \sigma_y \quad (\text{A20})$$

$$R[\sigma_y] = - \left(\operatorname{Re} (\Gamma_{-+} f^2) + 2\Gamma_{zz} f_3^2 + \left(\frac{\Gamma_{--}}{2} + \frac{\Gamma_{++}}{2} \right) |f|^2 \right) \sigma_y + \operatorname{Im} (f_3 f (\Gamma_{-z} + \Gamma_{z+})) \sigma_z - \operatorname{Im} (\Gamma_{-+} f^2) \sigma_x \quad (\text{A21})$$

Using this one may finally obtain the action of the super operator on each of the Pauli matrices. Since everything commutes with the identity there is no contribution from the Hamiltonian part then:

$$\mathcal{Z}[I] = |f|^2 (\Gamma_{++} - \Gamma_{--}) \sigma_z + 2 \operatorname{Re} (f_3 f (\Gamma_{-z} - \Gamma_{z+})) \sigma_x - 2 \operatorname{Im} (f_3 f (\Gamma_{-z} - \Gamma_{z+})) \sigma_y \quad (\text{A22})$$

For the Pauli matrices we have non-zero Hamiltonian contribution given by:

$$[\Lambda(t), \sigma_i] = \left(\frac{|f|^2}{2} (\xi_{++} - \xi_{--}) [\sigma_z, \sigma_i] + f_3 (\xi_{z-} - \xi_{z+}) (f_1 [\sigma_x, \sigma_i] + f_2 [\sigma_y, \sigma_i]) \right) \quad (\text{A23})$$

where σ_i can be any of the Pauli matrices, using the equation above one finds for σ_x :

$$[\Lambda(t), \sigma_x] = \left(\frac{|f|^2}{2} (\xi_{++} - \xi_{--}) (2i\sigma_y) + f_2 f_3 (\xi_{z-} - \xi_{z+}) (-2i\sigma_z) \right) \quad (\text{A24})$$

$$= i \left(|f|^2 (\xi_{++} - \xi_{--}) \sigma_y - 2f_2 f_3 (\xi_{z-} - \xi_{z+}) \sigma_z \right) \quad (\text{A25})$$

for σ_y

$$[\Lambda(t), \sigma_y] = \left(\frac{|f|^2}{2} (\xi_{++} - \xi_{--}) (-2i\sigma_x) + f_3(\xi_{z-} - \xi_{z+}) f_1(2i\sigma_z) \right) \quad (\text{A26})$$

$$= i \left(2f_1 f_3 (\xi_{z-} - \xi_{z+}) \sigma_z - |f|^2 (\xi_{++} - \xi_{--}) \sigma_x \right) \quad (\text{A27})$$

and finally for σ_z :

$$[\Lambda(t), \sigma_z] = f_3(\xi_{z-} - \xi_{z+})(f_1(-2i\sigma_y) + f_2(2i\sigma_x)) \quad (\text{A28})$$

$$= 2if_3(\xi_{z-} - \xi_{z+})(f_2\sigma_x - f_1\sigma_y) \quad (\text{A29})$$

Remember that

$$\mathcal{Z}[x] = -i[\Lambda(t), x] + R(x) \quad (\text{A30})$$

With all of the equations above we may now write the action of the super operator on each of the Pauli matrices, we start with σ_z :

$$\mathcal{Z}[\sigma_z] = 2f_3(\xi_{z-} - \xi_{z+})(f_2\sigma_x - f_1\sigma_y) - |f|^2(\Gamma_{--} + \Gamma_{++})\sigma_z - \text{Im}(ff_3(\Gamma_{-z} + \Gamma_{z+}))\sigma_y + \text{Re}(f_3f(\Gamma_{z-} + \Gamma_{z+}))\sigma_x \quad (\text{A31})$$

Then for σ_x :

$$\begin{aligned} \mathcal{Z}[\sigma_x] &= |f|^2(\xi_{++} - \xi_{--})\sigma_y - 2f_2f_3(\xi_{z-} - \xi_{z+})\sigma_z - \text{Im}(f^2\Gamma_{-+})\sigma_y + \text{Re}(ff_3(\Gamma_{-z} + \Gamma_{z-}))\sigma_z \\ &\quad - \left(\frac{|f|^2}{2}(\Gamma_{--} + \Gamma_{++}) + 2f_3^2\Gamma_{zz} - \text{Re}(f^2\Gamma_{-+}) \right) \sigma_x \end{aligned} \quad (\text{A32})$$

Finally for σ_y

$$\begin{aligned} \mathcal{Z}[\sigma_y] &= -|f|^2(\xi_{++} - \xi_{--})\sigma_x + 2f_3f_1(\xi_{z-} - \xi_{z+})\sigma_z - \left(\frac{|f|^2}{2}(\Gamma_{--} + \Gamma_{++}) + 2f_3^2\Gamma_{zz} + \text{Re}(f^2\Gamma_{-+}) \right) \sigma_y \\ &\quad - \text{Im}(f^2\Gamma_{-+})\sigma_x - \text{Im}(ff_3(\Gamma_{z-} + \Gamma_{z+}))\sigma_z \end{aligned} \quad (\text{A33})$$

To find the evolution of the density matrix, one can then use the fact that any qubit density matrix can be written as

$$\rho = \frac{\mathcal{I} + \vec{r} \cdot \vec{\sigma}}{2} = \frac{\mathcal{I}}{2} + c\sigma_x + b\sigma_y + a\sigma_z \quad (\text{A34})$$

Before moving forward let us introduce the following notation:

$$\xi = \xi_{++} - \xi_{--} \quad (\text{A35})$$

$$\Gamma_z^- = f_3f(\Gamma_{-z} - \Gamma_{z+}) \quad (\text{A36})$$

$$\Gamma_z^+ = f_3f(\Gamma_{z-} + \Gamma_{z+}) \quad (\text{A37})$$

$$\Gamma = \Gamma_{--} + \Gamma_{++} \quad (\text{A38})$$

$$\xi_z = f_3(\xi_{z+} - \xi_{z-}) \quad (\text{A39})$$

Using the previous results one finds that, and the notation defined above one obtains:

$$\begin{aligned}
\mathcal{Z}[\rho] &= \mathcal{Z} \left[\frac{\mathcal{I}}{2} + a\sigma_z + b\sigma_x + c\sigma_y \right] = \frac{\mathcal{Z}[\mathcal{I}]}{2} + a\mathcal{Z}[\sigma_z] + b\mathcal{Z}[\sigma_x] + c\mathcal{Z}[\sigma_y] \quad (\text{A40}) \\
&= \frac{I}{2} \left(|f|^2 (\Gamma_{++} - \Gamma_{--}) \sigma_z + 2 \operatorname{Re}(\Gamma_z^-) \sigma_x - 2 \operatorname{Im}(\Gamma_z^-) \sigma_y \right) \\
&\quad + a \left(-|f|^2 \Gamma \sigma_z + (\operatorname{Re}(\Gamma_z^+) - 2f_2 \xi_z) \sigma_x - (\operatorname{Im}(\Gamma_z^+) - 2f_1 \xi_z) \sigma_y \right) \\
&\quad - c \left(\left(\frac{|f|}{2} \Gamma + 2f_3^2 \Gamma_{zz} + \operatorname{Re}(f^2 \Gamma_{-+}) \right) \sigma_y + \operatorname{Im}(f^2 \Gamma_{-+}) \sigma_x + \operatorname{Im}(\Gamma_z^+) \sigma_z + |f|^2 \xi \sigma_x + 2f_1 \xi_z \sigma_z \right) \\
&\quad + b \left(|f|^2 \xi \sigma_y + 2f_2 \xi_z \sigma_z + \operatorname{Re}(\Gamma_z^+) \sigma_z - \operatorname{Im}(f^2 \Gamma_{-+}) \sigma_y - \left(\frac{|f|^2}{2} \Gamma + 2f_3^2 \Gamma_{zz} - \operatorname{Re}(f^2 \Gamma_{-+}) \right) \sigma_x \right) \quad (\text{A41})
\end{aligned}$$

One then collects terms proportional to each of the Pauli matrices so that one has:

$$\begin{aligned}
\mathcal{Z}[\rho] &= \left(\frac{|f|^2 (\Gamma_{++} - \Gamma_{--})}{2} - a|f|^2 \Gamma - c(\operatorname{Im}(\Gamma_z^+) + 2f_1 \xi_z) + b(2f_2 \xi_z + \operatorname{Re}(\Gamma_z^+)) \right) \sigma_z \\
&\quad + \left(-\operatorname{Im}(\Gamma_z^-) + a(2f_1 \xi_z - \operatorname{Im}(\Gamma_z^+)) - b(\operatorname{Im}(f^2 \Gamma_{-+}) - |f|^2 \xi) - c \left(\frac{|f|^2}{2} \Gamma + 2f_3^2 \Gamma_{zz} + \operatorname{Re}(f^2 \Gamma_{-+}) \right) \right) \sigma_y \\
&\quad + \left(\operatorname{Re}(\Gamma_z^+) - c(|f|^2 \xi + \operatorname{Im}(f^2 \Gamma_{-+})) + a(\operatorname{Re}(\Gamma_z^+) - 2\xi_z f_2) - b \left(\frac{|f|^2}{2} \Gamma + 2f_3^2 \Gamma_{zz} - \operatorname{Re}(f^2 \Gamma_{-+}) \right) \right) \sigma_x \quad (\text{A42})
\end{aligned}$$

This may be written as a linear transformation of the coefficients:

$$\begin{aligned}
\begin{pmatrix} a' \\ b' \\ c' \end{pmatrix} &= \underbrace{\begin{pmatrix} -|f|^2 \Gamma & 2f_2 \xi_z + \operatorname{Re}(\Gamma_z^+) & -2f_1 \xi_z - \operatorname{Im}(\Gamma_z^+) \\ \operatorname{Re}(\Gamma_z^+) - 2f_2 \xi_z & - \left(\frac{|f|^2}{2} \Gamma + 2f_3^2 \Gamma_{zz} - \operatorname{Re}(f^2 \Gamma_{-+}) \right) & - \left(|f|^2 \xi + \operatorname{Im}(f^2 \Gamma_{-+}) \right) \\ 2f_1 \xi_z - \operatorname{Im}(\Gamma_z^+) & \left(|f|^2 \xi - \operatorname{Im}(f^2 \Gamma_{-+}) \right) & - \left(\frac{|f|^2}{2} \Gamma + 2f_3^2 \Gamma_{zz} + \operatorname{Re}(f^2 \Gamma_{-+}) \right) \end{pmatrix}}_M \begin{pmatrix} a \\ b \\ c \end{pmatrix} \quad (\text{A43}) \\
&\quad + \underbrace{\begin{pmatrix} |f|^2 (\Gamma_{++} - \Gamma_{--}) \\ \operatorname{Re}(\Gamma_z^-) \\ -\operatorname{Im}(\Gamma_z^-) \end{pmatrix}}_{\vec{r}} \quad (\text{A44})
\end{aligned}$$

We may now rewrite the action of the super operator as a linear transformation and obtain an form for the evolution based on the previous map:

$$\mathcal{K}_2[\rho] = \vec{\sigma}^T (M\vec{a} + \vec{r}) \quad (\text{A45})$$

Where

$$\vec{\sigma} = \begin{pmatrix} \sigma_z \\ \sigma_x \\ \sigma_y \end{pmatrix} \quad (\text{A46})$$

Now applying the map again will have the same form, it will just be applied on $\rho = a'\sigma_z + b'\sigma_x + c'\sigma_y$, so this time the term proportional to the identity (\vec{r}) does not come into play so applying the map once again results in:

$$\mathcal{Z}^2[\rho] = \vec{\sigma}^T M(M\vec{a} + \vec{r}) \quad (\text{A47})$$

And the exponential can be computed as :

$$e^{\mathcal{Z}}[\rho] = \rho + \vec{\sigma}^T \sum_{n=1}^{\infty} \frac{M^{n-1}(M\vec{a} + \vec{r})}{n!} \quad (\text{A48})$$

$$= \rho - \vec{\sigma}^T (\vec{a} + M^{-1}\vec{r}) + \vec{\sigma}^T \sum_{n=0}^{\infty} \frac{M^n \vec{a}}{n!} + \vec{\sigma}^T \sum_{n=0}^{\infty} \frac{M^{n-1} \vec{r}}{n!} \quad (\text{A49})$$

$$= \rho - \vec{\sigma}^T (\vec{a} + M^{-1}\vec{r}) + \vec{\sigma}^T e^M \vec{a} + \vec{\sigma}^T e^M M^{-1} \vec{r} \quad (\text{A50})$$

$$e^{\mathcal{Z}}[\rho] = \frac{\mathbb{I}}{2} + \vec{\sigma}^T (e^M - \mathbb{I}) M^{-1} \vec{r} + \vec{\sigma}^T e^M \vec{a} \quad (\text{A51})$$

Appendix B: Relationship with the Charge Qubit

One of the simplest elements in superconducting circuits is the Cooper pair box (CPB) or charge qubit [41], which is a superconducting candidate for a qubit whose basis states are charge state which represent the presence of Cooper pairs in the superconducting island, the simplified schematics of a charge qubit are shown on Fig. 9, The line with the cross is used to denote a tunnel junction, C_J denotes the junction's capacitance while E_J is the Josephson energy, C_g and V_g are the gate voltage and capacitance used to control the superconducting junction. The Hamiltonian of such a superconducting circuit in standard circuit QED is given by

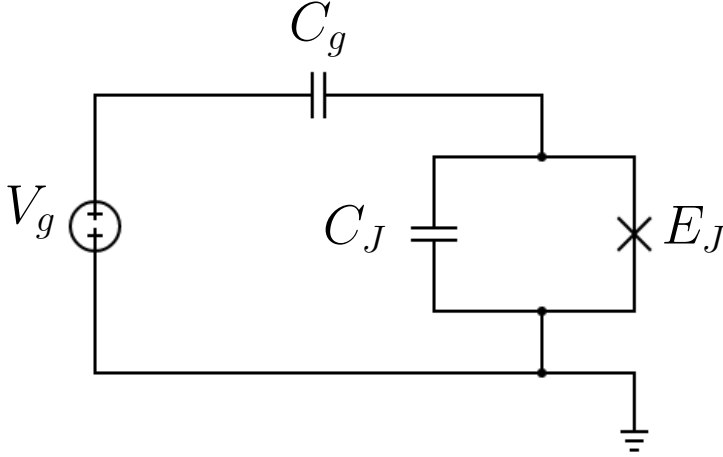

FIG. 8: Simple schematic for a charge qubit

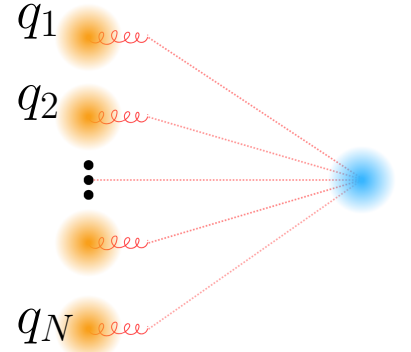

FIG. 9: Illustration of the spin boson model

FIG. 10: This figure shows the two possible representations of this model, on the one hand it can be thought of as a charge qubit where we are only interested in the first two levels and that is in the weakly coupled regime 8 on the other hand it can be thought of as a spin particle coupled to a Bosonic bath 9 where the coupling to the bath is not orthogonal or parallel to the system Hamiltonian as illustrated in the Table 1

$$H = E_C (\hat{N} - N_g)^2 - E_J \cos(\hat{\phi}) \quad (\text{B1})$$

where E_C is the junction's charging energy, \hat{N} and $\hat{\phi}$ correspond to the canonical operators that quantize charge and flux. if we rewrite (B1) in the Cooper pair number basis we obtain:

$$H = E_C \sum_N (N - N_g)^2 |N\rangle \langle N| - \frac{E_J}{2} \sum_N (|N+1\rangle \langle N| + |N\rangle \langle N+1|) \quad (\text{B2})$$

When the Josephson Energy is much bigger than the capacitive energy $E_J \gg E_C$, we find ourselves in the small coupling regime. In this regime $N_g = N + \frac{1}{2} + \Delta_g$, if we then now restrict ourselves to the two lowest energy levels we obtain

$$H = \frac{w_0}{2}\sigma_z - \frac{E_J}{2}\sigma_x \quad (\text{B3})$$

where $w_0 = 2E_C\Delta_g$, while the coupling from (1) may look a bit unnatural to the reader, it comes from the CPB model we just briefly reviewed by following the procedure in [8, 27, 35] we will follow the arguments given in those references. Without loss of generality let us consider

$$H = \underbrace{\frac{\omega_0}{2}\sigma_z + \frac{\Delta}{2}\sigma_x + \frac{\delta}{2}\sigma_y}_{H_S} + \underbrace{\sum_k w_k a_k^\dagger a_k}_{H_B} + \underbrace{\sum_k g_k \sigma_z (a_k + a_k^\dagger)}_{H_I} \quad (\text{B4})$$

which corresponds to the CPB qubit hamiltonian subjected to dephasing by a bosonic bath when $\delta = 0$. The first step towards deriving a master equation is to diagonalize the system, to obtain the eigenbasis $H_s |\psi\rangle = E_n |\psi\rangle$, for this two level system we will obtain:

$$E_\pm = \pm \frac{\Omega}{2} \quad (\text{B5})$$

$$|+\rangle = \sqrt{\frac{\delta^2 + \Delta^2}{\delta^2 + \Delta^2 + (\omega_0 + \Omega)^2}} \left(|1\rangle + \frac{\omega_0 + \Omega}{\Delta + i\delta} |0\rangle \right) \quad (\text{B6})$$

$$|-\rangle = \frac{\Omega + \omega_0}{\sqrt{\Delta^2 + \delta^2 + (\Omega + \omega_0)^2}} \left(|1\rangle - \frac{(\Delta - i\delta)}{\omega_0 + \Omega} |0\rangle \right) \quad (\text{B7})$$

Where $\Omega = \sqrt{\delta^2 + \Delta^2 + \omega_0^2}$. Then we need to rewrite σ_z in this basis which is given by:

$$\sigma_z^r = \sum_{i,j=+,-} \langle j | \sigma_z | i \rangle |i\rangle \langle j| \quad (\text{B8})$$

So in this basis we have:

$$\sigma_z^r = \begin{pmatrix} \langle + | \sigma_z | + \rangle & \langle + | \sigma_z | - \rangle \\ \langle - | \sigma_z | + \rangle & \langle - | \sigma_z | - \rangle \end{pmatrix} \quad (\text{B9})$$

We can then decompose this matrix in terms of the pauli matrices in this bases given by:

$$\tilde{\sigma}_z = |+\rangle \langle +| - |-\rangle \langle -| \quad (\text{B10})$$

$$\tilde{\sigma}_x = |+\rangle \langle -| + |-\rangle \langle +| \quad (\text{B11})$$

$$\tilde{\sigma}_y = -i(|+\rangle \langle +| - |-\rangle \langle -|) \quad (\text{B12})$$

We may find the decomposition due to the fact that $Tr[\sigma_i] = 0$ and $\{\mathbb{I}, \tilde{\sigma}_x, \tilde{\sigma}_y, \tilde{\sigma}_z\}$ form a complete basis, so that:

$$\sigma_z^r = c_x \tilde{\sigma}_x + c_y \tilde{\sigma}_y + c_z \tilde{\sigma}_z \quad (\text{B13})$$

$$Tr[\sigma_z^r \tilde{\sigma}_i] = c_i \quad (\text{B14})$$

Where we skipped the identity because our original matrix is trace-less. We then find:

$$c_z = \frac{2(\omega_0^2 - \Delta\sqrt{\Delta^2 + \delta^2})}{\Omega^2} \quad (\text{B15})$$

$$c_y = \frac{-2\delta}{\Omega} \quad (\text{B16})$$

$$c_x = -\frac{2\omega_0(\Delta + \sqrt{\delta^2 + \Delta^2})}{\Omega^2} \quad (\text{B17})$$

Then the Hamiltonian in this rotated picture can be written as:

$$\tilde{H} = \underbrace{\frac{\Omega}{2}\tilde{\sigma}_z}_{H_S} + \underbrace{\sum_k w_k a_k^\dagger a_k}_{H_B} + \underbrace{\sum_k g_k (c_z \tilde{\sigma}_z + c_x \tilde{\sigma}_x + c_y \tilde{\sigma}_y)}_{H_I} (a_k + a_k^\dagger) \quad (\text{B18})$$

Which is our model of interest, and the one whose steady state coherences have been debated [5–7], as we showed in this section it simply corresponds to diagonalizing the CPB qubit Hamiltonian

Appendix C: Non-Markovianity of the model

In previous studies the Non-Markovianity of the spin boson model under evolution described by the cumulant equation has been shown for x -coupling with bath [12, 14]. In this section we present results for more general coupling with bath, and compare them with the Bloch-Redfield equation as well as with the HEOM. This serves as a confirmation that the Non-Markovianity described by the cumulant equation is not an approximation effect. The measure of Non-Markovianity used is the trace distance measure

$$\frac{1}{2} \|\rho(t) - \sigma(t)\| = \frac{1}{2} \text{Tr} \left\{ \sqrt{(\rho(t) - \sigma(t))^\dagger (\rho(t) - \sigma(t))} \right\} \quad (\text{C1})$$

The initial states for the two evolutions were chosen to be orthogonal specifically we chose

$$\rho(0) = \begin{pmatrix} 0.5 & 0.5i \\ -0.5i & 0.5 \end{pmatrix} = \overline{\sigma(0)}. \quad (\text{C2})$$

For Markovian evolutions the trace distance between the evolutions decreases monotonically, while for Non-Markovian evolutions it does not, usually the increase in the measure is small [42]. To visualize the increase in the trace distance better better, an inset has been placed in Fig. 11 the inset contains the derivative of the trace distance and it is shown in logarithmic scale, a positive value indicates increase of the trace distance measure and therefore Non-Markovianity

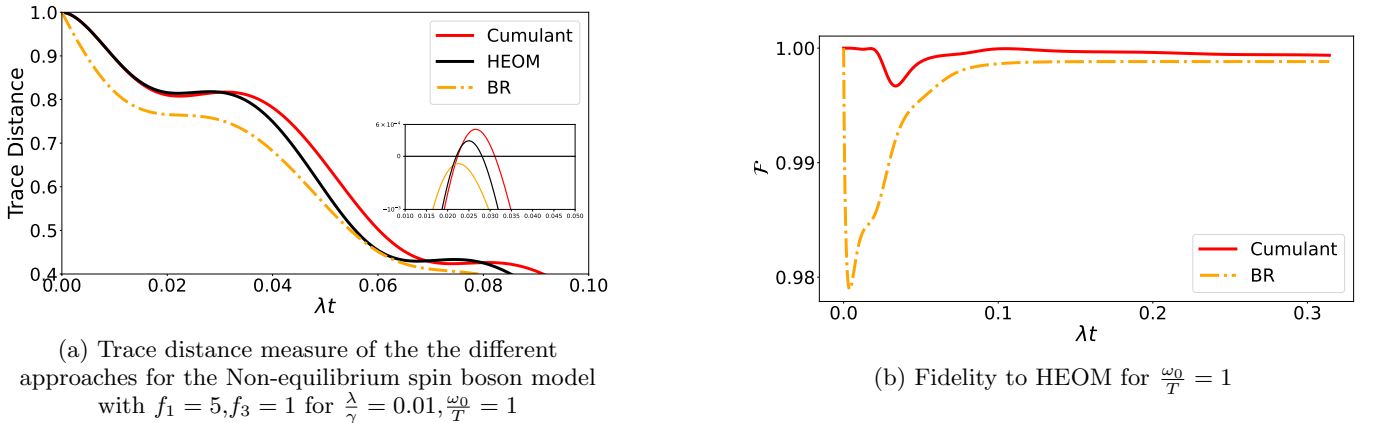

FIG. 11: Non-Markovianity measure for different temperatures, the fidelity from the dynamics shows that even when the Non-Markovianity of the model may be exaggerated the cumulant equation is still a good description.

Indeed, the cumulant equation correctly points out non-Markovian regimes, although it overestimates the magnitude of the Non-Markovianity, serving therefore for a qualitative indicator, a fact that was not discussed in previous studies.

For example when considering the parameters shown in the Fig. 11, the Non-Markovianity is clearly overestimated. Yet the cumulant equation still shows Non-Markovianity while the Bloch-Redfield (also known as Markovian Redfield) doesn't.

At the same time this section works as a word of caution against taking these measures calculated from master equations too seriously, as in some regimes it may overestimate the Non-Markovianity of the situation, while still being a more faithful description of the exact dynamics. or may show Non-Markovianity where the exact solution

shows none, we have observed that the cumulant equation presents deviations from the numerically exact solution in the latter case. While this may be seen as at disadvantage of the cumulant equation we would like to remark that the cumulant equation still shows Non-Markovianity while the Bloch-Redfield (also known as Markovian Redfield) doesn't, and at the same time exhibits higher fidelity at least in the setups considered.

-
- [1] M. Lobejko, M. Winczewski, G. Suárez, R. Alicki, and M. Horodecki, Towards reconciliation of completely positive open system dynamics with the equilibration postulate (2022), arXiv:2204.00643 [quant-ph].
- [2] A. S. Trushechkin, M. Merkli, J. D. Cresser, and J. Anders, Open quantum system dynamics and the mean force Gibbs state, *AVS Quantum Science* **4**, 10.1116/5.0073853 (2022), 012301, https://pubs.aip.org/avs/aqs/article-pdf/doi/10.1116/5.0073853/16493686/012301_1_online.pdf.
- [3] C. L. Latune, Steady state in strong system-bath coupling regime: Reaction coordinate versus perturbative expansion, *Phys. Rev. E* **105**, 024126 (2022).
- [4] A. Nazir and G. Schaller, The reaction coordinate mapping in quantum thermodynamics, in *Thermodynamics in the Quantum Regime: Fundamental Aspects and New Directions*, edited by F. Binder, L. A. Correa, C. Gogolin, J. Anders, and G. Adesso (Springer International Publishing, Cham, 2018) pp. 551–577.
- [5] G. Guarneri, M. Kolář, and R. Filip, Erratum: Steady-state coherences by composite system-bath interactions [phys. rev. lett. 121, 070401 (2018)], *Phys. Rev. Lett.* **127**, 129901 (2021).
- [6] G. Guarneri, M. Kolář, and R. Filip, Steady-state coherences by composite system-bath interactions, *Phys. Rev. Lett.* **121**, 070401 (2018).
- [7] M. Cattaneo and G. Manzano, Comment on "steady-state coherences by composite system-bath interactions" (2021), arXiv:2106.09138 [quant-ph].
- [8] A. Purkayastha, G. Guarneri, M. T. Mitchison, R. Filip, and J. Goold, Tunable phonon-induced steady-state coherence in a double-quantum-dot charge qubit, *npj Quantum Information* **6**, 27 (2020).
- [9] T. Mori and S. Miyashita, Dynamics of the density matrix in contact with a thermal bath and the quantum master equation, *Journal of the Physical Society of Japan* **77**, 124005 (2008), <https://doi.org/10.1143/JPSJ.77.124005>.
- [10] E. Geva, E. Rosenman, and D. Tannor, On the second-order corrections to the quantum canonical equilibrium density matrix, *The Journal of Chemical Physics* **113**, 1380 (2000), https://pubs.aip.org/aip/jcp/article-pdf/113/4/1380/10829106/1380_1_online.pdf.
- [11] V. Romero-Rochin and I. Oppenheim, Relaxation properties of two-level systems in condensed phases, *Physica A: Statistical Mechanics and its Applications* **155**, 52 (1989).
- [12] A. Rivas, Refined weak-coupling limit: Coherence, entanglement, and non-markovianity, *Phys. Rev. A* **95**, 042104 (2017).
- [13] R. Alicki, Master equations for a damped nonlinear oscillator and the validity of the markovian approximation, *Phys. Rev. A* **40**, 4077 (1989).
- [14] M. Winczewski, A. Mandarino, M. Horodecki, and R. Alicki, Bypassing the intermediate times dilemma for open quantum system (2021), arXiv:2106.05776 [quant-ph].
- [15] Y. Tanimura and R. Kubo, Time evolution of a quantum system in contact with a nearly gaussian-markoffian noise bath, *Journal of the Physical Society of Japan* **58**, 101 (1989), <https://doi.org/10.1143/JPSJ.58.101>.
- [16] N. Lambert, T. Raheja, S. Cross, P. Menczel, S. Ahmed, A. Pitchford, D. Burgarth, and F. Nori, Qutip-boost: A bosonic and fermionic numerical hierarchical-equations-of-motion library with applications in light-harvesting, quantum control, and single-molecule electronics, *Phys. Rev. Res.* **5**, 013181 (2023).
- [17] R. Doll, D. Zueco, M. Wubs, S. Kohler, and P. Hänggi, On the conundrum of deriving exact solutions from approximate master equations, *Chemical Physics* **347**, 243 (2008).
- [18] G. Suarez, Non markovian methods <https://github.com/gsuarezr/nonmarkovianmethods>.
- [19] R. Alicki, M. Horodecki, P. Horodecki, R. Horodecki, L. Jacak, and P. Machnikowski, Optimal strategy for a single-qubit gate and the trade-off between opposite types of decoherence, *Phys. Rev. A* **70**, 010501 (2004).
- [20] J. Schlienz and G. Mahler, Description of entanglement, *Phys. Rev. A* **52**, 4396 (1995).
- [21] R. Hartmann and W. T. Strunz, Accuracy Assessment of Perturbative Master Equations – Embracing Non-Positivity, *Physical Review A* **101**, 012103 (2020), arXiv:1906.02583 [quant-ph].
- [22] M. Cattaneo, G. L. Giorgi, S. Maniscalco, and R. Zambrini, Local versus global master equation with common and separate baths: superiority of the global approach in partial secular approximation, *New Journal of Physics* **21**, 113045 (2019).
- [23] P. P. Potts, A. A. S. Kalae, and A. Wacker, A thermodynamically consistent markovian master equation beyond the secular approximation, *New Journal of Physics* **23**, 123013 (2021).
- [24] D. F. de la Pradilla, E. Moreno, and J. Feist, Taming the bloch-redfield equation: Recovering an accurate lindblad equation for general open quantum systems (2024), arXiv:2402.06354 [quant-ph].
- [25] D. A. Lidar, Lecture notes on the theory of open quantum systems (2020), arXiv:1902.00967 [quant-ph].
- [26] Quantum computers and dissipation, *Proceedings of the Royal Society of London. Series A: Mathematical, Physical and Engineering Sciences* **452**, 567 (1996).
- [27] G. Schaller, Open Quantum Systems Far from Equilibrium — [link.springer.com](https://link.springer.com/book/10.1007/978-3-319-03877-3), <https://link.springer.com/book/10.1007/978-3-319-03877-3>, [Accessed 07-03-2024].
- [28] A. REDFIELD, The theory of relaxation processes* *this work was started while the author was at harvard university,

and was then partially supported by joint services contract n5ori-76, project order i., in *Advances in Magnetic Resonance*, Advances in Magnetic and Optical Resonance, Vol. 1, edited by J. S. Waugh (Academic Press, 1965) pp. 1–32.

- [29] F. Bloch, Nuclear induction, *Phys. Rev.* **70**, 460 (1946).
- [30] M. Mirrahimi, Z. Leghtas, V. V. Albert, S. Touzard, R. J. Schoelkopf, L. Jiang, and M. H. Devoret, Dynamically protected cat-qubits: a new paradigm for universal quantum computation, *New Journal of Physics* **16**, 045014 (2014).
- [31] V. V. Albert, Lindbladians with multiple steady states: theory and applications (2018), arXiv:1802.00010 [quant-ph].
- [32] M. Winczewski and R. Alicki, Renormalization in the theory of open quantum systems via the self-consistency condition (2023), arXiv:2112.11962 [quant-ph].
- [33] G. C. Hegerfeldt and M. B. Plenio, Coherence with incoherent light: A new type of quantum beat for a single atom, *Phys. Rev. A* **47**, 2186 (1993).
- [34] A. Dodin, T. Tscherbul, R. Alicki, A. Vutha, and P. Brumer, Secular versus nonsecular redfield dynamics and fano coherences in incoherent excitation: An experimental proposal, *Phys. Rev. A* **97**, 013421 (2018).
- [35] D. Xu and J. Cao, Non-canonical distribution and non-equilibrium transport beyond weak system-bath coupling regime: A polaron transformation approach, *Frontiers of Physics* **11**, 110308 (2016).
- [36] J. Jeske, D. J. Ing, M. B. Plenio, S. F. Huelga, and J. H. Cole, Bloch-Redfield equations for modeling light-harvesting complexes, *The Journal of Chemical Physics* **142**, 064104 (2015), https://pubs.aip.org/aip/jcp/article-pdf/doi/10.1063/1.4907370/14030726/064104_1_online.pdf.
- [37] M. Cattaneo, G. L. Giorgi, S. Maniscalco, and R. Zambrini, Local versus global master equation with common and separate baths: superiority of the global approach in partial secular approximation, *New Journal of Physics* **21**, 113045 (2019), publisher: IOP Publishing.
- [38] S. Vinjanampathy and J. Anders, Quantum thermodynamics, *Contemporary Physics* **57**, 545 (2016).
- [39] Ángel Rivas, A. D. K. Plato, S. F. Huelga, and M. B. Plenio, Markovian master equations: a critical study, *New Journal of Physics* **12**, 113032 (2010).
- [40] This convention has been chosen to match existing literature, when the reduced model is considered [12].
- [41] A. Blais, A. L. Grimsmo, S. M. Girvin, and A. Wallraff, Circuit quantum electrodynamics, *Rev. Mod. Phys.* **93**, 025005 (2021).
- [42] D. Chruściński, A. Kossakowski, and A. Rivas, Measures of non-markovianity: Divisibility versus backflow of information, *Phys. Rev. A* **83**, 052128 (2011).