

Rigid matroid categories

Kevin Purbhoo

March 7, 2024

Abstract

We consider three forms of composition of matroids, each of which extends the category of bimatroids to a rigid monoidal category. Many well-known constructions are functorial or defined by morphisms in these categories. Motivating examples include: deletion and contraction, 2-sum, series and parallel connections, the Tutte polynomial, gammoids, positroids, matroids representable over an infinite field, M -convex sets, and matroids associated to stable polynomials.

1 Introduction

1.1 Matroids

A matroid is a discrete structure which attempts to axiomatize and generalize the main combinatorial properties of linearly independent sets in a vector space. There are many equivalent ways think about matroids. They can be defined axiomatically in terms of their independent sets, bases, circuits, flats, rank function, or polytope. For our purposes, it is most useful to regard a matroid as being a set of bases. We begin by recalling the definition.

We will use the following notation throughout. If E is a finite set, then 2^E denotes the set of all subsets of E . For $X \in 2^E$, $x \in E$, we write $X - x := X \setminus \{x\}$ if $x \in X$, $X + x := X \cup \{x\}$ if $x \notin X$. We denote the complement by $\overline{X} := E \setminus X$.

Definition 1.1. Let E be a finite set, and let $\alpha \subseteq 2^E$ be a collection of subsets of E . We say that α satisfies the *exchange axiom* if the following condition holds: For all $X, X' \in \alpha$ and all $x \in X \setminus X'$, there exists $x' \in X' \setminus X$ such that $X - x + x' \in \alpha$.

Definition 1.2. A *matroid* is a pair (E, α) such that:

- (1) E is a finite set
- (2) $\alpha \subseteq 2^E$ is a collection of subsets of E
- (3) α satisfies the exchange axiom
- (4) $\alpha \neq \emptyset$.

The elements of E are called the *points* of the matroid (E, α) and the elements of α are called the *bases*. We also say that α is a matroid on E .

The prototypical example of a matroid is to take E to be a spanning set of vectors in a vector space V , and α to be the collection of all subsets of E that are bases for V (in the sense of linear algebra). However, most matroids are not actually of this form [11].

For any matroid (E, α) , all bases $X \in \alpha$ have the same size, which is called the *rank* of α . As the definition indicates, $\alpha = \emptyset$ is normally not considered to be a matroid on E , since it is both combinatorially uninteresting (it has no bases), and pathological (it does not have a well-defined rank). However, for our purposes it will be necessary to consider it, and we shall refer to it as the *zero matroid* on E . The zero matroid should not be confused with the 0-uniform matroid on E , $\alpha = \{\emptyset\}$, which is the unique matroid on E of rank 0.

1.2 Composition

We study composition of matroids, which is most naturally discussed in the language of categories. We assume familiarity with categories, and refer the reader to [9] or [12] for most definitions. The idea of forming a category in which the morphisms are matroids was considered by Kung [7], who introduced the *category of bimatroids*. Independently, bimatroids were introduced by Schrijver [19], who called them *linking systems*. A bimatroid is the discrete structure one naturally obtains by axiomatizing the combinatorial properties of the non-vanishing minors of a matrix. This turns out to be equivalent to the data of a matroid equipped with a distinguished basis. Here, we do not wish to require our matroids to have a distinguished basis, and so we consider some slightly more general constructions.

We define three main categories: \mathbf{Mtd}° , \mathbf{Mtd}^\bullet , $R\text{-}\mathbf{Mtd}^\star(x, y)$. In each case the objects of the category are finite sets. The morphisms of \mathbf{Mtd}° and \mathbf{Mtd}^\bullet are matroids, where the points have been partitioned into two sets: a domain, and a codomain. The morphisms of $R\text{-}\mathbf{Mtd}^\star(x, y)$ are formal R -linear combinations of such matroids. (Here R is an arbitrary commutative ring, semiring, or monoid, and $x, y \in R$ are elements.) Our main theorems assert that these are indeed categories: in each case, the class of morphisms is closed under composition, and composition is associative. Moreover, they are rigid monoidal categories: informally, *monoidal* means that we have notion of “tensor products” of matroids, and *rigid* means there is a canonical way (using morphisms in the category) to move points from the domain to the codomain, and vice-versa. In contrast, the category of bimatroids is monoidal but not rigid, and this poses limitations on the types of constructions and arguments that are possible with bimatroids.

In each of these categories, composition of morphisms is defined by an associative composition rule for matroids. The composition operations are denoted by \circ in \mathbf{Mtd}° , by \bullet in \mathbf{Mtd}^\bullet , and by \star in $R\text{-}\mathbf{Mtd}^\star(x, y)$. For bimatroids, there is no difference: all three operations \circ , \bullet and \star all coincide with bimatroid multiplication (when restricted to bimatroids). However, in general they are not the same: \circ is defined in Section 2,

as a specialization of composition of relations, whereas \bullet and \star are more subtle operations, defined in Sections 6 and 8, respectively. The relationship between them can be summarized as follows. Given composable matroids λ, μ , we consider a formal power series in two variables:

$$\lambda \blacksquare \mu := \sum_{k,l \geq 0} (\lambda \bullet_{k,l} \mu) x^k y^l,$$

where $\bullet_{k,l}$ is an operation defined in Section 6. Then $\lambda \circ \mu$ is the degree-zero term of $\lambda \blacksquare \mu$, while $\lambda \bullet \mu$ is the leading (lowest degree) coefficient, and $\lambda \star \mu$ is the leading term. Note, however, that \blacksquare is not the composition operation of any category, so this description does not help to prove anything. Nevertheless, we see that \circ should be regarded as a degenerate form of \bullet , while \star is weighted form of \bullet , which interpolates between \bullet and \circ . Another analogy is that \circ is to bases of a matroid, as \bullet is to independent sets, while \star keeps track of the difference. Both \mathbf{Mtd}° and \mathbf{Mtd}^\star are special cases of the construction $R\text{-Mtd}^\star(x, y)$, for suitably chosen R, x, y .

The category \mathbf{Mtd}° is what we get if we extend the category of bimatroids to a rigid category, in the most naïve way. It is likely that this idea has been considered (and possibly rejected) many times before. We contend, nevertheless, that this category is interesting and well-motivated. In particular, Section 3 discusses several examples of functorial constructions that are not bimatroidal, and illustrate some of the advantages of having a rigid category. However, in \mathbf{Mtd}° , we are forced to include zero matroids as morphisms in the category, since the \circ -composition of two non-zero matroids may nevertheless be zero. \mathbf{Mtd}^\star , on the other hand, is a (less obvious) extension of the category of bimatroids which also has rigid monoidal structure, and morphisms are precisely the non-zero matroids. The fact that \mathbf{Mtd}^\star is rigid, allows us to obtain a structure theorem on \bullet -composition and its relationship to \circ -composition. Furthermore, the fundamental deletion and contraction operations on matroids are realized as morphisms in the category \mathbf{Mtd}^\star . As such, an example of a morphism in $R\text{-Mtd}^\star(x, y)$ is the Tutte polynomial.

We describe variations on all of these categories for various special classes and generalizations of matroids, including:

- matroids representable over an infinite field ($\mathbf{Mtd}^\circ(\mathbb{F}), \mathbf{Mtd}^\star(\mathbb{F}), R\text{-Mtd}^\star(\mathbb{F}; x, y)$);
- gammoids ($\mathbf{Gam}^\circ, \mathbf{Gam}^\star, R\text{-Gam}^\star(x, y)$);
- positroids ($\mathbf{Pos}^\circ, \mathbf{Pos}^\star, R\text{-Pos}^\star(x, y)$);
- symmetric matroids ($\mathbf{SMtd}^\circ, \mathbf{SMtd}^\star, R\text{-SMtd}^\star(x, y)$);
- and M-convex sets ($\mathbf{MConv}^\circ, \mathbf{MConv}^\star, R\text{-MConv}^\star(x, y)$).

1.3 Outline

In Section 2, we begin by reformulating the definition of a matroid as a relation on subsets, and we list several examples that play a key role in the subsequent discussion. Since relations are composable, this reformulation implicitly defines a notion of composition of matroids, which we use to define the category \mathbf{Mtd}° . We verify that

this category is well-defined, and discuss its basic properties. We give several examples of functors to the category \mathbf{Mtd}° in Section 3. These connect with a variety of topics, including representable matroids, gammoids, positroids, and stable polynomials. In Section 4 we discuss the covariant hom-functor on \mathbf{Mtd}° , and other categories and constructions obtained from it. We consider some examples in Section 5; in particular we see that deletion and contraction are not quite the same as any of these constructions, though they are closely related. We also introduce categories of symmetric matroids and M-convex sets.

The category \mathbf{Mtd}^\bullet is defined in Section 6, and is meant to fix the problem with deletion and contraction. It is not immediately obvious that the construction gives anything reasonable. Here, we state one of our main results, Theorem 6.4, which asserts that \mathbf{Mtd}^\bullet is a category, and furthermore there is a numerical invariant of \bullet -compositions, called the *type*, which is well-defined and well-behaved with respect to associativity. Consequently, \mathbf{Mtd}^\bullet has many of the same properties as \mathbf{Mtd}° . In Section 7, we state and prove Theorem 7.1, a structure theorem which more precisely describes the relationship between \bullet and \circ . As an application, we show that \bullet restricts to a well-defined operation on positroids. The more general category $R\text{-}\mathbf{Mtd}^\star$, which interpolates between \mathbf{Mtd}° and \mathbf{Mtd}^\bullet , is defined in Section 8, and we discuss its connection to the Tutte polynomial.

The proof of Theorem 6.4 comprises the final two sections of the paper. In Section 9, we show that compositions in the category \mathbf{Mtd}^\bullet do indeed have a well-defined type; we do this by reducing the problem to a special class of morphisms, called *dominant morphisms*, and studying their properties. We deduce that the morphisms of \mathbf{Mtd}^\bullet are closed under \bullet -composition. Finally, the associativity of \bullet and the properties of type under association are proved in Section 10.

It is not necessary to read this paper in linear order. Dependencies between sections are shown in the diagram below. Solid arrows indicate that the main discussion in the later section depends on the main discussion in the earlier section. Dashed arrows mean that some of the examples in the later section refer back to examples from the earlier section (these may be skipped or skimmed without losing the main thread).

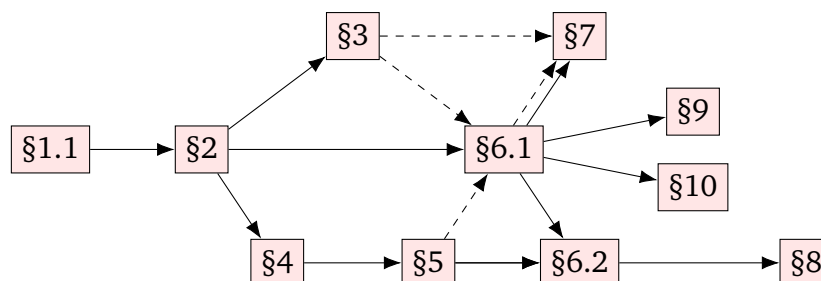

Acknowledgements. I thank Jim Geelen, Allen Knutson, Jake Levinson, Peter Nelson and David Wagner for helpful conversations and feedback. This research was supported by NSERC Discovery Grant RGPIN-04741-2018.

2 Matroids as relations

Convention 2.1. We use *diagrammatic order* for all compositions. In any category \mathcal{C} , if $A, B, C \in \text{Ob}_{\mathcal{C}}$ are objects, and $\phi \in \text{Mor}_{\mathcal{C}}(A, B)$, $\psi \in \text{Mor}_{\mathcal{C}}(B, C)$ are morphisms, then the composition of ϕ and ψ is denoted $\phi \circ \psi \in \text{Mor}_{\mathcal{C}}(A, C)$. If $\phi : A \rightarrow B$ and $\psi : B \rightarrow C$ are functions, $\phi \circ \psi : A \rightarrow C$ denotes the function $x \mapsto \psi(\phi(x))$.

We will be working extensively with sets that are disjoint unions of other sets. If S_1, \dots, S_n are finite sets, the disjoint union is formally $S = S_1 \sqcup \dots \sqcup S_n := \bigcup_{i=1}^n S_i \times \{i\}$. However, for ease of notation, we implicitly identify S_i and $S_i \times \{i\}$, e.g. writing $x \in S$ when we mean $(x, i) \in S$ for some i . We also identify $2^S \equiv 2^{S_1} \times \dots \times 2^{S_n}$. Specifically, for $X \in 2^S$, we identify $X \equiv (X_{S_1}, \dots, X_{S_n}) \equiv X_{S_1} \sqcup \dots \sqcup X_{S_n}$ where $X_{S_i} := X \cap S_i$, and $\overline{X} \equiv (\overline{X}_{S_1}, \dots, \overline{X}_{S_n}) \equiv \overline{X}_{S_1} \sqcup \dots \sqcup \overline{X}_{S_n}$ where $\overline{X}_{S_i} := S_i \setminus X$.

Definition 2.2. Let $\text{Rel}(S_1, S_2) = 2^{S_1 \times S_2}$ denote the set of all (binary) relations on $S_1 \times S_2$. If $\lambda \in \text{Rel}(S_1, S_2)$, we use the notation $x_1 \mapsto_{\lambda} x_2$ to mean $x_2 \in S_2$ is related to $x_1 \in S_1$ under λ , i.e. $(x_1, x_2) \in \lambda$.

- $\text{Rel}(S_1, S_2)$ is a partially ordered set: for $\lambda, \lambda' \in \text{Rel}(S_1, S_2)$, we write $\lambda \leq \lambda'$ if $x_1 \mapsto_{\lambda} x_2$ implies $x_1 \mapsto_{\lambda'} x_2$.
- The **adjoint relation** $\lambda^{\dagger} \in \text{Rel}(S_2, S_1)$ is characterized by $x_2 \mapsto_{\lambda^{\dagger}} x_1$ if and only if $x_1 \mapsto_{\lambda} x_2$.
- The **range** of λ is the set $\text{range}(\lambda) := \{x_2 \in S_2 \mid \exists x_1 \in S_1: x_1 \mapsto_{\lambda} x_2\}$, and the **corange** of λ is $\text{range}(\lambda^{\dagger})$.
- If $\lambda \in \text{Rel}(S_1, S_2)$, $\nu \in \text{Rel}(S_3, S_4)$, the **product relation** $\lambda \times \nu \in \text{Rel}(S_1 \times S_3, S_2 \times S_4)$ is defined by $(x_1, x_3) \mapsto_{\lambda \times \nu} (x_2, x_4)$ if and only if $x_1 \mapsto_{\lambda} x_2$ and $x_3 \mapsto_{\nu} x_4$.
- For $\lambda \in \text{Rel}(S_1, S_2)$, $\mu \in \text{Rel}(S_2, S_3)$ the **composition** $\lambda \circ \mu \in \text{Rel}(S_1, S_3)$ is the relation defined by $x_1 \mapsto_{\lambda \circ \mu} x_3$ if and only if there exists $x_2 \in S_2$ such that $x_1 \mapsto_{\lambda} x_2$ and $x_2 \mapsto_{\mu} x_3$.

Definition 2.3. Let A, B be finite sets. Let $\lambda \in \text{Rel}(2^A, 2^B)$. Given $X \mapsto_{\lambda} Y$, $u, v \in A \sqcup B$, we say that u and v are **exchangeable** in $X \mapsto_{\lambda} Y$, if either $u = v$, or one of the following is true:

- | | |
|--|---|
| • $u \in X, v \in Y$, and $X - u \mapsto_{\lambda} Y - v$ | • $u \in X, v \in \overline{X}$, and $X - u + v \mapsto_{\lambda} Y$ |
| • $u \in \overline{X}, v \in \overline{Y}$, and $X + u \mapsto_{\lambda} Y + v$ | • $u \in \overline{X}, v \in X$, and $X + u - v \mapsto_{\lambda} Y$ |
| • $u \in Y, v \in X$, and $X - v \mapsto_{\lambda} Y - u$ | • $u \in Y, v \in \overline{Y}$, and $X \mapsto_{\lambda} Y - u + v$ |
| • $u \in \overline{Y}, v \in \overline{X}$, and $X + v \mapsto_{\lambda} Y + u$ | • $u \in \overline{Y}, v \in Y$, and $X \mapsto_{\lambda} Y + u - v$. |

The definition of exchangeability is symmetric in u and v , in X and Y , and in “+” and “−”. Note the pattern in the list of cases above. In all cases, the first two conditions indicate which of the four sets $X, Y, \overline{X}, \overline{Y}$ contain u and v . The third condition is of the form $X' \mapsto_{\lambda} Y'$ where X', Y' are obtained by adding or deleting u and v to or from X

or Y , as appropriate, as determined by the first two conditions. The list consists of all combinations for which we have $|Y'| - |X'| = |Y| - |X|$.

Definition 2.4. A relation $\lambda \in \text{Rel}(2^A, 2^B)$ satisfies the *exchange axiom* if for all $X \mapsto_\lambda Y$, $X' \mapsto_\lambda Y'$, and $u \in \overline{X} \sqcup Y$ there exists $v \in \overline{X'} \sqcup Y'$ such that u and v are exchangeable in $X \mapsto_\lambda Y$. (Equivalently, for all $X \mapsto_\lambda Y$, $X' \mapsto_\lambda Y'$, and $u \in X \sqcup \overline{Y}$ there exists $v \in X' \sqcup \overline{Y'}$ such that u and v are exchangeable in $X \mapsto_\lambda Y$.) Let $\text{Exch}(2^A, 2^B) \subseteq \text{Rel}(2^A, 2^B)$ denote the subset of all relations on $2^A \times 2^B$ which satisfy the exchange axiom.

The exchange axiom for matroids and for relations are of course closely related. Let $\mathbb{M}(E)$ denote the set of all matroids on E , including the zero matroid. For a relation $\lambda \in \text{Rel}(2^A, 2^B)$, let

$$\alpha_\lambda := \{\overline{X} \sqcup Y \mid X \mapsto_\lambda Y\}.$$

Unpacking the definitions, we find that $\lambda \in \text{Exch}(2^A, 2^B)$ if and only if $\alpha_\lambda \in \mathbb{M}(A \sqcup B)$. Thus, the correspondence $\lambda \leftrightarrow \alpha_\lambda$ defines a bijection $\mathbb{M}(A \sqcup B) \leftrightarrow \text{Exch}(2^A, 2^B)$, and α_λ is called the *associated matroid* of λ . We define the *degree* of λ to be $\deg(\lambda) := \text{rank}(\alpha_\lambda) - |A|$. Equivalently, for all $X \mapsto_\lambda Y$, we have $|Y| - |X| = \deg(\lambda)$.

In particular for any finite set E , we canonically identify the set of matroids $\mathbb{M}(E)$ with the set of relations $\text{Exch}(2^\emptyset, 2^E)$. With this identification, the rank of a matroid is equal to the degree of the corresponding relation.

Example 2.5. The *zero relation* $0_{AB} \in \text{Rel}(2^A, 2^B)$ is the relation for which $X \not\mapsto_{0_{AB}} Y$ for all $X \in 2^A$, $Y \in 2^B$. Vacuously, we have $0_{AB} \in \text{Exch}(2^A, 2^B)$. The associated matroid of 0_{AB} is the zero matroid on $A \sqcup B$, and hence $\deg(0_{AB})$ is undefined.

Example 2.6. The *identity relation* $1_A \in \text{Rel}(2^A, 2^A)$ is the relation for which $X \mapsto_{1_A} Y$ if and only if $X = Y$. It is straightforward to verify that $1_A \in \text{Exch}(2^A, 2^A)$. For any finite set A , we have $\deg(1_A) = 0$,

Example 2.7. For $P \subseteq A$, $Q \subseteq B$, the *elementary relation* $\epsilon^{PQ} \in \text{Rel}(2^A, 2^B)$ is the relation such that $X \mapsto_{\epsilon^{PQ}} Y$ if and only if $X = P$ and $Y = Q$. Then $\epsilon^{PQ} \in \text{Exch}(2^A, 2^B)$, and $\deg(\epsilon^{PQ}) = |Q| - |P|$.

Example 2.8. For a finite set A , the *covering relation* $\eta \in \text{Rel}(2^A, 2^A)$ is the relation such that $X \mapsto_\eta Y$ if and only if $X \subseteq Y$, $|X| = |Y| - 1$. Then $\eta \in \text{Exch}(2^A, 2^A)$, and $\deg(\eta) = 1$.

Example 2.9. Given disjoint subsets $P, Q \subseteq A$, the *partial identity relation* $\theta_A^{PQ} \in \text{Rel}(2^A, 2^A)$ is the relation such that $X \mapsto_{\theta_A^{PQ}} Y$ if and only if $P = Y \setminus X$ and $Q = X \setminus Y$. We have $\theta_A^{PQ} \in \text{Exch}(2^A, 2^A)$, and $\deg(\theta_A^{PQ}) = |P| - |Q|$.

Example 2.10. For any $k \in \mathbb{Z}$, the degree- k *uniform relation* $\xi_{AB}^k \in \text{Rel}(2^A, 2^B)$ is the relation defined by $X \mapsto_{\xi_{AB}^k} Y$ if and only if $|Y| - |X| = k$. We have $\xi_{AB}^k \in \text{Exch}(2^A, 2^B)$. If $-|A| \leq k \leq |B|$ then $\xi_{AB}^k \neq 0_{AB}$ and $\deg(\xi_{AB}^k) = k$. The associated matroid of ξ_{AB}^k is the uniform matroid of rank $|A| + k$ on $A \sqcup B$.

Example 2.11. If $\lambda \in \text{Exch}(2^A, 2^B)$ and $\mu \in \text{Exch}(2^C, 2^D)$, then the product $\lambda \times \mu$ also satisfies the exchange axiom: $\lambda \times \mu \in \text{Exch}(2^{A \sqcup C}, 2^{B \sqcup D})$, and $\deg(\lambda \times \mu) = \deg(\lambda) + \deg(\mu)$. Here we are implicitly using the identifications $2^A \times 2^C = 2^{A \sqcup C}$ and $2^B \times 2^D = 2^{B \sqcup D}$.

Example 2.12. For any matroid (E, α) , $\bar{\alpha} := \{\bar{X} \mid X \in \alpha\}$ is also a matroid on E , called the **dual matroid** of α . Since $\alpha_{\lambda^\dagger} = \bar{\alpha}_\lambda$, we have that $\lambda \in \text{Exch}(2^A, 2^B)$ if and only if $\lambda^\dagger \in \text{Exch}(2^B, 2^A)$, and $\deg(\lambda^\dagger) = -\deg(\lambda)$.

Example 2.13. Similarly, for $\lambda \in \text{Exch}(2^A, 2^B)$, let $\bar{\lambda}$ be the relation defined by $X \mapsto_{\bar{\lambda}} Y$ if and only if $\bar{X} \mapsto_\lambda \bar{Y}$. Since $\alpha_{\bar{\lambda}} = \alpha_{\lambda^\dagger}$, we have $\bar{\lambda} \in \text{Exch}(2^A, 2^B)$, and $\deg(\bar{\lambda}) = |B| - |A| - \deg(\lambda)$.

Example 2.14. A **bimatroid** is a relation $\lambda \in \text{Exch}(2^A, 2^B)$ such that $\emptyset \mapsto_\lambda \emptyset$. Every bimatroid is non-zero, and has degree 0. Bimatroids have the following special property: if $\lambda \in \text{Exch}(2^A, 2^B)$ is a bimatroid, then $\text{range}(\lambda)$ is the collection of independent sets of a matroid on B , and $\text{range}(\lambda^\dagger)$ is the collection of independent sets of a matroid on A . The associated matroid α_λ has a distinguished basis, namely $A \in \alpha_\lambda$, and a bimatroid is equivalent to the data of a matroid equipped with a distinguished basis.

The following theorem is proved in [7, 19] for bimatroids.

Theorem 2.15. For finite sets A, B, C , if $\lambda \in \text{Exch}(2^A, 2^B)$ and $\mu \in \text{Exch}(2^B, 2^C)$ then $\lambda \circ \mu \in \text{Exch}(2^A, 2^C)$.

Proof. Suppose $X \mapsto_{\lambda \circ \mu} Z$, and $X' \mapsto_{\lambda \circ \mu} Z'$, and let $u \in \bar{X} \cap Z$. We must show that there exists $v \in \bar{X}' \cap Z'$, exchangeable with u in $X \mapsto_{\lambda \circ \mu} Z$. By definition of composition there exist $Y, Y' \subseteq B$ such that

$$X \mapsto_\lambda Y \mapsto_\mu Z \quad \text{and} \quad X' \mapsto_\lambda Y' \mapsto_\mu Z'$$

We now construct sequences $(X_n)_{n \geq 0}$, $(Y_n)_{n \geq 0}$, $(Z_n)_{n \geq 0}$, $(u_n)_{n \geq 0}$ as follows. Let $X_0 = X$, $Y_0 = Y$, $Z_0 = Z$, $u_0 = u$. Recursively define $X_{n+1}, Y_{n+1}, Z_{n+1}, u_{n+1}$ using the exchange axiom repeatedly, according to the following rules.

- (1) If $u_n \in X_n$ let $u_{n+1} = u_n$, $X_{n+1} = X_n - u_n$, $Y_{n+1} = Y_n$, $Z_{n+1} = Z_n$.
- ($\bar{1}$) If $u_n \in \bar{X}_n$, find $u_{n+1} \in \bar{X}' \sqcup Y'$ exchangeable for u_n in $X_n \mapsto_\lambda Y_n$. Let $X_{n+1} = X_n + u_n$, $Y_{n+1} = Y_n$, $Z_{n+1} = Z_n$.
- (2) If $u_n \in Y_n$, find $u_{n+1} \in \bar{X}' \sqcup Y'$ exchangeable for u_n in $X_n \mapsto_\lambda Y_n$. Let $X_{n+1} = X_n$, $Y_{n+1} = Y_n - u_n$, $Z_{n+1} = Z_n$.
- ($\bar{2}$) If $u_n \in \bar{Y}_n$, find $u_{n+1} \in \bar{Y}' \sqcup Z'$ exchangeable for u_n in $Y_n \mapsto_\mu Z_n$. Let $X_{n+1} = X_n$, $Y_{n+1} = Y_n + u_n$, $Z_{n+1} = Z_n$.
- (3) If $u_n \in Z_n$, find $u_{n+1} \in \bar{Y}' \sqcup Z'$ exchangeable for u_n in $Y_n \mapsto_\mu Z_n$. Let $X_{n+1} = X_n$, $Y_{n+1} = Y_n$, $Z_{n+1} = Z_n - u_n$.
- ($\bar{3}$) If $u_n \in \bar{Z}_n$ let $u_{n+1} = u_n$, $X_{n+1} = X_n$, $Y_{n+1} = Y_n$, $Z_{n+1} = Z_n + u_n$.

Note that each exchange is completed over two consecutive steps. Thus, we do not have $X_n \mapsto_\lambda Y_n$ and $Y_n \mapsto_\mu Z_n$ for all n , but the former holds in cases (1), $(\bar{1})$, (2), (3), and the latter holds in cases $(\bar{1})$, $(\bar{2})$, (3), $(\bar{3})$, so it is always possible to find u_{n+1} .

At $n = 0$, we begin in case $(\bar{1})$ or (3), and we can only return to these cases by first reaching case (1) or $(\bar{3})$. In cases (2) and $(\bar{2})$ we have $|Y_{n+1} \Delta Y'| < |Y_n \Delta Y'|$, so these cases can only occur finitely many times. Thus for some n , we must reach case (1) or $(\bar{3})$, at which point $v = u_{n+1}$ has the desired properties. \square

In light of Theorem 2.15, we can define a (locally small) category in which the morphisms are relations which satisfy the exchange axiom.

Definition 2.16. We define a category \mathbf{Mtd}° , in which the objects, morphisms, and composition rule are defined as follows. $\text{Ob}_{\mathbf{Mtd}^\circ}$ is the class of finite sets. $\text{Mor}_{\mathbf{Mtd}^\circ}$ is the class of relations which satisfy the exchange axiom. More precisely, for finite sets $A, B \in \text{Ob}_{\mathbf{Mtd}^\circ}$, $\text{Mor}_{\mathbf{Mtd}^\circ}(A, B) = \text{Exch}(2^A, 2^B)$. Composition of morphisms is defined to be composition of relations. We also define a functor $\otimes : \mathbf{Mtd}^\circ \times \mathbf{Mtd}^\circ \rightarrow \mathbf{Mtd}^\circ$. For objects $A, B \in \text{Ob}_{\mathbf{Mtd}^\circ}$, $A \otimes B := A \sqcup B$; for morphisms $\lambda, \mu \in \text{Mor}_{\mathbf{Mtd}^\circ}$, $\lambda \otimes \mu := \lambda \times \mu$.

Remark 2.17. We list a few elementary properties of the category \mathbf{Mtd}° .

1. The identity relations $1_A \in \text{Mor}_{\mathbf{Mtd}^\circ}(A, A)$ are identity morphisms, and the zero relations $0_{AB} \in \text{Mor}_{\mathbf{Mtd}^\circ}(A, B)$ are zero morphisms.
2. $(\mathbf{Mtd}^\circ, \otimes)$ is a symmetric monoidal category. The monoidal unit object is $\emptyset \in \text{Ob}_{\mathbf{Mtd}^\circ}$.
3. \mathbf{Mtd}° is a \dagger -category. That is, $\lambda \mapsto \lambda^\dagger$ defines an involutive contravariant functor from \mathbf{Mtd}° to itself.
4. Similarly $\lambda \mapsto \bar{\lambda}$ defines an involutive covariant functor from \mathbf{Mtd}° to itself.
5. A morphism $\lambda \in \text{Mor}_{\mathbf{Mtd}^\circ}(A, B)$ is an isomorphism if and only if there exists a bijection $\phi : A \rightarrow B$ such that $X \mapsto_\lambda Y$ if and only if $Y = \phi(X)$. If λ is an isomorphism then λ^\dagger is its inverse.
6. $(\mathbf{Mtd}^\circ, \otimes)$ is a rigid category. The precise definition of a rigid category (\mathcal{C}, \otimes) is less strict than what we state below, but for our purposes this means:
 - (a) (\mathcal{C}, \otimes) is a monoidal category, with monoidal unit object $\mathbb{1}_{\mathcal{C}} \in \text{Ob}_{\mathcal{C}}$.
 - (b) For every object $A \in \text{Ob}_{\mathcal{C}}$, there is a dual object $A^\dagger \in \text{Ob}_{\mathcal{C}}$ such that $(A^\dagger)^\dagger = A$.
 - (c) For every object $A \in \text{Ob}_{\mathcal{C}}$, we have evaluation and coevaluation morphisms $\text{ev}_A \in \text{Mor}_{\mathcal{C}}(A \otimes A^\dagger, \mathbb{1}_{\mathcal{C}})$, and $\text{ev}_A^\dagger \in \text{Mor}_{\mathcal{C}}(\mathbb{1}_{\mathcal{C}}, A \otimes A^\dagger)$ satisfying

$$(1_A \otimes \text{ev}_A^\dagger) \circ (\text{ev}_A \otimes 1_A) = (\text{ev}_A^\dagger \otimes 1_A) \circ (1_A \otimes \text{ev}_A) = 1_A. \quad (2.1)$$

In the case of $\mathcal{C} = \mathbf{Mtd}^\circ$, each object $A = A^\dagger$ is its own dual; the *evaluation morphism* $\text{ev}_A \in \text{Mor}_{\mathbf{Mtd}^\circ}(A \otimes A, \emptyset)$ is the relation defined by $(X, Y) \mapsto_{\text{ev}_A} \emptyset$ if and only if $X = \bar{Y}$; the *coevaluation morphism* ev_A^\dagger is the adjoint of ev_A .

Remark 2.18. Given a morphism $\lambda \in \text{Mor}_{\mathbf{Mtd}^\circ}(A, B)$, evaluation and coevaluation morphisms are used to move points between the domain and the codomain of λ . Suppose $S \subseteq A$, and let $A' = A \setminus S$. Then

$$\lambda' = (\text{ev}_S^\dagger \otimes 1_{A'}) \circ (1_S \otimes \lambda) \in \text{Mor}_{\mathbf{Mtd}^\circ}(A', S \otimes B)$$

is a morphism for which the points of S have been transferred from the domain to the codomain. Similarly if $T \subseteq B$, $B'' = B \setminus T$, then

$$\lambda'' = (1_B \otimes \lambda) \circ (\text{ev}_T \otimes 1_{B''}) \in \text{Mor}_{\mathbf{Mtd}^\circ}(T \otimes A, B'')$$

is a morphism for which the points of T have been transferred from the domain to the codomain. By (2.1), these constructions are mutually inverse. The three morphisms $\lambda, \lambda', \lambda''$ are all related by the fact that they have the same associated matroid: $\alpha_\lambda = \alpha_{\lambda'} = \alpha_{\lambda''} \in \mathbb{M}(A \sqcup B)$.

Remark 2.19. In most references on matroids, the operation \otimes is thought of as a “direct sum” of matroids, and is traditionally denoted by the symbol “ \oplus ”. However, in our discussion, it makes more sense to think of it as a kind of tensor product. For example, consider the unit object \emptyset . For every finite set E , $\text{Mor}_{\mathbf{Mtd}^\circ}(\emptyset, E) = \mathbb{M}(E)$ contains a zero morphism and at least one non-zero morphism (several if $|E| > 0$); in this respect, \emptyset behaves like a 1-dimensional vector space under \otimes , not like a 0-dimensional vector space under \oplus . Formulas such as (2.1) look bizarre if \otimes is replaced by \oplus .

3 Functorial constructions

Many well-known matroid constructions are functorial. We give some examples.

Example 3.1. For a function $\phi : A \rightarrow B$, a *partial transversal* to ϕ is a pair (X, Y) with $X \subseteq A$, $Y \subseteq B$, such that ϕ restricts to a bijection $X \rightarrow Y$. Let \mathbf{FSet} be the category of finite sets (with functions as morphisms). We have an injective functor $\text{Trans} : \mathbf{FSet} \rightarrow \mathbf{Mtd}^\circ$, defined as follows. For objects $A \in \mathbf{FSet}$, $\text{Trans}(A) = A$. For morphisms $\phi \in \text{Mor}_{\mathbf{FSet}}(A, B)$, $\text{Trans}(\phi)$ is the relation in which $X \mapsto_{\text{Trans}(\phi)} Y$ if and only if (X, Y) is a partial transversal to ϕ .

Example 3.2. Let \mathbb{F} be a field. For finite sets A, B let $\text{Mat}_{A \times B}(\mathbb{F})$ be the $|A| \times |B|$ dimensional affine space of matrices over \mathbb{F} , with rows indexed by the set A , and columns indexed by the set B . For a matrix $M \in \text{Mat}_{A \times B}(\mathbb{F})$, let $\lambda_M \in \text{Rel}(2^A, 2^B)$ be the relation $X \mapsto_{\lambda_M} Y$ if and only if the minor of M with row set X and column set Y is non-zero. Then $\lambda_M \in \text{Mor}_{\mathbf{Mtd}^\circ}(A, B)$. Here λ_M is a bimatroid and we say that M *represents* λ_M . (Note that when A and B are not ordered sets, minors are only defined up to sign, but λ_M is nevertheless well-defined.)

Unfortunately, $M \mapsto \lambda_M$ does not give a functor from matrices to \mathbf{Mtd}° . This is clear from the fact that there exist invertible matrices M such that λ_M is not an isomorphism.

To rectify this problem, we can consider subvarieties instead of individual matrices. A torus-invariant subvariety of $\text{Mat}_{A \times B}(\mathbb{F})$ is a subvariety (i.e. closed, reduced, irreducible \mathbb{F} -subscheme) which is invariant under both left and right multiplication by diagonal matrices.

Let $\mathbf{TVar}(\mathbb{F})$ be the category in which objects are finite sets, and the morphisms $\text{Mor}_{\mathbf{TVar}(\mathbb{F})}(A, B)$ are the torus-invariant subvarieties of $\text{Mat}_{A \times B}(\mathbb{F})$. Composition of morphisms is defined by matrix multiplication. That is, if $\mathcal{X} \in \text{Mor}_{\mathbf{TVar}(\mathbb{F})}(A, B)$ and $\mathcal{Y} \in \text{Mor}_{\mathbf{TVar}(\mathbb{F})}(B, C)$ then $\mathcal{X} \circ \mathcal{Y}$ is the image of $\mathcal{X} \times \mathcal{Y}$ under the matrix matrix multiplication map $\text{Mat}_{A \times B}(\mathbb{F}) \times \text{Mat}_{B \times C}(\mathbb{F}) \rightarrow \text{Mat}_{A \times C}(\mathbb{F})$. The variety of diagonal matrices in $\text{Mat}_{A \times A}(\mathbb{F})$ is the identity morphism.

We have a functor $\text{Minors} : \mathbf{TVar}(\mathbb{F}) \rightarrow \mathbf{Mtd}^\circ$, defined as follows. For objects $A \in \mathbf{TVar}(\mathbb{F})$, $\text{Minors}(A) = A$. For a morphism $\mathcal{X} \in \text{Mor}_{\mathbf{TVar}(\mathbb{F})}(A, B)$, $\text{Minors}(\mathcal{X}) = \lambda_{M_0}$ where M_0 is the generic point of \mathcal{X} . Note that each non-zero minor of M_0 has a distinct torus-weight, which is why the functor Minors respects composition. The image of Minors is the class of bimatroids which are representable over the algebraic closure of \mathbb{F} .

Example 3.3. We extend Example 3.2. Recall that the exterior algebra is a functor $\wedge^\bullet : \mathbf{Vect}(\mathbb{F}) \rightarrow \mathbf{Alg}(\mathbb{F})$ from vector spaces over \mathbb{F} to associative algebras over \mathbb{F} . Let V, W be finite dimensional vector spaces over \mathbb{F} . Given $\varphi \in \wedge^\bullet(V^*) \cong (\wedge^\bullet V)^*$, and $\omega \in \wedge^\bullet(V \oplus W) \cong \wedge^\bullet V \otimes_{\mathbb{F}} \wedge^\bullet W$, we define an \mathbb{F} -linear map $L_{\varphi, \omega} \in \text{Hom}_{\mathbb{F}}(\wedge^\bullet V, \wedge^\bullet W)$,

$$L_{\varphi, \omega}(\varpi) = (\varphi \otimes_{\mathbb{F}} I_{\wedge^\bullet W})(\varpi \wedge \omega).$$

An \mathbb{F} -linear map $L \in \text{Hom}_{\mathbb{F}}(\wedge^\bullet V, \wedge^\bullet W)$ is *pure* of degree $s - t$ if $L = L_{f_1 \wedge \dots \wedge f_s, w_1 \wedge \dots \wedge w_t}$ for some vectors $f_1, \dots, f_s \in V^*$ and $w_1, \dots, w_t \in V \oplus W$. For example, if $T : V \rightarrow W$ is any linear map then the associated \mathbb{F} -algebra homomorphism $\wedge^\bullet(T) : \wedge^\bullet V \rightarrow \wedge^\bullet W$ is pure of degree 0. It is not hard to show that the composition of two pure maps is again pure.

For finite sets A, B , let $\mathbb{G}_k(A, B) \subset \text{Hom}_{\mathbb{F}}(\wedge^\bullet(\mathbb{F}^A), \wedge^\bullet(\mathbb{F}^B))$ denote the variety of pure linear maps of degree k . $\mathbb{G}_k(A, B)$ is an embedding of the affine cone over the Grassmannian $\text{Gr}_{k+|A|, |A|+|B|}(\mathbb{F})$ inside $2^{|A|+|B|}$ -dimensional affine space. Let $\{v_x \mid x \in A\}$ denote the standard basis for \mathbb{F}^A , and for $X = \{x_1, \dots, x_s\}$ let $v_X = v_{x_1} \wedge \dots \wedge v_{x_s}$, which is only well-defined up to sign. For $L \in \mathbb{G}_k(A, B)$ let $\lambda_L \in \text{Rel}(2^A, 2^B)$ be the relation in which $X \mapsto_{\lambda_L} Y$ if and only the coefficient of v_Y in $L(v_X)$ is non-zero. Then $\lambda_L \in \text{Mor}_{\mathbf{Mtd}^\circ}(A, B)$, and $\text{deg}(\lambda_L) = k$, and we say that L **represents** λ_L . For a matrix $M \in \text{Mat}_{A \times B}(\mathbb{F})$, if we regard M as a linear map $M : \mathbb{F}^A \rightarrow \mathbb{F}^B$, then $\lambda_M = \lambda_{\wedge^\bullet(M)}$. But therefore, as in Example 3.2, this construction is not functorial.

To fix this, we define a category $\mathbf{TVar}^*(\mathbb{F})$, where the objects are finite sets and $\text{Mor}_{\mathbf{TVar}^*(\mathbb{F})}(A, B)$ is the set of torus-invariant subvarieties of $\bigcup_{k \in \mathbb{Z}} \mathbb{G}_k(A, B)$. For $\mathcal{X} \in \text{Mor}_{\mathbf{TVar}^*(\mathbb{F})}(A, B)$, $\mathcal{Y} \in \text{Mor}_{\mathbf{TVar}^*(\mathbb{F})}(B, C)$, composition is defined to be $\mathcal{X} \circ \mathcal{Y} := \{K \circ L \mid K \in \mathcal{X}, L \in \mathcal{Y}\}$. We regard $\mathbf{TVar}(\mathbb{F})$ as a subcategory of $\mathbf{TVar}^*(\mathbb{F})$, by identifying $\mathcal{X} \in \text{Mor}_{\mathbf{TVar}(\mathbb{F})}(A, B)$ with $\wedge^\bullet(\mathcal{X}) := \{\wedge^\bullet(M) \mid M \in \mathcal{X}\} \in \text{Mor}_{\mathbf{TVar}^*(\mathbb{F})}(A, B)$. We can now extend the functor $\text{Minors} : \mathbf{TVar}(\mathbb{F}) \rightarrow \mathbf{Mtd}^\circ$ to a functor $\text{Minors}^* : \mathbf{TVar}^*(\mathbb{F}) \rightarrow \mathbf{Mtd}^\circ$. For objects $\text{Minors}^*(A) = A$; for morphisms $\mathcal{X} \in \text{Mor}_{\mathbf{TVar}^*(\mathbb{F})}(A, B)$, $\text{Minors}^*(\mathcal{X}) = \lambda_{L_0}$,

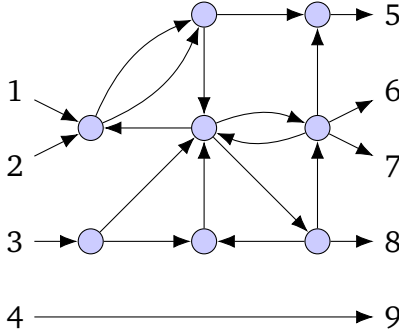

Figure 3.1: A directed graph $G \in \text{Mor}_{\mathbf{DGraph}}(\{1, 2, 3, 4\}, \{5, 6, 7, 8, 9\})$. G includes the isolated arrow $4 \rightarrow 9$.

where L_0 is the generic point of \mathcal{X} . The image of Minors^* is the class of morphisms $\lambda \in \text{Mor}_{\mathbf{Mtd}^\circ}$ that are representable over the algebraic closure of \mathbb{F} .

Example 3.4. If \mathbb{F} is an infinite field, we have a subcategory of $\mathbf{TVar}^*(\mathbb{F})$ where we take only the morphisms \mathcal{X} which have an \mathbb{F} -valued point L such that $\lambda_L = \lambda_{L_0}$. The image of Minors^* restricted to this subcategory is the class of $\lambda \in \text{Mor}_{\mathbf{Mtd}^\circ}$ that are representable over \mathbb{F} . Therefore, when \mathbb{F} is infinite, the morphisms of \mathbf{Mtd}° that are representable over \mathbb{F} form a subcategory of \mathbf{Mtd}° . We denote this subcategory $\mathbf{Mtd}^\circ(\mathbb{F})$. It is not hard to see that $(\mathbf{Mtd}^\circ(\mathbb{F}), \otimes)$ is a rigid monoidal category.

For finite fields, the preceding statements are false. For example, suppose $M \in \text{Mat}_{\{1,2,3\} \times \{1,2,3,4\}}(\mathbb{F}_2)$ has pairwise linearly independent columns. Then $\xi_{\emptyset, \{1,2,3\}}^2$ and λ_M are representable over \mathbb{F}_2 but $\xi_{\emptyset, \{1,2,3,4\}}^2 = \xi_{\emptyset, \{1,2,3\}}^2 \circ \lambda_M$ is not.

Example 3.5. Let \mathbf{DGraph} be the following category of directed graphs. The objects $\text{Ob}_{\mathbf{DGraph}}$ are finite sets. For $A, B \in \text{Ob}_{\mathbf{DGraph}}$, the morphisms $\text{Mor}_{\mathbf{DGraph}}(A, B)$ are directed graphs G in which the elements of A are half-edges pointing toward a vertex of G (sources), and the elements of B are half-edges pointing away from a vertex of G (sinks). We also allow a source in A to join directly to a sink in B without a vertex in between, forming an *isolated arrow*. Loops and parallel edges are allowed, however, the elements of $A \sqcup B$ must be the only half-edges. An example of such a graph is shown in Figure 3.1. For $G \in \text{Mor}_{\mathbf{DGraph}}(A, B)$, $H \in \text{Mor}_{\mathbf{DGraph}}(B, C)$, $G \circ H = G \sqcup_B H$ is the directed graph obtained taking the disjoint union of the two graphs, and then gluing the half-edges $B \subseteq V(G)$ to the half-edges $B \subseteq V(H)$ so that each matching pair of directed half-edges becomes a complete directed edge. (Isolated arrows are simply “absorbed” into the half-edge that they match with.) An example of composition is shown in Figure 3.2. The identity morphism on A consists of $|A|$ isolated arrows joining the half-edges of the domain to their counterparts in the codomain. \mathbf{DGraph} is a monoidal category, with disjoint union as the monoidal operation.

We have a functor $\text{Path} : \mathbf{DGraph} \rightarrow \mathbf{Mtd}^\circ$, defined as follows. For objects $A \in$

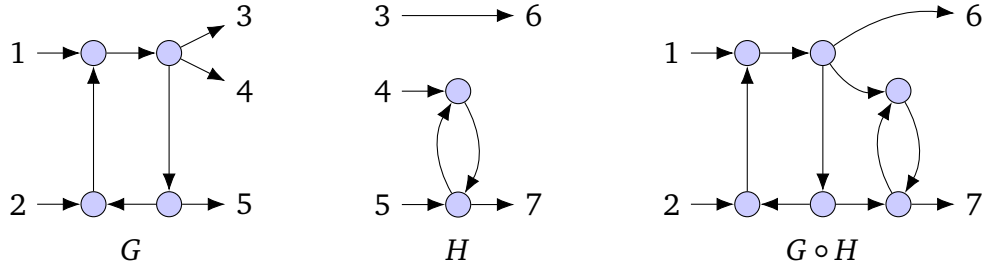

Figure 3.2: Composition in **DGraph**.

$\text{Ob}_{\mathbf{DGraph}}$, $\text{Path}(A) = A$. For morphisms $G \in \text{Mor}_{\mathbf{DGraph}}(A, B)$, $\text{Path}(G)$ is the relation in which $X \mapsto_{\text{Path}(G)} Y$ if and only if $|X| = |Y| = k$ for some k , and there exists a tuple (P_1, \dots, P_k) of vertex-disjoint directed paths such that P_i joins a half-edge in X to a half-edge in Y . $\text{Path}(G)$ is a bimatroid, as shown in [19]. This generalizes the linkage theorem [14, 18], which states that the range of $\text{Path}(G)$ is the collection of independent sets of matroid on B . The matroids obtained in this way are called **gammoids**.

Alternatively, the fact that $\text{Path}(G) \in \text{Mor}_{\mathbf{Mtd}^\circ}(A, B)$ can be seen algebraically from Talaska's generalization [20] of the Lindström–Gessel–Viennot lemma. Yet another proof can be obtained by considering the construction in the next example.

Example 3.6. We can extend **DGraph** to a rigid category **DGraph**^{*}. The objects of **DGraph**^{*} are signed finite sets, which we represent as ordered pairs of finite sets $A = (A^+, A^-)$. The morphisms are $\text{Mor}_{\mathbf{DGraph}^*}(A, B) := \text{Mor}_{\mathbf{DGraph}}(A^+ \sqcup B^-, B^+ \sqcup A^-)$. For $G \in \text{Mor}_{\mathbf{DGraph}^*}(A, B)$, the same digraph viewed element of $\text{Mor}_{\mathbf{DGraph}}(A^+ \sqcup B^-, B^+ \sqcup A^-)$ is denoted \vec{G} , and is called the **forward digraph**. We compose morphisms $G \circ H$ according to the same rule as **DGraph**: $G \circ H = G \sqcup_B H$ — the difference is that now the half-edges of B^- will be sources of G and instead of sinks of H , rather than the other way around. (Note that this is not the same as composing the forward digraphs — in fact $\vec{G} \circ \vec{H}$ is not necessarily defined.) In addition, if a set of isolated arrows in G joins up with a set of isolated arrows in H such that they form a closed loop with no vertices, we delete this loop. The monoidal structure of **DGraph**^{*} is again defined by disjoint union; for objects this means $A \otimes B := (A^+ \sqcup B^+, A^- \sqcup B^-)$. For an object $A = (A^+, A^-)$, let $A^\dagger := (A^-, A^+)$. The evaluation and coevaluation morphisms $\text{ev}_A \in \text{Mor}_{\mathbf{DGraph}^*}(A \otimes A^\dagger, \emptyset)$ and $\text{ev}_A^\dagger \in \text{Mor}_{\mathbf{DGraph}^*}(\emptyset, A \otimes A^\dagger)$ have the same forward digraph as the identity morphism on A ; these satisfy (2.1). **DGraph** is identified with the full subcategory of **DGraph**^{*}, where the objects are the pairs (A^+, \emptyset) .

The functor Path extends to a functor $\text{Path}^* : \mathbf{DGraph}^* \rightarrow \mathbf{Mtd}^\circ$.

- (a) For objects $A = (A^+, A^-)$, $\text{Path}^*(A) = A^+ \sqcup A^- \in \text{Ob}_{\mathbf{Mtd}^\circ}$.
- (b) For morphisms $G \in \text{Mor}_{\mathbf{DGraph}^*}(A, B)$, $\text{Path}^*(G) \in \text{Mor}_{\mathbf{Mtd}^\circ}(A^+ \sqcup A^-, B^+ \sqcup B^-)$ is the unique morphism with the same associated matroid as $\text{Path}(\vec{G})$.

Path^* is a rigid functor. That is, it respects \otimes and sends (co)evaluation morphisms to (co)evaluation morphisms.

A rigid functor on \mathbf{DGraph}^* is characterized by its evaluation on digraphs with a single vertex, no loops, and an arbitrary number of half-edges. Thus, $\text{Path} : \mathbf{DGraph} \rightarrow \mathbf{Mtd}^\circ$ is the unique functor with the following two properties:

- If $G \in \text{Mor}_{\mathbf{DGraph}}(A, B)$ has a single vertex, then $\text{Path}(G) = \xi_{A, V(G)}^0 \circ \xi_{V(G), B}^0$.
- Path extends to a rigid functor $\mathbf{DGraph}^* \rightarrow \mathbf{Mtd}^\circ$ via rules (a) and (b) above.

There are many variations on this theme. The first property above can be replaced by any (appropriately symmetric) rule for digraphs with a single vertex. For example, there is another functor $\text{EPath} : \mathbf{DGraph} \rightarrow \mathbf{Mtd}^\circ$, in which we consider tuples of edge-disjoint paths instead of tuples of vertex-disjoint paths. This functor is characterized by $\text{EPath}(G) = \xi_{A, B}^0$ if $G \in \text{Mor}_{\mathbf{DGraph}}(A, B)$ has a single vertex.

It is tempting to try to define a “rigid category of gammoids” as the image of the functor Path^* . However, this does not make sense, because Path^* is not one-to-one on objects. In the next example, we resolve this issue.

Example 3.7. We now modify the construction in Examples 3.5 and 3.6. Consider digraphs which are morphisms in \mathbf{DGraph} , but in addition every vertex is assigned a colour, either white or black. The colouring is not required to be proper. Let $\mathbf{BDGraph}$ denote the category with these bicoloured directed graphs as morphisms. An example is shown in Figure 3.3 (left). Like \mathbf{DGraph} , $\mathbf{BDGraph}$ can be extended to a rigid category. Hence we have a unique functor $\text{BPath} : \mathbf{BDGraph} \rightarrow \mathbf{Mtd}^\circ$ characterized (as in Example 3.6) by the following evaluations for digraphs with a single vertex: if $G \in \text{Mor}_{\mathbf{BDGraph}}(A, B)$ has a single vertex $v \in V(G)$, then

$$\text{BPath}(G) = \begin{cases} \xi_{AB}^{1-|A|} & \text{if } v \text{ is coloured white} \\ \xi_{AB}^{|B|-1} & \text{if } v \text{ is coloured black.} \end{cases} \quad (3.1)$$

We note four facts about this functor.

- Using the rigid structure of \mathbf{Mtd}° , we can see that changing the orientations of the (full) edges of G does not change $\text{BPath}(G)$. Furthermore, the associated matroid $\alpha_{\text{BPath}(G)}$ does not even depend on the orientations of the half-edges.
- G is said to be *perfectly oriented* [15] if every white vertex of G has a unique incoming edge or half-edge, and every black vertex of G has a unique outgoing edge or half-edge (see Figure 3.3 (right)). If G is perfectly oriented then $\text{BPath}(G) = \text{Path}(G)$.
- If G is not perfectly oriented, and there is way to change the orientations of the edges and half-edges of G so that it becomes perfectly oriented, then $\text{BPath}(G) = 0_{AB}$.
- For any uncoloured digraph $G \in \text{Mor}_{\mathbf{DGraph}}(A, B)$, one can construct a perfectly oriented bicoloured digraph $G^{\bullet\circ} \in \text{Mor}_{\mathbf{BDGraph}}(A, B)$ such that $\text{Path}(G) = \text{BPath}(G^{\bullet\circ})$.

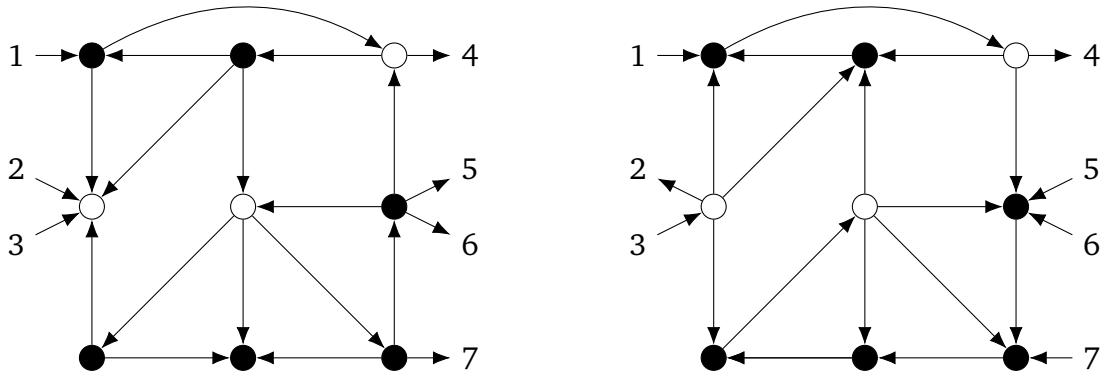

Figure 3.3: A bicoloured directed graph $G \in \text{Mor}_{\text{BDGraph}}(\{1, 2, 3\}, \{4, 5, 6, 7\})$ (left). The orientations of the edges and half-edges of G can be changed to give a perfect orientation (right).

To form G° we replace each vertex of G by a black and white pair, as shown in Figure 3.4.

Let $(\mathbf{Gam}^{\circ}, \otimes)$ be the monoidal subcategory of $(\mathbf{Mtd}^{\circ}, \otimes)$ defined by the image of the functor $\text{BPath} : \mathbf{BDGraph} \rightarrow \mathbf{Mtd}^{\circ}$. It is not hard to show that \mathbf{Gam}° contains all evaluation and coevaluation morphisms of the category \mathbf{Mtd}° , and therefore $(\mathbf{Gam}^{\circ}, \otimes)$ is a rigid category. In fact $(\mathbf{Gam}^{\circ}, \otimes)$ is the smallest monoidal subcategory of $(\mathbf{Mtd}^{\circ}, \otimes)$ that is rigid and contains the image of the functor Path . As such, \mathbf{Gam}° is the appropriate analogue of the category \mathbf{Mtd}° for gammoids.

Example 3.8. Positroids are a special class of matroids, arising in the theory of total positivity. The definition requires the set of points to be totally ordered. We write $E = (e_1, \dots, e_n)$ to mean the set $\{e_1, \dots, e_n\}$ with total ordering $e_1 < \dots < e_n$. Let $E^{\dagger} = (e_n, \dots, e_1)$ denote the opposite ordering.

If D, E are totally ordered finite sets, and $M \in \text{Mat}_{D \times E}(\mathbb{R})$, then for each pair of subsets $X \subseteq D, Y \subseteq E$, with $|X| = |Y|$, we have a well-defined minor $M_{XY} \in \mathbb{R}$ (no longer just well-defined up to sign). A matroid (E, α) is called a **positroid** if there exists a matrix $M \in \text{Mat}_{D \times E}(\mathbb{R})$, such that $|D| \leq |E|$, $M_{DY} \geq 0$ for all $Y \subseteq E$ with $|Y| = |D|$, and $Y \in \alpha$ if and only if $M_{DY} > 0$.

We define a monoidal category $(\mathbf{Pos}^{\circ}, \otimes)$ as follows. $\text{Ob}_{\mathbf{Pos}^{\circ}}$ is the class of totally ordered finite sets. For $A = (a_1, \dots, a_n), B = (b_1, \dots, b_m), A \otimes B := (a_1, \dots, a_n, b_1, \dots, b_m)$. $\text{Mor}_{\mathbf{Pos}^{\circ}}(A, B)$ is the subset of morphisms $\lambda \in \text{Mor}_{\mathbf{Mtd}^{\circ}}(A, B)$ such that α_{λ} is a positroid on $A^{\dagger} \otimes B$, or $\lambda = 0_{AB}$. For morphisms $\lambda, \mu \in \text{Mor}_{\mathbf{Pos}^{\circ}}, \lambda \otimes \mu := \lambda \times \mu$. It is not immediately clear that the morphisms of \mathbf{Pos}° are closed under composition, but this will be explained below.

The category \mathbf{Pos}° has much of the same structure as \mathbf{Mtd}° . If $\lambda \in \text{Mor}_{\mathbf{Pos}^{\circ}}(A, B)$, then $\lambda^{\dagger} \in \text{Mor}_{\mathbf{Pos}^{\circ}}(B^{\dagger}, A^{\dagger})$. The functor $\dagger : \mathbf{Pos}^{\circ} \rightarrow \mathbf{Pos}^{\circ}$ is a contravariant involution. For each

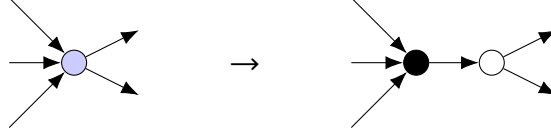

Figure 3.4: Converting a directed graph G into a bicoloured directed graph $G^{\circ\circ}$.

$A \in \text{Ob}_{\mathbf{Pos}^\circ}$, we have canonical morphisms $\text{ev}_A \in \text{Mor}_{\mathbf{Pos}^\circ}(A \otimes A^\dagger, \emptyset)$, defined (as in \mathbf{Mtd}°) by the relation $(X, Y) \mapsto_{\text{ev}_A} \emptyset$ if and only if $X = \overline{Y}$. \mathbf{Pos}° is a rigid category with evaluation and coevaluation morphisms given by ev_A and ev_A^\dagger , which satisfy (2.1). However, \mathbf{Pos}° is not a symmetric monoidal category (or even a braided monoidal category), since we do not have natural braiding isomorphisms $A \otimes B \leftrightarrow B \otimes A$.

We give three examples of functors to \mathbf{Pos}° ; a fourth is discussed in Remark 3.10.

- A matrix $M \in \text{Mat}_{A \times B}(\mathbb{R})$ is **totally non-negative** if and only if $M_{XY} \geq 0$ for all minors. Totally non-negative matrices form a category: let \mathbf{Mat}^+ be the category in which $\text{Ob}_{\mathbf{Mat}^+}$ is the class of totally ordered finite sets, and $\text{Mor}_{\mathbf{Mat}^+}(A, B) \subseteq \text{Mat}_{A \times B}(\mathbb{R})$ is the set of totally non-negative matrices with rows indexed by A and columns indexed by B , with composition defined by matrix multiplication. $M \mapsto \lambda_M$ defines a functor from \mathbf{Mat}^+ to \mathbf{Pos}° .
- Consider the construction in Example 3.5 applied to plane digraphs. Let $\mathbf{PDGraph}$ be the category in which objects are totally ordered finite sets, and the morphisms $\text{Mor}_{\mathbf{PDGraph}}(A, B)$ are directed graphs embedded in the plane, with half-edges $A \sqcup B$ appearing in the order

$$a_n, \dots, a_1, b_1, \dots, b_m$$

clockwise along the outer face. For example, if we take the graph G in Figure 3.1 together with its plane embedding, then $G \in \text{Mor}_{\mathbf{PDGraph}}((1, 2, 3), (4, 5, 6, 7))$. The construction from Example 3.5 applied to this context gives a functor $\text{Path} : \mathbf{PDGraph} \rightarrow \mathbf{Pos}^\circ$. This follows from the Lindström–Gessel–Viennot lemma [5, 8].

- Consider the construction in Example 3.7 applied to plane bicoloured digraphs. Let $\mathbf{PBDGraph}$ be the category in which the objects are totally ordered finite sets, and the morphisms are as in $\mathbf{PDGraph}$ but in addition the vertices are bicoloured. For example, if we take the graph G in Figure 3.3 with its plane embedding, then $G \in \text{Mor}_{\mathbf{PBDGraph}}((1, 2, 3), (4, 5, 6, 7))$. Such graphs are called **plabic graphs**. The construction from Example 3.7 gives a functor $\text{BPath} : \mathbf{PBDGraph} \rightarrow \mathbf{Pos}^\circ$. Indeed, properties (a)–(c) imply that this functor realizes one of Postnikov’s fundamental constructions of positroids (positroids via plabic graphs) [15], and in particular $\text{BPath} : \mathbf{PBDGraph} \rightarrow \mathbf{Pos}^\circ$ is surjective. This establishes that the morphisms of \mathbf{Pos}° are closed under composition.

Example 3.9. Our final example is concerned with stable polynomials; we refer the reader to the survey [21] for detailed background.

For a finite set $A = \{a_1, \dots, a_n\}$, let $\mathbf{z}_A = \{z_{a_1}, \dots, z_{a_n}\}$, be a set of formal indeterminates indexed by A , and let $\mathbb{C}[\mathbf{z}_A] = \mathbb{C}[z_{a_1}, \dots, z_{a_n}]$. For any subset $X \subseteq A$ let $\mathbf{z}^X = \prod_{a \in X} z_a \in \mathbb{C}[\mathbf{z}_A]$. The vector space of *multiaffine polynomials* in $\mathbb{C}[\mathbf{z}_A]$ is $\mathbb{C}^{\text{MA}}[\mathbf{z}_A] := \text{span}\{\mathbf{z}^X \mid X \subseteq A\}$.

A non-zero polynomial $f = f(\mathbf{z}_A)$ is *stable* if the evaluation of f at every point in \mathcal{H}^A is non-zero, where $\mathcal{H} = \{w \in \mathbb{C} \mid \text{Im}(w) > 0\}$ denotes the upper half-plane in \mathbb{C} . The zero polynomial is also, by convention, considered to be stable. A \mathbb{C} -linear map $\phi : \mathbb{C}^{\text{MA}}[\mathbf{z}_A] \rightarrow \mathbb{C}^{\text{MA}}[\mathbf{z}_B]$ is a (multiaffine) *stability preserver* if $\phi(f) \in \mathbb{C}^{\text{MA}}[\mathbf{z}_B]$ is stable whenever $f \in \mathbb{C}[\mathbf{z}_A]$ is stable. In addition, we say that ϕ is *homogeneous* if $\phi \equiv 0$, or there is an integer $k \in \mathbb{Z}$ such that for all $X \subseteq A$, $\phi(\mathbf{z}^X)$ is a homogeneous polynomial of degree $|X| + k$. Finally, we need to eliminate some trivial cases: we say that ϕ is a *true stability preserver* if it extends $\mathbb{C}[z']$ -linearly to a stability preserver $\phi : \mathbb{C}^{\text{MA}}[\mathbf{z}_A] \otimes \mathbb{C}^{\text{MA}}[z'] \rightarrow \mathbb{C}^{\text{MA}}[\mathbf{z}_B] \otimes \mathbb{C}^{\text{MA}}[z']$ in one additional variable. All interesting stability preservers are true — every non-true stability preserver is just a rank-one projection [1] (see also [17, Prop. 2.5]).

Homogeneous stability preservers form a category, **HSP**, in which the objects are finite sets, and $\text{Mor}_{\text{HSP}}(A, B)$ is the set of true homogeneous stability preservers $\phi : \mathbb{C}^{\text{MA}}[\mathbf{z}_A] \rightarrow \mathbb{C}^{\text{MA}}[\mathbf{z}_B]$. Composition is defined to be ordinary composition of linear maps.

We have a functor $\text{Supp} : \text{HSP} \rightarrow \mathbf{Mtd}^\circ$, defined as follows. For objects we have $\text{Supp}(A) = A$. For morphisms $\phi \in \text{Mor}_{\text{HSP}}(A, B)$, let $\text{Supp}(\phi)$ be the relation defined by $X \mapsto_{\text{Supp}(\phi)} Y$ if and only if the coefficient of \mathbf{z}^Y in $\phi(\mathbf{z}^X)$ is non-zero. The relation $\text{Supp}(\phi)$ is called the *support* of ϕ .

This construction works because of a combination of three major theorems. First, a landmark theorem of Borcea and Brändén [1, Theorem 1.1] states that ϕ is a (true) stability preserver if and only if a related polynomial $S(\phi) \in \mathbb{C}[\mathbf{z}_{A \sqcup B}]$ is itself stable. $S(\phi)$ is called the *symbol* of ϕ . When ϕ is a homogeneous linear map, $S(\phi)$ is a homogeneous polynomial. Second, a theorem of Choe, Oxley, Sokal and Wagner [3, Theorem 7.1] states that the support of homogeneous stable polynomial must be a matroid. Combining these implies that $\text{Supp}(\phi) \in \text{Exch}(2^A, 2^B)$. Finally, the Phase Theorem [3, Theorem 6.1] asserts that there exists a complex number $\gamma \in \mathbb{C}^\times$ such that all coefficients of $\gamma S(\phi)$ are non-negative real numbers. This in turn implies that for all $X \subseteq A$, all coefficients of $\gamma \phi(\mathbf{z}^X)$ are non-negative. Therefore, when two stability preservers are composed, the supports compose precisely as relations.

Remark 3.10. Both Example 3.3 and Example 3.9 involve spaces of linear maps between vector spaces of dimensions $2^{|A|}$ and $2^{|B|}$. Taking $\mathbb{F} = \mathbb{C}$, and working with a totally ordered finite sets, we can identify the spaces $\wedge^\bullet(\mathbb{C}^A)$ and $\mathbb{C}^{\text{MA}}[\mathbf{z}_A]$, and thus consider morphisms which are both homogeneous true stability preservers, and contained in $\mathbb{G}_k(A, B)$, for some k . The the main result of [17] implies that this intersection is the “non-negative part” of $\bigcup_{k \in \mathbb{Z}} \mathbb{G}_k(A, B)$. The restriction of Supp to this intersection category gives a surjective functor to \mathbf{Pos}° .

Remark 3.11. The categories $\mathbf{TVar}^*(\mathbb{F})$ and \mathbf{HSP} can both be endowed with the structure of a rigid monoidal category, which makes the functors Minors^* and Supp rigid functors. In $\mathbf{TVar}^*(\mathbb{F})$, the monoidal structure is given by disjoint union on objects, and $\otimes_{\mathbb{F}}$ on morphisms, where we identify $\wedge^{\bullet}(\mathbb{F}^A) \otimes_{\mathbb{F}} \wedge^{\bullet}(\mathbb{F}^B) \equiv \wedge^{\bullet}(\mathbb{F}^{A \sqcup B})$. Each object $A = A^{\dagger}$ is own dual; the evaluation morphism ev_A is the torus-orbit closure of the linear map $\wedge^{\bullet}(\mathbb{F}^A) \otimes_{\mathbb{F}} \wedge^{\bullet}(\mathbb{F}^A) \rightarrow \mathbb{F}$, $\omega \otimes_{\mathbb{F}} \varpi \mapsto [v_A] \omega \wedge \varpi$; coevaluation is the torus-orbit closure of the dual map. The structures on \mathbf{HSP} on are defined similarly.

Remark 3.12. Lorentzian polynomials [2] are an extension of the class of homogeneous stable polynomials, and have many similar properties. In particular:

- The support of a multiaffine Lorentzian polynomial is a matroid.
- If ϕ is a linear transformation of polynomials, and the symbol $S(\phi)$ is Lorentzian, then ϕ maps Lorentzian polynomials to Lorentzian polynomials.

However, since this is not a complete characterization of linear maps preserving the Lorentzian property, it is not immediately clear if there is an analogue of Example 3.9 for Lorentzian polynomials. We pose this as an open question.

4 Hom-functor and related categories

In this section we recall some basic constructions in category theory, and apply them to the category \mathbf{Mtd}° .

For any locally small category \mathcal{C} , and any object $S \in \text{Ob}_{\mathcal{C}}$, we obtain a covariant functor $\text{Hom}_{\mathcal{C}}(S, -) : \mathcal{C} \rightarrow \mathbf{Set}$, called the *covariant hom-functor*. For objects $A \in \text{Ob}_{\mathcal{C}}$, $\text{Hom}_{\mathcal{C}}(S, A) = \text{Mor}_{\mathcal{C}}(S, A)$ is the set of morphisms from S to A , while for a morphism $\lambda \in \text{Mor}_{\mathcal{C}}(A, B)$, $\text{Hom}_{\mathcal{C}}(S, \lambda)$ is the function $\lambda_{\circ} : \text{Hom}_{\mathcal{C}}(S, A) \rightarrow \text{Hom}_{\mathcal{C}}(S, B)$,

$$\lambda_{\circ}(\mu) = \mu \circ \lambda.$$

When $\mathcal{C} = \mathbf{Mtd}^{\circ}$, the covariant hom-functor is injective for every object S . Thus by considering the image of $\text{Hom}_{\mathbf{Mtd}^{\circ}}(S, -)$, we can reinterpret \mathbf{Mtd}° as a more familiar type of category, in which the objects are sets (of matroids), and the morphisms are certain functions between these sets. Each such function is a “matroid transformation”: it transforms a matroid in the domain into a matroid in the codomain, according to some rule, which is also controlled by a matroid.

Proposition 4.1. *For any set $S \in \text{Ob}_{\mathbf{Mtd}^{\circ}}$, $\text{Hom}_{\mathbf{Mtd}^{\circ}}(S, -)$ is an injective functor. That is if $\lambda, \mu \in \text{Mor}_{\mathbf{Mtd}^{\circ}}(A, B)$ are distinct morphisms then $\lambda_{\circ}, \mu_{\circ} : \text{Mor}_{\mathbf{Mtd}^{\circ}}(S, A) \rightarrow \text{Mor}_{\mathbf{Mtd}^{\circ}}(S, B)$ are distinct functions.*

Proof. For $X \subseteq A$, let $\lambda_X = \lambda_{\circ}(\epsilon^{\emptyset, X})$. Then $\emptyset \mapsto_{\lambda_X} Y$ if and only if $X \mapsto_{\lambda} Y$. Thus, we recover λ from λ_{\circ} . \square

We can also form a related category \mathbf{Mtd}_S° , in which the objects are pairs (A, μ) with $\mu \in \text{Hom}_{\mathbf{Mtd}^\circ}(S, A)$, and for objects (A, μ) and (B, ν) , $\text{Mor}_{\mathbf{Mtd}_S^\circ}((A, \mu), (B, \nu)) = \{\lambda \in \text{Mor}_{\mathbf{Mtd}^\circ}(A, B) \mid \lambda_\circ(\mu) = \nu\}$. The objects can be regarded as matroids on some set of the form $S \sqcup E$, and we call these *matroids with base S* .

In the case of $S = \emptyset$, the objects of the category $\mathbf{Mtd}_\emptyset^\circ$ are pairs (A, μ) where A is a finite set, and $\mu \in \text{Mor}_{\mathbf{Mtd}^\circ}(\emptyset, S) = \text{Exch}(2^\emptyset, 2^A)$. We identify (A, μ) with the matroid (A, α_μ) , and for $\lambda \in \text{Mor}_{\mathbf{Mtd}^\circ}(A, B)$ write $\lambda_\circ(\alpha_\mu) := \alpha_{\lambda_\circ(\mu)}$. This implicitly defines a notion of a morphism between two matroids, which we now unpack.

Proposition 4.2. *Let $\alpha \in \mathbb{M}(A)$, $\beta \in \mathbb{M}(B)$ be (possibly zero) matroids. A morphism λ between α and β in the category $\mathbf{Mtd}_\emptyset^\circ$ is a relation $\lambda \in \text{Exch}(2^A, 2^B)$ such that:*

- (a) if $X \in \alpha$ and $X \mapsto_\lambda Y$ then $Y \in \beta$;
- (b) for every $Y \in \beta$ there exists $X \in \alpha$ such that $X \mapsto_\lambda Y$. □

Remark 4.3. Many variations on the category $\mathbf{Mtd}_\emptyset^\circ$ can be formed. For example, one can restrict the class of objects, e.g. by excluding the zero matroids. Alternatively, one can enlarge the category by allowing morphisms that satisfy condition (a), but not necessarily condition (b) of Proposition 4.2. However, these constructions are somewhat unnatural from the point of view of the category \mathbf{Mtd}° , and so we will not study them further, here.

A *pointed matroid* is a triple (E, z_0, α) , where (E, α) is matroid, and $z_0 \in E$ is a distinguished point. If $S = \{z_0\}$ is a singleton set, the objects of $\mathbf{Mtd}_{\{z_0\}}^\circ$ are identified with pointed matroids. Specifically, the pointed matroid (E, z_0, α) is identified with the morphism $\mu \in \text{Mor}_{\mathbf{Mtd}^\circ}(\{z_0\}, E - z_0)$, where for $Y \subseteq E - z_0$, $\{z_0\} \mapsto_\mu Y$ if $Y \in \alpha$, and $\emptyset \mapsto_\mu Y$ if $Y + z_0 \in \alpha$. In some references, the distinguished point of a pointed matroid is required to have additional special properties, but here we are not imposing any such requirement.

Proposition 4.4. *Let (A, z_0, α) and (B, z_0, β) be pointed matroids on sets A, B , where $z_0 \in A \cap B$ is the distinguished point. A morphism λ between α and β in the category $\mathbf{Mtd}_{\{z_0\}}^\circ$ is a relation $\lambda \in \text{Exch}(2^A, 2^B)$ such that conditions (a) and (b) of Proposition 4.2 hold, and also*

- (c) for all $X \mapsto_\lambda Y$, we have $z_0 \in X$ if and only if $z_0 \in Y$. □

Remark 4.5. We note that these categories are substantially different from the matroid categories considered by Heunen and Patta [6], where the objects are the matroids and morphisms are strong maps. The constructions are nevertheless related. Consider the subcategory of \mathbf{Mtd}_S° in which we restrict the class of morphisms to bimatroids. [7, Theorem 4] effectively describes a functor from this subcategory to the category of matroids with strong maps. A natural (and likely not too difficult) question is: does this functor extend to all of \mathbf{Mtd}_S° ?

Let S, T be finite sets. For any $\kappa \in \text{Mor}_{\mathbf{Mtd}^\circ}(S, T)$, we obtain a natural transformation κ° between the functors $\text{Mor}_{\mathbf{Mtd}^\circ}(S, -)$ and $\text{Mor}_{\mathbf{Mtd}^\circ}(T, -)$: for $A \in \text{Ob}_{\mathbf{Mtd}^\circ}$, $\kappa^\circ : \text{Mor}_{\mathbf{Mtd}^\circ}(S, A) \rightarrow \text{Mor}_{\mathbf{Mtd}^\circ}(T, A)$ is defined to be the function

$$\kappa^\circ(\mu) = \bar{\kappa}^\dagger \circ \mu.$$

We call κ° a **base change** transformation. Yoneda's lemma asserts that all natural transformations between $\text{Mor}_{\mathbf{Mtd}^\circ}(S, -)$ and $\text{Mor}_{\mathbf{Mtd}^\circ}(T, -)$ are of this form.

Alternatively, κ° can be regarded as a functor $\kappa^\circ : \mathbf{Mtd}_S^\circ \rightarrow \mathbf{Mtd}_T^\circ$. For objects $\mu \in \text{Ob}_{\mathbf{Mtd}_S^\circ}$, $\kappa^\circ(\mu) = \bar{\kappa}^\dagger \circ \mu \in \text{Ob}_{\mathbf{Mtd}_T^\circ}$. For morphisms $\text{Mor}_{\mathbf{Mtd}_S^\circ} = \text{Mor}_{\mathbf{Mtd}_T^\circ}$, κ° sends any morphism to itself.

Example 4.6. Consider the morphism $\rho_S \in \text{Mor}_{\mathbf{Mtd}^\circ}(S \otimes S, S)$ defined by $(X, Y) \mapsto_{\rho_S} Z$ if and only if $X \cup Y = S$ and $X \cap Y = Z$. We define a functor $\otimes_S : \mathbf{Mtd}_S^\circ \times \mathbf{Mtd}_S^\circ \rightarrow \mathbf{Mtd}_S^\circ$, as the composition of the functors $\otimes : \mathbf{Mtd}_S^\circ \times \mathbf{Mtd}_S^\circ \rightarrow \mathbf{Mtd}_{S \otimes S}^\circ$ and $\rho_S^\circ : \mathbf{Mtd}_{S \otimes S}^\circ \rightarrow \mathbf{Mtd}_S^\circ$. With this definition, $(\mathbf{Mtd}_S^\circ, \otimes_S)$ is a symmetric monoidal category. For both objects and morphisms we have $\deg(\mu \otimes_S \nu) = \deg(\mu) + \deg(\nu)$, and the monoidal unit object is $\xi_{S, \emptyset}^0 \in \text{Ob}_{\mathbf{Mtd}_S^\circ}$. This construction works because $(\rho_S, \xi_{S, \emptyset}^0)$ is a (commutative) monoid in the category \mathbf{Mtd}° .

We can define a second functor $\bar{\otimes}_S : \mathbf{Mtd}_S^\circ \times \mathbf{Mtd}_S^\circ \rightarrow \mathbf{Mtd}_S^\circ$, using $\bar{\rho}_S$ in place of ρ_S . $(\mathbf{Mtd}_S^\circ, \bar{\otimes}_S)$ is also a symmetric monoidal category. In this case, $\deg(\mu \bar{\otimes}_S \nu) = \deg(\mu) + \deg(\nu) - |S|$, and the monoidal unit object is $\xi_{S, \emptyset}^{-|S|} \in \text{Ob}_{\mathbf{Mtd}_S^\circ}$. The functors \otimes_S and $\bar{\otimes}_S$ are related by $\mu \bar{\otimes}_S \nu = \overline{\mu \otimes_S \nu}$.

Note, however, that base change transformations do not respect either monoidal structure. That is, typically, $\kappa^\circ(\mu \otimes_S \nu) \neq \kappa^\circ(\mu) \otimes_T \kappa^\circ(\nu)$ and $\kappa^\circ(\mu \bar{\otimes}_S \nu) \neq \kappa^\circ(\mu) \bar{\otimes}_T \kappa^\circ(\nu)$, as can be seen from the fact that the two sides do not necessarily have the same degree.

5 Deletion, contraction, and symmetrization

In this section, we explain why deletion and contraction (as they are usually defined) are nearly, but not quite morphisms in the category \mathbf{Mtd}° . We then discuss symmetrization, which is a more general construction, and symmetric matroids. We begin by defining related operations, which we will refer to as *strict deletion*, and *strict contraction*.

Let E be a finite set, and let $e \in E$. Consider the morphisms

$$\delta^e := 1_{E-e} \otimes \xi_{\{e\}, \emptyset}^0 \quad \text{and} \quad \chi^e := 1_{E-e} \otimes \xi_{\{e\}, \emptyset}^{-1}$$

in $\text{Mor}_{\mathbf{Mtd}^\circ}(E, E - e)$. Equivalently δ^e is the relation defined by $X \mapsto_{\delta^e} Y$ if and only if $X = Y \subseteq E - e$, and χ^e is defined by $X \mapsto_{\chi^e} Y$ if and only if $X = Y + e$, $Y \subseteq E - e$. Note that $\delta^e = \overline{\chi^e}$.

Definition 5.1. Let $\alpha \in \mathbb{M}(E)$. The **strict deletion** of e is $\alpha \setminus e := \delta^e(\alpha) = \alpha \circ \delta^e$. The **strict contraction** of e is $\alpha // e := \chi^e(\alpha) = \alpha \circ \chi^e$. More explicitly $\alpha \setminus e = \{X \subseteq E - e \mid X \in \alpha\}$, and $\alpha // e = \{X \subseteq E - e \mid X + e \in \alpha\}$.

Thus, in the category $\mathbf{Mtd}_\emptyset^\circ$, δ^e is a morphism from α to $\alpha \setminus e$, and χ^e is a morphism from α to $\alpha // e$.

Proposition 5.2. For $e, f \in E$, $e \neq f$, we have

$$\delta^e \circ \delta^f = \delta^f \circ \delta^e \quad \delta^e \circ \chi^f = \chi^f \circ \delta^e \quad \chi^e \circ \chi^f = \chi^f \circ \chi^e. \quad \square$$

Strict deletion and contraction can also be viewed as base change transformations.

Proposition 5.3. If $\delta = \delta^{z_0}$ and $\chi = \chi^{z_0} \in \text{Mor}_{\mathbf{Mtd}^\circ}(\{z_0\}, \emptyset)$ the associated change of base transformations δ° and χ° are $\delta^\circ(\alpha) = \alpha \setminus z_0$ and $\chi^\circ(\alpha) = \alpha // z_0$, for every pointed matroid (E, z_0, α) . \square

Deletion and contraction are almost the same as strict deletion and strict contraction, with a small but significant difference. Suppose (E, α) is a matroid. A point $e \in E$ is a **loop** of α if $e \in \overline{X}$ for all $X \in \alpha$; e is a **coloop** of α if e is a loop of $\overline{\alpha}$. Equivalently, e is a loop of α if and only if $\alpha // e$ is the zero matroid, e is a coloop of α if and only if $\alpha \setminus e$ is the zero matroid. On the other hand deletion and contraction never produce the zero matroid (unless applied to the zero matroid itself).

Definition 5.4. Let $\alpha \in \mathbb{M}(E)$. The **deletion** of e is $\alpha \setminus e \in \mathbb{M}(E - e)$, and the **contraction** of e is $\alpha / e \in \mathbb{M}(E - e)$, where

$$\alpha \setminus e := \begin{cases} \alpha \setminus e & \text{if } e \text{ is not a coloop of } \alpha \\ \alpha // e & \text{if } e \text{ is a coloop of } \alpha, \end{cases} \quad \alpha / e := \begin{cases} \alpha // e & \text{if } e \text{ is not a loop of } \alpha \\ \alpha \setminus e & \text{if } e \text{ is a loop of } \alpha. \end{cases}$$

There are various other ways to define of deletion and contraction which do not explicitly involve two cases. Nevertheless, the dichotomy is always present and is connected to the behaviour of the rank: either $\text{rank}(\alpha \setminus e) = \text{rank}(\alpha)$ or $\text{rank}(\alpha \setminus e) = \text{rank}(\alpha) - 1$, and likewise for contraction. Thus, deletion and contraction cannot be defined by morphisms in the category \mathbf{Mtd}° , since for any morphism $\lambda \in \text{Mor}_{\mathbf{Mtd}^\circ}$, $\text{rank}(\lambda_\circ(\alpha)) = \text{deg}(\lambda) + \text{rank}(\alpha)$. Similarly, by Yoneda's lemma, they are not natural transformations between the functors $\text{Mor}_{\mathbf{Mtd}^\circ}(\{z_0\}, -)$, and functors $\text{Mor}_{\mathbf{Mtd}^\circ}(\emptyset, -)$. In the next section, we introduce the category \mathbf{Mtd}^\bullet which resolves these discrepancies.

In the remainder of the section, we discuss some examples of related constructions.

Example 5.5. A **minor** (F, β) of a matroid (E, α) is a matroid obtained by performing a sequence of deletions and contractions. Equivalently, there is a sequence of strict deletions and strict contractions to obtain any minor. Any such sequence determines a morphism from (E, α) to (F, β) in the category $\mathbf{Mtd}_\emptyset^\circ$, which is independent of the order in which deletions/contractions are performed. Note: this does not mean that there is a “canonical morphism” from a matroid to any given minor, since different choices of which points to delete/contract may produce the same matroid.

Example 5.6. Other well-known matroid constructions, such as 2-sum, parallel connection, and series connection (see e.g. [13, §7.1]), have similar interpretations in the category \mathbf{Mtd}° . The operation 2-sum takes a pair of pointed matroids (A, x_0, α) , (B, y_0, β) , and produces a matroid, while series and parallel connection take a pair of pointed matroids and produce another pointed matroid. Specifically, if $C = (A - x_0) \sqcup (B - y_0)$, then the **2-sum** of α and β is (C, γ) , the **parallel connection** is $(C + z_0, z_0, \gamma')$, and the **series connection** is $(C + z_0, z_0, \gamma'')$, where

$$\begin{aligned}\gamma &= (\alpha \otimes \beta) \circ (1_C \otimes \xi_{\{x_0, y_0\}, \emptyset}^{-1}) \\ \gamma' &= (\alpha \otimes \beta) \circ (1_C \otimes \xi_{\{x_0, y_0\}, \{z_0\}}^{-1}) \\ \gamma'' &= (\alpha \otimes \beta) \circ (1_C \otimes \xi_{\{x_0, y_0\}, \{z_0\}}^0).\end{aligned}$$

These operations come with the same caveat as strict deletion and contraction, namely for some inputs they produce the zero matroid. This is normally not considered to be a major problem; nevertheless the category \mathbf{Mtd}° will tell us the canonical way to fix it.

Alternatively, if we think of pointed matroids as objects μ, ν of the category $\mathbf{Mtd}_{\{z_0\}}^\circ$, then their parallel connection is $\mu \otimes_{\{z_0\}} \nu$, their series connection is $\mu \bar{\otimes}_{\{z_0\}} \nu$, and their 2-sum is $\delta^\circ(\mu \otimes_{\{z_0\}} \nu) = \chi^\circ(\mu \bar{\otimes}_{\{z_0\}} \nu)$. These operations are natural transformations between the functors

$$\mathrm{Hom}_{\mathbf{Mtd}^\circ}(\{z_0\}, -) \times \mathrm{Hom}_{\mathbf{Mtd}^\circ}(\{z_0\}, -) \quad \text{and} \quad \mathrm{Hom}_{\mathbf{Mtd}^\circ}(S, - \otimes -)$$

from $\mathbf{Mtd}^\circ \times \mathbf{Mtd}^\circ \rightarrow \mathbf{Set}$, where $S = \emptyset$ in the case of 2-sum, and $S = \{z_0\}$ in the case of parallel and series connection.

The preceding constructions are all special cases of symmetrization.

Definition 5.7. A matroid (E, α) is **symmetric** on $S \subseteq E$ if every permutation of S is an automorphism of α . A morphism $\lambda \in \mathrm{Mor}_{\mathbf{Mtd}^\circ}(A, B)$ is symmetric on S , if $S \subseteq A$ or $S \subseteq B$, and α_λ is symmetric on S .

Example 5.8. Suppose E, T are finite sets, $S \subseteq E$ and $E' = (E \setminus S) \sqcup T$. For $k \in \mathbb{Z}$, $\sigma = 1_{E \setminus S} \otimes \xi_{ST}^k \in \mathrm{Mor}_{\mathbf{Mtd}^\circ}(E, E')$ is a **symmetrization morphism**. For any matroid $\alpha \in \mathbb{M}(E)$, σ transforms α — symmetrically in S — into the matroid $\sigma_\circ(\alpha) \in \mathbb{M}(E')$, which is symmetric on T . When $S = T$, $k = 0$, $\sigma_\circ(\alpha)$ is the smallest matroid that is symmetric on S , such that $\alpha \leq \sigma_\circ(\alpha)$. Symmetrization can also be regarded as the base change transformation associated to ξ_{ST}^k .

Example 5.9. We define a rigid monoidal category $(\mathbf{SMtd}^\circ, \otimes)$, of “symmetric matroids”. The objects of \mathbf{SMtd}° are tuples of finite sets. For objects $A = (A_1, \dots, A_n)$, and $B = (B_1, \dots, B_m)$, $\mathrm{Mor}_{\mathbf{SMtd}^\circ}(A, B)$ is the subset of $\mathrm{Mor}_{\mathbf{Mtd}^\circ}(A_1 \otimes \dots \otimes A_n, B_1 \otimes \dots \otimes B_m)$ of morphisms that are symmetric on each of the subsets $A_1, \dots, A_n, B_1, \dots, B_m$. We define $A \otimes B := (A_1, \dots, A_n, B_1, \dots, B_m)$, and for morphisms \otimes is defined as in \mathbf{Mtd}° . It is not

hard to see that the morphisms of \mathbf{SMtd}° are closed under composition. The identity morphism on A in \mathbf{SMtd}° is the symmetrization morphism

$$1_A^{\mathbf{SMtd}^\circ} = \zeta_{A_1, A_1}^0 \otimes \cdots \otimes \zeta_{A_n, A_n}^0.$$

Each object $A = A^\dagger$ is its own dual. The evaluation morphism $\text{ev}_A^{\mathbf{SMtd}^\circ} \in \text{Mor}_{\mathbf{SMtd}^\circ}(A \otimes A, \emptyset)$ is $\text{ev}_A^{\mathbf{SMtd}^\circ} = (1_A^{\mathbf{SMtd}^\circ} \otimes 1_A^{\mathbf{SMtd}^\circ}) \circ \text{ev}_{A_1 \otimes \cdots \otimes A_n}$; coevaluation is the adjoint morphism.

For a point $e \in A_i$, the morphisms χ^e and δ^e are not symmetric, and therefore not in \mathbf{SMtd}° . However, strict deletion and contraction are realized in \mathbf{SMtd}° by the symmetrization morphisms

$$\zeta_{A_1, A_1}^0 \otimes \cdots \otimes \zeta_{A_i, A_i - e}^d \otimes \cdots \otimes \zeta_{A_n, A_n}^0,$$

for $d = 0$ and $d = -1$ respectively. In particular \mathbf{SMtd}° is closed under deletion and contraction.

Example 5.10. We now consider symmetric matroids from a different perspective. Write \mathbb{Z}^E for the set of all functions $p : E \rightarrow \mathbb{Z}$. For a subset $S \subseteq E$, the characteristic function of S is the function $\psi_S \in \mathbb{Z}^E$, where $\psi_S(x) = 1$ if $x \in S$, and $\psi_S(x) = 0$ otherwise. An *M-convex set* on a finite set E is a subset $\Gamma \subseteq \mathbb{Z}^E$ satisfying the following exchange axiom:

- If $p, q \in \Gamma$, $e \in E$ are such that $p(e) > q(e)$, then there exists $f \in E$ such that

$$p(f) < q(f) \quad \text{and} \quad p - \psi_{\{e\}} + \psi_{\{f\}} \in \Gamma.$$

For example, if (E, α) is a matroid, the characteristic functions of the bases form an M-convex set on E . See [10] for additional background on M-convex sets.

We extend this concept to relations. For a relation $\Lambda \in \text{Rel}(\mathbb{Z}^E, \mathbb{Z}^F)$, let

$$\Gamma_\Lambda := \{(-p, q) \in \mathbb{Z}^E \times \mathbb{Z}^F \mid p \mapsto_\Lambda q\}.$$

We'll say that Λ is an *M-convex relation* if Γ_Λ is an M-convex set on $E \sqcup F$. Let $\text{Exch}(\mathbb{Z}^E, \mathbb{Z}^F)$ denote the set of all M-convex relations in $\text{Rel}(\mathbb{Z}^E, \mathbb{Z}^F)$.

For $\Lambda \in \text{Rel}(\mathbb{Z}^E, \mathbb{Z}^F)$ and $(p_0, q_0) \in \mathbb{Z}^E \times \mathbb{Z}^F$, the *translation* of Λ by (p_0, q_0) is the relation $\Lambda' \in \text{Rel}(\mathbb{Z}^E, \mathbb{Z}^F)$ defined by $p \mapsto_{\Lambda'} q$ if and only if $p - p_0 \mapsto_\Lambda q - q_0$. Clearly, Λ is M-convex if and only if any translation of Λ is M-convex. For $k, l \geq 0$, let $\Lambda(k, l) \in \text{Rel}(\mathbb{Z}^E, \mathbb{Z}^F)$ be the relation where $p \mapsto_{\Lambda(k, l)} q$ if and only if $p \mapsto_\Lambda q$ and $\|p\|_\infty \leq k$, $\|q\|_\infty \leq l$. Then Λ is M-convex if and only if $\Lambda(k, l)$ is M-convex for all $k, l \geq 0$. Λ is *bounded* if $\Lambda = \Lambda(k, l)$ for some $k, l \geq 0$. Bounded M-convex sets are essentially the same mathematical objects as integral polymatroids [4], or integral generalized permutohedra [16].

For a non-negative integer n , let $[n] := \{1, \dots, n\}$. For $A = (A_1, \dots, A_n)$ and $B = (B_1, \dots, B_m)$ as in Example 5.9, and $\mu \in \text{Mor}_{\mathbf{SMtd}^\circ}(A, B)$, define the *skeleton* of μ to

be the relation $\text{Skel}(\mu) \in \text{Rel}(\mathbb{Z}^{[n]}, \mathbb{Z}^{[m]})$, where $p \mapsto_{\text{Skel}(\mu)} q$ if and only if there exists $(X_1, \dots, X_n) \mapsto_{\mu} (Y_1, \dots, Y_m)$ such that $p(i) = |X_i|$ and $q(j) = |Y_j|$, for $i = 1, \dots, n$, $j = 1, \dots, m$. Then $\text{Skel}(\mu)$ is a bounded M-convex relation, and up to translation, every bounded M-convex relation is this form. We can therefore think of M-convex relations as limits of morphisms in \mathbf{SMtd}° . To be more precise, let $[k]^{\otimes n}$ denote the n -tuple $([k], [k], \dots, [k]) \in \text{Ob}_{\mathbf{SMtd}^\circ}$. M-convex relations correspond to double sequences $(\mu_{k,l})_{k,l \geq 0}$ such that $\mu_{k,l} \in \text{Mor}_{\mathbf{SMtd}^\circ}([2k]^{\otimes n}, [2l]^{\otimes m})$ where $\mu_{k-1,l}$ is obtained from $\mu_{k,l}$ by deleting all the points labelled $2k$ in the domain and contracting all the points labelled $2k-1$ in the domain, and $\mu_{k,l-1}$ is obtained from $\mu_{k,l}$ by deleting all the points labelled $2l$ in the codomain and contracting all the points labelled $2l-1$ in the codomain. Specifically, such a sequence represents the unique $\Lambda \in \text{Exch}(\mathbb{Z}^{[n]}, \mathbb{Z}^{[m]})$ such that for all $k, l \geq 0$, $\Lambda(k, l)$ is the translation of $\text{Skel}(\mu_{k,l})$ by $(-k, \dots, -k, -l, \dots, -l)$. Note that if Λ, Θ correspond to the sequences $(\mu_{k,l})_{k,l \geq 0}, (\nu_{k,l})_{k,l \geq 0}$, then $\Lambda \circ \Theta$ corresponds to the sequence $(\lambda_{k,l})_{k,l \geq 0}$, where $\lambda_{k,l} = \max\{\mu_{k,s} \circ \nu_{s,l} \mid s \geq 0\}$. (The maximum is well-defined in the category \mathbf{SMtd}° , since $\mu_{k,s} \circ \nu_{s,l} \leq \mu_{k,s+1} \circ \nu_{s+1,l}$.)

From these observations we see that M-convex relations form another rigid monoidal category, which we denote $(\mathbf{MConv}^\circ, \otimes)$. The objects of \mathbf{MConv}° are finite sets and for $E, F \in \text{Ob}_{\mathbf{MConv}^\circ}$, $\text{Mor}_{\mathbf{MConv}^\circ}(E, F) = \text{Exch}(\mathbb{Z}^E, \mathbb{Z}^F)$; composition of morphisms is given by composition of relations. The empty relation in $\text{Rel}(\mathbb{Z}^E, \mathbb{Z}^F)$ is a zero-morphism, and we denote it by 0_{EF} . As with \mathbf{Mtd}° , the functor $\otimes : \mathbf{MConv}^\circ \rightarrow \mathbf{MConv}^\circ$ is given by disjoint union for objects, and \times for relations. The evaluation morphism $\text{ev}_E : \text{Mor}_{\mathbf{MConv}^\circ}(E \otimes E, \emptyset)$ is the relation $(p, q) \mapsto_{\text{ev}_E} \varepsilon$ if and only if $p + q = 0$, and the co-evaluation morphism ev_E^\dagger is the adjoint relation. (Here ε denotes the unique element of \mathbb{Z}^\emptyset .)

6 Lax composition

We now attempt to fix the fact that deletion and contraction are not morphisms in the category \mathbf{Mtd}° , by modifying the definition of composition. We define a new composition operation \bullet , by a relaxation of the definition of \circ . Going forward, since the term ‘‘composition’’ is now ambiguous, we shall refer to the operation \circ as *strict composition* or *o-composition*, and to \bullet as *lax composition* or *bullet-composition*. Using lax composition, we construct a new rigid monoidal category \mathbf{Mtd}^\bullet , in which deletion and contraction are morphisms. Furthermore, the category \mathbf{Mtd}^\bullet does not have any zero morphisms.

6.1 The category \mathbf{Mtd}^\bullet

Recall that if $\lambda \in \text{Rel}(2^A, 2^B)$, $\mu \in \text{Rel}(2^B, 2^C)$, then $X \mapsto_{\lambda \circ \mu} Z$ if and only if there exists Y such that $X \mapsto_{\lambda} Y \mapsto_{\mu} Z$. If no triples X, Y, Z with $X \mapsto_{\lambda} Y \mapsto_{\mu} Z$ exist, then $\lambda \circ \mu = 0_{AC}$. Lax composition operation avoids this possibility by relaxing the criterion $X \mapsto_{\lambda} Y \mapsto_{\mu} Z$.

Write $\text{Rel}^\times(2^A, 2^B) := \text{Rel}(2^A, 2^B) \setminus \{0_{AB}\}$, and $\text{Exch}^\times(2^A, 2^B) := \text{Exch}(2^A, 2^B) \setminus \{0_{AB}\}$.

Definition 6.1. Let $\lambda \in \text{Rel}^\times(2^A, 2^B)$, $\mu \in \text{Rel}^\times(2^B, 2^C)$. For each non-negative integer m , let $\lambda \bullet_m \mu \in \text{Rel}(2^A, 2^C)$ be the relation defined by $X \mapsto_{\lambda \bullet_m \mu} Z$ if and only if there exist $Y, Y' \subseteq B$ such that $X \mapsto_\lambda Y'$, $Y \mapsto_\mu Z$ and $|Y \Delta Y'| = m$. Let m_0 be the smallest non-negative integer such that $\lambda \bullet_{m_0} \mu \neq 0_{AC}$ and define the **lax composition** $\lambda \bullet \mu := \lambda \bullet_{m_0} \mu$. The number m_0 is called the **total type** of $\lambda \bullet \mu$ and we write $|\lambda : \mu| := m_0$.

In particular if $|\lambda : \mu| = 0$ then $\lambda \bullet \mu = \lambda \circ \mu$. However, if $|\lambda : \mu| \neq 0$, then $\lambda \circ \mu = 0_{AC}$, whereas by construction $\lambda \bullet \mu \neq 0_{AC}$.

As an operation on all relations, lax composition is not associative. However, when we restrict to relations that satisfy the exchange axiom, \bullet becomes a well-defined, well-behaved, associative operation. To understand why this works, we make the following more refined definition.

Definition 6.2. Let $\lambda \in \text{Rel}^\times(2^A, 2^B)$, $\mu \in \text{Rel}^\times(2^B, 2^C)$. For each pair of non-negative integers (k, l) , let $\lambda \bullet_{k,l} \mu \in \text{Rel}(2^A, 2^C)$ be the relation defined by $X \mapsto_{\lambda \bullet_{k,l} \mu} Z$ if and only if there exist $Y, Y' \subseteq B$ such that $X \mapsto_\lambda Y'$, $Y \mapsto_\mu Z$, $|Y \setminus Y'| = k$, $|Y' \setminus Y| = l$. Let $m_0 = |\lambda : \mu|$ be the total type of $\lambda \bullet \mu$. We say that $\lambda \bullet \mu$ has a **definite type**, if there exists a unique pair of non-negative integers (k_0, l_0) such that $k_0 + l_0 = m_0$ and $\lambda \bullet_{k_0, l_0} \mu \neq 0_{AC}$. If this condition holds, then

$$\lambda \bullet \mu = \lambda \bullet_{k_0, l_0} \mu.$$

The pair (k_0, l_0) is called the **type** of $\lambda \bullet \mu$, and we write $\langle \lambda : \mu \rangle := (k_0, l_0)$.

When $\lambda \bullet \mu$ has a definite type, it can be expressed in terms of strict composition.

Proposition 6.3. Suppose $\lambda \in \text{Rel}^\times(2^A, 2^B)$, $\mu \in \text{Rel}^\times(2^B, 2^C)$. Let $\eta \in \text{Exch}^\times(2^B, 2^B)$ be the covering relation from Example 2.8. Let $\eta^{k,l}$ be any \circ -composition of k factors of η , and l factors of η^\dagger , with the factors in any order.

- (i) For all $k, l \geq 0$, we have $\lambda \bullet_{k,l} \mu \leq \lambda \circ \eta^{k,l} \circ \mu$.
- (ii) If $\lambda \circ \eta^{k,l} \circ \mu \neq 0_{AC}$ then $|\lambda : \mu| \leq k + l$.
- (iii) $\lambda \bullet \mu$ has type (k, l) if and only if $k + l = |\lambda : \mu|$ and

$$\lambda \circ \eta^{k,l} \circ \mu = \lambda \bullet \mu. \quad \square$$

We can now formally state the main theorem about lax composition.

Theorem 6.4. If $\lambda \in \text{Exch}^\times(2^A, 2^B)$, $\mu \in \text{Exch}^\times(2^B, 2^C)$, $\nu \in \text{Exch}^\times(2^C, 2^D)$, then:

- (i) $\lambda \bullet \mu$ has a definite type, and hence,

$$\lambda \bullet \mu \in \text{Exch}^\times(2^A, 2^C).$$

- (ii) $(\lambda \bullet \mu) \bullet \nu = \lambda \bullet (\mu \bullet \nu)$

(iii) Types are additive under association:

$$\langle \lambda \bullet \mu : \nu \rangle + \langle \lambda : \mu \rangle = \langle \mu : \nu \rangle + \langle \lambda : \mu \bullet \nu \rangle.$$

The proof of Theorem 6.4 is deferred: part (i) is proved in Section 9, and parts (ii) and (iii) are proved in Section 10. We give a strengthening of part (i) in Section 7 (Theorem 7.1). In the meantime, we use lax composition to define the category \mathbf{Mtd}^\bullet .

Definition 6.5. Let \mathbf{Mtd}^\bullet be the category in which $\text{Ob}_{\mathbf{Mtd}^\bullet}$ is the class of finite sets, and for $A, B \in \text{Ob}_{\mathbf{Mtd}^\bullet}$, $\text{Mor}_{\mathbf{Mtd}^\bullet}(A, B) = \text{Exch}^\times(2^A, 2^B)$ is the set of non-zero relations which satisfy the exchange axiom. Composition of morphisms is given by the operation \bullet . We define the monoidal structure $\otimes : \mathbf{Mtd}^\bullet \times \mathbf{Mtd}^\bullet \rightarrow \mathbf{Mtd}^\bullet$ as in the category \mathbf{Mtd}° .

Remark 6.6. The category \mathbf{Mtd}^\bullet has all of properties of \mathbf{Mtd}° described in Remark 2.17, with the exception that \mathbf{Mtd}^\bullet has no zero morphisms.

Example 6.7. Let \mathbb{F} be an infinite field. Recall from Example 3.4 that the matroids representable over \mathbb{F} define a rigid subcategory $\mathbf{Mtd}^\circ(\mathbb{F})$ of \mathbf{Mtd}° . The covering relations η are representable over any infinite field. Therefore, by Proposition 6.3 the class of non-zero morphisms of $\mathbf{Mtd}^\circ(\mathbb{F})$ is closed under \bullet -composition. Hence we have a rigid subcategory $\mathbf{Mtd}^\bullet(\mathbb{F})$ of \mathbf{Mtd}^\bullet , where the morphisms are the non-zero morphisms of $\mathbf{Mtd}^\circ(\mathbb{F})$, and composition of morphisms is defined by \bullet . As with \circ , this is false for finite fields.

Example 6.8. Similarly, for gammoids (see Example 3.7), we can define a rigid category $(\mathbf{Gam}^\bullet, \otimes)$, in which the morphisms are non-zero morphisms of \mathbf{Gam}° , and composition of morphisms is given by \bullet . As in Example 6.7 this follows from Proposition 6.3, using the fact that the covering relations are in the category \mathbf{Gam}° ,

We give an example of a non-trivial (and reasonably natural) functor to \mathbf{Gam}^\bullet . First, we extend the category \mathbf{DGraph}^* (see Example 3.6) to a larger category $\mathbf{EDGraph}^*$, which allows graphs with extra half-edges that are not in the domain or codomain of the morphism. Define $\mathbf{EDGraph}^*$ as follows: $\text{Ob}_{\mathbf{EDGraph}^*} = \text{Ob}_{\mathbf{DGraph}^*}$ is the class of signed finite sets; a morphism $G \in \text{Mor}_{\mathbf{EDGraph}^*}(A, B)$ is a pair $G = (S_G, K_G)$, where $S_G = (S_G^+, S_G^-) \in \text{Ob}_{\mathbf{DGraph}^*}$ and $K_G \in \text{Mor}_{\mathbf{DGraph}^*}(A \otimes S_G, B)$ is a directed graph. (The elements of S_G are the aforementioned “extra half-edges”.) We compose morphisms according to the same basic rule as \mathbf{DGraph}^* : for $G \in \text{Mor}_{\mathbf{EDGraph}^*}(A, B)$, $H \in \text{Mor}_{\mathbf{EDGraph}^*}(B, C)$ $G \circ H = (S_G \otimes S_H, K_G \sqcup_B K_H)$. \mathbf{DGraph}^* is identified with the subcategory of $\mathbf{EDGraph}^*$ of morphisms of the form $G = (\emptyset, G)$.

We also extend the monoidal functor: for objects, $\otimes : \mathbf{EDGraph}^* \times \mathbf{EDGraph}^* \rightarrow \mathbf{EDGraph}^*$ is the same as for \mathbf{DGraph}^* ; for morphisms, $G \otimes H = (S_G \otimes S_H, K_G \otimes K_H)$. The monoidal category $(\mathbf{EDGraph}^*, \otimes)$ is rigid, with the (co)evaluation morphisms inherited from $(\mathbf{DGraph}^*, \otimes)$.

Now define a rigid functor $\text{Path}^\bullet : \mathbf{EDGraph}^* \rightarrow \mathbf{Gam}^\bullet$, as follows. For objects, $\text{Path}^\bullet(A) := \text{Path}^*(A) = A^+ \sqcup A^-$, which is A regarded as an unsigned set (to avoid cumbersome notation we will write $\text{Path}^\bullet(A) = A$, though it is worth remembering that

this is not actually an identity map). For a morphism $G \in \text{Mor}_{\text{EDGraph}^*}(A, B)$, we have $\text{Path}^*(K_G) \in \text{Mor}_{\mathbf{Gam}^\bullet}(A \otimes S_G, B)$; we define $\text{Path}^\bullet(G) \in \text{Mor}_{\mathbf{Gam}^\bullet}(A, B)$ to be

$$\text{Path}^\bullet(G) := (1_A \otimes \xi_{\emptyset, S_G^+}^{|S_G^+|} \otimes \xi_{\emptyset, S_G^-}^0) \bullet \text{Path}^*(K_G).$$

The associated matroid of $\text{Path}^\bullet(G)$ is the minor of the associated matroid of $\text{Path}^*(K_G)$ obtained by deleting all points in S_G^+ (extra sources) and contracting all points in S_G^- (extra sinks). This corresponds to considering tuples of vertex-disjoint paths in K_G in which the maximum possible number of sources and sinks in S_G are saturated. For example, the definition of a gammoid on an finite set E (see in Example 3.5) amounts to a matroid of the form $\text{Path}^\bullet(G)$, where $G \in \text{Mor}_{\text{EDGraph}^*}(\emptyset, E)$ and $S_G^- = \emptyset$. Note that Path^\bullet does not define a functor to \mathbf{Gam}° . The functoriality of $\text{Path}^\bullet : \text{EDGraph}^* \rightarrow \mathbf{Gam}^\bullet$ is a consequence of Theorem 6.4(ii).

Example 6.9. Consider the categories \mathbf{SMtd}° and \mathbf{MConv}° defined in Examples 5.9 and 5.10. By Proposition 6.3, lax composition gives a well-defined, associative operation on the non-zero morphisms of \mathbf{SMtd}° , and hence also on the non-zero morphisms of \mathbf{MConv}° (as the latter can be regarded as sequences in the former). We therefore have rigid monoidal categories $(\mathbf{SMtd}^\bullet, \otimes)$ and $(\mathbf{MConv}^\bullet, \otimes)$, where the objects are finite sets, the morphisms are the non-zero morphisms of \mathbf{SMtd}° and \mathbf{MConv}° respectively, and \bullet is the composition operation.

For \mathbf{MConv}^\bullet , we now describe \bullet more explicitly. For $\Lambda \in \text{Rel}(\mathbb{Z}^E, \mathbb{Z}^F)$, $\Theta \in \text{Rel}(\mathbb{Z}^F, \mathbb{Z}^G)$, let $\Lambda \bullet_m \Theta$ be the relation where $p \mapsto_{\Lambda \bullet_m \Theta} r$ if there exists $q, q' \in \mathbb{Z}^F$, such that

$$p \mapsto_{\Lambda} q', \quad q \mapsto_{\Theta} r, \quad \text{and} \quad \|q - q'\|_1 = m. \quad (6.1)$$

$\Lambda \bullet \Theta := \Lambda \bullet_{m_0} \Theta$, where m_0 is the least non-negative integer such that $\Lambda \bullet_{m_0} \Theta \neq 0_{EG}$.

For $s \in \mathbb{Z}^F$, let $s^+, s^- \in \mathbb{Z}^F$ denote the functions

$$s^+(f) = \max(s(f), 0) \quad s^-(f) = \min(s(f), 0).$$

If Λ and Θ are M-convex then $\Lambda \bullet \Theta$ has a well-defined type (k, l) , characterized by the following property: whenever (6.1) holds for $m = m_0$, we have $k = \|(q - q')^+\|_1$ and $l = \|(q - q')^-\|_1$.

6.2 Deletion and contraction in \mathbf{Mtd}^\bullet and related categories

As with \mathbf{Mtd}° , we may consider the covariant hom-functor, $\text{Hom}_{\mathbf{Mtd}^\bullet}(S, -)$, for a fixed finite set S . For a morphism $\lambda \in \text{Mor}_{\mathbf{Mtd}^\bullet}(A, B)$, we write $\text{Hom}_{\mathbf{Mtd}^\bullet}(S, \lambda) = \lambda_\bullet$, where $\lambda_\bullet : \text{Mor}_{\mathbf{Mtd}^\circ}(S, A) \rightarrow \text{Mor}_{\mathbf{Mtd}^\circ}(S, B)$, is the function defined by

$$\lambda_\bullet(\mu) = \mu \bullet \lambda$$

for $\mu \in \text{Mor}_{\mathbf{Mtd}^\circ}(S, A)$. Let \mathbf{Mtd}_S^\bullet be the category in which $\text{Ob}_{\mathbf{Mtd}_S^\bullet}$ is the class of morphisms of \mathbf{Mtd}^\bullet with domain S , and $\text{Mor}_{\mathbf{Mtd}_S^\bullet}(\mu, \nu)$ is the set of morphisms λ such that

$\lambda_\bullet(\mu) = \nu$. In particular if $S = \emptyset$ we obtain a category in which the objects themselves are matroids, and the zero matroid is now naturally excluded. We note that we now have a functor

$$\text{Type} : \mathbf{Mtd}_S^\bullet \rightarrow \mathbb{Z} \times \mathbb{Z},$$

where we regard the additive group $\mathbb{Z} \times \mathbb{Z}$ as a category with one object. The functor Type sends all objects of \mathbf{Mtd}_S^\bullet to the unique object of $\mathbb{Z} \times \mathbb{Z}$, and for $\lambda \in \text{Mor}_{\mathbf{Mtd}_S^\bullet}(\mu, \nu)$, $\text{Type}(\lambda) = \langle \mu : \lambda \rangle \in \mathbb{Z} \times \mathbb{Z}$.

Proposition 6.10. *If $|S| \geq 1$, then the covariant hom-functor $\text{Hom}_{\mathbf{Mtd}^\bullet}(S, -)$ is injective.*

Proof. Suppose $\lambda \in \text{Mor}_{\mathbf{Mtd}^\bullet}(A, B)$. We show that it is possible to recover λ from λ_\bullet .

Fix an element $s \in S$. For each pair (x, X) , with $X \subseteq A$, $x \in X$, consider the relation $\sigma_{x,X} \in \text{Hom}_{\mathbf{Mtd}^\bullet}(S, A) = \text{Mor}_{\mathbf{Mtd}^\bullet}(\{s\} \otimes (S-s), \{x\} \otimes (A-x))$, $\sigma_{x,X} = \xi_{\{s\}, \{x\}}^0 \otimes \epsilon^{\emptyset, X-x}$. We have $X \mapsto_\lambda Y$ if and only if the following conditions hold: for all $x \in X$, $\{s\} \mapsto_{\lambda_\bullet(\sigma_{x,X})} Y$, and for all $x \in \overline{X}$, $\emptyset \mapsto_{\lambda_\bullet(\sigma_{x,x})} Y$. \square

For $\kappa \in \text{Mor}_{\mathbf{Mtd}^\bullet}(T, S)$, we define base change transformations κ^\bullet between the functors $\text{Hom}_{\mathbf{Mtd}^\bullet}(S, -)$ and $\text{Hom}_{\mathbf{Mtd}^\bullet}(T, -)$. For any object $A \in \text{Ob}_{\mathbf{Mtd}^\bullet}$, $\kappa^\bullet : \text{Mor}_{\mathbf{Mtd}^\bullet}(S, A) \rightarrow \text{Mor}_{\mathbf{Mtd}^\bullet}(T, A)$ is the function

$$\kappa^\bullet(\mu) = \overline{\kappa}^\dagger \bullet \mu.$$

Alternatively, we can regard κ^\bullet as a functor $\kappa^\bullet : \mathbf{Mtd}_S^\bullet \rightarrow \mathbf{Mtd}_T^\bullet$.

Example 6.11. The construction in Example 4.6 works equally well for the category \mathbf{Mtd}^\bullet . Hence $(\mathbf{Mtd}_S^\bullet, \otimes_S)$ is a monoidal category, where $\otimes_S : \mathbf{Mtd}_S^\bullet \times \mathbf{Mtd}_S^\bullet \rightarrow \mathbf{Mtd}_S^\bullet$ is the composition of functors \otimes and ρ_S^\bullet .

The category \mathbf{Mtd}^\bullet fixes the earlier problem with deletion and contraction. Deletion and contractions are defined by δ^e , χ^e , working in the category \mathbf{Mtd}^\bullet .

Proposition 6.12. *Let (E, α) be a matroid, and $e \in E$. Then $\delta_\bullet^e(\alpha) = \alpha \setminus e$, and $\chi_\bullet^e(\alpha) = \alpha / e$.* \square

Similarly, considering pointed matroids, deletion and contraction are given by base change transformations.

Proposition 6.13. *If $\delta = \delta^{z_0}$ and $\chi = \chi^{z_0} \in \text{Mor}_{\mathbf{Mtd}^\bullet}(\{z_0\}, \emptyset)$ then $\delta^\bullet(\alpha) = \alpha \setminus z_0$ and $\chi^\bullet(\alpha) = \alpha / z_0$ for every pointed matroid (E, z_0, α) .* \square

7 Structure theorem

In this section we prove a theorem that gives a finer description of the structure of lax composition. Recall the partial identity relations θ_A^{PQ} , defined in Example 2.9.

Theorem 7.1. Suppose $\lambda \in \text{Mor}_{\mathbf{Mtd}^\bullet}(A, B)$, $\mu \in \text{Mor}_{\mathbf{Mtd}^\bullet}(B, C)$, and $\lambda \bullet \mu$ has type (k, l) . Then there exist disjoint sets $K, L \subseteq B$ with $|K| = k$, $|L| = l$ such that

$$\lambda \bullet \mu = \lambda \circ \theta_B^{K,L} \circ \mu. \quad (7.1)$$

Furthermore, if $K, L \subseteq B$ are disjoint with $|K| = k$, $|L| = l$, and $\lambda \circ \theta_B^{K,L} \circ \mu \neq 0_{AC}$, then (7.1) holds.

Example 7.2. Let $M \in \text{Mat}_{A \times B}(\mathbb{F})$ be a matrix of rank r , with rows and columns indexed A and B . For subsets $X \subseteq A$, $Y \subseteq B$, let $M[X, Y] \in \text{Mat}_{X \times Y}(\mathbb{F})$ denote the submatrix of M specified by row set X and column set Y . Let $\lambda_M \in \text{Mor}_{\mathbf{Mtd}^\bullet}(A, B)$ be as in Example 3.2. The **column matroid** of M is the matroid (B, α) such that $Y \in \alpha$ if and only if $\text{rank } M[A, Y] = |Y| = r$, (i.e. Y is a maximal linearly independent subset of the columns). The column matroid can be expressed in terms of λ_M as $\xi_{\emptyset, A}^{|A|} \bullet \lambda_M$, which is a \bullet -composition of type $(0, |A| - r)$.

Theorem 7.1 asserts that there exists $L \subseteq A$, $|L| = |A| - r$, such that

$$\xi_{\emptyset, A}^m \bullet \lambda_M = \xi_{\emptyset, A}^m \circ \theta_A^{\emptyset, L} \circ \lambda_M = \xi_{\emptyset, \bar{L}}^r \circ \lambda_{M[\bar{L}, B]},$$

and moreover this holds for L if and only if $|L| = |A| - r$ and the right hand side above is non-zero. Indeed, this is a well-known fact from linear algebra: the matrices M and $M[\bar{L}, B]$ have the same linearly independent columns if and only if \bar{L} is a spanning subset of the rows of M .

Example 7.3. For positroids (see Example 3.8), we define a monoidal category $(\mathbf{Pos}^\bullet, \otimes)$ as follows. $\text{Ob}_{\mathbf{Pos}^\bullet} := \text{Ob}_{\mathbf{Pos}^\circ}$ is the class of totally ordered finite sets, and $\text{Mor}_{\mathbf{Pos}^\bullet}(A, B) := \text{Mor}_{\mathbf{Pos}^\circ}(A, B) \setminus \{0_{AB}\}$. Composition of morphisms is given by \bullet . The functor $\otimes : \mathbf{Pos}^\bullet \times \mathbf{Pos}^\bullet \rightarrow \mathbf{Pos}^\bullet$ is defined as in \mathbf{Pos}° .

We now show that \mathbf{Pos}^\bullet is closed under composition of morphisms. We cannot use the same technique as Examples 6.7–6.9, since \mathbf{Pos}° does not contain the covering relations and is not even closed under \circ -composition with the covering relations. Instead we use Theorem 7.1. First, note that the partial identity relations are morphisms in the category \mathbf{Pos}° . To see this, observe that if $A = (a_1, \dots, a_n)$, then

$$\theta_A^{P,Q} = \xi_{\{a_1\}, \{a_1\}}^{d_1} \otimes \cdots \otimes \xi_{\{a_n\}, \{a_n\}}^{d_n},$$

where $d_i \in \{-1, 0, 1\}$. Each factor $\xi_{\{a_i\}, \{a_i\}}^{d_i}$ is a positroid, and therefore so is $\theta_A^{P,Q}$. Hence, Theorem 7.1 tells us that any \bullet -composition in \mathbf{Pos}^\bullet can be reexpressed as a \circ -composition in \mathbf{Pos}° . Since \mathbf{Pos}° is closed under composition of morphisms, so is \mathbf{Pos}^\bullet .

The category \mathbf{Pos}^\bullet has many of the same properties as \mathbf{Mtd}^\bullet , and \mathbf{Pos}° ; for example $(\mathbf{Pos}^\bullet, \otimes)$ is rigid. Furthermore, for any totally ordered finite set E , and $e \in E$, $\delta^e, \chi^e \in \text{Mor}_{\mathbf{Pos}^\bullet}(E, E - e)$, and hence deletion and contraction for positroids are given by morphisms in the category \mathbf{Pos}^\bullet .

Example 7.4. For the category \mathbf{MConv}^\bullet (see Example 6.9), Theorem 7.1 has the following analogue, in which the partial identity operators are replaced by translation operators:

Theorem 7.5. Let $\Lambda \in \text{Mor}_{\mathbf{MConv}^\bullet}(E, F)$, $\Theta \in \text{Mor}_{\mathbf{MConv}^\bullet}(F, G)$, and suppose $\Lambda \bullet \Theta$ has type (k, l) . For $s \in \mathbb{Z}^F$, let $T_s \in \text{Rel}(\mathbb{Z}^F, \mathbb{Z}^F)$ be the translation operator: $q' \mapsto_{T_s} q$ if and only if $q = q' + s$. Then there exists $s \in \mathbb{Z}^F$ such that $k = \|s^+\|_1$, $l = \|s^-\|_1$ and $\Lambda \bullet \Theta = \Lambda \circ T_s \circ \Theta$. Furthermore, this last equation holds for any s such that $k = \|s^+\|_1$, $l = \|s^-\|_1$ and $\Lambda \circ T_s \circ \Theta \neq 0_{EG}$. \square

In order to prove Theorem 7.1, we begin by showing that \bullet interacts sensibly with the monoidal structure of \mathbf{Mtd}^\bullet .

Lemma 7.6. Let A, B, C, D be finite sets, $\lambda \in \text{Mor}_{\mathbf{Mtd}^\bullet}(A, B \otimes D)$, $\mu \in \text{Mor}_{\mathbf{Mtd}^\bullet}(B, C)$. Let $\eta^{k,l} \in \text{Mor}_{\mathbf{Mtd}^\bullet}(B, B)$ be as in Proposition 6.3. Suppose $\lambda \bullet (\mu \otimes 1_D)$ has type (k, l) . Then

$$\lambda \bullet (\mu \otimes 1_D) = \lambda \circ ((\eta^{k,l} \circ \mu) \otimes 1_D).$$

In particular, note that $\eta^{k,l} \circ \mu \neq 0_{BC}$.

Proof. Let $\nu = \lambda \bullet (\mu \otimes 1_D)$, and $\nu' = \lambda \circ ((\eta^{k,l} \circ \mu) \otimes 1_D)$. Then $X \mapsto_\nu Z$ if and only if there exists $Y, Y' \subseteq B \sqcup D$ such that $X \mapsto_\lambda Y'$, $Y \mapsto_{\mu \otimes 1_D} Z$, $|Y' \setminus Y| = k$, $|Y \setminus Y'| = l$. On the other hand $X \mapsto_{\nu'} Z$ if and only if there exists $Y_B, Y'_B \subseteq B$ such that $X \mapsto_\lambda (Y'_B, Z \cap D)$, $Y'_B \mapsto_\mu Z \cap C$, where $|Y'_B \setminus Y_B| = k$, $|Y_B \setminus Y'_B| = l$.

Clearly $X \mapsto_{\nu'} Z$ implies $X \mapsto_\nu Z$, as we may take $Y = (Y_B, Z \cap D)$, $Y' = (Y'_B, Z \cap D)$. Now suppose $X \mapsto_\nu Z$, and Y, Y' are as above. If there exists $y \in (Y' \setminus Y) \cap D$ then we have $Y + z \mapsto_{\mu \otimes 1_D} Z + z$, $|(Y + z) \Delta Y'| < k + l$, contradicting the definition of type (k, l) . Similarly if there exists $y \in (Y \setminus Y') \cap D$ then the same reasoning applies for $Y - z \mapsto_{\mu \otimes 1_D} Z - z$. Therefore $Y \cap D = Y' \cap D$, and taking $Y_B = Y \cap B$, $Y'_B = Y' \cap B$ shows that $X \mapsto_{\nu'} Z$. \square

Now consider a more general set-up. Let E_0, E_1, \dots, E_{m+1} be finite sets, not necessarily disjoint, and suppose we have morphisms

$$\mu_i \in \text{Mor}_{\mathbf{Mtd}^\bullet}(E_i \setminus E_{i+1}, E_{i+1} \setminus E_i) \quad \text{for } i = 0, \dots, m. \quad (7.2)$$

Let $\hat{\mu}_i := \mu_i \otimes 1_{E_i \cap E_{i+1}} \in \text{Mor}_{\mathbf{Mtd}^\bullet}(E_i, E_{i+1})$. Consider the m -fold compositions

$$\begin{aligned} \Pi_o(\mu_0, \dots, \mu_m) &:= \hat{\mu}_0 \circ \hat{\mu}_1 \circ \dots \circ \hat{\mu}_m \\ \Pi_\bullet(\mu_0, \dots, \mu_m) &:= \hat{\mu}_0 \bullet \hat{\mu}_1 \bullet \dots \bullet \hat{\mu}_m. \end{aligned}$$

Let $\pi_i := \Pi_\bullet(\mu_0, \dots, \mu_i) \in \text{Mor}_{\mathbf{Mtd}^\bullet}(E_0, E_{i+1})$. The **type** of $\Pi_\bullet(\mu_0, \dots, \mu_m)$ is defined to be $\sum_{i=1}^m \langle \pi_{i-1} : \hat{\mu}_i \rangle$. If $\Pi_\bullet(\mu_0, \dots, \mu_m)$ has type $(0, 0)$, then $\Pi_o(\mu_0, \dots, \mu_m) = \pi_{m+1}$; otherwise, $\Pi_o(\mu_0, \dots, \mu_m) = 0_{E_0, E_{m+1}}$.

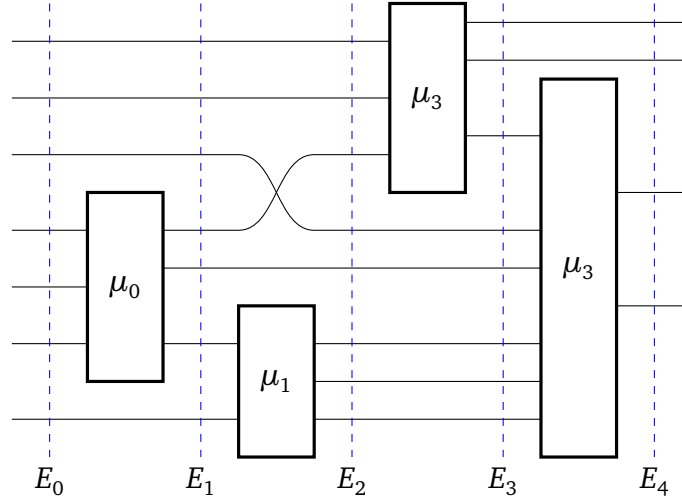

Figure 7.1: Schematic diagram of a composition $\Pi_{\bullet}(\mu_0, \mu_1, \mu_2, \mu_3)$.

Remark 7.7. We can represent the m -fold composition $\Pi_{\bullet}(\mu_0, \dots, \mu_m)$ by a schematic diagram. For each μ_i , draw a thin rectangular box centred at x -coordinate $i + \frac{1}{2}$. Draw an edge exiting the left size of the box for each point in the domain of μ_i , and an edge exiting to the right for each point in the codomain of μ_i . These edges extend to the left or the right until $x = 0$ or $x = m + 1$, or they are in the domain/codomain some other μ_j . Finally, for every point in $\bigcap_{i=0}^{m+1} E_i$, draw edge extending from $x = 0$ to $x = m + 1$ that does not intersect any of the boxes. $\bigcup_{i=0}^{m+1} E_i$ is then the set of all edges in the diagram, and E_i specifically corresponds to the set of edges that intersect the vertical line $x = i$. An example of such a diagram is shown in Figure 7.1.

If μ_i is a morphism with special structure, we may denote this by an appropriate symbol inside its box. For example, if $\mu_i = \text{ev}_A \in \text{Mor}_{\text{Mtd}^{\bullet}}(A \otimes A, \emptyset)$ is an evaluation morphism, we draw arcs connecting the corresponding elements of $A \otimes A$, and similarly if μ_i is a coevaluation morphism (see Figure 7.2). Or if μ_i is itself a composition, we may draw the structure of this composition inside the rectangle for μ_i . A tensor product is indicated by two vertically stacked rectangles.

In the following, we write $\eta^{k,l} \in \text{Mor}_{\text{Mtd}^{\circ}}(E, E)$ to mean a \circ -composition of k factors of $\eta \in \text{Mor}_{\text{Mtd}^{\circ}}(E, E)$ and l factors of $\eta^{\dagger} \in \text{Mor}_{\text{Mtd}^{\circ}}(E, E)$, where the factors may be taken in any order. The set E is suppressed from the notation, and is to be understood from context.

Corollary 7.8. Let E_0, \dots, E_{m+1} and μ_0, \dots, μ_m be as in (7.2). Suppose $\Pi_{\bullet}(\mu_0, \dots, \mu_m)$ has type (k, l) . There exist non-negative integers k_i, l_i , $i = 1, \dots, m$, such that $k = k_1 + \dots + k_m$, $l = l_1 + \dots + l_m$, and

$$\Pi_{\circ}(\mu_0, \eta^{k_1, l_1} \circ \mu_1, \dots, \eta^{k_m, l_m} \circ \mu_m) = \Pi_{\bullet}(\mu_0, \dots, \mu_m).$$



Figure 7.2: Schematic representation of an evaluation morphism ev_A (left), and coevaluation morphism ev_A^\dagger (right), for $A = \{a_1, a_2, a_3\}$.

Specifically, the equation above holds if (k_i, l_i) is the type of $\pi_{i-1} \bullet \hat{\mu}_i$. Note that each $\eta^{k_i, l_i} \circ \mu_i$ is non-zero.

Proof. Apply Lemma 7.6 inductively to (π_{i-1}, μ_i) , for $i = 1, \dots, m$. \square

We now prove Theorem 7.1, by using the rigid structure of \mathbf{Mtd}^\bullet to express $\lambda \bullet \mu$ as a composition of several smaller morphisms.

Proof of Theorem 7.1. Using the rigid structure, we have

$$\lambda \bullet \mu = (1_A \otimes \text{ev}_B^\dagger) \bullet (\lambda \otimes 1_B \otimes \mu) \bullet (\text{ev}_B \otimes 1_C),$$

We now turn this into an multifold composition of the form in Corollary 7.8. Choose any total ordering (b_1, \dots, b_m) of the elements of B . Let $B_1 = B$, and $B_{i+1} = B_i - b_i$ for $i = 1, \dots, m$. Let $E_0 = A$, and for $i = 1, \dots, m+1$, let $E_i = B_i \otimes B_i \otimes C$. Note that $E_1 \supseteq E_2 \supseteq \dots \supseteq E_{m+1}$, with $E_{i+1} \setminus E_i = \{b_i\} \otimes \{b_i\}$. Let

$$\mu_0 = (1_A \otimes \text{ev}_B^\dagger) \bullet (\lambda \otimes 1_B \otimes \mu) = (1_A \otimes \text{ev}_B^\dagger) \circ (\lambda \otimes 1_B \otimes \mu),$$

and for $i = 1, \dots, m$, let $\mu_i = \text{ev}_{\{b_i\}}$. With these sets and morphisms,

$$\lambda \bullet \mu = \Pi_\bullet(\mu_0, \dots, \mu_m).$$

By Theorem 6.4(iii), $\Pi_\bullet(\mu_0, \dots, \mu_m)$ has type (k, l) . Figure 7.3 shows the schematic diagram of this composition.

Now apply Corollary 7.8. There exist k_i, l_i such that for $\nu_i = \eta^{k_i, l_i} \circ \text{ev}_{\{b_i\}}$, we have

$$\Pi_\bullet(\mu_0, \dots, \mu_m) = \Pi_\circ(\mu_0, \nu_1, \dots, \nu_m).$$

Since each $\nu_i \in \text{Mor}_{\mathbf{Mtd}^\bullet}(\{b_i\} \otimes \{b_i\}, \emptyset)$ must be non-zero, ν_i is one of the following:

- (a) $\nu_i = \mu_i = \text{ev}_{\{b_i\}} = \xi_{\{b_i\} \otimes \{b_i\}, \emptyset}^{-1}$
- (b) $\nu_i = \eta \circ \text{ev}_{\{b_i\}} = \xi_{\{b_i\} \otimes \{b_i\}, \emptyset}^0$
- (c) $\nu_i = \eta^\dagger \circ \text{ev}_{\{b_i\}} = \xi_{\{b_i\} \otimes \{b_i\}, \emptyset}^{-2}$.

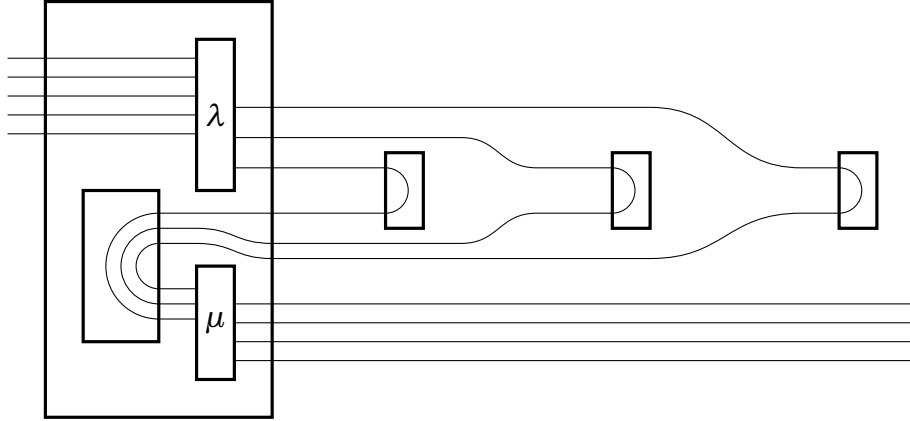

Figure 7.3: Schematic diagram of the proof of Theorem 7.1.

Let K be the set of all $b_i \in B$ for which (b) holds, and let L be the set of all $b_i \in B$ for which (c) holds. Note that $|K| = k$ and $|L| = l$, since (k, l) is the type of $\Pi_\bullet(\mu_0, \dots, \mu_m)$. Unpacking definitions, we have $\Pi_\circ(\mu_0, \nu_1, \dots, \nu_m) = \lambda \circ \theta_B^{K,L} \circ \mu$. Hence (7.1) holds for this choice of K, L .

Now suppose that $K, L \subseteq B$ are such that $K \cap L = \emptyset$, $|K| = k$, $|L| = l$ and $\lambda \circ \theta_B^{K,L} \circ \mu \neq 0_{AC}$. Let $r = m - k - l$. Repeat the argument above, with the elements of B ordered (b_1, \dots, b_m) , where $\{b_1, \dots, b_r\} = \overline{K} \cap \overline{L}$. Since $\lambda \circ \theta_B^{K,L} \circ \mu \neq 0_{AC}$, $\Pi_\circ(\mu_0, \mu_1, \dots, \mu_r)$ is non-zero, so we may assume that (a) holds for b_1, \dots, b_r . But now, since $\Pi_\bullet(\mu_0, \dots, \mu_m)$ has type (k, l) , each composition $\pi_{i-1} \bullet \hat{\mu}_i$, $i > r$ must have type $(1, 0)$ or $(0, 1)$. Thus there is at most one sequence ν_{r+1}, \dots, ν_m (where ν_i satisfies either (b) or (c), depending on the type of $\pi_{i-1} \bullet \hat{\mu}_i$) for which $\Pi_\circ(\mu_0, \nu_1, \dots, \nu_m) \neq 0_{AC}$. Furthermore, there is at least one such sequence, namely where (b) holds for $b_i \in K$, and (c) holds for $b_i \in L$. Therefore K must be the set of all $b_i \in B$ for which (b) holds, and L must be the set of all $b_i \in B$ for which (c) holds. Hence, $\Pi_\bullet(\mu_0, \mu_1, \dots, \mu_m) = \lambda \circ \theta_B^{K,L} \circ \mu$, for this ordering of the elements of B . \square

Using a similar argument, Theorem 7.1 generalizes to m -fold compositions.

Theorem 7.9. *Let E_0, \dots, E_{m+1} and μ_0, \dots, μ_m be as in (7.2). There exist disjoint subsets $K_i, L_i \subseteq E_i \setminus E_{i+1}$, such that $k = |K_1| + \dots + |K_m|$, $l = |L_1| + \dots + |L_m|$ and*

$$\Pi_\circ(\mu_0, \theta_{E_1 \setminus E_2}^{K_1, L_1} \circ \mu_1, \dots, \theta_{E_m \setminus E_{m+1}}^{K_m, L_m} \circ \mu_m) = \Pi_\bullet(\mu_0, \dots, \mu_m). \quad (7.3)$$

Furthermore if $K_i, L_i \subseteq E_i \setminus E_{i+1}$, $K_i \cap L_i = \emptyset$, $k = |K_1| + \dots + |K_m|$, $l = |L_1| + \dots + |L_m|$, and the left hand side of (7.3) is non-zero, then (7.3) holds. \square

Example 7.10. Recall the categories **BDGraph** and **Gam \bullet** from Examples 3.7 and 6.8. Consider the subcategory **BDGraph \bullet** of **BDGraph**, where we restrict the class of morphisms to bicoloured digraphs with no isolated vertices. By the same argument as in Examples 3.6 and 3.7, equation (3.1) characterizes a unique functor $\text{BPath}^\bullet : \text{BDGraph}^\bullet \rightarrow$

Gam[•]. Evaluation of this functor amounts to computing $\Pi_{\bullet}(\mu_0, \dots, \mu_m)$, where each μ_i is either $\text{BPath}^{\bullet}(G_i)$ for some graph G_i with one vertex, or a (co)evaluation morphism.

If $G \in \text{Mor}_{\text{BDGraph}^{\bullet}}(A, B)$ is perfectly orientable, then $\text{BPath}^{\bullet}(G) = \text{BPath}(G)$. Otherwise, consider the following operation: given an edge $e : u \rightarrow v$ of G , define **breaking** e to be the operation of replacing e by two new edges $e' : u \rightarrow w'$ and $e'' : w'' \rightarrow v$, where w' and w'' are two new degree-1 vertices of the same colour (either both black or both white). By repeatedly breaking edges of G , we can eventually make the graph perfectly orientable. In this context Theorem 7.9 is asserting that $\text{BPath}^{\bullet}(G) = \text{BPath}(G')$ where G' is obtained by breaking a minimum number of edges of G to make it perfectly orientable. Furthermore all such G' give the same result, and all involve the same number of black/white broken edges.

8 Enriched matroid categories

We now describe a structure that interpolates between the categories \mathbf{Mtd}° and \mathbf{Mtd}^{\bullet} . Let R be a commutative ring, or a commutative semiring, or a commutative monoid, and let $x, y \in R$ be elements. In our discussion, we use the language of rings and semirings. If R is a commutative monoid, see Remark 8.4 for clarification on what some of the definitions mean in this context.

Recall that an R -linear category is a locally small category in which the sets $\text{Mor}(A, B)$ are R -modules, and composition is R -bilinear.

Definition 8.1. We define an R -linear symmetric monoidal category $(R\text{-Mtd}^{\star}(x, y), \otimes)$. The objects of $R\text{-Mtd}^{\star}(x, y)$ are again finite sets. $\text{Mor}_{R\text{-Mtd}^{\star}(x, y)}(A, B)$ is the R -module of all formal R -linear combinations of morphisms in $\text{Mor}_{\mathbf{Mtd}^{\star}}(A, B)$.

The composition operation \star of $R\text{-Mtd}^{\star}(x, y)$ depends on the elements $x, y \in R$. For $\lambda \in \text{Mor}_{\mathbf{Mtd}^{\star}}(A, B)$, $\mu \in \text{Mor}_{\mathbf{Mtd}^{\star}}(B, C)$, let

$$\lambda \star \mu := x^k y^l \cdot (\lambda \bullet \mu),$$

where $(k, l) = \langle \lambda : \mu \rangle$ is the type of $\lambda \bullet \mu$. We extend this definition R -bilinearly to all of $\text{Mor}_{R\text{-Mtd}^{\star}(x, y)}(A, B) \times \text{Mor}_{R\text{-Mtd}^{\star}(x, y)}(B, C)$. Theorem 6.4(ii) and (iii) imply that \star is associative.

For the monoidal structure, we have a functor $\otimes : R\text{-Mtd}^{\star}(x, y) \times R\text{-Mtd}^{\star}(x, y) \rightarrow R\text{-Mtd}^{\star}(x, y)$ defined by $A \otimes B = A \sqcup B$ for objects, and $\lambda \otimes \mu = \lambda \otimes_R \mu$ for morphisms.

Remark 8.2. $R\text{-Mtd}^{\star}$ has many of the same properties as \mathbf{Mtd}° and \mathbf{Mtd}^{\bullet} . In particular, $R\text{-Mtd}^{\star}$ is again a rigid symmetric monoidal category. However, $\lambda \mapsto \lambda^{\dagger}$ is no longer an anti-automorphism; rather, \dagger defines a contravariant functor $R\text{-Mtd}^{\star}(x, y) \rightarrow R\text{-Mtd}^{\star}(y, x)$. The classification of isomorphisms in $R\text{-Mtd}^{\star}(x, y)$ is more complicated, and depends on R .

Example 8.3. For any commutative ring R , elements $x, y \in R$, and any finite set A , $\text{Mor}_{R\text{-Mtd}^{\star}(x, y)}(A, A)$ is an associative unital R -algebra. In addition, we have an R -linear

trace map $\text{tr} : \text{Mor}_{R\text{-Mtd}^*(x,y)}(A,A) \rightarrow R$, defined by $\text{tr}(\lambda) = \text{ev}_A^\dagger \star (\lambda \otimes 1_A) \star \text{ev}_A$, which satisfies $\text{tr}(\lambda \star \mu) = \text{tr}(\mu \star \lambda)$.

Remark 8.4. Let (R, \cdot) be a commutative monoid with identity element 1_R . In this case, an R -module is a set with an R -action. If M, M', M'' are R -modules, then $\phi : M \rightarrow M'$ is R -linear if $\phi(rm) = r\phi(m)$ for all $r \in R, m \in M$, and $\psi : M \times M' \rightarrow M''$ is R -bilinear if $\psi(rm, m') = \psi(m, rm') = r\psi(m, m')$ for all $r \in R, m \in M, m' \in M'$.

A zero element $0_R \in R$ is an element such that $0_R \neq 1_R$ and $0_R \cdot r = r \cdot 0_R = 0_R$ for all $r \in R$. To define formal R -linear combinations, we distinguish two categories of commutative monoids: commutative monoids, and commutative monoids with a zero element. In the former category, a morphism $\varphi : R \rightarrow R'$ must satisfy $\varphi(r_1 r_2) = \varphi(r_1)\varphi(r_2)$ and $\varphi(1_R) = 1_{R'}$; in the latter category, we also require $\varphi(0_R) = 0_{R'}$. Let S be a set. If R is in the category of commutative monoids, the set of formal R -linear combinations of elements of S is the R -module $R \times S$, where the action is given by $r'(r, s) = (r'r, s)$. If R is in the category of commutative monoids with a zero element, let \sim be the equivalence relation on $R \times S$ defined by $(r, s) \sim (r', s')$ if and only if $r = r' = 0_R$; in this case, the set of formal R -linear combinations of elements of S is the R -module $R \times S / \sim$.

Example 8.5. If $R = \{1_R\}$ is the monoid with one element, the category $R\text{-Mtd}^*(1_R, 1_R)$ is isomorphic to \mathbf{Mtd}^\bullet . If $R = \{0_R, 1_R\}$ is the monoid with an identity element and a zero element, then $R\text{-Mtd}^*(0_R, 0_R)$ is isomorphic to \mathbf{Mtd}° . In the latter case, the isomorphism identifies the equivalence class $\{(0_R, \lambda) \mid \lambda \in \text{Mor}_{\mathbf{Mtd}^\bullet}(A, B)\}$ with the zero morphism $0_{AB} \in \text{Mor}_{\mathbf{Mtd}^\circ}(A, B)$. These two monoids are, respectively, the initial object in the category of commutative monoids, and the initial object in the category of commutative monoids with a zero element.

For each morphism $\lambda \in \text{Mor}_{R\text{-Mtd}^*(x,y)}(A, B)$, we define

$$\lambda_\star(-, x, y) : \text{Mor}_{R\text{-Mtd}^*(x,y)}(S, A) \rightarrow \text{Mor}_{R\text{-Mtd}^*(x,y)}(S, B)$$

to be the function

$$\lambda_\star(\mu; x, y) = \mu \star \lambda,$$

which is a morphism of R -modules. The covariant hom-functor $\text{Hom}_{R\text{-Mtd}^*(x,y)}(S, -) : R\text{-Mtd}^*(x, y) \rightarrow R\text{-Mod}$ is now a functor to the category of R -modules, with evaluation on morphisms given by $\text{Hom}_{R\text{-Mtd}^*(x,y)}(S, \lambda) = \lambda_\star(-; x, y)$.

Example 8.6. Let (E, α) be a matroid, and let $e \in E$. Regard α as a morphism in $\text{Mor}_{R\text{-Mtd}^*(x,y)}(\emptyset, E)$. Then

$$\delta_\star^e(\alpha; x, y) := \begin{cases} \alpha \setminus e & \text{if } e \text{ is not a coloop of } \alpha \\ y \cdot (\alpha \setminus e) & \text{if } e \text{ is a coloop of } \alpha, \end{cases}$$

and

$$\chi_{\star}^e(\alpha; x, y) := \begin{cases} \alpha/e & \text{if } e \text{ is not a loop of } \alpha \\ x \cdot (\alpha/e) & \text{if } e \text{ is a loop of } \alpha. \end{cases}$$

Thus in $R\text{-Mtd}^{\star}$, δ_{\star}^e and χ_{\star}^e perform deletion and contraction, while the coefficient keeps track of how the rank of the matroid changes. Setting $(x, y) = (0, 0)$ or $(x, y) = (1, 1)$, we recover the behaviour of $(\delta_{\circ}^e, \chi_{\circ}^e)$ or $(\delta_{\bullet}^e, \chi_{\bullet}^e)$, respectively.

Example 8.7. For a matroid $\alpha \in \mathbb{M}(E)$, the **Tutte polynomial** $T_{\alpha}(x, y) \in \mathbb{Z}[x, y]$ is a matroid invariant which can be defined recursively:

$$T_{\alpha}(x, y) = T_{\alpha \setminus e}(x, y) + T_{\alpha/e}(x, y)$$

if $e \in E$ is neither a loop nor a coloop; if no such e exists,

$$T_{\alpha}(x, y) = x^k y^l,$$

where k is the number of loops in α , and l is the number of coloops. (Note: The conventions employed here are non-standard. In most references the polynomial defined above would be $T_{\alpha}(y, x)$.)

The Tutte polynomial is realized by a morphism in $\mathbb{Z}[x, y]\text{-Mtd}^{\star}(x-1, y-1)$. Specifically, consider $\tau \in \text{Mor}_{\mathbb{Z}[x, y]\text{-Mtd}^{\star}(x-1, y-1)}(E, \emptyset)$,

$$\tau = \sum_{X \subseteq E} \epsilon^{X, \emptyset} = (\delta^{e_1} + \chi^{e_1}) \star (\delta^{e_2} + \chi^{e_2}) \star \cdots \star (\delta^{e_n} + \chi^{e_n}), \quad (8.1)$$

where $E = \{e_1, \dots, e_n\}$. Then we have

$$\tau_{\star}(\alpha; x-1, y-1) = T_{\alpha}(x, y).$$

Remark 8.8. Analogously, we define enriched categories $R\text{-Pos}^{\star}(x, y)$, $R\text{-Gam}^{\star}(x, y)$, $R\text{-MConv}^{\star}(x, y)$, and $R\text{-Mtd}^{\star}(\mathbb{F}; x, y)$, for positroids, gammoids, M-convex sets, and matroids representable over an infinite field \mathbb{F} .

For symmetric matroids, it is reasonable to define $R\text{-SMtd}^{\star}(x, y)$ to be the (larger) category of symmetric R -linear combinations of matroids (rather than R -linear combinations of symmetric matroids). That is, for $A = (A_1, \dots, A_n)$ and $B = (B_1, \dots, B_m)$, define $\text{Mor}_{R\text{-SMtd}^{\star}(x, y)}(A, B)$ to be the subset of $\text{Mor}_{R\text{-Mtd}^{\star}(x, y)}(A_1 \otimes \cdots \otimes A_n, B_1 \otimes \cdots \otimes B_m)$ of morphisms which are invariant under all permutations of each of the sets A_i and B_j . For example, in (8.1) we have $\tau \in \text{Mor}_{\mathbb{Z}[x, y]\text{-SMtd}^{\star}(x-1, y-1)}(E, \emptyset)$, since τ is invariant under all permutations of E . In general, every element of $\text{Mor}_{R\text{-SMtd}^{\star}(x, y)}(E, \emptyset)$, defines a matroid invariant on $\mathbb{M}(E)$.

9 Dominant morphisms

The remaining sections of this paper are devoted to the proof of Theorem 6.4. In this section, we develop tools to prove part (i).

Definition 9.1. A morphism $\lambda \in \text{Mor}_{\mathbf{Mtd}^\circ}(A, B)$ is *dominant* if for all $X \mapsto_\lambda Y$ and all $y \in B$, there exists $x \in A$ such that x and y are exchangeable in $X \mapsto_\lambda Y$.

Example 9.2. Every isomorphism in the category \mathbf{Mtd}° is dominant.

Example 9.3. Suppose $\lambda \in \text{Mor}_{\mathbf{Mtd}^\circ}(A, B)$ is a bimatroid. Then λ is dominant if and only if $B \in \text{range}(\lambda)$.

Example 9.4. If $|A| - |B| \geq m \geq 0$, then the uniform relation $\xi_{AB}^{-m} \in \text{Mor}_{\mathbf{Mtd}^\circ}(A, B)$ is a dominant morphism.

Example 9.5. More generally, let $\mu \in \text{Mor}_{\mathbf{Mtd}^\circ}(B, C)$ be any morphism. Let $m = \min\{|X| \mid X \in \text{range}(\mu)\}$ and $n = \max\{|X| \mid X \in \text{range}(\mu)\}$. If $|D| = n - m$, then $\nu = \mu \circ \xi_{CD}^{-m} \in \text{Mor}_{\mathbf{Mtd}^\circ}(B, D)$ is dominant.

We will first prove that $\lambda \bullet \mu$ has a definite type when μ is dominant. We then use the construction in Example 9.5 to obtain the result in general. In the dominant case, the idea is to think of a λ as a piece of a larger morphism $\tilde{\lambda}$, called a general lift of λ . We show that the general lifts are well-behaved under composition with dominant morphisms. Throughout the rest of this section, we assume that $\lambda \in \text{Mor}_{\mathbf{Mtd}^\circ}(A, B)$ is non-zero.

Fix two additional finite sets S, T . For integers $k, l \geq 0$, define a “projection” function

$$\begin{aligned} \pi_{k,l} : \text{Mor}_{\mathbf{Mtd}^\circ}(A \otimes S, B \otimes T) &\rightarrow \text{Mor}_{\mathbf{Mtd}^\circ}(A, B) \\ \pi_{k,l}(\tilde{\lambda}) &= (1_A \otimes \xi_{\emptyset, S}^k) \circ \tilde{\lambda} \circ (1_B \otimes \xi_{T, \emptyset}^{-l}). \end{aligned}$$

Hence $X \mapsto_{\pi_{k,l}(\tilde{\lambda})} Y$ if and only if there exists $(X, U) \mapsto_{\tilde{\lambda}} (Y, V)$ with $|U| = k$, $|V| = l$.

We partially order $\mathbb{Z} \times \mathbb{Z}$ as follows: $(k', l') \geq (k, l)$ if and only if $k' \geq k$ and $l' \geq l$.

Definition 9.6. Let $\lambda \in \text{Mor}_{\mathbf{Mtd}^\circ}(A, B)$. A morphism $\tilde{\lambda} \in \text{Mor}(A \otimes S, B \otimes T)$ is a *lift* of λ if there exist $k, l \geq 0$ such that $\pi_{k,l}(\tilde{\lambda}) = \lambda$ and $\pi_{k',l'}(\tilde{\lambda}) = 0_{AB}$ for $(k', l') \not\geq (k, l)$. We say that (k, l) is the *type* of the lift, and we write $[\tilde{\lambda} : \lambda] := (k, l)$.

Definition 9.7. Let $\lambda \in \text{Mor}_{\mathbf{Mtd}^\circ}(A, B)$. A point $t \in B$ is *general in* λ if for all $X \mapsto_\lambda Y$ with $t \notin Y$, and all $z \in \overline{X} \sqcup Y$, t and z are exchangeable in $X \mapsto_\lambda Y$. We also say that $s \in A$ is general in λ if s is general in λ^\dagger . A morphism $\tilde{\lambda} \in \text{Mor}_{\mathbf{Mtd}^\circ}(A \otimes S, B \otimes T)$ is *(S, T) -general* if $\tilde{\lambda}$ is non-zero, and every point of $S \sqcup T$ is general in $\tilde{\lambda}$.

Lemma 9.8. If $\tilde{\lambda} \in \text{Mor}_{\mathbf{Mtd}^\circ}(A \otimes S, B \otimes T)$ is (S, T) -general there exists a unique $\lambda \in \text{Mor}_{\mathbf{Mtd}^\circ}(A, B)$ such that $\tilde{\lambda}$ is a lift of λ .

Proof. If λ exists, then by definition it is unique. For existence, consider the set of pairs (k, l) such that $\pi_{k,l}(\tilde{\lambda}) \neq 0_{AB}$. Since $\tilde{\lambda}$ is non-zero, this set is non-empty. We must show that there is a unique minimal pair.

Suppose to the contrary that there are two such minimal pairs, (k, l) and (k', l') , with $k < k'$, $l' < l$. Then there exists $(X, U) \mapsto_{\tilde{\lambda}} (Y, V)$ with $|U| = k$, $|V| = l$ and $(X', U') \mapsto_{\tilde{\lambda}} (Y', V')$ with $|U'| = k'$, $|V'| = l'$. Since $\tilde{\lambda}$ is (S, T) -general, we can exchange points of U for points of U' , and points of V' for points of V , and thereby assume $U \subsetneq U'$, $V' \subsetneq V$.

Let $v \in V \setminus V'$. By the exchange axiom there exists $z \in (X \setminus X') \sqcup (U \setminus U') \sqcup (Y' \setminus Y) \sqcup (V' \setminus V)$ such that v and z are exchangeable in $(X, U) \mapsto_{\tilde{\lambda}} (Y, V)$. Since $U \setminus U'$ and $V' \setminus V$ are empty, we must have $z \in X$ or $z \in \bar{Y}$. In the first case we have $(X - z, V) \mapsto_{\tilde{\lambda}} (Y, V - v)$; in the second, $(X, V) \mapsto_{\tilde{\lambda}} (Y + z, V - v)$. Either way, this implies that $\pi_{k,l-1}(\tilde{\lambda}) \neq 0_{AB}$, contradicting the minimality of (k, l) . \square

For $\lambda \in \text{Mor}_{\text{Mtd}^\circ}(A, B)$, consider the relation $\tilde{\lambda}_{k,l} \in \text{Rel}(2^{A \sqcup S}, 2^{B \sqcup Y})$ in which $(X, U) \mapsto_{\tilde{\lambda}_{k,l}} (Y, V)$ if and only if there exists $X' \mapsto_{\lambda} Y'$ and $c \geq 0$ such that

$$|U| = |X' \setminus X| + |Y \setminus Y'| + k + c \quad \text{and} \quad |V| = |X \setminus X'| + |Y' \setminus Y| + l + c.$$

Informally, $\tilde{\lambda}_{k,l}$ is the minimal relation which includes $(X, U) \mapsto_{\tilde{\lambda}_{k,l}} (Y, V)$ if $X \mapsto_{\lambda} Y$, $|U| = k$, $|V| = l$, as well as all other related pairs directly implied by the (S, T) -general condition, but no others. Thus $\tilde{\lambda}_{k,l}$ is the minimal viable candidate for an (S, T) -general lift of type (k, l) .

Lemma 9.9. *If $\lambda \in \text{Mor}_{\text{Mtd}^\circ}(A, B)$, then $\tilde{\lambda}_{k,l} \in \text{Mor}_{\text{Mtd}^\circ}(A \otimes S, B \otimes T)$. Furthermore, $\tilde{\lambda}_{k,l}$ is the unique (S, T) -general lift of λ of type (k, l) .*

Proof. We first verify that $\tilde{\lambda}_{k,l}$ satisfies the exchange axiom. To see this, we give an alternate description of the associated matroid $\alpha_{\tilde{\lambda}_{k,l}}$. For finite sets P, Q and $p, q \geq 0$, let $\zeta_{P,Q}^{p,q} \in \text{Mor}_{\text{Mtd}^\circ}(P, P \otimes Q)$ be the relation defined by $X \mapsto_{\zeta_{P,Q}^{p,q}} (Y, Z)$ if and only if $|X| = p$, $Y \subseteq X$, and $|Y| + |Z| = p + q$. For a matroid $\alpha \in \mathbb{M}(P) = \text{Mor}_{\text{Mtd}^\circ}(\emptyset, P)$, write $\zeta_Q^q(\alpha) := \alpha \circ \zeta_{P,Q}^{p,q}$, where $p = \text{rank}(\alpha)$. Let $\beta_\lambda = \zeta_T^l(\alpha_\lambda)$ and $\gamma_\lambda = \zeta_S^k(\beta_\lambda)$. Unpacking the definitions, one can check that $\alpha_{\tilde{\lambda}_{k,l}} = \bar{\gamma}_\lambda$, and hence is a matroid.

It is clear that $\tilde{\lambda}_{k,l}$ is both (S, T) -general and a lift of λ of type (k, l) , and as noted above, it is the minimal relation with this property. It remains to show uniqueness. Suppose $\tilde{\lambda}'$ is another (S, T) -general lift of λ of type (k, l) . By the minimality of $\tilde{\lambda}_{k,l}$, we have $\tilde{\lambda}' \geq \tilde{\lambda}_{k,l}$. Therefore, suppose $(X, U) \mapsto_{\tilde{\lambda}'} (Y, V)$. We must show that $(X, U) \mapsto_{\tilde{\lambda}_{k,l}} (Y, V)$.

We induct on $|U| + |V|$. By definition of a lift, we must have $|U| \geq k$, $|V| \geq l$. If $|U| = k$, $|V| = l$, since $\tilde{\lambda}'$ is a lift of λ , we must have $X \mapsto_{\lambda} Y$, and hence $(X, U) \mapsto_{\tilde{\lambda}_{k,l}} (Y, V)$. Now, suppose without loss of generality that $|V| > l$ (if instead $|U| > k$, we can apply the following argument to λ^\dagger). Let $X' \mapsto_{\lambda} Y'$, and let U', V' be subsets $U' \subseteq U$,

$V' \subseteq V$, $|U'| = k$, $|V'| = l$. Then $(X', U') \mapsto_{\tilde{\lambda}'} (Y', V')$. Let $v \in V \setminus V'$. By the exchange axiom there exists $z \in (U \setminus U') \sqcup (X \setminus X') \sqcup (Y' \setminus Y) \sqcup (V' \setminus V)$ exchangeable for v in $(X, U) \mapsto_{\tilde{\lambda}'} (Y, V)$. Since $V' \setminus V = \emptyset$, we must have $z \in U \sqcup X \sqcup \overline{Y}$. If $z \in U$, then we get $(X, U - z) \mapsto_{\tilde{\lambda}'} (Y, V - v)$; by induction, $(X, U - z) \mapsto_{\tilde{\lambda}_{k,l}} (Y, V - v)$ which, since $\tilde{\lambda}_{k,l}$ is (S, T) -general, implies $(X, U) \mapsto_{\tilde{\lambda}_{k,l}} (Y, V)$. A similar argument applies if $z \in X$ or $z \in \overline{Y}$. \square

Lemma 9.10. *Suppose $\tilde{\lambda} \in \text{Mor}_{\text{Mtd}^\circ}(A \otimes S, B \otimes T)$ is (S, T) -general, and $\mu \in \text{Mor}_{\text{Mtd}^\circ}(B, C)$ is dominant. Then $\tilde{\nu} = \tilde{\lambda} \circ (\mu \otimes 1_T) \in \text{Mor}_{\text{Mtd}^\circ}(A \otimes S, C \otimes T)$ is (S, T) -general.*

Proof. Let $t \in T$. Suppose $(X, U) \mapsto_{\tilde{\nu}} (Z, V)$, $t \notin V$. We must show the following:

- (a) For $v \in V$, $(X, U) \mapsto_{\tilde{\nu}} (Z, V - v + t)$.
- (b) For $u \in \overline{U}$, $(X, U + u) \mapsto_{\tilde{\nu}} (Z, V + t)$.
- (c) For $x \in \overline{X}$, $(X + x, U) \mapsto_{\tilde{\nu}} (Z, V + t)$.
- (d) For $z \in Z$, $(X, U) \mapsto_{\tilde{\nu}} (Z - z, V + t)$.

By definition of strict composition there exists Y such that $Y \mapsto_{\mu} Z$, and $(X, U) \mapsto_{\tilde{\lambda}} (Y, V)$. For (a), let $v \in V$. Since t is general in $\tilde{\lambda}$, we have $(X, U) \mapsto_{\tilde{\lambda}} (Y, V - v + t)$, and thus by composition $(X, U) \mapsto_{\tilde{\nu}} (Z, V - v + t)$. The arguments for (b) and (c) are essentially the same. As for (d), since μ is dominant there exists $y \in Y$ such that $Y - y \mapsto_{\mu} Z - z$. Since t is general in $\tilde{\lambda}$, we have $(X, U) \mapsto_{\tilde{\lambda}} (Y - y, V + t)$. Thus by composition $(X, U) \mapsto_{\tilde{\nu}} (Z - z, V + t)$.

Now, let $s \in S$. Suppose $(X, U) \mapsto_{\tilde{\nu}} (Z, V)$, $s \notin U$. In this case, we must show:

- (a') For $v \in \overline{V}$, $(X, U + s) \mapsto_{\tilde{\nu}} (Z, V + v)$.
- (b') For $u \in U$, $(X, U - u + s) \mapsto_{\tilde{\nu}} (Z, V)$.
- (c') For $x \in X$, $(X - x, U + s) \mapsto_{\tilde{\nu}} (Z, V + t)$.
- (d') For $z \in \overline{Z}$, $(X, U + s) \mapsto_{\tilde{\nu}} (Z + z, V)$.

Again, there exists Y such that $Y \mapsto_{\mu} Z$, and $(X, U) \mapsto_{\tilde{\lambda}} (Y, V)$. The arguments for (a')–(c') are essentially the same as (a)–(c). For (d'), this time using the fact that μ is dominant, there exists $y \in \overline{Y}$ such that $Y + y \mapsto_{\mu} Z + z$, and since $(X, U + s) \mapsto_{\tilde{\lambda}} (Y + y, V)$ we deduce that $(X, U + s) \mapsto_{\tilde{\nu}} (Z + z, V)$. \square

Lemma 9.11. *Suppose $\lambda \in \text{Mor}_{\text{Mtd}^\circ}(A, B)$, $\mu \in \text{Mor}_{\text{Mtd}^\circ}(B, C)$, $\nu \in \text{Mor}_{\text{Mtd}^\circ}(A, C)$, and μ is dominant. Let $\tilde{\lambda}$ be an (S, T) -general lift of λ . Let $\tilde{\nu} = \tilde{\lambda} \circ (\mu \otimes 1_T)$.*

Assume that $[\tilde{\lambda} : \lambda] \leq (|S| - |B|, |T| - |B|)$. Then the following are equivalent:

- (a) $\lambda \bullet \mu = \nu$;
- (b) $\tilde{\nu}$ is an (S, T) -general lift of ν .

Furthermore if these conditions hold, then $\lambda \bullet \mu$ has type

$$\langle \lambda : \mu \rangle = [\tilde{\nu} : \nu] - [\tilde{\lambda} : \lambda].$$

Proof. By Lemmas 9.8 and 9.10 there is a unique morphism ν such (b) holds. Define ν to be this morphism. We show $X \mapsto_{\lambda \bullet \mu} Z$ if and only if $X \mapsto_{\nu} Z$.

Let (k, l) be the type of the lift $\tilde{\lambda}$, and let (k', l') be the type of the lift $\tilde{\nu}$. By Lemma 9.9, $\tilde{\lambda} = \tilde{\lambda}_{k,l}$ and $\tilde{\nu} = \tilde{\nu}_{k',l'}$. We note that since $\pi_{k',l'}(\tilde{\nu}) \neq 0_{AC}$, by definition of strict composition, we have $\pi_{k',l'}(\tilde{\lambda}) \neq 0_{AB}$, and therefore we must have $(k', l') \geq (k, l)$.

Suppose $X \mapsto_{\lambda \bullet \mu} Z$. By definition, there exists Y, Y' such that $|Y \Delta Y'| = |\lambda : \mu|$, $X \mapsto_{\lambda} Y'$, $Y \mapsto_{\mu} Z$. Let $k_0 = |Y \setminus Y'|$ and $l_0 = |Y' \setminus Y|$. Then by the definition of $\tilde{\lambda}_{k,l} = \tilde{\lambda}$, if $|U| = k + k_0$, $|V| = l + l_0$ we have $(X, U) \mapsto_{\tilde{\lambda}} (Y, V)$, and therefore $(X, U) \mapsto_{\tilde{\nu}} (Z, V)$.

Since, $\lambda \bullet \mu \neq 0_{AC}$, there exists at least one pair $X \mapsto_{\lambda \bullet \mu} Z$, and hence $\pi_{k+k_0, l+l_0}(\tilde{\nu}) \neq 0_{AC}$. Since $\tilde{\nu}$ has type (k', l') , we deduce that

$$(k + k_0, l + l_0) \geq (k', l'),$$

and hence $|\lambda : \mu| = k_0 + l_0 \geq (k' - k) + (l' - l)$.

Now suppose that $X \mapsto_{\nu} Z$. Then if $|U| = k'$, $|V| = l'$ we have $(X, U) \mapsto_{\tilde{\nu}} (Z, V)$. Hence there exists Y such that $(X, U) \mapsto_{\tilde{\lambda}} (Y, V)$, and $Y \mapsto_{\mu} Z$. By definition of $\tilde{\lambda}_{k,l} = \tilde{\lambda}$, there exist X', Y' such that $X' \mapsto_{\lambda} Y'$ and

$$k' = |X' \setminus X| + |Y \setminus Y'| + k + c \quad \text{and} \quad l' = |X \setminus X'| + |Y' \setminus Y| + l + c.$$

Adding these equations,

$$|Y \Delta Y'| = (k' - k) + (l' - l) - 2c - |X \Delta X'| \leq (k' - k) + (l' - l),$$

with equality if $c = 0$ and $X = X'$. Also, since $X' \mapsto_{\lambda} Y'$ and $Y \mapsto_{\mu} Z$, by the definition of $|\lambda : \mu|$ we must have $|\lambda : \mu| \leq |Y \Delta Y'|$.

Since $\nu \neq 0_{AC}$ there exists at least one pair $X \mapsto_{\nu} Z$, and so we deduce that $|\lambda : \mu| \leq (k' - k) + (l' - l)$.

Therefore all inequalities in the arguments above must be equalities. If $X \mapsto_{\lambda \bullet \mu} Z$, then if $|U| = k'$, $|V| = l'$, there exists Y, Y' such that $X \mapsto_{\lambda} Y'$, $Y \mapsto_{\mu} Z$ such that $|Y \setminus Y'| = k' - k$ and $|Y' \setminus Y| = l' - l$, $|U| = k'$, $|V| = l'$, and $(X, U) \mapsto_{\tilde{\nu}} (Z, V)$. Therefore $X \mapsto_{\nu} Z$.

Conversely, if $X \mapsto_{\nu} Z$ then if $|U| = k'$, $|V| = l'$, there exists Y, Y' such that $X \mapsto_{\lambda} Y'$, $Y \mapsto_{\mu} Z$, and $|Y \Delta Y'| = |\lambda : \mu|$. Thus, $X \mapsto_{\lambda \bullet \mu} Z$.

If these equivalent conditions hold then the preceding arguments show that $(k' - k, l' - l)$ is the type of $\lambda \bullet \mu$, as required. (Note: we have implicitly used the inequality $|\tilde{\lambda} : \lambda| \leq (|S| - |B|, |T| - |B|)$ to ensure that the sets U, V of the appropriate size exist, in each of the arguments above.) \square

In particular, Lemma 9.11 shows that $\lambda \bullet \mu$ has a definite type when μ is dominant. We deduce the first part of Theorem 6.4.

Proof of Theorem 6.4(i). Observe that whether or not $\lambda \bullet \mu$ has a definite type depends only on the range of λ and the corange of μ . Consider the morphism ν defined in

Example 9.5. Then ν is dominant and $\text{range}(\nu^\dagger) = \text{range}(\mu^\dagger)$. Therefore, since $\lambda \bullet \nu$ has a definite type, so does $\lambda \bullet \mu$. The fact that $\lambda \bullet \mu$ satisfies the exchange axiom now follows from Proposition 6.3. \square

10 Associativity

In this section, we prove parts (ii) and (iii) of Theorem 6.4. Throughout this section we assume A, B, C, D , and λ, μ, ν are as in the statement of Theorem 6.4.

Lemma 10.1. *Suppose $\lambda \circ \mu \neq 0_{AC}$, $\mu \circ \nu \neq 0_{BD}$, and $\lambda \circ \mu \circ \nu = 0_{AD}$.*

- (i) $(\lambda \circ \mu) \bullet_{1,0} \nu = \lambda \bullet_{1,0} (\mu \circ \nu)$
- (ii) $(\lambda \circ \mu) \bullet_{0,1} \nu = \lambda \bullet_{0,1} (\mu \circ \nu)$
- (iii) *If $(\lambda \circ \mu) \bullet_{0,1} \nu = 0_{AD}$ and $(\lambda \circ \mu) \bullet_{1,0} \nu = 0_{AD}$ then*

$$(\lambda \circ \mu) \bullet_{1,1} \nu = \lambda \bullet_{1,1} (\mu \circ \nu).$$

Proof. We will prove the following two statements:

- (A) $(\lambda \circ \mu) \bullet_{0,1} \nu \leq \lambda \bullet_{0,1} (\mu \circ \nu)$;
- (B) Under the hypotheses of (iii), $(\lambda \circ \mu) \bullet_{1,1} \nu \leq \lambda \bullet_{1,1} (\mu \circ \nu)$.

This suffices, as (i) is equivalent to (ii), by taking $(\nu^\dagger, \mu^\dagger, \lambda^\dagger)$ in place of (λ, μ, ν) ; (ii) is equivalent to (A) being true for both (λ, μ, ν) and $(\bar{\nu}^\dagger, \bar{\mu}^\dagger, \bar{\lambda}^\dagger)$; and (iii) is equivalent to (B) being true for both (λ, μ, ν) and $(\nu^\dagger, \mu^\dagger, \lambda^\dagger)$.

Fix X_0, Y_0, Z_0 such that $X_0 \mapsto_\mu Y_0 \mapsto_\nu Z_0$. These exist, since $\mu \circ \nu \neq 0$.

We first prove (A). Suppose that $W \mapsto_{(\lambda \circ \mu) \bullet_{0,1} \nu} Z$. Then there exists X, Y, Y' such that $W \mapsto_\lambda X \mapsto_\mu Y', Y \mapsto_\nu Z$, and $Y = Y' - y$ for some $y \in Y'$. Subject to these conditions, assume that X, Y, Y' are chosen such that

$$|Y_0 \cap \bar{Y} \cap \bar{Y}'| + |\bar{Y}_0 \cap Y \cap Y'| \text{ is minimal.} \quad (10.1)$$

Suppose $y \in Y_0$. Using the exchange axiom on $Y \mapsto_\nu Z$ and $Y_0 \mapsto_\nu Z_0$, there exists either $z \in \bar{Z}$ such that $Y' = Y + y \mapsto_\nu Z + z$, or $y' \in Y \setminus Y_0$ such that $Y + y - y' \mapsto_\nu Z$. In the former case we have $W \mapsto_\lambda X \mapsto_\mu Y' \mapsto_\nu Z + z$ which contradicts the assumption $\lambda \circ \mu \circ \nu = 0_{AD}$. In the latter case $(X, Y + y - y', Y')$ contradicts the minimality assumption. Therefore, we must have $y \in \bar{Y}_0$. Using the exchange axiom on $X \mapsto_\mu Y'$ and $X_0 \mapsto_\mu Y_0$, there exists either $x \in X$ such that $X - x \mapsto_\mu Y' - y = Y$, or $y' \in Y_0 \setminus Y'$ such that $X \mapsto_\mu Y' - y + y'$. However, in the latter case $(X, Y, Y' - y + y')$ contradicts the minimality assumption, so the former must hold. Thus we have $W \mapsto_\lambda X$ and $X - x \mapsto_\mu Y \mapsto_\nu Z$, which implies $W \mapsto_{\lambda \bullet_{0,1} (\mu \circ \nu)} Z$. This completes the proof of (A).

Next we prove (B). Suppose that $W \mapsto_{(\lambda \circ \mu) \bullet_{1,1} \nu} Z$. Then there exists X, Y, Y' such that $W \mapsto_\lambda X \mapsto_\mu Y', Y \mapsto_\nu Z$, and $Y = Y' - y_1 + y_2$ for some $y_1 \in Y', y_2 \in \bar{Y}'$. As before, we may assume that (10.1) holds.

First note that y_1 and y_2 are not exchangeable in either $X \mapsto_{\mu} Y'$ or $Y \mapsto_{\nu} Z$. Otherwise, we have $W \mapsto_{\lambda} X \mapsto_{\mu} Y \mapsto_{\nu} Z$ or $W \mapsto_{\lambda} X \mapsto_{\mu} Y' \mapsto_{\nu} Z$; in either case, this contradicts the assumption $\lambda \circ \mu \circ \nu = 0_{AD}$.

We now proceed as in the proof of (A). If $y_1 \in Y_0$ or $y_2 \in \overline{Y_0}$, then using the exchange axiom, we obtain a contradiction with either the minimality assumption, or with the hypotheses $(\lambda \circ \mu) \bullet_{1,0} \nu = (\lambda \circ \mu) \bullet_{0,1} \nu = 0_{AD}$. Therefore $y_1 \in \overline{Y_0}$ and $y_2 \in Y_0$, and by the exchange axiom and the minimality assumption, there exist $x_1 \in X$ and $x_2 \in \overline{X}$ such that $X - x_1 \mapsto_{\mu} Y' - y_1$ and $X + x_2 \mapsto_{\mu} Y' + y_2$.

Now apply the exchange axiom to this pair: we must have either $X - x_1 + x_2 \mapsto_{\mu} Y' - y_1 + y_2 = Y$ or $X \mapsto_{\mu} Y' - y_1 + y_2 = Y$. However, by definition, the latter implies that y_1 and y_2 are exchangeable in $X \mapsto_{\nu} Y'$. Therefore the former must be true; hence $W \mapsto_{\lambda} X$ and $X - x_1 + x_2 \mapsto_{\mu} Y \mapsto_{\nu} Z$, which implies $W \mapsto_{\lambda \bullet_{1,1}(\mu \circ \nu)} Z$. This completes the proof of (B). \square

Lemma 10.2. *Suppose $\mu \circ \nu \neq 0_{BD}$ and $\mu \bullet_{k,l} \nu \neq 0_{BD}$, where k, l are non-negative integers. Then at least one of the following must be true.*

- (a) $(k, l) = (0, 0)$.
- (b) $k > 0$ and $\mu \bullet_{k-1,l} \nu \neq 0_{BD}$.
- (c) $l > 0$ and $\mu \bullet_{k,l-1} \nu \neq 0_{BD}$.
- (d) $k > 0, l > 0$ and $\mu \bullet_{k-1,l-1} \nu \neq 0_{BD}$.

Proof. Fix $X_0 \mapsto_{\mu} Y_0 \mapsto_{\nu} Z_0$, and suppose $X \mapsto_{\mu \bullet_{k,l} \nu} Z$. Then there exists Y, Y' such that $X \mapsto_{\mu} Y', Y \mapsto_{\nu} Z, |Y \setminus Y'| = k, |Y' \setminus Y| = l$. Subject to these conditions, assume Y, Y' are chosen so that the minimality condition (10.1) holds.

Suppose there exists $y \in Y \setminus (Y' \cup Y_0)$. We claim that either (b) or (d) must hold. Using the exchange axiom on $Y \mapsto_{\nu} Z$ and $Y_0 \mapsto_{\nu} Z_0$ there exists either $z \in Z$ such that $Y - y \mapsto_{\nu} Z - z$, or $y' \in Y_0 \setminus Y$ such $Y - y + y' \mapsto_{\nu} Z$. In the former case we have $X \mapsto_{\mu} Y'$ and $Y - y \mapsto_{\nu} Z - z$ which implies that (b) holds. In the latter case, we cannot have $y' \in \overline{Y'}$ as this would contradict the minimality assumption. So $y' \in Y'$ and $X \mapsto_{\mu} Y', Y - y + y' \mapsto_{\nu} Z$ shows that (d) holds. This proves the claim.

If there exists $y \in \overline{Y} \setminus (\overline{Y'} \cup \overline{Y_0})$, we use the argument above with $(\overline{\mu}, \overline{\nu})$ in place of (μ, ν) and $(\overline{X_0}, \overline{Y_0}, \overline{Z_0}, \overline{X}, \overline{Y'}, \overline{Y}, \overline{Z})$ in place of $(X_0, Y_0, Z_0, X, Y', Y, Z)$. We conclude that either (c) or (d) must hold. Similarly, if there exists $y \in Y' \setminus (Y \cup Y_0)$, then applying the same argument to $(\nu^{\dagger}, \mu^{\dagger})$ and $(Z_0, Y_0, X_0, Z, Y, Y', X)$ we again find that (c) or (d) holds. If there exists $y \in \overline{Y'} \setminus (\overline{Y} \cup \overline{Y_0})$, then applying the argument to $(\overline{\nu}^{\dagger}, \overline{\mu}^{\dagger})$ and $(\overline{Z_0}, \overline{Y_0}, \overline{Z_0}, \overline{Z}, \overline{Y}, \overline{Y'}, \overline{X})$, we find that either (b) or (d) holds. Here we are implicitly using the fact that the minimality condition (10.1) is symmetric with respect to both $Y \leftrightarrow Y'$ and $(Y_0, Y', Y) \leftrightarrow (\overline{Y_0}, \overline{Y'}, \overline{Y})$, so that the argument is indeed valid in all of these variations.

Finally, if all of the sets $Y \setminus (Y' \cup Y_0), \overline{Y} \setminus (\overline{Y'} \cup \overline{Y_0}), Y' \setminus (Y \cup Y_0), \overline{Y'} \setminus (\overline{Y} \cup \overline{Y_0})$ are empty, then $Y = Y'$, and so (a) holds. \square

In the following arguments, we make frequent and implicit use Proposition 6.3. We write $\eta^{k,l} \in \text{Mor}_{\text{Mtd}^\circ}(E, E)$ to mean a morphism which is a \circ -composition of k factors of $\eta \in \text{Mor}_{\text{Mtd}^\circ}(E, E)$ and l factors of $\eta^\dagger \in \text{Mor}_{\text{Mtd}^\circ}(E, E)$. The set of points E will be either B or C , as can be determined from context. We also use the notation $\eta^{(\lambda:\mu)} := \eta^{k,l}$, in the case where $(k, l) = \langle \lambda : \mu \rangle$.

Lemma 10.3. *Suppose $\lambda \circ \mu \neq 0_{AC}$, $\mu \circ \nu \neq 0_{BD}$. Then $(\lambda \circ \mu) \bullet \nu$ and $\lambda \bullet (\mu \circ \nu)$ have the same type (k, l) , and*

$$(\lambda \circ \mu) \bullet_{k,l} \nu = \lambda \bullet_{k,l} (\mu \circ \nu).$$

Proof. We assume, without loss of generality, that

$$|\lambda \circ \mu : \nu| \leq |\lambda : \mu \circ \nu|. \quad (10.2)$$

Let $(k, l) = \langle \lambda \circ \mu : \nu \rangle$. By definition, $(\lambda \circ \mu) \bullet_{k,l} \nu \neq 0_{AD}$, and therefore $\mu \bullet_{k,l} \nu \neq 0_{BD}$. We proceed by induction on $|\lambda \circ \mu : \nu| = k + l$. If $(k, l) = (0, 0)$ the result follows from the associativity of \circ . Otherwise, one of statements (b), (c) or (d) of Lemma 10.2 is true.

Suppose (b) is true, i.e. $\mu \bullet_{k-1,l} \nu \neq 0_{BD}$. Let $\mu' = \mu \circ \eta^{k-1,l}$, and let $\lambda' = \lambda \circ \eta$. Then $(\lambda \circ \mu) \bullet_{k,l} \nu = \lambda \circ \mu \circ \eta^{k-1,l} \circ \eta \circ \nu = (\lambda \circ \mu') \bullet_{1,0} \nu$ is non-zero. In particular $\lambda \circ \mu' \neq 0_{BD}$, and $\mu' \circ \nu \geq \mu \bullet_{k-1,l} \nu \neq 0_{BD}$. Finally $\lambda \circ \mu' \circ \nu = (\lambda \circ \mu) \circ \eta^{k-1,l} \circ \nu = 0_{AC}$, since otherwise we would have $|\lambda \circ \mu : \nu| \leq k-1+l$. Thus λ, μ', ν satisfy the hypotheses of Lemma 10.1. Applying part (i) of the lemma, we deduce that

$$(\lambda \circ \mu) \bullet_{k,l} \nu = (\lambda \circ \mu') \bullet_{1,0} \nu = \lambda \bullet_{1,0} (\mu' \circ \nu) = (\lambda' \circ \mu) \circ \eta^{k-1,l} \circ \nu.$$

Since the expression above is non-zero, $|\lambda' \circ \mu : \nu| \leq k+l-1$. By induction, $|\lambda' : \mu \circ \nu| = |\lambda' \circ \mu : \nu|$, and $(\lambda' \circ \mu) \bullet \nu$ has the same type as $\lambda' \bullet (\mu \circ \nu)$. Since $\lambda' = \lambda \circ \eta$, we must have $\langle \lambda : \mu \circ \nu \rangle \leq \langle \lambda' : \mu \circ \nu \rangle + (1, 0)$. Therefore $|\lambda : \mu \circ \nu| \leq |\lambda' : \mu \circ \nu| + 1 \leq k+l = |\lambda \circ \mu : \nu|$. By (10.2), all of these inequalities must be equalities. Therefore, $(\lambda' \circ \mu) \bullet \nu$ and $\lambda' \bullet (\mu \circ \nu)$ both have type $(k-1, l)$, and $(\lambda' \circ \mu) \circ \eta^{k-1,l} \circ \nu = (\lambda' \circ \mu) \bullet_{k-1,l} \nu$. By induction,

$$(\lambda \circ \mu) \bullet_{k,l} \nu = (\lambda' \circ \mu) \bullet_{k-1,l} \nu = \lambda' \bullet_{k-1,l} (\mu \circ \nu) = \lambda \circ \eta \circ \eta^{k-1,l} \circ (\mu \circ \nu).$$

Since the expression above is non-zero, and $|\lambda : \mu \circ \nu| = k+l$, we conclude that (k, l) is the type of $\lambda \bullet (\mu \circ \nu)$, and $(\lambda \circ \mu) \bullet_{k,l} \nu = \lambda \bullet_{k,l} (\mu \circ \nu)$.

Similarly if (c) is true, we consider $\mu' = \mu \circ \eta^{k,l-1}$, $\lambda' = \lambda \circ \eta^\dagger$ and proceed as above, this time using Lemma 10.1(ii).

If neither (b) nor (c) is true, then (d) must be true. In this case we consider $\mu' = \mu \circ \eta^{k-1,l-1}$, $\lambda' = \lambda \circ \eta^{1,1}$. Since neither (b) nor (c) is true, $\mu' \bullet_{1,0} \nu = \mu' \bullet_{0,1} \nu = 0_{BD}$, which implies $\lambda \circ \mu' \circ \eta \circ \nu = \lambda \circ \mu' \circ \eta^\dagger \circ \nu = 0_{AD}$, and hence $(\lambda \circ \mu') \bullet_{1,0} \nu = (\lambda \circ \mu') \bullet_{0,1} \nu = 0_{AD}$. Thus we can apply Lemma 10.1(iii), and proceed as in the other two cases. \square

Proof of Theorem 6.4(ii) and (iii). Let $\lambda' = \lambda \circ \eta^{(\lambda:\mu)}$, and $\nu' = \eta^{(\mu:\nu)} \circ \nu$. Then $\lambda' \circ \mu = \lambda \bullet \mu \neq 0_{AC}$ and $\mu \circ \nu' = \mu \bullet \nu \neq 0_{BD}$. By Lemma 10.3,

$$(\lambda \bullet \mu) \bullet \nu = (\lambda' \circ \mu) \bullet_{k,l} \nu' = \lambda' \bullet_{k,l} (\mu \circ \nu') = \lambda \bullet (\mu \bullet \nu),$$

where (k, l) is equal to each of the following:

- $\langle \lambda' \circ \mu : \nu' \rangle$
- $\langle \lambda' : \mu \circ \nu' \rangle$
- $\langle \lambda \bullet \mu : \nu \rangle - \langle \mu : \nu \rangle$
- $\langle \lambda : \mu \bullet \nu \rangle - \langle \lambda : \mu \rangle$.

Thus \bullet is associative, and additivity of types follows from the equality of the last two quantities above. \square

References

- [1] J. Borcea and P. Brändén, *The Lee–Yang and Pólya–Schur programs I: linear operators preserving stability*, *Invent. Math.* **177** (2009), 541–569.
- [2] P. Brändén and J. Huh, *Lorentzian polynomials*, *Ann. Math.*, **192** (2020), 821–891.
- [3] Y.-B. Choe, J. G. Oxley, A. D. Sokal, and D. G. Wagner, *Homogeneous multivariate polynomials with the half-plane property*, *Adv. in Appl. Math.* **32** (2004), 88–187.
- [4] J. Edmonds, *Submodular functions, matroids, and certain polyhedra*, in “Combinatorial Structures and Their Applications” (R. Guy, H. Hanani, N. Sauer and J. Schonheim, Eds.) Gordon and Breach, New York, 1970, pp. 69 – 87.
- [5] I. Gessel and G. Viennot, *Binomial determinants, paths, and hook length formulae*, *Adv. in Math.*, **58** (1985), 300–321.
- [6] C. Heunen and V. Patta, *The Category of Matroids*, *Appl. Categor. Struct.* **26** (2018), 205–237.
- [7] J. P. S. Kung, *Bimatroids and invariants*, *Adv. in Math.*, **30** (1978), 238–249.
- [8] B. Lindström. *On the vector representations of induced matroids*, *Bull. London Math. Soc.*, **5** (1972), 85–90.
- [9] S. Mac Lane, *Categories for the working mathematician* (2nd ed.), Springer-Verlag, New York, (1998).
- [10] K. Murota, *Discrete convex analysis*, SIAM Monographs on Discrete Mathematics and Applications, Society for Industrial and Applied Mathematics (SIAM), Philadelphia, 2003.

- [11] P. Nelson, *Almost all matroids are non-representable*, Bull. London Math. Soc. **50** (2018), 245–248.
- [12] nLab authors, *Category* (website), <https://ncatlab.org/nlab/show/category>.
- [13] J. G. Oxley, *Matroid Theory*, Oxford University Press, second edition, 2011.
- [14] H. Perfect, *Applications of Menger’s graph theorem*, J. Math. Anal. Appl. **22** (1968), 96–111.
- [15] A. Postnikov, *Total positivity, Grassmannians, and networks*, arXiv:0609764, (2006).
- [16] A. Postnikov, *Permutohedra, associahedra, and beyond*, Int. Math. Res. Not. (2009), 1026–1106.
- [17] K. Purbhoo, *Total Nonnegativity and Stable Polynomials*, Canad. Math. Bull. **61** (2018), 836–847.
- [18] J. S. Pym, *The Linking of Sets in Graphs*, J. London Math. Soc. **44** (1969), 542–550.
- [19] A. Schrijver, *Matroids and linking systems*, J. Combin. Theory Ser. B **26** (1979) 349–369.
- [20] K. Talaska, *Determinants of weighted path matrices*, arXiv:1202.3128, (2012).
- [21] D. G. Wagner, *Multivariate stable polynomials: Theory and applications*, Bull. Amer. Math. Soc. **48** (2011), 53–84.

K. PURBHOO, COMBINATORICS AND OPTIMIZATION DEPARTMENT, UNIVERSITY OF WATERLOO, WATERLOO, ON, N2L 3G1, CANADA. kpurbhoo@uwaterloo.ca.