

A game-theoretic approach to the asymptotic behavior of solutions to an obstacle problem for the mean curvature flow equation

Kuniyasu Misu

email: kuniyasu.misu@math.sci.hokudai.ac.jp

Abstract

We consider the asymptotic behavior of solutions to an obstacle problem for the mean curvature flow equation by using a game-theoretic approximation, to which we extend that of Kohn and Serfaty [14]. The paper [14] gives a deterministic two-person zero-sum game whose value functions approximate the solution to the level set mean curvature flow equation without obstacle functions. We prove that moving curves governed by the mean curvature flow converge in time to the boundary of the convex hull of obstacles under some assumptions on the initial curves and obstacles. Convexity of the initial set, as well as smoothness of the initial curves and obstacles, are not needed. In these proofs, we utilize properties of the game trajectories given by very elementary game strategies and consider reachability of each player. Also, when the equation has a driving force term, we present several examples of the asymptotic behavior, including a problem dealt in [9].

Keywords— Viscosity solutions, Mean curvature flow equation, Asymptotic shape, Large time behavior, Deterministic game

Mathematics Subject Classification 2020— 35B40, 35D40, 91A50

1 Introduction

Obstacle problem for the mean curvature flow equation. We consider the following obstacle problem for the mean curvature flow equation:

$$\begin{cases} V = -\kappa \text{ on } \partial D_t, \\ O_- \subset D_t, \end{cases} \quad (1.1)$$

where $\{D_t\}_{t>0}$ is the unknown family of open sets in \mathbb{R}^d , V is the velocity of a point in ∂D_t in the direction of its outward normal vector, κ is the mean curvature of ∂D_t at the point and O_- is a fixed open set in \mathbb{R}^d . Our main goal is to investigate the asymptotic behavior of solutions to (1.1) by the level set equation and its game-theoretic approximation. We mainly deal with the case $d = 2$ in this manuscript.

The mean curvature flow equation has been attracting much attention. In the early stages, the smoothness of the initial surface was naturally assumed and the surface evolution was considered as long as singularities do not occur. In particular when $d = 2$, the mean curvature flow equation is often called *the curve shortening problem* and the curve evolution was analysed in e.g. [6, 11].

The level set method for surface evolution equations was first rigorously analyzed in [3, 5]. The basic idea of this method is to represent moving surfaces as level sets of auxiliary functions and to rewrite surface evolution equations by level set equations, whose unknown functions are the auxiliary functions. A great advantage is the point that viscosity solutions of level set equations follow the long time behavior of the moving surfaces even after topological change of surfaces. The level set method is applied to various surface evolution equations including the mean curvature flow equation. See also [7] in detail.

Recently obstacle problems for the mean curvature flow equation have been considered in [10, 13, 21]. Obstacle problems are problems that have regions called obstacles which the solutions cannot exceed.

According to the unpublished paper [20] by Mercier, the level set method is still valid for (1.1). The corresponding level set equation to (1.1) is the following:

$$\begin{cases} u_t(x, t) + F(Du(x), D^2u(x)) = 0 & \text{in } \mathbb{R}^d \times (0, \infty), \\ u(x, 0) = u_0(x) & \text{in } \mathbb{R}^d, \\ \Psi_-(x) \leq u(x, t) & \text{in } \mathbb{R}^d \times (0, \infty), \end{cases} \quad (1.2)$$

where $\Psi_- \in Lip(\mathbb{R}^d)$ is a given obstacle function that satisfies $O_- = \{x \in \mathbb{R}^d \mid \Psi_-(x) > 0\}$. The function $u_0 \in C(\mathbb{R}^d)$ is an initial datum and F is given by

$$F(Du, D^2u) = -|Du| \operatorname{div} \left(\frac{Du}{|Du|} \right).$$

Namely F is the level-set mean curvature flow operator defined as

$$F(p, X) = -\operatorname{Tr} \left(\left(I - \frac{p \otimes p}{|p|^2} \right) X \right), \quad p \in \mathbb{R}^d \setminus \{0\}, \quad X \in \mathbb{S}^d,$$

where $p \otimes p = (p_i p_j)_{i,j=1}^d$ for a vector $p = (p_1, \dots, p_d) \in \mathbb{R}^d$ and \mathbb{S}^d is the set of $d \times d$ real symmetric matrices. For a comparison principle to (1.2), see also [13].

Throughout this paper we follow the 0 level set of the solution u . Together with it, we assume on the initial data u_0 as follows:

$$\text{For some } a < 0 \text{ and } R > 0, \quad u_0 = a \text{ in } B^c(0, R). \quad (1.3)$$

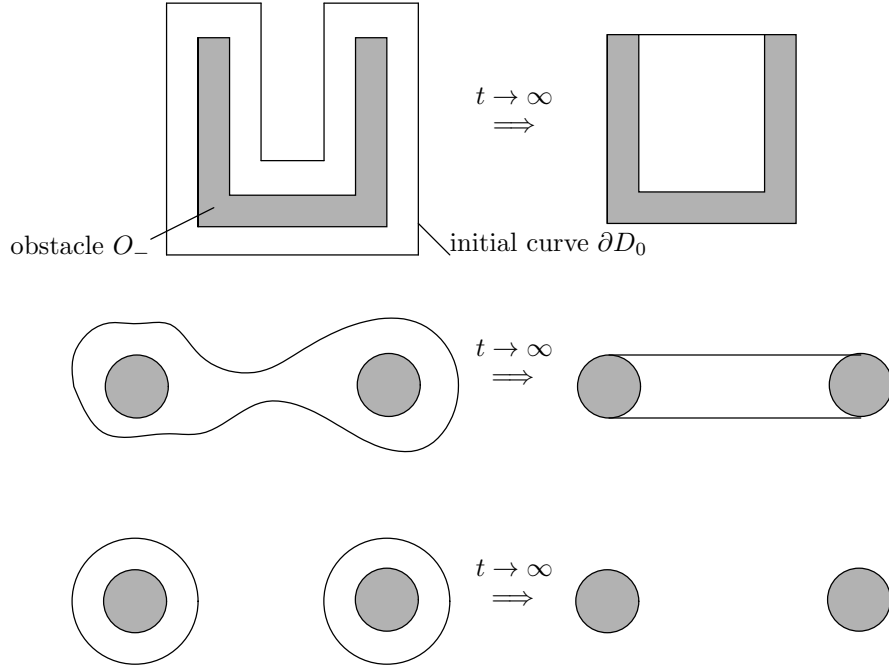

Figure 1: Conjectures on the asymptotic shapes

Intuitive observation. For the solution to (1.1) with $d = 2$ and without obstacles, it is known that D_t becomes convex at some time, the moving curve ∂D_t converges to a single point and then vanishes, provided ∂D_0 is a smooth closed curve ([6, 11]). On the other hand, for our problem (1.1), it is obvious that the solution does not converge to any single point. Also it is not clear whether D_t becomes convex at some time. However it is natural to expect that in many cases D_t converges to the convex hull of O_- , which we hereafter denote by $Co(O_-)$, as $t \rightarrow \infty$ because of the curve shortening property of the solution and the smoothing effect of the curvature flow as we draw some examples in Figure 1. As shown in Figure 1, even for the same obstacles, different initial curves may converge to different limits. Thus we shall assume at least that one connected component of D_0 contains the whole O_- and expect that the asymptotic shape is $Co(O_-)$ under this assumption. Our main theorem (Theorem 3.2) is intended to justify this expectation as much as possible.

Game interpretation. Our first result is the extension of [14] to problems including (1.2). First, let us briefly explain the game rule for (1.2) with $d = 2$ and without obstacle function by following [14, Section 1.6]. The game is a deterministic two-person zero-sum game. For convenience, we name the first player Paul and the second player Carol. Let $\epsilon > 0$. Also, let $x_0 = x \in \mathbb{R}^2$ be the initial position of this game and $t > 0$ be the terminal time. At the i -th round of this game, Paul chooses directions $v_i \in \mathbb{R}^2$ with $|v_i| = 1$ and Carol chooses a number $b_i = \pm 1$ after Paul's choice. Then the game position that we henceforth regard as Paul's position conveniently moves from x_{i-1} to the next place x_i depending on their choice as follows:

$$x_i = x_{i-1} + \sqrt{2}\epsilon b_i v_i \quad (1.4)$$

After the N -th round, where $N \sim t\epsilon^{-2}$, the game ends and Carol pays the terminal cost $u_0(x_N)$ to Paul. Paul's goal is maximizing the cost while Carol's goal is minimizing it. The value function $u^\epsilon(x, t)$ is defined as the cost optimized by both the players, that is,

$$u^\epsilon(x, t) = \max_{v_1} \min_{b_1} \dots \max_{v_N} \min_{b_N} u_0(x_N).$$

This value function approximates the viscosity solution u of (1.2) with $d = 2$ and without obstacle function. In fact the convergence $u^\epsilon \rightarrow u$ is shown in [14].

In order to handle (1.2) that has the obstacle function Ψ_- , we modify the game rule as follows. At each i -th round, we suppose that Paul has the right to quit the game. If Paul quits the game, the game cost is given by $\Psi_-(x_i)$. By doing this modification, the value function u^ϵ is restricted to $\Psi_- \leq u^\epsilon$. Such an interpretation of parameters of PDEs is well understood for first order equations; see [1]. The cost $\Psi_-(x_i)$ is called *stopping cost* and an optimal control problem with stopping cost is called *optimal stopping time problem*. For second order equations, see e.g. [18, 4], which deal with the optimal stopping time problem corresponding to the obstacle problem for the infinity Laplacian equation and p-Laplacian equation respectively.

The value function $u^\epsilon(x, t)$ satisfies the following *Dynamic Programming Principle*:

$$u^\epsilon(x, t) = \max\{\Psi_-(x), \max_{|v|=1} \min_{b=\pm 1} u^\epsilon(x + \sqrt{2}\epsilon bv, t - \epsilon^2)\}$$

for $t > 0$. This is a key equation in the proof of the convergence result.

The paper [14] also mention the game interpretation for higher dimensional case. Based on this, we can generalize our game to the case $d \geq 3$. In the game, Paul chooses $d-1$ orthogonal unit vectors v_i^j ($j = 1, 2, \dots, d-1$), Carol chooses $d-1$ values $b_i^j \in \{\pm 1\}$ ($j = 1, 2, \dots, d-1$), and the state equation is $x_i = x_{i-1} + \sqrt{2}\epsilon \sum_{j=1}^{d-1} b_i^j v_i^j$ instead of (1.4).

The precise statement of the convergence of the value functions is described by the half relaxed limits of the value functions, which are defined as follows:

$$\bar{u}(x, t) := \overline{\lim}_{\substack{(y,s) \rightarrow (x,t) \\ \epsilon \searrow 0}} u^\epsilon(y, s), \quad \underline{u}(x, t) := \underline{\lim}_{\substack{(y,s) \rightarrow (x,t) \\ \epsilon \searrow 0}} u^\epsilon(y, s).$$

As a consequence of Proposition A.3, we present the convergence result for (1.2) at the moment. We describe a game interpretation and the same type of convergence result for more general PDEs than (1.2) in Appendix A.

Proposition 1.1. *The functions \bar{u} and \underline{u} are respectively viscosity sub- and supersolution of (1.2). Moreover $\bar{u}(x, 0) = \underline{u}(x, 0) = u_0(x)$ for $x \in \mathbb{R}^d$.*

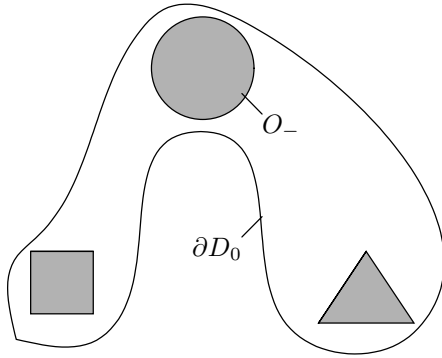

Figure 2: Example of D_0 and O_-

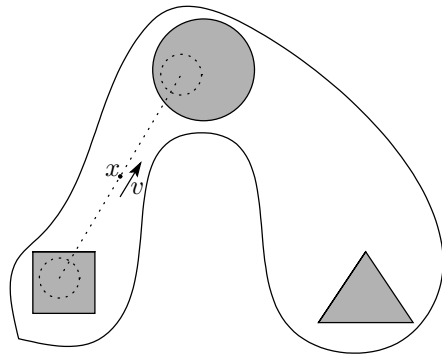

Figure 3: Strategy

Asymptotic behavior. We study the asymptotic behavior of solutions to (1.1). To explain an outline of the proof of the main theorem (Theorem 3.2), at the moment, we identify u^ϵ with u and consider a specific figure (Figure 2). Since we consider 0 level set of solutions to (1.2), our concern is whether the game cost is positive or negative. Thus, from Paul's point of view, the victory condition is that the game cost becomes positive. Namely, from Carol's point of view, the victory condition is that the game cost becomes negative. There is no need to give optimal strategies. Hereafter, even if a strategy taken by the players is not optimal, we often use present tense such as "Paul takes some strategy when he is in some domain". To show that the asymptotic shape is $Co(O_-)$, we have to prove that Paul wins if he starts from $Co(O_-)$ and Carol wins if Paul starts from $\overline{Co(O_-)}^c$. (We avoid the argument on the boundary of $Co(O_-)$.) Furthermore, by the rule of the game explained above, we see that the victory condition of Paul is whether he reaches O_- at some round or D_0 at the final round.

The easiest situation for Paul is that the initial game position $x \in O_-$. In this case, it suffices for Paul to quit the game at the first round and gain the stopping cost $\Psi_-(x) > 0$. If we take x as shown in Figure 3, a strategy for Paul to win is the following: He keeps taking v parallel to the dotted line segment as in Figure 3 until he reaches the domain inside the dotted circle. Once he gets there, he quits the game and gains the positive stopping cost. Even if he does not get there, he can gain the positive terminal cost at the final round of the game because the dotted line segment in Figure 3 is contained in D_0 .

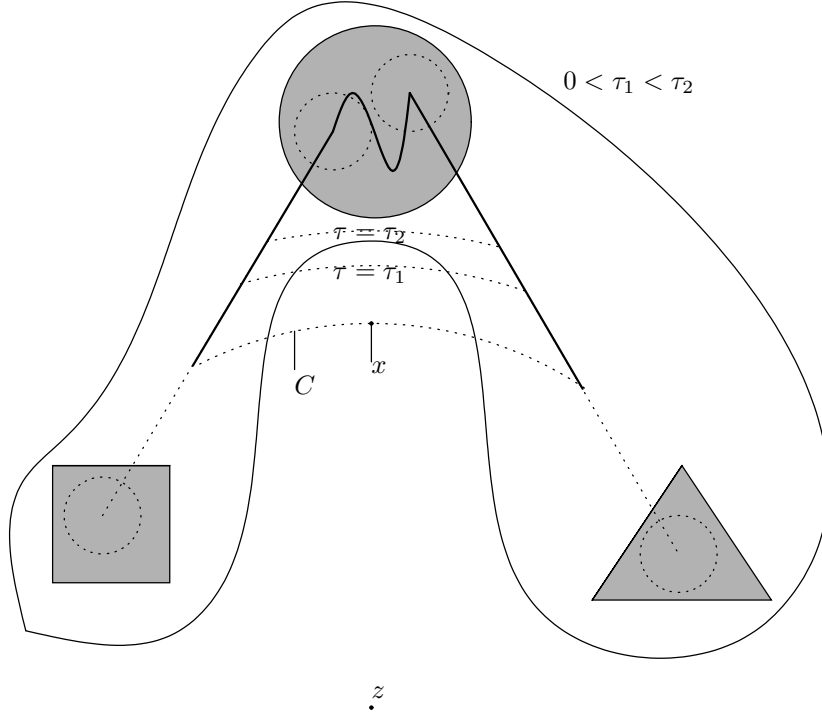

Figure 4: Strategy for $x \in Co(O_-)$

For the other $x \in Co(O_-)$, we consider a strategy for Paul to reach the domain from where we above overview that he could win if he started. To construct it, we prepare a type of strategies of the game called *concentric strategy*, which is also introduced in [14] and [16, Lemma 2.5 2.6]. See Definition 2.5. If Paul takes a concentric strategy, he can choose his favorable point $z \in \mathbb{R}^2$ and can control the distance from z to game positions regardless of Carol's choices as follows:

$$|x_n - z| = \sqrt{|x_0 - z|^2 + 2n\epsilon^2}.$$

In particular $|x_n - z|$ is monotonically increasing with respect to n and, denoting the game time $n\epsilon^2$ by τ , it goes to infinity as $\tau \rightarrow \infty$. Figure 4 shows an example of $x \in Co(O_-)$ and an appropriate concentric strategy. In Figure 4 the center of the arc C is z . Paul's strategy is to choose this z and keep taking the concentric strategy until he reaches a neighborhood of the bold curve in D_0 . Since the domain enclosed by the arc C and the bold curve is bounded, he indeed reaches a neighborhood of the bold curve. Therefore he wins if he starts at this initial position x .

In the main theorem we state a condition on D_0 and O_- that we are able to apply above technique. To indicate above bounded domain, we construct an appropriate Jordan closed curve in the proof and Appendix D and then use the Jordan curve theorem.

One also define a concentric strategy of Carol (Definition 2.5) that has similar effect to that of Paul. Namely if Carol chooses a point z and takes the concentric strategy, she can force the distance $|x_n - z|$ to be monotonically increasing with respect to n and go to infinity as $\tau \rightarrow \infty$. For $x \in \overline{Co(O_-)}^c$ we can take an open ball B such that $\overline{Co(O_-)} \subset B$ and $x \in B^c$ by the hyperplane separation theorem and the boundedness of $\overline{Co(O_-)}$. If Carol chooses z and takes the concentric strategy, she wins for sufficiently large τ owe to the boundedness of D_0 . If we assume a kind of strict convexity on the obstacle O_- , we can take above open ball B for $x \in \overline{Co(O_-)}^c$ whose radius does not depend on x . This means that the moving surface sticks to the obstacle in finite time (Theorem 3.7).

Literature. We give some other related works on the asymptotic behavior of solutions to obstacle problems for the mean curvature flow equation. Spadaro considers (1.1) to characterize the mean-convex hull set in his unpublished paper [22]. He considers (1.1) by a variational discrete scheme, which is different from our approach, but is guaranteed to approximate the viscosity solution to (1.2) by [20]. According to [22], the part of the limit

hypersurface that does not touch the obstacle is a minimal surface. (This result enhances the plausibility of our expectation.) Compared to our result, his result works in higher dimensional case $d \leq 7$, while it needs to assume at least that the initial set D_0 is convex when $d = 2$. For $d \geq 8$, [23, Proposition 4.2] implies that the limit hypersurface may have non empty boundary. [21] proves the convergence of moving surfaces in a situation that both initial surface and obstacles are given as periodic graphs. For problems with driving force, [10] proves the solution $u(x, t)$ to the problem (2.1) with $f = 0$ (We will introduce it later.) converges as $t \rightarrow \infty$ to the stationary solution. They also give the result concerning to the shape of the stationary solution. However it is limited to the case where the initial data and the obstacle function are radially symmetric.

Concerning to an approach other than the level set method, Takasao [24] considers an obstacle problem for the mean curvature flow equation in the sense of Brakke's mean curvature flow ([2]). He proves the global existence of the weak solution by using the Allen-Cahn equation with forcing term.

While [13, 24] and this paper consider given obstacle problems, they arise from many different situations. In [9] an obstacle problem naturally appears in the motion of the top and the bottom of the solution of birth and spread type equations though the equations have no obstacle functions. [17] shows that large exponent limit of power mean curvature flow equation is formulated by an obstacle problem involving 1-Laplacian.

Organization. This paper is organized as follows. Section 2 contains definitions, notations and lemmas that are needed to prove our results. In Section 3 we prove the theorems on the asymptotic shape of the solution to (1.1). Section 4 is devoted to compute several examples of asymptotic shapes of solutions to problems with driving force. The convergence of the value functions of the game and some arguments to complement the proof of the main theorem are presented in appendices.

2 Preliminary result

2.1 Definitions and notations

In this subsection we introduce the notion of viscosity solution to the following obstacle problem, which is the most general form in this manuscript. Moreover we remark some known results.

$$\begin{cases} u_t(x, t) - \nu|Du(x, t)| + F(Du(x, t), D^2u(x, t)) = f(x) & \text{in } \mathbb{R}^d \times (0, \infty), \\ u(x, 0) = u_0(x) & \text{in } \mathbb{R}^d, \\ \Psi_-(x) \leq u(x, t) \leq \Psi_+(x) & \text{in } \mathbb{R}^d \times (0, \infty), \end{cases} \quad (2.1)$$

where $\Psi_+, \Psi_- \in Lip(\mathbb{R}^d)$ are obstacle functions which satisfy $\Psi_- \leq \Psi_+$ in \mathbb{R}^d . A real number ν is a constant and f is a locally bounded function. This equation without obstacles is a birth and spread type equation introduced in [9]. Though the source term f is not considered in the proof of the main theorem, we take it into consideration in Appendix A to prepare for the forthcoming paper "Asymptotic shape of solutions to the mean curvature flow equation with discontinuous source terms" by Hamamuki and the author. We do so all the more because it is natural extension in light of optimal control theory.

We denote the upper and lower semicontinuous envelope of u by u^* and u_* respectively.

Definition 2.1 (Viscosity solution). 1. A function u is a viscosity subsolution of (2.1) if it satisfies the following conditions.

- (a) $\Psi_-(x) \leq u^*(x, t) \leq \Psi_+(x)$ for all $(x, t) \in \mathbb{R}^d \times (0, \infty)$.
- (b) $u^*(x, 0) \leq u_0(x)$ for all $x \in \mathbb{R}^d$.
- (c) Whenever $\phi(x, t)$ is smooth, $u^* - \phi$ has a local maximum at $(x_0, t_0) \in \mathbb{R}^d \times (0, \infty)$ and $u^*(x_0, t_0) - \Psi_-(x_0) > 0$, we have

$$\phi_t(x_0, t_0) - \nu|D\phi(x_0, t_0)| + F_*(D\phi(x_0, t_0), D^2\phi(x_0, t_0)) \leq f^*(x_0).$$

- 2. A function u is a viscosity supersolution of (2.1) if it satisfies the following conditions.

- (a) $\Psi_-(x) \leq u_*(x, t) \leq \Psi_+(x)$ for all $(x, t) \in \mathbb{R}^d \times (0, \infty)$.
- (b) $u_*(x, 0) \geq u_0(x)$ for all $x \in \mathbb{R}^d$.
- (c) Whenever $\phi(x, t)$ is smooth, $u_* - \phi$ has a local minimum at $(x_0, t_0) \in \mathbb{R}^d \times (0, \infty)$ and $u_*(x_0, t_0) < \Psi_+(x_0)$, we have

$$\phi_t(x_0, t_0) - \nu|D\phi(x_0, t_0)| + F^*(D\phi(x_0, t_0), D^2\phi(x_0, t_0)) \geq f_*(x_0).$$

- 3. A function u is a viscosity solution of (2.1) if it is a viscosity subsolution and a viscosity supersolution of (2.1).

We now give the definition of solutions of the following surface evolution equation:

$$\begin{cases} V = -\kappa + \nu, & \text{on } \partial D_t, \\ O_- \subset D_t \subset O_+, \end{cases} \quad (2.2)$$

where $\{D_t\}_{t>0}$ is the unknown family of open sets in \mathbb{R}^d . Furthermore O_- and O_+ are fixed open sets in \mathbb{R}^d . We also introduce the closed version of (2.2):

$$\begin{cases} V = -\kappa + \nu, & \text{on } \partial E_t \\ C_- \subset E_t \subset C_+, \end{cases} \quad (2.3)$$

where $\{E_t\}_{t>0}$ is the unknown family of closed sets in \mathbb{R}^d . C_- and C_+ are fixed closed sets in \mathbb{R}^d . The PDE (2.1) with $f = 0$ is the level set equation for these surface evolution equations. Since we only consider bounded initial surfaces in this manuscript, we employ the following class of solutions:

$$K_a(\mathbb{R}^d \times [0, \infty)) := \{u \in C(\mathbb{R}^d \times [0, \infty)) \mid \forall T > 0 \exists R > 0 \text{ s.t. } u = a \text{ in } B_R^c(0) \times [0, T]\}.$$

- Definition 2.2.**
1. Let D_0 , O_- and O_+ be open sets in \mathbb{R}^d . A family of open sets $\{D_t\}_{t \geq 0}$ is called an *open evolution* of (2.2) with D_0 , O_- and O_+ if there exist $\Psi_-, \Psi_+ \in Lip(\mathbb{R}^d)$, $u_0 \in C(\mathbb{R}^d)$ and a solution $u \in K_a(\mathbb{R}^d \times [0, \infty))$ of (2.1) with Ψ_-, Ψ_+, u_0 and $f = 0$ such that $O_- = \{x \in \mathbb{R}^d \mid \Psi_-(x) > 0\}$, $O_+ = \{x \in \mathbb{R}^d \mid \Psi_+(x) > 0\}$ and $D_t = \{x \in \mathbb{R}^d \mid u(x, t) > 0\}$ for $t \geq 0$.
 2. Let E_0 , C_- and C_+ be closed sets in \mathbb{R}^d . A family of closed sets $\{E_t\}_{t \geq 0}$ is called a *closed evolution* of (2.3) with E_0 , C_- and C_+ if there exist $\Psi_-, \Psi_+ \in Lip(\mathbb{R}^d)$, $u_0 \in C(\mathbb{R}^d)$ and a solution $u \in K_a(\mathbb{R}^d \times [0, \infty))$ of (2.1) with Ψ_-, Ψ_+, u_0 and $f = 0$ such that $C_- = \{x \in \mathbb{R}^d \mid \Psi_-(x) \geq 0\}$, $C_+ = \{x \in \mathbb{R}^d \mid \Psi_+(x) \geq 0\}$ and $E_t = \{x \in \mathbb{R}^d \mid u(x, t) \geq 0\}$ for $t \geq 0$.

Remark 2.3. The open evolutions and the closed evolutions uniquely exist ([20]).

Remark 2.4. Our main equation in this manuscript is (1.1), which has an obstacle on one side. We interpret problems that have only O_- as (2.2) with $O_+ = \mathbb{R}^d$ and problems that have only O_+ as (2.2) with $O_- = \emptyset$.

Whenever we consider (2.2) in this manuscript, we simultaneously consider the solution $\{E_t\}_{t \geq 0}$ to (2.3) with $E_0 = \overline{D_0}$, $C_- = \overline{O_-}$ and $C_+ = \overline{O_+}$. Throughout the manuscript, we denote an open evolution by $\{D_t\}_{t \geq 0}$ and a closed evolution by $\{E_t\}_{t \geq 0}$. As explained above, we assume that D_0 is bounded.

Notations. For a point $z \in \mathbb{R}^d$, we denote the set $\{x \in \mathbb{R}^d \mid |x - z| < r\}$ by $B_r(z)$ or sometimes $B(z, r)$. For a set $S \subset \mathbb{R}^d$, we denote the set $\{x \in \mathbb{R}^d \mid \text{dist}(x, S) < r\}$ by $B_r(S)$. We denote by S^{d-1} the set of unit vectors in \mathbb{R}^d . The line segment with end points x and y will be denoted by $l_{x,y}$. When two lines l_1 and l_2 are parallel, we will write $l_1 \parallel l_2$. For a set A , we denote the convex hull of A by $Co(A)$. For a family of sets $\{D_t\}_{t \geq 0}$, we define

$$\overline{\lim}_{t \rightarrow \infty} D_t := \bigcap_{\tau > 0} \bigcup_{t > \tau} D_t, \quad \underline{\lim}_{t \rightarrow \infty} D_t := \bigcup_{\tau > 0} \bigcap_{t > \tau} D_t.$$

If $\overline{\lim}_{t \rightarrow \infty} D_t = \underline{\lim}_{t \rightarrow \infty} D_t$, we will write

$$\lim_{t \rightarrow \infty} D_t := \overline{\lim}_{t \rightarrow \infty} D_t = \underline{\lim}_{t \rightarrow \infty} D_t.$$

2.2 Basic strategy of the game

We prepare special strategies of both players that we explained in Section 1.

Definition 2.5 (Concentric strategy). Let $\epsilon > 0$ and $z \in \mathbb{R}^d$. Let $x \in \mathbb{R}^d$ be the current position of the game.

1. A set of $d - 1$ orthogonal unit vectors $v^j \in S^{d-1}$ ($j = 1, 2, \dots, d - 1$) chosen by Paul is called a *z concentric strategy* (by Paul) if $\langle v^j, x - z \rangle = 0$ for all j , where $\langle \cdot, \cdot \rangle$ stands for the Euclidean inner product.
2. Let $\{v^1, v^2, \dots, v^{d-1}\}$ be a choice by Paul in the same round. A choice $(b^1, b^2, \dots, b^{d-1}) \in \{\pm 1\}^{d-1}$ by Carol is called a *z concentric strategy* (by Carol) if $\langle b^j v^j, x - z \rangle \geq 0$ for all j .

One can easily understand the behaviors of trajectories given when one player takes above strategies. Let $d_n = |x_n - z|$ for fixed $z \in \mathbb{R}^d$. If Paul takes a *z concentric strategy* through the game, then we see that the sequence $\{d_n\}$ satisfies

$$R_{n+1} = \sqrt{R_n^2 + 2(d-1)\epsilon^2} \quad (2.4)$$

by the Pythagorean theorem regardless of Carol's choices. The solution $\{R_n\}$ of (2.4) is explicitly obtained by

$$R_n = \sqrt{R_0^2 + 2(d-1)n\epsilon^2}. \quad (2.5)$$

On the other hand, if Carol takes a z concentric strategy through the game, we have

$$\begin{aligned} \left| x + \sum_j (\sqrt{2}\epsilon b^j v^j) - z \right|^2 &= |x - z|^2 + 2(d-1)\epsilon^2 + \sum_j \sqrt{2}\epsilon \langle b^j v^j, x - z \rangle \\ &\geq |x - z|^2 + 2(d-1)\epsilon^2, \end{aligned}$$

which implies $d_{n+1} \geq \sqrt{d_n^2 + 2(d-1)\epsilon^2}$. Therefore we obtain $d_n \geq \sqrt{d_0^2 + 2(d-1)n\epsilon^2}$.

Remark 2.6. When Carol takes a z concentric strategy, she can control the distance $|x_n - z|$. However we notice that she can not control the moves in tangential direction. For instance, let $d = 2$, $z = (0, 0)$ and the current game position $x_n = (0, 1)$. If Paul chooses $v = (1, 0)$ at this point, both $b = 1$ and $b = -1$ are $(0, 0)$ concentric strategies by Carol. One may think that if Carol makes the further decision that for Paul's choice v tangential to the circle centered at the origin passing through x_n , she chooses b so that bv becomes clockwise, then she could control the trajectory of the game to be clockwise. However this is not true. Carol's greedy attempt to move as she pleases in the tangential direction will be thwarted by Paul. Indeed when Carol makes above decision, Paul can move counterclockwise while the distance $|x_n - z|$ meets almost the condition (2.5) by slightly leaning the vector v from tangential one. (e.g. $v = (\cos -\epsilon^2, \sin -\epsilon^2)$ at $x_n = (0, 1)$)

3 Asymptotic behavior of solutions

Throughout this section we consider the main equation (1.1).

In the following lemma, we estimate the asymptotic shape from above by considering Carol's strategies.

Lemma 3.1.

$$\overline{\lim}_{t \rightarrow \infty} E_t \subset Co(C_-).$$

Proof. Let u be the unique solution to (1.2) with u_0 and Ψ_- that are as in Definition 2.2. We notice that the conclusion holds if and only if for $x \in Co(C_-)^c$, there exists $\tau > 0$ such that $u(x, t) < 0$ for $t > \tau$. To prove $u^\epsilon < 0$, it is sufficient to give a Carol's strategy that makes the game cost negative but is not necessarily optimal one. For $x \in Co(C_-)^c$ we can take an open ball B such that $C_- \subset B$ and $x \in \partial B$ by the hyperplane separation theorem and the boundedness of $Co(C_-)$. Let z be the center of B and $r = |z - x|$. If Carol takes a z concentric strategy, then we see that regardless of Paul's choice, the game trajectory $\{x_n\}$ satisfies $|x_n - z| \geq \sqrt{r^2 + 2n(d-1)\epsilon^2}$, where $\sqrt{r^2 + 2n(d-1)\epsilon^2}$ is the solution of (2.4) with $R_0 = r$. Letting $\tau = 2R(R+r)/(d-1)$, we have

$$|x_N - z| \geq r + 2R \tag{3.1}$$

for the last position x_N of the game, where $R > 0$ is a constant taken in (1.3). The inequality (3.1) and $Co(C_-) \subset B$ imply $dist(x_N, Co(C_-)) \geq dist(x_N, B) \geq 2R$. Also $C_- \subset E_0 \subset B_R(0)$ implies $Co(C_-) \subset B_R(0)$. Hence we have $x_N \notin B_R(0)$, which means $u_0(x_N) = a < 0$ by (1.3). If Paul quits the game on the way, the stopping cost is at most

$$\sup_{b \in B^c} \Psi_-(b) < 0.$$

The comparison principle ([13]) for (1.2) and the convergence results in Appendix A imply that $u^\epsilon(x, t)$ converges to $u(x, t)$ locally uniformly in (x, t) . See also [1, Chapter V Lemma 1.9] if necessary. We also notice that the uniform boundedness of u^ϵ is satisfied owe to the rule of the game and the boundedness of u_0 and Ψ_- . Since both upper bound of the terminal cost a and that of the stopping cost $\sup_{b \in B^c} \Psi_-(b)$ do not depend on ϵ , we conclude that $u(x, t) < 0$ for $t > \tau$ and $x \in Co(C_-)^c$. \square

For an obstacle O_- and an initial set D_0 , we define the graph $G = (V, E)$ as follows:

$$V := \{O \subset \mathbb{R}^2 \mid O \text{ is a connected component of } O_-\},$$

$$E := \{\langle O, P \rangle \mid O, P \in V \text{ and } l_{x,y} \subset D_0 \text{ for some } x \in O \text{ and } y \in P\}.$$

See Appendix C for definitions of terms in graph theory.

Theorem 3.2. *Assume that $d = 2$ and the graph G is connected. Then*

$$Co(O_-) \subset \underline{\lim}_{t \rightarrow \infty} D_t \subset \overline{\lim}_{t \rightarrow \infty} D_t \subset \overline{Co(O_-)}$$

and

$$Co(O_-) \subset \underline{\lim}_{t \rightarrow \infty} E_t \subset \overline{\lim}_{t \rightarrow \infty} E_t \subset \overline{Co(O_-)}.$$

Remark 3.3. Figure 5 (resp. Figure 6) shows examples of D_0 and O_- that satisfy (resp. do not satisfy) the assumption of Theorem 3.2.

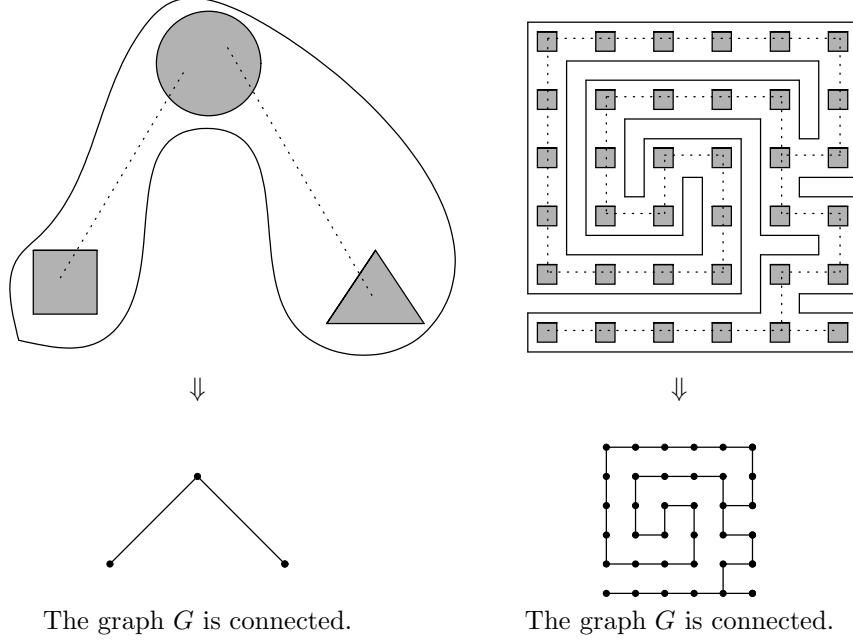

Figure 5: D_0 and O_- that satisfy the assumption of Theorem 3.2 (In this figure the loops of G are ignored.)

Proof. For D_0 and E_0 , we take u_0 as in Definition 2.2. Indeed it suffices to let

$$u_0(x) = \begin{cases} \text{dist}(x, \partial D_0), & x \in D_0 \\ \max\{a, -\text{dist}(x, \partial D_0)\}, & x \in D_0^c. \end{cases} \quad (3.2)$$

Similarly it suffices to let

$$\Psi_-(x) = \begin{cases} \text{dist}(x, \partial O_-), & x \in O_- \\ \max\{a, -\text{dist}(x, \partial O_-)\}, & x \in O_-^c. \end{cases} \quad (3.3)$$

By Lemma 3.1 and $D_t \subset E_t$, it suffices to prove $Co(O_-) \subset \varliminf_{t \rightarrow \infty} D_t$. Namely our goal is to prove that for $x \in Co(O_-)$, there exists $\tau > 0$ such that $u(x, t) > 0$ for $t > \tau$. To prove $u^\epsilon > 0$, it is sufficient to give a Paul's strategy, which makes the game cost positive and is not necessarily optimal one. Let $x \in Co(O_-)$. It would be convenient to introduce the set

$$L := \{z \in l_{x,y} \mid x, y \in O_-, l_{x,y} \subset D_0\}$$

in doing case analysis for $x \in Co(O_-)$.

1) $x \in O_-$. In this case, it suffices for Paul to quit the game at the first round and gain the stopping cost $\Psi_-(x) > 0$. Recall that $u^\epsilon(x, t)$ converges to $u(x, t)$ locally uniformly in (x, t) . Thus we obtain $u(x, t) > 0$ for any $t > 0$.

2) $x \in L \setminus O_-$. Let $z, w \in O_-$ satisfy $x \in l_{z,w}$ and $l_{z,w} \subset D_0$. We take $\delta > 0$ to satisfy $\overline{B_\delta(z)} \subset O_-$ and $\overline{B_\delta(w)} \subset O_-$. For the initial position x , Paul's strategy is to keep taking $v = \frac{z-x}{|z-x|}$ until he reaches $B_\delta(z) \cup B_\delta(w)$. If he reaches $B_\delta(z) \cup B_\delta(w)$, then he quits the game. By doing this, Paul gains positive game cost in either case he quits the game or not. See Figure 3. More precisely, Paul gains at least

$$\min \left\{ \frac{\min_{y \in \overline{B_\delta(z)} \cup \overline{B_\delta(w)}} \Psi_-(y)}{\min_{y \in l_{z,w}} u_0(y)} \right\} > 0$$

regardless of $\epsilon \in (0, \delta/\sqrt{2})$, where ϵ is taken small enough for Paul not to stride over $B_\delta(z)$ or $B_\delta(w)$. Hence, as in the case 1), we obtain $u(x, t) > 0$ for any $t > 0$.

3) $x \in Co(O_-) \setminus L$. Henceforth we give a strategy by Paul that includes a z concentric strategy and makes the game cost positive. To do so, we are going to construct a closed curve that consists of an arc C with its center at z and a path $\hat{\Gamma}$ in L . Since $O_- \subset L \subset Co(O_-)$, we have $Co(O_-) = Co(L)$. By Lemma B.2 in Appendix B, we can take $a, b \in L$ such that $x \in l_{a,b}$. We only show the case $a, b \notin O_-$, since otherwise we would prove it in a simpler manner.

We first explain how to construct a path $\Gamma \subset L$ that contains a and b . We take a specific path rather than just a path. By doing so, we are able to indicate a region that includes final positions of the games to guarantee

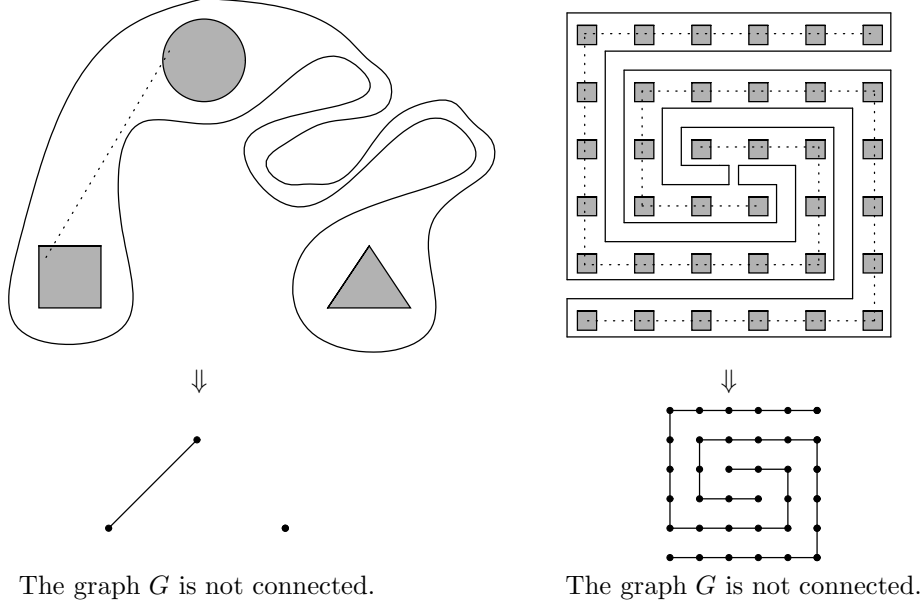

Figure 6: D_0 and O_- that do not satisfy the assumption of Theorem 3.2

that u^ϵ is uniformly positive. Since $a \in L$, there is a line segment that is in D_0 , contains a , and has endpoints in some connected components A and B of O_- respectively. Similarly there is a line segment that is in D_0 , contains b , and has endpoints in some connected components C and D of O_- respectively. Notice that $\langle A, B \rangle, \langle C, D \rangle \in E$, recalling E is the set of unordered pairs of the graph G defined above. From Proposition C.2 there is a path $P = (V', E')$ of the graph G such that $A, B, C, D \in V'$ and $\langle A, B \rangle, \langle C, D \rangle \in E'$. Writing $V' = \{O_0, O_1, \dots, O_n\}$ and $E' = \{\langle O_i, O_{i+1} \rangle \mid i = 0, 1, \dots, n-1\}$, we see that for some points $y_i, \tilde{y}_i \in O_i$ ($i = 0, 1, \dots, n-1$), there are line segments $l_{\tilde{y}_i, y_{i+1}}$ ($i = 0, 1, \dots, n-1$) such that $a \in l_{\tilde{y}_0, y_1}$, $b \in l_{\tilde{y}_{n-1}, y_n}$ and $l_{\tilde{y}_i, y_{i+1}} \subset D_0$ ($i = 0, 1, \dots, n-1$). Let Γ_i be a polygonal line in O_i with endpoints y_i and \tilde{y}_i . Now we define

$$\Gamma := l_{\tilde{y}_0, y_1} \cup \Gamma_1 \cup l_{\tilde{y}_1, y_2} \cup \Gamma_2 \cup l_{\tilde{y}_2, y_3} \cup \dots \cup l_{\tilde{y}_{n-2}, y_{n-1}} \cup \Gamma_{n-1} \cup l_{\tilde{y}_{n-1}, y_n}.$$

We may assume $l_{a,b} \not\parallel l_{\tilde{y}_0, y_1}$ and $l_{a,b} \not\parallel l_{\tilde{y}_{n-1}, y_n}$, since otherwise we would retake either a or b as an element of O_- . Without loss of generality we can also assume that Γ and $l_{a,b}$ do not cross each other except at a and b . By Lemma B.1 in Appendix B we take $\delta > 0$ small enough to satisfy $B_{3\delta}(\Gamma) \subset L$, noticing that L is an open set and Γ is a compact set. Let w_0, w_1, w_2 be unit vectors in \mathbb{R}^2 such that $w_0 \parallel l_{a,b}$, $w_1 \parallel l_{\tilde{y}_0, y_1}$, $w_2 \parallel l_{\tilde{y}_{n-1}, y_n}$ and $(w_0 \cdot w_1)(w_0 \cdot w_2) \geq 0$. Let $\hat{a} = a + \delta w_1$ and $\hat{b} = b + \delta w_2$. We temporarily define C as the arc passing through \hat{a} , \hat{b} and x . Combining Γ and C , we make a closed curve $C \cup \hat{\Gamma}$, where

$$\hat{\Gamma} := l_{\hat{a}, y_1} \cup \Gamma_1 \cup l_{\tilde{y}_1, y_2} \cup \Gamma_2 \cup l_{\tilde{y}_2, y_3} \cup \dots \cup l_{\tilde{y}_{n-2}, y_{n-1}} \cup \Gamma_{n-1} \cup l_{\tilde{y}_{n-1}, \hat{b}}.$$

For the closed curve $C \cup \hat{\Gamma}$ and x in it, there is a Jordan closed curve \hat{C} such that $x \in \hat{C}$ and $\hat{C} \subset C \cup \hat{\Gamma}$ (Figure 8). See Appendix D in detail. Thus, based on the Jordan curve theorem, we let Ω be the bounded domain that satisfies $\partial\Omega = \hat{C}$. If Ω touches the arc C from inside, then we retake the other pair of (\hat{a}, \hat{b}) and, together with it, retake C and Ω so that Ω touches the arc C from outside (Figure 9). We notice that the domain enclosed by $l_{\tilde{y}_0, y_1}$, $l_{\tilde{y}_{n-1}, y_n}$ and the two arcs shown in Figure 9 is bounded, and hence, so is the new Ω . We further notice that we can take C so that C and $\hat{\Gamma}$ intersect only at \hat{a} and \hat{b} by taking δ smaller if necessary.

We now give a strategy by Paul for the initial position x . Paul first takes a z concentric strategy, where z is the center of the arc C . If Paul enters $B_\delta(\Gamma_i)$ for some i , then he quits the game at this point. Once he enters $B_\delta(l_{\tilde{y}_i, y_{i+1}})$ for some i , he takes a similar strategy to that in the case 2). To see that it attains positive game cost, we notice two properties of game trajectories $\{x_n\}$ given when Paul keeps taking a z concentric strategy by some round. One is that $x_n \in B(z, \sqrt{|x_0 - z|^2 + 2n\epsilon^2})^c$. The other is that $x_n \in (C \cup \Omega) \setminus N_\delta$ implies $x_{n+1} \in \Omega$ for $\sqrt{2}\epsilon < \delta$, where we denote $(\bigcup_i B_\delta(\Gamma_i)) \cup (\bigcup_i B_\delta(l_{\tilde{y}_i, y_{i+1}}))$ by N_δ . Thus it takes at most finite time τ (satisfying $\Omega \subset B(z, \sqrt{|x_0 - z|^2 + 2\tau})$) for Paul to reach N_δ . We see that the game ends at some point in $N_{2\delta}$ and Paul gains at least

$$\min \left\{ \inf_{y \in \bigcup_i B_{2\delta}(\Gamma_i)} \Psi_-(y), \inf_{y \in \bigcup_i B_\delta(l_{\tilde{y}_i, y_{i+1}})} u_0(y) \right\} > 0,$$

regardless of $\epsilon \in (0, \delta/\sqrt{2})$. Therefore we conclude that $u(x, t) > 0$ for any $t > \tau$, noticing that τ may depend on ϵ , but does not depend on ϵ . \square

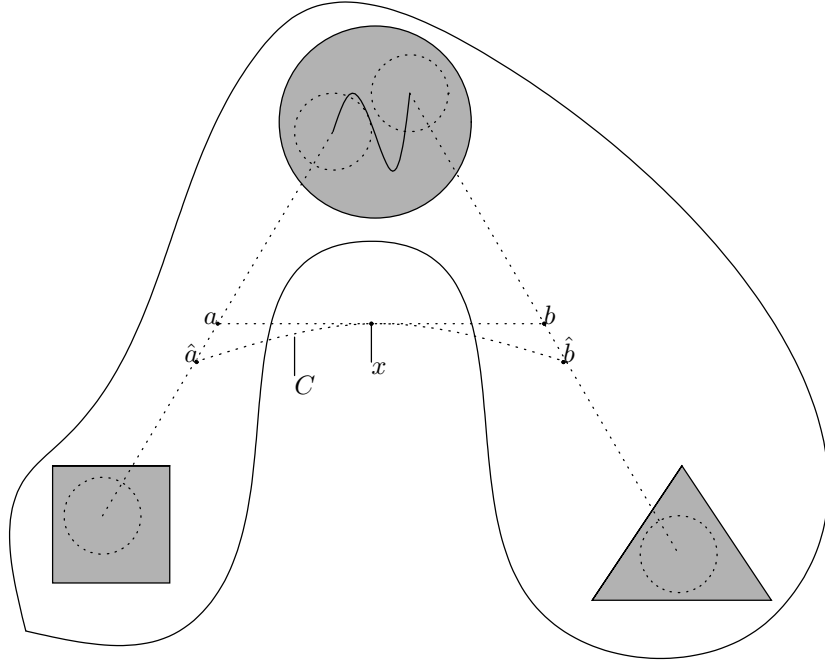

Figure 7: strategy in the case 3)

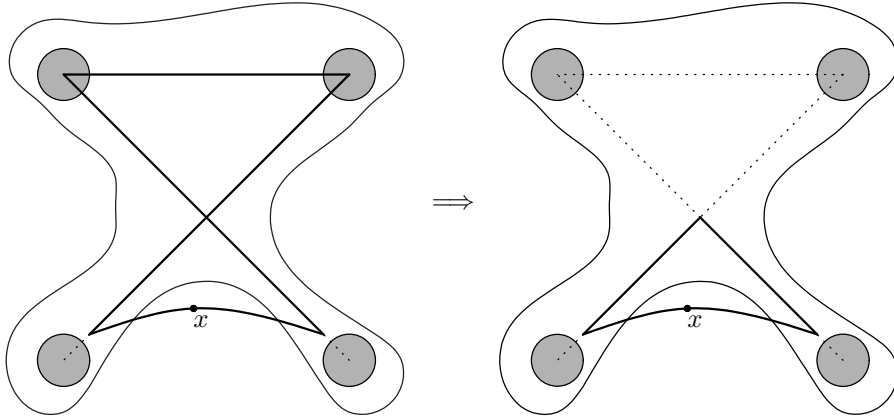

Figure 8: make a Jordan closed curve

Remark 3.4. In general, fattening of the level set may occur under the assumption of Theorem 3.2. i.e., $\overline{D_t} = E_t$ may fail at some $t > 0$. Theorem 3.2 states that even if the curve evolutions are not unique, they have the same limit.

We give some sufficient conditions to the assumption of Theorem 3.2.

Corollary 3.5. *Assume that $Co(O_-) \subset D_0$. Then the same conclusion as that of Theorem 3.2 holds.*

Corollary 3.6. *Assume that O_- is connected (Figure 10 and 11). Then the same conclusion as that of Theorem 3.2 holds.*

Under the following assumption, the moving surface sticks to the obstacle in finite time:

$$\exists r > 0 \forall w \in \partial O_- \exists z \in B_r(w), \text{ s.t. } O_- \subset B_{|z-w|}(z). \quad (3.4)$$

In the following theorem, there is no need to assume $d = 2$.

Theorem 3.7. *Assume (3.4). Then*

$$\lim_{t \rightarrow \infty} D_t = O_-$$

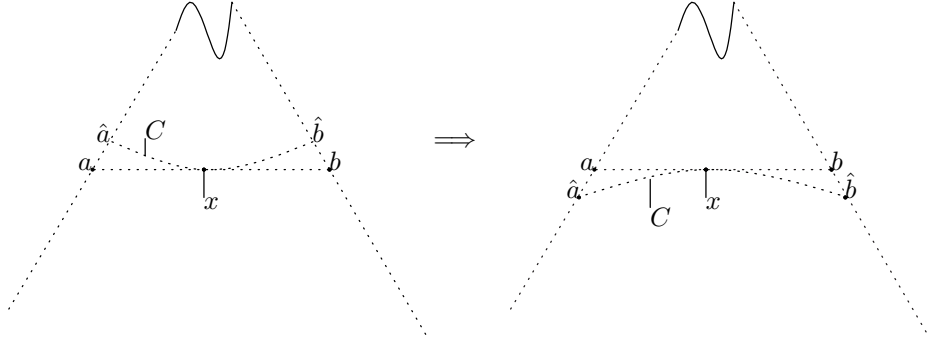

Figure 9: retake C and Ω

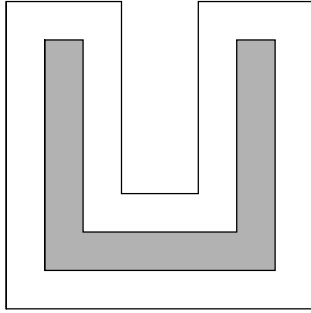

Figure 10: O_- is connected

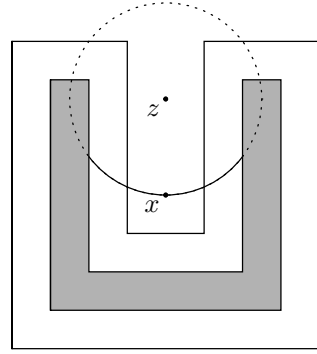

Figure 11: Paul's strategy to achieve positive game cost for the initial position x

and

$$\lim_{t \rightarrow \infty} E_t = C_-.$$

Moreover there exists $\tau > 0$ such that $D_t = D_\tau = O_-$ and $E_t = E_\tau = C_-$ for $t \geq \tau$.

Proof. We notice that the condition (3.4) implies that O_- is convex (Proposition B.4). It is now clear that $O_- \subset D_t$ for any $t > 0$ and hence $O_- \subset \bigcap_{t>0} D_t \subset \underline{\lim}_{t \rightarrow \infty} D_t$. We prove that there exists $\tau > 0$ such that $\bigcup_{t \geq \tau} E_t \subset \overline{O_-}$. Namely we show that there exists $\tau > 0$ such that $u(x, t) < 0$ for $t \geq \tau$ and $x \in (\overline{O_-})^c$. The difference from Lemma 3.1 is that we now have to take τ independent of x . Indeed, for $x \in (\overline{O_-})^c$, we can take a ball $B_{|z-w|}(z)$ in (3.4) such that $x \notin B_{|z-w|}(z)$ and it suffices for Carol to keep taking a z centric strategy until the game ends. The value r in (3.1) is now taken independent of x and then so is τ . Therefore we obtain

$$O_- \subset \underline{\lim}_{t \rightarrow \infty} D_t \subset \overline{\lim}_{t \rightarrow \infty} D_t \subset \bigcup_{t \geq \tau} D_t \subset \bigcup_{t \geq \tau} E_t \subset \overline{O_-}.$$

Since $\bigcup_{t \geq \tau} D_t$ is open, we have $O_- = \bigcup_{t \geq \tau} D_t$, which means $\underline{\lim}_{t \rightarrow \infty} D_t = \overline{\lim}_{t \rightarrow \infty} D_t$ and moreover $D_t = D_\tau = O_-$ for $t \geq \tau$.

We also have

$$O_- \subset \bigcap_{t>0} D_t \subset \bigcap_{t>0} E_t \subset \underline{\lim}_{t \rightarrow \infty} E_t \subset \overline{\lim}_{t \rightarrow \infty} E_t \subset \overline{O_-}.$$

Since $\bigcap_{t>0} E_t$ is closed, we similarly have $\overline{O_-} = \bigcap_{t>0} E_t$, which means $\underline{\lim}_{t \rightarrow \infty} E_t = \overline{\lim}_{t \rightarrow \infty} E_t$ and moreover $E_t = E_0 = \overline{O_-}$ for $t \geq 0$. \square

Remark 3.8. The hair-clip solution, which can be regarded as an explicit solution to the curve shortening problem with the Dirichlet condition (See e.g. [19]), implies that the solution of our obstacle problem can be apart from the asymptotic shape at any time. i.e., there are D_0 and O_- such that $Co(O_-) \subsetneq D_t$ for any $t > 0$.

4 With driving force

In this section we consider the following surface evolution equations in the plane that have obstacles on one side:

$$\begin{cases} V = -\kappa + \nu, & \text{on } \partial D_t, \\ O_- \subset D_t, \end{cases} \quad (4.1)$$

or

$$\begin{cases} V = -\kappa + \nu, & \text{on } \partial D_t, \\ D_t \subset O_+, \end{cases} \quad (4.2)$$

where D_t , O_- and O_+ are open sets in \mathbb{R}^2 and $\nu > 0$ is a constant. These equations are specific cases of (2.2).

While Theorem 3.2 is invariant with respect to similarity transformation, the behaviors of moving curves governed by (4.1) or (4.2) depend not only on shape of the obstacles and the initial curve but also on size of them. It is easily understood by considering the case ∂D_0 is a circle. For $D_0 = B_R((0, 0))$, the circle ∂D_0 shrinks if $R < \nu^{-1}$, and it spreads if $R > \nu^{-1}$ as time goes. So it is difficult to present a concise result as Theorem 3.2. We give several examples of computations of the asymptotic shapes here.

4.1 Basic strategy of the game

Concerning to the game interpretation for (4.1), the difference from the game in Section 1 is that Paul has the right to choose $w_i \in S^1$ at each round i and the control system is

$$x_i = x_{i-1} + \sqrt{2}\epsilon b_i v_i + \nu\epsilon^2 w_i,$$

instead of (1.4). In the game for (4.2), not Paul but Carol has the right to quit the game. If Carol quits the game at round i , then the cost is given by $\Psi_+(x_i)$. See Appendix A in detail. As explained later in the proof of Lemma 3.1, the value functions u^ϵ locally uniformly converge to the solution u of the corresponding level set equation.

We now prepare several types of game strategies and give the properties of the game trajectories when they are used. The first one is similar to the one in Definition 2.5.

Definition 4.1 (Concentric strategy). Let $\nu > 0$, $\epsilon > 0$ and $z \in \mathbb{R}^2$. Let $x \in \mathbb{R}^2$ be the current position of the game.

1. A choice $(v, w) \in S^1 \times S^1$ by Paul is called a z *concentric strategy* (by Paul) if

$$w = \frac{z - x}{|z - x|} \text{ and } v \perp w.$$

When $x = z$, any $(v, w) \in S^1 \times S^1$ satisfying $v \perp w$ is called a z *concentric strategy*.

2. Let $(v, w) \in S^1 \times S^1$ be a choice by Paul in the same round. A choice $b \in \{\pm 1\}$ by Carol is called a z *concentric strategy* (by Carol) if

$$\langle bv, x + \nu\epsilon^2 w - z \rangle \geq 0.$$

As in Section 2.2, let $d_n = |x_n - z|$ for fixed $z \in \mathbb{R}^2$. If Paul takes a z concentric strategy through the game, then the sequence $\{d_n\}$ satisfies

$$R_{n+1} = \sqrt{(R_n - \nu\epsilon^2)^2 + 2\epsilon^2}. \quad (4.3)$$

If Carol takes a z concentric strategy through the game, we have $d_n \geq R_n$, where $\{R_n\}$ is the solution to (4.3) with $R_0 = d_0$. In the following lemmas, we give basic properties of the behaviors of the solutions to (4.3).

Lemma 4.2. Fix $\nu > 0$. Let $\epsilon > 0$ and $\{R_n\}$ be a sequence satisfying the condition (4.3). Then the following properties hold.

1. If $R_0 = \nu^{-1} + \frac{\nu}{2}\epsilon^2$, then $R_n = \nu^{-1} + \frac{\nu}{2}\epsilon^2$ for all n . If $R_0 > \nu^{-1} + \frac{\nu}{2}\epsilon^2$, then $R_n > \nu^{-1} + \frac{\nu}{2}\epsilon^2$ for all n and $\{R_n\}$ is decreasing for $\epsilon \leq \sqrt{2}\nu^{-1}$. If $\nu\epsilon^2 \leq R_0 < \nu^{-1} + \frac{\nu}{2}\epsilon^2$, then $R_n < \nu^{-1} + \frac{\nu}{2}\epsilon^2$ for all n and $\{R_n\}$ is increasing.

2.

$$\lim_{n \rightarrow \infty} R_n = \nu^{-1} + \frac{\nu}{2}\epsilon^2.$$

3.

$$R_{n+1} - R_n \leq \frac{\epsilon^2}{R_n} - \nu\epsilon^2 + \frac{\nu^2\epsilon^4}{2R_n}. \quad (4.4)$$

If $R_{n+1} \geq R_n$, then

$$\frac{\epsilon^2}{R_{n+1}} - \nu\epsilon^2 + \frac{\nu^2\epsilon^4}{2R_{n+1}} \leq R_{n+1} - R_n. \quad (4.5)$$

Proof. 1. We first notice that $R_{n+1} \leq R_n$ is equivalent to $R_n \geq \frac{\nu}{2}\epsilon^2 + \nu^{-1}$. Also $R_{n+1} \geq R_n$ is equivalent to $R_n \leq \frac{\nu}{2}\epsilon^2 + \nu^{-1}$. These facts imply the first assertion.

Assume that $R_k > \frac{\nu}{2}\epsilon^2 + \nu^{-1}$ for some k . Since $(R_k - \nu\epsilon^2)^2 > (\nu^{-1} - \frac{\nu}{2}\epsilon^2)^2$ for $\epsilon \leq \sqrt{2}\nu^{-1}$, we have

$$R_{k+1} = \sqrt{(R_k - \nu\epsilon^2)^2 + 2\epsilon^2} > \sqrt{\left(\nu^{-1} - \frac{\nu}{2}\epsilon^2\right)^2 + 2\epsilon^2} = \frac{\nu}{2}\epsilon^2 + \nu^{-1}.$$

Hence, if $R_0 > \frac{\nu}{2}\epsilon^2 + \nu^{-1}$, we have by induction that $R_n > \frac{\nu}{2}\epsilon^2 + \nu^{-1}$ for all n . The second assertion follows from this.

Assume that $\nu\epsilon^2 \leq R_k < \frac{\nu}{2}\epsilon^2 + \nu^{-1}$. Since $(R_k - \nu\epsilon^2)^2 < (\nu^{-1} - \frac{\nu}{2}\epsilon^2)^2$ for $\epsilon \in (0, \sqrt{2}\nu^{-1})$, we get $R_{k+1} < \frac{\nu}{2}\epsilon^2 + \nu^{-1}$. In the same way, $\nu\epsilon^2 \leq R_0 < \frac{\nu}{2}\epsilon^2 + \nu^{-1}$ gives $R_n < \frac{\nu}{2}\epsilon^2 + \nu^{-1}$. Therefore the third assertion is obtained.

2. Since $\{R_n\}$ is monotone and bounded, it is convergent. Its limit value is given by taking limit for both sides of (4.3) and solving the limit equation.

3. The inequality (4.4) is given by the following computation.

$$R_{n+1} - R_n = \frac{R_{n+1}^2 - R_n^2}{R_{n+1} + R_n} \leq \frac{R_{n+1}^2 - R_n^2}{2R_n} = \frac{\epsilon^2}{R_n} - \nu\epsilon^2 + \frac{\nu^2\epsilon^4}{2R_n}.$$

Similarly (4.5) is obtained by

$$R_{n+1} - R_n = \frac{R_{n+1}^2 - R_n^2}{R_{n+1} + R_n} \geq \frac{R_{n+1}^2 - R_n^2}{2R_{n+1}} \geq \frac{\epsilon^2}{R_{n+1}} - \nu\epsilon^2 + \frac{\nu^2\epsilon^4}{2R_{n+1}}.$$

□

It is sometimes convenient to describe the behavior of the trajectory by an operator. For fixed $\nu > 0$, we define the operator $T_h : \mathbb{R} \rightarrow \mathbb{R}$ as

$$T_h(R) := \sqrt{(R - \nu h)^2 + 2h}.$$

We denote n times composition of T_h by T_h^n . The solution $\{R_n\}$ to (4.3) with $R_0 = R$ is described by $R_n = T_{\epsilon^2}^n(R)$.

Lemma 4.3. 1. $T_h(R) < T_h(R')$, provided $\nu h \leq R < R'$.

2. $T_h(R) > T_{h/2}^2(R)$.

Proof. The proofs are done by direct computation, so are omitted. □

We also prepare a notation that represents the time to pass through the set $B_b(z) \setminus B_a(z)$ when Paul takes a z concentric strategy. For $a, b \geq 0$ and $\epsilon > 0$ satisfying $a \leq b \leq \nu^{-1} + \frac{\nu}{2}\epsilon^2$, we define

$$t_\epsilon(a, b) := \epsilon^2 |\{n \in \mathbb{N} \mid T_{\epsilon^2}^n(a) < b\}|, \quad (4.6)$$

where we denote the set $\{0, 1, 2, \dots\}$ by \mathbb{N} .

Lemma 4.4. Let $t > 0$ and $0 < R < \nu^{-1}$. Define $N = \lceil t\epsilon^{-2} \rceil$. Then $T_{\epsilon^2}^N(R) < \nu^{-1}$ for sufficiently small $\epsilon > 0$.

Proof. We prove that

$$t_\epsilon(\nu^{-1} - \epsilon, \nu^{-1}) \geq C \log_2 \epsilon^{-1}$$

for some constant $C > 0$.

First let us explain the property of $t_\epsilon(a, b)$. Let $0 < a \leq b \leq c \leq \nu^{-1} + \frac{\nu}{2}\epsilon^2$. By the definition of t_ϵ , we see

$$t_\epsilon(a, b) \leq t_\epsilon(a, c).$$

By Lemma 4.3 1, we have

$$t_\epsilon(b, c) \leq t_\epsilon(a, c).$$

Let $n^* = t_\epsilon(a, b)\epsilon^{-2}$ and $d = T_{\epsilon^2}^{n^*-1}(a)$. Then we have

$$t_\epsilon(a, c) = t_\epsilon(a, b) + t_\epsilon(d, c) - \epsilon^2.$$

Since $d < b$, we deduce that

$$t_\epsilon(a, c) \geq t_\epsilon(a, b) + t_\epsilon(b, c) - \epsilon^2. \quad (4.7)$$

We next estimate $t_\epsilon(\nu^{-1} - \epsilon, \nu^{-1})$. When $\nu^{-1} - 2^{-m}\epsilon \leq R_n \leq \nu^{-1} - 2^{-m-1}\epsilon$ for $m, n \in \mathbb{N}$, the inequality (4.4) implies

$$R_{n+1} - R_n \leq \frac{\epsilon^2}{\nu^{-1} - 2^{-m}\epsilon} - \nu\epsilon^2 + \frac{\nu^2\epsilon^4}{2\nu^{-1} - 2^{-m+1}\epsilon} = \frac{2^{-m}\nu\epsilon^3 + \nu^2\epsilon^4}{2\nu^{-1} - 2^{-m+1}\epsilon},$$

and in particular, if $\epsilon \leq \nu^{-1}$,

$$R_{n+1} - R_n \leq \frac{2^{-m}\nu\epsilon^3 + \nu^2\epsilon^4}{2\nu^{-1} - 2^{-m+1}\epsilon} \leq \frac{2^{-m}\nu\epsilon^3 + \nu^2\epsilon^4}{\nu^{-1}} = \nu^2\epsilon^3(2^{-m} + \nu\epsilon).$$

Thus $t_\epsilon(\nu^{-1} - 2^{-m}\epsilon, \nu^{-1} - 2^{-m-1}\epsilon)$ can be compared to the exit time for sequences with the constant speed of $\nu^2\epsilon^3(2^{-m} + \nu\epsilon)$ per round. Then we have

$$\begin{aligned} & t_\epsilon(\nu^{-1} - 2^{-m}\epsilon, \nu^{-1} - 2^{-m-1}\epsilon) \\ & \geq ((\nu^{-1} - 2^{-m-1}\epsilon) - (\nu^{-1} - 2^{-m}\epsilon)) \frac{\epsilon^2}{\nu^2\epsilon^3(2^{-m} + \nu\epsilon)} = \frac{1}{2\nu^2 + 2^{m+1}\nu^3\epsilon}. \end{aligned}$$

In particular, if $2^m \leq \epsilon^{-1}$, we get

$$\frac{1}{2\nu^2 + 2^{m+1}\nu^3\epsilon} \geq \frac{1}{2\nu^2 + 2\nu^3} = \frac{1}{2\nu^2(\nu + 1)}.$$

Let m^* be the minimal integer m satisfying $2^m > \epsilon^{-1}$. Using (4.7), we obtain

$$\begin{aligned} t_\epsilon(\nu^{-1} - \epsilon, \nu^{-1}) & \geq \sum_{k=0}^{m^*-1} (t_\epsilon(\nu^{-1} - 2^{-k}\epsilon, \nu^{-1} - 2^{-k-1}\epsilon) - \epsilon^2) \\ & \geq \sum_{k=0}^{m^*-1} \frac{1}{3\nu^2(\nu + 1)} = \frac{\log_2 \epsilon^{-1}}{3\nu^2(\nu + 1)}, \end{aligned}$$

which is the conclusion. \square

Lemma 4.5. For $\nu > 0$ and $\nu^{-1} \geq \delta > 0$, there exist $\epsilon_0 > 0$ and $M > 0$ such that

$$t_\epsilon(a, \nu^{-1} - \delta) \leq M$$

for all $0 < \epsilon < \epsilon_0$ and $0 \leq a \leq \nu^{-1} - \delta$.

Proof. Let $n_\epsilon = t_\epsilon(a, \nu^{-1} - \delta)\epsilon^{-2}$. Namely $T_{\epsilon^2}^{n_\epsilon}(a) < \nu^{-1} - \delta$ and $T_{\epsilon^2}^{n_\epsilon+1}(a) \geq \nu^{-1} - \delta$ are satisfied. Since $T_{\epsilon^2}(R) - R$ is monotonically decreasing with respect to R and $T_{\epsilon^2}^{n_\epsilon+1}(a) \leq \nu^{-1} - \delta/2$ for sufficiently small $\epsilon > 0$, we have by (4.5) in Lemma 4.2

$$T_{\epsilon^2}^{n_\epsilon+1}(a) - T_{\epsilon^2}^{n_\epsilon}(a) \geq T_{\epsilon^2}^{n_\epsilon+1}(a) - T_{\epsilon^2}^{n_\epsilon}(a) \geq \frac{\epsilon^2}{T_{\epsilon^2}^{n_\epsilon+1}(a)} - \nu\epsilon^2 + \frac{\nu^2\epsilon^4}{2T_{\epsilon^2}^{n_\epsilon+1}(a)} \geq \frac{\delta\nu^2}{2 - \delta\nu}\epsilon^2$$

for $n = 0, 1, \dots, n_\epsilon$. This means

$$n_\epsilon \leq (\nu^{-1} - \delta - a) \frac{2 - \delta\nu}{\delta\nu^2\epsilon^2}$$

and hence

$$t_\epsilon(a, \nu^{-1} - \delta) \leq (\nu^{-1} - \delta - a) \frac{2 - \delta\nu}{\delta\nu^2\epsilon^2} \leq (\nu^{-1} - \delta) \frac{2 - \delta\nu}{\delta\nu^2},$$

which is the conclusion. \square

To study the asymptotic behavior of solutions, the following types of strategies of the game are also useful.

Definition 4.6 (Push by moving circle). For a sequence $\{z_n\} \subset \mathbb{R}^2$ such that $|z_{n+1} - z_n| \leq C$ for some constant $C > 0$, a strategy for Paul (resp. for Carol) to keep taking a z_n concentric strategy at each round n is called a *push by moving circle strategy* by Paul (resp. by Carol).

Lemma 4.7 (Properties of push by moving circle strategies). Let $\delta > 0$. Let $\epsilon > 0$ be sufficiently small. i.e., we assume that $0 < \epsilon < \epsilon_0(\nu, \delta)$ for some $\epsilon_0(\nu, \delta) > 0$.

1. If either Paul or Carol takes a push by moving circle strategy with $C = \frac{\delta}{2}\nu^2\epsilon^2$ and $x_0 \in \overline{B(z_0, \nu^{-1} - \delta)}^c$, then $x_n \in \overline{B(z_n, \nu^{-1} - \delta)}^c$ for all round n .
2. If Paul takes a push by moving circle strategy with $C = \frac{\nu^2\delta}{2(1+\nu\delta)}\epsilon^2$ and $x_0 \in \overline{B(z_0, \nu^{-1} + \delta)}$, then $x_n \in \overline{B(z_n, \nu^{-1} + \delta)}$ for all round n .

Proof. 1. We notice that $|x_{n+1} - z_n| \geq T_{\epsilon^2}(|x_n - z_n|)$ whichever player takes the push by moving circle strategy. We prove that $x_n \in \overline{B(z_n, \nu^{-1} - \delta)}^c$ implies $x_{n+1} \in \overline{B(z_{n+1}, \nu^{-1} - \delta)}^c$. If $|x_n - z_n| \geq \nu^{-1}$, we see from Lemma 4.2 that $|x_{n+1} - z_n| \geq \nu^{-1}$ and hence $|x_{n+1} - z_{n+1}| \geq \nu^{-1} - \frac{\delta}{2}\nu^2\epsilon^2 \geq \nu^{-1} - \delta$ for sufficiently small ϵ . Thus we assume $|x_n - z_n| < \nu^{-1}$ hereafter.

It suffices to show $|x_{n+1} - z_n| > \nu^{-1} - \delta + \frac{\delta}{2}\nu^2\epsilon^2$. Indeed this inequality is obtained by

$$|x_{n+1} - z_n| \geq T_{\epsilon^2}(|x_n - z_n|) > T_{\epsilon^2}(\nu^{-1} - \delta) \geq \nu^{-1} - \delta + \frac{\delta}{2}\nu^2\epsilon^2.$$

The second inequality is derived from the monotonicity property of T_{ϵ^2} stated in Lemma 4.3. The third inequality is computed by (4.5) in Lemma 4.2. We notice that $T_{\epsilon^2}(\nu^{-1} - \delta) \leq \nu^{-1} - \delta/2$ for sufficiently small ϵ . Letting $R_n = \nu^{-1} - \delta$ and hence $R_{n+1} = T_{\epsilon^2}(\nu^{-1} - \delta)$, we indeed have

$$R_{n+1} - R_n \geq \frac{\epsilon^2}{R_{n+1}} - \nu\epsilon^2 + \frac{\nu^2\epsilon^4}{2R_{n+1}} \geq \frac{\epsilon^2}{\nu^{-1} - \delta/2} - \nu\epsilon^2 + \frac{\nu^2\epsilon^4}{2\nu^{-1} - \delta} \geq \frac{\delta}{2}\nu^2\epsilon^2.$$

Thus the proof is complete.

2. We prove that $x_n \in \overline{B(z_n, \nu^{-1} + \delta)}$ implies $x_{n+1} \in \overline{B(z_{n+1}, \nu^{-1} + \delta)}$. If $|x_n - z_n| < \nu\epsilon^2$, it is clear that $|x_{n+1} - z_{n+1}| \leq \nu^{-1} + \delta$ for sufficiently small ϵ . If not, we have

$$|x_{n+1} - z_{n+1}| \leq T_{\epsilon^2}(\nu^{-1} + \delta) + \frac{\nu^2\delta}{2(1 + \nu\delta)}\epsilon^2.$$

Letting $R_n = \nu^{-1} + \delta$ and hence $R_{n+1} = T_{\epsilon^2}(\nu^{-1} + \delta)$, we have from (4.4) in Lemma 4.2

$$R_n - R_{n+1} \geq -\frac{\epsilon^2}{R_n} + \nu\epsilon^2 - \frac{\nu^2\epsilon^4}{2R_n} = \frac{\nu^2\delta}{1 + \nu\delta}\epsilon^2 + o(\epsilon^2).$$

Therefore we obtain

$$|x_{n+1} - z_{n+1}| \leq \nu^{-1} + \delta$$

for sufficiently small ϵ . □

We set

$$\mathcal{L}_\nu := \{\gamma([0, 1]) \mid \gamma \in C^2([0, 1]; \mathbb{R}^2), \gamma \text{ is regular and } |\kappa_{\gamma(t)}| \leq \nu \text{ for all } t \in (0, 1)\},$$

where we denote the curvature of $\gamma([0, 1])$ at $\gamma(t)$ by $\kappa_{\gamma(t)}$.

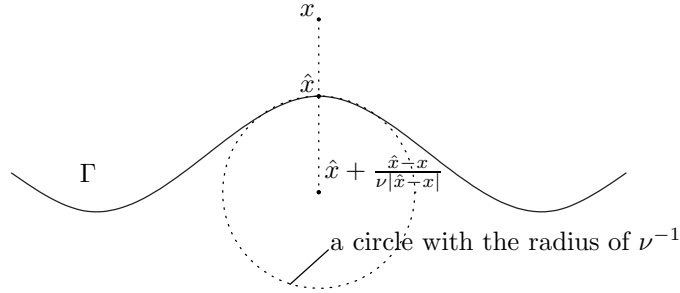

Figure 12: Γ tube strategy

Definition 4.8 (Γ tube strategy). Let $\nu > 0$ and $\Gamma \in \mathcal{L}_\nu$. Let $x \in \mathbb{R}^2$ be the current position of the game. Let \hat{x} satisfy $\min_{y \in \Gamma} |x - y| = |x - \hat{x}|$. A $\hat{x} + \frac{\hat{x} - x}{\nu|\hat{x} - x|}$ concentric strategy is called a Γ tube strategy (Figure 12).

Lemma 4.9 (Property of Γ tube strategies). Let $\Gamma = \gamma([0, 1]) \in \mathcal{L}_\nu$. Let $\delta > 0$ and $\epsilon \ll \delta$. If Paul takes a Γ tube strategy at round n and $x_n \in B_\delta(\Gamma) \setminus (B_\delta(\gamma(0)) \cup B_\delta(\gamma(1)))$, then $x_{n+1} \in B_\delta(\Gamma)$.

Proof. It is clear that the statement holds if $x_n \in B_{\delta/2}(\Gamma)$. Thus, there is no loss of generality to assume that $\hat{x}_n = (0, 0)$ and $x_n \in \{(0, q) \mid \delta/2 \leq q < \delta\}$, where \hat{x}_n is a minimizer taken in Definition 4.8. There are a graph $f : \mathbb{R} \rightarrow \mathbb{R}$ and $\delta_0 > 0$ such that $\hat{\Gamma} := \{(p, q) \mid q = f(p), -\delta_0 < p < \delta_0\} \subset \Gamma$. Let $C = \partial B_{\nu^{-1}}((0, -\nu^{-1}))$. If Paul takes a Γ tube strategy, we see that $\text{dist}(x_{n+1}, C) < \text{dist}(x_n, C) < \delta$. Since $f(p) \geq -\nu^{-1} + \sqrt{\nu^{-2} - p^2}$ for $-\delta_0 < p < \delta_0$, we have

$$\text{dist}(x_{n+1}, \Gamma) \leq \text{dist}(x_{n+1}, \hat{\Gamma}) \leq \text{dist}(x_{n+1}, C) < \text{dist}(x_n, C) < \delta,$$

which is the conclusion. □

4.2 Examples

We first observe the behavior of the solution to (4.1) by considering two examples of O_- . In both of the problems we assume

(A1) $D_0 \subset B_R(z)$ for some $z \in \mathbb{R}^2$ and $R < \nu^{-1}$.

Set

$$A := \bigcap \left\{ \overline{B_{\nu^{-1}}(z)} \mid O_- \subset \overline{B_{\nu^{-1}}(z)}, z \in \mathbb{R}^2 \right\}$$

for $O_- \subset \mathbb{R}^2$. Under the assumption (A1), this A is a major candidate of the asymptotic shape. Indeed we can show at least that the asymptotic shape is bounded by A from above for general O_- satisfying (A1).

Lemma 4.10. *Let $O \subset \mathbb{R}^d$ and $r > 0$. Then the set $\{y \in \mathbb{R}^d \mid O \subset \overline{B_r(y)}\}$ is convex.*

Proof. Let $y_1, y_2 \in \mathbb{R}^d$ satisfy $O \subset \overline{B_r(y_1)}$ and $O \subset \overline{B_r(y_2)}$. Then, for $x \in O$, we have $|y_i - x| \leq r$ ($i = 1, 2$). This implies that

$$\left| \frac{y_1 + y_2}{2} - x \right| = \frac{|y_1 - x + y_2 - x|}{2} \leq r$$

for all $x \in O$ and the lemma follows. \square

We hereafter take u_0 and Ψ_- as (3.2) and (3.3) respectively. We set $O_{\delta_1} := \{x \in \mathbb{R}^2 \mid \Psi_-(x) > -\delta_1\}$ and $C_{\delta_1, \delta_2} := \{z \in \mathbb{R}^2 \mid O_{\delta_1} \subset \overline{B(z, \nu^{-1} - \delta_2)}\}$ for $\delta_1, \delta_2 > 0$.

Lemma 4.11. *Assume (A1). For $x \in A^c$, there exist $\delta_1, \delta_2 > 0$ and $\hat{z} \in \mathbb{R}^2$ such that $\hat{z} \in C_{\delta_1, \delta_2}$ and $x \in \overline{B_{\nu^{-1}}(\hat{z})}^c$.*

Proof. Step 1. We first show that $B_{\delta_1 + \delta_2}(z) \subset C_{0,0}$ implies $z \in C_{\delta_1, \delta_2}$. Indeed $B_{\delta_1 + \delta_2}(z) \subset C_{0,0}$ implies

$$O_- \subset \bigcap \left\{ \overline{B_{\nu^{-1}}(\hat{z})} \mid \hat{z} \in B_{\delta_1 + \delta_2}(z) \right\} = \overline{B(z, \nu^{-1} - (\delta_1 + \delta_2))}.$$

By taking δ_1 neighborhood of both sides, we have

$$O_{\delta_1} \subset \overline{B(z, \nu^{-1} - \delta_2)},$$

which means $z \in C_{\delta_1, \delta_2}$.

Step 2. Let $C_{0,0}^x := \{z \in \mathbb{R} \mid O_- \subset \overline{B_{\nu^{-1}}(z)}, x \in \overline{B_{\nu^{-1}}(z)}^c\}$. We next show $(C_{0,0}^x)^{int} \neq \emptyset$. By the assumption (A1), we see that $\overline{B(z, \nu^{-1} - R)} \subset C_{0,0}$ for some $z \in \mathbb{R}^2$. We also notice that $C_{0,0}^x = C_{0,0} \setminus \overline{B_{\nu^{-1}}(x)}$. If $\overline{B(z, \nu^{-1} - R)} \setminus \overline{B_{\nu^{-1}}(x)} \neq \emptyset$, then it has the interior and so does $C_{0,0}^x$. Since $x \in A^c$, we have $C_{0,0}^x \neq \emptyset$ and let $\hat{z} \in C_{0,0}^x$. Since $C_{0,0}$ is convex (Lemma 4.10), we have $C_o(\{\hat{z}\} \cup \overline{B(z, \nu^{-1} - R)}) \subset C_{0,0}$. Hence, even if $\overline{B(z, \nu^{-1} - R)} \subset \overline{B_{\nu^{-1}}(x)}$, the set $C_o(\{\hat{z}\} \cup \overline{B(z, \nu^{-1} - R)}) \setminus \overline{B_{\nu^{-1}}(x)}$ has the interior and so does $C_{0,0}^x$.

Therefore, for small $\delta_1 > 0$ and $\delta_2 > 0$, there exists $\hat{z} \in C_{\delta_1, \delta_2}$ and $x \in \overline{B_{\nu^{-1}}(\hat{z})}^c$. \square

Lemma 4.12. *Assume (A1). Then*

$$\overline{\lim}_{t \rightarrow \infty} E_t \subset A.$$

Proof. We give appropriate strategies of Carol as in the proof of Lemma 3.1. For $x \in A^c$, there exist $\delta_1, \delta_2 > 0$ and $z_0 \in \mathbb{R}^2$ such that $R < \nu^{-1} - \delta_2$, $z_0 \in C_{\delta_1, \delta_2}$ and $x \notin \overline{B(z_0, \nu^{-1} - \delta_2)}$ (Lemma 4.11). We define the sequence $\{z_n\}$ by

$$z_n := z_0 + \min \left\{ \frac{\delta_2}{2} n \nu^2 \epsilon^2, |z - z_0| \right\} \frac{z - z_0}{|z - z_0|},$$

where z is a point taken in the assumption (A1). Carol's strategy is to take a push by moving circle strategy with this $\{z_n\}$.

If she does so, then $z_n \in C_{\delta_1, \delta_2}$ for all n because $z_0, z \in C_{\delta_1, \delta_2}$ and C_{δ_1, δ_2} is convex (Lemma 4.10). By 1 in Lemma 4.7 we see that if Paul quits the game at round i , the game position x_i is not in O_{δ_1} . Thus the stopping cost is at most $-\delta_1$ regardless of ϵ . If Paul does not quit the game, the last position x_N of the game is not in $\overline{B(z, \nu^{-1} - \delta_2)}$ for sufficiently large t . Thus the terminal cost is at most $R - \nu^{-1} + \delta_2 < 0$ for large t regardless of ϵ . Therefore we conclude that for $x \in A^c$, there exists $\tau > 0$ such that $u(x, t) < 0$ for $t > \tau$. \square

The first example of O_- is the following:

$$O_- := B_{R'}((0, 0)) \setminus \{(p, q) \mid q \geq |p|\},$$

where $R' < \nu^{-1}$ (Figure 13). Notice that

$A^{int} = B_{R'}((0, 0)) \setminus \{(p, q) \mid q \geq \sqrt{\nu^{-2} - p^2} + R' - \sqrt{\nu^{-2} - R'^2}\}$ for this obstacle, where we denote the interior of A by A^{int} .

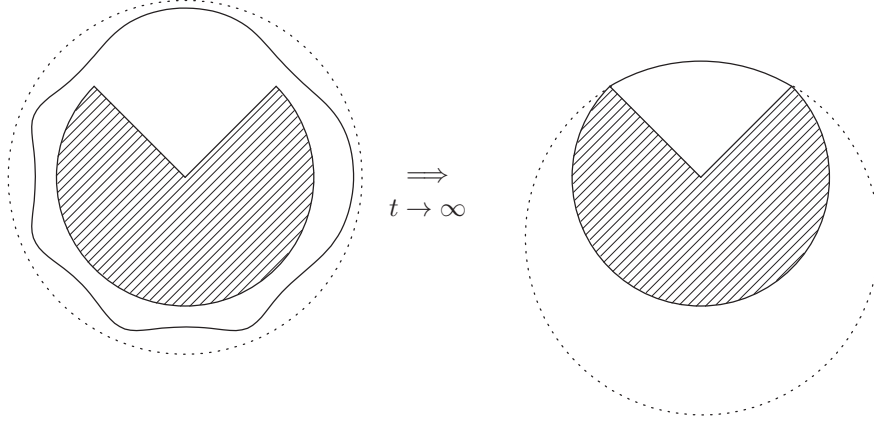

Figure 13: Small Pac-Man

Proposition 4.13 (Small Pac-Man). *Assume (A1). Then*

$$A^{int} \subset \varliminf_{t \rightarrow \infty} D_t \subset \overline{\varliminf_{t \rightarrow \infty} D_t} \subset A$$

and

$$A^{int} \subset \varliminf_{t \rightarrow \infty} E_t \subset \overline{\varliminf_{t \rightarrow \infty} E_t} \subset A.$$

Proof. By Lemma 4.12, it suffices to show $A^{int} \subset \varliminf_{t \rightarrow \infty} D_t$. As in the proof of Theorem 3.2, we do case analysis for the initial game position $x \in A^{int}$ and give an appropriate strategy of Paul.

1) $x \in O_-$. In this case, it suffices for Paul to quit the game at the first round and gain the stopping cost $\Psi_-(x) > 0$ as in the proof of Theorem 3.2.

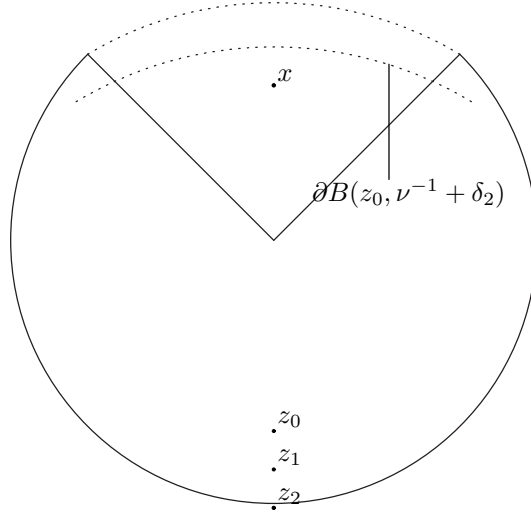

Figure 14: A strategy of Paul

2) $x \in A^{int} \setminus O_-$. We set $O^{\delta_1} := \{x \in \mathbb{R}^2 \mid \Psi_-(x) > \delta_1\}$. We see that for $x \in A^{int} \setminus O_-$, there exist $\delta_1, \delta_2 > 0$ and $z_0 \in \{(0, q) \mid q \leq x \cdot (0, 1)\}$ such that $x \in B(z_0, \nu^{-1} + \delta_2)$ and $O^{\delta_1} \cap \partial B(z_0, \nu^{-1} + \delta_2) \cap \{(p, q) \mid q > 0\} \neq \emptyset$ (Figure 14). Define the sequence $\{z_n\}$ so that

$$z_{n+1} = z_n + \left(0, -\frac{\nu^2 \delta_2}{2(1 + \nu \delta_2)} \epsilon^2\right).$$

Paul's strategy is to keep taking a push by moving circle strategy with this $\{z_n\}$ until he reaches O^{δ_1} , where he quits the game.

By doing this strategy, Paul actually gains positive game cost. Set

$$\Omega_n = B_{\delta_1}(\{(p, q) \mid q \geq |p|\}) \cap B(z_n, \nu^{-1} + \delta_2)$$

for $n = 0, 1, \dots$. By 2 in Lemma 4.7 we see that if $x_n \in \Omega_n$, then $x_{n+1} \in \Omega_{n+1}$ or Paul quits the game. If $n\epsilon^2$ is sufficiently large, then $\Omega_n = \emptyset$. That means Paul definitely quits the game in finite time and the stopping cost is at least

$$\inf_{y \in O^{\delta_1}} \Psi_-(y) = \delta_1 > 0$$

regardless of ϵ . Hence, together with the case 1), it turns out that for $x \in A^{int}$, there exists $\tau > 0$ such that $u(x, t) > 0$ for $t > \tau$. \square

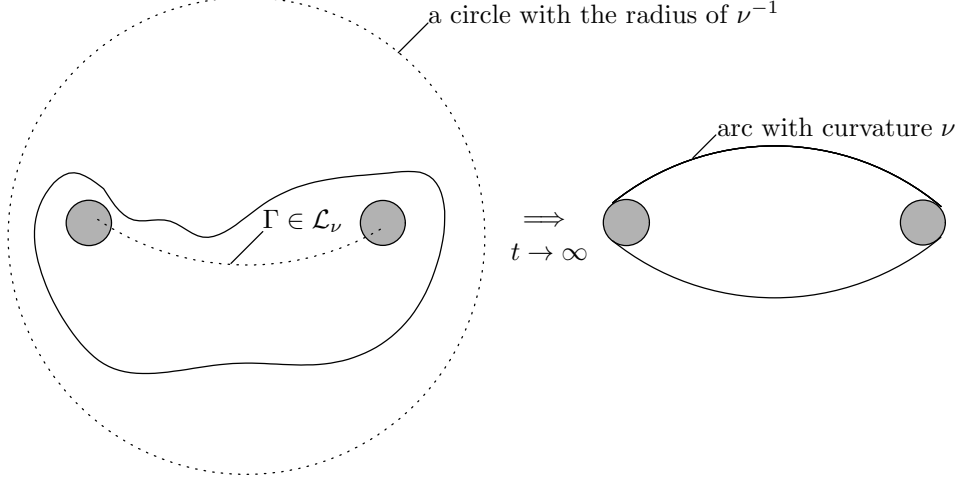

Figure 15: Two small balls

We next consider (4.1) with $O_- = B_r((d, 0)) \cup B_r((-d, 0))$. In this problem we further assume

(A2) There exists a function $f : [a, b] \rightarrow \mathbb{R}$ such that $\Gamma := \{(p, q) \mid q = f(p), a \leq p \leq b\} \in \mathcal{L}_\nu$, $(a, f(a)) \in B_r((-d, 0))$, $(b, f(b)) \in B_r((d, 0))$ and $\Gamma \subset D_0$.

Proposition 4.14 (Two small balls). *Assume (A1) and (A2). Then*

$$A^{int} \subset \varliminf_{t \rightarrow \infty} D_t \subset \overline{\varliminf_{t \rightarrow \infty} D_t} \subset A$$

and

$$A^{int} \subset \varliminf_{t \rightarrow \infty} E_t \subset \overline{\varliminf_{t \rightarrow \infty} E_t} \subset A.$$

Proof. We take $\delta > 0$ small enough to satisfy $B_{2\delta}(\Gamma) \subset D_0$ and $B_{2\delta}((a, f(a))) \cup B_{2\delta}((b, f(b))) \subset O_-$.

1) $x \in O_-$. The proof for this case is the same as before.

2) $x \in B_\delta(\Gamma) \setminus O_-$. Paul keeps taking a Γ tube strategy until he reaches $B_\delta((a, f(a))) \cup B_\delta((b, f(b)))$. Once he reaches $B_\delta((a, f(a))) \cup B_\delta((b, f(b)))$, he quits the game.

By his doing this strategy, the game trajectory $\{x_n\}$ is restricted to $B_\delta(\Gamma)$ as shown in Lemma 4.9. Thus, whether he quits the game or not, he gains at least $\delta > 0$.

3) $x \in A^{int} \setminus (B_\delta(\Gamma) \cup O_-)$. We extend f as follows:

$$\tilde{f}(p) := \begin{cases} \max\{f(p), \sqrt{(r - \delta_1)^2 - (p + d)^2}\}, & -d - r + \delta_1 \leq p \leq -d + r - \delta_1 \\ \max\{f(p), \sqrt{(r - \delta_1)^2 - (p - d)^2}\}, & d - r + \delta_1 \leq p \leq d + r - \delta_1 \\ f(p), & -d + r - \delta_1 < p < d - r + \delta_1. \end{cases}$$

Without loss of generality we can assume $x \in \{(p, q) \mid q \geq \tilde{f}(p), -d - r + \delta_1 \leq p \leq d + r - \delta_1\}$. We take $\delta_1, \delta_2 > 0$ and $\{z_n\}$ as in the case 2) in the proof of Proposition 4.13. See also Figure 16.

Paul's strategy is to keep taking a push by moving circle strategy with this $\{z_n\}$ until he reaches $O^{\delta_1} \cup B_\delta(\Gamma)$. Once he reaches O^{δ_1} , he quits the game. Once he reaches $B_\delta(\Gamma)$, he takes the same strategy as in the case 2).

By adopting this strategy, Paul actually gains positive game cost. Set

$$\Omega_n = \{(p, q) \mid q \geq \tilde{f}(p), -d - r + \delta_1 \leq p \leq d + r - \delta_1\} \cap B(z_n, \nu^{-1} + \delta_2) \setminus B_\delta(\Gamma)$$

for $n = 0, 1, \dots$. By 2 in Lemma 4.7 we see that if $x_n \in \Omega_n$, then $x_{n+1} \in \Omega_{n+1}$ or Paul reaches $O^{\delta_1} \cup B_\delta(\Gamma)$ (Figure 16). If $n\epsilon^2$ is sufficiently large, then $\Omega_n = \emptyset$. That means Paul definitely reaches $O^{\delta_1} \cup B_\delta(\Gamma)$ in finite time. Since the stopping cost is at least $\delta_1 > 0$ and the terminal cost is at least $\delta > 0$, it turns out that for $x \in A^{int}$, there exists $\tau > 0$ such that $u(x, t) > 0$ for $t > \tau$. \square

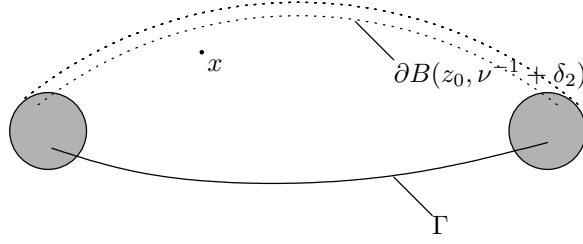

Figure 16: A strategy of Paul

Remark 4.15. We expect that the same conclusion holds for more general O_- . As an analogue of Theorem 3.2, we define the graph $G = (V, E)$ as follows:

$$V := \{O \subset \mathbb{R}^2 \mid O \text{ is a connected component of } O_-\},$$

$$E := \{\langle O, P \rangle \mid \text{There exist } x \in O, y \in P \text{ and } \Gamma_{x,y} \in \mathcal{L}_\nu \text{ such that } \Gamma_{x,y} \subset D_0\},$$

where we denote a curve $\Gamma = \gamma([0, 1]) \in \mathcal{L}_\nu$ satisfying $\gamma(0) = x$ and $\gamma(1) = y$ by $\Gamma_{x,y}$. It seems that if O_- satisfies (A1) and the graph G is connected, then the same conclusion holds.

Finally we give an example of computation of the asymptotic shape of solutions to (4.2). We can deal with the problem that remains in [9, Section 6], where $O_+ = \mathbb{R}^2 \setminus \{(p, q) \in \mathbb{R}^2 \mid |p| + |q| \leq R\}$ with $R = \sqrt{2}\nu^{-1}$. We also give a game theoretic proof for the case $R \neq \sqrt{2}\nu^{-1}$, which is considered in a different way in [9, Section 6].

We set

$$A := \bigcup \{B_{\nu^{-1}}(z) \mid B_{\nu^{-1}}(z) \subset O_+, z \in \mathbb{R}^2\}.$$

We notice that $A = B_{\nu^{-1}}((0, 0))$ if $R = \sqrt{2}\nu^{-1}$ and $A = \emptyset$ if $R < \sqrt{2}\nu^{-1}$. Figure 17 shows the result of the asymptotic shapes. In Figure 17, dotted circles are circles with the radius of ν^{-1} .

Proposition 4.16. *Assume either of the following:*

1. $R = \sqrt{2}\nu^{-1}$ and $B_{\nu^{-1}}((0, 0)) \subset D_0$,
2. $R < \sqrt{2}\nu^{-1}$,
3. $R > \sqrt{2}\nu^{-1}$ and $B(\hat{z}, \nu^{-1} + \delta) \subset D_0$ for some $\hat{z} \in \mathbb{R}^2$ and $\delta > 0$.

Then

$$A \subset \varliminf_{t \rightarrow \infty} D_t \subset \overline{\varliminf_{t \rightarrow \infty} D_t} \subset \bar{A}$$

and

$$A \subset \varliminf_{t \rightarrow \infty} E_t \subset \overline{\varliminf_{t \rightarrow \infty} E_t} \subset \bar{A}.$$

Proof. It suffices to take u_0 as (3.2). Similarly it suffices to let

$$\Psi_+(x) = \begin{cases} \text{dist}(x, \partial O_+), & x \in O_+ \\ \max\{a, -\text{dist}(x, \partial O_+)\}, & x \in O_+^c. \end{cases}$$

1. **1) $x \in B_{\nu^{-1}}((0, 0))$.** Paul's strategy is to keep taking a $(0, 0)$ concentric strategy. We denote by $V^\epsilon(x, t)$ the total cost when Paul takes this strategy with the game variables (x, t, ϵ) and Carol does not quit the game on the way. Notice that $V^\epsilon(x, t)$ does not depend on Carol's choices $\{b_n\}$ because u_0 is radially symmetric. Since $u_0(x_n)$ is monotonically decreasing with respect to n and $u_0(x_n) \leq \Psi_+(x_n)$, Carol's optimal strategy for the strategy of Paul is not to quit the game on the way. Thus the inequality $u^\epsilon(x, t) \geq V^\epsilon(x, t)$ is satisfied. Fix $x \in B_{\nu^{-1}}((0, 0))$ and $t > 0$. By Lemma 4.4 we have $V^\epsilon(x, t) > 0$ for sufficiently small $\epsilon > 0$. Lemma 4.3 2 implies that for any subsequence $\{\epsilon_n\}$ satisfying $\epsilon_n = 2^{-n}\epsilon_0$, $V^{\epsilon_n}(x, t)$ is monotonically increasing with respect to n . Therefore we obtain $u(x, t) > 0$.

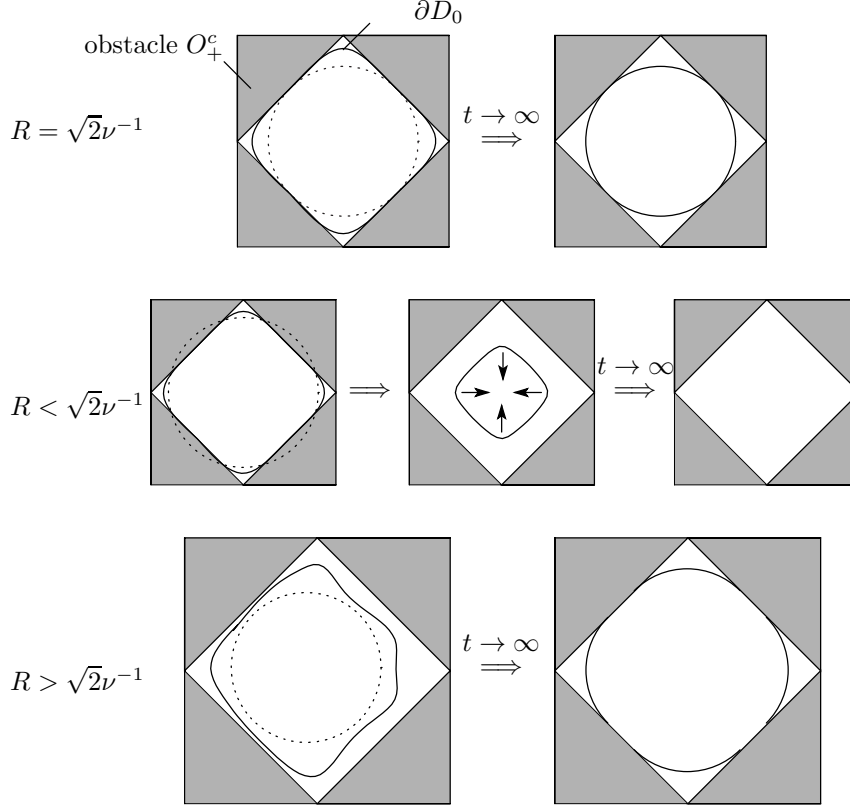

Figure 17: Square boxes

2) $x \in \overline{O_+^c}$. Carol's strategy is to quit the game at the first round.

3) $x = (p, q) \in \overline{A^c} \setminus \overline{O_+^c}$. We may assume $q \geq |p|$. We can take $z_0 \in \mathbb{R}^2$, $\delta_1 > 0$ and $\delta_2 > 0$ so that $|x - z_0| \geq \nu^{-1} - \delta_1$, $z_0 \in \{(0, y) \mid y > 0\}$ and $\partial B(z_0, \nu^{-1} - \delta_1) \cap \overline{B_{\delta_2}(O_+^c)} \neq \emptyset$. Carol's strategy is to take a push by moving circle strategy with $\{z_n\} \subset \{(0, q) \mid q > 0\}$ satisfying $z_{n+1} = z_n + (0, \frac{\delta_1}{2} \nu^2 \epsilon^2)$ for all n until Paul reaches $\overline{B_{\delta_2}(O_+^c)}$. Once he reaches there, she quits the game. See Figure 18.

By doing above strategy, Carol actually pays negative game cost. To show it, set

$$\Omega_n = \{(p, q) \mid q \geq |p|\} \cap \left(\overline{B_{\delta_2}(O_+)} \setminus B(z_n, \nu^{-1} - \delta_1) \right)$$

for $n = 0, 1, \dots$. We see that if $x_n \in \Omega_n$, then $x_{n+1} \in \Omega_{n+1}$ or Carol quits the game at round $n + 1$. If $n\epsilon^2$ is sufficiently large, then $\Omega_n = \emptyset$. That means Carol definitely quits the game in finite time and the stopping cost is at most

$$\sup_{y \in \overline{B_{\delta_2}(O_+)}} \Psi_+(y) = -\delta_2 < 0$$

regardless of ϵ . Therefore we obtain $u(x, t) < 0$ for $x \in \overline{B_{\nu^{-1}}((0, 0))}$ and sufficiently large $t > 0$.

2. We take $\delta_1 > 0$ to satisfy $B((0, 0), \nu^{-1} - 2\delta_1) \cap \overline{O_+^c} \neq \emptyset$.

1) $x \in \overline{O_+^c}$. Carol's strategy is to quit the game at the first round.

2) $x \in \overline{O_+} \setminus B((0, 0), \nu^{-1} - \delta_1)$. Carol's strategy is similar to that in the case 3) in 1.

3) $x \in \overline{O_+} \cap B((0, 0), \nu^{-1} - \delta_1)$. Carol keeps taking a $(0, 0)$ concentric strategy until Paul is forced to reach $B((0, 0), \nu^{-1} - \delta_1)^c \cap B_{\delta_1}(O_+)^c$. By Lemma 4.5 it takes at most finite time for Paul to reach there. Once Paul reaches $B_{\delta_1}(O_+)^c$, Carol quits the game. Once Paul reaches $\overline{O_+} \setminus B((0, 0), \nu^{-1} - \delta_1)$, Carol's strategy is as in the case 2).

Therefore, for $x \in \mathbb{R}^2$, we obtain $u(x, t) < 0$ for sufficiently large $t > 0$.

3. 1) $x \in \overline{O_+^c}$. Carol's strategy is to quit the game at the first round.

2) $x \in \overline{O_+} \setminus A$. Carol's strategy is similar to that in the case 3) in 1.

3) $x \in A$. We set $O^{\delta_1} := \{x \in \mathbb{R}^2 \mid \Psi_+(x) > \delta_1\}$ and $C_{\delta_1, \delta_2} := \{z \in \mathbb{R}^2 \mid B(z, \nu^{-1} + \delta_2) \subset O^{\delta_1}\}$ for $\delta_1, \delta_2 > 0$. For $x \in A$, there exist $\delta_1, \delta_2 > 0$ such that

$$x \in \bigcup \{B(z, \nu^{-1} + \delta_2) \mid z \in C_{\delta_1, \delta_2}\}$$

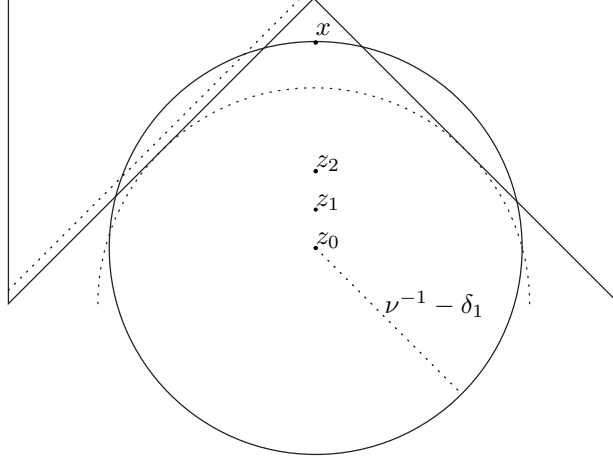

Figure 18: Carol's strategy

and $C_{0,\delta} \subset C_{\delta_1,\delta_2}$. Let $z_0 \in \mathbb{R}^2$ be a point satisfying $x \in B(z_0, \nu^{-1} + \delta_2)$ and $z_0 \in C_{\delta_1,\delta_2}$. We define the sequence $\{z_n\}$ by

$$z_n := z_0 + \min \left\{ \frac{\delta_2}{2} n \nu^2 \epsilon^2, |\hat{z} - z_0| \right\} \frac{\hat{z} - z_0}{|\hat{z} - z_0|}.$$

Since C_{δ_1,δ_2} is now convex, we have $l_{z_0,\hat{z}} \subset C_{\delta_1,\delta_2}$.

Paul's strategy is to take a push by moving circle strategy with this $\{z_n\}$. Indeed if Carol quits the game on the way, the stopping cost is at least $\delta_1 > 0$ because the game trajectory $\{x_n\}$ is contained in O^{δ_1} . If Carol does not quit the game, the terminal cost is at least $\delta - \delta_1$, which is positive. That is because $x_N \in B(\hat{z}, \nu^{-1} + \delta_1) \subset B(\hat{z}, \nu^{-1} + \delta) \subset D_0$ for any last position x_N of the game. □

A Game interpretation and convergence of value functions

In this appendix we give a game whose value functions converge to the viscosity solution to (2.1). We introduce the rule of the game corresponding to (2.1) with $\nu \geq 0$ and $d = 2$ and give the proof of the convergence result for the case. We also remark on the other $\nu \in \mathbb{R}$ and d .

The game is almost the same as explained in Section 1. We define the total number N of rounds by $N = \lceil t\epsilon^{-2} \rceil$, where $\lceil r \rceil$ stands for the minimum integer that is no less than r . The actions of both players in each round i ($i = 1, 2, \dots, N$) are modified as follows:

1. Paul decides whether to quit the game.
2. Carol decides whether to quit the game.
3. Paul chooses $v_i, w_i \in S^1$. (S^1 is the set of unit vectors in \mathbb{R}^2 .)
4. Carol chooses $b_i \in \{\pm 1\}$ after Paul's choice.
5. Determine the next states as follows.

$$x_i = x_{i-1} + \sqrt{2}\epsilon b_i v_i + \nu \epsilon^2 w_i. \tag{A.1}$$

The total cost is also modified as follows. If Paul quits the game at round i , the total cost is given by $\Psi_-(x_i)$. If Carol quits the game at round i , it is given by $\Psi_+(x_i)$. If both players go throughout N rounds of the game, it is given by $u_0(x_N) + \sum_{i=0}^{N-1} \epsilon^2 f(x_i)$. The value function $u^\epsilon(x, t)$ is defined inductively based on the following *Dynamic Programming Principle* and the initial condition:

$$u^\epsilon(x, t) = \max \left\{ \Psi_-(x), \min \left\{ \Psi_+(x), \sup_{v,w \in S^1} \min_{b=\pm 1} [u^\epsilon(x + \sqrt{2}\epsilon b v + \nu w \epsilon^2, t - \epsilon^2) + \epsilon^2 f(x)] \right\} \right\} \tag{A.2}$$

for $t > 0$.

$$u^\epsilon(x, t) = u_0(x) \tag{A.3}$$

for $t \leq 0$.

These value functions mean the total cost optimized by both players.

Remark A.1. As explained in Section 1, we can generalize our game to the case $d \geq 3$. In the game corresponding to (2.1) with $\nu \geq 0$, Paul chooses a unit vector w_i and $d - 1$ orthogonal unit vectors $v_i^j (j = 1, 2, \dots, d - 1)$. Carol chooses $d - 1$ values $b_i^j \in \{\pm 1\} (j = 1, 2, \dots, d - 1)$. The state equation is $x_i = x_{i-1} + \nu w_i \epsilon^2 + \sqrt{2} \epsilon \sum_{j=1}^{d-1} b_i^j v_i^j$ instead of (A.1).

Remark A.2. The Dynamic Programming Principle corresponding to (2.1) with $\nu < 0$ is given by

$$u^\epsilon(x, t) = \max\{\Psi_-(x), \min\{\Psi_+(x), \sup_{v \in S^1} \inf_{\substack{w \in S^1 \\ b = \pm 1}} [u^\epsilon(x + \sqrt{2}\epsilon bv + \nu w \epsilon^2, t - \epsilon^2) + \epsilon^2 f(x)]\}\}.$$

Namely, not Paul but Carol has the right to choose $w_i \in S^1$.

For these value functions, the same type of result as Proposition 1.1 holds.

Proposition A.3. *the functions \bar{u} and \underline{u} are respectively viscosity sub- and supersolution of (2.1). Moreover $\bar{u}(x, 0) = \underline{u}(x, 0) = u_0(x)$ for $x \in \mathbb{R}^d$.*

Remark A.4. As explained before, (2.1) with $f = 0$ is a level set equation. By choosing Ψ_+ so that $\Psi_+ > \|u_0\|_\infty$ for $O_+ = \mathbb{R}^d$, we can ignore Carol's stopping cost Ψ_+ when we consider obstacle problems that have an obstacle on one side such as (1.1). Similarly, by choosing Ψ_- so that $\Psi_- < -\|u_0\|_\infty$ for $O_- = \emptyset$, we can ignore Paul's stopping cost Ψ_- .

We especially show the proof of Proposition A.3 with $d = 2$ and $\nu \geq 0$ because the other case is similar. Our proof is based directly on the game as in [14], whereas those in [12, 15] are based on the properties of the operator whose fixed point is the solution of the Dynamic Programming Principle. Also since the proof in [14] is local argument, roughly speaking, all we have to do is to do the local argument in $\{(x, t) \mid \Psi_-(x) < \bar{u}(x, t)\}$ or in $\{(x, t) \mid \Psi_+(x) > \underline{u}(x, t)\}$. However we need to care about the point that $\{(x, t) \mid \Psi_-(x) < \bar{u}(x, t)\}$ or $\{(x, t) \mid \Psi_+(x) > \underline{u}(x, t)\}$ may not be open.

The proof consists of three steps. We show that the limits of the value functions satisfy the conditions (a) and (c) in Definition 2.1 in the first two propositions, (Proposition A.5 and A.7) and they satisfy the initial condition (b) in the last one. (Proposition A.11) We mention that the initial data u_0 is assumed to be just continuous, not to be Lipschitz continuous as in [12] or bounded uniformly continuous as in [15]. Regarding the last proposition, the idea of the proof is similar to that of [8, Proposition 3.1] though the situation is different.

To visualize choices of players of the game, we give another description of the level-set mean curvature flow operator F :

$$F(Du, D^2u) = - \left\langle D^2u \frac{D^\perp u}{|Du|}, \frac{D^\perp u}{|Du|} \right\rangle$$

for $Du \neq 0$. Here we denote by $D^\perp u$ a vector field satisfying $Du \cdot D^\perp u = 0$ and $|Du| = |D^\perp u|$ in \mathbb{R}^2 .

Proposition A.5. *The function \underline{u} is a viscosity supersolution of (2.1) in $\mathbb{R}^2 \times (0, \infty)$.*

Proof. As for Definition 2.1-2(a), we directly have $\Psi_-(x) \leq u^\epsilon(x, t) \leq \Psi_+(x)$ by the Dynamic Programming Principle (A.2). Thus we obtain $\Psi_-(x) \leq \underline{u}(x, t) \leq \Psi_+(x)$ since Ψ_+ and Ψ_- are continuous. To prove the viscosity inequality, we argue by contradiction. For a smooth function $\phi : \mathbb{R}^2 \times (0, \infty) \rightarrow \mathbb{R}$, a positive constant $\theta_0 > 0$ and $(x, t) \in \mathbb{R}^2 \times (0, \infty)$, we consider the following condition (C):

$$\partial_t \phi(x, t) - \nu |D\phi(x, t)| - \left\langle D^2 \phi(x, t) \frac{D^\perp \phi(x, t)}{|D\phi(x, t)|}, \frac{D^\perp \phi(x, t)}{|D\phi(x, t)|} \right\rangle - f_*(x) \leq -\theta_0 < 0 \quad (\text{A.4})$$

if $D\phi(x, t) \neq 0$, and

$$\partial_t \phi(x, t) - \nu |D\phi(x, t)| - \inf_{|\zeta|=1} \langle D^2 \phi(x, t) \zeta, \zeta \rangle - f_*(x) \leq -\theta_0 < 0 \quad (\text{A.5})$$

if $D\phi(x, t) = 0$.

We assume that there exist a smooth function ϕ and (\hat{x}, \hat{t}) such that (\hat{x}, \hat{t}) is a strict local minimum of $\underline{u} - \phi$, $\underline{u} < \Psi_+$ at (\hat{x}, \hat{t}) and the condition (C) is satisfied at (\hat{x}, \hat{t}) with ϕ and some $\theta_0 > 0$. Then we can take a δ neighborhood of (\hat{x}, \hat{t}) where $\underline{u} - \phi$ attains its unique minimum at (\hat{x}, \hat{t}) and the condition (C) holds, retaking smaller $\theta_0 > 0$ if necessary. For technical reasons, we take such δ neighborhood as $N_\delta((\hat{x}, \hat{t})) := \{(x, t) \in \mathbb{R}^2 \times [0, \infty) \mid |x - \hat{x}| + |t - \hat{t}| < \delta\}$ and $\delta > 0$ small enough to satisfy $\delta \leq \frac{a}{2 \max\{L, M\}}$, where $a := \Psi_+(\hat{x}) - \underline{u}(\hat{x}, \hat{t})$, L is the Lipschitz constant of Ψ_+ and $M = \sup_{y \in B_1(\hat{x})} |f(y)|$.

From the definition of \underline{u} , there are sequence $\{\epsilon_n\}$, $\{x_{\epsilon_n}^0\}$, and $\{t_{\epsilon_n}^0\}$ satisfying

$$\epsilon_n \searrow 0, \quad (x_{\epsilon_n}^0, t_{\epsilon_n}^0) \rightarrow (\hat{x}, \hat{t}), \quad u^{\epsilon_n}(x_{\epsilon_n}^0, t_{\epsilon_n}^0) \rightarrow \underline{u}(\hat{x}, \hat{t}).$$

We may substitute ϵ for ϵ_n hereafter. We take ϵ small enough to satisfy $(x_\epsilon^0, t_\epsilon^0) \in N_{\delta/2}((\hat{x}, \hat{t}))$ and $\Psi_+(x_\epsilon^0) - u^\epsilon(x_\epsilon^0, t_\epsilon^0) \geq a/2$. For any ϵ , we construct the sequence $\{X_k\}$ satisfying

$$X_0 = (x_\epsilon^0, t_\epsilon^0),$$

$$X_{k+1} = X_k + (\sqrt{2}\epsilon b_k \eta_k^\perp + \nu \eta_k \epsilon^2, -\epsilon^2), \quad (\text{A.6})$$

where $\eta_k = \frac{D\phi(X_k)}{|D\phi(X_k)|}$ if $D\phi(X_k) \neq 0$, and is an arbitrary unit vector if $D\phi(X_k) = 0$. We will determine b_k later. Let x_k and t_k denote the spatial and time component of X_k respectively hereafter. Let k_ϵ be the maximal k satisfying

$$X_j \in N_{\delta/2}((\hat{x}, \hat{t})) \text{ for any } j = 0, 1, \dots, k-1.$$

Indeed such k_ϵ exists because of the definition of the sequence $\{X_k\}$. We prove by induction that $\Psi_+(x_k) > u^\epsilon(X_k)$ and

$$u^\epsilon(X_0) - u^\epsilon(X_k) \geq \epsilon^2 \sum_{m=0}^{k-1} f(x_m) \quad (\text{A.7})$$

for all $k < k_\epsilon$. These inequalities hold for $k = 0$. We assume that these hold for some $k < k_\epsilon$. Then the Dynamic Programming Principle (A.2) and $\Psi_+(x_k) > u^\epsilon(X_k)$ imply

$$u^\epsilon(X_k) = \max\{\Psi_-(x_k), \sup_{v, w \in S^1} \min_{b=\pm 1} u^\epsilon(x_k + \sqrt{2}\epsilon b v + \nu w \epsilon^2, t_k - \epsilon^2) + \epsilon^2 f(x_k)\}.$$

Thus we have

$$u^\epsilon(X_k) \geq \min_{b=\pm 1} u^\epsilon(x_k + \sqrt{2}\epsilon b \eta_0^\perp + \nu \eta_0 \epsilon^2, t_k - \epsilon^2) + \epsilon^2 f(x_k). \quad (\text{A.8})$$

We determine b_k in (A.6) as a minimizer b in (A.8). We then get

$$u^\epsilon(X_k) - u^\epsilon(X_{k+1}) \geq \epsilon^2 f(x_k).$$

Adding (A.7), we have

$$u^\epsilon(X_0) - u^\epsilon(X_{k+1}) \geq \epsilon^2 \sum_{m=0}^k f(x_m)$$

and consequently

$$u^\epsilon(X_0) + M(k+1)\epsilon^2 \geq u^\epsilon(X_{k+1}). \quad (\text{A.9})$$

If $k+1 < k_\epsilon$, we see from the definition of k_ϵ that $X_{k+1} \in N_{\delta/2}((\hat{x}, \hat{t}))$ and thus

$$|x_{k+1} - x_0| + |t_{k+1} - t_0| \leq |x_{k+1} - \hat{x}| + |x_0 - \hat{x}| + |t_{k+1} - \hat{t}| + |t_0 - \hat{t}| \leq \delta. \quad (\text{A.10})$$

From the Lipschitz continuity of Ψ_+ , we have

$$|\Psi_+(x_{k+1}) - \Psi_+(x_0)| \leq L|x_{k+1} - x_0| \leq L(\delta - |t_{k+1} - t_0|) = L(\delta - (k+1)\epsilon^2). \quad (\text{A.11})$$

Combining (A.9) and (A.11), we obtain

$$\begin{aligned} \Psi_+(x_{k+1}) - u^\epsilon(X_{k+1}) &\geq \Psi_+(x_0) - L(\delta - (k+1)\epsilon^2) - u^\epsilon(X_0) - M(k+1)\epsilon^2 \\ &\geq \Psi_+(x_0) - \max\{L, M\}(\delta - (k+1)\epsilon^2) - u^\epsilon(X_0) - \max\{L, M\}(k+1)\epsilon^2 \\ &\geq \Psi_+(x_0) - u^\epsilon(X_0) - \max\{L, M\}\delta \\ &> \frac{a}{2} - \frac{a}{2} = 0 \end{aligned}$$

and conclude the induction.

Next we take the continuous path that affinely interpolates among $\{X_k\}$, i.e., $X(s) = X_k + (s\epsilon^{-2} - k)(X_{k+1} - X_k)$ for $k\epsilon^2 \leq s \leq (k+1)\epsilon^2$, and we write $X(s) = (x(s), t_\epsilon^0 - s)$. Using Taylor's theorem for $\phi(X(t))$ at $t = k\epsilon^2$, we get

$$\phi(X_{k+1}) - \phi(X_k) = \epsilon^2 \{-\partial_t \phi(X_k) + \nu |D\phi(X_k)| + \langle D^2 \phi(X_k) \eta_k^\perp, \eta_k^\perp \rangle\} + \Psi_k(\epsilon), \quad (\text{A.12})$$

where $\Psi_k(\epsilon) = o(\epsilon^2)$. Moreover, from the assumption (A.4), we have

$$\phi(X_{k+1}) - \phi(X_k) \geq \epsilon^2(\theta_0 - f_*(x_k)) + \Psi_k(\epsilon).$$

This inequality is also obtained in the case $D\phi(X_k) = 0$, using (A.12) and (A.5). Summing up both sides, we have

$$\phi(X_k) - \phi(X_0) \geq k\epsilon^2 \theta_0 - \epsilon^2 \sum_{m=0}^{k-1} f_*(x_m) + \sum_{m=0}^{k-1} \Psi_m(\epsilon). \quad (\text{A.13})$$

Provided $k < k_\epsilon$, we have

$$|\Psi_k(\epsilon)| \leq C\epsilon^3,$$

where C depends on ϕ in δ neighborhood around (\hat{x}, \hat{t}) , and does not depend on k . This estimation is derived from the Taylor expansion (A.12). Hence (A.13) becomes

$$\phi(X_k) - \phi(X_0) \geq k\epsilon^2 \theta_0 - \epsilon^2 \sum_{m=0}^{k-1} f_*(x_m) + kC\epsilon^3, \quad k \leq k_\epsilon.$$

Adding this relation to (A.7), we have

$$\begin{aligned} u^\epsilon(X_0) - \phi(X_0) &\geq u^\epsilon(X_k) - \phi(X_k) + \epsilon^2 \sum_{m=0}^{k-1} (f(x_m) - f_*(x_m)) + k\epsilon^2\theta_0 + kC\epsilon^3 \\ &\geq u^\epsilon(X_k) - \phi(X_k) + k\epsilon^2\theta_0 + kC\epsilon^3. \end{aligned}$$

For sufficiently small ϵ , we get

$$-\frac{k}{2}\epsilon^2\theta_0 \geq u^\epsilon(X_k) - u^\epsilon(X_0) - \phi(X_k) + \phi(X_0), \quad k \leq k_\epsilon. \quad (\text{A.14})$$

By the definition of k_ϵ , we see that $Y_\epsilon \in \overline{N_{3\delta/4}((\hat{x}, \hat{t}))} \setminus N_{\delta/2}((\hat{x}, \hat{t}))$, where we substitute Y_ϵ for X_{k_ϵ} . So there is a subsequence $\{Y_{\epsilon_n}\}_n$ such that

$$\lim_{n \rightarrow \infty} Y_{\epsilon_n} = (x', t'),$$

where $(x', t') \in B_\delta((\hat{x}, \hat{t}))$ and $(x', t') \neq (\hat{x}, \hat{t})$. From (A.14), we have

$$u^{\epsilon_n}(x_{\epsilon_n}^0, t_{\epsilon_n}^0) - \phi(x_{\epsilon_n}^0, t_{\epsilon_n}^0) \geq u^{\epsilon_n}(Y_{\epsilon_n}) - \phi(Y_{\epsilon_n}).$$

Letting n go to ∞ , we obtain

$$\underline{u}(\hat{x}, \hat{t}) - \phi(\hat{x}, \hat{t}) \geq \underline{u}(x', t') - \phi(x', t').$$

This is a contradiction since $\underline{u} - \phi$ attains its unique minimum at (\hat{x}, \hat{t}) . \square

The following lemma can be found in [14, Lemma 2.3].

Lemma A.6. *Let ϕ be a C^3 function on a compact subset K of \mathbb{R}^2 . Let $x \in K$ and $\epsilon \in [0, \infty)$. If $D\phi(x) \neq 0$, there exists a constant C_1 (depending only on the C^2 norm of ϕ) with the following two properties for all unit vectors $v \in \mathbb{R}^2$.*

1. If $\sqrt{2}|\langle D\phi(x), v \rangle| \geq C_1\epsilon$,

$$\sqrt{2}\epsilon|\langle D\phi, v \rangle| + \epsilon^2\langle D^2\phi v, v \rangle \geq \epsilon^2 \left\langle D^2\phi \frac{D^\perp\phi}{|D\phi|}, \frac{D^\perp\phi}{|D\phi|} \right\rangle$$

at x .

2. If $\sqrt{2}|\langle D\phi(x), v \rangle| \leq C_1\epsilon$, there exists a constant C_2 (depending only on the C^2 norm of ϕ) such that

$$\sqrt{2}\epsilon|\langle D\phi, v \rangle| + \epsilon^2\langle D^2\phi v, v \rangle \geq \epsilon^2 \left\langle D^2\phi \frac{D^\perp\phi}{|D\phi|}, \frac{D^\perp\phi}{|D\phi|} \right\rangle - \frac{C_2\epsilon^3}{|D\phi|}$$

at x .

Proposition A.7. *The function \bar{u} is a viscosity subsolution of (2.1) in $\mathbb{R}^2 \times (0, \infty)$.*

Proof. As in Proposition A.5, we obtain $\Psi_-(x) \leq \bar{u}(x, t) \leq \Psi_+(x)$ and argue by contradiction to prove the viscosity inequality. We prepare the following conditions:

$$\partial_t\phi(x, t) - \nu|D\phi(x, t)| - \left\langle D^2\phi(x, t) \frac{D^\perp\phi(x, t)}{|D\phi(x, t)|}, \frac{D^\perp\phi(x, t)}{|D\phi(x, t)|} \right\rangle - f^*(x) \geq \theta_0 > 0, \quad (\text{A.15})$$

$$\partial_t\phi(x, t) - \nu|D\phi(x, t)| - \sup_{|\zeta|=1} \langle D^2\phi(x, t)\zeta, \zeta \rangle - f^*(x) \geq \theta_0 > 0. \quad (\text{A.16})$$

We assume that there exist a smooth function ϕ and (\hat{x}, \hat{t}) such that (\hat{x}, \hat{t}) is a strict local maximum of $\bar{u} - \phi$, $\bar{u} > \Psi_-$ at (\hat{x}, \hat{t}) and, for some $\theta_0 > 0$, (A.15) is satisfied at (\hat{x}, \hat{t}) provided $D\phi(\hat{x}, \hat{t}) \neq 0$, and (A.16) is satisfied at (\hat{x}, \hat{t}) provided $D\phi(\hat{x}, \hat{t}) = 0$. If $D\phi(\hat{x}, \hat{t}) \neq 0$, we take a δ neighborhood of (\hat{x}, \hat{t}) where $\bar{u} - \phi$ attains its unique maximum at (\hat{x}, \hat{t}) , $|D\phi| > \theta_1$ for some $\theta_1 > 0$, and (A.15) holds, retaking smaller $\theta_0 > 0$ if necessary. If $D\phi(\hat{x}, \hat{t}) = 0$, we take a δ neighborhood of (\hat{x}, \hat{t}) where $\bar{u} - \phi$ attains its unique maximum at (\hat{x}, \hat{t}) and (A.16) holds, retaking smaller $\theta_0 > 0$ if necessary. We take $\delta > 0$ small enough to satisfy $\delta \leq \frac{b}{3\max\{L, M\}}$, where $b := \bar{u}(\hat{x}, \hat{t}) - \Psi_-(\hat{x})$. From the definition of \bar{u} , there are some sequences $\{\epsilon_n\}$, $\{x_{\epsilon_n}^0\}$, and $\{t_{\epsilon_n}^0\}$ satisfying

$$\epsilon_n \searrow 0, \quad (x_{\epsilon_n}^0, t_{\epsilon_n}^0) \rightarrow (\hat{x}, \hat{t}), \quad u^{\epsilon_n}(x_{\epsilon_n}^0, t_{\epsilon_n}^0) \rightarrow \bar{u}(\hat{x}, \hat{t}).$$

We may substitute ϵ for ϵ_n hereafter. We take ϵ small enough to satisfy $(x_\epsilon^0, t_\epsilon^0) \in N_{\delta/2}((\hat{x}, \hat{t}))$ and $u^\epsilon(x_\epsilon^0, t_\epsilon^0) - \Psi_-(x_\epsilon^0) \geq b/2$.

We construct the sequence $\{X_k\}$ and the functions $\Psi_k : S^1 \times S^1 \rightarrow \mathbb{R}$ inductively as follows. We first let

$$X_0 := (x_\epsilon^0, t_\epsilon^0),$$

and

$$\Psi_0(v, w) := \min_{b=\pm 1} u^\epsilon(x_\epsilon^0 + \sqrt{2}\epsilon bv + \nu\epsilon^2 w, t_\epsilon^0 - \epsilon^2) + \epsilon^2 f(x_\epsilon^0).$$

Then let (v_0, w_0) satisfying

$$\Psi_0(v_0, w_0) \geq \sup_{(v, w) \in S^1 \times S^1} \Psi_0(v, w) - \epsilon^3,$$

and we determine

$$X_1 = X_0 + (\sqrt{2}\epsilon b_0 v_0 + \nu\epsilon^2 w_0, -\epsilon^2),$$

where we will decide b_0 later. For any $k \in \mathbb{N}$, we similarly define

$$\Psi_k(v, w) := \min_{b=\pm 1} u^\epsilon(x_k + \sqrt{2}\epsilon bv + \nu\epsilon^2 w, t_k - \epsilon^2) + \epsilon^2 f(x_k),$$

and

$$X_{k+1} := X_k + (\sqrt{2}\epsilon b_k v_k + \nu\epsilon^2 w_k, -\epsilon^2), \quad (\text{A.17})$$

where $(v_k, w_k) \in S^1 \times S^1$ satisfies

$$\Psi_k(v_k, w_k) \geq \sup_{(v, w) \in S^1 \times S^1} \Psi_k(v, w) - \epsilon^3.$$

Define k_ϵ as in the proof of Proposition A.5. We prove by induction that $u^\epsilon(X_k) > \Psi_-(x_k)$ and

$$u^\epsilon(X_0) - u^\epsilon(X_k) \leq \epsilon^2 \sum_{m=0}^{k-1} [f(x_m)] + k\epsilon^3 \quad (\text{A.18})$$

for all $k < k_\epsilon$. These inequalities hold for $k = 0$. We assume that these hold for some $k < k_\epsilon$. Then the Dynamic Programming Principle (A.2) and $u^\epsilon(X_k) > \Psi_-(x_k)$ imply

$$u^\epsilon(X_k) = \min\{\Psi_+(x_k), \sup_{v, w \in S^1} \min_{b=\pm 1} u^\epsilon(x_k + \sqrt{2}\epsilon bv + \nu w \epsilon^2, t_k - \epsilon^2) + \epsilon^2 f(x_k)\}.$$

Thus we have

$$\begin{aligned} u^\epsilon(X_k) &\leq \sup_{v, w \in S^1} \Psi_k(v, w) \\ &\leq \Psi_k(v_k, w_k) + \epsilon^3 \\ &= u^\epsilon(x_k + \sqrt{2}\epsilon b_k v_k + \nu w_k \epsilon^2, t_k - \epsilon^2) + \epsilon^2 f(x_k) + \epsilon^3 \end{aligned}$$

and hence

$$u^\epsilon(X_k) - u^\epsilon(X_{k+1}) \leq \epsilon^2 f(x_k) + \epsilon^3, \quad (\text{A.19})$$

which means (A.18) holds for $k + 1$. From the Lipschitz continuity of Ψ_- and (A.10), we have

$$-\Psi_-(x_{k+1}) \geq -\Psi_-(x_0) - L(\delta - (k+1)\epsilon^2) \quad (\text{A.20})$$

provided $k + 1 < k_\epsilon$. Combining (A.19) and (A.20), we obtain

$$\begin{aligned} &u^\epsilon(X_{k+1}) - \Psi_-(x_{k+1}) \\ &\geq u^\epsilon(X_0) - \Psi_-(x_0) - M(k+1)\epsilon^2 - L(\delta - (k+1)\epsilon^2) - (k+1)\epsilon^3 \\ &\geq u^\epsilon(X_0) - \Psi_-(x_0) - \max\{M, L\}\delta - (k+1)\epsilon^3. \end{aligned}$$

We notice that $(k+1)\epsilon^3 \leq L\delta\epsilon$ from (A.11). Therefore $u^\epsilon(X_{k+1}) > \Psi_-(x_{k+1})$ holds for sufficiently small ϵ and we conclude the induction.

Next we take the continuous path $X(s)$ and use the Taylor's theorem in the same way as in Proposition A.5. Then we have

$$\begin{aligned} &\phi(X_{k+1}) - \phi(X_k) \\ &= \sqrt{2}\epsilon b_k \langle D\phi(X_k), v_k \rangle + \epsilon^2 \{-\partial_t \phi(X_k) + \nu \langle D\phi(X_k), w_k \rangle + \langle D^2 \phi(X_k) v_k, v_k \rangle\} + \Phi_k(\epsilon), \end{aligned}$$

where $\Phi_k(\epsilon) = o(\epsilon^2)$. By taking b_k in (A.17) properly, we get

$$\begin{aligned} &\phi(X_{k+1}) - \phi(X_k) \\ &\leq -\sqrt{2}\epsilon |\langle D\phi(X_k), v_k \rangle| + \epsilon^2 \{-\partial_t \phi(X_k) + \nu |D\phi(X_k)| + \langle D^2 \phi(X_k) v_k, v_k \rangle\} + \Phi_k(\epsilon). \end{aligned} \quad (\text{A.21})$$

We first consider the case $D\phi(\hat{x}, \hat{t}) \neq 0$. If $k < k_\epsilon$, we just consider ϕ in $N_\delta((\hat{x}, \hat{t}))$. We now use the assumption (A.15) and Lemma A.6 replacing ϕ by $-\phi$ to get

$$\begin{aligned} & \phi(X_{k+1}) - \phi(X_k) \\ & \leq \epsilon^2 \left\{ -\partial_t \phi(X_k) + \nu |D\phi(X_k)| + \left\langle D^2 \phi(X_k) \frac{D^\perp \phi(X_k)}{|D\phi(X_k)|}, \frac{D^\perp \phi(X_k)}{|D\phi(X_k)|} \right\rangle \right\} \\ & + \frac{C_2 \epsilon^3}{|D\phi(X_k)|} + \Phi_k(\epsilon) \\ & \leq \epsilon^2 \left(-\frac{\theta_0}{2} - f^*(x_k) \right), \end{aligned} \tag{A.22}$$

for sufficiently small ϵ . This inequality is also obtained in the case $D\phi(\hat{x}, \hat{t}) = 0$, using (A.21) and the assumption (A.16). From (A.19) and (A.22), we have

$$u^\epsilon(X_0) - u^\epsilon(X_k) - \phi(X_0) + \phi(X_k) \leq -\frac{k}{4} \epsilon^2 \theta_0, \quad k \leq k_\epsilon. \tag{A.23}$$

By the same argument as in Proposition A.5, we obtain

$$\bar{u}(\hat{x}, \hat{t}) - \phi(\hat{x}, \hat{t}) \leq \bar{u}(x', t') - \phi(x', t'),$$

where $(x', t') \neq (\hat{x}, \hat{t})$. This is a contradiction since $\bar{u} - \phi$ attains its unique maximum at (\hat{x}, \hat{t}) . \square

The proof of Proposition A.3 is completed by checking that \bar{u} and \underline{u} satisfy the initial condition. To prove the last proposition, we need additional property of the solution to (4.3) and strategies of the game.

Lemma A.8. *Let $\delta \in (0, \nu^{-1}]$. For sufficiently small $\epsilon > 0$, we have*

$$\frac{r_2 - \delta}{\delta^{-1} - \frac{\nu}{2}} \leq t_\epsilon(r_1, r_2),$$

for any r_1 and r_2 satisfying $0 \leq r_1 \leq \delta \leq r_2 \leq \nu^{-1}$.

Proof. Let $\delta \leq r \leq \nu^{-1}$. We take $\epsilon > 0$ small enough to satisfy $T_{\epsilon^2}(r) \geq r$. Concretely we assume $\nu \epsilon^2 \leq \delta$. Then the inequality (4.4) implies

$$T_{\epsilon^2}(r) - r \leq (\delta^{-1} - \nu) \epsilon^2 + \frac{\nu^2 \epsilon^4}{2\delta}.$$

Hence we obtain

$$t_\epsilon(r_1, r_2) \geq t_\epsilon(\delta, r_2) \geq \frac{r_2 - \delta}{(\delta^{-1} - \nu) \epsilon^2 + \frac{\nu^2 \epsilon^4}{2\delta}} \epsilon^2 \geq \frac{r_2 - \delta}{\delta^{-1} - \nu + \frac{\nu}{2}} = \frac{r_2 - \delta}{\delta^{-1} - \frac{\nu}{2}}.$$

\square

Definition A.9 (Reversed concentric strategy). Let $\nu > 0$, $\epsilon > 0$ and $z \in \mathbb{R}^2$. Let $x \in \mathbb{R}^2$ be the current position of the game. Let $(v, w) \in S^1 \times S^1$ be a choice by Paul in the same round. A choice $b \in \{\pm 1\}$ by Carol is called a *reversed z concentric strategy* if

$$\langle bv, x + \nu \epsilon^2 w - z \rangle \leq 0.$$

If Carol takes reversed z concentric strategy through the game, we get $|x_n - z| \leq P_n$, where P_n satisfies

$$P_{n+1} = \sqrt{(P_n + \nu \epsilon^2)^2 + 2\epsilon^2} \tag{A.24}$$

with $P_0 = |x_0 - z|$. We define $t_\epsilon(a, b)$ in the same way as (4.6), replacing the operator T_h as follows:

$$T_h(R) := \sqrt{(R + \nu h)^2 + 2h}.$$

Lemma A.10. *Let $\delta > 0$. For sufficiently small $\epsilon > 0$, we have*

$$\frac{r_2 - \delta}{\delta^{-1} + \nu + 1} \leq t_\epsilon(r_1, r_2)$$

for any r_1 and r_2 satisfying $0 \leq r_1 \leq \delta \leq r_2$.

Proof. The proof is similar to that of Lemma A.8, so is omitted. \square

Proposition A.11. *Let u_0 be a continuous function. Then $\bar{u}(x, 0) = \underline{u}(x, 0) = u_0(x)$ for all $x \in \mathbb{R}^2$.*

Proof. Let $x \in \mathbb{R}^2$. For the initial position $y \in \mathbb{R}^2$, the terminal time $s > 0$ and the step size $\epsilon > 0$, we define $V^-(y, s, \epsilon)$ as the minimum total cost when Paul takes a x concentric strategy through the game. Similarly we define $V^+(y, s, \epsilon)$ as the supremum total cost when Carol takes reversed x concentric strategy through the game. It is clear by the property of the value functions that

$$V^-(y, s, \epsilon) \leq u^\epsilon(y, s) \leq V^+(y, s, \epsilon).$$

It is sufficient to show

$$\lim_{\substack{(y,s) \rightarrow (x,0) \\ \epsilon \searrow 0}} V^-(y, s, \epsilon) \geq u_0(x) \quad (\text{A.25})$$

and

$$\lim_{\substack{(y,s) \rightarrow (x,0) \\ \epsilon \searrow 0}} V^+(y, s, \epsilon) \leq u_0(x). \quad (\text{A.26})$$

We first analyze V^- . We denote by $V_{quit}^-(y, s, \epsilon)$ (resp. $V_{end}^-(y, s, \epsilon)$) the minimum total cost when Paul takes x concentric strategy through the game and Carol quits (resp. does not quit) the game on the way. Then we write

$$V^-(y, s, \epsilon) = \min\{V_{end}^-(y, s, \epsilon), V_{quit}^-(y, s, \epsilon)\}.$$

Furthermore we analyze V_{end}^- . We denote by $V_{run}^-(y, s, \epsilon)$ (resp. $V_{ter}^-(y, s, \epsilon)$) the minimum running cost (resp. terminal cost) in the same situation as $V_{end}^-(y, s, \epsilon)$. Obviously we have

$$V_{end}^-(y, s, \epsilon) \geq V_{run}^-(y, s, \epsilon) + V_{ter}^-(y, s, \epsilon).$$

Since Paul takes a x concentric strategy, he can stay in $B(x, 2\nu^{-1})$ by Lemma 4.2. So the running cost is at most $M := \sup_{z \in B(x, 2\nu^{-1})} |f(z)|$, and at least $-M$ per round. Hence we have

$$|V_{run}^-(y, s, \epsilon)| \leq \epsilon^2 NM = \epsilon^2 \lceil s\epsilon^{-2} \rceil M \leq \epsilon^2 (s\epsilon^{-2} + 1) M = (s + \epsilon^2)M. \quad (\text{A.27})$$

We denote by $Ter(y, s, \epsilon)$ a terminal point x_N in the situation of $V_{end}^-(y, s, \epsilon)$. Since u_0 is continuous, what we have to prove about the terminal cost is

$$\lim_{\substack{(y,s) \rightarrow (x,0) \\ \epsilon \searrow 0}} Ter(y, s, \epsilon) = x$$

for any choices of Carol. Let $\{(y_n, s_n, \epsilon_n)\} \subset \mathbb{R}^2 \times (0, \infty) \times (0, \infty)$ be any sequence satisfying

$$\epsilon_n \searrow 0, \quad y_n \rightarrow x, \quad s_n \rightarrow 0.$$

Let $\delta > 0$. Then we shall show that $|Ter(y_n, s_n, \epsilon_n) - x| < \delta$ for sufficiently large n . Indeed, from Lemma A.8, there exists $\tilde{\epsilon} > 0$ such that

$$\frac{\delta/3}{3\delta^{-1} - \nu + 1} \leq t_\epsilon(r, 2\delta/3) \quad (\text{A.28})$$

for all $r \in [0, \delta/3]$ and all $\epsilon \in (0, \tilde{\epsilon})$. We take n large enough so that

$$|y_n - x| < \delta/3, \quad |s_n| < \frac{\delta/3}{3\delta^{-1} - \nu + 1}, \quad \epsilon_n < \tilde{\epsilon}.$$

Hence, together with (A.27), we obtain

$$\lim_{\substack{(y,s) \rightarrow (x,0) \\ \epsilon \searrow 0}} V_{run}^-(y, s, \epsilon) + V_{ter}^-(y, s, \epsilon) = u_0(x). \quad (\text{A.29})$$

If Carol quits the game on the way, the game positions $\{x_n\}$ are in $B(x, |Ter(y, s, \epsilon) - x|)$. Thus we have

$$V_{quit}^-(y, s, \epsilon) \geq \inf\{\Psi_+(z) \mid z \in B(x, |Ter(y, s, \epsilon) - x|)\}$$

and hence

$$\begin{aligned} \lim_{\substack{(y,s) \rightarrow (x,0) \\ \epsilon \searrow 0}} V_{quit}^-(y, s, \epsilon) &\geq \lim_{\substack{(y,s) \rightarrow (x,0) \\ \epsilon \searrow 0}} \inf\{\Psi_+(z) \mid z \in B(x, |Ter(y, s, \epsilon) - x|)\} \\ &= \Psi_+(x) \geq u_0(x). \end{aligned}$$

Together with (A.29), we obtain (A.25).

We next estimate V^+ . We denote by $V_{quit}^+(y, s, \epsilon)$ (resp. $V_{end}^+(y, s, \epsilon)$) the supremum total cost when Carol takes a reversed x concentric strategy through the game and Paul quits (resp. does not quit) the game on the way. Then we write

$$V^+(y, s, \epsilon) = \max\{V_{end}^+(y, s, \epsilon), V_{quit}^+(y, s, \epsilon)\}.$$

We further denote by $V_{run}^+(y, s, \epsilon)$ (resp. $V_{ter}^+(y, s, \epsilon)$) the supremum running cost (resp. terminal cost) in the same situation as $V_{end}^+(y, s, \epsilon)$. Obviously we have

$$V_{end}^+(y, s, \epsilon) \leq V_{run}^+(y, s, \epsilon) + V_{ter}^+(y, s, \epsilon).$$

From Lemma A.10, Paul is forced to stay in a compact set for sufficiently small s . Thus as in (A.27), we have

$$|V_{run}^+(y, s, \epsilon)| \leq \epsilon^2 NM \leq (s + \epsilon^2)M.$$

The values V_{ter}^+ and V_{quit}^+ are also estimated in the same way as V_{ter}^- and V_{quit}^- respectively. The only difference is

$$\frac{\delta/3}{3\delta^{-1} + \nu + 1} \leq t_\epsilon(r, 2\delta/3)$$

instead of (A.28). Thus (A.26) is also obtained. \square

B Set theory

The following are supplementary propositions related to general topology and convex sets.

Lemma B.1. *Let $A \subset \mathbb{R}^d$ be an open set. Let $K \subset A$ be a compact set. Then, for sufficiently small $\delta > 0$,*

$$B_\delta(K) \subset A.$$

Proof. We can assume without loss of generality that A is bounded. We define $f(x) := \sup\{\delta > 0 \mid B_\delta(x) \subset A\}$ for $x \in A$ and check that it is a lower semicontinuous function. Let $\epsilon > 0$. For $x, y \in A$ satisfying $|x - y| < \epsilon$, it is clear that $B_{f(x)-\epsilon}(y) \in A$ and then $f(y) \geq f(x) - \epsilon$.

Since f is lower semicontinuous, it has a minimizer \hat{x} in K by the extreme value theorem. Letting $\delta = f(\hat{x})$, we obtain the conclusion. \square

Lemma B.2. *Let $A \subset \mathbb{R}^2$ be a connected open set. Then $Co(A) = \{x \in l_{a,b} \mid a, b \in A\}$.*

Proof. It is clear that $Co(A) \supset \{x \in l_{a,b} \mid a, b \in A\}$. By Carathéodory's theorem, we have

$$Co(A) = \left\{ \sum_{i=1}^3 \lambda_i x_i; x_i \in A, \lambda_i \in [0, 1], \sum_{i=1}^3 \lambda_i = 1 \right\}.$$

Fix any element $x \in Co(A)$. Then we can write $x = \sum_{i=1}^3 \lambda_i x_i$ for some $x_i \in A$ and $\lambda_i \in [0, 1]$. It suffices to consider the case x_1, x_2, x_3 are different and $\lambda_i \in (0, 1)$. We can assume $x = (0, 0)$, $x_1 = (0, 1)$, $x_2 \in \{(p, q) \in \mathbb{R}^2 \mid p < 0\}$, and $x_3 \in \{(p, q) \in \mathbb{R}^2 \mid p > 0\}$. Since A is a connected open set, it is also path-connected. Thus there is a continuous path $\Gamma \subset A$ that connects x_2 and x_3 . By the intermediate value theorem, the path Γ crosses y -axis. If Γ crosses $x_4 \in \{(0, q) \in \mathbb{R}^2 \mid q < 0\}$, then $x_1, x_4 \in A$ and $x \in l_{x_1, x_4}$. Otherwise let l be the line satisfying $x \in l$ and $l_{x_2, x_3} \parallel l$. The path Γ crosses points $x_4 \in l \cap \{(p, q) \in \mathbb{R}^2 \mid p < 0\}$ and $x_5 \in l \cap \{(p, q) \in \mathbb{R}^2 \mid p > 0\}$. Thus we have $x_4, x_5 \in A$ and $x \in l_{x_4, x_5}$. Therefore we conclude that $x \in l_{a,b}$ for some $a, b \in A$. \square

Proposition B.3. *If $A \subset \mathbb{R}^d$ is open, then $Co(A)$ is open.*

Proof. Fix $x \in Co(A)$. By Carathéodory's theorem, we have $x = \sum_{i=1}^{d+1} \lambda_i x_i$ for some $x_i \in A$ and $\lambda_i \in [0, 1]$ satisfying $\sum_{i=1}^{d+1} \lambda_i = 1$. Since A is open, we see that $\cup_{i=1}^{d+1} B_{r_0}(x_i) \subset A$ for some $r_0 > 0$. Therefore, for any unit vector $v \in S^1$, we have $x + rv \in Co(A)$ for $0 \leq r < r_0$ since $x + rv = \sum_{i=1}^{d+1} \lambda_i (x_i + rv)$. \square

Proposition B.4. *Let $O_- \subset \mathbb{R}^d$. If O_- satisfies (3.4), then $\overline{O_-}$ is strictly convex.*

Proof. Assume that $\overline{O_-}$ is not strictly convex, i.e., there exist $x, y \in \overline{O_-}$ such that $\lambda x + (1 - \lambda)y \in (O_-^{int})^c$ for some $\lambda \in (0, 1)$.

1) $\lambda x + (1 - \lambda)y =: z \in \partial O_-$ for some $\lambda \in (0, 1)$. By (3.4) we can take an open ball B that satisfies $z \in \partial B$ and $\overline{O_-} \subset \overline{B}$. Since $x \in \overline{B}$ and $z \in \partial B$, we have $y \in (\overline{B})^c$, which is a contradiction.

2) $\lambda x + (1 - \lambda)y \in (\overline{O_-})^c$ for any $\lambda \in (0, 1)$. Let $z = \frac{x+y}{2}$. Let $\delta > 0$ satisfy $B_\delta(z) \subset (\overline{O_-})^c$. Since $x \in \partial O_-$, there exists $w \in O_-$ such that $w \in B_{2\delta}(x)$. Since $\frac{w+y}{2} \in (\overline{O_-})^c$, we see that $\lambda w + (1 - \lambda)y \in \partial O_-$ for some $\lambda \in (0, 1)$ and hence deduce a contradiction. \square

C Graph theory

We present the notion of graph and some related notions in the graph theory.

Definition C.1. For a non empty set V and a set E of unordered pairs in V , the pair of the sets (V, E) is called a *graph*. A graph $H = (V', E')$ is called a *subgraph* of G if $V' \subset V$ and $E' \subset E$. A subgraph $H = (V', E') \subset G$ is called a *path* of G if V' is a finite set $\{x_0, x_1, \dots, x_n\}$ (duplication is permitted.) and $E' = \{\langle x_i, x_{i+1} \rangle \mid i = 0, 1, \dots, n-1\}$, where we denote unordered pairs by $\langle \cdot, \cdot \rangle$. A graph $G = (V, E)$ is *connected* if for any $v_1, v_2 \in V$, there is a path of G whose endpoints are v_1 and v_2 .

To precisely indicate the path of graph introduced in the proof of Theorem 3.2, we present the following proposition, though the assertion seems to be obvious.

Proposition C.2. Let $G = (V, E)$ be a connected graph. Let $\langle a, b \rangle, \langle c, d \rangle \in E$. Then there is a path $P = (V', E')$ such that $a, b, c, d \in V'$ and $\langle a, b \rangle, \langle c, d \rangle \in E'$.

Proof. If $a = c$, $(\{b, a, d\}, \{\langle b, a \rangle, \langle a, d \rangle\})$ is a required path. Hereafter we consider the case neither $a = c$, $b = c$, $a = d$ nor $b = d$. Let $P_0 = (V_0, E_0)$ be a path with endpoints a and c .

If $b, d \notin V_0$, define $V_2 := V_0 \cup \{b, d\}$ and $E_2 := E_0 \cup \{\langle b, a \rangle, \langle c, d \rangle\}$.

If $b \notin V_0$ and $d \in V_0$, define $V_1 := V_0 \cup \{b\}$ and $E_1 := E_0 \cup \{\langle b, a \rangle\}$. Writing

$$\begin{aligned} V_1 &= \{x_0, x_1, \dots, x_n\}, \\ E_1 &= \{\langle x_i, x_{i+1} \rangle \mid i = 0, 1, \dots, n-1\}, \end{aligned} \tag{C.1}$$

we see that $x_0 = b$, $x_1 = a$, $x_n = c$ and $x_j = d$ for some $j \in \{2, 3, \dots, n\}$. Then we further define $V_2 := \{x_0, x_1, \dots, x_j, x_n\}$ and $E_2 := \{\langle x_0, x_1 \rangle, \langle x_1, x_2 \rangle, \dots, \langle x_{j-1}, x_j \rangle, \langle x_j, x_n \rangle\}$.

We finally consider the case $b, d \in V_0$. When we follow the path P_0 from a to c , there are two cases: whether we find b earlier than d or not. In the former case, writing V_0 and E_0 as (C.1), we see $x_j = b$, $x_m = d$ for some $0 \leq j < m \leq n$. We then define $V_2 := \{x_0, x_j, x_{j+1}, \dots, x_m, x_n\}$ and $E_2 := \{\langle x_0, x_j \rangle, \langle x_j, x_{j+1} \rangle, \dots, \langle x_{m-1}, x_m \rangle, \langle x_m, x_n \rangle\}$. In the latter case, we see $x_j = d$, $x_m = b$ for some $0 \leq j < m \leq n$. We define $V_2 := \{x_l, x_0, x_1, \dots, x_j, x_n\}$ and $E_2 := \{\langle x_l, x_0 \rangle, \langle x_0, x_1 \rangle, \dots, \langle x_{j-1}, x_j \rangle, \langle x_j, x_n \rangle\}$.

In any case, $P_2 := (V_2, E_2)$ is a required path. \square

D Curve theory

To complement the proof of Theorem 3.2, we will mathematically describe the construction of a Jordan curve \hat{C} that is included in a given closed curve C and includes a given point $x \in C$. We begin with a general property of connected sets. In what follows we especially notice that two points in an open and connected subset of \mathbb{R}^d can be connected by a polygonal line.

Definition D.1 (polygonal line connected). A path is called a *polygonal line* if it consists of finite line segments. Let $A \subset \mathbb{R}^d$. The set A is called *polygonal line connected* if for any two points $x, y \in A$, there exists a polygonal line in A that connects x and y .

Proposition D.2. Let $A \subset \mathbb{R}^d$ be an open set. Then the following statements are equivalent.

1. A is connected.
2. A is path-connected.
3. A is polygonal line connected.

Proof. Without loss of generality, we can assume $A \neq \emptyset$ since otherwise all the statements are obviously true.

$3 \Rightarrow 2$.

This is clear because a polygonal line is a path.

$2 \Rightarrow 1$.

Fix $x \in A$. Since a path is a connected set, all elements $y \in A$ are in the connected component including x . Therefore A is connected.

$1 \Rightarrow 3$.

Fix $x \in A$. We define

$O := \{y \in A \mid \text{there exists a polygonal line in } A \text{ that connects } x \text{ and } y\}$. We first show that O is an open set. Let $y \in O$. Since $y \in A$, there is an open ball $B_\delta(y)$ such that $B_\delta(y) \subset A$. For any $z \in B_\delta(y)$, we can make a polygonal line in A that connects x and z , combining the line segment between y and z with a polygonal line between x and y . Therefore we have $B_\delta(y) \subset O$, which means O is an open set.

We show that $A \setminus O$ is also an open set. Let $y \in A \setminus O$. As before, there is an open ball $B_\delta(y)$ such that $B_\delta(y) \subset A$. If a point z in $B_\delta(y)$ is in O , we can make a polygonal line in A that connects x and y . This is a contradiction. Hence we have $B_\delta(y) \subset A \setminus O$.

Since A is connected, O must be \emptyset or A . Since $x \in O$, we have $O = A$ and conclude that A is polygonal line connected. \square

We state the condition on components of the closed curve C . In what follows we call a map $f|_A$ injective at $t \in A$ if $s \in A$ and $f(s) = f(t)$ imply $s = t$. Also we call a map $f|_A$ injective in $B(\subset A)$ if $s \in A$, $t \in B$ and $f(s) = f(t)$ imply $s = t$. We set a class \mathcal{C} of curves in \mathbb{R}^2 . We make the assumption on \mathcal{C} :

(A1) There exists a map $\mathcal{C} \ni C \mapsto \gamma_C \in C([0, 1]; \mathbb{R}^2)$ such that

1. $\gamma_C([0, 1]) = C$ and the set $\{t \in (0, 1) \mid \gamma_C \text{ is not injective at } t\}$ is at most finite.
2. For any $C, D \in \mathcal{C}$, $\{t \in (0, 1) \mid \gamma_C(t) \notin D\}$ is at most a finite union of open intervals.

We now state the assumption on the closed curve C :

(A2) For some $C_1, C_2, \dots, C_N \in \mathcal{C}$, $C = \cup_{i=1}^N C_i$, $\gamma_{C_i}(1) = \gamma_{C_{i+1}}(0)$ for $i \in \{1, 2, \dots, N-1\}$ and $\gamma_{C_N}(1) = \gamma_{C_1}(0)$.

Remark D.3. The set of line segments and arcs in \mathbb{R}^2 satisfies (A1). Hence the closed curve in the proof of Theorem 3.2 satisfies (A2).

Set $\gamma : [0, N] \rightarrow \mathbb{R}^2$ as

$$\gamma(t) := \gamma_{C_i}(t - [t]),$$

if $i-1 \leq t \leq i$. Here we denote by $[t]$ the maximal integer that is no more than t . For a point $x \in C$, there is no loss of generality to assume $\gamma(0) = x$. The reason is the following:

Proposition D.4. *Let \mathcal{C} satisfy (A1). Let $C' \in \mathcal{C}$. Then $\mathcal{C}' := \mathcal{C} \cup \{C'_1, C'_2\}$ also satisfies (A1), where we define*

$$C'_1 := \gamma_{C'}([0, a]) \text{ and } C'_2 := \gamma_{C'}([a, 1])$$

for $a \in (0, 1)$.

Proof. Let $\gamma_{C'_1}(t) = \gamma_{C'}(t/a)$ and $\gamma_{C'_2}(t) = \gamma_{C'}(a + (1-a)t)$. The proof is done by checking the assumption (A1) directly. \square

We assume that $\gamma|_{[0, N]}$ is injective in a neighborhood of 0. i.e.,

(A3) There exists $\delta > 0$ such that $\gamma|_{[0, N]}$ is injective in $[0, \delta)$.

Remark D.5. The closed curve $C \cup \hat{\Gamma}$ in the proof of Theorem 3.2 satisfies (A3) because $B_{3\delta}(\hat{\Gamma}) \subset L$ and $x \notin L$. We inductively define

$$\begin{aligned} t_1 &:= 0, \\ s_i &:= \sup\{\tau \mid \gamma|_{(t_i, N]} \text{ is injective in } (t_i, \tau)\}, \\ t_{i+1} &:= \sup\{\tau \mid \gamma(s_i) = \gamma(\tau)\} \end{aligned}$$

for $i = 1, 2, \dots$.

Proposition D.6. *For some $m \in \mathbb{N}$, $s_m = N$ or $t_m = N$.*

Proof. We first prove $t_j < s_j$ for all j . The assumption that $\gamma|_{[0, N]}$ is injective in a neighborhood of 0 implies $t_1 < s_1$. If $s_1 < N$, then fix $j \in \{2, 3, \dots\}$. Let $i = [t_j] + 1$. Set

$$A_i := \bigcap_{i+1 \leq k \leq N} \{t \in (i-1, i) \mid \gamma(t) \notin C_k\}$$

for $1 \leq i \leq N-1$ and $A_N := (N-1, N)$. We also set

$$B_i := \{t \in (i-1, i) \mid \gamma|_{(i-1, i)} \text{ is not injective at } t\}.$$

From the assumption (A1), A_i is a finite union of open intervals and B_i is at most finite. By the definition of t_j we see that if $i-1 < t_j < i$, then $t_j \in A_i$. Hence, if $i-1 < t_j < i$, we have $(t_j, t_j + \delta) \subset A_i \cap B_i^c$ for some $\delta > 0$. Also this assertion holds for $t_j = i-1$. To show it, we prove by contradiction that $\inf A_i = i-1$. We assume that $\inf A_i > i-1$. Then we have $\inf\{t \in (i-1, i) \mid \gamma(t) \notin C_k\} > i-1$ for $i+1 \leq k \leq N$. From the continuity of γ , we obtain $\gamma(t_j) \in C_k$, which is a contradiction with the definition of t_j .

Now it turns out that there exists $l \geq 0$ such that $i-1 \leq t_j < i$ implies $i \leq s_{j+l}$ or $i \leq t_{j+l+1}$. Indeed, if $s_j < i$, then $s_j \in \partial A_i \cup B_i$. If $s_j < i$ and $s_j \in \partial A_i$, then $i \leq t_{j+1}$. If $s_j < i$ and $s_j \in B_i$, then $t_{j+1} \in B_i$. Thus the proof is complete. \square

If $s_m = N$ or $t_{m+1} = N$, then let $T = \sum_{i=1}^m (s_i - t_i)$. Define $\hat{\gamma} : [0, T] \rightarrow \mathbb{R}^2$ as follows:

$$\hat{\gamma}(t) := \gamma(t)$$

if $t \leq s_1$ and

$$\hat{\gamma}(t) := \gamma\left(t + t_{k+1} - \sum_{i=1}^k (s_i - t_i)\right)$$

if $\sum_{i=1}^k (s_i - t_i) \leq t \leq \sum_{i=1}^{k+1} (s_i - t_i)$.

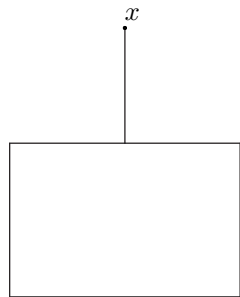

Figure 19: An example of C and x that we avoid

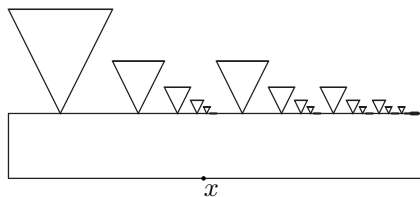

Figure 20: An example of C that includes an infinite number of loops

Proposition D.7. $\hat{C} := \hat{\gamma}([0, T])$ is a Jordan closed curve.

Proof. This assertion is obvious from the definitions of t_i and s_i . □

Remark D.8. By assuming (A3), we can avoid a closed curve C and a point x in it such as Figure 19. We also avoid a closed curve C that includes an infinite number of loops such as Figure 20 by the assumption (A2).

References

- [1] M. Bardi and I. Capuzzo-Dolcetta. *Optimal control and viscosity solutions of Hamilton-Jacobi-Bellman equations*. Birkhäuser Boston Inc., Boston, MA, 1997.
- [2] K. A. Brakke. *The motion of a surface by its mean curvature*. Princeton University Press, Princeton, N.J., 1978.
- [3] Y. G. Chen, Y. Giga, and S. I. Goto. Uniqueness and existence of viscosity solutions of generalized mean-curvature flow equations. *J. Differential Geom.*, 33(3):749–786, 1991.
- [4] L. Codenotti, M. Lewicka, and J. Manfredi. Discrete approximations to the double-obstacle problem and optimal stopping of tug-of-war games. *Trans. Amer. Math. Soc.*, 369:7387–7403, 2017.
- [5] L. C. Evans and J. Spruck. Motion of level sets by mean-curvature.1. *J. Differential Geom.*, 33:635–681, 1991.
- [6] M. Gage and R. S. Hamilton. The heat equation shrinking convex plane curves. *J. Differential Geom.*, 26:69–96, 1986.
- [7] Y. Giga. *Surface evolution equations. A level set approach*. Birkhäuser Verlag, Basel, 2006.
- [8] Y. Giga and Q. Liu. A billiard-based game interpretation of the neumann problem for the curve shortening equation. *Adv. Differential Equations*, 14(3-4), 2009.
- [9] Y. Giga, H. Mitake, and H. V. Tran. On asymptotic speed of solutions to level-set mean curvature flow equations with driving and source terms. *SIAM J. Math. Anal.*, 48:3515–3546, 2016.
- [10] Y. Giga, H. V. Tran, and L. Zhang. On obstacle problem for mean curvature flow with driving force. *Geometric flows*, 4:9–29, 2019.
- [11] M. A. Grayson. The heat equation shrinks embedded plane curves to round points. *J. Differential Geom.*, 26:285–314, 1987.
- [12] N. Hamamuki and Q. Liu. A deterministic game interpretation for fully nonlinear parabolic equations with dynamic boundary conditions. *ESAIM Control Optim. Calc. Var.*, 26-13, 2020.
- [13] K. Ishii, H. Kamata, and S. Koike. Remarks on viscosity solutions for mean curvature flow with obstacles. *Springer Proc. Math. Stat.*, 215:83–103, 2017.
- [14] R. Kohn and S. Serfaty. A deterministic-control-based approach to motion by curvature. *Commun. Pure Appl. Math.*, 59:344–407, 2006.
- [15] R. Kohn and S. Serfaty. A deterministic-control-based approach to fully nonlinear parabolic and elliptic equations. *Comm. Pure Appl. Math.*, 10:1298–1350, 2010.
- [16] Q. Liu. Fattening and comparison principle for level set equations of mean curvature type. *SIAM J. Control Optim.*, 49:2518–2541, 2011.
- [17] Q. Liu and N. Yamada. An obstacle problem arising in large exponent limit of power mean curvature flow equation. *Trans. Amer. Math. Soc.*, 372:2103–2141, 2019.

- [18] J. J. Manfredi, J. D. Rossi, and S. J. Somersille. An obstacle problem for tug-of-war games. *Commun. Pure Appl. Math.*, 14:217–228, 2015.
- [19] N. R. McDonald. The fundamental solutions of the curve shortening problem via the Schwarz function. *Complex Anal. Synerg.*, 8(1):Paper No. 5, 6, 2022.
- [20] G. Mercier. Mean curvature flow with obstacles: a viscosity approach. arXiv:1409.7657v3.
- [21] G. Mercier and M. Novaga. Mean curvature flow with obstacles: Existence, uniqueness and regularity of solutions. *Interfaces and Free Boundaries*, 17:399–426, 2015.
- [22] E. Spadaro. Mean-convex sets and minimal barriers. arXiv:1112.4288v1.
- [23] E. Spadaro. Mean-convex sets and minimal barriers. *Matematiche(Catania)*, 1:353–375, 2020.
- [24] K. Takasao. On obstacle problem for Brakke’s mean curvature flow. *SIAM J. Math. Anal.*, 53(6):6355–6369, 2021.