

Minions: Accelerating Large Language Model Inference with Adaptive and Collective Speculative Decoding

Siqi Wang
Beihang University

Hailong Yang*
Beihang University

Xuezhu Wang
Beihang University

Tongxuan Liu
University of Science and Technology of China

Pengbo Wang
Beihang University

Xuning Liang
Beihang University

Kejie Ma
Beihang University

Tianyu Feng
Beihang University

Xin You
Beihang University

Yongjun Bao
JD Company

Yi Liu
Beihang University

Zhongzhi Luan
Beihang University

Depei Qian
Beihang University

Abstract

Large language models (LLM) have recently attracted surging interest due to their outstanding capabilities across various domains. However, enabling efficient LLM inference is challenging due to its autoregressive decoding that generates tokens only one at a time. Although research works apply pruning or quantization to speed up LLM inference, they typically require fine-tuning the LLM, incurring significant time and economic costs. Meanwhile, speculative decoding has been proposed to use small speculative models (SSMs) to accelerate the inference of LLM. However, the low acceptance rate of SSM and the high verification cost of LLM prohibit further performance improvement of inference. In this paper, we propose *Minions*, an LLM inference system that accelerates LLM inference with a collective and adaptive speculative generation. Specifically, *Minions* proposes a majority-voted mechanism to leverage multiple SSMs to jointly speculate the outputs of LLM, which improves the inference performance without introducing prohibitive computation costs for LLM. To better trade off the number of tokens speculated from SSM and the verification cost of LLM, *Minions* proposes an adaptive mechanism to dynamically determine the optimal speculation length of SSM, which can achieve better inference performance across different models, datasets, and hyper-parameters. In addition, *Minions* decouples the SSM decoding and LLM verification efficiently and adopts a pipelined execution mechanism to further improve the inference performance of LLM. By comparing with the state-of-the-art LLM inference systems, we demonstrate that *Minions* can achieve higher inference throughput and lower inference time.

1 Introduction

Recently, Large Language Models (LLMs) such as GPT [1], Llama [44], and OPT [51] have achieved significant success in various domains within both industry and academia [2, 4,

29, 33, 37, 39, 47, 48]. The success of these LLMs relies on their core model architecture of transformer [45], which exhibits unexceptional natural language understanding capabilities. However, LLMs typically require extensive training with massive datasets, and their model parameter can easily scale beyond hundreds of billions (e.g., OPT-175B), demanding substantial computational power during the inference process. The surging computational demands also result in astonishing energy consumption for LLM inference, contributing to significant carbon emissions and economic expenses. For example, research firm SemiAnalysis indicated that OpenAI required 3,617 NVIDIA HGX A100 servers, with a total of 28,936 GPUs, to support the popular inference service of ChatGPT. This also implies a daily energy demand of 564 MWh [6], contributing a large amount of carbon footprint. For the latest OpenAI GPT-4 model, the inference cost for processing 1,000 tokens of input and output is reported to be \$0.03 and \$0.06, respectively [32]. The high cost from both environment and economics makes it formidable for many small and medium-sized enterprises to afford, hindering further innovation in the applications of LLMs. Therefore, to support the LLM inference efficiently is vital for the future success of LLMs.

In particular, the token generation of LLM inference is performed iteratively in an autoregressive manner, that decodes the next token based on the preceding token sequence in each iteration. Specifically, the inference process can be divided into two stages: prefill and decode. In the prefill stage, LLM takes the prompt (e.g., input sequence) as input and generates one token. In the decode stage, LLM uses the previously generated token as input to produce a new token, which is then appended to the end of the generated token sequence. The above process is performed iteratively, therefore for a single request to generate n outputs, LLM needs to execute n iterations sequentially, resulting in low parallelism and underutilization of computation resources during the inference.

Meanwhile, the concurrency of requests during the LLM inference is also quite limited, exacerbating the underutilization of computation resources and thus low inference throughput. The reason can be attributed to the attention mechanism

*Corresponding author

adopted by LLM that requires accessing keys and values for all previous tokens to compute the output of the newly generated token. To avoid redundant computation, a caching mechanism called KVCache is commonly adopted to store previous keys and values for subsequent reuse in future token generation. Despite the elimination of redundant computation, the adoption of KVCache in LLM inference also introduces downsides. On one hand, it needs to load large key and value matrices during each decoding iteration, which consumes memory bandwidth and thus constrains the inference performance due to limited memory bandwidth (a.k.a., memory-bounded). On the other hand, the GPU memory occupied by KVCache increases significantly during inference, preventing the LLM from adopting a large batch size and thus severely restricting the inference throughput.

To address the limitation of low inference throughput of LLMs, researchers have proposed various optimization techniques [11, 17, 35, 38]. For example, Medusa [35] has been proposed to accelerate the LLM inference by introducing additional decoding heads, enabling the parallel prediction of multiple subsequent tokens. However, such a method requires retraining the LLM, incurring prohibitive training costs. Other methods [11, 17, 38] observe that not all tasks require a full-sized LLM and propose to prune or quantize LLM. While these methods can reduce GPU memory usage of LLM, and thus improve inference throughput with increased batch size, the accuracy loss restricts their applicability in certain scenarios. In addition, these methods typically require fine-tuning the LLM to reach the desired accuracy, which is hardly affordable economically for the majority of researchers and practitioners.

Speculative decoding [3, 19, 25], as an emerging technique to accelerate LLM inference, harnesses a small speculative model (SSM) to expedite the inference process of LLM. Advantageously, it requires no modifications to the LLM itself and thus does not require additional retraining or fine-tuning of the LLM, rendering it more practical economically. Specifically, speculative decoding adopts SSM to generate the next s tokens for a given request (where s is a tunable hyperparameter, referred to as the *speculation length*) and utilizes the LLM for parallel verification of the generated tokens [25]. Since the SSM inference is an order of magnitude faster than the LLM, it can effectively improve the inference latency and throughput if more tokens generated from the SSM can be accepted by the LLM.

For speculative decoding, the acceptance rate (correctly verified token length/speculation length) is a critical factor impacting the performance of speculative decoding (e.g., a higher acceptance rate means higher inference throughput). Unfortunately, we notice that the acceptance rate of existing speculative decoding methods [3, 19, 25] remains low. For example, when evaluating the speculative decoding method proposed by [25], the average acceptance rate of SSMs is only 0.22 (Llama-7B with ChatGPT Prompts [28]). In addition,

these approaches execute LLM and SSM sequentially, which means the LLM has to wait for several steps of SSM inference before conducting a verification, and vice versa the SSM has to wait for the LLM verification before starting the next round of decoding. The tightly coupled execution of SSM and LLM results in significant idle time during the decoding and verification, hindering further improvement of LLM inference.

Based on our in-depth investigation of speculative decoding methods, to further accelerate LLM inference, there are several challenges that need to be addressed. Firstly, there is a substantial knowledge gap between SSM and LLM due to the large discrepancy of parameter scale (ranging from $100\times\sim 1000\times$), which leads to a low acceptance rate from SSM and thus constrains the speedup of LLM inference. **Challenge 1: How to enable SSM to better align with the inference results of LLM without offsetting its benefit of fast inference?** Additionally, the speculation length of SSM also significantly affects the performance of speculative decoding. A longer speculation length can result in a larger verification cost in each iteration and thus increase the LLM inference time. However, the optimal setting of speculation length varies depending on different models, datasets, and hyper-parameters (e.g., batch size). **Challenge 2: How to efficiently exploit the vast search space to determine the optimal setting of speculation length?** Finally, the existing methods tightly couple the execution of SSM and LLM, which introduces significant idle time during the interaction of SSM decoding and LLM verification. For example, the sequential execution of SSM decoding and LLM verification forces either SSM or LLM to stay idle when the other is working in progress. **Challenge 3: How to effectively decouple the execution of SSM and LLM in order to reduce the idle time during decoding and verification?**

To address the above challenges of speculative decoding with improved inference performance, we propose *Minions*, an LLM inference system that accelerates generative LLM inference with a collective and adaptive speculative generation. To speed up LLM inference without introducing additional computation cost, *Minions* adopts a majority-voted mechanism that leverages the collective wisdom of multiple SSMs to jointly speculate the outputs of LLM. The mechanism can effectively improve the acceptance rate of speculative tokens during LLM verification and thus the inference performance without introducing an overwhelming computation burden. Additionally, to better balance the number of tokens speculated from SSM and the verification overhead of LLM, *Minions* adopts an adaptive mechanism to dynamically adjust the SSM speculation length. The mechanism determines the optimal speculation length to ensure better inference performance across different configurations (e.g., model, dataset, hyper-parameters). Moreover, *Minions* adopts a pipelined execution mechanism that decouples the SSM decoding and LLM verification to effectively reduce the idle time during

the inference. The mechanism enables a larger batch size and better utilization of GPU resources, further boosting the inference performance of LLM. *Minions* is implemented based on the vLLM [18] and can support main-stream LLMs. We demonstrate the effectiveness of *Minions* by comparing it with cutting-edge LLM inference systems under representative LLMs and datasets.

Specifically, this paper makes the following contributions:

- We propose a majority-voted mechanism that leverages multiple SSMs to improve the acceptance rate of speculative tokens during LLM verification with a low computation cost for the inference.
- We propose an adaptive mechanism to determine the optimal speculation length of SSMs by efficiently exploiting the search space composed of different LLM configurations for better inference performance.
- We propose a pipelined execution mechanism that decouples the execution of SSM decoding and LLM verification to effectively reduce the idle time during the inference with improved throughput.
- Based on the above mechanisms, we implement *Minions*, an LLM inference system to accelerate the speculative generation of LLM inference. The experiment results demonstrate that the *Minions* can achieve shorter latency and higher throughput compared to existing systems.

The rest of this paper is organized as follows. Section 2 describes the background and motivation of this paper. Section 3 presents the details of our proposed method. Section 4 describes the implementation details. Section 5 provides the evaluation results compared to the state-of-the-art approaches. We discuss the related work in Section 6 and conclude this paper in Section 7.

2 Background and Motivation

In this section, we start by introducing speculative decoding as the background. We then present important observations based on quantitative experiments to illustrate new opportunities for accelerating speculative decoding. We use publicly released LLaMA-160M and OPT-125M as SSMs [25]. The remaining experimental setup can be referred to in Section 5.1.

2.1 Speculative Decoding

The fundamental idea of speculative decoding is to use a small speculative model (SSM) to predict several subsequent tokens in advance and then feed them into its counterpart, the large language model (LLM) to verify its speculations. If the speculations from SSM are consistent with LLM, the LLM accepts these speculative outputs. Since the actual token generations are carried out with the SSM that is an order of

magnitude faster than LLM, the more tokens from the SSM that are verified by the LLM, the more it accelerates the LLM inference.

Specifically, in each iteration, the SSM predicts s subsequent tokens (x_1, x_2, \dots, x_s) , and LLM calculates the logit $o_i(x)$ corresponding to each token in parallel. When the computation from both SSM and LLM is complete, the outputs from SSM are verified as follows. For each token, if the logit of SSM ($q_i(x)$) is less or equal to that of LLM ($o_i(x)$), the token will be accepted. Otherwise, the token will be rejected with probability $1 - \frac{o_i(x)}{q_i(x)}$ and sampled again from an adjusted distribution of $\text{norm}(\max(0, o_i(x) - q_i(x)))$. Once the rejection occurs, all tokens after this token will be discarded. Therefore, the efficacy of speculative decoding largely depends on the ability of SSM to accurately predict the outputs of LLM. Moreover, if every token generated by SSM is accepted, an extra token will be sampled using $o_{i+1}(x)$. The above process is repeated until the LLM finishes generating all tokens.

2.2 Model Capability Gap Between SSM and LLM

Figure 1 presents the average acceptance rates of speculative decoding for two pairs of LLM-SSM models under varying speculation lengths across different datasets. The model pair *OPT-13B-OPT-125M* exhibits a superior acceptance rate on *finance* and *dialogue* datasets, however performs slightly poor in the case of *chatbot* dataset. Whereas for the model pair *Llama2-70B-chat-Llama-160M*, the average acceptance rate is consistently low, especially on the *finance* dataset. The lower acceptance rate can be attributed to the large discrepancy in parameter scale between LLM and SSM, which leads to significant challenges in aligning their token distributions. Moreover, Figure 1 also shows the varying capability of SSM across different datasets. This is because the SSMs are fine-tuned on different datasets, which leads to varying performance in various LLM tasks. In sum, the difference in parameter scale and fine-tuning dataset leads to a notable capability gap between LLM and SSM that constrains the acceptance rate of SSM and thus the inference performance of speculative decoding.

To fill the capability gap, existing work [25] adopts several SSMs to generate multiple speculative outputs simultaneously, which are then verified by the LLM in parallel. However, concurrent verification of multiple SSM outputs can lead to a sharp increase in the computation overhead for LLM, which can quickly offset the performance advantage of SSM inference and ultimately degrade the inference performance of LLM. **Observation 1: To further improve the performance of speculative decoding, it is challenging to take advantage of the increased capability of multiple SSMs without burdening the LLM verification.**

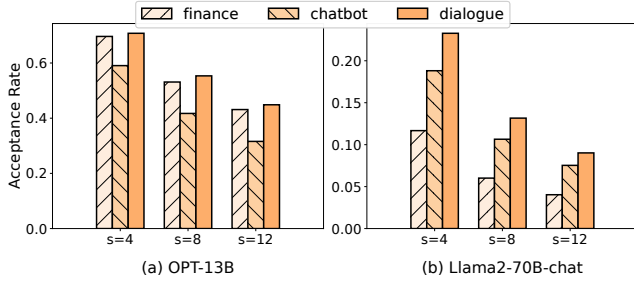

Figure 1: The acceptance rate of models with different speculation lengths and datasets.

2.3 Vast Search Space for Determining Optimal Speculation Length

Figure 2 presents the LLM inference time under different speculation lengths and model configurations (datasets, hyper-parameters). The asterisk in each figure annotated the optimal setting of speculation length for each model configuration. As shown in Figure 2, regardless of the dataset and hyper-parameters (e.g., batch size), the inference time of LLM exhibits a decreasing-then-increasing trend when increasing the speculation length of SSM. An optimal setting of speculation length exists that minimizes the LLM inference time. The reason is that a larger speculation length can reduce the number of LLM verifications, which effectively improves the performance of speculation decoding. However, when the speculation length reaches a turning point (asterisk in Figure 2), the computation cost of LLM verification rises significantly, which offsets the benefit of reduced LLM verifications.

Moreover, we notice there are several factors such as dataset and batch size that determine the optimal speculation length. For example, with a batch size of 16, the optimal speculation length of OPT-13B is 6 and 5 under *finance* and *dialogue* datasets, respectively. Similarly, under *dialogue* dataset, the optimal speculation length of Llama2-70B is 5 and 2 with batch size of 8 and 16, respectively. The above factors actually form a vast search space that is prohibitive to exploit exhaustively in order to determine the optimal speculation length. **Observation 2: An optimal speculation length exists for speculative decoding, however, it is challenging to exploit the search space efficiently to identify the optimal setting.**

2.4 Tightly-Coupled Speculative Execution Hinders Inference Performance

As shown in the upper part of Figure 3, the existing speculative decoding methods execute SSM and LLM sequentially. Specifically, SSM receives a batch of input tokens, performs speculative inference for several steps, and sends the speculative outputs to LLM for verification. After the LLM ver-

ification, SSM proceeds with speculative inference for the next batch, and the above process repeats until all tokens have been generated. Consequently, due to the sequential execution of SSM and LLM, there is a large portion of idle time for both SSM decoding and LLM verification, constraining the inference performance. However, as shown in the lower part of Figure 3, if the SSM and LLM execution can be decoupled efficiently, after completing one batch of speculation, the SSM can immediately proceed to the next batch. Similarly for LLM, after completing one batch of verification, it can proceed to the next batch. Ideally, the pipelined execution of SSM and LLM can overlap the execution cost of SSM, which can effectively reduce the inference time of LLM. Moreover, decoupling the SSM decoding and LLM verification enables more opportunities to consolidate the execution of SSM and LLM on underutilized computation resources of GPU, which helps to reduce the deployment cost of speculative decoding. **Observation 3: The tightly-coupled design of speculative decoding forces SSM and LLM to execute sequentially, whereas the decoupled design of SSM decoding and LLM verification reveals promising opportunities for improving inference performance and GPU resource utilization.**

3 Methodology

3.1 Design Overview

In this section, we propose *Minions*, an LLM inference system with collective and adaptive speculative generation. As shown in Figure 4, newly arrived requests are placed into the pending request pool to wait for execution. *Minions* proposes the *Minions Engine* to execute the requests with a pipelined execution mechanism. It utilizes an *intermediate resulting pool* to store outputs of SSM which decouples the SSM decoding and LLM verification. To ensure the efficiency of the pipeline, *Minions* leverages the *scheduler* to track the *intermediate resulting pool* for determining the timing of SSM execution. Simultaneously, the *scheduler* also dynamically determines the speculation length for SSM execution based on LLM runtime information through the *adaptive speculation length selector*. With speculation length and execution timing from the *scheduler*, *Minions Engine* speculates the results of requests with the SSM execution engine. Specifically, it leverages a *majority-voted speculator* to leverage the collective wisdom of multiple SSMs to determine the majority-approved SSM output. These majority-approved outputs are then placed into the *intermediate resulting pool* to wait for the LLM verification. *Minions Engine* leverages the LLM execution engine to conduct the verification. If the request remains incomplete after this verification round, it will be moved to the running request pool to wait for the next execution.

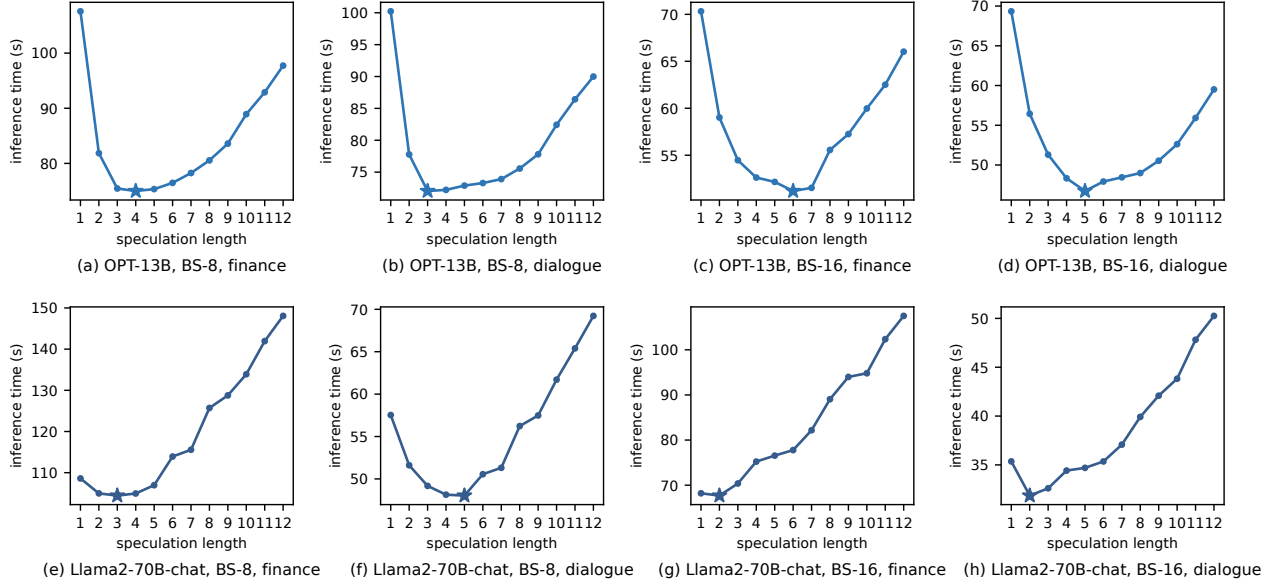

Figure 2: The inference time of the LLM under different speculation lengths, datasets, and batch size.

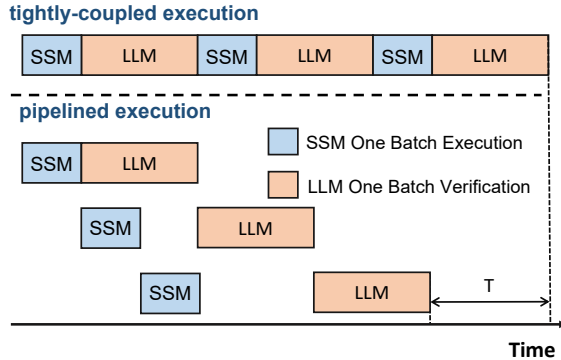

Figure 3: Performance potential revealed by pipelined execution. T represents the reduced inference time.

3.2 Majority-voted Speculator

To solve the challenge mentioned in Section 2.2, we propose the majority-voted speculator inspired by the weighted majority algorithm [21]. The key point is that each SSM can be regarded as an expert in several fields. To perform as the best expert in hindsight, we follow the majority of experts weighted by their accuracy in the past. Specifically, *Minions* updates the weights over time based on the correctness of outputs from the experts. To achieve this goal, we need to answer two crucial questions:

- **How to define the weighted majority of SSMs?** For each request, due to variations in the capabilities of SSMs, they may not necessarily produce identical outputs. *Minions* needs to define what results can represent

the majority of choices.

- **How to judge whether the SSM makes a mistake?** The output of SSM is challenging to match exactly with LLM. Therefore, *Minions* needs to define a metric to determine whether the output of the selected SSM is *correct* or *wrong*.

To tackle these issues, *Minions* leverages the following techniques, including *tree-based weighted majority decision* and *speculation quality metric*.

Tree-based Weighted Majority Decision. We leverage a tree structure to represent the output sequences of different SSMs and select the majority-approved output token by token. Specifically, for each request, we first merge the output sequences of SSMs into a tree. As shown in Figure 5, each node u_i in the tree represents a prompt token or generated token (e.g., one word corresponds to one token). The output sequence of each SSM corresponds to a branch (S_{u_i}) originating from the root node and terminating at a leaf node (u_i). For example, in Figure 5, S_{u_6} represents sequence (u_1, u_3, u_6) . For each SSM, we assign a weight value (w_i). We define the weight of each node (w_{u_i}) as the sum of SSMs' weights whose output sequence passes through that node. For example, in Figure 5, $w_{u_2} = w_1 + w_2$ as SSM₁ and SSM₂ both generate the token associated with 'like'.

We consider the path that is approved by SSMs with higher weights to be more likely the correct path. As a result, after obtaining a weighted tree, the node with the maximum weight is iteratively searched at each tree level starting from the root node to determine the nodes in the majority-approved output, i.e., $v_{i+1} = \arg \max_{u \in c(v_i)} (w_u)$, $S_{final} = S_{v_n}$, where $c(v_i)$ is the set of

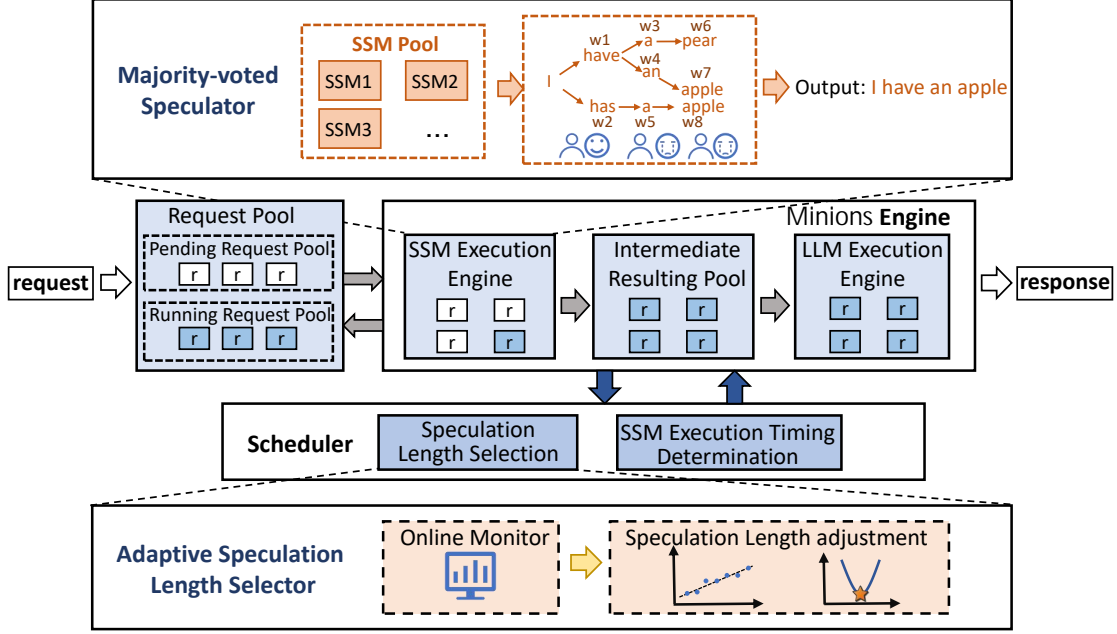

Figure 4: Design overview of *Minions*

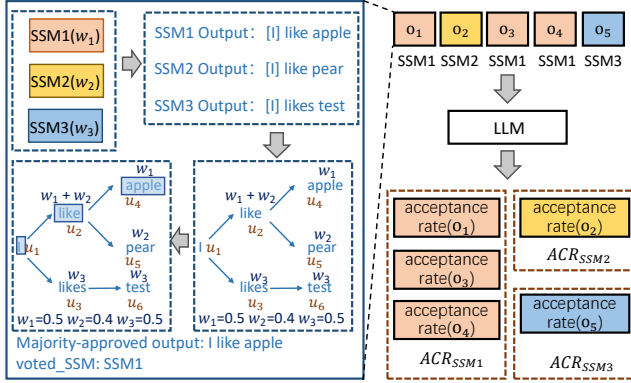

Figure 5: The primary workflow of Majority-voted Speculator.

children of v_i and v_n is a leaf node. For example, in Figure 5, for 'like' and 'likes', as $w_1 + w_2 > w_3$, 'like' is selected. And for 'apple' and 'pear', as $w_1 > w_2$, 'apple' is selected. Thus S_{u_4} is the majority-approved output. It is worth mentioning that the majority-approved output only represents the output of one SSM, and we regard this SSM as *voted_SSM*.

Speculation Quality Metric. The performance of speculative decoding heavily relies on the acceptance rate of LLM for SSM speculation results (i.e., correctly verified token length/speculation length). As a result, we leverage *SSM average acceptance rate (ACR)* as the speculation quality metric to assess the performance of *voted_SSMs* in the current scenario. Specifically, after validating majority-approved

outputs (o_i) with LLM, we record the acceptance rate for each output. We denote o_{SSM_i} as the set of o_i with SSM_i as their *voted_SSM*. For example, in Figure 5, $o_{SSM_1} = \{o_1, o_3, o_4\}$. And ACR_{SSM_i} is defined as the average acceptance rate of all majority-approved outputs in o_{SSM_i} , i.e., Equation 1.

$$ACR_{SSM_i} = \frac{\sum_{o \in o_{SSM_i}} \text{acceptance rate}(o)}{|o_{SSM_i}|} \quad (1)$$

In summary, our holistic process is as follows. Once SSMs finish executing a batch of requests, *Minions* will make a tree-based weighted majority decision for each request as discussed above. Meanwhile, *Minions* will also record the *voted_SSM* that corresponds to the majority-approved output. Then this output will wait to be fed into the LLM for verification. Once LLM finishes verifying a batch of outputs, *ACR* of SSMs will be calculated and will be used to update the weights of SSMs. Specifically, we set a *reward_threshold* and a *punish_threshold*, once the *ACR* of the SSM exceeds the *reward_threshold* or falls below the *punish_threshold*, we will provide rewards or punishments by multiplying the weight by the corresponding factor.

3.3 Adaptive Speculation Length Selector

To address the challenge of the vast search space for determining the optimal speculation length as discussed in Section 2.3, we first analyze the relationship between speculation length and the inference time of *Minions*. Table 1 provides the notations used in our modeling.

Table 1: Notations used for modeling the inference runtime of *Minions*.

T_{LLM}	Total inference time of the LLM
T_{SSM}	Total inference time of the SSM
N	Total number of tokens LLM needs to generate
b_{LLM}	The batch size of LLM
b_{SSM}	The batch size of SSM
s	Speculation length
$vl(s)$	Average number of SSM generated tokens that are verified as correct by LLM
$t_{LLM}(b_{LLM}, s)$	Per step inference time of LLM
$t_{SSM}(b_{SSM})$	Per step inference time of SSM

The total inference time of *Minions* is influenced by two parts: (1) the inference time of SSM (T_{SSM}), and (2) the inference time of LLM (T_{LLM}). The time for the SSM to execute one speculative step is related to SSM batch size (b_{SSM}), denoted as $t_{SSM}(b_{SSM})$ and, after performing speculation for a length of s steps, the results are handed over to the LLM for verification. The time required for the LLM to verify once depends on s and LLM batch size b_{LLM} , denoted as $t_{LLM}(b_{LLM}, s)$. The average number of tokens that are verified as correct by LLM depends on s , denoted as $vl(s)$. Assuming the total number of tokens LLM needs to generate is N , the overall verification rounds are given by $\frac{N}{vl(s)}$. Therefore, we can formulate the inference time of the LLM and SSM as Equation 2 and Equation 3, respectively.

$$T_{SSM} = \frac{N}{vl(s)} \times t_{SSM}(b_{SSM}) \times s \quad (2)$$

$$T_{LLM} = \frac{N}{vl(s)} \times t_{LLM}(b_{LLM}, s) \quad (3)$$

Given the large discrepancy of parameter scale between SSM and LLM, t_{SSM} is shorter than t_{LLM} , leading to a shorter T_{SSM} compared to T_{LLM} . As pipelined execution is employed for SSM and LLM in *Minions* (details will be shown in Section 3.4), the longer T_{LLM} dominates the total inference time. As a result, to optimize the inference efficiency of *Minions*, the key lies in selecting an appropriate s to minimize T_{LLM} . Since N is solely input-dependent and unrelated to s , we can further simplify the equation as:

$$\begin{aligned} s_{optimal} &= \arg \min_{s \in \mathbb{N}} \left(\frac{N}{vl(s)} \times t_{LLM}(b_{LLM}, s) \right) \\ &= \arg \min_{s \in \mathbb{N}} \left(\frac{t_{LLM}(b_{LLM}, s)}{vl(s)} \right) \end{aligned} \quad (4)$$

Based on this modeling analysis, we propose a heuristic search algorithm that dynamically adjusts the speculation length by monitoring runtime information on LLM verification. Specifically, during each verification of LLM, *Minions* employs an online monitor to record the LLM execution time (t_{LLM}) and the number of tokens that are verified as correct for

each request. The monitor then calculates the average verified length (vl) and records $\frac{t_{LLM}}{vl}$. After adjusting s from s_1 to s_2 , as illustrated in Figure 6, there are still requests with s set to s_1 in the *intermediate resulting pool* that have not been processed by LLM. Consequently, we cannot immediately assess the outcome of this adjustment through the runtime information from LLM.

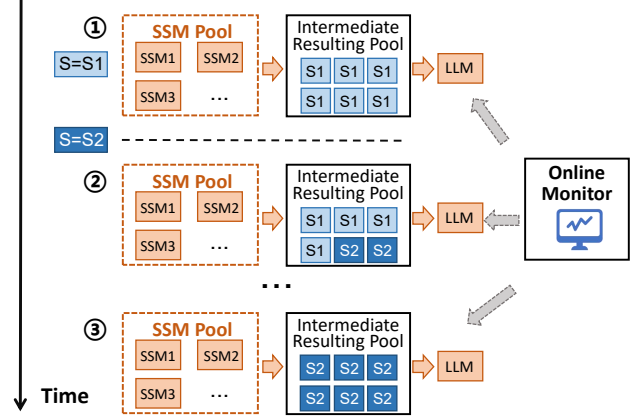

Figure 6: The evolution of requests within the system as s transitions from s_1 to s_2 .

To make informed decisions, it is crucial for the online monitor to acquire comprehensive runtime information of LLM, representing the transition of s from s_1 to s_2 (i.e., from ① to ③ in Figure 6). To achieve this, we set a *decision_threshold* to restrict the frequency of speculation length adjustments. The adjustment only commences when the online monitor has collected information greater than or equal to *decision_threshold*. Whenever an adjustment process takes place, we perform linear fitting on the monitored data. If the obtained slope is greater than 0, it indicates that, since the last change of s , LLM execution has exhibited an upward trend in $\frac{t_{LLM}}{vl}$. Based on our observations from Section 2.3, this indicates that the current choice of s is greater than the optimal s , suggesting that our last change was too aggressive. Therefore, we apply punishment on s by subtracting it from s_{punish} . If the slope is less than 0 which indicates a downward trend in $\frac{t_{LLM}}{vl}$. Similarly, our observation from Section 2.3, suggests that there is still room for further increase in s to further decrease the total inference time. Consequently, we continue to increase s by s_{reward} . Through adjustments of s based on runtime feedback, we approach the performance using the optimal s (details in Section 5.4).

3.4 Speculative Generation Pipeline

As depicted in Section 2.4, there is a large portion of idle time in tightly-coupled speculative decoding, opening up new opportunities for further improvement in speculation performance. To achieve cost-effective and efficient LLM inference,

Minions introduces an efficient pipeline mechanism. It concurrently executes SSMs and the LLM and effectively overlaps the additional runtime overhead introduced by the speculation of SSMs.

The key to enabling pipelined execution of SSMs and the LLM lies in decoupling their execution processes. To solve this issue, we introduce an *intermediate resulting pool*. After inferencing a batch, SSMs store speculation results in the *intermediate resulting pool*, and the LLM accesses the pool for verification. Hence, the execution of SSMs is not constrained by LLM. And as long as there are available requests in the *intermediate resulting pool*, LLM can sustain continuous execution.

To ensure efficient execution of the pipeline, a crucial consideration is the speed of SSM speculation. Avoiding bubbles in the LLM execution process is a key factor in achieving a high throughput pipeline mechanism. Fortunately, due to the large discrepancy in parameter scale between SSM and LLM, the execution speed of SSM is faster than that of LLM. This ensures that there are always pending requests in the *intermediate resulting pool* when LLM is ready to execute, preventing the occurrence of bubbles in the execution flow. Nevertheless, this efficiency comes at the cost of introducing another intricate challenge. As shown in Figure 7, the high inference speed of SSM results in LLM being unable to immediately verify the requests SSM generates. Consequently, over time, the *intermediate resulting pool* accumulates a significant number of pending requests. Once a request is processed, the key and value matrices will be calculated and reside in the GPU memory as KVCache. As the LLM inference progresses, the GPU memory is occupied by a large number of KVCache for requests, but only a small portion of these requests are actively being executed by LLM. On one hand, this leads to frequent triggering of swapping [13, 34] or recomputation [18] to ensure memory safety, which results in severe degradation of the inference efficiency of LLM. On the other hand, constrained by this inefficient memory management, the batch size for LLM inference is also limited, thereby impacting the throughput of LLM.

To alleviate this issue, we track the *intermediate resulting pool* to restrict the speculation speed of SSMs. Firstly, for LLM, as long as the *intermediate resulting pool* can accommodate requests equivalent to its batch size before each inference execution, there will be no bubbles in the pipeline process. Under this constraint, efforts are made to minimize the accumulation of requests in the pool. To achieve this goal, as soon as a round of SSM speculation finishes, we track the volume of the *intermediate resulting pool*. If the volume is greater than or equal to the batch size of LLM, SSMs pause their execution. However, once it is observed that the volume of the *intermediate resulting pool* falls below the batch size of LLM due to LLM execution, the SSM will execute immediately. Due to the higher speed of SSM compared to LLM in processing an equal number of requests, SSM can generate a

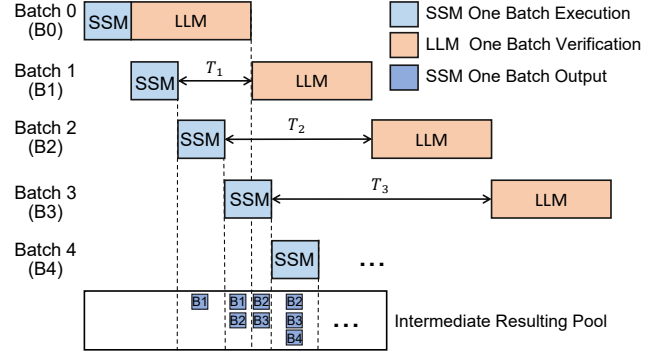

Figure 7: The workflow of the speculative generation pipeline and the status of the *intermediate resulting pool* in the absence of any control. T_i denotes the duration during which requests from Batch i are queued in the *intermediate resulting pool*.

sufficient quantity of requests before the completion of LLM verification, thereby satisfying the imposed constraint.

4 Implementation

We have implemented a system prototype of *Minions* in Python, and built it on top of vLLM [18]. The ideas behind *Minions* are general to be adapted to other LLM inference systems, and we leave such engineering efforts for future work.

The vLLM system is built with the assumption that in the decoding stage, there will be one newly generated token that ties to one KVCache block for each sequence. This assumption won't hold anymore for speculative decoding. To address this issue, we extend the paged attention of vLLM to support taking more than one token as input when KVCache has already existed. Furthermore, to remove the KVCache corresponding to tokens that failed verification in the LLM, we extend the BlockManager of vLLM. Specifically, during LLM execution, for the KVCache of each token, we record its logical block ID and offset. After execution, for tokens that failed verification, we delete their corresponding memory slots based on the previously recorded logical addresses.

In addition, to better align the SSMs with LLM, we fine-tune SSMs with distillation technique [12, 41]. Specifically, we prompt LLM with part of the instructions constructed from Empathetic Dialogues Datasets [36], Chatbot Instruction Prompts Datasets [14], and Finance Alpaca Datasets [15] respectively. We then filter out wrong answers and use the correct generated instruction data to fine-tune SSMs.

Moreover, to achieve concurrent inference for SSMs and LLM, we utilize NVIDIA MPS [30] which is a practical technique used by several spatial GPU sharing works [5, 43].

5 Evaluation

5.1 Experiment Setup

Hardware and Software Configurations - We run our evaluation on 4 NVIDIA 80-GB A100 GPUs connected over NVLink. The experiments are conducted on Ubuntu 20.04 with CUDA 11.8 and cuDNN v8.9.0. *Minions* is implemented on PyTorch v2.0.1, transformers v4.34.0, xformers v0.0.22 and pydantic 1.10.13.

Models and Datasets - Throughout the experiments, we evaluate our system using two representative LLM families: Llama [44] and OPT [51]. Specifically, we choose Llama2-70B-chat [24] and OPT-13B [23] as the LLMs and fine-tune Llama-160M [9] and OPT-125M [22] to generate SSMs. We evaluate *Minions* on three conversational datasets: Empathetic Dialogues Datasets [36] (*dialogue*), Chatbot Instruction Prompts Datasets [14] (*chatbot*), and Finance Alpaca Datasets [15] (*finance*). To simulate the real-world scenario, for *chatbot* and *finance*, we only use part of the prompt (instruction) field to form our input prompts. And for *dialogue*, we combine partial prompt and utterance field to create the input prompts.

Baseline Systems and Comparison Methods - We compare *Minions* with state-of-the-art LLM inference systems including *vLLM* [18], HuggingFace Text Generation Inference (*TGI*) [16], DeepSpeed-FastGen [27] (*FastGen*) and TensorRT-LLM [31] (*TRT-LLM*). All systems serve LLMs with fp16-formatted model parameters and intermediate activations. The difference is that OPT-13B is served with two GPUs utilizing tensor parallelism, while Llama2-70B-chat employs four GPUs with tensor parallelism to ensure memory safety.

We use prompts from the datasets described above. For each prompt, we let all systems generate a maximum of 128 new tokens. To measure the effectiveness of *Minions*, we use the normalized latency (the mean end-to-end latency of each request divided by its output length) and throughput as the major evaluation metric.

5.2 End-to-end Performance

Latency - Figure 8 presents the comparison of latency with each LLM inference system. In Figure 8(a)(b)(c), for Llama2-70B-chat with *finance*, *chatbot*, and *dialogue* dataset, *Minions* shows a maximum speedup of $3.11\times/2.91\times/2.84\times$, $3.81\times/4.06\times/3.98\times$, $7.06\times/4.48\times/5.62\times$, and $3.70\times/3.99\times/3.89\times$ compared to *TRT-LLM*, *vLLM*, *FastGen*, and *TGI*, respectively. The performance improvement comes from the following aspects. Firstly, *Minions* can leverage the collective wisdom of multiple SSMs to jointly speculate the outputs of LLM without introducing additional computational overhead for LLM. In addition, *Minions* also achieves a good balance

between the number of tokens speculated from SSM and the verification cost of LLM, which further boosts the performance. Lastly, with efficient pipelined speculative generation, LLM can continuously perform verification while ensuring that requests are not excessively backlogged in the *intermediate resulting pool*. Note that compared with *vLLM*, in *finance*, *chatbot*, and *dialogue* dataset, *Minions* achieves an average speedup of $3.10\times$, $2.86\times$, and $2.70\times$, which further demonstrates the strength of our work. Figure 8(d)(e)(f) presents similar results for OPT-13B. For *finance*, *chatbot*, and *dialogue* dataset, *Minions* shows a maximum speedup of $2.21\times/2.78\times/1.99\times$, $4.22\times/4.33\times/3.75\times$, $4.99\times/4.74\times/4.71\times$, and $5.70\times/5.88\times/5.18\times$ compared to *TRT-LLM*, *vLLM*, *FastGen*, and *TGI*, respectively. As for *TRT-LLM*, our performance is slightly inferior to it when using a batch size of 32 in certain datasets. The reason is that *TRT-LLM* is built on a high-performance inference framework, TensorRT, incorporating highly optimized operators and various additional compilation optimizations. The optimized implementations of models enable it to achieve higher performance than our base system *vLLM*, thereby surpassing ours in certain configurations. However, since the idea behind our work is orthogonal to the system, we believe that there will be additional performance improvement arising by adapting *Minions* to *TRT-LLM*.

Throughput - Figure 9 presents the comparison of throughput when inferencing two LLM models with different configurations. For Llama2-70B-chat with *finance*, *chatbot*, and *dialogue* dataset, *Minions* shows a maximum speed up of $3.00\times/2.71\times/2.71\times$, $3.71\times/3.95\times/3.88\times$, $6.84\times/4.39\times/5.25\times$, and $3.60\times/3.88\times/3.81\times$ compared to *TRT-LLM*, *vLLM*, *FastGen*, and *TGI*, respectively. This is because *Minions* leverages multiple SSMs to collectively assist the inference of LLM and adaptively adjust the speculation length to enhance the verification efficiency of LLM. Compared with *vLLM*, in *finance*, *chatbot*, and *dialogue* dataset, *Minions* achieves an average speedup of $3.02\times$, $2.76\times$, and $2.69\times$, which further demonstrates the performance enhancement achieved by our work. For OPT-13B, similar experimental results are presented. On the *finance*, *chatbot*, and *dialogue* dataset, *Minions* shows a maximum speed up of $2.17\times/2.64\times/2.03\times$, $4.18\times/4.17\times/3.83\times$, $5.01\times/4.66\times/4.78\times$, and $5.65\times/5.61\times/5.31\times$ compared to *TRT-LLM*, *vLLM*, *FastGen*, and *TGI*, respectively. For both models, the performance is slightly lower when compared to *TRT-LLM* on certain datasets with a batch size of 32. The reason is also attributed to the high performance of TensorRT, as discussed above.

5.3 Ablation Study

To better understand the contribution of adopted methods in *Minions*, we profile the throughput of *Minions* on *finance* dataset with a batch size of 16 and break down the perfor-

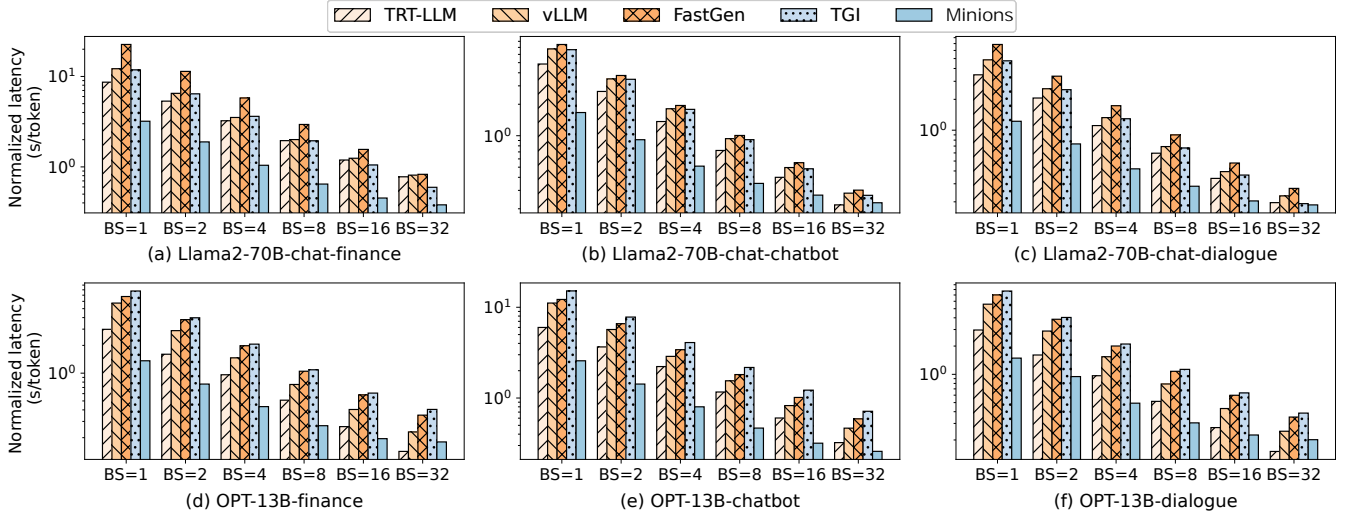

Figure 8: Normalized latency of different LLM inference systems.

mance results into three parts. We regard the implementation of traditional speculative decoding mentioned by previous work [3] as the baseline (*Default*) and choose the speculation length consistent with it (i.e. 4). We first employ diverse SSMs with a majority-voted speculator (*Majority*) on the basis of *Default*. As shown in Figure 10, for OPT-13B and Llama-70B-chat, *Majority* can bring an increment of 9.56% and 59.82% on throughput. This is mainly because *Majority* unifies the capabilities of multiple SSMs without incurring additional verification overhead. For OPT-13B, the increase is not as substantial as Llama2-70B-chat. The reason is that its employed SSMs exhibit comparable capabilities on the *finance* dataset, thus the combined advantage of their collaboration is weakened.

Based on *Majority*, we further demonstrate the effectiveness of adaptive speculation length selector (*Selector*). Specifically, it delivers extra throughput increments of 35.07% and 5.91% on OPT-13B and Llama2-70B-chat, respectively. The main reason is that *Selector* can dynamically adjust the speculation length to bring it closer to the optimum, greatly balancing the verified length and verification cost of LLM. For Llama2-70B-chat, the rise is not significant compared to OPT-13B. The reason is that the default speculation length is very close to the optimum. As a result, only a minimal optimization space remains for *Selector*.

Based on *Majority* and *Selector*, we further consider the effectiveness of the speculative generation pipeline (*Pipeline*). For OPT-13B and Llama-70B-chat, it additionally brings an increase of 34.27% and 55.37% on throughput. This is mainly because *Pipeline* decouples the execution of SSM decoding and LLM verification, effectively reducing the idle time during the inference with improved throughput.

5.4 Effectiveness of Design Choices

Effectiveness of Majority-voted Speculator - To demonstrate the effectiveness of our proposed majority-voted speculator, we evaluate *Minions* with the implementations using only one kind of SSM, respectively recorded as SSM1, SSM2, and SSM3. The batch size we use is 16. The detailed evaluation results are shown in Figure 11, where the bars indicate the throughput of each evaluated employment, and the circled dots are the acceptance rates. As shown in Figure 11, in all diverse model and dataset configurations, *Minions* is able to achieve throughput comparable to, or even higher than the optimal throughput in SSM1, SSM2, and SSM3. The reason is that through the majority-voted mechanism, *Minions* can leverage the collective wisdom of multiple SSMs under a dataset by adjusting weights based on runtime feedback. The results of the acceptance rate further demonstrate this point. As shown in Figure 11, for OPT-13B, *Minions* is able to achieve acceptance rates of 0.87, 0.89, and 0.78 on *finance*, *chatbot*, and *dialogue* respectively. For Llama-70B-chat, *Minions* is able to achieve acceptance rates of 0.54, 0.49, and 0.55 on *finance*, *chatbot*, and *dialogue* respectively.

Effectiveness of Adaptive Speculation Length Selector - To illustrate the effectiveness of our adaptive mechanism to dynamically adjust the speculation length (s) of SSMs, we compare *Minions* with the implementations with fixed s ranging from 2 to 12. The batch size we use is 16. Particularly, we leverage the red line to represent the highest throughput across all steps, regarding it as the optimality. As shown in Figure 12, in all diverse model and dataset configurations, *Minions* consistently achieve high throughput that closely approaches the optimality and outperforms others. The result demonstrates that through several rounds of adjustments, *Minions* is capable of correctly selecting the optimal speculation

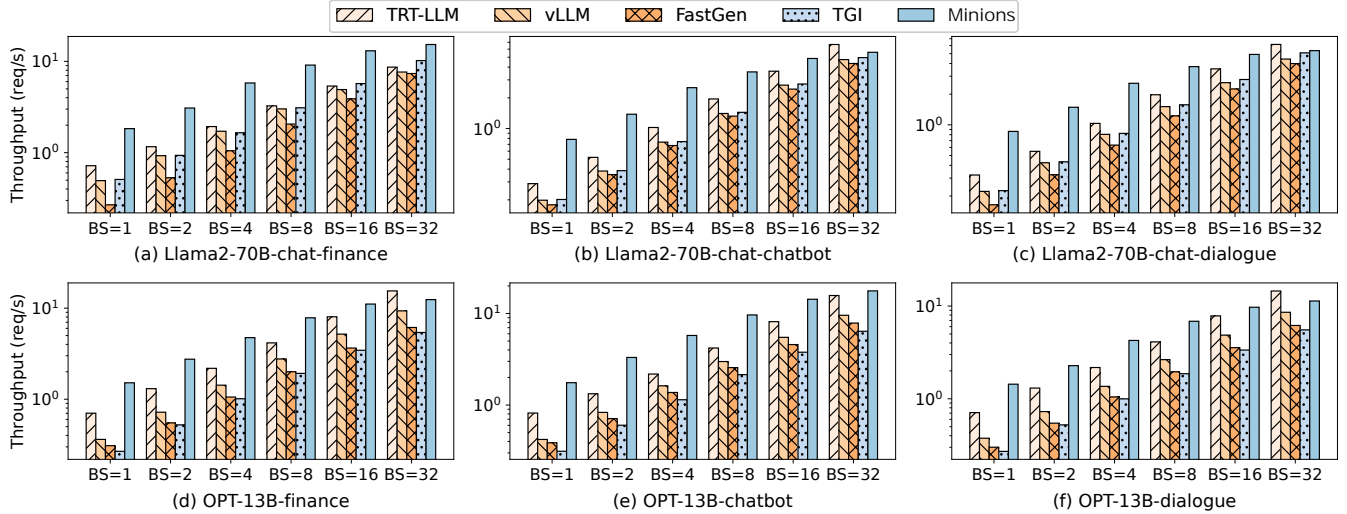

Figure 9: Throughput of different LLM inference systems.

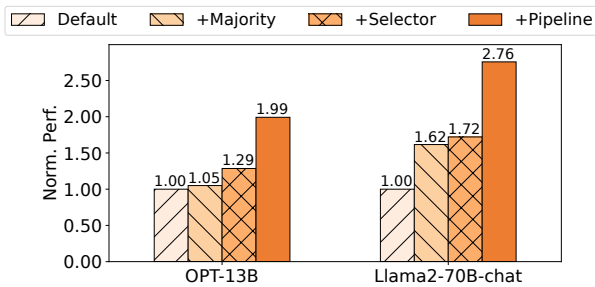

Figure 10: Throughput breakdown of *Minions*. The reported throughputs are normalized by *Default*.

length, and therefore greatly enhances inference throughput.

5.5 Comparison with Speculative Decoding

To demonstrate the efficiency of *Minions* compared to existing speculative decoding work, we conduct an experiment with *SpecInfer* [25]. The experiment setups are the same as Section 5.1 with a batch size of 32. As shown in Figure 13, for OPT-13B, *Minions* achieves a speedup of $7.61 \times \sim 14.49 \times$ on throughput and $6.34 \times \sim 8.89 \times$ on latency. The main reason is that *Minions* efficiently pipelines the execution of SSM and LLM and achieves a high acceptance rate across different datasets via a majority-voted speculator and adaptive speculation length selector. Moreover, the performance of *SpecInfer* is far below what is reported in the paper [25]. We suspect the poor performance can be attributed to the problematic operator implementations¹. We have also tried to compare with it on Llama2-70B-chat model. However, it fails to load the attention weights of the model.

¹<https://github.com/flexflow/FlexFlow/issues/1240>

5.6 Overhead Analysis

The overhead of *Minions* can be divided into three parts, including *monitored data fitting (MDF)*, *tree-based weighted majority decision (TMD)*, and *SSMs weights update (SWU)*. *MDF* performs linear fitting on monitored data. *TMD* constructs a tree based on the outputs of SSMs and selects the majority-approved output token by token. *SWU* calculates the acceptance rate for each request and rewards or punishes the weight of the corresponding SSM based on a preset threshold. As illustrated in Figure 14, the overhead incurred by *MDF*, *TMD* and *SWU* is at most 2.37% of the total inference time, which is negligible compared to the inference process.

6 Related Work

Recent work has proposed a series of optimization techniques, which can be categorized into two types: system optimizations and algorithm optimizations.

LLM system optimizations - With the emergence of LLM inference, there have been many efforts to build efficient LLM inference systems [16, 18, 27, 31, 40, 46, 50]. Orca [50] proposes iteration-level scheduling, which lowers the scheduling granularity from the request level to the iteration level. Drawing inspiration from virtual memory and paging techniques in operating systems, vLLM [18] introduces the PagedAttention to manage KVCache. TGI [16] introduces a new model serialization format safetensor to store the LLM weights. It is faster and more secure compared to other serialization formats. DeepSpeed-FastGen [27] presents a token composition strategy called Dynamic SplitFuse, which further improves continuous batching and system throughput. TensorRT-LLM [31] is built on the inference framework TensorRT and can perform compilation optimizations such as kernel fusion and kernel

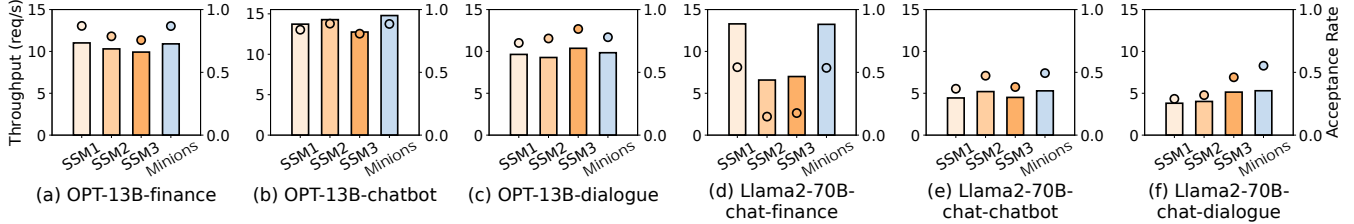

Figure 11: The throughput and acceptance rate of majority-voted speculator compared to the implementations using only one kind of SSM.

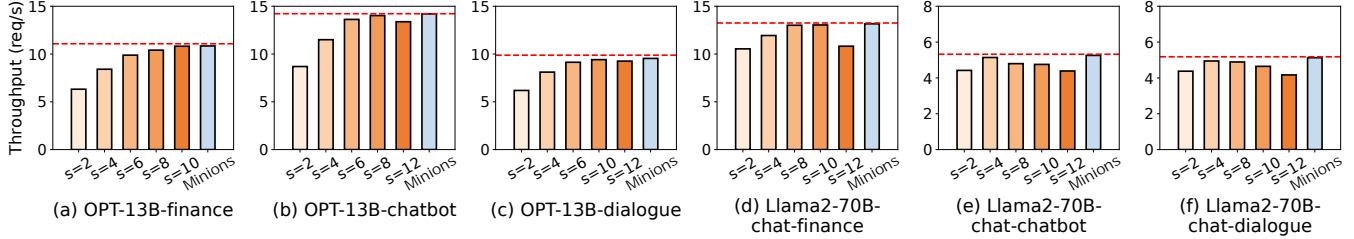

Figure 12: The throughput of adaptive speculation length selector compared to the implementations with fixed speculation length ranging from 2 to 12.

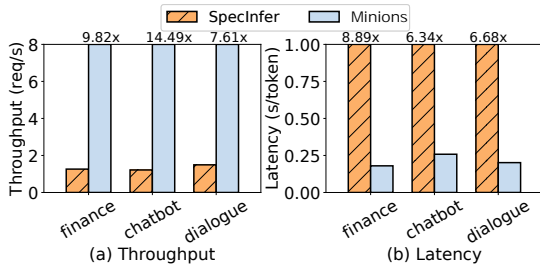

Figure 13: The performance comparison of *Minions* and *SpecInfer*.

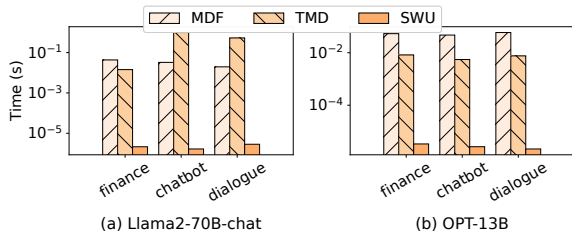

Figure 14: The overhead of *Minions* on two LLMs, including *MDF*, *TMD*, and *SWU*.

auto-tuning on computation graphs. The idea behind *Minions* is orthogonal to the above works and can be adapted to these systems.

LLM algorithm optimizations - Researchers have proposed various algorithmic innovations to accelerate LLM inference on GPUs [7, 8, 10, 11, 17, 20, 26, 38, 49]. Low-bit quantization [11, 17, 20] uses fewer bits to represent numerical values of LLM weights and activations. Pruning-based methods [8, 10, 26, 38] reduce the inference cost by setting some weights to zero. While these methods can accelerate model inference, they may also lead to accuracy losses. Other works attempt to improve the process of LLM autoregressive decoding. For instance, blockwise parallel decoding [42] and Medusa [35] add new layers on top of the original models to enable parallel inference of multiple tokens at once. However, they need to retrain the model with high economic costs. Compared with these approaches, *Minions* does not require modifying the structure of LLMs or finetuning them. Speculative decoding [3, 19] is another approach to accelerate LLM inference. SpecInfer [25] combines multiple boosted SSMs to predict the output of the LLM. Although it enhances the efficiency of LLM execution, it concurrently increases the workload of LLM verification, offsetting the performance improvement. In contrast to it, *Minions* leverages a majority-voted mechanism to achieve a well-alignment with LLM without introducing additional verification overhead.

7 Conclusion

In this paper, we propose *Minions*, an LLM inference system with collective and adaptive speculative generation. Specifically, *Minions* proposes a majority-voted mechanism that utilizes multiple SSMs to achieve a well-alignment with LLM. *Minions* also proposes an adaptive mechanism to dynamically adjust the SSM speculation length for better inference performance. Moreover, *Minions* decouple the deployment of LLM and SSM with efficient pipeline execution. The evaluation results demonstrate that *Minions* can achieve higher inference throughput and lower latency compared to existing systems.

References

- [1] Josh Achiam, Steven Adler, Sandhini Agarwal, Lama Ahmad, Ilge Akkaya, Florencia Leoni Aleman, Diogo Almeida, Janko Altenschmidt, Sam Altman, Shyamal Anadkat, et al. Gpt-4 technical report. *arXiv preprint arXiv:2303.08774*, 2023.
- [2] Daniel Adiwardana, Minh-Thang Luong, David R So, Jamie Hall, Noah Fiedel, Romal Thoppilan, Zi Yang, Apoorv Kulshreshtha, Gaurav Nemade, Yifeng Lu, et al. Towards a human-like open-domain chatbot. *arXiv preprint arXiv:2001.09977*, 2020.
- [3] Charlie Chen, Sebastian Borgeaud, Geoffrey Irving, Jean-Baptiste Lespiau, Laurent Sifre, and John Jumper. Accelerating large language model decoding with speculative sampling. *arXiv preprint arXiv:2302.01318*, 2023.
- [4] Mark Chen, Jerry Tworek, Heewoo Jun, Qiming Yuan, Henrique Ponde de Oliveira Pinto, Jared Kaplan, Harri Edwards, Yuri Burda, Nicholas Joseph, Greg Brockman, et al. Evaluating large language models trained on code. *arXiv preprint arXiv:2107.03374*, 2021.
- [5] Seungbeom Choi, Sunho Lee, Yeonjae Kim, Jongse Park, Youngjin Kwon, and Jaehyuk Huh. Serving heterogeneous machine learning models on multi-gpu servers with spatio-temporal sharing. In *2022 USENIX Annual Technical Conference (USENIX ATC 22)*, pages 199–216, 2022.
- [6] Alex de Vries. The growing energy footprint of artificial intelligence. *Joule*, 7(10):2191–2194, 2023.
- [7] Tim Dettmers, Artidoro Pagnoni, Ari Holtzman, and Luke Zettlemoyer. Qlora: Efficient finetuning of quantized llms. *arXiv preprint arXiv:2305.14314*, 2023.
- [8] Angela Fan, Edouard Grave, and Armand Joulin. Reducing transformer depth on demand with structured dropout. *arXiv preprint arXiv:1909.11556*, 2019.
- [9] FlexFlow. Llama-160m, <https://huggingface.co/jackfram/llama-160m>, 2023.
- [10] Elias Frantar and Dan Alistarh. Sparsegpt: Massive language models can be accurately pruned in one-shot. In *International Conference on Machine Learning*, pages 10323–10337. PMLR, 2023.
- [11] Elias Frantar, Saleh Ashkboos, Torsten Hoefer, and Dan Alistarh. Optq: Accurate quantization for generative pre-trained transformers. In *The Eleventh International Conference on Learning Representations*, 2022.
- [12] Cheng-Yu Hsieh, Chun-Liang Li, Chih-Kuan Yeh, Hootan Nakhost, Yasuhisa Fujii, Alexander Ratner, Ranjay Krishna, Chen-Yu Lee, and Tomas Pfister. Distilling step-by-step! outperforming larger language models with less training data and smaller model sizes. *arXiv preprint arXiv:2305.02301*, 2023.
- [13] Chien-Chin Huang, Gu Jin, and Jinyang Li. Swapadvisor: Pushing deep learning beyond the gpu memory limit via smart swapping. In *Proceedings of the Twenty-Fifth International Conference on Architectural Support for Programming Languages and Operating Systems*, pages 1341–1355, 2020.
- [14] HuggingFace. Chatbot, https://huggingface.co/datasets/alespalla/chatbot_instruction_prompts, 2023.
- [15] HuggingFace. Finance, <https://huggingface.co/datasets/gbharti/finance-alpaca>, 2023.
- [16] HuggingFace. Text generation inference, <https://github.com/huggingface/text-generation-inference>, 2023.
- [17] Benoit Jacob, Skirmantas Kligys, Bo Chen, Menglong Zhu, Matthew Tang, Andrew Howard, Hartwig Adam, and Dmitry Kalenichenko. Quantization and training of neural networks for efficient integer-arithmetic-only inference. In *Proceedings of the IEEE conference on computer vision and pattern recognition*, pages 2704–2713, 2018.
- [18] Woosuk Kwon, Zhuohan Li, Siyuan Zhuang, Ying Sheng, Lianmin Zheng, Cody Hao Yu, Joseph Gonzalez, Hao Zhang, and Ion Stoica. Efficient memory management for large language model serving with page-dattention. In *Proceedings of the 29th Symposium on Operating Systems Principles*, pages 611–626, 2023.
- [19] Yaniv Leviathan, Matan Kalman, and Yossi Matias. Fast inference from transformers via speculative decoding. In *International Conference on Machine Learning*, pages 19274–19286. PMLR, 2023.

- [20] Ji Lin, Jiaming Tang, Haotian Tang, Shang Yang, Xingyu Dang, and Song Han. Awq: Activation-aware weight quantization for llm compression and acceleration. *arXiv preprint arXiv:2306.00978*, 2023.
- [21] Nick Littlestone and Manfred K Warmuth. The weighted majority algorithm. *Information and computation*, 108(2):212–261, 1994.
- [22] Meta. Opt-125m, <https://huggingface.co/facebook/opt-125m>, 2022.
- [23] Meta. Opt-13b, <https://huggingface.co/facebook/opt-13b>, 2022.
- [24] Meta. Llama2-70b-chat, <https://huggingface.co/meta-llama/llama-2-70b-chat-hf>, 2023.
- [25] Xupeng Miao, Gabriele Oliaro, Zhihao Zhang, Xinhao Cheng, Zeyu Wang, Rae Ying Yee Wong, Alan Zhu, Lijie Yang, Xiaoxiang Shi, Chunan Shi, Zhuoming Chen, Daiyaan Arfeen, Reyna Abhyankar, and Zhihao Jia. Specinfer: Accelerating generative large language model serving with speculative inference and token tree verification, 2023.
- [26] Paul Michel, Omer Levy, and Graham Neubig. Are sixteen heads really better than one? *Advances in neural information processing systems*, 32, 2019.
- [27] Microsoft. Deepspeed fastgen, <https://github.com/microsoft/deepspeed/tree/master/blogs/deepspeed-fastgen>, 2023.
- [28] MohamedRashad. Chatgpt-prompts, <https://huggingface.co/datasets/mohamedrashad/chatgpt-prompts>, 2023.
- [29] Ramesh Nallapati, Bowen Zhou, Caglar Gulcehre, Bing Xiang, et al. Abstractive text summarization using sequence-to-sequence rnns and beyond. *arXiv preprint arXiv:1602.06023*, 2016.
- [30] NVIDIA. Nvidia: Sharing a gpu between mpi processes: multiple-process service, <https://docs.nvidia.com/deploy/mps/index.html>, 2012.
- [31] NVIDIA. Tensorrt-llm, <https://github.com/nvidia/tensorrt-llm>, 2023.
- [32] OpenAI. Openai pricing, <https://openai.com/pricing>, 2023.
- [33] Romain Paulus, Caiming Xiong, and Richard Socher. A deep reinforced model for abstractive summarization. *arXiv preprint arXiv:1705.04304*, 2017.
- [34] Xuan Peng, Xuanhua Shi, Hulin Dai, Hai Jin, Weiliang Ma, Qian Xiong, Fan Yang, and Xuehai Qian. Capuchin: Tensor-based gpu memory management for deep learning. In *Proceedings of the Twenty-Fifth International Conference on Architectural Support for Programming Languages and Operating Systems*, pages 891–905, 2020.
- [35] Princeton. Medusa, <https://sites.google.com/view/medusa-llm>, 2023.
- [36] Hannah Rashkin, Eric Michael Smith, Margaret Li, and Y-Lan Boureau. Towards empathetic open-domain conversation models: A new benchmark and dataset. In *Proceedings of the 57th Annual Meeting of the Association for Computational Linguistics*, pages 5370–5381, 2019.
- [37] Stephen Roller, Emily Dinan, Naman Goyal, Da Ju, Mary Williamson, Yinhan Liu, Jing Xu, Myle Ott, Kurt Shuster, Eric M Smith, et al. Recipes for building an open-domain chatbot. *arXiv preprint arXiv:2004.13637*, 2020.
- [38] Victor Sanh, Thomas Wolf, and Alexander Rush. Movement pruning: Adaptive sparsity by fine-tuning. *Advances in Neural Information Processing Systems*, 33:20378–20389, 2020.
- [39] Abigail See, Peter J Liu, and Christopher D Manning. Get to the point: Summarization with pointer-generator networks. *arXiv preprint arXiv:1704.04368*, 2017.
- [40] Ying Sheng, Lianmin Zheng, Binhang Yuan, Zhuohan Li, Max Ryabinin, Beidi Chen, Percy Liang, Christopher Ré, Ion Stoica, and Ce Zhang. Flexgen: High-throughput generative inference of large language models with a single gpu. In *International Conference on Machine Learning*, pages 31094–31116. PMLR, 2023.
- [41] Ryan Smith, Jason A Fries, Braden Hancock, and Stephen H Bach. Language models in the loop: Incorporating prompting into weak supervision. *arXiv preprint arXiv:2205.02318*, 2022.
- [42] Mitchell Stern, Noam Shazeer, and Jakob Uszkoreit. Blockwise parallel decoding for deep autoregressive models. *Advances in Neural Information Processing Systems*, 31, 2018.
- [43] Qingxiao Sun, Yi Liu, Hailong Yang, Ruizhe Zhang, Ming Dun, Mingzhen Li, Xiaoyan Liu, Wencong Xiao, Yong Li, Zhongzhi Luan, et al. Cognn: efficient scheduling for concurrent gnn training on gpus. In *SC22: International Conference for High Performance Computing, Networking, Storage and Analysis*, pages 1–15. IEEE, 2022.

- [44] Hugo Touvron, Louis Martin, Kevin Stone, Peter Albert, Amjad Almahairi, Yasmine Babaei, Nikolay Bashlykov, Soumya Batra, Prajjwal Bhargava, Shruti Bhosale, et al. Llama 2: Open foundation and fine-tuned chat models. *arXiv preprint arXiv:2307.09288*, 2023.
- [45] Ashish Vaswani, Noam Shazeer, Niki Parmar, Jakob Uszkoreit, Llion Jones, Aidan N Gomez, Łukasz Kaiser, and Illia Polosukhin. Attention is all you need. *Advances in neural information processing systems*, 30, 2017.
- [46] Xiaohui Wang, Ying Xiong, Yang Wei, Mingxuan Wang, and Lei Li. Lightseq: A high performance inference library for transformers. *arXiv preprint arXiv:2010.13887*, 2020.
- [47] Kelvin Xu, Jimmy Ba, Ryan Kiros, Kyunghyun Cho, Aaron Courville, Ruslan Salakhudinov, Rich Zemel, and Yoshua Bengio. Show, attend and tell: Neural image caption generation with visual attention. In *International conference on machine learning*, pages 2048–2057. PMLR, 2015.
- [48] Zhilin Yang, Ye Yuan, Yuexin Wu, William W Cohen, and Russ R Salakhutdinov. Review networks for caption generation. *Advances in neural information processing systems*, 29, 2016.
- [49] Zhewei Yao, Reza Yazdani Aminabadi, Minjia Zhang, Xiaoxia Wu, Conglong Li, and Yuxiong He. Zeroquant: Efficient and affordable post-training quantization for large-scale transformers. *Advances in Neural Information Processing Systems*, 35:27168–27183, 2022.
- [50] Gyeong-In Yu, Joo Seong Jeong, Geon-Woo Kim, Soojeong Kim, and Byung-Gon Chun. Orca: A distributed serving system for {Transformer-Based} generative models. In *16th USENIX Symposium on Operating Systems Design and Implementation (OSDI 22)*, pages 521–538, 2022.
- [51] Susan Zhang, Stephen Roller, Naman Goyal, Mikel Artetxe, Moya Chen, Shuohui Chen, Christopher Dewan, Mona Diab, Xian Li, Xi Victoria Lin, et al. Opt: Open pre-trained transformer language models. *arXiv preprint arXiv:2205.01068*, 2022.