

Efficient Enumeration of Large Maximal k -Plexes

Qihao Cheng^{*1}, Da Yan^{#1}, Tianhao Wu^{*1}, Lyuheng Yuan^{#4},
Ji Cheng^{†5}, Zhongyi Huang^{*6}, Yang Zhou^{‡7}

[#]The University of Alabama at Birmingham {yanda¹, lyuan⁴}@uab.edu

^{*}Tsinghua University {cqhq22¹, wuth20¹}@mails.tsinghua.edu.cn, zhongyih@tsinghua.edu.cn

[†]HKUST jchengac@connect.ust.hk

[‡]Auburn University yangzhou@auburn.edu

Abstract—Finding cohesive subgraphs in a large graph has many important applications, such as community detection and biological network analysis. Clique is often a too strict cohesive structure since communities or biological modules rarely form as cliques for various reasons such as data noise. Therefore, k -plex is introduced as a popular clique relaxation, which is a graph where every vertex is adjacent to all but at most k vertices. In this paper, we propose an efficient branch-and-bound algorithm as well as its task-based parallel version to enumerate all maximal k -plexes with at least q vertices. Our algorithm adopts an effective search space partitioning approach that provides a good time complexity, a new pivot vertex selection method that reduces candidate vertex size, an effective upper-bounding technique to prune useless branches, and three novel pruning techniques by vertex pairs. Our parallel algorithm uses a timeout mechanism to eliminate straggler tasks, and maximizes cache locality while ensuring load balancing. Extensive experiments show that compared with the state-of-the-art algorithms, our sequential and parallel algorithms enumerate large maximal k -plexes with up to $5\times$ and $18.9\times$ speedup, respectively. Ablation results also demonstrate that our pruning techniques bring up to $7\times$ speedup compared with our basic algorithm.

I. INTRODUCTION

Finding cohesive subgraphs in a large graph is useful in various applications, such as finding protein complexes or biologically relevant functional groups [4], [10], [17], [24], and social communities [16], [20] that can correspond to cybercriminals [27], botnets [23], [27] and spam/phishing email sources [22], [26]. One classic notion of cohesive subgraph is *clique* which requires every pair of distinct vertices to be connected by an edge. However, in real graphs, communities rarely appear in the form of cliques due to various reasons such as the existence of data noise [12], [13], [25].

As a relaxed clique model, k -plex was first introduced in [21], which is a graph where every vertex is adjacent to all but at most k vertices. However, mining k -plexes is NP-hard [5], [19], so existing algorithms rely on branch-and-bound search which runs in exponential time in the worst case. Many recent works have studied the branch-and-bound algorithms for mining maximal k -plexes [13], [14], [25], [33] and finding a maximum k -plex [11], [15], [18], [28], [32], with various techniques proposed to prune the search space. We will review these works in Section VII.

In this paper, we study the problem of enumerating all maximal k -plexes with at least q vertices, and propose a more efficient branch-and-bound algorithm with new search-space

pruning techniques and parallelization techniques to speed up computation. Our search algorithm treats each set-enumeration subtree as an independent task, so that different tasks can be processed in parallel. Our main contributions are as follows:

- We propose a method for search space partitioning to create independent searching tasks, and show that its time complexity is $O(nr_1^k r_2 \gamma_k^D)$, where n is the number of vertices, D is the graph degeneracy, Δ is the maximum degree, $r_1 = \min\left\{\frac{D\Delta}{q-2k+2}, n\right\}$, $r_2 = \min\left\{\frac{D\Delta^2}{q-2k+2}, nD\right\}$, and $\gamma_k < 2$ is a constant close to 2.
- We propose a new approach to selecting a pivot vertex to expand the current k -plex by maximizing the number of saturated vertices (i.e., those vertices whose degree is the minimum allowed to form a valid k -plex) in the k -plex. This approach effectively reduces the number of candidate vertices to expand the current k -plex.
- We design an effective upper bound on the maximum size of any k -plex that can be expanded from the current k -plex P , so that if this upper bound is less than the user-specified size threshold, then the entire search branch originated from P can be pruned.
- We propose three novel effective pruning techniques by vertex pairs, and they are integrated into our algorithm to further prune the search space.
- We propose a task-based parallel computing approach over our algorithm to achieve ideal speedup, integrated with a timeout mechanism to eliminate straggler tasks.
- We conduct comprehensive experiments to verify the effectiveness of our techniques, and to demonstrate our superior performance over existing solutions.

The rest of this paper is organized as follows. Section II defines our problem and presents some basic properties of k -plexes. Then, Section III describes the branch-and-bound framework of our mining algorithm, Section IV further describes the pruning techniques to speed up our algorithm, and Section V presents our task-based parallelization approach. Finally, Section VI reports our experiments, Section VII reviews the related work, and Section VIII concludes this paper.

II. PROBLEM DEFINITION

For ease of presentation, we first define some notations.

Notations. We consider an undirected and unweighted simple graph $G = (V, E)$, where V is the set of vertices, and E is the

set of edges. We let $n = |V|$ and $m = |E|$ be the number of vertices and the number of edges, respectively. The diameter of G , denoted by $\delta(G)$, is the shortest-path distance of the farthest pair of vertices in G , measured by the # of hops.

For each vertex $v \in V$, we use $N_G^c(v)$ to denote the set of vertices with distance exactly c to v in G . For example, $N_G^1(v)$ is v 's direct neighbors in G , which we may also write as $N_G(v)$; and $N_G^2(v)$ is the set of all vertices in G that are 2 hops away from v . The degree of a vertex v is denoted by $d_G(v) = |N_G(v)|$, and the maximum vertex degree in G is denoted by Δ . We also define the concept of *non-neighbor*: a vertex u is a non-neighbor of v in G if $(u, v) \notin E$. Accordingly, the set of non-neighbors of v is denoted by $\overline{N}_G(v) = V - N_G(v)$, and we denote its cardinality by $\overline{d}_G(v) = |\overline{N}_G(v)|$.

Given a vertex subset $S \subseteq V$, we denote by $G[S] = (S, E[S])$ the subgraph of G induced by S , where $E[S] = \{(u, v) \in E \mid u \in S \wedge v \in S\}$. We simplify the notation $N_{G[S]}(v)$ to $N_S(v)$, and define the other notations such as $\overline{N}_S(v)$, $d_S(v)$, $\overline{d}_S(v)$ and $\delta(S)$ in a similar manner.

The k -core of an undirected graph G is its largest induced subgraph with minimum degree k . The degeneracy of G , denoted by D , is the largest value of k for which a k -core exists in G . The degeneracy of a graph may be computed in linear time by a peeling algorithm that repeatedly removes the vertex with the minimum current degree at a time [6], which produces a degeneracy ordering of vertices denoted by $\eta = [v_1, v_2, \dots, v_n]$. In a real graph, we usually have $D \ll n$.

Problem Definition. We next define our mining problem. As a relaxed clique model, a k -plex is a subgraph $G[P]$ that allows every vertex u to miss at most k links to vertices of P (including u itself), i.e., $d_P(u) \geq |P| - k$ (or, $\overline{d}_P(u) \leq k$):

Definition 1 (k -Plex). Given an undirected graph $G = (V, E)$ and a positive integer k , a set of vertices $P \subseteq V$ is a k -plex iff for every $u \in P$, its degree in $G[P]$ is no less than $(|P| - k)$.

Note that k -plex satisfies the hereditary property:

Theorem 1. Given a k -plex $P \subseteq V$, Any subset $P' \subseteq P$ is also a k -plex.

This is because for any $u \in P'$, we have $u \in P$ and since P is a k -plex, $\overline{d}_P(u) = |\overline{N}_P(u)| \leq k$. Since $\overline{N}_{P'}(u) \subseteq \overline{N}_P(u)$, we have $\overline{d}_{P'}(u) = |\overline{N}_{P'}(u)| \leq k$, so P' is also a k -plex.

Another important property is that if a k -plex P has $|P| > 2k - c$, then $G[P]$ is connected with diameter $\delta(P) \leq c$ ($c \geq 2$) [28]. A common assumption by existing works [13], [14] is the special case when $c = 2$:

Theorem 2. Given a k -plex P , if $|P| \geq 2k - 1$, then $\delta(P) \leq 2$.

This is a reasonable assumption since natural communities that k -plexes aim to discover are connected, and we are usually interested in only large (hence statistically significant) k -plexes with size at least q . For $k \leq 5$, we only require $q \geq 2k - 1 = 9$. Note that a k -plex with $|P| = 2k - 2$ may be disconnected, such as one formed by two disjoint $(k - 1)$ -cliques.

A k -plex is said to be maximal if it is not a subgraph of any larger k -plex. We next formally define our problem:

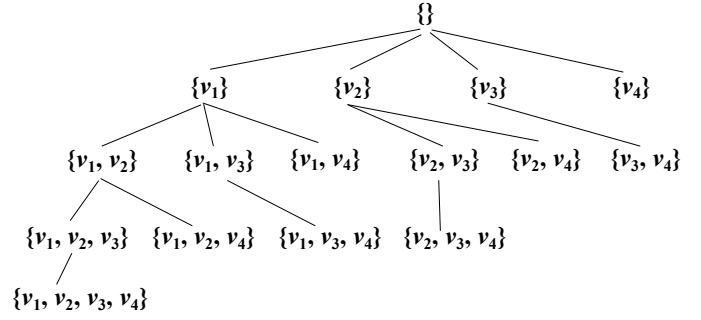

Fig. 1. Set-Enumeration Search Tree

Definition 2 (Size-Constrained Maximal k -Plex Enumeration). Given a graph $G = (V, E)$ and an integer size threshold $q \geq 2k - 1$, find all the maximal k -plexes with at least q vertices.

Note that instead of mining G directly, we can shrink G into its $(q - k)$ -core for mining, which can be constructed in $O(m + n)$ time using the peeling algorithm that keeps removing those vertices with degree less than $(q - k)$:

Theorem 3. Given a graph $G = (V, E)$, all the k -plexes with at least q vertices must be contained in the $(q - k)$ -core of G .

This is because for any vertex v in a k -plex P , $d_P(v) \geq |P| - k$, and since we require $|P| \geq q$, we have $d_P(v) \geq q - k$.

III. BRANCH-AND-BOUND ALGORITHM

This section describes the branch-and-bound framework of our mining algorithm. Section IV will further describe the pruning techniques that we use to speed up our algorithm.

Set-Enumeration Search. Figure 1 shows the set-enumeration tree T for a graph G with four vertices $V = \{v_1, v_2, v_3, v_4\}$ where we assume a vertex order $v_1 < v_2 < v_3 < v_4$. Each tree node represents a vertex set P , and only those vertices larger than the largest vertex in P are used to extend P . For example, in Figure 1, node $\{v_1, v_3\}$ can be extended with v_4 but not v_2 since $v_2 < v_3$; in fact, $\{v_1, v_2, v_3\}$ is obtained by extending $\{v_1, v_2\}$ with v_3 . Let us denote T_P as the subtree of T rooted at a node with set P . Then, T_P represents a search space for all possible k -plexes that contain all vertices in P . We represent the task of mining T_P as a pair $\langle P, C \rangle$, where P is the set of vertices assumed to be already included, and $C \subseteq (V - P)$ keeps those vertices that can extend P further into a valid k -plex. The task of mining T_P , i.e., $\langle P, C \rangle$, can be recursively decomposed into tasks that mine the subtrees rooted at the children of node P in T_P .

Algorithm 1 describes how this set-enumeration search process is generated, where we first ignore the red parts, and begin by calling *bron_kerbosch*($P = \emptyset, C = V$). Specifically, in each iteration of the for-loop in Lines 2–7, we consider the case where v_i is included into P (see P' in Lines 3 and 6). Here, Line 4 is due to the hereditary property: if $P' \cup \{u\}$ is not a k -plex, then any superset of $P' \cup \{u\}$ cannot be a k -plex, so $u \notin C'$. Also, Line 3 removes v_i from C so in later iterations, v_i is excluded from any subgraph grown from P .

Algorithm 1: $bron_kerbosch(P, C, X)$

```
1 if  $C = \emptyset$  and  $X = \emptyset$  do   Output  $P$ , return
2 foreach vertex  $v_i \in C$  do
3    $P' \leftarrow P \cup \{v_i\}$ ,  $C \leftarrow C - \{v_i\}$ 
4    $C' \leftarrow \{u \mid u \in C \wedge P' \cup \{u\} \text{ is a } k\text{-plex}\}$ 
5    $X' \leftarrow \{u \mid u \in X \wedge P' \cup \{u\} \text{ is a } k\text{-plex}\}$ 
6    $bron\_kerbosch(P', C', X')$ 
7    $X \leftarrow X \cup \{v_i\}$ 
```

Note that while the set-enumeration tree in Figure 1 ensures no redundancy, i.e., every subset of V will be visited at most once, it does not guarantee set maximality: even if $\{v_1, v_2, v_4\}$ is a k -plex, $\{v_2, v_4\}$ will still be visited but it is not maximal.

Bron-Kerbosch Algorithm. The Bron-Kerbosch algorithm as shown in Algorithm 1 avoids outputting non-maximal k -plexes with the help of an exclusive set X . The algorithm was originally proposed to mine maximal cliques [9], and has been recently adapted for mining maximal k -plexes [13], [33].

Specifically, after each iteration of the for-loop where considered the case with v_i included into P , Line 7 adds v_i to X in Line 7 so that in later iterations (where v_i is not considered for extending P), v_i will be used to check result maximality.

We can redefine the task of mining T_P as a triple $\langle P, C, X \rangle$ with three disjoint sets, where the exclusive set X keeps all those vertices that have been considered before (i.e., added by Line 7), and can extend P to obtain larger k -plexes (see Line 5, those k -plexes should have been found before).

When there is no more candidate to grow P (i.e., $C = \emptyset$ in Line 1), if $X \neq \emptyset$, then based on Line 5, $P \cup \{u\}$ is a k -plex for any $u \in X$, so P is not maximal. Otherwise, P is maximal (since such a u does not exist) and outputted. For example, let $P = \{v_2, v_4\}$ and $X = \{v_1\}$, then we cannot output P since $\{v_1, v_2, v_4\} \supseteq P$ is a k -plex, so P is not maximal.

Initial Tasks. Referring to Figure 1 again, the top-level tasks are given by $P = \{v_1\}$, $\{v_2\}$, $\{v_3\}$ and $\{v_4\}$, which are generated by $bron_kerbosch(P = \emptyset, C = V, X = \emptyset)$. It is common to choose the precomputed degeneracy ordering $\eta = [v_1, v_2, \dots, v_n]$ to conduct the for-loop in Line 2, which was found to generate more load-balanced tasks $T_{\{v_i\}}$ [13], [14], [25], [33]. Intuitively, each vertex v_i is connected to no more than D vertices among the later candidates $\{v_{i+1}, v_{i+2}, \dots, v_n\}$, and D is typically a small value in real-world graphs.

Note that we do not need to mine each $T_{\{v_i\}}$ over the entire G . Let us define $V_{<\eta}(v_i) = \{v_1, v_2, \dots, v_{i-1}\}$ and $V_{\geq\eta}(v_i) = \{v_i, v_{i+1}, v_{i+2}, \dots, v_n\}$, then we only need to mine $T_{\{v_i\}}$ over

$$G_i = G[V_{\geq\eta}(v_i) \cap (\{v_i\} \cup N_G(v_i) \cup N_G^2(v_i))], \quad (1)$$

since candidates in C must be after v_i in η , and must be within two hops from v_i according to Theorem 2. In fact, G_i is dense, and is efficient when represented by an adjacency matrix [11]. We call v_i as a seed vertex, and call G_i as a seed subgraph.

As a further optimization, we decompose $T_{\{v_i\}}$ into disjoint sub-tasks $T_{\{v_i\} \cup S}$ for subsets $S \subseteq N_{G_i}^2(v_i)$, where the vertices

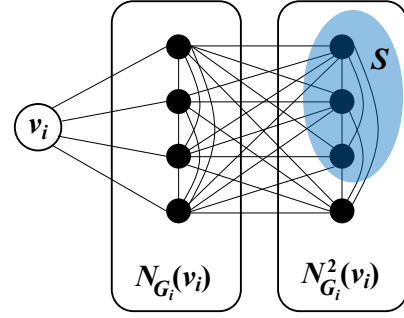

Fig. 2. Decomposition of Top-Level Task T_{v_i}

Algorithm 2: Enumerating k -Plex with Initial Tasks

```
Input: Graph  $G = (V, E)$ ,  $k$ ,  $q \geq 2k - 1$ 
1  $G \leftarrow$  the  $(q - k)$ -core of  $G$  // Using Theorem 3
2  $\eta = \{v_1, \dots, v_n\}$  is the degeneracy ordering of  $V$ 
3 for  $i = 1, 2, \dots, n - q + 1$  do
4    $V_i \leftarrow \{v_i, v_{i+1}, \dots, v_n\} \cap (\{v_i\} \cup N_G(v_i) \cup N_G^2(v_i))$ 
5    $V'_i \leftarrow \{v_1, v_2, \dots, v_{i-1}\} \cap (N_G(v_i) \cup N_G^2(v_i))$ 
6    $G_i \leftarrow G[V_i]$ , and apply further pruning over  $G_i$ 
7   foreach  $S \subseteq N_{G_i}^2(v_i)$  that  $|S| \leq k - 1$  do
8      $P_S \leftarrow \{v_i\} \cup S$ ,  $C_S \leftarrow N_{G_i}(v_i)$ 
9      $X_S \leftarrow V'_i \cup (N_{G_i}^2(v_i) - S)$ 
10    Call Branch( $G_i, k, q, P_S, C_S, X_S$ )
```

of S are the only vertices in $N_{G_i}^2(v_i)$ allowed to appear in a k -plex found in $T_{\{v_i\} \cup S}$, and other candidates have to come from $N_{G_i}(v_i)$. This is illustrated in Figure 2. We only need to consider $|S| < k$ since otherwise, v_i has at least k non-neighbors $S \subseteq N_{G_i}^2(v_i)$, plus v_i itself, v_i misses $(k+1)$ edges which violates the k -plex definition, so $\{v_i\} \cup S$ cannot be a k -plex, neither can its superset due to the hereditary property.

In summary, each search tree $T_{\{v_i\}}$ creates a *task group* sharing the same graph G_i , where each task mines the search tree $T_{\{v_i\} \cup S}$ for a subset $S \subseteq N_{G_i}^2(v_i)$ with $|S| < k$.

Algorithm 2 shows the pseudocode for creating initial task groups, where in Line 1 we shrink G into its $(q - k)$ -core by Theorem 3, so n is reduced. We then generate initial task groups $T_{\{v_i\}}$ in Line 3, where we skip $i > n - q + 1$ since $|V_i| < q$ in this case; here, V_i is the vertex set of G_i (see Lines 4 and 6). For each task $T_{\{v_i\} \cup S} = \langle P, C, X \rangle$ of the task group $T_{\{v_i\}}$, we have $P = \{v_i\} \cup S$ and $C \subseteq N_{G_i}(v_i) \triangleq C_S$ (Line 8). Let us define $N_{<\eta}^{1,2}(v_i) = V_{<\eta}(v_i) \cap (N_G(v_i) \cup N_G^2(v_i))$ (i.e., V'_i in Line 5), then we also have $X \subseteq N_{<\eta}^{1,2}(v_i) \cup (N_{G_i}^2(v_i) - S) \triangleq X_S$ (Line 9). This is because vertices of $(N_{G_i}^2(v_i) - S)$ may be considered by other sub-tasks $T_{\{v_i\} \cup S'}$, and vertices of $N_{<\eta}^{1,2}(v_i)$ may be considered by other task groups $T_{\{v_j\}}$ ($j < i$) (if v_j is more than 2 hops away from v_i , it cannot form a k -plex with v_i , so v_j is excluded from X_S). Line 7 of Algorithm 2 is implemented by the set-enumeration search of S over $N_{G_i}^2(v_i)$, similar to Algorithm 1 Lines 2, 3 and 6.

Finally, to maintain the invariant of Bron-Kerbosch algo-

Algorithm 3: Branch-and-Bound Search

```
1 function Branch( $G, k, q, P, C, X$ )
2    $C \leftarrow \{v \in C \wedge P \cup \{v\} \text{ is a } k\text{-plex}\}$ 
3    $X \leftarrow \{v \in X \wedge P \cup \{v\} \text{ is a } k\text{-plex}\}$ 
4   if  $C = \emptyset$  then
5     if  $X = \emptyset$  and  $|P| \geq q$  then   Output  $P$ 
6     return
7    $M_0 \leftarrow$  the subset of  $P \cup C$  with minimum degree
   in  $G[P \cup C]$ 
8    $M \leftarrow$  the subset of  $M_0$  with maximum  $\overline{d}_P(v)$ 
9   if  $M \cap P \neq \emptyset$  then   Pick a pivot  $v_p \in M \cap P$ 
10  else   Pick a pivot  $v_p \in M \cap C$ 
11  if  $d_{P \cup C}(v_p) \geq |P| + |C| - k$  then
12    if  $P \cup C$  is a maximal  $k$ -plex then
13      if  $|P \cup C| \geq q$  then   Output  $P \cup C$ 
14    return
15  if  $v_p \in P$  then
16    Re-pick a pivot  $v_{new}$  from  $\overline{N}_C(v_p)$  using the
    same rules as in Lines 7–10;    $v_p \leftarrow v_{new}$ 
17  Compute the upper bound  $ub$  of the size of any
    $k$ -plex that can be expanded from  $P \cup \{v_p\}$ 
18  if  $ub \geq q$  then
19     $\text{Branch}(G, k, q, P \cup \{v_p\}, C - \{v_p\}, X)$ 
20   $\text{Branch}(G, k, q, P, C - \{v_p\}, X \cup \{v_p\})$ 
```

rithm (c.f., Lines 4–5 of Algorithm 1), we set $C \leftarrow \{u \mid u \in C_S \wedge P \cup \{u\} \text{ is a } k\text{-plex}\}$ and $X \leftarrow \{u \mid u \in X_S \wedge P \cup \{u\} \text{ is a } k\text{-plex}\}$, and mine $T_{\{v_i\}US} = \langle P, C, X \rangle$ recursively using the Bron-Kerbosch algorithm of Algorithm 1 over G_i . Instead of directly running Algorithm 1, we actually run a variant to be described in Algorithm 3 which applies more pruning techniques, and refines C_S and X_S into C and X , respectively, at the very beginning. This branch-and-bound sub-procedure is called in Line 10 of Algorithm 2.

Branch-and-Bound Search. Algorithm 3 first updates C and X to ensure that each vertex in C or X can form a k -plex with P (Lines 2–3). If $C = \emptyset$ (Line 2), there is no more candidate to expand P with, so Line 6 returns. Moreover, if $X = \emptyset$ (i.e., P is maximal) and $|P| \geq q$, we output P (Line 5).

Otherwise, we pick a pivot vertex v_p (Lines 7–10 and 15–17) and compute an upper bound ub of the maximum size of any k -plex that $P \cup \{v_p\}$ may expand to (Line 17). The branch expanding $P \cup \{v_p\}$ is filtered if $ub < q$ (Lines 18–19), while the branch excluding v_p is always executed in Lines 20. We will explain how ub is computed later.

Pivot Selection. We next explain our pivot selection strategy. Specifically, Lines 7–10 select $v_p \in P \cup C$ to be a vertex with the minimum degree in $G[P \cup C]$, so that in Line 11, if $d_{P \cup C}(v_p) \geq |P| + |C| - k$, then for any other $v \in P \cup C$, we have $d_{P \cup C}(v) \geq d_{P \cup C}(v_p) \geq |P| + |C| - k$, and hence $P \cup C$ (i.e., including all candidates) is a k -plex that we examine for maximality. In this case, we do not need to expand further so Line 14 returns. In Line 12, we check if $P \cup C$ is maximal by

checking if $\{v \in X \wedge P \cup C \cup \{v\} \text{ is a } k\text{-plex}\}$ is empty.

Note that among those vertices with the minimum degree in $G[P \cup C]$, we choose v_p with the maximum $\overline{d}_P(v)$ (Line 8) which tends to prune more candidates in C . Specifically, if $\overline{d}_P(v_p) = k$ and v_p is in (or added to) P , then v_p 's non-neighbors in C are pruned; such a vertex v_p is called *saturated*.

Note that if more saturated vertices are included in P , then more vertices in C tend to be pruned. We, therefore, pick a pivot to maximize the number of saturated vertices in P . Specifically, we try to find the closest-to-saturation pivot v_p in P (Line 9), and then find a non-neighbor of v_p in C that is closer to saturation (Lines 16) as the new pivot $v_{new} \in C$, which is then used to expand P (Line 19). While if the closest-to-saturation pivot v_p cannot be found in P , we then pick v_p in C (Line 10), which is then used to expand P (Line 19).

IV. PRUNING AND UPPER BOUNDING TECHNIQUES

This section introduces our additional pruning and upper bounding techniques used in Algorithms 2 and 3 that are critical in speeding up the enumeration process.

Seed Subgraph Pruning. The theorem below gives the second-order property of two vertices in a k -plex with size constraint:

Theorem 4. *Let P be a k -plex with $|P| \geq q$. Then, for any two vertices $u, v \in P$, we have (i) if $(u, v) \notin E$, $|N_P(u) \cap N_P(v)| \geq q - 2k + 2$, (ii) otherwise, $|N_P(u) \cap N_P(v)| \geq q - 2k$.*

Proof. See our online Appendix A [2]. \square

Note that by setting $q = 2k - 1$, Case (i) gives $|N_P(u) \cap N_P(v)| \geq (2k - 1) - 2k + 2 = 1$, i.e., for any two vertices $u, v \in P$ that are not mutual neighbors, they must share a neighbor and is thus within 2 hops, which proves Theorem 2.

This also gives the following corollary to help further prune the size of a seed subgraph G_i in Line 6 of Algorithm 2.

Corollary 1. *Consider an undirected graph $G = (V, E)$ and an ordering of V : $\{v_1, v_2, \dots, v_n\}$. Let v_i be the seed vertex and G_i be the seed subgraph. Then, any vertex $u \in V_i$ (recall Algorithm 2 Line 4 for the definition of V_i) that satisfies either of the following two conditions can be pruned:*

- $u \in N_{G_i}(v_i)$ and $|N_{G_i}(u) \cap N_{G_i}(v_i)| < q - 2k$;
- $u \in N_{G_i}^2(v_i)$ and $|N_{G_i}(u) \cap N_{G_i}(v_i)| < q - 2k + 2$.

Upper Bound Computation. We next consider how to obtain the upper bound of the maximum size of a k -plex containing P , which is called in Algorithm 3 Line 17.

Theorem 5. *Given a k -plex P in a seed subgraph $G_i = (V_i, E_i)$, the upper bound of the maximum size of a k -plex containing P is $\min_{u \in P} \{d_{G_i}(u)\} + k$.*

Proof. Let $P_m \subseteq P \cup C$ be a maximum k -plex containing P . Given any $u \in P$, we can partition P_m into two sets: (1) $N_{G_i}(u) \cap P_m$, and (2) $\overline{N}_{G_i}(u) \cap P_m$. The first set has size at most $|N_{G_i}(u)| = d_{G_i}(u)$, while we can add at most k vertices of the second set into P (or the degree of $u \in P$ will

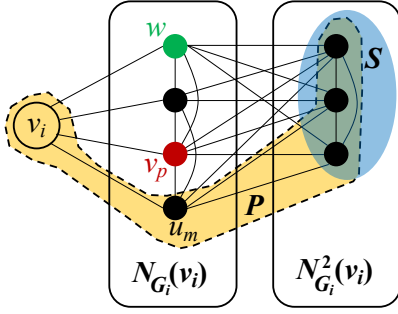

Fig. 3. Upper Bound Illustration for Theorem 6

violate the definition of k -plex). Thus, $|P_m| \leq d_{G_i}(u) + k$. The theorem is proved since u is an arbitrary vertex in P . \square

In Line 17 of Algorithm 3, we actually compute $\min_{u \in P \cup \{v_p\}} \{d_{G_i}(u)\} + k$ as an upper bound by Theorem 5. Recall that we already select v_p as the vertex in G_i with the minimum degree in Line 7 of Algorithm 3, so the upper bound can be simplified as $d_{G_i}(v_p) + k$. Note that v_p here is the one obtained in Lines 7–10, not the v_{new} that replaces the old v_p in Line 16 in the case when $v_p \in P$.

We next derive another upper bound of the maximum size of a k -plex containing P . First, we define the concept of “support number of non-neighbors”. Given a k -plex P and candidate set C , for a vertex $v \in P \cup C$, its support number of non-neighbors is defined as $\text{sup}_P(v) = k - \overline{d}_P(v)$, which is the maximum number of non-neighbors of v outside P that can be included in any k -plex containing P .

Theorem 6. Let v_i and $G_i = (V_i, E_i)$ be the seed vertex and corresponding seed subgraph, respectively, and consider a sub-task $P_S = S \cup \{v_i\}$ where $S \subseteq N_{G_i}^2(v_i)$.

For a k -plex P satisfying $P_S \subseteq P \subseteq V_i$ and for a pivot vertex $v_p \in C \subseteq C_S = N_{G_i}(v_i)$, the upper bound of the maximum size of a k -plex containing $P \cup \{v_p\}$ is

$$|P| + \text{sup}_P(v_p) + |K|, \quad (2)$$

where the set K is computed as follows:

Initially, $K = N_C(v_p)$. For each $w \in K$, we find $u_m \in \overline{N}_P(w)$ such that $\text{sup}_P(u_m)$ is the minimum; if $\text{sup}_P(u_m) > 0$, we decrease it by 1. Otherwise, we remove w from K .

Figure 3 shows the rationale of the upper bound in Eq (2), where $v_p \in C_S$ is to be added to P (shown inside the dashed contour). Let $P_m \subseteq P \cup C$ be a maximum k -plex containing $P \cup \{v_p\}$, then the three terms in Eq (2) correspond to the upper bounds of the three sets that P_m can take its vertices from: (1) P whose size is exactly $|P|$, (2) v_p 's non-neighbors in C , i.e., $P_m \cap \overline{N}_C(v_p)$ (including v_p itself) whose size is upper-bounded by $\text{sup}_P(v_p) = k - \overline{d}_P(v_p)$, and (3) v_p 's neighbors in C , i.e., $P_m \cap N_C(v_p)$ whose size is upper-bounded by $|K|$.

Here, K computes the largest set of candidates in $N_C(v_p)$ that can expand $P \cup \{v_p\}$. Specifically, for each $w \in N_C(v_p)$, if there exists a non-neighbor in P , denoted by u_m , that has $\text{sup}_P(u_m) = 0$, then w is pruned (from K) since if we move w to P , u_m would violate the k -plex definition. Otherwise,

Algorithm 4: Computing Upper Bound by Theorem 6

```

1  $\text{sup}_P(v_p) \leftarrow k - \overline{d}_P(v_p)$ 
2 foreach  $u \in P$  do    $\text{sup}_P(u) \leftarrow k - \overline{d}_P(u)$ 
3  $ub \leftarrow |P| + \text{sup}_P(v_p)$ 
4 foreach  $w \in N_C(v_p)$  do
5   Find  $u_m \in \overline{N}_P(w)$  s.t.  $\text{sup}_P(u_m)$  is the minimum
6   if  $\text{sup}_P(u_m) > 0$  then
7      $\text{sup}_P(u_m) \leftarrow \text{sup}_P(u_m) - 1$ 
8      $ub \leftarrow ub + 1$ 
9 return  $ub$ 

```

we decrement $\text{sup}_P(u_m)$ to reflect that w (which is a non-neighbor of u_m) has been added to K (i.e., removed from C) to expand $P \cup \{v_p\}$. Algorithm 4 shows the above approach to compute the upper bound, called in Line 17 of Algorithm 3.

We next prove that K is truly the largest set of candidates in $N_C(v_p)$ that can expand $P \cup \{v_p\}$.

Proof. See our online Appendix B [2]. \square

Putting Theorems 5 and 6 together, the upper bound in Line 17 of Algorithm 3 is given by

$$\min\{|P| + \text{sup}_P(v_p) + |K|, d_{G_i}(v_p) + k\}. \quad (3)$$

For an initial sub-task $\langle P_S, C_S, X_S \rangle$, we can further improve Theorem 6 as follows.

Theorem 7. Let v_i and $G_i = (V_i, E_i)$ be the seed vertex and corresponding seed subgraph, respectively, and consider a sub-task $P_S = S \cup \{v_i\}$ where $S \subseteq N_{G_i}^2(v_i)$ and $S \neq \emptyset$.

Let K be $C_S = N_{v_i}(G_i)$ initially. For each $v \in K$, we find $u_m \in \overline{N}_S(v)$ that $\text{sup}(P_S, u_m)$ is minimum. If $\text{sup}(P_S, u_m) > 0$, decrease it by 1. Otherwise remove v from K .

Then, the upper bound of the maximum size of a k -plex containing P_S is $|P_S| + |K|$.

Proof. This is a special case of Theorem 6 with $P = S$ and $v_p = v_i$. Let $P_m \supseteq P_S = S \cup \{v_i\}$ be a maximum k -plex containing P_S , then following the proof of Theorem 6, we divide P_m into three disjoint sets: (1) P_S , (2) $P_m \cap \overline{N}_{C_S}(v_i)$, (3) $P_m \cap N_{C_S}(v_i)$. Note that $P_m \cap \overline{N}_{C_S}(v_i) = \emptyset$ since $\overline{N}_{C_S}(v_i) = \emptyset$ (as $C_S = N_{G_i}(v_i)$). Also, Theorem 6 has proved that $|P_m \cap N_{C_S}(v_i)| \leq |K|$. Therefore, we have $|P_m| \leq |P_S| + 0 + |K| = |P_S| + |K|$. \square

Theorem 5 also gives another upper bound of the maximum size of a k -plex containing P_S , which is $\min_{v \in P_S} \{d_{G_i}(v)\} + k$.

Combining with Theorem 7, the new upper bound is given by $ub(P_S) = \min\{|P_S| + |K|, \min_{v \in P_S} \{d_{G_i}(v)\} + k\}$. Right before Line 10 of Algorithm 2, we check if $ub(P_S) < q$; if so, we prune this sub-task without calling Branch().

Time Complexity Analysis. We now analyze the time complexity of our algorithm, i.e., Algorithm 2. Recall that D is the degeneracy of G , that Δ is the maximum degree of G , and that seed vertices are in the degeneracy ordering of V , $\eta = \{v_1, \dots, v_n\}$. Therefore, given a seed subgraph

$G_i = (V_i, E_i)$ where $V_i \subseteq \{v_i, v_{i+1}, \dots, v_n\}$, for each $v \in G_i$, we have $d_{G_i}(v) = |N_{G_i}(v)| \leq D$.

Let us first consider the time complexity of Algorithm 4.

Lemma 1. *The time complexity of Algorithm 4 is given by*

$$O(k + (k + 1)D) \approx O(D).$$

Proof. See our online Appendix C [2]. \square

We next bound the number of sub-tasks of in each G_i created by Lines 7 and 10 of Algorithm 2.

Lemma 2. *Let v_i and $G_i = (V_i, E_i)$ be the seed vertex and corresponding seed subgraph, respectively. Also, let us abuse the notation $|N_{G_i}^2(v_i)|$ to mean the one pruned by Corollary 1 in Line 6 of Algorithm 2. Then, we have $|N_{G_i}(v_i)| \leq D$ and $|N_{G_i}^2(v_i)| = O(r_1)$ where $r_1 = \min \left\{ \frac{D\Delta}{q-2k+2}, n \right\}$.*

Also, the number of subsets $S \subseteq N_{G_i}^2(v_i)$ ($|S| \leq k - 1$) is bounded by $O(|N_{G_i}^2(v_i)|^k) = O(r_1^k)$.

Proof. See our online Appendix D [2]. \square

We can also bound the time complexity of Algorithm 3:

Lemma 3. *Let v_i and $G_i = (V_i, E_i)$ be the seed vertex and corresponding seed subgraph, respectively. Then, $\text{Branch}(G_i, k, q, P_S, C_S, X_S)$ (see Line 10 in Algorithm 2) recursively calls the body of Algorithm 4 for $O(\gamma_k^D)$ times, where $\gamma_k < 2$ is the maximum positive real root of $x^{k+2} - 2x^{k+1} + 1 = 0$ (e.g., $\gamma_1 = 1.618$, $\gamma_2 = 1.839$, and $\gamma_3 = 1.928$).*

To see this bound, note that Theorem 1 of [14] has proved that the branch-and-bound procedure is called for $O(\gamma_k^{|C|})$ times. In [14], the candidate set C is taken from vertices within two hops away from each seed vertex v_i , so the branch-and-bound procedure is called for $O(\gamma_k^{|C|}) \leq O(\gamma_k^n)$ times. In our case, $C = C_S = N_{G_i}(v_i)$ which is much tighter since $|C| \leq D$, hence the branch-and-bound procedure is called for $O(\gamma_k^{|C|}) \leq O(\gamma_k^D)$ times.

Finally, let us consider the cost of the recursion body of Algorithm 3. Note that besides $d_P(\cdot)$, we also maintain $d_{G_i}(\cdot)$ for all vertices in G_i , so that Line 7 of Algorithm 3 (the same applies to Line 16) can obtain the vertices with minimum $d_{G_i}(\cdot)$ in $O(|P| + |C|) \approx O(D)$ time. This is because $P \cup C \subseteq P_S \cup C_S$, so $O(|P| + |C|) = O(|P_S| + |C_S|) = O(k + D) \approx O(D)$, as $|P_S| \leq k$ and $|C_S| \leq D$.

As for the tightening of C and X in Lines 2–3 of Algorithm 3 (the same applies to Line 12), the time complexity is $O(|P|(|C| + |X|))$. Specifically, we first compute the set of saturated vertices in P , denoted by P^* . Since we maintain $d_P(\cdot)$, we can find P^* in $O(|P|)$ time by examining if each vertex u has $d_P(u) = |P| - k$. Then, for each vertex $v \in C \cup X$, we do not prune it if and only if (1) v is adjacent to all vertices in P^* , and meanwhile, (2) $d_P(v) \geq |P \cup \{v\}| - k = |P| + 1 - k$. This takes $O(|P^*|(|C| + |X|)) = O(|P|(|C| + |X|))$ time.

The recursive body takes time $O(|P|(|C| + |X|))$ which is dominated by the above operation. Note that by Lemma 1, Line 17 of Algorithm 3 takes only $O(D) \approx O(|P| + |C|)$

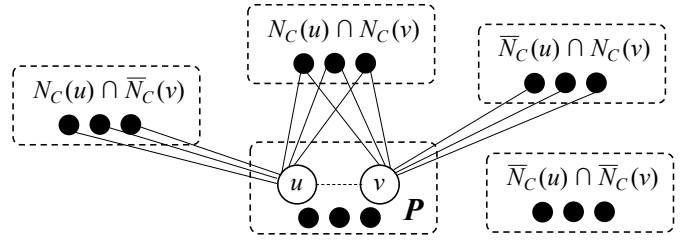

Fig. 4. Upper Bound Illustration for Lemma 4

time, and the time to select pivot (cost dominated by Line 7) also takes only $O(|P| + |C|)$ time.

Now we are ready to present the time complexity of our Algorithm 2.

Theorem 8. *Given an undirected graph $G = (V, E)$ with degeneracy D and maximum degree Δ , Algorithm 2 lists all the k -plexes with size at least q within time $O(nr_1^k r_2^D \gamma_k^D)$, where $r_1 = \min \left\{ \frac{D\Delta}{q-2k+2}, n \right\}$ and $r_2 = \min \left\{ \frac{D\Delta^2}{q-2k+2}, nD \right\}$.*

Proof. See our online Appendix E [2]. \square

Additional Pruning by Vertex Pairs. We next present how to utilize the property between vertex pairs in G_i to enable three further pruning opportunities, all based on Lemma 4 below.

Lemma 4. *Given a k -plex P and candidate set C , the upper bound of the maximum size of a k -plex containing P is*

$$\min_{u, v \in P} \left\{ |P| + \sup_P(u) + \sup_P(v) + |N_u(C) \cap N_v(C)| \right\}$$

Proof. To prove this, let $P_m \subseteq P \cup C$ be a maximum k -plex containing P . For two arbitrary vertices $u, v \in P$, the candidate set C can be divided into four subsets as illustrated in Figure 4: (1) $N_C(u) \cap N_C(v)$, (2) $N_C(u) \cap \overline{N_C}(v)$, (3) $\overline{N_C}(u) \cap N_C(v)$, and (4) $\overline{N_C}(u) \cap \overline{N_C}(v)$. Therefore,

$$|P_m| \leq |P| + |N_C(u) \cap N_C(v)| + |N_C(u) \cap \overline{N_C}(v)| + |\overline{N_C}(u) \cap N_C(v)| + |\overline{N_C}(u) \cap \overline{N_C}(v)|.$$

Note that

$$|N_C(u) \cap \overline{N_C}(v)| + |\overline{N_C}(u) \cap \overline{N_C}(v)| = |\overline{N_C}(v)| \leq \sup_P(v),$$

$$|\overline{N_C}(u) \cap N_C(v)| + |\overline{N_C}(u) \cap \overline{N_C}(v)| = |\overline{N_C}(u)| \leq \sup_P(u).$$

Therefore, we have

$$|P_m| \leq |P| + \sup_P(u) + \sup_P(v) + |N_C(u) \cap N_C(v)|, \quad (4)$$

which completes the proof since $u, v \in P$ are arbitrary. \square

Recall that Algorithm 2 Line 7 enumerates set S from the vertices of $N_{G_i}^2(v_i)$. The first pruning rule below checks if two vertices $u_1, u_2 \in N_{G_i}^2(v_i)$ have sufficient common neighbors in C_S , and if not, then u_1 and u_2 cannot occur together in S .

Theorem 9. *Let v_i be a seed vertex and $G_i = (V_i, E_i)$ be the corresponding seed subgraph. For any two vertices $u_1, u_2 \in N_{G_i}^2(v_i)$, if either of the following conditions are met*

- $(u_1, u_2) \in E_i$ and $|N_{C_S}(u_1) \cap N_{C_S}(u_2)| < q - k - 2 \cdot \max\{k - 2, 0\}$,

- $(u_1, u_2) \notin E_i$ and $|N_{C_S}(u_1) \cap N_{C_S}(u_2)| < q - k - 2 \cdot \max\{k - 3, 0\}$,

then u_1 and u_2 cannot co-occur in a k -plex P with $|P| \geq q$.

Proof. We prove it using Lemma 4. Specifically, assume that two vertices $u_1, u_2 \in N_{G_i}^2(v_i)$ co-occur in a k -plex P with $|P| \geq q$, then P is expanded from $P_S = \{v_i\} \cup S$, where $\{u_1, u_2\} \subseteq S \subseteq N_{G_i}^2(v_i)$ and $|S| \leq k - 1$ (hence $|P_S| \leq k$).

According to Eq (4) in Lemma 4, we require

$$|P_S| + \sup_{P_S}(u_1) + \sup_{P_S}(u_2) + |N_{C_S}(u_1) \cap N_{C_S}(u_2)| \geq q,$$

or equivalently (recall that $|P_S| \leq k$),

$$|N_{C_S}(u_1) \cap N_{C_S}(u_2)| \geq q - k - \sup_{P_S}(u_1) - \sup_{P_S}(u_2).$$

If $(u_1, u_2) \in E_i$, then $\sup_{P_S}(u_1) \leq k - 2$ (resp. $\sup_{P_S}(u_2) \leq k - 2$), since $v_i \in P_S$ is a non-neighbor of u_1 (resp. u_2) besides u_1 (resp. u_2) itself in P_S . Thus,

$$|N_{C_S}(u_1) \cap N_{C_S}(u_2)| \geq q - k - 2 \cdot \max\{k - 2, 0\}.$$

While if $(u_1, u_2) \notin E_i$, then $\sup_{P_S}(u_1) \leq k - 3$ (resp. $\sup_{P_S}(u_2) \leq k - 3$), since $v_i \in P_S$ is a non-neighbor of u_1 (resp. u_2) besides $u_1, u_2 \in P_S$. Thus,

$$|N_{C_S}(u_1) \cap N_{C_S}(u_2)| \geq q - k - 2 \cdot \max\{k - 3, 0\}.$$

This completes our proof of Theorem 9. \square

Similar analysis can be adapted for the other two cases: (1) $u_1 \in N_{v_i}(G_i)$ and $u_2 \in N_{v_i}^2(G_i)$, and (2) $u_1, u_2 \in N_{v_i}(G_i)$, which we present in the next two theorems.

Theorem 10. Let v_i be a seed vertex and $G_i = (V_i, E_i)$ be the corresponding seed subgraph. For any two vertices $u_1 \in N_{G_i}^2(v_i)$ and $u_2 \in N_{G_i}(v_i)$, let us define $C_S^- = C_S - \{u_2\}$, then if either of the following two conditions are met

- $(u_1, u_2) \in E_i$ and $|N_{C_S^-}(u_1) \cap N_{C_S^-}(u_2)| < q - 2k - 2 \cdot \max\{k - 2, 0\}$,
- $(u_1, u_2) \notin E_i$ and $|N_{C_S^-}(u_1) \cap N_{C_S^-}(u_2)| < q - k - \max\{k - 2, 0\} - \max\{k - 2, 1\}$,

then u_1 and u_2 cannot co-occur in a k -plex P with $|P| \geq q$.

Proof. See our online Appendix F [2]. \square

Theorem 11. Let v_i be a seed vertex and $G_i = (V_i, E_i)$ be the corresponding seed subgraph. For any two vertices $u_1, u_2 \in N_{G_i}(v_i) = C_S$, let us define $C_S^- = C_S - \{u_1, u_2\}$, then if either of the following two conditions are met

- $(u_1, u_2) \in E_i$ and $|N_{C_S^-}(u_1) \cap N_{C_S^-}(u_2)| < q - 3k$,
- $(u_1, u_2) \notin E_i$ and $|N_{C_S^-}(u_1) \cap N_{C_S^-}(u_2)| < q - k - 2 \cdot \max\{k - 1, 1\}$,

then u_1 and u_2 cannot co-occur in a k -plex P with $|P| \geq q$.

Proof. See our online Appendix G [2]. \square

We next explain how Theorems 9, 10 and 11 are used in our algorithm to prune the search space. Recall that G_i is dense, so we use adjacency matrix to maintain the information of G_i . Here, we also maintain a boolean matrix T so that for any $u_1, u_2 \in V_i$, $T[u_1][u_2] = false$ if they are pruned by Theorem 9

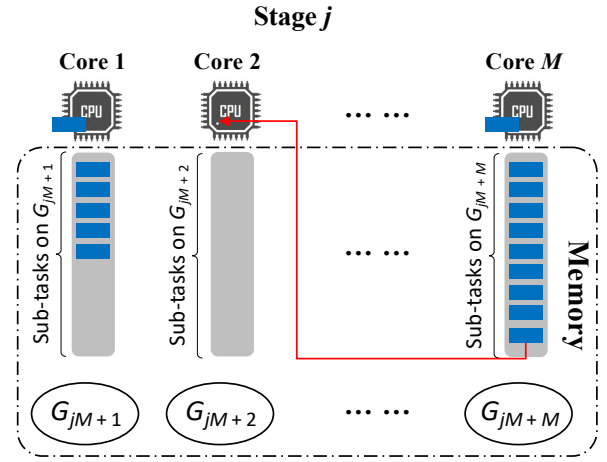

Fig. 5. Illustration of Parallel Processing

or 10 or 11 due to the number of common neighbors in the candidate set being below the required threshold; otherwise, $T[u_1][u_2] = true$. Note that given T , we can obtain $T[u_1][u_2]$ in $O(1)$ time to determine if u_1 and u_2 can co-occur.

Recall from Figure 1 that we enumerate S using the set-enumeration tree. When we enumerate S in Algorithm 2 Line 7, assume that the current S is expanded from S' by adding u , and let us denote by $ext(S')$ those candidate vertices that can still expand S' , then by Theorem 9, we can incrementally prune those candidate vertices $u' \in ext(S')$ with $T[u][u'] = false$ to obtain $ext(S)$ that can expand S further.

We also utilize Theorem 10 to further shrink C_S in Algorithm 2 Line 8. Assume that the current S is expanded from S' by adding u , then we can incrementally prune those candidate vertices $u' \in C_{S'}$ with $T[u][u'] = false$ to obtain C_S .

Finally, we utilize Theorem 11 to further shrink C and X in Algorithm 3 Lines 2 and 3. Specifically, assume that v_p is newly added to P , then Line 2 now becomes

$$C \leftarrow \{v \in C \wedge P \cup \{v\} \text{ is a } k\text{-plex} \wedge T[v_p][v] = true\}.$$

Recall from Algorithm 2 Line 9 that vertices in X may come from V'_i or V_i . So for each $v \in X$, if $v \in V_i$, then we prune v if $T[v_p][v] = false$. This is also applied in Line 12 when we compute the new exclusive set to check maximality.

V. PARALLELIZATION

Recall from Algorithm 2 that we generate initial task groups $T_{\{v_i\}}$ each creating and maintaining G_i . The sub-tasks of $T_{\{v_i\}}$ are $T_{\{v_i\} \cup S}$ that are generated by enumerating $S \subseteq N_{G_i}^2(v_i)$, and each such task runs the recursive $Branch(\cdot)$ procedure of Algorithm 3 (recall Line 10 of Algorithm 2).

We parallelize Algorithm 2 on a multi-core machine with M CPU cores (and hence M working threads to process tasks) in stages. In each stage j ($j = 0, 1, \dots$), the M working threads obtain M new task groups generated by the next M seed vertices in η for parallel processing, as illustrated in Figure 5.

Specifically, at the beginning of Stage j , the i^{th} thread creates and processes the task group with seed vertex v_{jM+i} by creating the subgraph G_{jM+i} , and enumerating S to create

the sub-tasks with $P_S = \{v_{jM+i}\} \cup S$ and adding them into a task queue Q_i local to Thread i . Then, each thread i processes the tasks in its local queue Q_i to maximize data locality and hence cache hit rate (since the processing is on a shared graph G_i). If Thread i finishes all tasks in Q_i but other threads are still processing their tasks in Stage j , then Thread i will obtain tasks from another non-empty queue $Q_{i'}$ for processing to take over some works of Thread i' . This approach achieves load balancing while maximizes CPU cache hit rate.

Stage j ends when the tasks in all queues are exhausted, after which we release the memory used by these task groups (e.g., seed subgraphs G_i) and move forward to Stage $(j + 1)$ to process the next M seed vertices. The stages are repeated until all seed vertices in η are exhausted.

So far, we treat each sub-task T_{P_S} as an independent task run by a thread in its entirety. However, some sub-tasks T_{P_S} can become stragglers that take much longer time to complete than other tasks (e.g., due to a much larger set-enumeration subtree under P_S). We propose to use a timeout mechanism to further decompose each straggler task into many smaller tasks to allow parallel processing. Specifically, let t_0 be the time when the current task is created, and let t_{cur} be the current time. Then in Algorithm 3 Line 19 (resp. Line 20), we only recursively call $Branch(\cdot)$ over $\langle P \cup \{v_p\}, C - \{v_p\}, X \rangle$ (resp. $\langle P, C - \{v_p\}, X \cup \{v_p\} \rangle$) if $t_{cur} - t_0 \leq \tau_{time}$, where τ_{time} is a user-defined task timeout threshold. Otherwise, let the thread processing the current task be Thread i , then we create a new task and add it to Q_i . The new tasks can reuse the seed subgraph of its task group, but need to materialize new status variables such as containers for keeping P , C and X , and the boolean matrix $T[u_1][u_2]$ for pruning by vertex pairs.

In this way, a straggler task will call $Branch(\cdot)$ for recursive backtracking search as usual until $t_{cur} - t_0 \leq \tau_{time}$, after which it backtracks and creates new tasks to be added to Q_i . If a new task also times out, it will be further decomposed in a similar manner, so stragglers are effectively eliminated at the small cost of status variable materialization.

VI. EXPERIMENT

In this section, we conduct comprehensive experiments to evaluate our method for large maximal k -plex enumeration, and compare it with the other existing methods. We also conduct an ablation study to show the effectiveness of our optimization techniques. All our source codes have been released at <https://github.com/chengqihao/Maximal-kPlex>.

Recall from Algorithm 3 Lines 15-16 that we always select the pivot v_p to be from C , so that our upper-bound-based pruning in Lines 17-18 can be applied to try to prune the branch in Line 19. In fact, if $v_p \in P$, FaPlexen [33] proposed and adopted another branching method to reduce the search space, which is also adopted by ListPlex [25]. Specifically, let us define $s = \sup_P(v_p)$, and $\overline{N}_C(v_p) = \{w_1, w_2, \dots, w_\ell\}$, then we can move at most s vertices from $\overline{N}_C(v_p)$ to P to produce k -plexes. Note that $s \leq k$ since $\sup_P(v_p) = k - \overline{d}_P(v_p)$ so s is small, and that $s \leq \ell$ since otherwise, $P \cup C$ is a k -plex and this branch of search terminates (see Algorithm 3

TABLE I
DATASETS

Network	n	m	Δ	D
jazz	198	2742	100	29
wiki-vote	7115	100,762	1065	53
lastfm	7624	27,806	216	20
as-caida	26,475	53,381	2628	22
soc-epinions	75,879	405,740	3044	67
soc-slashdot	82,168	504,230	2552	55
email-euall	265,009	364,481	7636	37
com-dblp	317,080	1,049,866	343	113
amazon0505	410,236	2,439,437	2760	10
soc-pokec	1,632,803	22,301,964	14,854	47
as-skitter	1,696,415	11,095,298	35,455	111
enwiki-2021	6,253,897	136,494,843	232,410	178
arabic-2005	22,743,881	553,903,073	575,628	3247
uk-2005	39,454,463	783,027,125	1,776,858	588
it-2004	41,290,648	1,027,474,947	1,326,744	3224
webbase-2001	115,554,441	854,809,761	816,127	1506

Lines 11-14). Therefore, let the current task be $\langle P, C, X \rangle$, then it only needs to produce $s + 1$ branches without missing k -plexes:

$$\langle P, C - \{w_1\}, X \cup \{w_1\} \rangle, \quad (5)$$

For $i = 2, \dots, s$,

$$\langle P \cup \{w_1, \dots, w_{i-1}\}, C - \{w_1, \dots, w_i\}, X \cup \{w_i\} \rangle, \quad (6)$$

$$\langle P \cup \{w_1, \dots, w_\ell\}, C - \{w_1, \dots, w_\ell\}, X \rangle. \quad (7)$$

In summary, if $v_p \in P$, we can apply Eq (5)–Eq (7) for branching, while if $v_p \in C$, we can apply the upper bound defined by Eq (3) to allow the pruning of $\langle P \cup \{v_p\}, C - \{v_p\}, X \rangle$ in Algorithm 3 Line 19. Therefore, besides the original Algorithm 3 which we denote by **Ours**, we also consider a variant of Algorithm 3 which, when $v_p \in P$ is selected by Lines 7–10, uses Eq (5)–Eq (7) for branching rather than re-picking a pivot $v_p \in C$ as in Lines 15–16. We denote this variant by **Ours_P**. As we shall see, Ours_P is generally not as efficient as Ours, showing that upper-bound based pruning is more effective than the branch reduction scheme of Eq (5)–Eq (7), so Ours is selected as our default algorithm in our experiments.

Datasets and Experiment Setting. Following [13], [14], [25], we use the 18 real-world datasets in our experiments as summarized in Table I, where n and m are the numbers of vertices and edges, respectively; Δ indicates the maximum degree and D is the degeneracy. These public graph datasets are obtained from Stanford Large Network Dataset Collection (SNAP) [3] and Laboratory for Web Algorithmics (LAW) [1], [8]. Similar to the previous works [13], [14], [25], we roughly categorize these graphs into three types: small, medium, and large. The ranges of the number of vertices for these three types of graphs are $[1, 10^4]$, $[10^4, 5 \times 10^6]$, and $[5 \times 10^6, +\infty)$.

Our code is written in C++14 and compiled by g++-7.2.0 with optimization flag -O3. All the experiments are conducted on a platform with 20 cores (Intel Xeon Gold 6248R CPU 3.00GHz) and 128GB RAM.

Existing Methods for Comparison. A few methods have been proposed for large maximal k -plex enumeration, includ-

TABLE II
THE RUNNING TIME (SEC) OF LISTING LARGE MAXIMAL k -PLEXES FROM SMALL AND MEDIUM GRAPHS BY FP, LISTPLEX, OURS_P, OURS

Network (n, m)	k	q	# k -plexes	Running time (sec)				Network (n, m)	k	q	# k -plexes	Running time (sec)			
				FP	ListPlex	Ours_P	Ours					FP	ListPlex	Ours_P	Ours
jazz (198, 2742)	4	12	2,745,953	3.68	4.12	3.92	2.87	soc-epinions (75,879, 405,740)	2	12	49,823,056	278.56	153.64	157.98	130.14
lastfm (7624, 27,806)	4	12	1,827,337	2.39	2.58	2.52	2.04		20	3,322,167	16.65	17.00	16.65	14.01	
as-caida (26,475, 53,381)	2	12	5336	0.03	0.03	0.03	0.03		30	548,634,119	2240.68	2837.49	2442.10	1540.87	
	3	12	281,251	0.94	0.78	0.67	0.53		4	16,066	3.29	4.66	2.52	2.11	
amazon0505 (410,236, 2,439,437)	4	12	15,939,891	51.39	45.31	37.52	26.08	4	30	13,172,906	139.59	545.82	198.88	93.47	
	2	12	376	0.37	0.11	0.08	0.07	wiki-vote (7115, 100,762)	2	12	2,919,931	19.21	14.77	13.62	12.58
	3	12	6347	0.57	0.26	0.20	0.22		20	52	0.37	0.46	0.44	0.42	
4	12	105,649	1.47	0.99	0.91	0.78	12		458,153,397	2680.68	2037.51	1746.63	1239.83		
2	20	0	1.49	0.14	0.14	0.11	3		20	156,727	11.91	8.13	4.67	4.15	
as-skitter (1,696,415, 11,095,298)	2	60	87,767	4.37	5.14	4.41	4.68	soc-slashdot (82,168, 504,230)	4	20	46,729,532	483.97	1025.54	455.37	252.40
	3	60	9,898,234	283.52	1010.48	302.53	234.17		30	0	0.03	0.07	0.08	0.06	
email-euall (265,009, 364,481)	2	12	412,779	1.61	1.34	1.27	1.11		2	12	30,281,571	91.10	65.57	66.16	51.41
	2	20	0	0.08	0.05	0.05	0.05		20	20	13,570,746	38.44	36.85	38.68	28.89
email-euall (265,009, 364,481)	3	12	32,639,016	101.16	91.59	82.07	56.22	soc-pokec (1,632,803, 22,301,964)	3	12	3,306,582,222	10368.47	8910.28	8894.69	5995.67
	3	20	2637	0.34	0.30	0.21	0.19		20	20	1,610,097,574	3950.16	5244.41	5325.80	3377.68
	4	12	1,940,182,978	7085.39	6041.73	5385.09	3535.63		30	30	4,626,307	32.36	76.44	49.43	30.10
	4	20	1,707,177	11.99	21.40	13.30	7.70		4	30	1,047,289,095	4167.85	10239.25	7556.32	4016.08
com-dblp (317,080, 1,049,866)	2	12	12,544	0.34	0.11	0.11	0.11	12	12	7,679,906	50.77	39.16	36.78	35.53	
	2	20	5049	0.27	0.06	0.06	0.05	2	20	94,184	9.02	10.67	10.24	10.00	
	3	12	3,003,588	6.13	3.75	3.68	3.51	soc-pokec (1,632,803, 22,301,964)	3	12	520,888,893	1719.85	1528.07	1347.97	996.43
		20	2,141,932	4.28	2.83	2.77	2.57		20	20	5,911,456	30.52	39.38	33.38	26.94
	4	12	610,150,817	914.84	729.16	720.13	666.98		30	30	5	6.10	6.35	6.47	5.92
		20	492,253,045	726.93	621.17	612.59	546.30		20	20	318,035,938	1148.87	1722.87	1292.65	780.34
30	12,088,200	27.66	32.58	31.65	17.08	30	30	4515	7.14	7.39	6.96	6.37			

ing D2K [13], CommuPlex [33], ListPlex [25], and FP [14]. Among them, ListPlex and FP outperform all the earlier works in terms of running time according to their experiments [14], [25], so they are chosen as our baselines for comparison. Note that ListPlex and FP are concurrent works, so there is no existing comparison between them. Thus, we choose these two state-of-the-art algorithms as baselines and compare our algorithm with them. Please refer to Section VII for a more detailed review of ListPlex and FP.

Following the tradition of previous works, we set the k -plex size lower bound q to be at least $2k - 1$ which guarantees the connectivity of the k -plexes outputted.

Performance of Sequential Execution. We first compare the sequential versions of our algorithm and the two baselines ListPlex and FP with parameters $k = 2, 3, 4$ and $q = 12, 20, 30$, following the parameter setting in [14], [25]. Since sequential algorithms can be slow (esp. for the baselines), the experiments use the small and medium graphs.

In Table II, we can see that our algorithm outperforms ListPlex and FP except for rare cases that are easy (i.e., where all algorithms finish very quickly). For our two algorithm variants, Ours is consistently faster than Ours_P, except for rare cases where both finish quickly in a similar amount of time. Moreover, our algorithm is consistently faster than ListPlex and FP. Specifically, Ours is up to $5\times$ faster than ListPlex (e.g., soc-epinions, $k = 4, q = 30$), and up to $2\times$ (e.g., email-euall, $k = 4, q = 12$) faster than FP, respectively. Also, there is no clear winner between ListPlex and FP: for example, ListPlex can be $3.56\times$ slower than FP (e.g., as-skitter, $k = 3, q = 60$), but over $10\times$ faster in other cases (e.g., as-skitter, $k = 3, q = 100$).

We can see that our algorithm has more advantage in effi-

ciency when the number of sub-tasks is larger. This is because our upper bounding and pruning techniques can effectively prune unfruitful sub-tasks. For instance, on dataset email-euall when $k = 4$ and $q = 12$, there are a lot of sub-tasks and the number of k -plexes outputted is thus huge; there, FP takes 7085.39 seconds while Ours takes only 3535.63 seconds.

We also study how the performance of sequential algorithms changes when q varies, and the results are shown in Figure 6. In each subfigure, the horizontal axis is q , and the vertical axis is the running time which consists of the time for core decomposition, subgraph construction, and k -plex enumeration. As Figure 6 shows, Ours (the red line) consistently uses less time than ListPlex and FP. For example, Ours is $4\times$ faster than ListPlex on dataset wiki-vote when $k = 4$ and $q = 20$.

As for the performance between ListPlex and FP, we can see from Figure 6 that when k is small, ListPlex (blue line) is always faster than FP (green line) with different values of q . As k becomes larger, FP can become faster than ListPlex. Note that the time complexity of ListPlex and FP are $O(n^{2k} + n(D\Delta)^{k+1}\gamma_k^D)$ and $O(n^2\gamma_k^n)$, respectively where $\gamma_k < 2$ is a constant. Therefore, when k is small, the time complexity of ListPlex is smaller than FP; but as k becomes large, the number of branches increases quickly and the upper-bounding technique in FP becomes effective. These results are also consistent with the statement in FP's paper [14]: *the speedup of FP increases dramatically with the increase of k* . As far as we now, this is the first time to compare the performance of ListPlex and FP, which are proposed in parallel very recently.

Performance of Parallel Execution. We next compare the performance of the parallel versions of Ours, ListPlex, and FP, using the large graphs. Note that both ListPlex and FP

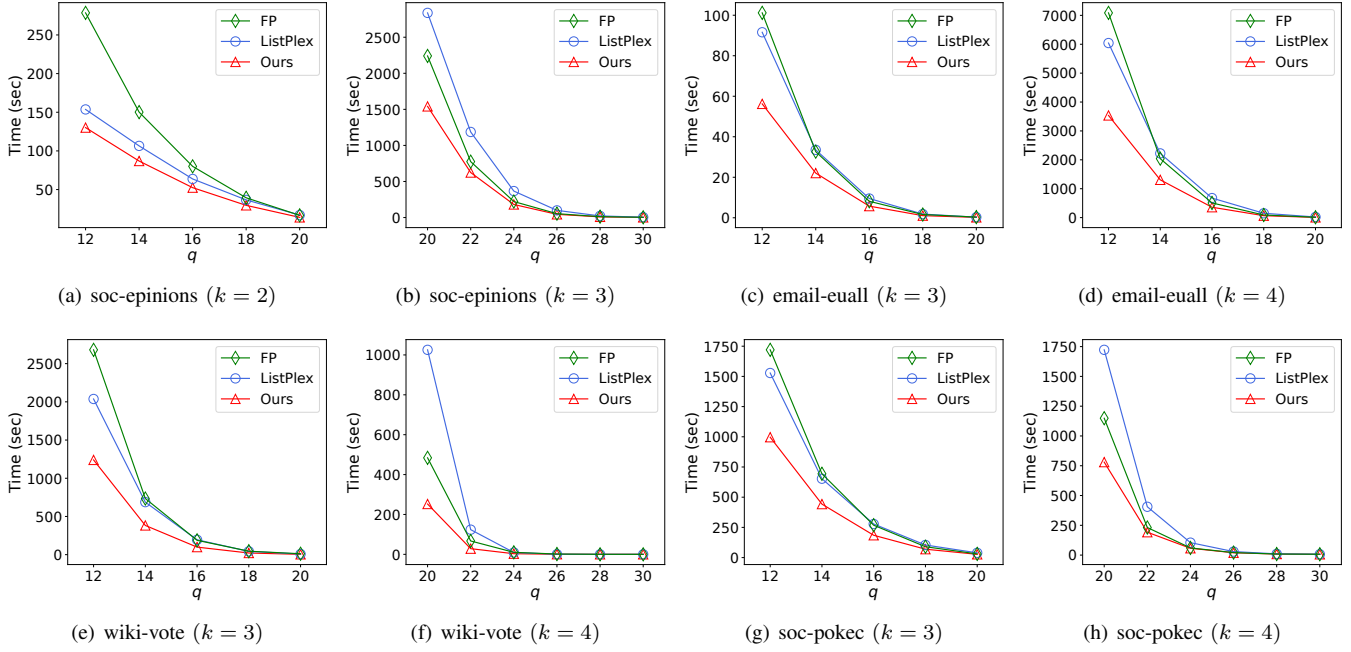

Fig. 6. The Running Time (sec) of the Three Algorithms on Various Datasets and Parameters

TABLE III

THE RUNNING TIME (SEC) OF LISTING LARGE MAXIMAL k -PLEXES ON LARGE GRAPHS BY PARALLEL FP, LISTPLEX, AND OURS WITH 16 THREADS

Network	n	m	$k = 2$							$k = 3$						
			q	τ_{best} (ms)	# k -plexes	FP	ListPlex	Ours	Ours (τ_{best})	q	τ_{best} (ms)	# k -plexes	FP	ListPlex	Ours	Ours (τ_{best})
enwiki-2021	6,253,897	136,494,843	40	0.01	1,443,280	241.18	291.22	154.99	151.01	50	0.001	40,997	19056.73	3860.17	1008.26	1006.43
arabic-2005	2,2743,881	553,903,073	900	1	224,870,898	1873.71	417.91	388.42	385.52	1000	0.1	34,155,502	708.36	70.10	67.98	67.98
uk-2005	39,454,463	783,027,125	250	0.01	159,199,947	FAIL	194.68	165.54	164.20	500	0.1	116,684,615	553.03	56.68	52.06	52.06
it-2004	41,290,648	1,027,474,947	1000	20	66,067,542	1958.70	2053.83	934.80	907.36	2000	0.1	197,679,229	17785.82	458.83	401.13	401.13
webbase-2001	115,554,441	854,809,761	400	0.1	59674227	222.81	67.45	60.93	60.93	800	0.1	1,785,341,050	15446.46	3312.95	3014.44	3014.442

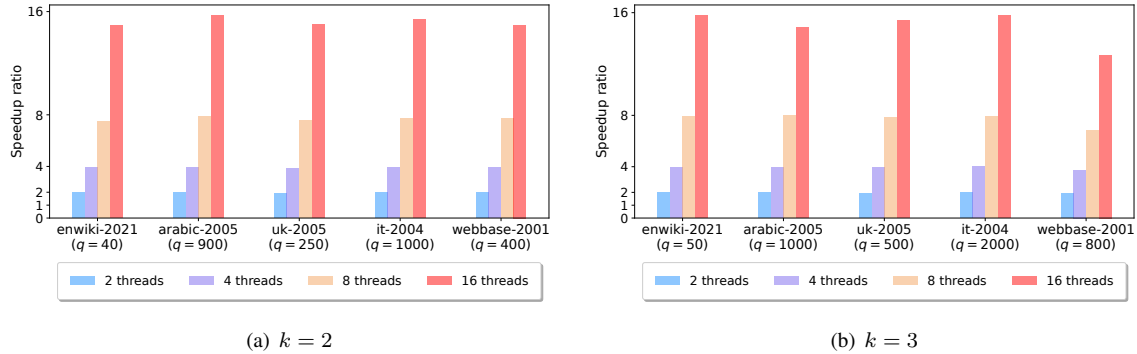

Fig. 7. The Speedup Ratio of Our Parallel Algorithm in Five Large Networks

provide their own parallel implementations, but they cannot eliminate straggler tasks like Ours, which adopts a timeout mechanism (c.f. Section V). For Ours, we fix the timeout threshold $\tau_{time} = 0.1$ ms by default to compare with parallel ListPlex and FP. We also include a variant “Ours (τ_{best})” which tunes τ_{time} to find its best value (i.e., τ_{best}) that minimizes the running time for each individual dataset and each parameter pair (k, q) .

Table III shows the running time of parallel FP, ListPlex, Ours ($\tau_{time} = 0.1$ ms) and Ours ($\tau_{time} = \tau_{best}$) running

with 16 threads. Note that the tuned values of τ_{best} are also shown in Table III, which vary in different test cases. Please refer to our online Appendix H [2] for the experimental results on tuning τ_{time} , where we can see that unfavorable values of τ_{time} (e.g., those too large for load balancing) may slow down the computation significantly. Overall, our default setting $\tau_{time} = 0.1$ ms consistently performs very close to the best setting when $\tau_{time} = \tau_{best}$ in all test cases shown in Table III, so it is a good default choice.

Compared with parallel ListPlex and FP, parallel Ours is

TABLE IV
EFFECT OF DIFFERENT UPPER BOUNDING TECHNIQUES

Network	k	q	Running time (sec)		
			Ours\ub	Ours\ub+fp	Ours
wiki-vote	3	12	1393.50	1319.05	1239.83
		20	5.20	4.72	4.15
	4	20	530.48	280.75	252.40
		30	0.14	0.13	0.06
soc-epinions	2	12	138.82	142.06	130.14
		20	14.92	15.48	14.01
	3	20	1699.49	1687.29	1540.87
		30	2.87	2.44	2.11
email-euall	3	12	62.85	63.83	56.22
		20	0.29	0.28	0.19
	4	12	4367.88	3961.40	3535.63
		20	13.01	9.31	7.70
soc-pokec	3	12	1039.61	1022.14	996.43
		20	27.21	29.19	26.94
	4	20	988.90	877.95	780.34
		30	6.91	6.76	6.37

TABLE V
EFFECT OF PRUNING RULES

Network	k	q	Running time (sec)			
			Basic	Basic+R1	Basic+R2	Ours
wiki-vote	3	12	2124.54	1726.29	1269.16	1239.83
		20	30.93	16.09	4.54	4.15
	4	20	1763.94	791.73	272.78	252.40
		30	0.14	0.15	0.15	0.06
soc-epinions	2	12	148.09	145.56	135.93	130.14
		20	16.42	16.31	14.86	14.01
	3	20	2086.60	1796.44	1582.69	1540.87
		30	10.48	6.43	2.30	2.11
email-euall	3	12	83.05	73.29	60.51	56.22
		20	0.53	0.44	0.28	0.19
	4	12	5729.98	4997.78	3708.91	3535.63
		20	15.39	11.58	8.04	7.70
soc-pokec	3	12	1477.74	1272.26	1009.03	996.43
		20	34.25	30.09	27.07	26.94
	4	20	1003.68	886.50	791.87	780.34
		30	6.88	6.57	6.63	6.37

significantly faster. For example, Ours is $18.9\times$ and $3.8\times$ faster than FP and ListPlex on dataset enwiki-2021 ($k = 3$ and $q = 50$), respectively. Note that FP is said to have *very high parallel performance* [14] and ListPlex also claims that it *can reach a nearly perfect speedup* [25]. Also note that FP fails on uk-2005 when $k = 2$ and $q = 250$, likely due to a bug in the code implementation of parallel FP. In fact, FP can be a few times slower than ListPlex, since its parallel implementation does not parallelize the subgraph construction step: all subgraphs are constructed in serial at the beginning which can become the major performance bottleneck.

We also evaluate the scale-up performance of our parallel algorithm. Figure 7 shows the speedup results, where we can see that Ours scales nearly ideally with the number of threads on all the five large datasets for all the tested parameters k and q used in Table III. For example, on dataset it-2004 ($k = 3$ and $q = 2000$), it achieves $7.93\times$ and $15.82\times$ speedup with 8 and 16 threads, respectively.

Ablation Study. We now conduct ablation study to verify the effectiveness of our upper-bound-based pruning technique

as specified in Lines 17-18 of Algorithm 3, where the upper bound is computed with Eq (3). While ListPlex does not apply any upper-bound-based pruning, FP uses one which requires a time-consuming sorting procedure in the computation of upper bound (c.f., Lemma 5 of [14]).

The ablation study results are shown in Table IV, where we use “Ours\ub” to denote our algorithm variant without using upper-bound-based pruning, and use “Ours\ub+fp” to denote our algorithm that directly uses the upper bounding technique of FP [14] instead. In Table IV, we show the results on four representative datasets with different k and q (the results on other datasets are similar and omitted due to space limit). We can see that Ours outperforms “Ours\ub” and “Ours\ub+fp” in all the cases. This shows that while using upper-bound-based pruning improves performance in this framework, FP’s upper bounding technique is not as effective as Ours, due to the need of costly sorting when computing the upper bound in each recursion. In fact, “Ours\ub+fp” can be even slower than “Ours\ub” (c.f., soc-epinions with $k = 2$ and $q = 12$) since the time-consuming sorting procedure in the computation of upper bound backfires, while the upper-bound-based pruning does not reduce the branches much. Another observation is that our upper-bounding technique is more effective when k and the number of sub-tasks become larger (e.g., when q is smaller). For example, the running time of Ours and “Ours\ub” is 252.40 seconds and 530.48 seconds, respectively, on dataset wiki-vote with $k = 4$ and $q = 20$.

We next conduct ablation study to verify the effectiveness of our pruning rules, including (R1) Theorem 7 for pruning initial sub-tasks right before Line 10 of Algorithm 2, and (R2) Theorems 9, 10 and 11 for second-order-based pruning to shrink the candidate and exclusive sets during recursion.

The ablation study results are shown in Table V, where our algorithm variant without R1 and R2 is denoted by “Basic”. In Table V, we can see that both R1 and R2 bring performance improvements on the four tested graphs. The pruning rules are the most effective on dataset wiki-vote with $k = 4$ and $q = 20$, where Ours achieves $7\times$ speedup compared with Basic.

Figure 8 further compares the running time between Basic and Ours as k and q vary (where more values of q are tested). We can see that Ours is consistently faster than the basic version with different k and q . This demonstrates the effectiveness of our pruning rules.

VII. RELATED WORK

Maximal k -Plex Finding. Berlowitz et al. [7] adopt a reverse search framework to enumerate maximal k -plexes. The key insight is that given a solution P , it is possible to find another solution by excluding some existing vertices from and including some new ones to H . Starting from an initial solution H_0 , [7] conducts depth-first search over the solution graph to enumerate all solutions. While the algorithm provides a polynomial delay (i.e., time of waiting for the next MBP) so that it is guaranteed to find some solutions in bounded time, it is less efficient than the Bron-Kerbosch algorithm when the goal is to enumerate all maximal k -plexes. The reverse

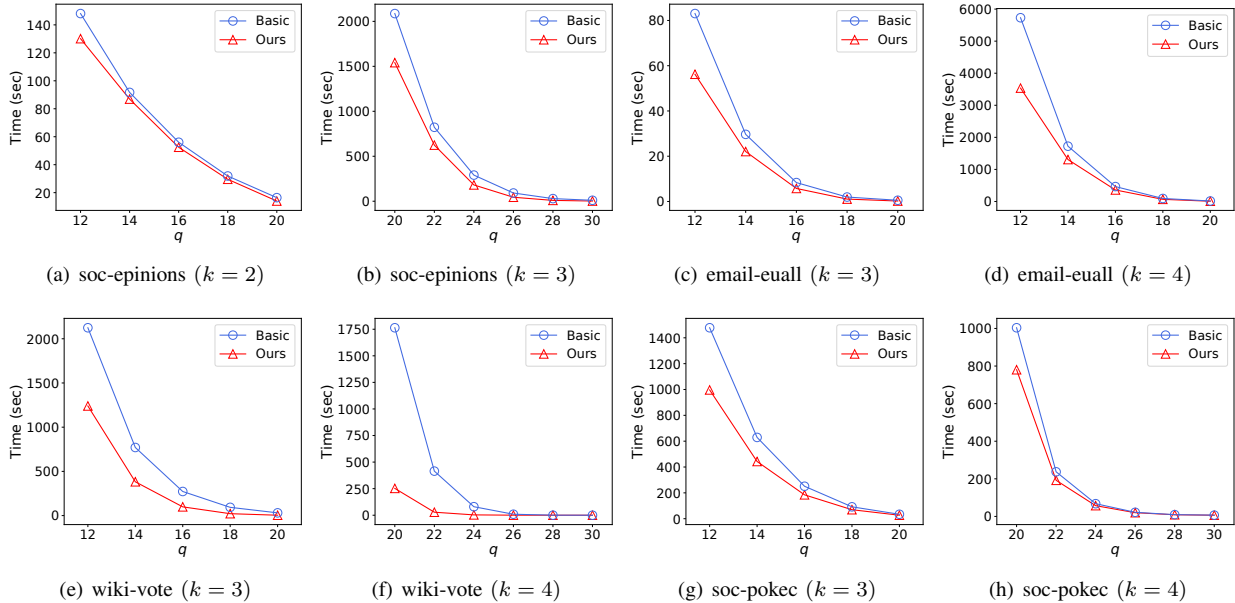

Fig. 8. The Running Time (sec) of Our Basic and Optimized Algorithms on Various Datasets and Parameters

search framework has also been used to enumerate maximal k -biplexes (adaptation of k -plexes to a bipartite graph) [30].

Many algorithms improve the Bron-Kerbosch algorithm by proposing effective search space pruning techniques. D2K [13] proposes a simple pivoting technique to cut useless branches, which generalizes the pivoting technique for maximal clique finding. FaPlexen [33] proposes the pivoting technique that finds $v_p \in P$ and uses Eq (5)–Eq (7) for branching, and found that it competes favorably with D2K. FP [14] adopts a pivoting technique most similar to ours, but it does not prioritize P over C as in our Algorithm 3 Lines 9–10 to maximize the number of saturated vertices in P (to minimize $|C|$). Moreover, while FP uses upper-bound-based pruning, it starts branch-and-bound search over each seed graph G_i from v_i (with C including second-hop neighbors) rather than from $S \cup \{v_i\}$ for $S \subseteq N_{G_i}^2(v_i)$ (with C including only direct neighbors of v_i), so the branch-and-bound procedure is called for $O(\gamma_k^{|C|}) \leq O(\gamma_k^n)$ times rather than $O(\gamma_k^D)$ times as in our case. ListPlex [25] adopts the sub-tasking scheme similar to ours, but it uses the less effective pivoting and branching scheme of FaPlexen [33] and does not apply effective pruning techniques by vertex pairs such as our Theorems 9, 10 and 11.

Maximum k -Plex Finding. Conte et al. [12] notice that any node of a k -plex P with $|P| \geq q$ is included in a clique of size at least $\lceil q/k \rceil$, which is used to prune invalid nodes. However, it is necessary to enumerate all maximal cliques which is expensive per se. To find a maximum k -plex, [12] uses binary search to guess the maximum k -plex size for vertex pruning, and then mines k -plexes on the pruned graph to see if such a maximum k -plex can be found, and if not, the maximum k -plex size threshold is properly adjusted for another round of search. However, this approach may fail for multiple iterations before finding a maximum k -plex, so is less efficient than the branch-and-bound algorithms. BS [28]

pioneers a number of pruning techniques in the branch-and-bound framework for finding a maximum k -plex, including one that uses pivot $v_p \in P$ and Eq (5)–Eq (7) for branching.

For maximum k -plex finding, if the current maximum k -plex found is P , then we can prune any branch that cannot generate a k -plex with at least $|P| + 1$ vertices (i.e., upper bound $\leq |P| + 1$). BnB [15] proposes upper bounds and pruning techniques based on deep structural analysis, KpLeX [18] proposes an upper bound based on vertex partitioning, and Maplex [32] proposes an upper bound based on graph coloring which is later improved by RGB [31]. kPlexS [11] proposes a CTCP technique to prune the vertices and edges using the second-order property as established by our Theorem 4, and it shows that the reduced graph by CTCP is guaranteed to be no larger than that computed by BnB, Maplex and KpLeX. kPlexS also proposed new techniques for branching and pruning specific to maximum k -plex finding, and outperforms BnB, Maplex and KpLeX. Yu and Long [29] proposed a branch-and-bound algorithm for finding a maximum k -biplex (one with the most edges) in a bipartite graph.

VIII. CONCLUSION

In this paper, we proposed an efficient branch-and-bound algorithm to enumerate all maximal k -plexes with at least q vertices. Our algorithm adopts an effective search space partitioning approach that provides a good time complexity, a new pivot vertex selection method that reduces candidate size, an effective upper-bounding technique to prune useless branches, and three novel pruning techniques by vertex pairs. Our parallel algorithm version uses a timeout mechanism to eliminate straggler tasks. Extensive experiments show that our algorithms compare favorably compared with the state-of-the-art algorithms, and the performance of our parallel algorithm version scales nearly ideally with the number of threads.

REFERENCES

- [1] Laboratory for Web Algorithmics (LAW). <https://law.di.unimi.it/datasets.php>.
- [2] Online Appendices. <https://github.com/chengqihao/Maximal-kPlex/blob/main/OnlineAppendix.pdf>.
- [3] SNAP Datasets: Stanford Large Network Dataset Collection. <http://snap.stanford.edu/data>.
- [4] G. D. Bader and C. W. Hogue. An automated method for finding molecular complexes in large protein interaction networks. *BMC bioinformatics*, 4(1):2, 2003.
- [5] B. Balasundaram, S. Butenko, and I. V. Hicks. Clique relaxations in social network analysis: The maximum k -plex problem. *Oper. Res.*, 59(1):133–142, 2011.
- [6] V. Batagelj and M. Zaversnik. An $o(m)$ algorithm for cores decomposition of networks. *CoRR*, cs.DS/0310049, 2003.
- [7] D. Berlowitz, S. Cohen, and B. Kimelfeld. Efficient enumeration of maximal k -plexes. In *SIGMOD*, pages 431–444. ACM, 2015.
- [8] P. Boldi and S. Vigna. The WebGraph framework I: Compression techniques. In *WWW*, pages 595–601. ACM, 2004.
- [9] C. Bron and J. Kerbosch. Finding all cliques of an undirected graph (algorithm 457). *Commun. ACM*, 16(9):575–576, 1973.
- [10] D. Bu, Y. Zhao, L. Cai, H. Xue, X. Zhu, H. Lu, J. Zhang, S. Sun, L. Ling, N. Zhang, et al. Topological structure analysis of the protein-protein interaction network in budding yeast. *Nucleic acids research*, 31(9):2443–2450, 2003.
- [11] L. Chang, M. Xu, and D. Strash. Efficient maximum k -plex computation over large sparse graphs. *Proc. VLDB Endow.*, 16(2):127–139, 2022.
- [12] A. Conte, D. Firmani, C. Mordente, M. Patrignani, and R. Torlone. Fast enumeration of large k -plexes. In *KDD*, pages 115–124. ACM, 2017.
- [13] A. Conte, T. D. Matteis, D. D. Sensi, R. Grossi, A. Marino, and L. Versari. D2K: scalable community detection in massive networks via small-diameter k -plexes. In *KDD*, pages 1272–1281. ACM, 2018.
- [14] Q. Dai, R. Li, H. Qin, M. Liao, and G. Wang. Scaling up maximal k -plex enumeration. In *CIKM*, pages 345–354. ACM, 2022.
- [15] J. Gao, J. Chen, M. Yin, R. Chen, and Y. Wang. An exact algorithm for maximum k -plexes in massive graphs. In *Proceedings of the Twenty-Seventh International Joint Conference on Artificial Intelligence, IJCAI 2018, July 13-19, 2018, Stockholm, Sweden*, pages 1449–1455. ijcai.org, 2018.
- [16] J. Hopcroft, O. Khan, B. Kulis, and B. Selman. Tracking evolving communities in large linked networks. *Proceedings of the National Academy of Sciences*, 101(suppl 1):5249–5253, 2004.
- [17] H. Hu, X. Yan, Y. Huang, J. Han, and X. J. Zhou. Mining coherent dense subgraphs across massive biological networks for functional discovery. *Bioinformatics*, 21(suppl_1):i213–i221, 2005.
- [18] H. Jiang, D. Zhu, Z. Xie, S. Yao, and Z. Fu. A new upper bound based on vertex partitioning for the maximum k -plex problem. In *IJCAI*, pages 1689–1696. ijcai.org, 2021.
- [19] J. M. Lewis and M. Yannakakis. The node-deletion problem for hereditary properties is np-complete. *J. Comput. Syst. Sci.*, 20(2):219–230, 1980.
- [20] J. Li, X. Wang, and Y. Cui. Uncovering the overlapping community structure of complex networks by maximal cliques. *Physica A: Statistical Mechanics and its Applications*, 415:398–406, 2014.
- [21] S. B. Seidman and B. L. Foster. A graph-theoretic generalization of the clique concept. *Journal of Mathematical sociology*, 6(1):139–154, 1978.
- [22] S. Sheng, B. Wardman, G. Warner, L. Cranor, J. Hong, and C. Zhang. An empirical analysis of phishing blacklists. In *6th Conference on Email and Anti-Spam (CEAS)*. Carnegie Mellon University, 2009.
- [23] B. K. Tanner, G. Warner, H. Stern, and S. Olechowski. Koobface: The evolution of the social botnet. In *eCrime*, pages 1–10. IEEE, 2010.
- [24] D. Ucar, S. Asur, U. Catalyurek, and S. Parthasarathy. Improving functional modularity in protein-protein interactions graphs using hub-induced subgraphs. In *European Conference on Principles of Data Mining and Knowledge Discovery*, pages 371–382. Springer, 2006.
- [25] Z. Wang, Y. Zhou, M. Xiao, and B. Khoussainov. Listing maximal k -plexes in large real-world graphs. In *WWW*, pages 1517–1527. ACM, 2022.
- [26] C. Wei, A. Sprague, G. Warner, and A. Skjellum. Mining spam email to identify common origins for forensic application. In R. L. Wainwright and H. Haddad, editors, *ACM Symposium on Applied Computing*, pages 1433–1437. ACM, 2008.
- [27] D. Weiss and G. Warner. Tracking criminals on facebook: A case study from a digital forensics reu program. In *Proceedings of Annual ADFSL Conference on Digital Forensics, Security and Law*, 2015.
- [28] M. Xiao, W. Lin, Y. Dai, and Y. Zeng. A fast algorithm to compute maximum k -plexes in social network analysis. In *AAAI*, pages 919–925. AAAI Press, 2017.
- [29] K. Yu and C. Long. Maximum k -biplex search on bipartite graphs: A symmetric-bk branching approach. *Proc. ACM Manag. Data*, 1(1):49:1–49:26, 2023.
- [30] K. Yu, C. Long, S. Liu, and D. Yan. Efficient algorithms for maximal k -biplex enumeration. In *SIGMOD*, pages 860–873. ACM, 2022.
- [31] J. Zheng, M. Jin, Y. Jin, and K. He. Relaxed graph color bound for the maximum k -plex problem. *CoRR*, abs/2301.07300, 2023.
- [32] Y. Zhou, S. Hu, M. Xiao, and Z. Fu. Improving maximum k -plex solver via second-order reduction and graph color bounding. In *AAAI*, pages 12453–12460. AAAI Press, 2021.
- [33] Y. Zhou, J. Xu, Z. Guo, M. Xiao, and Y. Jin. Enumerating maximal k -plexes with worst-case time guarantee. In *AAAI*, pages 2442–2449. AAAI Press, 2020.

A. Proof of Theorem 4

Proof. This can be seen from Figure 9. Let us first define $\overline{N}_P^*(v) = \overline{N}_P(v) - \{v\}$, so $|\overline{N}_P^*(v)| \leq k - 1$. In Case (i) where $(u, v) \notin E$, any vertex $w \in P$ can only fall in the following 3 scenarios: (1) $w \in \overline{N}_P^*(u)$, (2) $w \in \overline{N}_P^*(v)$, and (3) $w \in N_P(u) \cap N_P(v)$. Note that w may be in both (1) and (2). So we have:

$$\begin{aligned} |P| &= |N_P(u) \cap N_P(v)| + |\overline{N}_P^*(u) \cup \overline{N}_P^*(v)| \\ &\leq |N_P(u) \cap N_P(v)| + |\overline{N}_P^*(u)| + |\overline{N}_P^*(v)| \\ &\leq |N_P(u) \cap N_P(v)| + 2(k - 1) \\ &= |N_P(u) \cap N_P(v)| + 2k - 2, \end{aligned}$$

so $|N_P(u) \cap N_P(v)| \geq |P| - 2k + 2 \geq q - 2k + 2$.

In Case (ii) where $(u, v) \in E$, any vertex $w \in P$ can only be in one of the following 4 scenarios: (1) $w = u$, (2) $w = v$, (3) $w \in N_P(u) \cap N_P(v)$, and (4) $w \in \overline{N}_P(u) \cup \overline{N}_P(v)$, so:

$$\begin{aligned} |P| &= 2 + |N_P(u) \cap N_P(v)| + |\overline{N}_P^*(u) \cup \overline{N}_P^*(v)| \\ &\leq 2 + |N_P(u) \cap N_P(v)| + |\overline{N}_P^*(u)| + |\overline{N}_P^*(v)| \\ &\leq 2 + |N_P(u) \cap N_P(v)| + 2(k - 1) \\ &= |N_P(u) \cap N_P(v)| + 2k, \end{aligned}$$

so $|N_P(u) \cap N_P(v)| \geq |P| - 2k \geq q - 2k$. \square

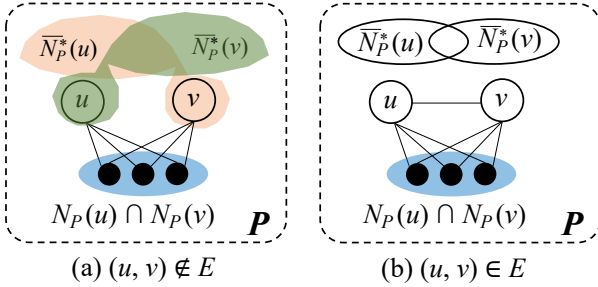

Fig. 9. Second-Order Pruning

B. Proof of Theorem 6

Proof. We prove by contradiction. Assume that there exists $K' = P_m \cap N_C(v_p)$ with $|K'| > |K|$. Also, let us denote by $\psi = \{w_1, w_2, \dots, w_\ell\}$ the vertex ordering of $w \in N_C(v_p)$ in Line 5 to create K , as illustrated in Figure 10.

Specifically, Figure 10 top illustrates the execution flow of Lines 4–8 in Algorithm 3, where w_1, w_3 and w_4 select their non-neighbor u_1 as u_m in Line 5, w_2 and w_5 select u_2 as u_m , and w_6 selects u_3 as u_m . We define $\{w_1, w_3, w_4\}$ as u_1 -group, $\{w_2, w_5\}$ as u_2 -group, and $\{w_6\}$ as u_3 -group.

Let us consider the update of $\text{sup}_P(u_1)$, whose initial value computed by Line 2 is assumed to be 2. When processing w_1 , Line 7 decrements $\text{sup}_P(u_1)$ as 1. Then, w_3 decrements it as 0. When processing w_4 , since Line 4 already finds that $\text{sup}_P(u_1) = 0$, w_4 is excluded from K (i.e., Line 8 does not add it to ub). In a similar spirit, $w_5 \notin K$ since $\text{sup}_P(u_2) = 0$, and $w_6 \notin K$ since $\text{sup}_P(u_3) = 0$.

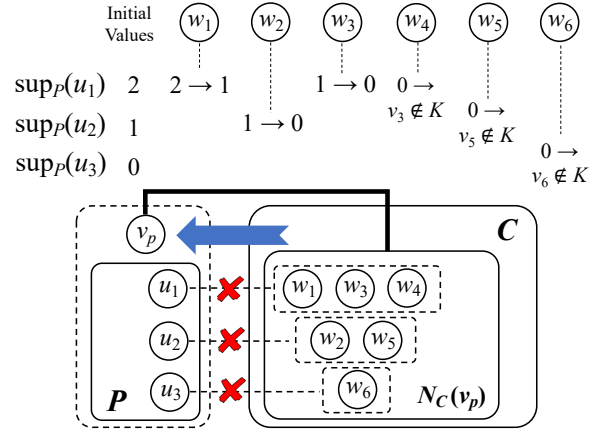

Fig. 10. Illustration of the Proof of Theorem 6

Note that since w_1, w_3 and w_4 cannot co-exist in a k -plex containing $P \cup \{v_p\}$, they cannot all belong to K' . In other words, if $w_4 \notin K$ belongs to K' , then at least one of w_1 and w_3 is not in K' . In a similar spirit, if $w_5 \notin K$ belongs to K' , then $w_2 \notin K'$. As for those u_i whose initial value of $\text{sup}_P(u_i)$ is 0, we can show that any element in u_i -group can belong to neither K nor K' . See u_3 -group = $\{w_6\}$ in Figure 10 for example. This is because if w is added to P , then $\overline{d}_P(u_i) > k$ so P cannot be a k -plex. \square

In general, in each u_i -group where $\text{sup}_P(u_i) \neq 0$, if a vertex $w \in K' - K$ exists (e.g., w_4 in Figure 10), then there must exist a different vertex $w' \in K - K'$ in the u_i -group (e.g., w_1 or w_3). This implies that $|K - K'| \geq |K' - K|$.

Therefore, we have

$$\begin{aligned} |K| &= |K - K'| + |K \cap K'| \\ &\geq |K' - K| + |K \cap K'| = |K'|, \end{aligned}$$

which contradicts with our assumption $|K'| > |K|$. \square

C. Proof of Lemma 1

Proof. To implement Algorithm 4, given a seed graph $G_i = (V_i, E_i)$, we maintain $d_P(v)$ for every $v \in V_i$. These degrees $d_P(\cdot)$ are incrementally updated; for example, when a vertex v_p is moved into P , we will increment $\overline{d}_P(v)$ for every $v \in N_{G_i}(v_p)$. As a result, we can compute $\overline{d}_P(v) = |P| - d_P(v)$ and $\text{sup}_P(v) = k - \overline{d}_P(v)$ in $O(1)$ time.

Moreover, we materialize $\text{sup}_P(u)$ for each vertex $u \in P$ in Line 2, so that in Line 5 we can access them directly to compute u_m , and Line 7 can be updated in $O(1)$ time.

Since P is a k -plex of G_i , $|P|$ is bounded by $O(D + k)$ by Theorem 5. Thus, Line 2 takes $O(D + k)$ time.

Also, $|N_C(v_p)|$ is bounded by $O(D)$ since $N_C(v_p) \subseteq C_S = N_{G_i}(v_i)$, so the for-loop in Line 4 is executed for $O(D)$ iterations. In each iteration, Line 5 takes $O(k)$ time since $|\overline{N}_P(w)| \leq k$, so the entire for-loop in Line 4–8 takes $O(kD)$.

Putting them together, the time complexity of Algorithm 4 is $O(D + k) + O(kD) = O(k + (k + 1)D) \approx O(D)$ as k is usually very small constant. \square

D. Proof of Lemma 2

Proof. Since $\eta = \{v_1, \dots, v_n\}$ is the degeneracy ordering of V and $V_i \subseteq \{v_i, v_{i+1}, \dots, v_n\}$, we have $d_{G_i}(v_i) = |N_{G_i}(v_i)| \leq D$.

To show that $|N_{G_i}^2(v_i)| = O\left(\frac{D\Delta}{q-2k+2}\right)$, consider $E^* = \{(v, u) \mid v \in N_{G_i}(v_i) \wedge u \in N_{G_i}^2(v_i)\}$, which are those edges between $N_{G_i}(v_i)$ and $N_{G_i}^2(v_i)$ in Figure 2. Since $|N_{G_i}(v_i)| \leq D$, and each $v \in N_{G_i}(v_i)$ has at most Δ neighbors in $N_{G_i}^2(v_i)$, we have $|E^*| \leq D\Delta$. Also, let us denote by E' all those edges $(v, u) \in E^*$ that are valid (i.e., v and u can appear in a k -plex P in G_i with $|P| \geq q$), then $|E'| \leq |E^*| \leq D\Delta$.

Recall from Corollary 1 that if $u \in N_{G_i}^2(v_i)$ belongs to a valid k -plex in G_i , then $|N_{G_i}(u) \cap N_{G_i}(v_i)| \geq q - 2k + 2$. This means that each valid $u \in N_{G_i}^2(v_i)$ share with v_i at least $(q - 2k + 2)$ common neighbors that are in $N_{G_i}(v_i)$ (c.f., Figure 2), or equivalently, u is adjacent to (or, uses) at least $(q - 2k + 2)$ edges (v, u) in E' . Therefore, the number of valid $u \in N_{G_i}^2(v_i)$ is bounded by $\frac{|E'|}{q-2k+2} \leq \frac{D\Delta}{q-2k+2}$.

It may occur that $\frac{D\Delta}{q-2k+2} > n$, in which case we use $|N_{G_i}^2(v_i)| = O(n)$ instead. Combining the above two cases, we have $|N_{G_i}^2(v_i)| = O(r_1)$ where $r_1 = \min\left\{\frac{D\Delta}{q-2k+2}, n\right\}$.

Finally, the number of subsets $S \subseteq N_{G_i}^2(v_i)$ ($|S| \leq k - 1$) (c.f., Line 7 of Algorithm 2) is bounded by $C_{r_1}^0 + C_{r_1}^1 + \dots + C_{r_1}^{k-1} \approx O(r_1^k)$, since k is a small constant. \square

E. Proof of Theorem 8

Proof. We just showed that the recursive body of Branch(.) takes time $O(|P|(|C| + |X|))$. Let us first bound $|X|$. Recall Algorithm 2, where by Line 9, vertices of $X \subseteq X_S$ are from either V'_i or $(N_{G_i}^2(v_i) - S)$. Moreover, by Line 5, vertices of V'_i are from either $N_G(v_i)$ or $N_G^2(v_i)$. Since $(N_{G_i}^2(v_i) - S) \subseteq N_G^2(v_i)$, vertices of X are from either $N_G(v_i)$ or $N_G^2(v_i)$. Let us denote $X_1 = X \cap N_G(v_i)$ and $X_2 = X \cap N_G^2(v_i)$.

We first bound X_2 . Consider $E^* = \{(u, v) \mid u \in N_G(v_i) \wedge v \in X_2\}$. Since $|N_G(v_i)| \leq \Delta$, and each $v \in N_G(v_i)$ has at most Δ neighbors in $N_G^2(v_i)$, we have $|E^*| \leq \Delta^2$. Recall from Theorem 4 that if $v \in X_2$ belongs to k -plex P with $|P| \geq q$, then $|N_G(v) \cap N_G(v_i)| \geq q - 2k + 2$. This means that each $v \in X_2$ share with v_i at least $(q - 2k + 2)$ common neighbors that are in $N_G(v_i)$, or equivalently, v is adjacent to (or, uses) at least $(q - 2k + 2)$ edges (u, v) in E^* . Therefore, the number of $v \in X_2$ is bounded by $\frac{|E^*|}{q-2k+2} \leq \frac{\Delta^2}{q-2k+2}$.

As for $X_1 \subseteq N_G(v_i)$, we have $|X_1| \leq \Delta$. In general, we do not set q to be too large in reality, or there would be no results, so $(q - 2k + 2)$ is often much smaller than Δ . Therefore, $|X| = |X_1| + |X_2| = O\left(\frac{\Delta^2}{q-2k+2} + \Delta\right) \approx O\left(\frac{\Delta^2}{q-2k+2}\right)$.

Since $|P|$ is bounded by $O(D + k) \approx O(D)$ by Theorem 5, and $C \subseteq C_S$ so $|C| \leq D$, the recursive body of Branch(.) takes $O(|P|(|C| + |X|)) \approx O\left(D(D + \frac{\Delta^2}{q-2k+2})\right) \approx O\left(\frac{D\Delta^2}{q-2k+2}\right)$ time. This is because $\frac{\Delta^2}{q-2k+2} > \Delta \geq D$.

It may occur that $\frac{\Delta^2}{q-2k+2} > n$, in which case we use $|X| = O(n)$ instead, so the recursive body of Branch(.) takes $O(|P|(|C| + |X|)) \approx O(D(D + n)) = O(nD)$ time.

Combining the above two cases, the recursive body of Branch(.) takes $O(r_2)$ time where $r_2 = \min\left\{\frac{D\Delta^2}{q-2k+2}, nD\right\}$.

By Lemma 3, Branch(G_i, k, q, P_S, C_S, X_S) in Line 10 of Algorithm 2 recursively calls the body of Algorithm 4 for $O(\gamma_k^D)$ times, so the total time is $O(r_2\gamma_k^D)$.

Finally, we have at most $O(n)$ initial task groups (c.f., Line 3 of Algorithm 2), and by Lemma 2, each initial task group with seed vertex v_i generates $O(r_1^k)$ sub-tasks that call Branch(G_i, k, q, P_S, C_S, X_S). So, the total time cost of Algorithm 2 is $O(nr_1^k r_2 \gamma_k^D)$. \square

F. Proof of Theorem 10

Proof. Assume that $u_1 \in N_{G_i}^2(v_i)$ and $u_2 \in N_{G_i}(v_i)$ co-occur in a k -plex P with $|P| \geq q$. Let us assume $u_1 \in S$ and $P^+ = P_S \cup \{u_2\}$, then $P^+ \subseteq P$. As the proof of Theorem 9 has shown, we have $|P_S| \leq k$, so $|P^+| \leq k + 1$.

Applying Eq (4) in Lemma 4 with $P = P^+$, $u = u_1$ and $v = u_2$, we require

$$|P^+| + \sup_{P^+}(u_1) + \sup_{P^+}(u_2) + |N_{C_S^-}(u_1) \cap N_{C_S^-}(u_2)| \geq q,$$

or equivalently (recall that $|P^+| \leq k + 1$),

$$|N_{C_S^-}(u_1) \cap N_{C_S^-}(u_2)| \geq q - (k + 1) - \sup_{P^+}(u_1) - \sup_{P^+}(u_2).$$

If $(u_1, u_2) \in E_i$, then $\sup_{P^+}(u_1) \leq k - 2$ since $v_i \in P_S$ is a non-neighbor of u_1 besides u_1 itself in P_S , and $\sup_{P^+}(u_2) \leq k - 1$ since u_2 is a non-neighbor of itself in P_S . Thus,

$$\begin{aligned} |N_{C_S^-}(u_1) \cap N_{C_S^-}(u_2)| &\geq q - (k + 1) - \max\{k - 2, 0\} \\ &\quad - (k - 1) \\ &= q - 2k - \max\{k - 2, 0\} \end{aligned}$$

While if $(u_1, u_2) \notin E_i$, then $\sup_{P^+}(u_1) \leq k - 3$ since $v_i \in P_S$ is a non-neighbor of u_1 besides $u_1, u_2 \in P^+$, and $\sup_{P^+}(u_2) \leq k - 2$ since $u_1, u_2 \subseteq P^+$ are the non-neighbors of u_2 . Thus, we have

$$\begin{aligned} |N_{C_S^-}(u_1) \cap N_{C_S^-}(u_2)| &\geq q - (k + 1) - \max\{k - 2, 0\} \\ &\quad - \max\{k - 3, 0\} \\ &= q - k - \max\{k - 2, 0\} \\ &\quad - \max\{k - 2, 1\} \end{aligned}$$

This completes our proof of Theorem 10. \square

G. Proof of Theorem 11

Proof. Assume that $u_1, u_2 \in N_{G_i}(v_i)$ co-occur in a k -plex P with $|P| \geq q$. Let us define $P^+ = P_S \cup \{u_1, u_2\}$, then $P^+ \subseteq P$. As the proof of Theorem 9 has shown, we have $|P_S| \leq k$, so $|P^+| \leq k + 2$.

Applying Eq (4) in Lemma 4 with $P = P^+$, $u = u_1$ and $v = u_2$, we require

$$|P^+| + \sup_{P^+}(u_1) + \sup_{P^+}(u_2) + |N_{C_S^-}(u_1) \cap N_{C_S^-}(u_2)| \geq q,$$

or equivalently (recall that $|P^+| \leq k + 2$),

$$|N_{C_S^-}(u_1) \cap N_{C_S^-}(u_2)| \geq q - (k + 2) - \sup_{P^+}(u_1) - \sup_{P^+}(u_2).$$

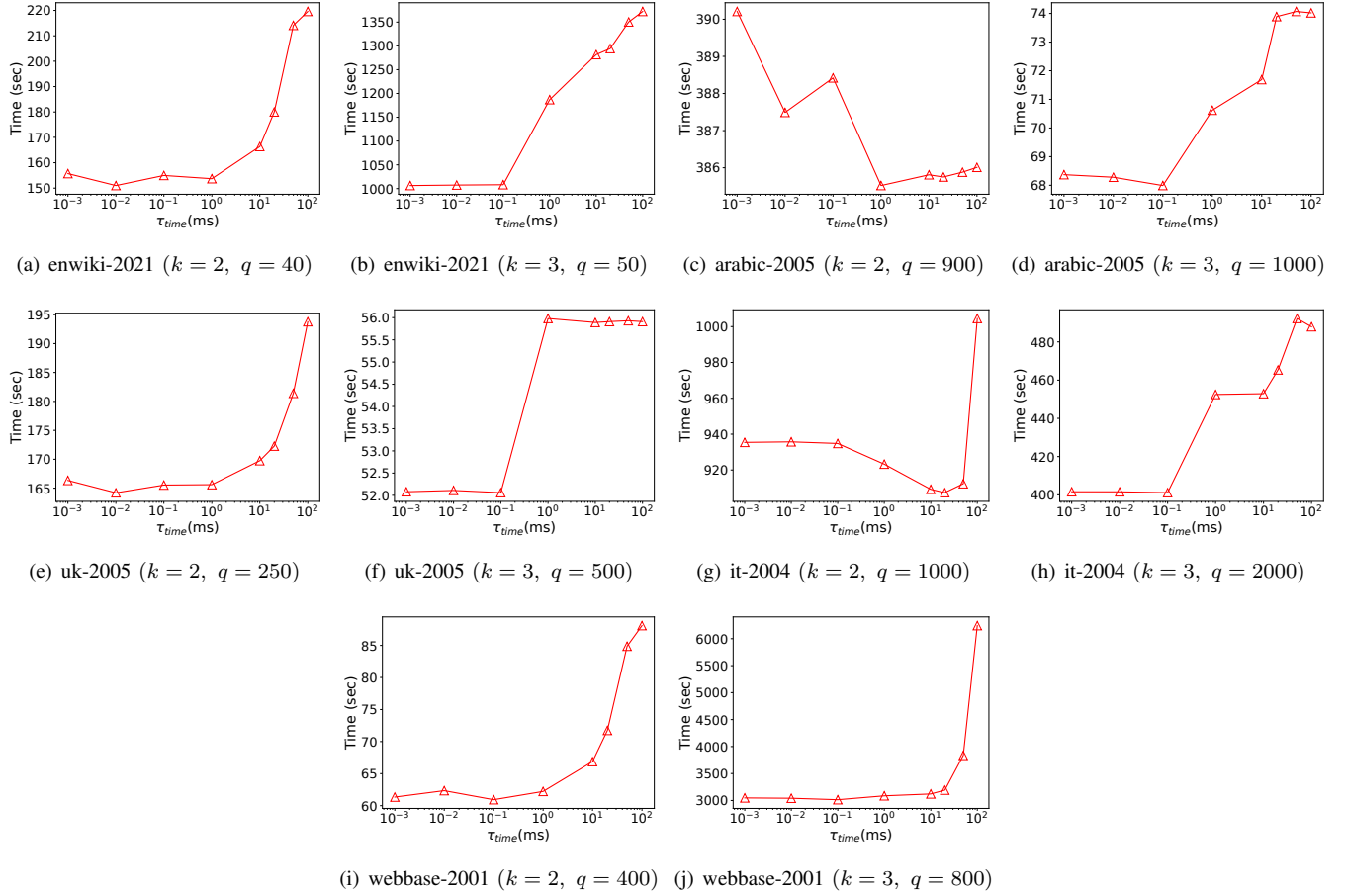

Fig. 11. The Running Time (sec) of Parallel Ours with Different τ_{time} on Five Large Datasets

If $(u_1, u_2) \in E_i$, then $\sup_{P^+}(u_1) \leq k - 1$ (resp. $\sup_{P^+}(u_2) \leq k - 1$), since u_1 (resp. u_2) is a non-neighbor of itself in P^+ . Thus,

$$|N_{C_S^-}(u_1) \cap N_{C_S^-}(u_2)| \geq q - (k + 2) - 2 \cdot (k - 1) = q - 3k.$$

While if $(v_1, v_2) \notin E_i$, then $\sup_{P^+}(u_1) \leq k - 2$ (resp. $\sup_{P^+}(u_2) \leq k - 2$), since u_1 (resp. u_2) is a non-neighbor of $u_1, u_2 \in P^+$. Thus,

$$\begin{aligned} |N_{C_S^-}(u_1) \cap N_{C_S^-}(u_2)| &\geq q - (k + 2) - 2 \cdot \max\{k - 2, 0\} \\ &= q - k - 2 \cdot \max\{k - 1, 1\}. \end{aligned}$$

This completes our proof of Theorem 11. \square

H. Effect of τ_{time}

We vary τ_{time} from 10^{-3} to 100 and evaluate the running time of our parallel algorithm on five large datasets with the same parameters as Table III. The results are shown in Figure 11, where we can see that an inappropriate parameter τ_{time} (e.g., one that is very long) can lead to a very slow performance. Note that without the timeout mechanism (as is the case in ListPlex and Ours), we are basically setting $\tau_{time} = \infty$ so the running time is expected to be longer (e.g., than when $\tau_{time} = 100$) due to poor load balancing.