

HotRAP: Hot Record Retention and Promotion for LSM-trees with Tiered Storage

Jiansheng Qiu
Tsinghua University
China

qjc21@mails.tsinghua.edu.cn

Mingyu Gao
Tsinghua University
China

gaomy@tsinghua.edu.cn

Fangzhou Yuan
Tsinghua University
China

yfz23@mails.tsinghua.edu.cn

Huanchen Zhang
Tsinghua University
China

huanchen@tsinghua.edu.cn

Abstract

The multi-level design of Log-Structured Merge-trees (LSM-trees) naturally fits the tiered storage architecture: the upper levels (recently inserted/updated records) are kept in fast storage to guarantee performance while the lower levels (the majority of records) are placed in slower but cheaper storage to reduce cost. However, frequently accessed records may have been compacted and reside in slow storage, and existing algorithms are inefficient in promoting these “hot” records to fast storage, leading to compromised read performance. We present HotRAP, a key-value store based on RocksDB that can timely promote hot records individually from slow to fast storage and keep them in fast storage while they are hot. HotRAP uses an on-disk data structure (a specially-made LSM-tree) to track the hotness of keys and includes three pathways to ensure that hot records reach fast storage with short delays. Our experiments show that HotRAP outperforms state-of-the-art LSM-trees on tiered storage by up to 5.6× compared to the second best under read-only and read-write-balanced YCSB workloads with common access skew patterns, and by up to 2.0× compared to the second best under Twitter production workloads.

1 Introduction

Log-Structured Merge-trees (LSM-trees) [18, 29] are widely adopted to build key-value stores [6, 12, 16, 25] and database storage engines [1, 2, 17, 19, 22] because of their superior write performance. To achieve better cost efficiency, systems tend to leverage the tiered storage by locating the upper levels of the LSM-tree in fast local solid-state drives (SSDs) while storing the lower levels (i.e., the majority of the records) in slower but cheaper cloud storage or hard disk drives (HDDs). Such a storage-tier separation is inherently efficient for the write operations (i.e., inserts, updates, deletes) because the append-only nature of the LSM-tree keeps the most recent writes automatically in the fast storage. However, although in typical workloads the records that are frequently accessed are often correlated with those that are frequently updated, the “read-hot” set and the “write-hot” set may not always fully overlap. This leads to a majority of the read-hot records sitting in slow storage with higher latency and lower bandwidth, thus compromising the read performance of the LSM-tree.

The problem can be mitigated by caching frequently accessed records in memory, and prior studies have proposed numerous caching algorithms [32, 33, 35, 39, 43]. However, memory is often

a limiting resource for systems [23, 37, 38], and the size of the hot records can be far larger than the memory capacity (limitation 1). RocksDB, therefore, introduces the secondary cache on fast SSDs for caching recently-accessed data blocks [27, 41]. Solutions such as Mutant [36], LogStore [24], and MirrorKV [31] propose to adjust the placement of blocks/SSTables across the storage tiers periodically according to their access frequencies. These approaches, nonetheless, cannot fully leverage the capacity of the expensive fast storage because they move data at a coarse granularity, where many cold records in the identified hot blocks/SSTables are altogether piggybacked to the fast storage (limitation 2). Moreover, the above solutions can only promote hot data to the fast storage through the LSM-tree compaction. To deal with read-heavy workloads where compactions happen infrequently, several systems [24, 30] allow triggering compactions proactively, but they must wait for the hot records to accumulate in the slow storage before promoting them. Such a promotion delay harms read performance because it could overstep the time window when a record is still hot (limitation 3).

In this paper, we present HotRAP (Hot record Retention And Promotion), an LSM-tree design based on RocksDB on tiered storage. HotRAP can promote hot records timely from the slow disk (abbr. as *SD* hereafter) to the fast disk (abbr. as *FD* hereafter), and retain them in *FD* as long as they stay hot. HotRAP addresses the aforementioned three limitations of previous solutions. Figure 1 shows the big picture of HotRAP.

First, instead of tracking the record hotness in memory, HotRAP logs each record access in a small specially-made LSM-tree, called *RALT* (Recent Access Lookup Table), located in *FD* (addressing limitation 1). *RALT* tracks the access history for each logged key and maintains a hotness score for the key using exponential smoothing. *RALT* then evicts low-score keys periodically from itself to stay under a size limit that can be automatically tuned according to the workload. We choose LSM-tree to implement *RALT* in order to benefit from its low write latency on disks because inserting access records to it is on the critical path of lookups.

By utilizing *RALT*, HotRAP also supports hot record retention and promotion at the *record level* rather than at the block/SSTable level, thus preventing cold records from being piggybacked to *FD* (addressing limitation 2). Also, besides waiting for LSM-tree compactions to retain/promote hot records, HotRAP introduces a small in-memory *promotion cache* that logs each access to *SD* and timely

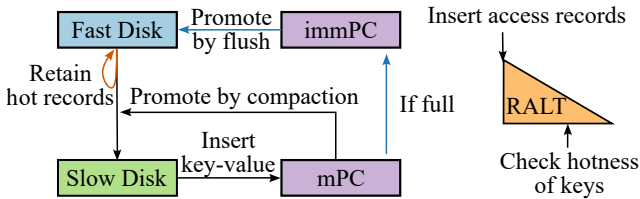

Figure 1: The high-level picture of HotRAP. RALT is a small LSM-tree in the fast disk that tracks the hotness of keys. *mPC* and *immPC* stand for the mutable and immutable promotion caches. Hot records are retained in the fast disk during compactions. Records accessed in the slow disk are inserted into the promotion cache and then promoted by compaction or flush if they are hot.

promotes the hot records (via checking RALT) by flushing them to the top of the data LSM-tree (addressing limitation 3).

More specifically, HotRAP provides the following three pathways for hot records to reside in FD: retention, promotion by compaction, and promotion by flush. First, when the normal LSM-tree compaction moves records from FD to SD, HotRAP checks the hotness of each record in the selected SSTable in FD, and the hot records are written back to FD instead of merged down to SD, i.e., *retention*. Second, the in-memory mutable promotion cache in HotRAP is used to cache the accessed records in SD. When the above compaction from FD to SD happens, HotRAP also checks the hotness of the records in the mutable promotion cache that are within the compaction key range, and similarly handle these records, writing the hot ones to FD and compacting the others to SD. We call this path as *promotion by compaction*. Both the hotness checks in these two paths are facilitated by RALT and can be efficiently performed mainly with sequential scans of corresponding key ranges. Third, in the case of insufficient LSM-tree compactions, the mutable promotion cache may grow too big, so we turn it into an immutable promotion cache, and HotRAP triggers *promotion by flush* to bulk-insert the hot records in the immutable promotion cache (also identified via consulting RALT) to L_0 of the LSM-tree. Thus we effectively restrict the size of the promotion cache. To prevent promotion by flush from overwriting records with a newer version (i.e., promoting a stale record to L_0 that has a higher level than the newly updated version), we perform extra checks and carry out a concurrency control mechanism to guarantee correctness.

We evaluated HotRAP using YCSB-based workloads and Twitter production traces [34] on AWS instances with fast local NVMe SSDs and slower cloud storage. We compare HotRAP to the state-of-the-art LSM-trees on tiered storage, e.g., SAS-Cache [41] (based on RocksDB with secondary cache [27]), Mutant [36] (promoting at the block/SSTable level), and PrismDB [30] (proactively triggering compactions). HotRAP achieves 5.6 \times speedup over the second best for read-only YCSB workloads, 3.7 \times for read-write-balanced YCSB workloads, and 2.0 \times for Twitter production workloads, while maintaining competitive performance for write-heavy and update-heavy YCSB workloads. Our experiments also show that HotRAP adds < 2% overhead to the plain RocksDB under uniform workloads and is robust against hotspot shifts, where RALT quickly evicts stale access records and adds keys in the new hotspot into the hot set.

We make three primary contributions in this paper. First, we propose an on-disk data structure (i.e., RALT, a specially-made LSM-tree) for tracking the hotness of key-value records. Second, we design three pathways in a tiered LSM-tree for timely promoting/retaining hot records to/in fast storage. Our algorithm operates at the record level so that the system can efficiently utilize the limited space of the fast storage. Finally, we implement HotRAP, a key-value store based on RocksDB that outperforms state-of-the-art LSM-trees on tiered storage because of its efficient hot record tracking and movement features.

2 Background & Related Work

2.1 LSM-trees and tiered storage

A Log-Structured Merge-tree (LSM-tree) consists of an in-memory buffer (i.e., MemTable) and multiple levels L_0, \dots, L_n on disk. The capacity of level L_i is made T times larger than L_{i-1} , where T is called the size ratio of the LSM-tree. Records are first inserted into MemTable. When MemTable is full, it becomes immutable and then flushed to L_0 as an SSTable (i.e., a file format called Sorted String Table). When level L_{i-1} reaches its capacity, it will trigger the compaction process to merge its content into the next level L_i . There are typically two kinds of compaction policies: leveling and tiering. Leveling only allows one sorted run per level while tiering allows multiple. This paper focuses on the leveling policy because it is RocksDB’s default choice [25]. RocksDB also adopts partial compaction: each compaction picks an SSTables from L_{i-1} whose key range overlaps with a minimal number of SSTables in L_i to merge to the next level. Such a compaction strategy leads to a write amplification of $\approx \frac{T}{2}(n-1)$ [11].

A lookup first checks the MemTable and then searches the levels from top to bottom until a matching key is found. A block index in memory is used to determine which SSTable data block to search for a particular key in a sorted run. Per-SSTable Bloom filters are used to reduce the number of candidate SSTables to further save I/Os. RocksDB provides snapshot isolation via multiversion concurrency control (MVCC) to prevent compactions from blocking normal read operations. A snapshot in RocksDB, called a supervision, is created after a flush or a compaction completes. An old snapshot is garbage collected when none of the active queries refer to it.

Although many LSM-trees such as RocksDB are initially designed for local SSDs, the multi-level nature of LSM-trees is a good fit for the tiered storage architecture. The upper levels contain the recently inserted and updated records and are therefore kept in the fast storage such as local SSDs because they are more likely to be accessed in the near future. To improve the system’s cost efficiency, the majority of records in the lower levels are placed in HDDs [13, 14] or low-tier cloud storage based on HDDs [15]. HDDs exhibit higher latency and lower bandwidth than SSDs, but they are much cheaper. For example, the unit price for a 20TB Seagate Enterprise HDD Exos X20 today is 6.75 \times cheaper than a 7.68TB SAMSUNG Enterprise SSD PM9A3 [4, 5]. That means a tiered storage with a size ratio of 1:10 based on these hardware can reduce the storage cost by 77% compared to pure SSDs of the same capacity.

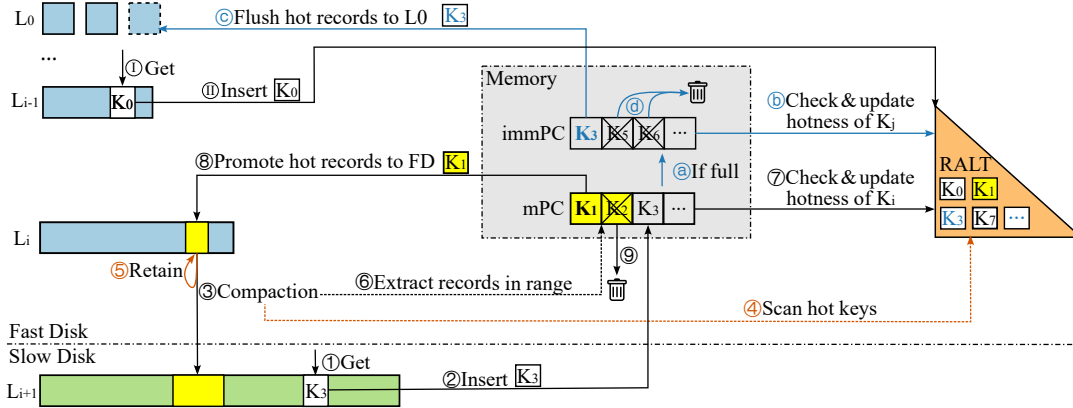

Figure 2: Overview of HotRAP. *mPC* and *immPC* stand for the mutable and immutable promotion caches. Solid arrows are data flow. Dashed arrows are control flow. The accessed keys in SD are firstly inserted into the mutable promotion cache (① to ②). Hot records are retained in FD during compactions (③ to ⑤). A compaction can piggyback hot records in its range to FD (⑥ to ⑨). If the mutable promotion cache becomes full, hot records in it will be flushed to Level 0 (⑩ to ⑪).

2.2 Hot/cold separation in LSM-trees

Tracking the access history of (potentially) hot records in memory can incur a large footprint. According to the Twitter trace [34], for example, 50% of the records have a value size smaller than $5 \times$ the key size. We take the AWS EC2 i4i.2xlarge instance for example, which is equipped with 64GB memory and an 1875GB local AWS Nitro SSD [3]. The configuration reflects the typical memory-disk ratio in the industry. If 1TB of its local SSD is used to store hot records, we need at least $(0.5 \times 1000) / 6 = 85.3$ GB memory to track those hot keys, which exceeds the physical memory of the instance.

Mutant [36] tracks the access frequencies of SSTables and adjusts their placement periodically to store the hottest SSTables in the faster storage. LogStore [24] maintains histograms in memory to track the hotness of SSTables and retains/promotes hot SSTables in/to the faster storage. They both separate hot/cold data in the granularity of SSTables, which is too coarse because there can be considerable cold data in the same SSTable that is considered hot.

RocksDB introduces the secondary cache on the fast disk to cache data blocks colder than blocks in the in-memory block cache [27]. SAS-Cache [41] further proposes several optimizations such as actively removing the cached blocks invalidated by compactions. However, the granularity of blocks is still too coarse because small objects are prevalent in large-scale systems [23], and there can be many cold tiny records in a hot data block.

MirrorKV [31] splits the LSM-tree into the key LSM-tree and the value LSM-tree and caches the most frequently accessed key SSTables in the faster storage. Additionally, MirrorKV retains the hottest blocks (e.g., 10%) during compactions from L1 to L2. Similarly, the granularity of SSTables and blocks are both too coarse.

SA-LSM [40] accurately predicts cold data using historical information with survival analysis and demotes cold records from the faster storage to the slower storage. However, SA-LSM does not support promoting hot records back to the faster storage, and the training cost of the survival model is heavy.

PrismDB [30] estimates key popularity with the clock algorithm, and the clock bits are indexed with a hash table. Hot records are

retained/promoted in/to the fast disk during compactions. However, the hash table used to index clock bits can consume considerable memory if the number of records is huge. Also, the promotion speed of PrismDB is slow because it only promotes during compactions.

2-Tree [42] maintains two B-trees, one in the memory and the other one on the disk. It migrates hot records to the in-memory B-tree and cold records to the on-disk B-tree. However, it does not support tiered storage and the in-memory B-tree consumes huge memory.

3 Design & Implementation

3.1 Overview

The overview of HotRAP is shown in Figure 2. There are two components to facilitate retention and promotion: Recent Access Lookup Table (*RALT*) and the promotion cache. *RALT* is responsible for tracking the hotness of records. It maintains a set of hot keys (without values) that are worth promoting and retaining, while ensuring the total size of hot keys does not exceed a limit that is automatically tuned to match the workload characteristics. The promotion cache is an in-memory cache that resides between the last level of FD and the first level of SD; that is, the version of records in it is older than the levels in FD and not older than the levels in SD. To read a key, HotRAP first searches in MemTables and the levels in FD, then searches in the promotion cache, and at last searches the levels in SD. The promotion cache consists of a mutable promotion cache and a list of immutable promotion caches. The mutable promotion cache is turned into immutable when full. Immutable promotion caches are flushed to disk as soon as possible.

When a record in FD is accessed (①), its key will be inserted into *RALT* to record the access (②). When a record in SD is accessed (①), HotRAP first inserts the key into the mutable promotion cache (②) (unless checks in §3.3 fail), and the key’s hotness information in *RALT* is updated later.

Retention. During normal LSM-tree compactions from the last level of FD to the first level of SD (③), HotRAP checks the hotness of each record to be compacted, and retains the hot ones in FD. It

does so by constructing a RALT iterator whose range is the key range of FD’s input SSTables. This iterator would produce the hot records identified by RALT in the order of keys. Therefore, we can advance the compaction iterator and the RALT iterator in a sort-merge manner (④), to decide the records to retain and write them to new SSTables in FD (⑤). The I/O incurred by the RALT iterator is small because RALT does not store values of HotRAP records.

Promotion by compaction. During the compaction between FD and SD, we also would like to promote the hot records in SD to FD. Recall that the accessed records in SD are cached in the in-memory promotion cache. We extract the records from the promotion cache that fall within the compaction key range (⑥), so that they could be handled together with this compaction. For the example in Figure 2, K_1 and K_2 are extracted. HotRAP consults RALT about whether each key is hot, and updates the hotness score in RALT accordingly (⑦). Hot records (K_1) are written to the last level in FD (⑧). Cold records (K_2) are dropped (⑨) and future lookups to them would go to SD. Actually, promotion by compaction could also be triggered by a compaction to the last level of FD. However, doing promotion during compactations at higher levels of FD would require complex version control, because the records in the promotion cache have older versions.

Promotion by flush. For read-heavy workloads, there may not be enough compactations. In this case, promotion by compaction is insufficient to keep the mutable promotion cache small. Therefore, when the size of the mutable promotion cache grows to the target size of SSTables (64 MiB by default), HotRAP converts it to an immutable promotion cache, and a new mutable promotion cache will be created (Ⓐ). For the example in Figure 2, K_1 and K_2 have been promoted by compaction. Therefore, only K_3, K_5, \dots are packed into an immutable promotion cache. Similar to promoting by compaction, the immutable promotion cache consults RALT about whether the records are hot (Ⓑ). Hot records (K_3) will be flushed to L_0 in FD (Ⓒ), while other records (K_5, K_6) are dropped (Ⓓ). Records promoted by flush will be compacted level by level again, which incurs non-negligible I/O. Therefore, promotion by compaction is still needed to reduce the promotion cost. Additionally, to avoid creating tiny SSTables in L_0 which will trigger compactations from L_0 to L_1 prematurely, if the total size of hot records is less than half of the target SSTable size, we insert them back into the mutable promotion cache instead of flushing to L_0 .

3.2 Recent Access Lookup Table (RALT)

RALT is a lightweight LSM-tree stored on FD, logging the accesses to the records in HotRAP. Its structure is in Figure 3. Each access record in RALT consists of the key, the length of the value (instead of the value itself), and the scoring metadata tick and score. Keys are considered hot if their scores are greater than a score threshold. We distinguish the size of the original key-value record in HotRAP (called the *HotRAP size*) and the size of the RALT access record itself (called the *physical size*). The total HotRAP size of hot records is called the *hot set size*. RALT has two parameters: the *hot set size limit* and the *physical size limit*, which constrain the total size of hot records and the occupied disk space of RALT itself, respectively. We set their values based on workload characteristics in §3.7.

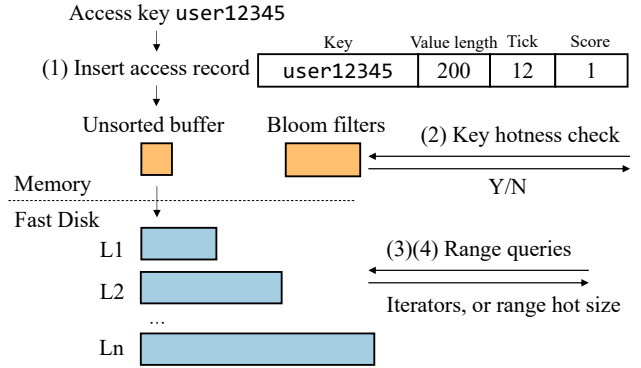

Figure 3: RALT structure. Suppose key user12345, whose value length is 200B, is accessed in HotRAP and an access record is inserted to RALT. The figure shows the RALT access record format, as well as the four supported operations (1) to (4). The current time slice sequence number for exponential smoothing is 12. The HotRAP size is $\text{len}(\text{user12345}) + 200 = 209$ bytes. The physical size is $(9 + 4) + (8 \times 3) = 37$ bytes, where we use 4 bytes for the length of the key, and 8 bytes each for the value length, tick, and score.

RALT supports four operations in Figure 3: (1) insert an access record; (2) check if a key is hot; (3) calculate the hot set size in a range; (4) scan hot keys in a range. When HotRAP inserts an access record into RALT, it first goes into an in-memory unsorted buffer. We use an unsorted buffer to improve performance because a sorted memory table does not benefit much (if a key is accessed again while its last access record is in the buffer, it should be super hot and promote very fast). If the unsorted buffer is full, it is sorted and flushed to FD. There are several levels on FD, following LSM-tree leveling compaction. For checking hotness, RALT uses an in-memory bloom filter to avoid random disk reads. For calculating a range hot set size, RALT stores the prefix sum of the HotRAP size of hot records in index blocks to reduce FD I/O. The details are explained below. For range scans, RALT constructs iterators on each level, like other LSM-trees. To avoid blocking reads, RALT maintains multiple versions of the LSM-tree structure.

If the hot set size or the occupied disk space of RALT exceeds the limits, an *eviction* is triggered, in which RALT evicts 10% of access records, and all access records are merged into a single sorted run (see below). 10% is a trade-off between the I/O cost and the stability of HotRAP’s hit rate.

Calculating scores. We use exponential smoothing [20] to calculate scores in order to utilize history information. The score for a key is defined as $\sum_{i=1}^N a_i \alpha^{t-i}$ where N is the number of time slices, t is the current time slice sequence number, and $a_i = 1$ if the key is accessed in the i -th time slice, $a_i = 0$ otherwise. In every access record, we store a pair (*tick*, *score*) for scoring, where $\text{tick} = t$ is the current time slice sequence number and $\text{score} = \sum_i a_i \alpha^{\text{tick}-i}$. RALT maintains the current time slice sequence number t , and increments t every time after $\gamma \times (\text{size of FD})$ data have been accessed. When the time slice proceeds, we do not need to update the scores in already stored access records; the real score of an access record (*tick*, *score*) can be obtained as $\alpha^{t-\text{tick}} \cdot \text{score}$. Two



Figure 4: Eviction in RALT. Each record has a score shown above it, and the length represents its size (HotRAP size or physical size). The sampled points are shown as stars in this virtual size space.

records $(tick_i, score_i)$, $(tick_j, score_j)$ with the same key may need to be merged in RALT which is an LSM-tree. The merged record $(tick^*, score^*)$ becomes $score^* = \alpha^{tick_j - tick_i} \cdot score_i + score_j$ and $tick^* = tick_j$, assuming $tick_i < tick_j$ without loss of generality. In our implementation, α and γ are set to 0.999 and 10%.

Eviction. If the hot set size or the physical size of RALT exceeds the limit, RALT evicts β records. By default, β is set to 10%. Ideally, we would like to set a score threshold and evict access records with scores smaller than it. However, since the records in RALT are sorted by key, not by score, it is non-trivial to determine a proper threshold. Instead, we use an approximate approach.

We formalize the problem as follows. Each record i has a size A_i (either HotRAP size or physical size) and a score S_i . We denote the total size as $A = \sum_i A_i$. β records will be evicted, and the target size after eviction becomes $A' = (1 - \beta)A$. We want to find a score threshold S' , so that records with scores less than S' are evicted. The total size of records with scores greater than S' is approximately A' , i.e., $\sum_{i \in RALT, S_i \geq S'} A_i \approx A'$.

Our algorithm is illustrated in Figure 4. First, we sample N numbers a_i from the numerical range $[0, A)$, and use a full scan to find the corresponding record x of a_i , defined as $\sum_{j < x} A_j \leq a_i < \sum_{j \leq x} A_j$; that is, the record that roughly sits at the uniformly sampled position a_i in the space of all records. Assume scores are uniformly distributed among records. Then, based on the definition of S' , about A'/A of all records should have their scores $\geq S'$. Among our N samples, there should be $\approx NA'/A = k$ records with scores $\geq S'$. We thus pick the k -th largest score in these records to be an approximation of S' .

We use this method to calculate the score thresholds for the two size limits, respectively. Records with a score less than the physical size score threshold are evicted from RALT. Records with a score less than the hot set score threshold but not less than the physical size score threshold are kept but not considered hot. The hotness check and hot key scan operations in RALT ensure this guarantee.

During eviction, RALT also merges all records. To limit the temporarily occupied space, RALT merges data step by step. At each step, it picks several unmerged SSTables in the largest level and SSTables that overlap with them in other levels. It then merges them and updates the version of RALT’s LSM-tree.

Checking hotness of a key. Searching keys by reading from SSTables on FD is expensive, so for each SSTable, RALT stores a bloom filter in memory that contains the hot keys (keys with scores higher than the threshold). When checking whether a key is hot, RALT checks the bloom filters at each level and returns true if

any bloom filter gives a positive result. We use 20-bit bloom filters to achieve a low overall false positive rate ($\ll 0.1\%$). The small number of false positives do not affect performance. Thus we do not perform second-verification.

Calculating the hot set size in a range. RALT needs to calculate the hot set size in a given range, for HotRAP to select which SSTable to compact (details in §3.5). Similar to a normal LSM-tree, we have data blocks and index blocks for SSTables. For each data block, its first key and the sum of the HotRAP size of hot keys in all previous data blocks are added to the index block. For a range query, at each level, we read the two edge index blocks and calculate the difference of their stored sums, to obtain the total HotRAP size of hot keys in the range. The results of all levels are summed up and returned, as an estimation of the hot set size in the range.

The above result is an overestimation because of two error sources. First, the total HotRAP size of hot keys in the one or two edge data blocks is small, so we choose to tolerate the error and do not read them. Second, there may be duplicated keys in different levels. If the number of levels is small and the size ratio between levels is large, we can expect the overestimation rate to be small. For example, if the size ratio is 10, the result in the second largest level may be about 1/10 of the result in the largest level on average. So the overestimation is only about 10%. §3.5 discusses how we handle such overestimation in HotRAP.

Memory usage and I/O cost. Bloom filters and index blocks are cached in memory. For a $\approx 200B$ key-value size, supposing 5% keys are hot, then the memory usage of bloom filters in RALT is $5\% \times 20/8/200 = 0.0625\%$ of the data size. Suppose the key length is about 20B. Then the size of an index block record is less than 40B. The size of a data block in RALT is 8KiB. Therefore, the memory usage of index blocks is $5\% \times 40/8192 = 0.0244\%$ of the data size. In total, the memory usage is only 0.0869% of the data size.

For I/O cost, suppose RALT has N_L levels and the size ratio between levels is T . The write amplification is $\frac{T}{2}(N_L - 1)$. Since we evict β of data, the total write amplification is $\frac{T}{2}(N_L - 1) + \frac{1}{\beta}$. The total read amplification is $\frac{T}{2}(N_L - 1) + \frac{2}{\beta}$ because we need two full scans to calculate the score threshold and evict records. In our experiments in §4.4, $T = 10$, $\beta = 10\%$, $N_L \approx 3$, the read amplification is about 30 while the write amplification is about 20. The experiment results show that RALT is only responsible for 6.1%–15.5% of total I/O, because a RALT record does not contain the value in a HotRAP record, therefore the total I/O of RALT is small compared to HotRAP.

3.3 Checks before inserting to promotion cache

The promotion cache resides between FD and SD. Therefore, before promoting a record into the promotion cache, it is crucial to verify the absence of a newer version of this record in SD, which would otherwise be shielded by the inserted older record in the promotion cache. For a point read that wants to insert the latest version just retrieved from SD into the promotion cache, it is known that no newer version exists in the same supervision (i.e., the LSM-tree’s snapshot). However, it is still possible that a newer version of the record is compacted into SD before the previous record has finished being inserted into the promotion cache. To address this issue, HotRAP marks SSTables as being or having been compacted when

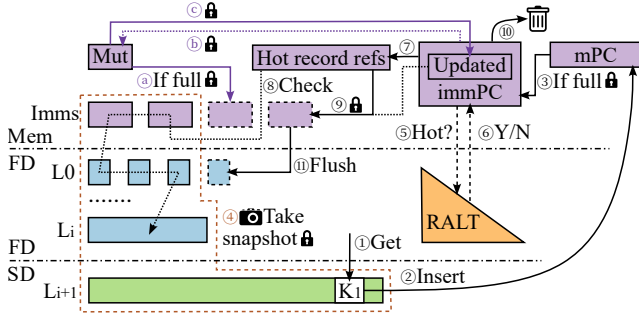

Figure 5: Concurrency control of promotion by flush. The processes with lock icons are protected by the DB mutex lock. ⑧ ensures that no newer versions exist in the snapshot of the LSM-tree. ① to ③ insert all updated keys in immutable promotion caches into their *updated* fields. Hot records with updated keys are excluded in ⑨. The snapshot is taken (④) after the creation of the immutable promotion cache (③), therefore, a key updated before ⑨ is either found out by ⑧ or by ①–③.

setting up compaction jobs with the write lock of the promotion cache held. During the client access, all SD SSTables whose range contains the key are recorded. Before inserting a record into the promotion cache, HotRAP tries to acquire the read lock and then checks whether any of the recorded SSTables is being or has been compacted. If there is, or if lock acquirement fails, HotRAP aborts the promotion. The abort rate is low because of the small number of compaction jobs. Our experiments show that this check only aborts less than 1% of insertions into the promotion cache.

3.4 Concurrency control of promotion by flush

Now we discuss the details of promotion by flush in Figure 5. As mentioned before, a read to SD record (①) inserts it to the mutable promotion cache (②), which may be later made immutable when full (③). At this point, a snapshot is taken by incrementing the reference count of the caller’s supervision (④). We pass the immutable promotion cache’s reference and the supervision’s reference to a background thread called *Checker*, who handles the rest part of promotion by flush. This minimizes the impact on foreground reads. *Checker* then picks out the hot records in the immutable promotion cache by consulting RALT (⑤ to ⑦). These hot records are candidates to be flushed to L_0 .

Proper concurrency control is needed to avoid the issue that flushing a hot record to L_0 may shield a newer version of this key in the FD levels. *Checker* looks for newer versions of the hot records in the snapshot’s immutable MemTables and the levels in FD (⑧). Hot records without newer versions are packed into a new immutable MemTable (⑨)¹. The immutable promotion cache can be deleted now (⑩). Those records will eventually be flushed into L_0 (⑪).

However, there is still a corner case: newer versions can be flushed into L_0 in the normal access path when HotRAP is looking for newer versions during step ⑧. To address this issue, HotRAP attaches an *updated* field to each immutable promotion cache. When a mutable MemTable becomes immutable during normal accesses

¹Or inserted back to the mutable promotion cache if there are too few of them.

(①), for every record in it, HotRAP checks whether the same key exists in the immutable promotion caches (⑤), and if so, HotRAP inserts the key into the *updated* field of the corresponding immutable promotion cache (③). The records whose keys exist in the *updated* field will not be packed into the immutable MemTable at step ⑨.

To ensure that the list of immutable promotion caches does not change during the creation of immutable MemTables at step ① so that the *updated* fields are comprehensive, we create immutable promotion caches with the DB mutex (the only major lock in RocksDB) held at step ③. Since in RocksDB, flushes are protected by the DB mutex, there are only two possible cases and both are correct: (1) An immutable MemTable is created before an immutable promotion cache is created. The newer versions of records in the immutable MemTable will be detected by the check of ⑧. (2) An immutable promotion cache is created before an immutable MemTable is created. The newer versions of records in the immutable MemTable will be added to the *updated* field and detected by ① to ③.

3.5 How to pick an SSTable to compact

In the leveling compaction strategy, every time a level reaches its capacity, we pick an SSTable and merge it into the next level. Typically, we calculate a score for each SSTable and pick the one with the highest score. For example, RocksDB defines the score as $FileSize/OverlappingBytes$ by default, in which *OverlappingBytes* represents the total size of the target level’s input SSTables whose key ranges overlap with the key range of the picked SSTable in the source level. This is essentially a cost-benefit trade-off score: *FileSize* is the benefit, and $(FileSize + OverlappingBytes)$ is the cost, in which *FileSize* is optimized out.

However, the cost-benefit score needs some adjustment to better support HotRAP. During a cross-tier compaction from FD to SD in HotRAP, hot records in the chosen SSTable in the source level will be retained in the source level. Therefore, the benefit becomes $(FileSize - HotSize)$, and the cost is still $(FileSize + OverlappingBytes)$. Their ratio is the new cost-benefit score.

HotRAP estimates the *HotSize* of an SSTable by querying RALT about the hot set size in the corresponding range (§3.2). Recall that the obtained *HotSize* is an overestimation. Therefore, it is possible, although very unlikely, that all benefit values are zero. In this case, HotRAP falls back to choose the oldest SSTable for compaction.

3.6 Write amplification of retention

Since some data in the last level on FD are retained, the efficiency of cross-tier compaction decreases. For example, supposing half of the last level on FD is hot data, then we need two compactations to compact data of one SSTable size from FD to SD, resulting in an increase of $2\times$ for write amplification. Suppose the size ratio of the LSM-tree is T , FD and SD respectively have n_{FD} and n_{SD} levels, and the fraction of cold data is p . Since each compaction at the last level on FD only compacts p of selected data to SD, $\frac{1}{p}\times$ more compactations are needed to compact the same amount of data. The write amplification is $\frac{T}{2}(n_{FD} - 1) + \frac{T}{2p} + \frac{T}{2}(n_{SD} - 1)$, which is $\frac{T}{2p} - \frac{T}{2}$ larger than a normal LSM-tree.

Write amplification can be lowered by tuning the level size ratios and adding more levels. Specifically, we can shrink the first level of SD to make the size ratio between the last level of FD and the first

level of SD be pT . To keep the size of the LSM-tree in SD unchanged, we can add an extra level after the last level with a size ratio of $\frac{1}{p}$. The size ratio between other levels in SD remains T . In this way, the write amplification is $\frac{T}{2}(n_{FD} - 1) + \frac{T}{2} + \frac{T}{2}(n_{SD} - 1) + \frac{1}{2p}$, which is only $\frac{1}{2p}$ larger than a normal LSM-tree.

3.7 Auto-tuning

In §3.2, RALT takes 2 parameters: the hot set size limit and the physical size limit, to constrain the total size of hot records and the space of RALT itself, respectively. Fundamentally speaking, the hot set size is determined by the distribution of the workload, which is usually unknown to the user and may further dynamically vary over time. Hence we propose an automatic tuning approach to estimate the most suitable hot set size and physical size.

To facilitate formal analysis, we assume each key k has an access probability of p_k . For skewed workload distributions, we can set a hot key threshold p_t , and find all the keys with $p_k \geq p_t$. When p_t is given, this is a “frequent items” problem, with several known solutions like counter-based methods [21, 28] or sketch-based methods [8]. However, counter-based methods need to maintain a large amount of counters, and sketch-based methods need to maintain extra expensive data structures. We proposed a novel algorithm that can dynamically calculate the hot size with small storage overheads and can be implemented by slightly modifying the RALT record format and compaction/eviction strategies.

Algorithm 1 Algorithm for updating hot set size limit

```

1: Let the set of tracked keys  $T \leftarrow \emptyset$ 
2: for each access  $k_i$  do
3:   if  $k_i \in T$  then
4:      $c_{k_i} \leftarrow \min(c_{k_i} + \Delta_c, c_{max})$ 
5:      $t_{k_i} \leftarrow 1$ 
6:   else
7:      $T \leftarrow T \cup \{k_i\}$ 
8:      $c_{k_i} \leftarrow \Delta_c$ 
9:      $t_{k_i} \leftarrow 0$ 
10:  end if
11: if accessed data amount reaches  $R$  then
12:   forall  $k_i \in T$  do  $c_{k_i} \leftarrow \max(c_{k_i} - 1, 0)$ 
13:  end if
14: if hot set size limit or physical size limit is exceeded then
15:   Evict  $k$  from  $T$  with either  $c_k$  or  $t_k$  is 0
16:   If not enough, evict  $k$  with low scores
17:   % Update size limits.
18:    $t \leftarrow$  HotRAP size of stable records
19:    $p \leftarrow$  Physical size of stable records
20:   Hot set size limit  $\leftarrow \max(L_{hs}, \min(t + D_{hs}, R_{hs}))$ 
21:   Physical size limit  $\leftarrow p + rD_{hs}$ 
22: end if
23: end for

```

Our algorithm to update the two size limits is summarized in Algorithm 1. We maintain a counter c and a tag t in each RALT access record. Records with $c > 0$ and $t = 1$ are considered *stable*; otherwise *unstable*. The first access to a key sets $c = \Delta_c$ and $t = 0$. A hit on an existing key increments c by Δ_c (capped at c_{max}) and activates $t = 1$ to be stable. Similar to the score calculation in §3.2, records with the same keys are merged during compaction. Every

time when the accessed data amount (in terms of the HotRAP size) reaches a limit R (e.g., the size of FD), we decrement all counters by 1, which eventually makes cold records become no longer stable. The maximum counter value c_{max} ensures that cold keys can be evicted after accessing at most $c_{max} \cdot R$ data.

Old unstable records are evicted when the hot set size or physical size exceeds the limit. If the size is still too large, records with low scores will continue to be evicted following the eviction process in §3.2. After each eviction, we also update the two limits as depicted in Lines 18 to 21 in Algorithm 1. Here we have several pre-determined parameters. L_{hs} and R_{hs} are the lower and upper bounds of the hot set size; D_{hs} is the maximum allowed HotRAP size of unstable records; Their values in our implementation are listed at the end of this subsection. Essentially, we set the hot set size limit to be the size of stable records plus D_{hs} , subject to constraints of the two bounds. Finally, r is the average ratio between physical size and HotRAP size, i.e., RALT access record size/key-value record size. The physical size limit is thus r times of the hot set size limit.

Analysis. We define the keys with $p_k \geq p_t$ as *hot* and the keys with $p_k < \epsilon p_t$ as *cold*, where $\epsilon < 1$ and p_t are given. Our algorithm ensures that if we set Δ_c and c_{max} carefully, then almost all hot keys will become stable, while the size of stable cold keys is bounded. We prove this with the following formal analysis.

To avoid considering varying HotRAP sizes of records, for convenience, we let all the records have the same HotRAP size s . We define the probability p_k as $P(\text{access probability of } k)/s$. Then $\sum_k p_k = \frac{1}{s}$, and Rp_k is the expected number of accesses to k during total R accessed data amount. The maximum number of keys with probability p_t is $\frac{1}{sp_t}$ and the corresponding HotRAP size is $s \cdot \frac{1}{sp_t} = \frac{1}{p_t}$. Then, we have the following theorem.

THEOREM 3.1. *Suppose accesses are independent and identically distributed (i.i.d.). The parameters p_t , $\epsilon < 1$, R , and D_{hs} are given. The probability that a hot key becomes stable is no less than $1 - \frac{1}{\omega}$ if we let $c_{max} \geq 1 + X(\omega)$, $\Delta_c \geq Y(c_{max})$. The expectation of the size of stable cold keys is no greater than $(1 - Z)\frac{1}{\epsilon p_t}$. Here X is a function on ω , Y is a function on c_{max} , and Z is a constant, each depending on the above given parameters.*

PROOF. We consider the process as a Markov chain. For each key k , it has c_{max} states: $0, 1, \dots, c_{max} - 1$. State 0 is unstable and will be evicted during eviction, and states $i > 0$ are stable and will be kept, i.e., $c_k = i$, $t_k = 1$ after eviction and decrementing counters by 1. State transits every time the accessed data amount reaches R .

To save space, we only prove the special case of $\Delta_c = c_{max}$. We begin with calculating the state transit probabilities. The probability of no access to k within R amount of data accessed is e^{-Rp_k} . In this case, the counter decrements by 1, so we have $p_{i,i-1} = e^{-Rp_k}$. Otherwise, there are accesses to k . Since $\Delta_c = c_{max}$, the counter becomes $c_{max} - 1$ (it increases to c_{max} and decrements by 1), so we have $p_{i,c_{max}-1} = 1 - e^{-Rp_k}$ when $i > 0$. Since we update the hot set size limit to $t + D_{hs}$ in Algorithm 1, the HotRAP size of unstable records is about D_{hs} at evictions. So the probability for an unstable key k to become stable during R amount of data accessed, $p_{0,c_{max}-1}$, is approximately the probability for k to be accessed two times with less than D_{hs} other data accessed in between. Therefore, $p_{0,c_{max}-1} \approx P(k \text{ is accessed in } R) \times P(k \text{ is accessed in } D_{hs}) = (1 -$

$e^{-Rp_k}(1 - e^{-D_{hs}p_k})$. According to the Markov chain, we can then derive the stationary probability of state 0 for keys with probability p_k is $\pi(p_k) = \frac{e^{D_{hs}p_k}}{1 + e^{(c_{max}-1)Rp_k}(e^{D_{hs}p_k} - 1)}$.

To make the probability that a key with $p_k \geq p_t$ becomes stable $\geq 1 - \frac{1}{\omega}$, we choose a c_{max} satisfying $\pi(p_t) \leq \frac{1}{\omega}$. This gives the bound $X(\omega)$ of c_{max} . And in this case, $Y(c_{max}) = c_{max}$. Since the HotRAP size of keys with probability ϵp_t is $\leq \frac{1}{\epsilon p_t}$, the expectation of the HotRAP size of stable cold keys is $\leq \frac{\pi(\epsilon p_t)}{\epsilon p_t}$, from which we can derive the bound Z . This is an upper bound for all Δ_c and c_{max} because HotRAP size of stable cold keys is smaller when $\Delta_c < c_{max}$ compared to when $\Delta_c = c_{max}$.

In practice, Δ_c and c_{max} are not necessary the same, and we need to calculate the stationary probabilities of a more complex Markov process. Although the exact equations would differ from the above, the bounds still exist and can be similarly calculated. \square

The intuition is that, for a cold key set K_{cold} and a hot key set K_{hot} , the difference between $\sum_{k \in K_{hot}} p_k$ and $\sum_{k \in K_{cold}} p_k$ may not be large enough because of the very large number of cold keys. But the difference between $\sum_{k \in K_{hot}} p_k^2$ and $\sum_{k \in K_{cold}} p_k^2$ is typically large. In our algorithm, the probability of becoming stable is $(1 - e^{-Rp_k})(1 - e^{-D_{hs}p_k}) \approx (Rp_k)(D_{hs}p_k) \propto p_k^2$. By this approach, hot keys are identified because hot keys become stable faster than cold keys. If the eviction speed of cold keys is faster than the speed of becoming stable, the size of cold keys is limited.

Implementation details. We set $L_{hs} = 0.05 \times \text{FD size}$, $R_{hs} = 0.7 \times \text{FD size}$, $D_{hs} = 0.1 \times R_{hs}$, $R = R_{hs}$. We set $\Delta_c = 2.6$, $c_{max} = 5$, $p_t = \frac{1}{0.5 \times \text{FD size}}$. With these parameters, according to our theorem, the HotRAP size of cold keys with $p_k < 0.1 \times p_t$ is smaller than $0.5 \times \text{FD size}$, which is acceptable. The probability of each hot key becoming stable is at least 98%. The experiments are shown in §4.6.

3.8 Supporting scan

HotRAP can support short range scans. We only consider short ranges (e.g., 10 keys) because long range scans are mainly bound by the disk bandwidth. Different from point lookups, we need to know whether all the keys in the queried range are in FD to avoid reading SD. A possible implementation is as follows: RALT stores the hot information and the promotion tags for some ranges. The promotion tag is used to indicate whether the keys in the range have been promoted to FD. For each scan, HotRAP first queries RALT. If the queried range is contained in a promoted range, it does not need to read from SD. Otherwise, it reads from SD, promotes them to FD, and inserts a promotion tag for this range into RALT. When a range in RALT becomes cold, records in it will be compacted to SD during compactions, and then the range is marked as not promoted and evicted later. However, efficiently querying whether a range is promoted is non-trivial. We leave this as our future work.

4 Evaluation

4.1 Experimental setup

Testbed. We evaluate HotRAP on AWS EC2 i4i.2xlarge instances running Debian 12. Each instance has 8 vCPU cores, 64GiB memory, and a 1875GB local AWS Nitro SSD. We use local SSDs as FD and gp3 as SD, with their performance shown in Table 1. Since HDD RAID

Table 1: Disk performance on our EC2 instances.

	Fast Disk	Slow Disk
Type	AWS Nitro SSD	gp3
16 threads rand 16K read IOPS	≈ 83000	10000
Sequential read bandwidth	$\approx 1.4\text{GiB/s}$	1000MiB/s
Sequential write bandwidth	$\approx 1.1\text{GiB/s}$	1000MiB/s

Table 2: Read-write ratios of YCSB workloads in our tests.

Notation	Meaning	Read-write ratio
RO	read-only	100% read
RW	read-write	75% read, 25% insert
WH	write-heavy	50% read, 50% insert
UH	update-heavy	50% read, 50% update

arrays can achieve thousands of IOPS and high throughput, we set the maximum IOPS and throughput of gp3 to 10000 and 1000MiB/s respectively to simulate the most performant HDD RAID arrays.

Sizes of tiers and memory. We set the space ratio between tiers to 10: the expected used size of FD is set to 10GB and the initial expected used size of SD is set to 100GB.

Compared systems. We compare HotRAP with Mutant [36], PrismaDB [30], SAS-Cache [41], and two variants of RocksDB as follows. *RocksDB(FD)* stores all data in FD, which is used to indicate the upper-bound performance that HotRAP can achieve. *RocksDB-fat* is a variant of RocksDB in which the size of the last level in FD is increased so that the total size of FD levels becomes 10GB, which is the same as HotRAP. Mutant, PrismaDB, and SAS-Cache are also tuned to use about 10GB of FD expectedly.

Configurations. All experiments run with 16 threads. To reduce the memory usage of block indexes, the block size of all systems is set to 16KiB following Meta’s practice [26]. The maximum number of background jobs is set to 8 for HotRAP and RocksDB. To minimize the impact of the file system cache, direct I/O is used for HotRAP, RocksDB, and PrismaDB, for fair comparison. For Mutant, since it is difficult to enable direct I/O due to its old version of RocksDB, we limit its memory with `systemd-run` to reduce the page cache size. Auto-tuning of HotRAP is turned on. We set the initial hot set size limit and RALT physical size limit to 50% and 15% of the FD size respectively. The secondary cache size of SAS-Cache is set to 6GB. All systems are configured with a 128MiB block cache and 10-bit bloom filters. Other configurations are set to their default values.

4.2 Performance on YCSB workloads

To assess the performance of HotRAP under various key distributions and read-write ratios, we evaluate HotRAP with the YCSB workloads [9] shown in Table 2. *RO* (read-only) tests the effectiveness of promotion by flush. *RW* (read-write) and *WH* (write-heavy) test the effectiveness of retention. *UH* (update-heavy) is the worst case for HotRAP. With UH, the key distributions of reads and updates are the same. Therefore, newer versions of read-intensive records are frequently inserted into the database and flushed into FD, making the proactive promotion of HotRAP barely needed.

We test three skewness types: hotspot-5%, Zipfian, and uniform. In the hotspot-5% distributions, 5% of records are treated as hot records, accessed by 95% operations uniformly. The other 5% operations uniformly access the other 95% of records. In the Zipfian

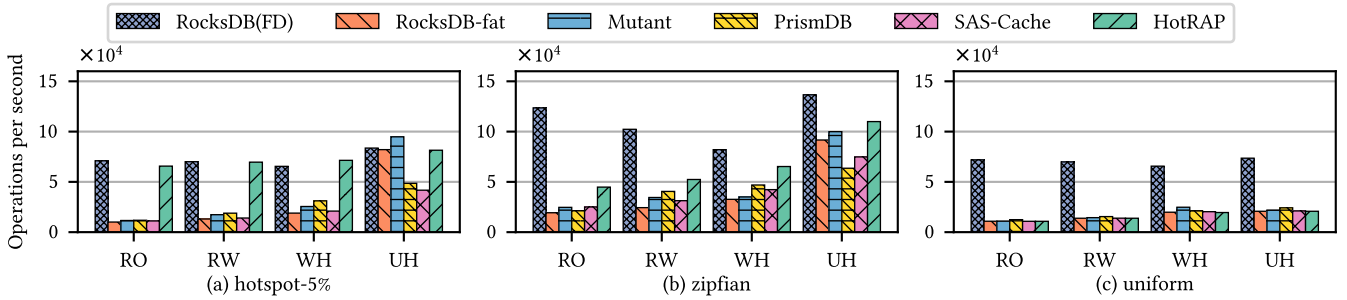

Figure 6: Throughput comparison with 1KiB record size.

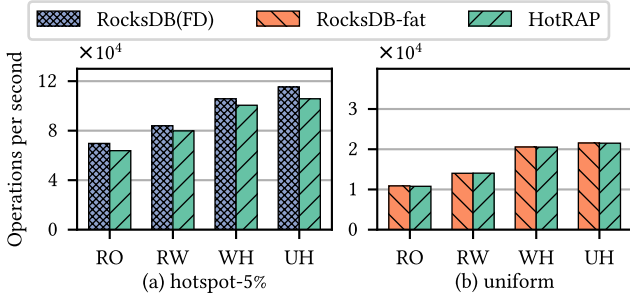

Figure 7: Throughput comparison with 200B record size.

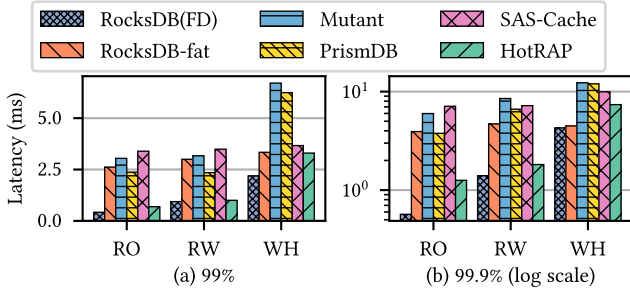

Figure 8: Get tail latency comparison under hotspot-5% workloads with 1KiB record size.

distribution, the access probability of the k -th hottest record is proportional to $\frac{1}{k^s}$ [7]. In our experiments, $s = 0.99$. In the uniform distribution, the access probability of all records is the same. We evaluate two record sizes, 1KiB (≈ 24 B key and 1000B value) and 200B (≈ 24 B key and 176B value).

In all workloads, the client first loads 110GB of records into the LSM-tree (the load phase). After that, the client executes read/insert operations (the run phase). We focus on the performance of the run phase. For workloads with 1KiB records, 2.2×10^8 read/insert operations are executed in the run phase. For 200B records, 1.1×10^9 operations are executed in the run phase.

Figures 6 and 7 compare the average throughput (measured over the final 10% of the run phase) of evaluated systems under different read-write ratios and skewness types, with the 1KiB and 200B record sizes, respectively. Since the trends are similar, we only show a representative subset in Figure 7 to save space.

Under both record sizes, the performance of HotRAP when running hotspot-5% workloads is close to that of the ideal RocksDB(FD),

because HotRAP promotes almost all hot data into FD and achieves an about 95% hit rate. Compared to other systems, HotRAP achieves 5.6 \times speedup over the second best for read-only (RO) workloads, and 3.7 \times for read-write-balanced workloads (RW). On the other hand, HotRAP is only 1.6% slower than RocksDB-fat under uniform workloads, showing the overhead incurred by HotRAP is low when promotion has no benefits. For the Zipfian distribution, there is a noticeable gap in Figure 6 between HotRAP and the upper-bound RocksDB(FD), because the hit rate is lower (79%) compared to hotspot-5%. But HotRAP still outperforms other designs.

For the three baseline designs, Mutant and SAS-Cache show negligible improvements compared to RocksDB-fat, because their data promotion granularity is too coarse: data blocks for SAS-Cache and SSTables for Mutant. PrismDB also only has small improvements over RocksDB-fat due to its inefficient promotion mechanism.

Among different read-write ratios, we notice that all systems exhibit higher throughput under the update-heavy (UH) workloads. This is because the updated data have a skewed distribution, and thus update operations can be considered as promotions to FD. However, PrismDB and SAS-Cache perform relatively poorly in this case. PrismDB suffers from lock contention and inefficient random writes to FD. SAS-Cache has its secondary cache frequently evict and promote data blocks, thus incurring significant FD I/O.

Figure 8 shows the tail latencies (again over the final 10% of the run phase) under hotspot-5% workloads with 1KiB record size. When running read-heavy workloads (RO & RW), HotRAP achieves lower tail latency than other systems except RocksDB(FD). In these cases, HotRAP has higher FD hit rates and thus reduces accesses to SD, so there are proportionally fewer long-latency accesses affected by the SD tail latency among all FD and SD accesses. In contrast, under write-heavy workloads (WH), HotRAP has a higher tail latency than RocksDB-fat. We believe this is because the throughput of HotRAP is higher than RocksDB-fat, therefore compactions in HotRAP are more frequent, which deteriorates the tail latency.

4.3 Performance on real-world Twitter traces

To show the performance of HotRAP under real-world workloads, we evaluate HotRAP with the Twitter production traces [34]. We pre-process every trace into two phases: the load phase and the run phase. In the load phase, we ignore reads and keep inserting about 110GB of data. In the run phase, we execute 5×10^8 operations. We augment small traces by repeating operations until reaching 110GB of data. For example, if a trace has 40GB of data, we repeat each

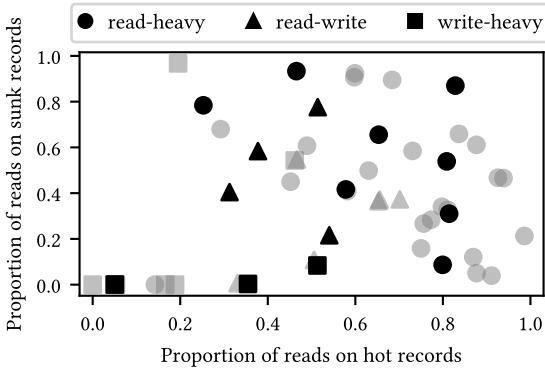

Figure 9: Characteristics of Twitter production traces. Each point stands for a cluster’s trace. Dark black points are our selected traces for evaluation in Figure 10.

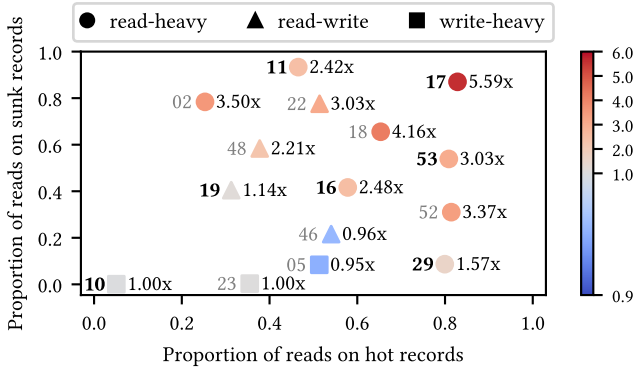

Figure 10: Speedup of HotRAP over RocksDB-fat on Twitter production traces. Numbers on the two sides of a point are the cluster ID and the speedup. Traces with bold cluster IDs are selected for further analysis in Figure 11.

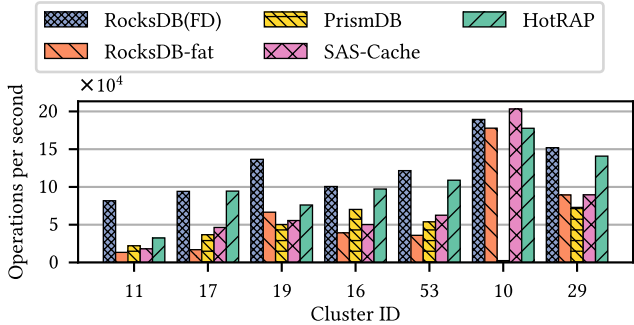

Figure 11: Throughput comparison under several Twitter production traces.

operation 3 times, e.g., an operation “INSERT user123” becomes “INSERT @user123, INSERT 1user123, INSERT 2user123”.

Traces are categorized based on their read proportions: read-heavy has $>75\%$ reads; read-write has $>50\%$ and $\leq 75\%$ reads; write-heavy has $\leq 50\%$ reads. In some traces, it is common for a frequently read key to be also frequently updated. Proactively promoting this key has little benefit because its newer version will be automatically

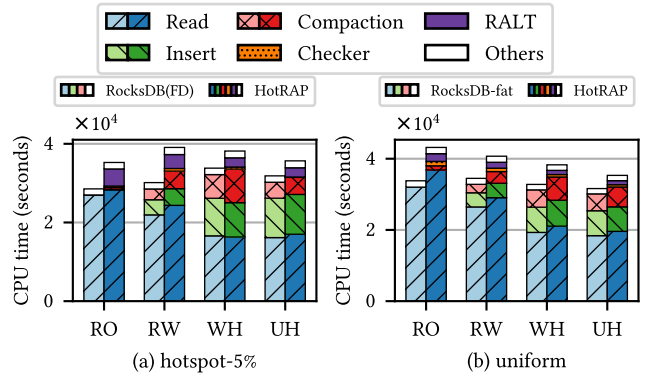

Figure 12: CPU time breakdown with 200B record size.

inserted into FD. We define that a read is performed on a *sunk* record if the data amount written since the last update of this record is greater than 5% of the DB size, so that the latest version is now likely sunk to SD when being read. Similarly, we define that a read is performed on a *hot* record if the data amount read since the last read of this record is less than 5% of the DB size, so that the record is likely to be identified hot. If there are many reads on such sunk and hot records, then it is necessary to promote them to FD.

Figure 9 shows the categories and proportion of reads on sunk/hot records in the Twitter traces. We select some representative traces to evaluate the speedup of HotRAP over RocksDB-fat in Figure 10. HotRAP performs better when the proportions of reads on sunk and hot records are higher, e.g., achieving up to 5.59 \times speedup under the trace of cluster 17. On the other hand, HotRAP is not significantly slower than RocksDB-fat under traces with low proportions of reads on sunk and hot records, showing its low overhead.

We further analyze several traces with high (11, 17), middle (19, 16, 53), and low (10, 29) proportions of sunk record reads and show their throughput in Figure 11. Mutant is not shown because it incurs too much FD usage ($>30\text{GB}$) when executing several traces. HotRAP is almost always the best among compared systems, and achieves up to 2.0 \times speedup over the second best. When the proportion of sunk record reads is lower, almost all systems perform better, but the speedup of HotRAP also becomes smaller. At middle and high proportions of sunk record reads, if we increase the amount of hot record reads, HotRAP throughput would significantly increase, while PrismDB and SAS-Cache perform moderately better, and RocksDB-fat does not benefit from it at all.

PrismDB performs extremely bad under cluster 10 trace because this trace uniformly reads recently updated keys which are still in FD. Therefore PrismDB identifies almost all data in FD as hot and retains them. As a result, when FD gets full, PrismDB can only demote a few keys to SD, and it has to trigger demotion repeatedly to keep FD usage under the limit. The frequent demotion contends for locks with reads and thus causes severe performance degradation.

4.4 Cost breakdown

Figures 12 and 13 show the breakdown of CPU time and I/O for the run phase of YCSB workloads with 200B record size. The size of RALT here is more than 1.5GB, which needs to be stored in FD instead of memory. The results show that RALT is only responsible

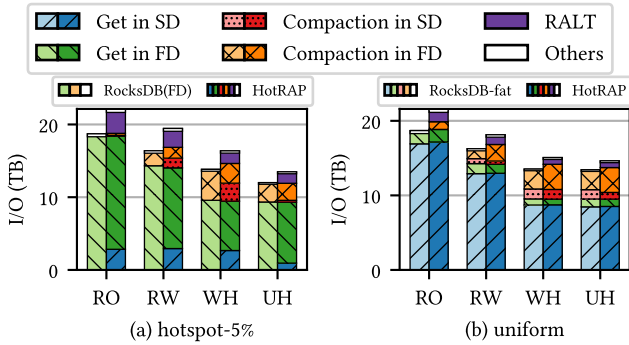

Figure 13: I/O breakdown with 200B record size.

Table 3: Promotion costs with/without retention under the RW hotspot-5% workload with 1KiB record size.

Version	Promoted	Retained	Compaction	Hit rate
HotRAP	5.9GB	41.3GB	2530.6GB	94.5%
no-retain	35.2GB	0.0GB	3156.5GB	72.0%

for 3.1%–12.3% of total CPU time and 6.1%–15.5% of total I/O, hence the design is efficient.

In the hotspot-5% workloads, HotRAP incurs more CPU time and I/O on compaction than RocksDB(FD), because retention increases write amplification. HotRAP incurs more read CPU time, because HotRAP needs to insert accessed SD records into the promotion cache. RocksDB(FD) incurs more insert CPU time under the write-heavy hotspot-5% workload. The reason is that RocksDB(FD) executes more inserts than HotRAP in the same amount of time and thus more writes are batch-executed by the leader writer. Therefore, non-leader writers incur more CPU time calling `__sched_yield` to wait for the results from the leader writer.

In the uniform workloads, HotRAP consumes more CPU time than RocksDB-fat because most accesses are in SD and thus the records are inserted into the promotion cache. However, few records are promoted into FD due to the hotness checking (7) & (b) in Figure 2), therefore they have similar compaction I/O.

Figure 14 shows the breakdown of device throughput under the RW (75% read, 25% insert) hotspot-5% workload. HotRAP promotes and retains hot records in FD. Therefore, the number of *Get* operations served by FD increases over time, and thus the total throughput of *Get* also increases over time until it is close to that of RocksDB(FD). Most *Get* operations in RocksDB-fat are served by SD, which bounds its total *Get* throughput.

4.5 Effectiveness of individual techniques

To show the effectiveness of retention, we remove the retention mechanism from HotRAP and call the design as *no-retain*. Table 3 shows that *no-retain* incurs more promotion costs and achieves a lower final hit rate than HotRAP. The reason is that although *no-retain* still promotes records into FD, the promoted records are compacted into SD again during compactions. Therefore, hot records have to be promoted repeatedly, with much more promotion traffic.

HotRAP only promotes hot records to reduce the overhead introduced by promotion. To show its effectiveness, we remove hotness

Table 4: Promotion costs with/without hotness checking under the RO uniform workload with 1KiB record size.

Version	Promoted	Retained	Compaction
HotRAP	1.0GB	0.0MB	24.7GB
no-hotness-check	206.4GB	8.0GB	7093.7GB

Table 5: Promotion costs with/without promotion by compaction under the RW hotspot-5% workload with 1KiB record size.

Version	By Compaction	By flush	Compaction
HotRAP	0.9GB	5.0GB	2530.6GB
no-by-compaction	0.0GB	5.8GB	2683.5GB

checking and promote all accessed records. Table 4 shows that under uniform workloads, *no-hotness-check* promotes 209.9× more records and thus incurs 285.8× more compaction I/O than HotRAP.

HotRAP also promotes by compactions to reduce the costs of promotion. To show its effectiveness, we remove the promote-by-compaction policy and only promote hot records by flushing them to L_0 of the LSM-tree. We call this design as *no-by-compaction*. Table 5 shows that *no-by-compaction* incurs 6.0% more compaction I/O than HotRAP because the records that could have been promoted by compaction are unnecessarily brought to L_0 and compacted to deeper levels again. Therefore, the promote-by-compaction policy is effective in reducing compaction I/O caused by promotions.

4.6 Performance on dynamic workload

To show that HotRAP can effectively adapt to changes in the access pattern, we evaluate it under a dynamic workload. The details of the dynamic workload and the results are shown in Figure 15.

The hot set starts from 5GB at the beginning. The first stage has a uniform distribution, so there are few stable records, and the hot set size limit decreases to the minimum value 0.5GB. At the second stage, the key distribution becomes hotspot-1%. With the auto-tuning method in §3.7, HotRAP gradually increases the hot set size limit until all hotspot keys are added to the hot set. Eventually, the hot set size stabilizes around the hotspot size. There is a small overshoot for the hot set size because it needs some time for old stable records in the prior stage to become unstable. After the hotspot expands from 1% to 3% and from 3% to 5%, the FD hit rate temporarily drops because new hot keys are not yet promoted. Then HotRAP is able to gradually increase the hot set size limit until all new hot keys are added to the hot set, thus recovering the hit rate, showing the efficient promotion mechanism. Similar behaviors also happen when the hotspot shifts between the fourth and fifth stages. HotRAP reacts adaptively to the hotspot shift by evicting old hot keys after they become unstable, and gradually adding new hot keys to the hot set. Both the throughput and the hit rate recover eventually. After the hotspot shrinks from 5% to 4% and from 4% to 2%, the throughput and the hit rate do not drop because new hot keys are already considered hot and have already been promoted. Nevertheless, HotRAP in this case could decrease the hot set size limit after old access records become unstable.

In summary, the results show that the auto-tuning mechanism enables HotRAP to find the most suitable hot set size limit under a dynamic workload with hotspot expanding, shrinking, and shifts.

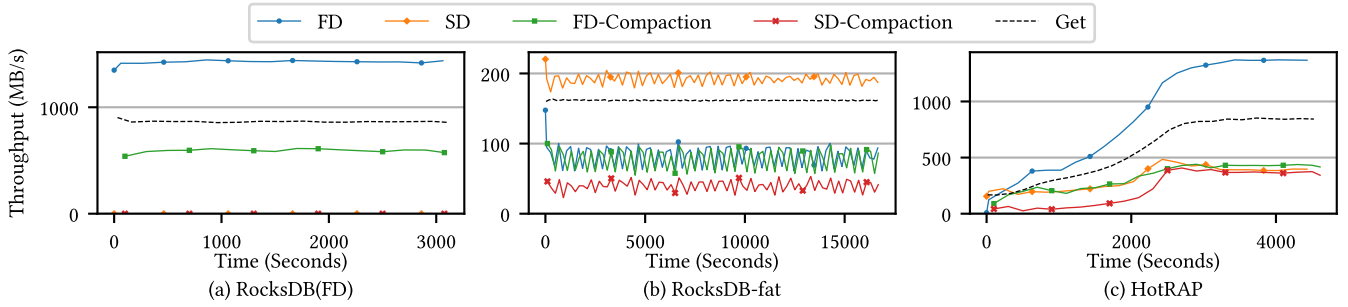

Figure 14: Device throughput breakdown under the RW (75% read, 25% insert) hotspot-5% workload with 1KiB record size. For readability, throughput is averaged every 200 seconds. *Get* is the measured throughput of disk reads during *Get* operations, which is an indicator of end-to-end performance.

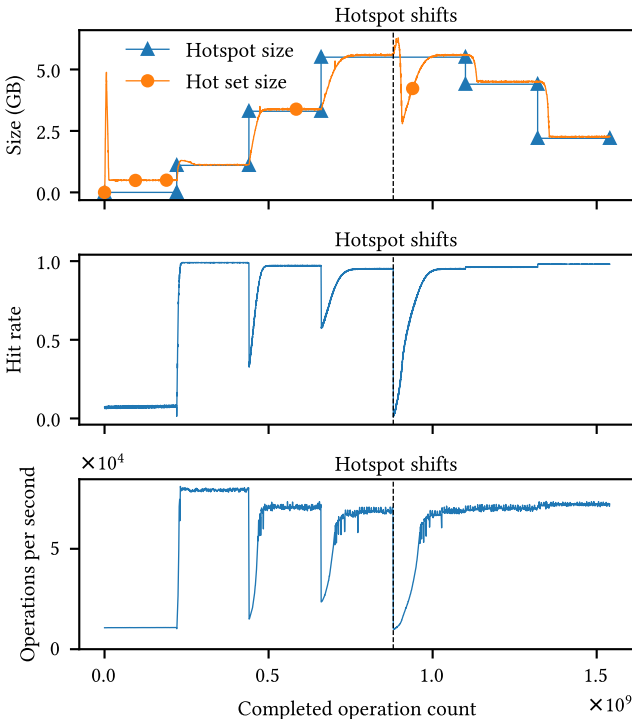

Figure 15: HotRAP under dynamic workload. The run phase consists of seven stages, whose data distributions are uniform \rightarrow hotspot-1% \rightarrow hotspot-3% \rightarrow hotspot-5% \rightarrow hotspot-5% \rightarrow hotspot-4% \rightarrow hotspot-2%. Each stage executes 2.2×10^8 read operations. The two 5% hotspots in the 4th and 5th stages are non-overlapping. When the hotspots increase from 1% to 3% and 5%, the new hotspot completely contains the old hotspot. When they decrease from 5% to 4% and 2%, the new one is completely contained by the old one.

4.7 Efficiency of scoring methods

We now use the hotspot-5% WH workload to compare three scoring methods for RALT: LRU, multi-bit CLOCK [10], and exponential smoothing [20]. In this experiment, we fix the hot set size limit to 5.5GB to match the hotspot size. The results show that the final hit rate of exponential smoothing is the best, about 93%, while CLOCK gives 90%, and LRU has 85%. LRU is inefficient because hot keys

Table 6: Disk performance in the HDD test.

Type	Fast Disk	Slow Disk
16 threads rand 16K read IOPS	≈ 98000	≈ 400
Sequential read bandwidth	$\approx 5\text{GiB/s}$	$\approx 260\text{MiB/s}$
Sequential write bandwidth	$\approx 4\text{GiB/s}$	$\approx 250\text{MiB/s}$

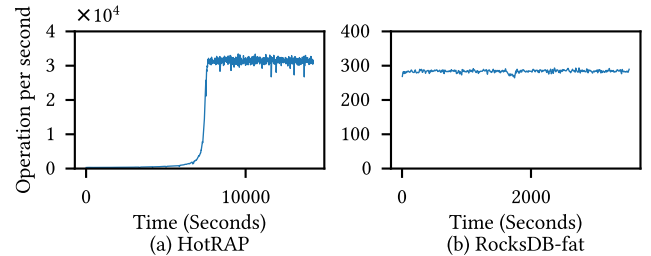

Figure 16: Throughput comparison of HotRAP and RocksDB-fat using HDD as SD, under the hotspot-1% RO workload with 1KiB record size. HotRAP runs 2.2×10^8 operations. RocksDB-fat only runs 10^6 operations as it has consistent throughput.

can be easily evicted due to recent cold accesses. CLOCK is better because it captures the access counts, but it may cause the counters of hot keys to be decremented unnecessarily.

4.8 Performance on hard disk drive (HDD)

Although most of our experiments are conducted with gp3 as the slow disk, HotRAP can also achieve significant performance gains with other types of slow disks. We now evaluate HotRAP using a hard disk drive (HDD) as the slow disk, which is likely to be a common choice in the industry due to its large capacity and cost-effectiveness. The experiments are conducted on an Intel NUC with an i7-1165G7 CPU (2.80GHz, 8 vCPU cores), 32GB DRAM, and a Samsung 980PRO NVMe SSD as the fast disk. The disk performance is shown in Table 6. Figure 16 shows the results. HotRAP is 110 \times faster than RocksDB-fat. HotRAP achieves even higher performance improvement if the slow disk is a real HDD instead of gp3 due to the larger performance gap between the two disk tiers.

5 Conclusion

We introduced HotRAP, an LSM-tree-based key-value store on tiered storage. Unlike previous solutions, HotRAP adopts an efficient on-disk hotness tracker, along with fine-grained record-level retention and promotion mechanisms that independently operate besides LSM-tree compactions. These techniques allow HotRAP to move data efficiently across tiers to fully utilize the fast storage for keeping hot records even under read-heavy workloads.

References

- [1] 2009. Apache Cassandra. <https://cassandra.apache.org>.
- [2] 2015. ScyllaDB. <https://github.com/scylladb/scylladb>.
- [3] 2024. Amazon EC2 Instance Types. <https://aws.amazon.com/ec2/instance-types/>.
- [4] 2024. SAMSUNG PM9A3 2.5" U.2 7.68TB PCIe 4.0 x4 NVMe 1.4 V-NAND TLC Enterprise Solid State Drive. <https://www.newegg.com/p/N82E16820147858?Item=9SIA12KJA14195>.
- [5] 2024. Seagate Exos X20 ST20000NM007D 20TB 7200 RPM 256MB Cache 3.5" Internal Hard Drive. <https://www.newegg.com/seagate-exos-x20-st20000nm007d-20tb/p/N82E16822185011?Item=N82E16822185011>.
- [6] 2024. TiKV is a highly scalable, low latency, and easy to use key-value database. <https://tikv.org/>.
- [7] 2024. Zipf's law. https://en.wikipedia.org/wiki/Zipf%27s_law.
- [8] Moses Charikar, Kevin Chen, and Martin Farach-Colton. 2002. Finding frequent items in data streams. In *International Colloquium on Automata, Languages, and Programming*. Springer, 693–703.
- [9] Brian F Cooper, Adam Silberstein, Erwin Tam, Raghu Ramakrishnan, and Russell Sears. 2010. Benchmarking cloud serving systems with YCSB. In *Proceedings of the 1st ACM symposium on Cloud computing*. 143–154.
- [10] Fernando J Corbato et al. 1968. A paging experiment with the multics system. (1968).
- [11] Niv Dayan, Tamar Weiss, Shmuel Dashevsky, Michael Pan, Edward Bortnikov, and Moshe Twitto. 2022. Spooky: granulating LSM-tree compactions correctly. *Proceedings of the VLDB Endowment* 15, 11 (2022), 3071–3084.
- [12] Siying Dong, Mark Callaghan, Leonidas Galanis, Dhruba Borthakur, Tony Savor, and Michael Strum. 2017. Optimizing Space Amplification in RocksDB. In *CIDR*, Vol. 3. 3.
- [13] Siying Dong, Andrew Kryczka, Yanqin Jin, and Michael Stumm. 2021. Evolution of development priorities in key-value stores serving large-scale applications: The {rocksdb} experience. In *19th USENIX Conference on File and Storage Technologies (FAST 21)*, 33–49.
- [14] Siying Dong, Andrew Kryczka, Yanqin Jin, and Michael Stumm. 2021. Rocksdb: Evolution of development priorities in a key-value store serving large-scale applications. *ACM Transactions on Storage (TOS)* 17, 4 (2021), 1–32.
- [15] Siying Dong, Shiva Shankar P, Satadru Pan, Anand Ananthabhotla, Dhanabal Ekambaram, Abhinav Sharma, Shobhit Dayal, Nishant Vinaybhai Parikh, Yanqin Jin, Albert Kim, et al. 2023. Disaggregating RocksDB: A Production Experience. *Proceedings of the ACM on Management of Data* 1, 2 (2023), 1–24.
- [16] Google. 2011. LevelDB. <https://github.com/google/leveldb>.
- [17] Dongxu Huang, Qi Liu, Qiu Cui, Zhuhe Fang, Xiaoyu Ma, Fei Xu, Li Shen, Liu Tang, Yuxing Zhou, Menglong Huang, et al. 2020. TiDB: a Raft-based HTAP database. *Proceedings of the VLDB Endowment* 13, 12 (2020), 3072–3084.
- [18] HV Jagadish, PPS Narayan, Sridhar Seshadri, S Sudarshan, and Rama Kanneganti. 1997. Incremental organization for data recording and warehousing. In *VLDB*. 16–25.
- [19] Cockroach Labs. 2015. CockroachDB. <https://github.com/cockroachdb/cockroach>.
- [20] Justin J Levandoski, Per-Åke Larson, and Radu Stoica. 2013. Identifying hot and cold data in main-memory databases. In *2013 IEEE 29th International Conference on Data Engineering (ICDE)*. IEEE, 26–37.
- [21] Gurmeet Singh Manku and Rajeev Motwani. 2002. Approximate frequency counts over data streams. In *VLDB'02: Proceedings of the 28th International Conference on Very Large Databases*. Elsevier, 346–357.
- [22] Yoshinori Matsunobu, Siying Dong, and Herman Lee. 2020. Myrocks: Lsm-tree database storage engine serving facebook's social graph. *Proceedings of the VLDB Endowment* 13, 12 (2020), 3217–3230.
- [23] Sara McAllister, Benjamin Berg, Julian Tutuncu-Macias, Juncheng Yang, Sathya Gunasekar, Jimmy Lu, Daniel S Berger, Nathan Beckmann, and Gregory R Ganger. 2021. Kangaroo: Caching billions of tiny objects on flash. In *Proceedings of the ACM SIGOPS 28th Symposium on Operating Systems Principles*. 243–262.
- [24] Prashanth Menon, Thamir M Qadah, Tilmann Rabl, Mohammad Sadoghi, and Hans-Arno Jacobsen. 2020. Logstore: A workload-aware, adaptable key-value store on hybrid storage systems. *IEEE Transactions on Knowledge and Data Engineering* 34, 8 (2020), 3867–3882.
- [25] Meta. 2012. RocksDB: A Persistent Key-Value Store for Flash and RAM Storage. <https://github.com/facebook/rocksdb/>.
- [26] Meta. 2021. Memory usage in RocksDB. <https://github.com/facebook/rocksdb/wiki/Memory-usage-in-RocksDB>.
- [27] Meta. 2022. SecondaryCache (Experimental). [https://github.com/facebook/rocksdb/wiki/SecondaryCache-\(Experimental\)](https://github.com/facebook/rocksdb/wiki/SecondaryCache-(Experimental)).
- [28] Ahmed Metwally, Divyakant Agrawal, and Amr El Abbadi. 2005. Efficient computation of frequent and top-k elements in data streams. In *International conference on database theory*. Springer, 398–412.
- [29] Patrick O'Neil, Edward Cheng, Dieter Gawlick, and Elizabeth O'Neil. 1996. The log-structured merge-tree (LSM-tree). *Acta Informatica* 33 (1996), 351–385.
- [30] Ashwini Raina, Jianan Lu, Asaf Cidon, and Michael J Freedman. 2023. Efficient Compactions between Storage Tiers with PrismDB. In *Proceedings of the 28th ACM International Conference on Architectural Support for Programming Languages and Operating Systems, Volume 3*. 179–193.
- [31] Zhiqi Wang and Zili Shao. 2023. MirrorKV: An Efficient Key-Value Store on Hybrid Cloud Storage with Balanced Performance of Compaction and Querying. *Proceedings of the ACM on Management of Data* 1, 4 (2023), 1–27.
- [32] Fenggang Wu, Ming-Hong Yang, Baoquan Zhang, and David HC Du. 2020. AC-Key: Adaptive Caching for LSM-based Key-Value Stores. In *2020 USENIX Annual Technical Conference (USENIX ATC 20)*. 603–615.
- [33] Kingbo Wu, Li Zhang, Yandong Wang, Yufei Ren, Michel Hack, and Song Jiang. 2016. zexpander: A key-value cache with both high performance and fewer misses. In *Proceedings of the Eleventh European Conference on Computer Systems*. 1–15.
- [34] Juncheng Yang, Yao Yue, and K. V. Rashmi. 2020. A large scale analysis of hundreds of in-memory cache clusters at Twitter. In *14th USENIX Symposium on Operating Systems Design and Implementation (OSDI 20)*. USENIX Association, 191–208. <https://www.usenix.org/conference/osdi20/presentation/yang>
- [35] Lei Yang, Hong Wu, Tiejing Zhang, Xuntao Cheng, Feifei Li, Lei Zou, Yujie Wang, Rongyao Chen, Jianying Wang, and Gui Huang. 2020. Leaper: A learned prefetcher for cache invalidation in LSM-tree based storage engines. *Proceedings of the VLDB Endowment* 13, 12 (2020), 1976–1989.
- [36] Hobin Yoon, Juncheng Yang, Sveinn Fannar Kristjansson, Steinn E Sigurdarson, Ymir Vigfusson, and Ada Gavrilovska. 2018. Mutant: Balancing storage cost and latency in lsm-tree data stores. In *Proceedings of the ACM Symposium on Cloud Computing*. 162–173.
- [37] Huanchen Zhang, David G Andersen, Andrew Pavlo, Michael Kaminsky, Lin Ma, and Rui Shen. 2016. Reducing the storage overhead of main-memory OLTP databases with hybrid indexes. In *Proceedings of the 2016 International Conference on Management of Data*. 1567–1581.
- [38] Huanchen Zhang, Hyeontaek Lim, Viktor Leis, David G Andersen, Michael Kaminsky, Kimberly Keeton, and Andrew Pavlo. 2018. Surf: Practical range query filtering with fast succinct tries. In *Proceedings of the 2018 International Conference on Management of Data*. 323–336.
- [39] Jianshun Zhang, Fang Wang, and Chao Dong. 2022. HaLSM: A Hotspot-aware LSM-tree based Key-Value Storage Engine. In *2022 IEEE 40th International Conference on Computer Design (ICCD)*. IEEE, 179–186.
- [40] Teng Zhang, Jian Tan, Xin Cai, Jianying Wang, Feifei Li, and Jianling Sun. 2022. SA-LSM: optimize data layout for LSM-tree based storage using survival analysis. *Proceedings of the VLDB Endowment* 15, 10 (2022), 2161–2174.
- [41] Chang Guo Zhang Cao, Ziyuan Lv, Anand Ananthabhotla, and Zhichao Cao. 2024. SAS-Cache: A Semantic-Aware Secondary Cache for LSM-based Key-Value Stores. In *The 38th International Conference on Massive Storage Systems and Technology (MSST 2024)*.
- [42] Xinjing Zhou, Xiangyao Yu, Goetz Graefe, and Michael Stonebraker. 2023. Two is better than one: The case for 2-tree for skewed data sets. *memory* 11 (2023), 13.
- [43] Yuanhui Zhou, Jian Zhou, Shuning Chen, Peng Xu, Peng Wu, Yanguang Wang, Xian Liu, Ling Zhan, and Jiguang Wan. 2023. Calcspar: A Contract-Aware LSM Store for Cloud Storage with Low Latency Spikes. In *2023 USENIX Annual Technical Conference (USENIX ATC 23)*. 451–465.