

Analysis of the electromagnetic form factors and the radiative decays of the vector heavy-light mesons

Jie Lu^{1,2}, Guo-Liang Yu^{1,2,*}, Zhi-Gang Wang^{1,†} and Bin Wu¹

¹ *Department of Mathematics and Physics, North China Electric Power University, Baoding 071003, People's Republic of China*

² *Hebei Key Laboratory of Physics and Energy Technology, North China Electric Power University, Baoding 071000, China*

(Dated: March 5, 2024)

In this article, we analyze the electromagnetic form factors of the vector heavy-light mesons to the pseudoscalar heavy-light mesons in the framework of three-point QCD sum rules, where the contributions of vacuum condensate terms $\langle \bar{q}q \rangle$, $\langle \bar{q}g_s \sigma G q \rangle$, $\langle g_s^2 G^2 \rangle$, $\langle f^3 G^3 \rangle$ and $\langle \bar{q}q \rangle \langle g_s^2 G^2 \rangle$ are considered. With these results, we also obtain the radiative decay widths of the vector heavy-light mesons and then compare our results with those of other collaboration's. The final results about the radiative decay widths are $\Gamma(D^{*0} \rightarrow D^0 \gamma) = 1.74^{+0.40}_{-0.37}$ keV, $\Gamma(D^{*+} \rightarrow D^+ \gamma) = 0.17^{+0.08}_{-0.07}$ keV, $\Gamma(D_s^* \rightarrow D_s \gamma) = 0.029^{+0.009}_{-0.008}$ keV, $\Gamma(B^{*0} \rightarrow B^0 \gamma) = 0.018^{+0.006}_{-0.005}$ keV, $\Gamma(B^{*+} \rightarrow B^+ \gamma) = 0.015^{+0.007}_{-0.007}$ keV and $\Gamma(B_s^* \rightarrow B_s \gamma) = 0.016^{+0.003}_{-0.005}$ keV.

I. INTRODUCTION

As one of the most interesting research areas in particle physics, the experimental and theoretical investigations about the heavy flavor hadrons have been developing rapidly. This is due to their key roles in both understanding of QCD long-distance dynamics, and the determination of the fundamental parameters of the standard model (SM). Especially, the decay behavior of heavy flavor hadrons is an important and interesting research topic for testing the SM and finding new physics beyond the SM. These decay processes can be classified into leptonic, semileptonic and nonleptonic decays which involve both electroweak and strong interactions. However, theoretical investigations about the heavy hadrons is very difficult because the QCD is non-perturbative in low energy regions. Therefore, many phenomenological approaches[1–34] have been employed to analyze the decay processes of the heavy flavor hadrons.

The QCD sum rules (QCDSR) is one of the most powerful non-perturbative approach, and has been widely used to analyze the mass spectra and the decay behavior of hadrons [35–50]. In recent years, some tasks were carried out by three-point QCDSR, such as the analysis of electroweak and electromagnetic form factors[12, 51–57], and the strong coupling constants [58–68]. These parameters are very important to analyze the decay process of hadrons. In our previous work, the $B_c^* \rightarrow B_c$ electromagnetic form factor were studied by three-point QCDSR, and the corresponding radiative decay $B_c^* \rightarrow B_c \gamma$ was calculated[69]. In Ref[70], we analyzed the momentum dependent strong coupling constant $G_{D_s^* D_s \phi}(Q^2)$. According vector meson dominant(VMD), the electromagnetic coupling constant $G_{D_s^* D_s \gamma}$ was also obtained by setting $Q^2 = 0$. And the radiative decay width for $D_s^* \rightarrow D_s \gamma$ was determined to be 0.59 ± 0.15 keV. As a continuation of these works, we systematically analyze the electromagnetic form factors of vector heavy-light mesons to pseudoscalar

heavy-light mesons. Based on these results, the decay widths about vector heavy-light mesons to pseudoscalar heavy-light mesons plus a photon are obtained. Although some radiative decays, such as $D^{*+} \rightarrow D^+ \gamma$, $D^{*0} \rightarrow D^0 \gamma$ and $D_s^* \rightarrow D_s \gamma$ were already analyzed by other research groups[21–24, 51]. However, these results were obtained by different methods and not consistent well with each other, which needs further confirmation by other theoretical methods.

The experimental data for the radiative decay of the vector meson D^{*+} in Particle Data Group(PDG)[71] is $\Gamma_{Total}(D^{*+}) = 83.4 \pm 1.8$ keV, and $\frac{\Gamma(D^{*+} \rightarrow D^+ \gamma)}{\Gamma_{Total}(D^{*+})} \approx 1.6 \pm 0.4\%$. The decay widths for D^{*0} and D_s^* are given as $\Gamma_{Total}(D^{*0}) < 2.1$ MeV, $\frac{\Gamma(D^{*0} \rightarrow D^0 \gamma)}{\Gamma_{Total}(D^{*0})} \approx 35.3 \pm 0.9\%$, and $\Gamma_{Total}(D_s^*) < 1.9$ MeV, $\frac{\Gamma(D_s^* \rightarrow D_s \gamma)}{\Gamma_{Total}(D_s^*)} \approx (93.5 \pm 0.7)\%$, respectively. However, more exact values about these decays have not been determined yet. For the mesons $B^{*\pm(0)}$ and B_s^* , the radiative decays as their main decay channels have not been determined in experiment. In general, more exact experimental results and theoretical predictions need to be provided, which can help us to understand the nature of the mesons and test the theoretical models.

The layout of this paper is as follows, After introduction in Sec. I, the radiative decays of the vector heavy-light mesons are analyzed in the framework of SM in Sec. II, and the electromagnetic form factor is introduced. In Sec. III, we systematically analyze the electromagnetic form factors of vector heavy-light meson to pseudoscalar heavy-light meson by the three-point QCDSR, where the contributions of perturbative part and vacuum condensate including $\langle \bar{q}q \rangle$, $\langle \bar{q}g_s \sigma G q \rangle$, $\langle g_s^2 G^2 \rangle$, $\langle f^3 G^3 \rangle$ and $\langle \bar{q}q \rangle \langle g_s^2 G^2 \rangle$ are considered in QCD side. Sec. IV is employed to present the numerical results and discussions. Sec. V is reserved as conclusions. Some important figures are shown in Appendix.

II. THE RADIATIVE DECAY OF VECTOR HEAVY-LIGHT MESONS

To analyze the radiative decay of vector heavy-light mesons(\mathbb{V}) to pseudoscalar heavy-light mesons(\mathbb{P}) ($\mathbb{V} \rightarrow \mathbb{P}\gamma$), we firstly write the following electromagnetic lagrangian

*Electronic address: yuguoliang2011@163.com

†Electronic address: zgwang@aliyun.com

\mathcal{L}_{EM} ,

$$\mathcal{L}_{EM} = -e_Q \bar{Q} \gamma_\mu Q A^\mu - e_q \bar{q} \gamma_\mu q A^\mu \quad (1)$$

where A^μ is the electromagnetic field, q and Q denote the light (u, d or s) and heavy (c, b) quarks. e_q and e_Q are electric charges which are taken as $-\frac{1}{3}e$ for d, s and b quarks, and $\frac{2}{3}e$ for u and c quarks. The assignments of \mathbb{P} , \mathbb{V} , Q and q for different decay modes are shown in Table I.

TABLE I: The assignments of \mathbb{P} , \mathbb{V} , Q and q for different decay modes.

Mode	\mathbb{P}	\mathbb{V}	Q	q
$D^{*+} \rightarrow D^+ \gamma$	D^+	D^{*+}	c	d
$D^{*0} \rightarrow D^0 \gamma$	D^0	D^{*0}	c	u
$D_s^{*+} \rightarrow D_s^+ \gamma$	D_s^+	D_s^{*+}	c	s
$B_s^{*-} \rightarrow B_s^- \gamma$	B_s^-	B_s^{*-}	b	u
$\bar{B}^{*0} \rightarrow \bar{B}^0 \gamma$	\bar{B}^0	\bar{B}^{*0}	b	d
$B_s^{*0} \rightarrow B_s^0 \gamma$	B_s^0	B_s^{*0}	b	s

From this lagrangian(Eq. (1)), the decay amplitude can be expressed as the following form,

$$\begin{aligned} & \langle \mathbb{P}(p') \gamma(q) | \mathcal{L}_{EM} | \mathbb{V}(p) \rangle \\ &= \langle \mathbb{P}(p') \gamma(q) | (-e_Q \bar{Q} \gamma_\mu Q - e_q \bar{q} \gamma_\mu q) A^\mu | \mathbb{V}(p) \rangle \\ &= -\langle \gamma(q) | A^\mu | 0 \rangle \langle \mathbb{P}(p') | (e_Q \bar{Q} \gamma_\mu Q + e_q \bar{q} \gamma_\mu q) | \mathbb{V}(p) \rangle \quad (2) \end{aligned}$$

with

$$\begin{aligned} & \langle \mathbb{P}(p') | e_Q \bar{Q} \gamma_\mu Q + e_q \bar{q} \gamma_\mu q | \mathbb{V}(p) \rangle \\ &= \varepsilon_{\mu\sigma\alpha\beta} \zeta^\sigma p^\alpha p'^\beta \frac{V(q^2)}{m_{\mathbb{V}} + m_{\mathbb{P}}} \quad (3) \end{aligned}$$

where $V(q^2)$ is electromagnetic form factor, p^α and p'^β are four momentum of the vector and pseudoscalar heavy-light mesons, and ζ^σ is the polarization vector of vector heavy-light mesons. According to Eqs. (2) and (3), the decay amplitude finally can be written as,

$$\begin{aligned} & \langle \mathbb{P}(p') \gamma(q) | \mathcal{L}_{EM} | \mathbb{V}(p) \rangle \\ &= \varepsilon_{\mu\sigma\alpha\beta} \zeta^\sigma p^\alpha p'^\beta \frac{V(0)}{m_{\mathbb{V}} + m_{\mathbb{P}}} (-i) \eta^\mu \quad (4) \end{aligned}$$

where η_μ is the polarization vector of the photon. This decay process can be explicitly illustrated by feynman diagrams in Fig. 1.

III. QCDSR FOR THE ELECTROMAGNETIC FORM FACTORS

To study the electromagnetic form factor of the vector heavy-light meson to the pseudoscalar heavy-light meson, we firstly write down the three-point correlation function,

$$\begin{aligned} \Pi_{\mu\nu}(p, p') &= i^2 \int d^4x d^4y e^{ip'x} e^{i(p-p')y} \\ &\times \langle 0 | T \{ J_{\mathbb{P}}(x) j_\mu(y) J_{\mathbb{V}}^+(0) \} | 0 \rangle \quad (5) \end{aligned}$$

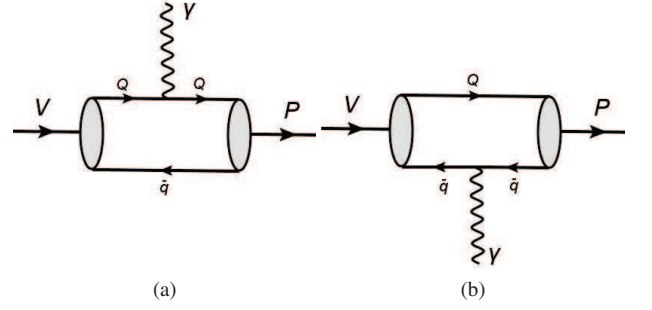

FIG. 1: The feynman diagrams of radiative decay for $\mathbb{V} \rightarrow \mathbb{P} \gamma$.

where T denotes the time ordered product, $J_{\mathbb{P}}$ and $J_{\mathbb{V}}^+$ are the interpolating currents of the pseudoscalar and vector heavy-light mesons, and j_μ is the electromagnetic current. These currents are taken as the following forms,

$$\begin{aligned} J_{\mathbb{P}}(x) &= \bar{q}(x) i \gamma_5 Q(x) \\ j_\mu(y) &= e_Q \bar{Q}(y) \gamma_\mu Q(y) + e_q \bar{q}(y) \gamma_\mu q(y) \\ J_{\mathbb{V}}(0) &= \bar{q}(0) \gamma_\nu Q(0) \quad (6) \end{aligned}$$

In the framework of QCDSR, the correlation function will be calculated at two sides which are called the phenomenological side and the QCD side. Then, according to the quark hadron duality, the calculations of these two sides will be coordinated and the sum rules for electromagnetic form factor in the hadronic level can be obtained.

A. The Phenomenological side

In the phenomenological side, a complete sets of hadronic states with the same quantum numbers as the interpolating currents $J_{\mathbb{P}}$ and $J_{\mathbb{V}}^+$ are inserted into the correlation function. By using the dispersion relation, the correlation function can be written as[72],

$$\begin{aligned} \Pi_{\mu\nu}^{\text{phy}}(p, p') &= \frac{\langle 0 | J_{\mathbb{P}}(0) | \mathbb{P}(p') \rangle \langle \mathbb{V}(p) | J_{\mathbb{V}}^+(0) | 0 \rangle}{(m_{\mathbb{V}}^2 - p^2)(m_{\mathbb{P}}^2 - p'^2)} \\ &\times \langle \mathbb{P}(p') | j_\mu(y) | \mathbb{V}(p) \rangle + h.c. \quad (7) \end{aligned}$$

where $h.c.$ represents the contributions coming from higher resonances and continuum states. The hadronic matrix elements are defined by the following parameterized equations,

$$\begin{aligned} \langle 0 | J_{\mathbb{P}}(0) | \mathbb{P}(p') \rangle &= \frac{f_{\mathbb{P}} m_{\mathbb{P}}^2}{m_q + m_Q} \\ \langle \mathbb{V}(p) | J_{\mathbb{V}}^+(0) | 0 \rangle &= f_{\mathbb{V}} m_{\mathbb{V}} \zeta_\nu^* \\ \langle \mathbb{P}(p') | j_\mu(y) | \mathbb{V}(p) \rangle &= \varepsilon_{\mu\sigma\alpha\beta} \zeta^\sigma p^\alpha p'^\beta \frac{V(q^2)}{m_{\mathbb{V}} + m_{\mathbb{P}}} \quad (8) \end{aligned}$$

with $q = p - p'$. In these above equations, $f_{\mathbb{P}}$ and $f_{\mathbb{V}}$ are the decay constants of the pseudoscalar and vector heavy-light mesons, $\varepsilon_{\mu\sigma\alpha\beta}$ is the Levi-Civita tensor, and $V(q^2)$ is the electromagnetic form factor. ζ_ν is the polarization vector of vector

heavy-light meson with the following properties,

$$\zeta_v^* \zeta_\sigma = -g_{v\sigma} + \frac{p_\nu p_\sigma}{p^2} \quad (9)$$

With these above equations, the correlation function in phenomenological side can be expressed as the following form,

$$\begin{aligned} \Pi_{\mu\nu}^{\text{phy}}(p, p') &= -\frac{f_{\mathbb{P}} m_{\mathbb{P}}^2 f_{\mathbb{V}} m_{\mathbb{V}}}{(m_q + m_Q)(m_{\mathbb{V}} + m_{\mathbb{P}})} \\ &\times \frac{V(q^2) \varepsilon_{\mu\nu\alpha\beta} p^\alpha p'^\beta}{(m_{\mathbb{V}}^2 - p^2)(m_{\mathbb{P}}^2 - p'^2)} + h.c. \\ &= \Pi^{\text{phy}}(p, p') \varepsilon_{\mu\nu\alpha\beta} p^\alpha p'^\beta + h.c. \end{aligned} \quad (10)$$

where $\Pi^{\text{phy}}(p, p')$ is called scalar invariant amplitude, $\varepsilon_{\mu\nu\alpha\beta} p^\alpha p'^\beta$ is the corresponding tensor structure.

B. The QCD side

In this part, we firstly contract the quark field with Wick's theorem, and then do the operator product expansion(OPE). After contraction of the quark field, the correlation function in QCD side can be expressed as,

$$\begin{aligned} \Pi_{\mu\nu}^{\text{QCD}}(p, p') &= -i \int d^4x d^4y e^{ip'x} e^{i(p-p')y} \\ &\times \{e_Q \text{Tr}[S_Q^{nk}(y) \gamma_\nu S_q^{km}(-x) \gamma_5 S_Q^{mn}(x-y) \gamma_\mu] \\ &+ e_q \text{Tr}[S_Q^{nk}(x) \gamma_\nu S_q^{km}(-y) \gamma_\mu S_q^{mn}(y-x) \gamma_5]\} \\ &= e_Q \Pi_{1\mu\nu}(p, p') + e_q \Pi_{2\mu\nu}(p, p') \end{aligned} \quad (11)$$

where $S_q^{mn}(x)$ and $S_Q^{mn}(x)$ are the full propagators of light and heavy quarks, and they have the following forms[73, 74],

$$\begin{aligned} S_q^{mn}(x) &= \frac{i\delta^{mn} \not{x}}{2\pi^2 x^4} - \frac{\delta^{mn} m_q}{4\pi^2 x^4} - \frac{\delta^{mn} \langle \bar{q}q \rangle}{12} + \frac{i\delta^{mn} \not{x} m_q \langle \bar{q}q \rangle}{48} \\ &- \frac{\delta^{mn} x^2 \langle \bar{q}g_s \sigma Gq \rangle}{192} + \frac{i\delta^{mn} x^2 \not{x} m_q \langle \bar{q}g_s \sigma Gq \rangle}{1152} \\ &- \frac{ig_s G_{\alpha\beta}^a t^a (\not{x} \sigma^{\alpha\beta} + \sigma^{\alpha\beta} \not{x})}{32\pi^2 x^2} - \frac{i\delta^{mn} x^2 \not{x} g_s^2 \langle \bar{q}q \rangle^2}{7776} \\ &- \frac{\delta^{mn} x^4 \langle \bar{q}q \rangle \langle g_s^2 GG \rangle}{27648} - \frac{\langle \bar{q}^n \sigma^{\mu\nu} q^m \rangle \sigma_{\mu\nu}}{8} \\ &- \frac{\langle \bar{q}^n \gamma^\mu q^m \rangle \gamma_\mu}{4} + \dots \\ S_Q^{mn}(x) &= \frac{i}{(2\pi)^4} \int d^4k e^{-ikx} \left\{ \frac{\delta^{mn}}{\not{k} - m_Q} \right. \\ &- \frac{g_s G_{\alpha\beta}^a t^a_{mn} \sigma^{\alpha\beta} (\not{k} + m_Q) + (\not{k} + m_b) \sigma^{\alpha\beta}}{4(k^2 - m_Q^2)^2} \\ &+ \frac{g_s D_\alpha G_{\beta\lambda}^a t^a_{mn} (f^{\lambda\beta\alpha} + f^{\lambda\alpha\beta})}{3(k^2 - m_Q^2)^4} \\ &- \frac{g_s^2 (t^a t^b)_{mn} G_{\alpha\beta}^a G_{\mu\nu}^b (f^{\alpha\beta\mu\nu} + f^{\alpha\mu\beta\nu} + f^{\alpha\nu\mu\beta})}{4(k^2 - m_Q^2)^5} \\ &+ \dots \} \end{aligned} \quad (12)$$

Here, $\langle g_s^2 GG \rangle = \langle g_s^2 G_{\alpha\beta}^a G^{a\alpha\beta} \rangle$, $D_\alpha = \partial_\alpha - ig_s G_\alpha^a t^a$, $t^a = \frac{\lambda^a}{2}$. $\lambda^a (a=1, \dots, 8)$ are the Gell-Mann matrices, m and n are color indices, q denotes the light quarks(u, d, and s), Q represents the heavy quarks(c and b), $\sigma_{\alpha\beta} = \frac{1}{2}[\gamma_\alpha, \gamma_\beta]$, and $f^{\lambda\alpha\beta}$, $f_{\alpha\beta\mu\nu}$ have the following forms,

$$f^{\lambda\alpha\beta} = (\not{k} + m_Q) \gamma^\lambda (\not{k} + m_Q) \gamma^\alpha (\not{k} + m_Q) \gamma^\beta (\not{k} + m_Q) \quad (13)$$

$$f^{\alpha\beta\mu\nu} = \frac{(\not{k} + m_Q) \gamma^\alpha (\not{k} + m_Q) \gamma^\beta (\not{k} + m_Q) \gamma^\mu (\not{k} + m_Q) \gamma^\nu (\not{k} + m_Q)}{(\not{k} + m_Q) \gamma^\nu (\not{k} + m_Q)} \quad (14)$$

From these above equations, the correlation function in QCD side(Eq. (11)) can also be transformed into the following form,

$$\Pi_{\mu\nu}^{\text{QCD}}(p, p') = \Pi^{\text{QCD}}(p^2, p'^2, q^2) \varepsilon_{\mu\nu\alpha\beta} p^\alpha p'^\beta \quad (15)$$

where Π^{QCD} is the scalar invariant amplitude in QCD side, and it can be divided into several parts according to different condensate terms,

$$\begin{aligned} \Pi^{\text{QCD}} &= \Pi^{\text{pert}} + \Pi^{\langle \bar{q}q \rangle} + \Pi^{\langle g_s^2 G^2 \rangle} + \Pi^{\langle \bar{q}g_s \sigma Gq \rangle} \\ &+ \Pi^{\langle f^3 G^3 \rangle} + \Pi^{\langle \bar{q}q \rangle \langle g_s^2 G^2 \rangle} + \dots \end{aligned} \quad (16)$$

Here, Π^{pert} represents the perturbative part, and $\Pi^{\langle \bar{q}q \rangle}$, $\Pi^{\langle g_s^2 G^2 \rangle}$, $\Pi^{\langle \bar{q}g_s \sigma Gq \rangle}$, $\Pi^{\langle f^3 G^3 \rangle}$ and $\Pi^{\langle \bar{q}q \rangle \langle g_s^2 G^2 \rangle}$ are the vacuum condensate terms with dimension 3, 4, 5, 6 and 7, respectively. The perturbative part and the gluon condensate terms $\Pi^{\langle g_s^2 G^2 \rangle}$ and $\Pi^{\langle f^3 G^3 \rangle}$ can be written as the following form according to the dispersion relation,

$$\Pi(p, p') = - \int_{s_1}^{\infty} \int_{u_1}^{\infty} \frac{\rho(s, u, q^2)}{(s - p^2)(u - p'^2)} ds du$$

where $\rho(s, u, q^2)$ is the QCD spectral density and it can be represented as,

$$\begin{aligned} \rho(s, u, q^2) &= \rho^{\text{pert}}(s, u, q^2) + \rho^{\langle g_s^2 G^2 \rangle}(s, u, q^2) \\ &+ \rho^{\langle f^3 G^3 \rangle}(s, u, q^2) \end{aligned} \quad (17)$$

with $s = p^2$, $u = p'^2$ and $q = p - p'$.

For the perturbative part, we firstly substitute the free propagator of heavy and light quarks in the momentum space in Eq. (11). Then, the correlation function can be expressed as the following form after performing the integrations in the coordinate and momentum space,

$$\begin{aligned} \Pi_{\mu\nu}^{\text{pert}}(p, p') &= -\frac{3}{(2\pi)^4} \int d^4k \\ &\times \{e_Q \frac{\text{Tr}[(\not{k} + \not{q} + m_Q) \gamma_\nu (\not{k} - \not{p}' + m_Q) \gamma_5 (\not{k} + m_Q) \gamma_\mu]}{[(k+q)^2 - m_Q^2][(k-p')^2 - m_Q^2](k^2 - m_Q^2)} \\ &+ e_q \frac{\text{Tr}[(\not{k} + \not{p}' + m_Q) \gamma_\nu (\not{k} - \not{q} + m_Q) \gamma_\mu (\not{k} + m_Q) \gamma_5]}{[(k+p')^2 - m_Q^2][(k-q)^2 - m_Q^2](k^2 - m_Q^2)}\} \\ &= e_Q \Pi_{1\mu\nu}^{\text{pert}}(p, p') + e_q \Pi_{2\mu\nu}^{\text{pert}}(p, p') \end{aligned} \quad (18)$$

Then, the QCD spectral density for the perturbative contribution can be obtained by putting all the quark lines on mass-shell using the Cutkosky's rules (see Fig. 2),

$$\begin{aligned}\rho_{1\mu\nu}^{\text{pert}}(s, u, q^2) &= \frac{3}{(2\pi)^3} \int d^4k \delta[(k+q)^2 - m_Q^2] \\ &\times \delta[(k-p')^2 - m_q^2] \delta(k^2 - m_Q^2) \text{Tr}[(\not{k} + \not{q} + m_Q)\gamma_\nu \\ &\times (\not{k} - \not{p}' + m_q)\gamma_5(\not{k} + m_Q)\gamma_\mu] \\ \rho_{2\mu\nu}^{\text{pert}}(s, u, q^2) &= -\frac{3}{(2\pi)^3} \int d^4k \delta[(k-p')^2 - m_Q^2] \\ &\times \delta[(k+q)^2 - m_q^2] \delta(k^2 - m_q^2) \text{Tr}[(\not{k} - \not{p}' - m_Q)\gamma_\nu \\ &\times (\not{k} + \not{q} - m_q)\gamma_\mu(\not{k} - m_q)\gamma_5]\end{aligned}\quad (19)$$

After performing integrations of these Dirac delta functions

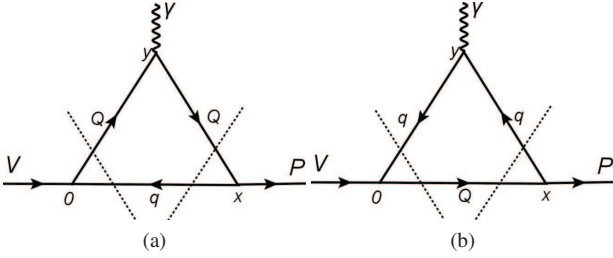

FIG. 2: The feynman diagrams for Π_1^{pert} (a) and Π_2^{pert} (b) in Eq. (18). The dashed lines denote the cutkosky cuts.

in Eq. (19), the spectral density can be expressed as,

$$\begin{aligned}\rho_{1\mu\nu}^{\text{pert}}(s, u, q^2) &= \frac{3}{(2\pi)^3} \frac{\pi}{2\sqrt{\lambda(s, u, q^2)}} \text{Tr}\{[(C_p + 1)\not{p} \\ &+ (C_{p'} - 1)\not{p}' + m_Q]\gamma_\nu [C_p\not{p} + (C_{p'} - 1)\not{p}' + m_q]\gamma_5 \\ &\times (C_p\not{p} + C_{p'}\not{p}' + m_Q)\gamma_\mu\} \\ \rho_{2\mu\nu}^{\text{pert}}(s, u, q^2) &= -\frac{3}{(2\pi)^3} \frac{\pi}{2\sqrt{\lambda(s, u, q^2)}} \text{Tr}\{[C_p'\not{p} \\ &+ (C_{p'}' - 1)\not{p}' - m_Q]\gamma_\nu [(C_p' + 1)\not{p} + (C_{p'}' - 1)\not{p}' \\ &- m_q]\gamma_\mu (C_p'\not{p} + C_{p'}'\not{p}' - m_Q)\gamma_5\}\end{aligned}\quad (20)$$

where,

$$\begin{aligned}C_p &= \frac{(u + m_Q^2 - m_q^2)(s + u - q^2) - 2u(u - q^2 + m_Q^2 - m_q^2)}{\lambda(s, u, q^2)} \\ C_{p'} &= \frac{(u - q^2 + m_Q^2 - m_q^2)(s + u - q^2) - 2s(u + m_Q^2 - m_q^2)}{\lambda(s, u, q^2)} \\ C_p' &= \frac{(u + m_q^2 - m_Q^2)(s + u - q^2) - 2u(u - q^2 + m_q^2 - m_Q^2)}{\lambda(s, u, q^2)} \\ C_{p'}' &= \frac{(u - q^2 + m_q^2 - m_Q^2)(s + u - q^2) - 2s(u + m_q^2 - m_Q^2)}{\lambda(s, u, q^2)} \\ \lambda(s, u, q^2) &= (s + u - q^2)^2 - 4su\end{aligned}\quad (21)$$

As for the gluon condensate terms $\langle g_s^2 G^2 \rangle$ and $\langle f^3 G^3 \rangle$, the following integral will be encountered,

$$I_{ijk} = \int d^4k \frac{1}{[(k+q)^2 - m_1^2]^i [(k-p')^2 - m_2^2]^j (k^2 - m_3^2)^k} \quad (22)$$

This integral can also be calculated by Cutkosky's rules according to the following transformations,

$$\begin{aligned}I_{ijk} &= \frac{1}{(i-1)!(j-1)!(k-1)!} \frac{\partial^{i-1}}{\partial A^{i-1}} \frac{\partial^{j-1}}{\partial B^{j-1}} \frac{\partial^{k-1}}{\partial C^{k-1}} \int d^4k \\ &\times \frac{1}{[(k+q)^2 - A][(k-p')^2 - B](k^2 - C)} \Big|_{A \rightarrow m_1, B \rightarrow m_2, C \rightarrow m_3} \\ &\rightarrow \frac{(-2\pi i)^3}{(2\pi i)^2} \frac{1}{(i-1)!(j-1)!(k-1)!} \frac{\partial^{i-1}}{\partial A^{i-1}} \frac{\partial^{j-1}}{\partial B^{j-1}} \frac{\partial^{k-1}}{\partial C^{k-1}} \\ &\times \int d^4k \delta[(k+q)^2 - A] \delta[(k-p')^2 - B] \\ &\times \delta(k^2 - C) \Big|_{A \rightarrow m_1, B \rightarrow m_2, C \rightarrow m_3} \\ &= \frac{(-2\pi i)^3}{(2\pi i)^2} \frac{1}{(i-1)!(j-1)!(k-1)!} \frac{\partial^{i-1}}{\partial A^{i-1}} \frac{\partial^{j-1}}{\partial B^{j-1}} \frac{\partial^{k-1}}{\partial C^{k-1}} \\ &\times \frac{\pi}{2\sqrt{\lambda(s, u, q^2)}} \Big|_{A \rightarrow m_1, B \rightarrow m_2, C \rightarrow m_3}\end{aligned}\quad (23)$$

Besides of these above contributions, the condensate terms of $\langle \bar{q}q \rangle$, $\langle \bar{q}g_s \sigma G q \rangle$ and $\langle \bar{q}q \rangle \langle g_s^2 G^2 \rangle$ are also taken into account in this work. The feynman diagrams of these condensate terms can be classified into two groups (see Fig. 3 and Fig. 4) which correspond to the correlation functions Π_1 and Π_2 in Eq. (11), respectively.

C. The electromagnetic form factor

We take the change of variables $p^2 \rightarrow -P^2$, $p'^2 \rightarrow -P'^2$ and $q^2 \rightarrow -Q^2$ and perform double Borel transforms [75, 76] for the variables P^2 and P'^2 to both phenomenological and QCD sides. And then P^2 and P'^2 will be replaced by T_1^2 and T_2^2 which are called Borel parameters. After matching the phenomenological and QCD side by using quark-hadron duality, the sum rule for the electromagnetic form factor is obtained as,

$$\begin{aligned}V(Q^2) &= \frac{(m_q + m_Q)(m_{\mathbb{P}} + m_{\mathbb{V}})}{f_{\mathbb{P}} m_{\mathbb{P}}^2 f_{\mathbb{V}} m_{\mathbb{V}}} e^{m_{\mathbb{P}}^2/T_1^2} e^{m_{\mathbb{V}}^2/T_2^2} \\ &\times \left\{ e_Q \left[- \int_{s_1}^{s_0} \int_{u_1}^{u_0} \rho_1(s, u, Q^2) e^{-u/T_1^2} e^{-s/T_2^2} du ds \Big|_{|b_1(s, u, Q^2)| \leq 1} \right. \right. \\ &\left. \left. + \mathcal{B} \mathcal{B} [\Pi_1^{\langle \bar{q}q \rangle} + \Pi_1^{\langle \bar{q}g_s \sigma G q \rangle} + \Pi_1^{\langle \bar{q}q \rangle \langle g_s^2 G^2 \rangle}] \right] \right. \\ &\left. + e_q \left[- \int_{s_1}^{s_0} \int_{u_1}^{u_0} \rho_2(s, u, Q^2) e^{-u/T_1^2} e^{-s/T_2^2} du ds \Big|_{|b_2(s, u, Q^2)| \leq 1} \right] \right\} \\ &= e_Q V_1(Q^2) + e_q V_2(Q^2)\end{aligned}\quad (24)$$

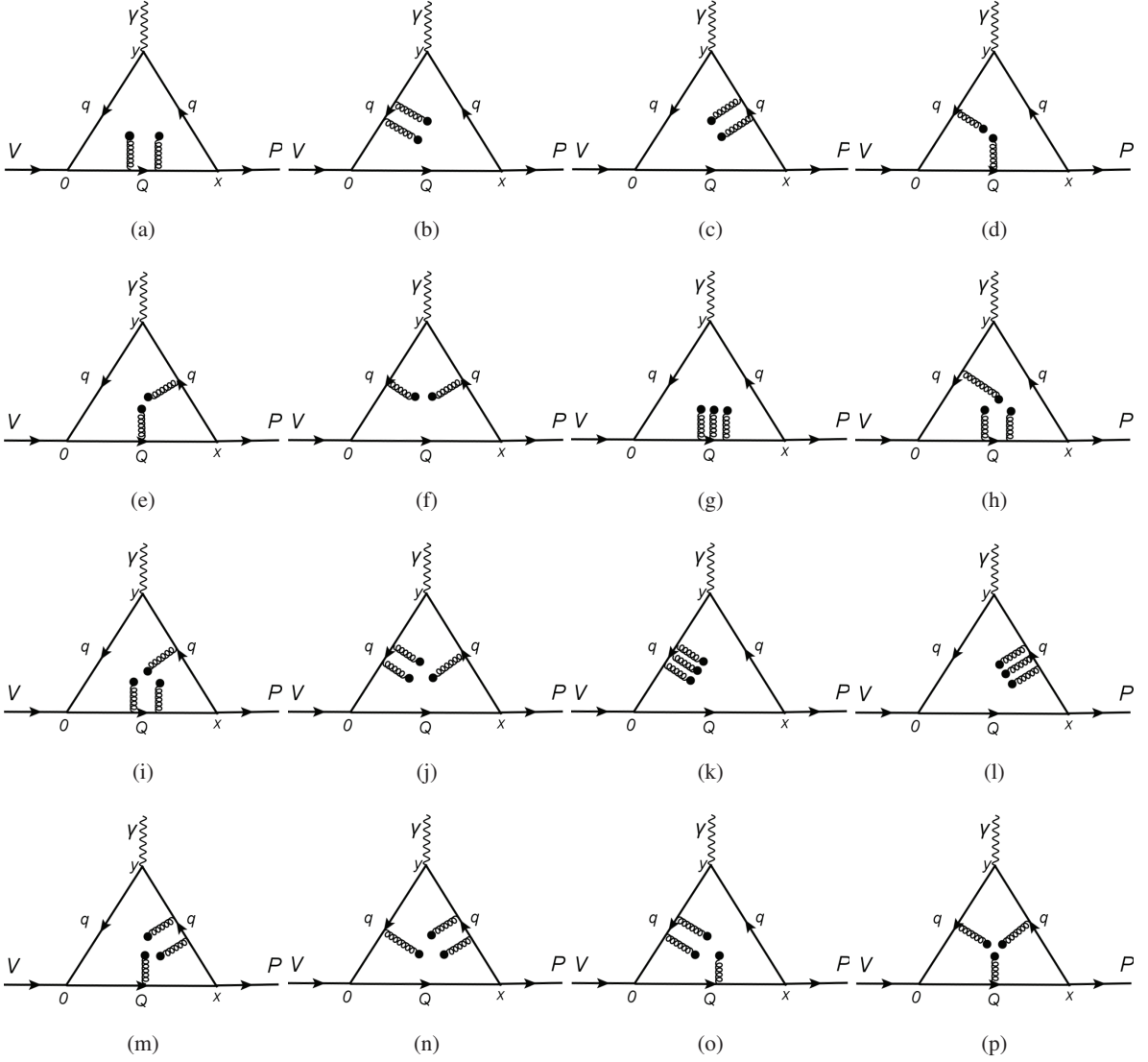

FIG. 4: Feynman diagrams of the vacuum condensate terms $\langle g_s^2 G^2 \rangle$ (a-f) and $\langle f^3 G^3 \rangle$ (g-p) for Π_2 in Eq. (11).

IV. NUMERICAL RESULTS AND DISCUSSIONS

The masses of the heavy and light quarks, and the values of vacuum condensate terms are energy-scale dependent, which can be expressed as the following forms according to the renormalization group equation(RGE),

$$\begin{aligned}
 m_b(\mu) &= m_b(m_b) \left[\frac{\alpha_s(\mu)}{\alpha_s(m_b)} \right]^{\frac{12}{33-2n_f}} \\
 m_c(\mu) &= m_c(m_c) \left[\frac{\alpha_s(\mu)}{\alpha_s(m_c)} \right]^{\frac{12}{33-2n_f}} \\
 m_s(\mu) &= m_s(2\text{GeV}) \left[\frac{\alpha_s(\mu)}{\alpha_s(2\text{GeV})} \right]^{\frac{12}{33-2n_f}} \\
 \langle \bar{q}q \rangle(\mu) &= \langle \bar{q}q \rangle(1\text{GeV}) \left[\frac{\alpha_s(1\text{GeV})}{\alpha_s(\mu)} \right]^{\frac{12}{33-2n_f}}
 \end{aligned}$$

$$\langle \bar{s}s \rangle(\mu) = \langle \bar{s}s \rangle(1\text{GeV}) \left[\frac{\alpha_s(1\text{GeV})}{\alpha_s(\mu)} \right]^{\frac{12}{33-2n_f}}$$

$$\langle \bar{q}g_s\sigma Gq \rangle(\mu) = \langle \bar{q}g_s\sigma Gq \rangle(1\text{GeV}) \left[\frac{\alpha_s(1\text{GeV})}{\alpha_s(\mu)} \right]^{\frac{2}{33-2n_f}}$$

$$\langle \bar{s}g_s\sigma Gs \rangle(\mu) = \langle \bar{s}g_s\sigma Gs \rangle(1\text{GeV}) \left[\frac{\alpha_s(1\text{GeV})}{\alpha_s(\mu)} \right]^{\frac{2}{33-2n_f}}$$

$$\begin{aligned}
 \alpha_s(\mu) &= \frac{1}{b_0 t} \left[1 - \frac{b_1 \log t}{b_0^2 t} \right. \\
 &\quad \left. + \frac{b_1^2 (\log^2 t - \log t - 1) + b_0 b_2}{b_0^4 t^2} \right] \quad (26)
 \end{aligned}$$

where $t = \log \frac{\mu^2}{\Lambda_{QCD}^2}$, $b_0 = \frac{33-2n_f}{12\pi}$, $b_1 = \frac{153-19n_f}{24\pi^2}$, $b_2 = \frac{2857 - \frac{5033}{9}n_f + \frac{325}{27}n_f^2}{128\pi^3}$, $\Lambda_{QCD} = 210 \text{ MeV}, 292 \text{ MeV}$ and 332 MeV for the flavors $n_f = 5, 4$ and 3 , respectively[71]. The $\overline{\text{MS}}$ masses of the heavy and light quarks are adopted from the

PDG[71], where $m_c(m_c) = 1.275 \pm 0.025$ GeV, $m_b(m_b) = 4.18 \pm 0.03$ GeV, $m_{u(d)}(\mu = 1\text{GeV}) = 0.006 \pm 0.001$ GeV and $m_s(\mu = 2\text{GeV}) = 0.095 \pm 0.005$ GeV. As for the values of other input parameters, they are all listed in Table II, where the quark and quark-gluon condensate parameters take their values in the energy scale $\mu = 1$ GeV. Based on our previous researches about the heavy-light mesons[77], the values of decay constants are selected by following energy-scale, where $\mu = 1$ GeV for $D^* \rightarrow D$ electromagnetic form factor, $\mu = 2.5$ GeV for $B^* \rightarrow B$, $\mu = 1.1$ GeV for $D_s^* \rightarrow D_s$ and $\mu = 2.6$ GeV for $B_s^* \rightarrow B_s$.

TABLE II: Input parameters (IP) in this work.

IP	values(GeV)	IP	values
m_D	1.86[71]	f_B	0.192 ± 0.013 GeV[77]
m_{D^*}	2.01[71]	f_{B^*}	0.213 ± 0.018 GeV[77]
m_{D_s}	1.97[71]	f_{B_s}	0.230 ± 0.013 GeV[77]
$m_{D_s^*}$	2.11[71]	$f_{B_s^*}$	0.255 ± 0.019 GeV[77]
m_B	5.28[71]	$\langle \bar{q}q \rangle$	$-(0.23 \pm 0.01)^3$ GeV ³ [74, 78]
m_{B^*}	5.32[71]	$\langle \bar{q}g_s \sigma G q \rangle$	$m_0^2 \langle \bar{q}q \rangle$ [74, 78]
m_{B_s}	5.37[71]	$\langle \bar{s}s \rangle$	$-(0.8 \pm 0.1) \langle \bar{q}q \rangle$ [74, 78]
$m_{B_s^*}$	5.42[71]	$\langle \bar{s}g_s \sigma G s \rangle$	$m_0^2 \langle \bar{s}s \rangle$ [74, 78]
f_D	0.210 ± 0.011 [77]	m_0^2	0.8 ± 0.1 GeV ² [74, 78]
f_{D^*}	0.236 ± 0.021 [77]	$\langle g_s^2 G^2 \rangle$	0.88 ± 0.15 GeV ⁴ [79–81]
f_{D_s}	0.259 ± 0.010 [77]	$\langle f^3 G^3 \rangle$	$(8.8 \pm 5.5) \langle \alpha_s G^2 \rangle$ [79–81]
$f_{D_s^*}$	0.308 ± 0.021 [77]		

In the framework of QCDSR, two criteria should be satisfied, which are the pole dominance and convergence of operator product expansion (OPE). The pole and continuum contribution can be defined as[61],

$$\text{Pole} = \frac{\Pi_{\text{pole}}^{\text{OPE}}(T_1^2, T_2^2)}{\Pi_{\text{pole}}^{\text{OPE}}(T_1^2, T_2^2) + \Pi_{\text{cont}}^{\text{OPE}}(T_1^2, T_2^2)}$$

$$\text{Continuum} = \frac{\Pi_{\text{cont}}^{\text{OPE}}(T_1^2, T_2^2)}{\Pi_{\text{pole}}^{\text{OPE}}(T_1^2, T_2^2) + \Pi_{\text{cont}}^{\text{OPE}}(T_1^2, T_2^2)} \quad (27)$$

with

$$\Pi_{\text{pole}}^{\text{OPE}}(T_1^2, T_2^2) = - \int_{s_1}^{s_0} \int_{u_1}^{u_0} \rho^{\text{OPE}}(s, u, Q^2) e^{-\frac{s}{T_1^2}} e^{-\frac{u}{T_2^2}} ds du$$

$$\Pi_{\text{cont}}^{\text{OPE}}(T_1^2, T_2^2) = - \int_{s_0}^{\infty} \int_{u_0}^{\infty} \rho^{\text{OPE}}(s, u, Q^2) e^{-\frac{s}{T_1^2}} e^{-\frac{u}{T_2^2}} ds du \quad (28)$$

It can be seen from Eqs. (24) and (27) that the results of QCDSR depend on input parameters such as the Borel parameters T_1^2 and T_2^2 , the continuum threshold parameters s_0 and u_0 , and the square momentum Q^2 . In this article, we take $T_1^2 = T^2$ and $T_2^2 = kT_1^2 = kT^2$. k is a constant which is related to the ratio of vector and pseudoscalar heavy-light mesons and can be expressed as $k = \frac{m_V^2}{m_P^2}$. The threshold parameters are defined as $s_0 = (m_V + \Delta_V)^2$ and $u_0 = (m_P + \Delta_P)^2$. The values of Δ_V and Δ_P should be smaller than the experimental value of the distance between the ground and first excited state. Taking the electromagnetic form factor V_1 of $D^* \rightarrow D$ as an example, we simply discuss how to select s_0 and u_0 . Fixing $Q^2 = 1\text{GeV}^2$

in Eq. (28), we firstly plot the electromagnetic form factor V_1 on Borel parameter T^2 in Fig. 5, where different values of s_0 and u_0 are adopted. It is indicated that the results have good stability when s_0 is taken to be 6.30 GeV^2 ($\Delta_V=0.5\text{ GeV}$) and u_0 is 5.57 GeV^2 ($\Delta_P=0.5\text{ GeV}$). Thus, the final results will be obtained by taking $\Delta_V = \Delta_P = 0.4, 0.5$ and 0.6 GeV , where 0.5 GeV is used to determine the central values of the electromagnetic form factors, and $0.4, 0.6\text{ GeV}$ are for the lower and upper bounds of the final results.

An appropriate region of the Borel parameter T^2 needs to be chosen to make the final results stable and reliable. This region is commonly called 'Borel platform'. After repeated trial and contrast, we finally determine the Borel platforms which are shown in Fig. 8 in Appendix. From Fig. 8, we can see that the values of the form factors have good stability in the Borel regions, which means the convergence of OPE is well satisfied. In addition, the pole and continuum contributions in

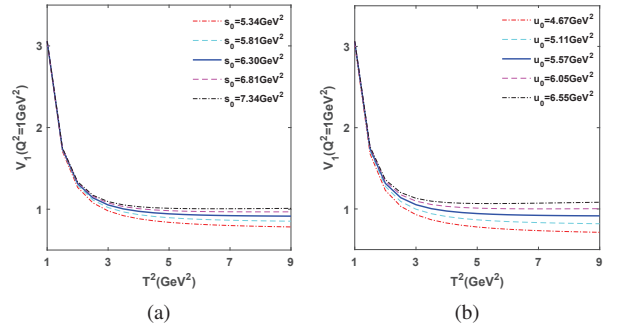

FIG. 5: The $D^* \rightarrow D$ electromagnetic form factor V_1 on Borel parameter T^2 with different s_0 (a) and u_0 (b).

the Borel platforms are plotted in Fig. 9. We can see from Fig. 9 that the central values of pole contribution in the Borel platform satisfy the condition of pole dominance ($> 50\%$). That is to say, two criteria of pole dominance and convergence of OPE are both satisfied. The Borel platform, pole contributions in the Borel platform, and the values of electromagnetic form factors in $Q^2 = 1\text{ GeV}^2$ are listed in Table III.

TABLE III: The Borel platform, pole contributions (Pole) and the values of electromagnetic form-factors in $Q^2 = 1\text{ GeV}^2$ for different radiative decay modes.

Mode	Form factor	Borel platform	Pole(%)	$V_i(Q^2 = 1\text{ GeV}^2)$
$D^* \rightarrow D\gamma$	V_1	3 ~ 5	60 ~ 44	$0.97^{+0.10}_{-0.09}$
	V_2	3.5 ~ 5.5	68 ~ 44	$0.69^{+0.17}_{-0.16}$
$D_s^* \rightarrow D_s\gamma$	V_1	4.5 ~ 6.5	58 ~ 42	$0.98^{+0.12}_{-0.11}$
	V_2	5 ~ 7	64 ~ 46	$0.95^{+0.20}_{-0.17}$
$B^* \rightarrow B\gamma$	V_1	11 ~ 13	53 ~ 46	$1.42^{+0.13}_{-0.12}$
	V_2	12 ~ 14	58 ~ 49	$2.54^{+0.46}_{-0.47}$
$B_s^* \rightarrow B_s\gamma$	V_1	13 ~ 15	52 ~ 45	$1.30^{+0.12}_{-0.13}$
	V_2	15 ~ 17	57 ~ 50	$3.00^{+0.45}_{-0.48}$

By taking different values of Q^2 , the electromagnetic form factors $V_i(Q^2)$ in space-like regions ($Q^2 > 0$) can be obtained, where Q^2 is in the range of $0.5 \sim 5.5\text{ GeV}^2$ for $V_1(Q^2)$, and

$1 \sim 6 \text{ GeV}^2$ for $V_2(Q^2)$. For the values of the electromagnetic form factors at $Q^2 = 0$, which are used to analyze the radiative decay of the vector heavy-light mesons, they can be obtained by extrapolating the results $V_i(Q^2)$ into $Q^2 = 0$. This process is realized by selecting appropriate analytical functions to fit the results $V_i(Q^2)$ in space-like region. In general, the single pole fitting or exponential fitting are usually used to roughly parameterize the electroweak form factors. More precise and physical method is the z -series expansion which is used to extrapolate the heavy-to-light electroweak form factors to large momentum transfer regions ($q^2 = -Q^2 \gg 0$) [82–84]. For the electromagnetic form factors of vector heavy-light mesons to pseudoscalar heavy-light mesons, both the initial and final states are heavy mesons, and we only take care of the values at $Q^2 = 0$. Thus, we do not directly employ the z -series expansion method to fit the electromagnetic form factors. After repeated trial and error, we find that the results in space-like regions ($Q^2 > 0$) can be well fitted by the combinations of the single pole, exponential and polynomial functions. In addition, we know that the series expansion of the exponential function and z -series expansion are essentially consistent with each other in their mathematical form. Thus, the simple parameterizations method is adopted to fit the form factors in this work, and it has the following form,

$$V_i(Q^2) = \frac{A}{1 + BQ^2} \text{Exp}(-CQ^2) + D \quad (29)$$

where A , B , C and D are the fitting parameters and their values are listed in Table IV. The fitting results are also explicitly shown in Figs. 6 and 7. By setting $Q^2 = 0$ in the analytical functions (Eq. (29)), the values of electromagnetic form factors in $Q^2 = 0$ ($V_i(0)$) are obtained, which are also listed in the last column of Table IV.

TABLE IV: The parameters for the analysis function and the values of electromagnetic form factors in $Q^2 = 0$ for different radiative decay modes.

Mode	Form factor	A	B	C	D	$V_i(0)$
$D^* \rightarrow D\gamma$	V_1	1.01	1.18	-0.0006	0.53	$1.54^{+0.08}_{-0.11}$
	V_2	1.33	0	0.56	-0.04	$1.29^{+0.23}_{-0.21}$
$D_s^* \rightarrow D_s\gamma$	V_1	0.70	0	0.40	0.53	$1.23^{+0.19}_{-0.18}$
	V_2	1.62	0	0.57	0.04	$1.65^{+0.26}_{-0.24}$
$B^* \rightarrow B\gamma$	V_1	1.62	0	1.93	1.22	$2.85^{+0.67}_{-0.64}$
	V_2	5.00	0	0.67	-0.04	$4.96^{+0.54}_{-0.46}$
$B_s^* \rightarrow B_s\gamma$	V_1	1.54	5.46	0.0002	1.09	$2.62^{+0.31}_{-0.65}$
	V_2	5.19	0	0.57	0.01	$5.20^{+0.61}_{-0.56}$

According to the heavy-hadron chiral perturbation theory, the relation of the form factors $\frac{V_1(0)}{V_2(0)} < 1$ should be satisfied [85]. From Table IV, we find the values of $\frac{V_1(0)}{V_2(0)}$ for $D_s^* \rightarrow D_s$, $B^* \rightarrow B$ and $B_s^* \rightarrow B_s$ are all lower than 1, which means the results are consistent well with the conclusion of heavy-hadron chiral perturbation theory. For the form factor of $D^* \rightarrow D$, the central value of $V_1(0)$ is slightly larger than that of $V_2(0)$, which looks as if these results are contradict with the conclusion of chiral perturbation theory. Actually, if we consider the error bar of the results, the relation $\frac{V_1(0)}{V_2(0)} < 1$

is still roughly satisfied. It is known that the next-to-leading order contribution is important in small Q^2 regions. However, the calculation of this diagram is very complicated for three-point QCDSR, thus we do not consider this contribution, which may lead to errors in the final results. In addition, the parametrization of the form factors is model dependent, it may also lead to some errors in the results. According to these above discussions, we think there are no contradiction between the results of QCDSR and that of the heavy-hadron chiral perturbation theory.

Basing on these above analysis about the electromagnetic form factors, we can now discuss the radiative decays of vector heavy-light mesons. The standard form of two body decay width can be written as,

$$\Gamma = \frac{1}{2J+1} \sum \frac{p}{8\pi M_i^2} |T|^2$$

$$p = \frac{\sqrt{[M_i^2 - (m + M_f)^2][M_i^2 - (M_f - m)^2]}}{2M_i} \quad (30)$$

where M_i and M_f represent the masses of initial and final mesons, J is the total angular momentum of the initial meson, Σ denotes the summation of all the polarization vectors, and T is the scattering amplitude.

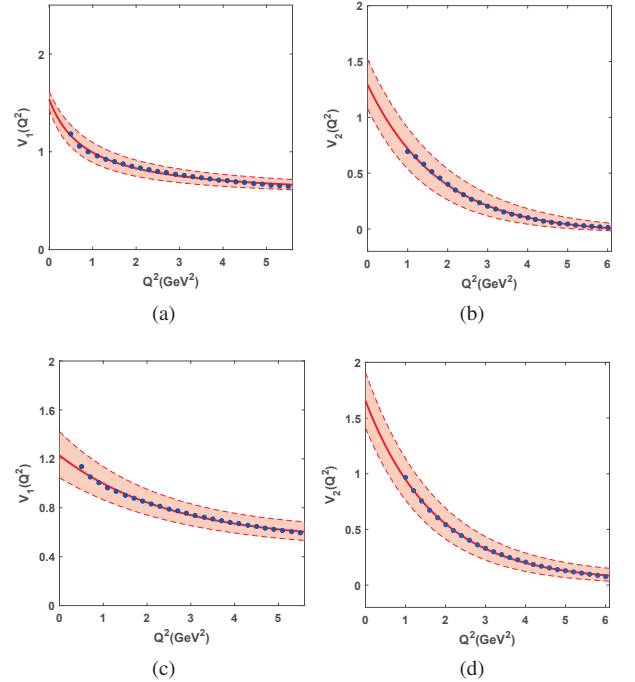

FIG. 6: The fitting results for $D^{*0(\pm)} \rightarrow D^{0(\pm)}$ (a,b) and $D_s^{*\pm} \rightarrow D_s^\pm$ (c,d). The blue circles are the form factors in space-like regions ($Q^2 > 0$), the red solid lines are the fitting curves, and the red bands represent the error regions.

With Eqs. (4) and (30), the decay width of vector heavy-light meson to pseudoscalar heavy-light meson and photon

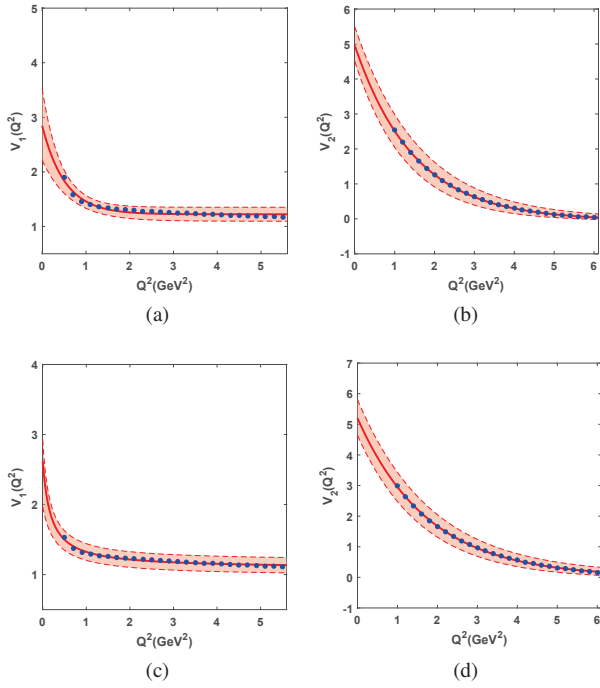

FIG. 7: The fitting results for $B^{*0(\pm)} \rightarrow B^{0(\pm)}$ (a,b) and $B_s^{*0} \rightarrow B_s^0$ (c,d). The blue circles are the form factors in space-like regions ($Q^2 > 0$), the red solid lines are the fitting curves, and the red bands represent the error regions.

can be expressed as,

$$\Gamma = \frac{\alpha |Q_Q V_1(0) + Q_q V_2(0)|^2 (m_V + m_P)(m_V - m_P)^3}{24m_V^3} \quad (31)$$

Here, $Q_{Q[q]}$ denote the electric charges of quarks, which are taken as $\frac{2}{3}$ for u and c quarks, $-\frac{1}{3}$ for d, s and b quarks. α is the electromagnetic fine structure constant whose value is $\frac{1}{137}$. Using the values about electromagnetic form factors $V_i(0)$ in Table IV, we can obtain the decay widths of radiative decay for vector heavy-light mesons. The results of present work and those of other collaboration's are all listed in Table V.

According to Particle Data Group(PDG)[71], the experimental data of the total decay width for D^{*+} is 83.4 ± 1.8 keV, and the ratio of the decay width of $D^{*+} \rightarrow D^+\gamma$ to the total width is about $(1.6 \pm 0.4)\%$. The results of present work about this radiative decay is $0.17^{+0.08}_{-0.07}$ keV, which is about 0.20% of the total width 83.4 ± 1.8 keV and is smaller than the experi-

mental data. In Ref[51], the radiative decay for D^{*+} was also analyzed by QCDSR, and their result is compatible with ours, which is also smaller than the experimental data. The total widths for D^{*0} and D_s^* are given as $\Gamma(D^{*0}) < 2.1$ MeV and $\Gamma(D_s^*) < 1.9$ MeV, and the ratios of the radiative decays are about $(35.3 \pm 0.9)\%$ and $(93.5 \pm 0.7)\%$ of the total widths. However, the exact values of these decay widths have not been determined yet. Our results for D^{*0} and D_s^* are $1.74^{+0.40}_{-0.37}$ keV and $0.029^{+0.009}_{-0.008}$ keV, which are compatible with the experimental data. In addition, the electromagnetic form factor which has the same expression as ours was firstly analyzed by Lattice QCD[87], their radiative decay width about $D_s^* \rightarrow D_s \gamma$ is given as 0.066 ± 0.026 keV. Considering the uncertainties, our result is in agreement well with theirs. We also notice that the radiative decays of the heavy-light mesons were analyzed in the framework of light-cone QCD sum rules(LCSR) by considering the subleading power corrections in recent years[88, 89]. In Ref[88], the electromagnetic coupling constants of the heavy-light mesons were obtained by considering the contributions from twist-two photon distribution amplitude at next-to-leading-order in α_s . For the convenience of comparing the results, we use their electromagnetic coupling constants to get the corresponding decay widths which are shown in Table V. As for the results of mesons $B^{*0(\pm)}$ and B_s^* , it can be seen from Table V that the theoretical results of different collaborations are not consistent well with each other, which needs to be further testified by experiments in the future.

V. CONCLUSIONS

In this article, the electromagnetic form factors in space-like regions ($Q^2 > 0$) for vector heavy-light meson to pseudoscalar heavy-light meson are firstly analyzed within the framework of three-point QCDSR. Then, the electromagnetic form factors in $Q^2 = 0$ are obtained by fitting the results into analytical functions in space-like regions. Based on these results, the radiative decays of the vector heavy-light mesons are systematically analyzed. We hope the results about electromagnetic form factors and radiative decays can help to shed more light on the nature of the hadrons.

Acknowledgements

This project is supported by National Natural Science Foundation, Grant Number 12175068 and Natural Science Foundation of HeBei Province, Grant Number A2018502124.

[1] M. Beneke, G. Buchalla, M. Neubert and C. T. Sachrajda, QCD factorization for $B \rightarrow \pi\pi$ decays: Strong phases and CP violation in the heavy quark limit,

Phys. Rev. Lett. **83**, 1914-1917 (1999).

[2] T. Muta, A. Sugamoto, M. Z. Yang and Y. D. Yang, $B \rightarrow \pi\pi$, $K\pi$ decays in QCD improved factorization approach,

TABLE V: The radiation decay width of vector heavy-light mesons, all values are in units of keV.

Method	Ref	$\Gamma(D^{*0} \rightarrow D^0\gamma)$	$\Gamma(D^{*+} \rightarrow D^+\gamma)$	$\Gamma(D_s^{*+} \rightarrow D_s^+\gamma)$	$\Gamma(B^{*0} \rightarrow B^0\gamma)$	$\Gamma(B^{*+} \rightarrow B^+\gamma)$	$\Gamma(B_s^{*+} \rightarrow B_s^+\gamma)$
QCDSR	present work	$1.74^{+0.40}_{-0.37}$	$0.17^{+0.08}_{-0.07}$	$0.029^{+0.009}_{-0.008}$	$0.018^{+0.006}_{-0.005}$	$0.015^{+0.007}_{-0.007}$	$0.016^{+0.003}_{-0.005}$
	[51]	2.43 ± 0.21	0.22 ± 0.06	0.25 ± 0.08	-	-	-
LCSR	[88]	$13.70^{+5.88}_{-4.55}$	$0.14^{+0.27}_{-0.12}$	$0.041^{+0.137}_{-0.041}$	$0.17^{+0.05}_{-0.05}$	$0.42^{+0.14}_{-0.11}$	$0.15^{+0.03}_{-0.04}$
	[89]	$27.83^{+9.23}_{-9.50}$	$0.96^{+0.38}_{-0.62}$	$2.36^{+1.49}_{-1.41}$	$0.16^{+0.06}_{-0.06}$	$0.45^{+0.17}_{-0.16}$	$0.24^{+0.08}_{-0.08}$
	[90]	14.40	1.50	-	0.16	0.63	-
Lattice QCD	[86] [*] , [87] [†]	$27 \pm 14^*$	$0.8 \pm 0.7^*$	$0.066 \pm 0.026^\dagger$	-	-	-
Salpeter-like model	[18]	20.8	0.46	0.38	0.092	0.243	0.080
χ -loop model	[21]	10.3	0.16	0.06	0.09	0.14	0.03
VMD model		18.0	0.64	0.35	0.12	0.37	0.09
Chiral quark model	[22]	13.11	0.25	-	0.05	-	-
	[24]	32.02	1.42	0.3	-	-	-
Bag model	[23]	7.18	1.72	-	0.064	0.272	0.051
Light front model	[26]	20.0 ± 0.3	0.90 ± 0.02	0.18 ± 0.01	0.13 ± 0.01	0.40 ± 0.03	0.068 ± 0.017
	[27]	21.69	0.56	-	0.142	0.429	-
GI quark model	[30]	97	9.9	-	-	-	-
Covariant confined quark model	[33] [*] , [34] [†]	$18.4 \pm 7.4^\dagger$	$1.21 \pm 0.48^\dagger$	$0.55 \pm 0.22^\dagger$	$0.126 \pm 0.019^*$	$0.372 \pm 0.056^*$	$0.090 \pm 0.014^*$

Phys. Rev. D **62**, 094020 (2000).

- [3] C. D. Lu, K. Ukai and M. Z. Yang, Branching ratio and CP violation of $B \rightarrow \pi\pi$ decays in perturbative QCD approach, *Phys. Rev. D* **63**, 074009 (2001).
- [4] Y. Y. Keum, H. N. Li and A. I. Sanda, Fat penguins and imaginary penguins in perturbative QCD, *Phys. Lett. B* **504**, 6-14 (2001).
- [5] Y. Y. Keum, H. N. Li and A. I. Sanda, Penguin enhancement and $B \rightarrow K\pi$ decays in perturbative QCD, *Phys. Rev. D* **63**, 054008 (2001).
- [6] C. D. Lu and M. Z. Yang, $B \rightarrow \pi\rho, \pi\omega$ decays in perturbative QCD approach, *Eur. Phys. J. C* **23**, 275-287 (2002).
- [7] C. W. Bauer, S. Fleming, D. Pirjol and I. W. Stewart, An Effective field theory for collinear and soft gluons: Heavy to light decays, *Phys. Rev. D* **63**, 114020 (2001).
- [8] C. W. Bauer, D. Pirjol and I. W. Stewart, Soft collinear factorization in effective field theory, *Phys. Rev. D* **65**, 054022 (2002).
- [9] A. Bazavov *et al.* [Fermilab Lattice and MILC], B^- and D^- -meson decay constants from three-flavor lattice QCD, *Phys. Rev. D* **85**, 114506 (2012).
- [10] M. Z. Yang, Semileptonic decay of B and $D \rightarrow K_0^*(1430)\bar{l}\nu$ from QCD sum rule, *Phys. Rev. D* **73**, 034027 (2006) [erratum: *Phys. Rev. D* **73**, 079901 (2006)]
- [11] T. M. Aliev, K. Azizi and M. Savci, Analysis of rare $B \rightarrow K_{(0)}^*(1430)l^+l^-$ decay within QCD sum rules, *Phys. Rev. D* **76**, 074017 (2007).
- [12] Y. M. Wang, H. Zou, Z. T. Wei, X. Q. Li and C. D. Lu, The Transition form-factors for semi-leptonic weak decays of J/ψ in QCD sum rules, *Eur. Phys. J. C* **54**, 107-121 (2008).
- [13] N. Ghahramany and R. Khosravi, Analysis of the rare semileptonic decays of B_s to $f_0(980)$ and $K_0^*(1430)$ scalar mesons in QCD sum rules, *Phys. Rev. D* **80**, 016009 (2009).
- [14] Y. M. Wang, M. J. Aslam and C. D. Lu, Scalar mesons in weak semileptonic decays of $B_{(s)}$, *Phys. Rev. D* **78**, 014006 (2008).
- [15] P. Colangelo, F. De Fazio and W. Wang, $B_s \rightarrow f_0(980)$ form factors and B_s decays into $f_0(980)$, *Phys. Rev. D* **81**, 074001 (2010).
- [16] Y. J. Sun, Z. H. Li and T. Huang, $B_{(s)} \rightarrow S$ transitions in the light cone sum rules with the chiral current, *Phys. Rev. D* **83**, 025024 (2011).
- [17] H. Y. Han, X. G. Wu, H. B. Fu, Q. L. Zhang and T. Zhong, Twist-3 Distribution Amplitudes of Scalar Mesons within the QCD Sum Rules and Its Application to the $B \rightarrow S$ Transition Form Factors, *Eur. Phys. J. A* **49**, 78 (2013).
- [18] P. Colangelo, F. De Fazio and G. Nardulli, D^* radiative decays and strong coupling of heavy mesons with soft pions in a QCD relativistic potential model, *Phys. Lett. B* **334**, 175-179 (1994).
- [19] P. L. Cho and H. Georgi, Electromagnetic interactions in heavy hadron chiral theory, *Phys. Lett. B* **296**, 408-414 (1992) [erratum: *Phys. Lett. B* **300**, 410 (1993)].
- [20] P. Ball and V. M. Braun, Use and misuse of QCD sum rules in heavy to light transitions: The Decay $B \rightarrow \rho e\nu$ reexamined, *Phys. Rev. D* **55**, 5561-5576 (1997).
- [21] R. Casalbuoni, A. Deandrea, N. Di Bartolomeo, R. Gatto, F. Feruglio and G. Nardulli, Phenomenology of heavy meson chiral Lagrangians, *Phys. Rept.* **281**, 145-238 (1997).
- [22] A. Deandrea, N. Di Bartolomeo, R. Gatto, G. Nardulli and A. D. Polosa, A Constituent quark meson model for heavy meson processes, *Phys. Rev. D* **58**, 034004 (1998).
- [23] A. H. Orsland and H. Hogaasen, Strong and electromagnetic decays for excited heavy mesons, *Eur. Phys. J. C* **9**, 503-510 (1999).
- [24] J. L. Goity and W. Roberts, Radiative transitions in heavy mesons in a relativistic quark model, *Phys. Rev. D* **64**, 094007 (2001).
- [25] C. H. Chen, C. Q. Geng, C. C. Lih and C. C. Liu, Study of $B \rightarrow K_{(0)}^*(1430)l\bar{l}$ decays, *Phys. Rev. D* **75**, 074010 (2007).
- [26] H. M. Choi, Decay constants and radiative decays of heavy mesons in light-front quark model, *Phys. Rev. D* **75**, 073016 (2007).
- [27] W. Jaus, Semileptonic, radiative, and pionic decays of B, B^* and D, D^* mesons, *Phys. Rev. D* **53**, 1349 (1996) [erratum: *Phys. Rev. D* **54**, 5904 (1996)].
- [28] R. H. Li, C. D. Lu, W. Wang and X. X. Wang, $B \rightarrow S$ Transition Form Factors in the PQCD approach, *Phys. Rev. D* **79**, 014013 (2009).
- [29] B. Wang, B. Yang, L. Meng and S. L. Zhu, Radiative transitions and magnetic moments of the charmed and bottom vector mesons in chiral perturbation theory, *Phys. Rev. D* **100**, no.1, 016019 (2019).
- [30] J. L. Li and D. Y. Chen, Radiative decays of charmed

- mesons in a modified relativistic quark model, *Chin. Phys. C* **46**, no.7, 073106 (2022).
- [31] C. D. Lü, Y. L. Shen, C. Wang and Y. M. Wang, Shedding new light on weak annihilation B-meson decays, *Nucl. Phys. B* **990**, 116175 (2023).
- [32] B. Y. Cui, Y. K. Huang, Y. M. Wang and X. C. Zhao, Shedding new light on $R(D_{(s)}^{(*)})$ and $|V_{cb}|$ from semileptonic $\bar{B}_{(s)} \rightarrow D_{(s)}^{(*)} l \nu_l$ decays, *Phys. Rev. D* **108**, no.7, L071504 (2023).
- [33] M. A. Ivanov, Z. Tyulemissov and A. Tyulemissova, Weak nonleptonic decays of vector B-mesons, *Phys. Rev. D* **107**, no.1, 013009 (2023).
- [34] C. T. Tran, M. A. Ivanov, P. Santorelli and Q. C. Vo, Radiative decays in covariant confined quark model, *Chin. Phys. C* **48**, no.2, 023103 (2024).
- [35] W. Lucha, D. Melikhov and S. Simula, OPE, charm-quark mass, and decay constants of D and D_s mesons from QCD sum rules, *Phys. Lett. B* **701**, 82-88 (2011).
- [36] S. Narison, A fresh look into $m_{c,b}$ and precise $f_{D_{(s)},B_{(s)}}$ from heavy-light QCD spectral sum rules, *Phys. Lett. B* **718**, 1321-1333 (2013).
- [37] P. Gelhausen, A. Khodjamirian, A. A. Pivovarov and D. Rosenthal, Decay constants of heavy-light vector mesons from QCD sum rules, *Phys. Rev. D* **88**, 014015 (2013) [erratum: *Phys. Rev. D* **89**, 099901 (2014); erratum: *Phys. Rev. D* **91**, 099901 (2015)].
- [38] S. L. Zhu, W. Y. P. Hwang and Z. S. Yang, $D^* \rightarrow D\gamma$ and $B^* \rightarrow B\gamma$ as derived from QCD sum rules, *Mod. Phys. Lett. A* **12**, 3027-3036 (1997).
- [39] S. L. Zhu, Strong and electromagnetic decays of P wave heavy baryons $\Lambda_{c1}, \Lambda_{c1}^*$, *Phys. Rev. D* **61**, 114019 (2000).
- [40] Z. G. Wang, Analysis of the $1/2^-$ and $3/2^-$ heavy and doubly heavy baryon states with QCD sum rules, *Eur. Phys. J. A* **47**, 81 (2011).
- [41] H. X. Chen, Q. Mao, A. Hosaka, X. Liu and S. L. Zhu, D-wave charmed and bottomed baryons from QCD sum rules, *Phys. Rev. D* **94**, no.11, 114016 (2016).
- [42] K. Azizi, Y. Sarac and H. Sundu, $\Lambda_b(6146)^0$ state newly observed by LHCb, *Phys. Rev. D* **101**, no.7, 074026 (2020).
- [43] F. O. Duraes and M. Nielsen, QCD sum rules study of Ξ_c and Ξ_b baryons, *Phys. Lett. B* **658**, 40-44 (2007).
- [44] X. Liu, H. X. Chen, Y. R. Liu, A. Hosaka and S. L. Zhu, Bottom baryons, *Phys. Rev. D* **77**, 014031 (2008).
- [45] J. R. Zhang and M. Q. Huang, Heavy baryon spectroscopy in QCD, *Phys. Rev. D* **78**, 094015 (2008).
- [46] Q. Xin and Z. G. Wang, Analysis of the doubly-charmed tetraquark molecular states with the QCD sum rules, *Eur. Phys. J. A* **58**, no.6, 110 (2022).
- [47] Z. Y. Li, Z. G. Wang and G. L. Yu, Strong decays of heavy tensor mesons in QCD sum rules, *Mod. Phys. Lett. A* **31**, no.06, 1650036 (2016).
- [48] G. L. Yu, Z. G. Wang and Z. Y. Li, Strong coupling constants and radiative decays of the heavy tensor mesons, *Eur. Phys. J. C* **79**, no.9, 798 (2019).
- [49] Z. G. Wang, Decipher the width of the $X(3872)$ via the QCD sum rules, [arXiv:2310.02030 [hep-ph]].
- [50] Z. G. Wang and X. S. Yang, The two-body strong decays of the fully-charm tetraquark states, [arXiv:2310.16583 [hep-ph]].
- [51] T. M. Aliev, E. Iltan and N. K. Pak, Radiative D^* meson decays in QCD sum rules, *Phys. Lett. B* **334**, 169-174 (1994).
- [52] R. Khosravi and F. Falahati, Semileptonic decays of B_s to ϕ meson in QCD, *Phys. Rev. D* **88**, no.5, 056002 (2013).
- [53] Y. Q. Peng and M. Z. Yang, Form factors and decay of $\bar{B}_s^0 \rightarrow J/\psi\phi$ from QCD sum rule, *Mod. Phys. Lett. A* **35**, no.22, 2050187 (2020).
- [54] Y. J. Shi, W. Wang and Z. X. Zhao, QCD Sum Rules Analysis of Weak Decays of Doubly-Heavy Baryons, *Eur. Phys. J. C* **80**, no.6, 568 (2020).
- [55] Z. X. Zhao, R. H. Li, Y. L. Shen, Y. J. Shi and Y. S. Yang, The semi-leptonic form factors of $\Lambda_b \rightarrow \Lambda_c$ and $\Xi_b \rightarrow \Xi_c$ in QCD sum rules, *Eur. Phys. J. C* **80**, no.12, 1181 (2020).
- [56] Z. P. Xing and Z. X. Zhao, QCD sum rules analysis of weak decays of doubly heavy baryons: the $b \rightarrow c$ processes, *Eur. Phys. J. C* **81**, no.12, 1111 (2021).
- [57] S. Q. Zhang and C. F. Qiao, Λ_c semileptonic decays, *Phys. Rev. D* **108**, no.7, 074017 (2023).
- [58] K. Azizi and H. Sundu, $g_{D_s^* DK^{*(892)}}$ and $g_{B_s^* BK^{*(892)}}$ coupling constants in QCD sum rules, *J. Phys. G* **38**, 045005 (2011).
- [59] H. Sundu, J. Y. Sungu, S. Sahin, N. Yinelek and K. Azizi, Strong coupling constants of bottom and charmed mesons with scalar, pseudoscalar and axial vector kaons, *Phys. Rev. D* **83**, 114009 (2011).
- [60] C. Y. Cui, Y. L. Liu and M. Q. Huang, $B^* B^* \rho$ vertex from QCD sum rules, *Phys. Lett. B* **711**, 317-326 (2012).
- [61] M. E. Bracco, M. Chiapparini, F. S. Navarra and M. Nielsen, Charm couplings and form factors in QCD sum rules, *Prog. Part. Nucl. Phys.* **67**, 1019-1052 (2012).
- [62] B. O. Rodrigues, M. E. Bracco and C. M. Zanetti, A QCD sum rules calculation of the $\eta_c D^* D$ and $\eta_c D_s^* D_s$ form factors and strong coupling constants, *Nucl. Phys. A* **966**, 208-223 (2017).
- [63] J. Lu, G. L. Yu and Z. G. Wang, The strong vertices of charmed mesons D, D^* and charmonia $J/\psi, \eta_c$, *Eur. Phys. J. A* **59**, no.8, 195 (2023).
- [64] J. Lu, G. L. Yu, Z. G. Wang and B. Wu, The strong vertices of bottom mesons B, B^* and bottomonia Υ, η_b , [arXiv:2307.05090 [hep-ph]].
- [65] K. Azizi, Y. Sarac and H. Sundu, Strong $\Lambda_b NB$ and $\Lambda_c ND$ vertices, *Phys. Rev. D* **90**, no.11, 114011 (2014).
- [66] K. Azizi, Y. Sarac and H. Sundu, Strong $\Sigma_b NB$ and $\Sigma_c ND$ coupling constants in QCD, *Nucl. Phys. A* **943**, 159-167 (2015).
- [67] G. L. Yu, R. H. Guan and Z. G. Wang, Analysis of the strong vertices of $\Sigma_c ND^*$ and $\Sigma_b NB^*$ in QCD sum rules, *Int. J. Mod. Phys. A* **33**, no.36, 1850217 (2019).
- [68] J. Lu, G. L. Yu, Z. G. Wang and B. Wu, Analysis of the strong vertices of $\Sigma_c \Delta D^*$ and $\Sigma_b \Delta B^*$ in QCD sum rules, *Eur. Phys. J. C* **83**, no.10, 907 (2023).
- [69] Z. G. Wang, The radiative decays $B_c^{*\pm} \rightarrow B_c^{\pm} \gamma$ with QCD sum rules, *Eur. Phys. J. C* **73**, no.9, 2559 (2013).
- [70] G. L. Yu, Z. Y. Li and Z. G. Wang, Analysis of the strong coupling constant $G_{D_s^* D_s \phi}$ and the decay width of $D_s^* \rightarrow D_s \gamma$ with QCD sum rules, *Eur. Phys. J. C* **75**, no.6, 243 (2015).
- [71] R. L. Workman *et al.* [Particle Data Group], Review of Particle Physics, *PTEP* **2022**, 083C01 (2022).
- [72] P. Colangelo and A. Khodjamirian, QCD sum rules, a modern perspective, [arXiv:hep-ph/0010175 [hep-ph]].
- [73] P. Pascual and R. Tarrach, QCD: RENORMALIZATION FOR THE PRACTITIONER, *Lect. Notes Phys.* **194**, 1-277 (1984).
- [74] L. J. Reinders, H. Rubinstein and S. Yazaki, Hadron Properties from QCD Sum Rules, *Phys. Rept.* **127**, 1 (1985).
- [75] B. L. Ioffe and A. V. Smilga, Pion Form-Factor at Intermediate Momentum Transfer in QCD, *Phys. Lett. B* **114**, 353-358 (1982).
- [76] B. L. Ioffe and A. V. Smilga, Meson Widths and Form-Factors at Intermediate Momentum Transfer in Nonperturbative QCD, *Nucl. Phys. B* **216**, 373-407 (1983).
- [77] Z. G. Wang, Analysis of the masses and decay constants of the heavy-light mesons with QCD sum rules, *Eur. Phys. J. C* **75**, 427 (2015).
- [78] M. A. Shifman, A. I. Vainshtein and V. I. Za-

- kharov, QCD and Resonance Physics: Applications, *Nucl. Phys. B* **147**, 448-518 (1979).
- [79] S. Narison, Gluon condensates and c , b quark masses from quarkonia ratios of moments, *Phys. Lett. B* **693**, 559-566 (2010) [erratum: *Phys. Lett. B* **705**, 544-544 (2011)].
- [80] S. Narison, Gluon Condensates and precise $\bar{m}_{c,b}$ from QCD-Moments and their ratios to Order α_s^3 and $\langle G^4 \rangle$, *Phys. Lett. B* **706**, 412-422 (2012).
- [81] S. Narison, Gluon Condensates and $\bar{m}_b(\bar{m}_b)$ from QCD-Exponential Moments at Higher Orders, *Phys. Lett. B* **707**, 259-263 (2012).
- [82] C. G. Boyd, B. Grinstein and R. F. Lebed, Constraints on form-factors for exclusive semileptonic heavy to light meson decays, *Phys. Rev. Lett.* **74**, 4603-4606 (1995).
- [83] Y. M. Wang and Y. L. Shen, QCD corrections to $B \rightarrow \pi$ form factors from light-cone sum rules, *Nucl. Phys. B* **898**, 563-604 (2015).
- [84] B. Y. Cui, Y. K. Huang, Y. L. Shen, C. Wang and Y. M. Wang, Precision calculations of $B_{d,s} \rightarrow \pi, K$ decay form factors in soft-

- collinear effective theory, *JHEP* **03**, 140 (2023).
- [85] H. Y. Cheng, C. Y. Cheung, G. L. Lin, Y. C. Lin, T. M. Yan and H. L. Yu, Chiral Lagrangians for radiative decays of heavy hadrons, *Phys. Rev. D* **47**, 1030-1042 (1993).
- [86] D. Becirevic and B. Haas, $D^* \rightarrow D\pi$ and $D^* \rightarrow D\gamma$ decays: Axial coupling and Magnetic moment of D^* meson, *Eur. Phys. J. C* **71**, 1734 (2011).
- [87] G. C. Donald, C. T. H. Davies, J. Koponen and G. P. Lepage, Prediction of the D_s^* width from a calculation of its radiative decay in full lattice QCD, *Phys. Rev. Lett.* **112**, 212002 (2014).
- [88] H. D. Li, C. D. Lü, C. Wang, Y. M. Wang and Y. B. Wei, QCD calculations of radiative heavy meson decays with subleading power corrections, *JHEP* **04**, 023 (2020).
- [89] B. Pullin and R. Zwicky, Radiative decays of heavy-light mesons and the $f_{H,H^*,H_1}^{(T)}$ decay constants, *JHEP* **09**, 023 (2021).
- [90] T. M. Aliev, D. A. Demir, E. Iltan and N. K. Pak, Radiative $B^* \rightarrow B\gamma$ and $D^* \rightarrow D\gamma$ decays in light cone QCD sum rules, *Phys. Rev. D* **54**, 857-862 (1996).

Appendix: The pole and continuum contributions, and the contributions of different vacuum condensate terms.

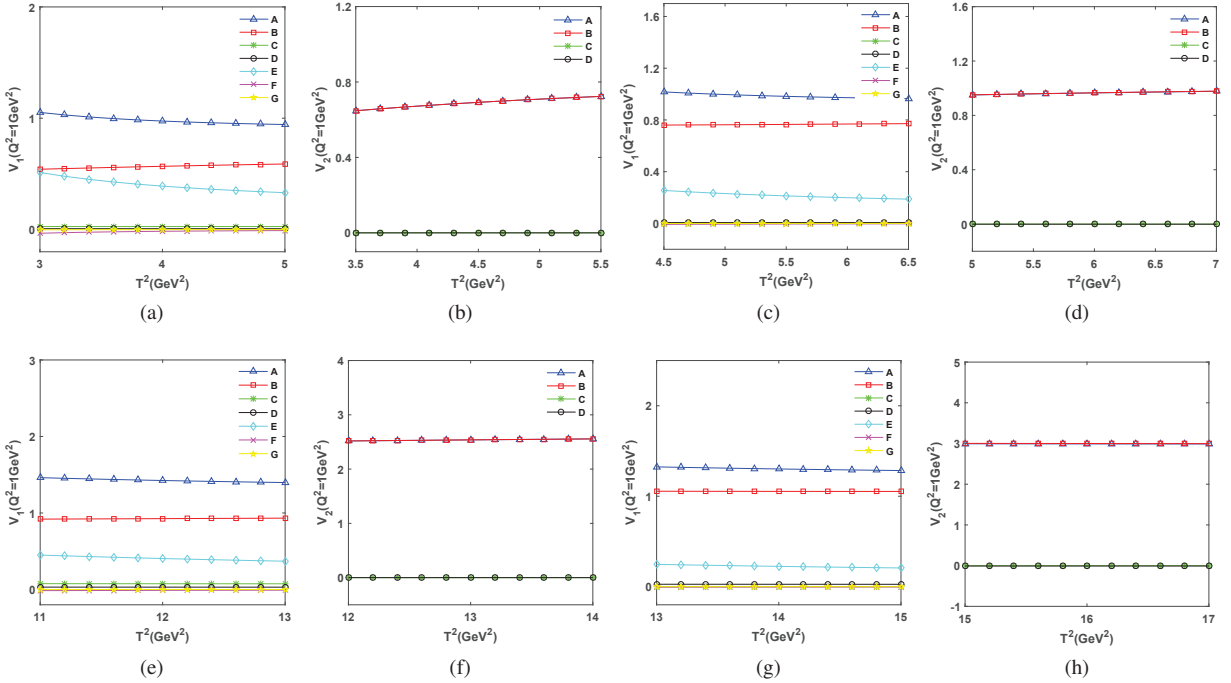

FIG. 8: The contributions of different vacuum condensate terms with variation of the Borel parameter T^2 for $D^{*0(\pm)} \rightarrow D^{0(\pm)}$ (a,b), $D_s^{*0(\pm)} \rightarrow D_s^{0(\pm)}$ (c,d), $B^{*0(\pm)} \rightarrow B^{0(\pm)}$ (e,f), and $B_s^{*0} \rightarrow B_s^0$ electromagnetic form-factors, where A-G represent the total, perturbative term, $\langle g_s^2 G^2 \rangle$, $\langle f^3 G^3 \rangle$, $\langle \bar{q}q \rangle$, $\langle \bar{q}g_s \sigma G q \rangle$, and $\langle \bar{q}q \rangle \langle g_s^2 G^2 \rangle$ contributions, here the q denotes the light quarks $u(d)$ or s .

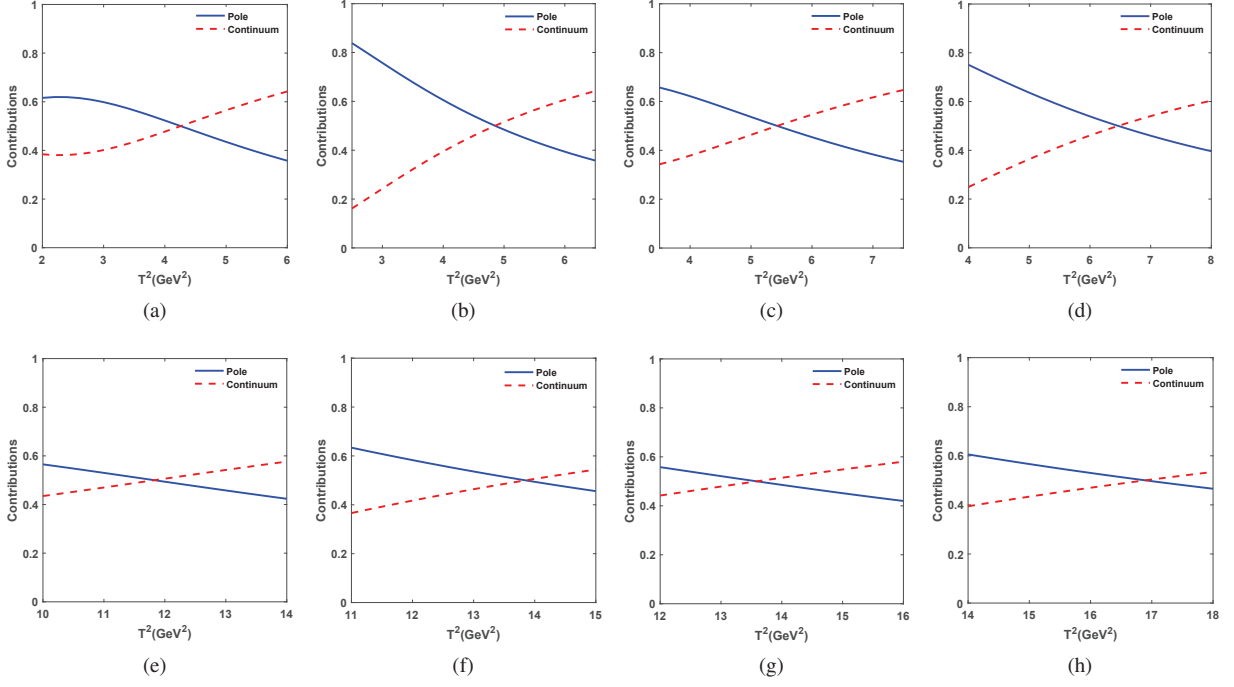

FIG. 9: The pole and continuum contributions with variation of the Borel parameter T^2 for $D^{*0(\pm)} \rightarrow D^{0(\pm)}$ (a, b), $D_s^{*\pm} \rightarrow D_s^\pm$ (c, d), $B^{*0(\pm)} \rightarrow B^{0(\pm)}$ (e, f), and $B_s^{*0} \rightarrow B_s^0$ electromagnetic form-factors.