

ALGEBRAIC STRING TOPOLOGY FROM THE NEIGHBORHOOD OF INFINITY

MANUEL RIVERA, ALEX TAKEDA AND ZHENGFANG WANG

ABSTRACT. We construct and study an algebraic analogue of the loop coproduct in string topology, also known as the Goresky-Hingston coproduct. Our algebraic setup, which under this analogy takes the place of the complex of chains on the free loop space of a possibly non-simply connected manifold, is the Hochschild chain complex of a smooth A_∞ -category equipped with a pre-Calabi-Yau structure and a trivialization of a version of the Chern character of its diagonal bimodule. The algebraic analogue of the loop coproduct is part of a more general mapping cone construction, which we describe in terms of the categorical formal punctured neighborhood of infinity associated to the underlying smooth A_∞ -category. We use a graphical formalism for A_∞ -categories and bimodules to describe explicit models for the operations and homotopies involved. We also compute explicitly the algebraic coproduct in the context of the string topology of spheres.

Mathematics Subject Classification (2020). 16E40, 55P50; 18G10, 16S38.

Keywords. Hochschild (co)homology, string topology, Calabi-Yau structure

CONTENTS

1. Introduction	2
1.1. Motivation	2
1.2. Summary of results	3
1.3. Outline of the proof	6
1.4. Relation to existing work	8
2. Pre-CY categories and their graphical calculus	9
2.1. The graphical calculus	9
2.2. Pre-CY structures	13
3. Chain-level Chern character and coproduct	15
3.1. Chern character	15
3.2. Coproduct	17
3.3. Covariance of the space of trivializations with respect to choices	19
3.4. Infinitesimal bialgebra relation	19
4. Categorical formal punctured neighborhood of infinity	21
4.1. Definition	21
4.2. Relation to Chern character of diagonal bimodule	22
5. Pre-CY structures and product on their cone	25
5.1. The cone bimodule of a pre-CY category	25
5.2. Extending products on chains and cochains	27
5.3. Lift of the product	29
6. Relations between products on the dual and coproducts	32
6.1. Symmetry of Chern character	32
6.2. Compatibility relation	34
7. Examples	37
7.1. Spheres of odd dimension greater or equal to 3	37
7.2. Spheres of even dimension greater or equal to 4	42
7.3. The 2-sphere	47
7.4. The circle	48
Appendix A. Explicit diagrams	52
References	63

1. INTRODUCTION

String topology is the study of algebraic structures defined in terms of intersecting, cutting, and reconnecting families (or more precisely, *chains*) of strings or loops on a manifold [CS99]. One of the principal themes in string topology since its inception has been the characterization of the algebraic topology of manifolds through chain-level manifestations of Poincaré duality. In this article, we construct and study algebraic operations on the Hochschild chains of a smooth A_∞ -category equipped with some additional structure, inspired by the constructions in string topology with emphasis on an algebraic analogue of the *Goresky-Hingston (loop) coproduct*. We propose a construction that combines algebraic analogues for the Goresky-Hingston loop coproduct and Chas-Sullivan loop product. Our construction is inspired by the *categorical formal punctured neighborhood of infinity*, a non-commutative analogue of the category of perfect complexes on the formal punctured neighborhood of the divisor at infinity for a compactification of a smooth variety [Efi17].

The Goresky-Hingston loop coproduct was originally defined geometrically as an operation on the homology of the free loop space of a manifold relative to constant loops [GH09], [HW22]. It is a type of secondary invariant and its construction requires choices that are more subtle than those involved in other string topology operations such as the Chas-Sullivan loop product. In fact, the Goresky-Hingston loop coproduct, in contrast to the Chas-Sullivan loop product, is sensitive to structure beyond the homotopy type of the underlying manifold [Nae21] [NRW23], [NW19]. The algebraic formalism proposed in the present article makes explicit the choices required to construct such a coproduct and provides a transparent framework to analyze its properties and compatibilities with other operations.

1.1. Motivation. Let M be a closed oriented (smooth or combinatorial) manifold of dimension n . One of the first operations considered in string topology was the *loop product*

$$\wedge: H_*(LM) \otimes H_*(LM) \rightarrow H_*(LM)$$

(Chas-Sullivan product in the literature) [CS99], where $LM = \text{Map}(S^1, M)$ is the free loop space of M . This is a degree $-n$ product combining the intersection product on the chains on M with the concatenation product of loops with the same base point. The circle action on LM given by rotation of loops gives rise to an operator $B: H_*(LM) \rightarrow H_{*+1}(LM)$. One of the first theorems in string topology is that $(H_*(LM)[-n], \wedge, B)$ satisfies the axioms of a *BV-algebra* structure. This algebraic structure (as well as chain level lifts taking the form of a framed E_2 -algebra) has been constructed rigorously through different perspectives [CJ02], [Iri18], [Tra02], [TZ06], [TZ07a], [WW16], [KTV22], [BR23], [HW22]. The loop product has shown to be an invariant of the oriented homotopy type of the underlying manifold [CKS08].

Another major string topology operation is the *loop coproduct*

$$\vee: H_*(LM, M) \rightarrow H_*(LM, M) \otimes H_*(LM, M)$$

(Goresky-Hingston coproduct in the literature)[GH09], [HW22]. This is a degree $1-n$ coproduct defined by considering a 1-parameter family of self intersections in a single chain of loops and then splitting at the points of intersection to obtain a formal sum of pairs of chains of loops. In order to obtain a well-defined operation on homology, one must work relative to constant loops or relative to a choice of base point. Constructing the loop coproduct rigorously, understanding all the necessary choices, and analyzing its properties and compatibilities with other operations has proven to be a delicate endeavor.

The first and third named authors of this paper constructed in [RW19] a framework combining algebraic models for the loop product and loop coproduct into a single algebra structure on the mapping cone of a map connecting the Hochschild chain and cochain complexes of a connected differential graded (dg) Frobenius algebra. The construction was coined the *Tate-Hochschild complex* since it resembles Tate cohomology of finite groups. One can derive an explicit formula for the algebraic analogue of the loop coproduct in this context, which agrees with a formula given previously by [Abb16]. The Tate-Hochschild construction has a counterpart in symplectic

topology known as *Rabinowitz-Floer homology*, a theory combining symplectic homology and cohomology of symplectic manifolds [CHO23], [CHO20], [GGV22]

The setting of Frobenius algebras (or proper Calabi Yau algebras) is suitable for studying string topology in the *simply connected* setting: the Tate-Hochschild cohomology perspective was used to deduce that, working over rational coefficients, two homotopy-equivalent simply connected closed manifolds have isomorphic Goresky-Hingston loop coalgebras [RW22]. In the *non-simply connected* setting, F. Naef observed that the loop coproduct can distinguish homotopy-equivalent but non-homeomorphic lens spaces [Nae21]. This was strengthened in [NRW23] by proving two lens spaces $L_{p,q}$ and $L_{p,q'}$ are homeomorphic if and only if their Goresky-Hingston coalgebras are isomorphic. These results realized one of the original goals of string topology of constructing operations that can detect more geometric information than just the oriented homotopy type of the underlying manifold.

The motivation for the present article is to devise an algebraic framework for string topology that 1. allows to keep track of the choices necessary to construct chain level operations for non-simply connected manifolds, 2. makes transparent the dependency of the string operations on the underlying manifold, and 3. is suitable for describing explicit formulas, compatibilities between operations, and carrying out computations. With this motivation in mind, we describe a construction that we believe to be a Koszul dual version of the Tate-Hochschild complex; like the latter, this construction combines algebraic models for the loop product and loop coproduct, but is now applicable to the setting of non-simply connected manifolds.

We model the complex of chains on the free loop space of a closed manifold as the Hochschild chain complex of a smooth dg (or A_∞) category A playing the role of the dg category of paths on the underlying manifold. To recover the relevant string operations, the category A is equipped with the additional data of a *pre-Calabi Yau* structure manifesting chain level Poincaré duality together with certain “trivialization” of (a version of) the Chern character of A . This approach is grounded on combining the perspectives and results of [Goo85], [Riv23], [KTV22], [RW19], and [Efi17]. In a subsequent article, we will describe how our algebraic formalism may be used to construct string topology operations of non-simply connected manifolds directly from a triangulation.

1.2. Summary of results. We briefly summarize our main constructions and results while describing how the paper is organized. We outline the construction of the *algebraic loop coproduct*, which is described in detail in Section 3 building upon the graphical formalism recalled in Section 2. Suppose A is a connective (i.e. non-negatively graded) smooth dg category over a ring \mathbb{k} . We also suppose that all its morphism spaces are cofibrant over \mathbb{k} ; this condition, which holds automatically when \mathbb{k} is a field, is called \mathbb{k} -cofibrancy* in [LV05] (see also [Kel03]), and implies that the Hochschild complexes we write compute the appropriate derived tensors and homs. We will assume all our dg categories are \mathbb{k} -cofibrant throughout the whole article.

Denote $A^e = A \otimes A^{op}$ and let $A^!$ be any A -bimodule modeling the inverse dualizing bimodule complex $\mathbb{R}\mathrm{Hom}_{A^e}(A, A^e)$. For any A -bimodule N , denote by $C_*(A, N)$ and $C^*(A, N)$ the Hochschild chain and cochain complexes of A with values on N , respectively, and by $D^*(A \otimes A^!, A^e)$ the chain complex calculating $\mathbb{R}\mathrm{Hom}_{A^e \otimes A^e}(A \otimes A^!, A^e)$ obtained through appropriate bar resolutions. Smoothness implies the existence of natural quasi-isomorphisms

$$C_*(A, A^!) \xrightarrow{\cong} C^*(A, A) \xleftarrow{\cong} D^*(A \otimes A^!, A^e).$$

Recall that $C_*(A, A^!)$ models the derived tensor product $A \otimes_{A^e}^{\mathbb{L}} A^!$ and $C^*(A, A)$ models the derived mapping space $\mathbb{R}\mathrm{Hom}_{A^e}(A, A)$. Choose cycles $\mathrm{co} \in C_*(A, A^!)$ and $\eta \in D^*(A \otimes A^!, A^e)$ representing the cohomology class of the identity (bimodule) morphism

$$[\mathrm{id}_A] \in H^0(\mathbb{R}\mathrm{Hom}_{A^e}(A, A)) \cong H^0(C^*(A, A))$$

under the above quasi-isomorphisms.

We have an evaluation map

$$e: D^*(A \otimes A^!, A^e) \otimes C_*(A, A^!) \rightarrow C_*(A, A) \otimes C_*(A, A),$$

*Not to be confused with cofibrancy in any particular model structure for the category of dg categories.

with which we make the following definition.

Definition 1.1. (Definition 3.3) The *chain-level Chern character* (of the diagonal bimodule of) A is the element

$$E = e(\eta, \text{co}) \in C_*(A, A) \otimes C_*(A, A).$$

This definition is a special case of a more general definition that makes sense for any perfect A -bimodule. Though E depends on the representatives we chose for co and η , its homology class $[E] \in HH_*(A, A) \otimes HH_*(A, A)$ is well defined and may be thought of as a version of *Chern character*, or of the *Hattori-Stallings trace* [Hat65], for smooth dg categories.

Using co and η one can also define a map of graded vector spaces, see Section 3.2

$$G: C^*(A, A) \rightarrow C_*(A, A) \otimes C_*(A, A)[-1].$$

This is not in general a map of complexes; instead it is a homotopy between capping either factor of E by φ . That is, G satisfies

$$[d, G]\varphi = (\varphi \smile E') \otimes E'' - (-1)^{\deg(\varphi) \deg(E')} E' \otimes (\varphi \smile E'')$$

where $\smile: C^*(A, A) \otimes C_*(A, A) \rightarrow C_*(A, A)$ the classical cap product between Hochschild cochains and chains.

One can correct G to a map of complexes, by choosing some extra data, as follows.

Definition 1.2. (Definition 3.8) Suppose W is some subcomplex of $C_*(A, A)$. A *trivialization of E onto W* is a pair (E_0, H) , where $E_0 \in W \otimes C_*(A, A) + C_*(A, A) \otimes W$ and $H \in C_*(A, A) \otimes C_*(A, A)$, such that $dH = E - E_0$ in $C_*(A, A) \otimes C_*(A, A)$.

Since A is connective, if (E_0, H) is a trivialization onto W , we will assume that E_0 lives in $W_0 \otimes C_0(A, A) + C_0(A, A) \otimes W_0$ and H has pure degree 1; this restriction will not lead to any loss of generality for our statements.

Given a trivialization of E onto W as above, let us denote $\overline{C}_*(A, A) = C_*(A, A)/W$ and define

$$\tilde{\Delta}_H: C^*(A, A) \rightarrow \overline{C}_*(A, A) \otimes \overline{C}_*(A, A)[-1]$$

by the formula

$$\tilde{\Delta}_H(\varphi) = G(\varphi) - (-1)^{\deg(\varphi)}((\varphi \smile H') \otimes H'' - (-1)^{\deg(\varphi) \deg(H')} (H' \otimes (\varphi \smile H''))).$$

This is a map of complexes, and induces a map on homology

$$\tilde{\Delta}_H: HH^*(A, A) \rightarrow H_*(\overline{C}_*(A, A) \otimes \overline{C}_*(A, A))[-1].$$

We note that this map is defined independent on having any sort of duality structure on A .

We now include such a duality structure, in the form of a *pre-Calabi-Yau* (pre-CY) structure of dimension n . The formalism of pre-CY structures was developed in [KTV22] and will be recalled in Section 2.2. The data of a pre-CY structure of dimension n , in particular, gives rise to a map of A -bimodules $\alpha: A \rightarrow A^1[n]$ and a map of complexes

$$g_\alpha: C_*(A, A) \rightarrow C^*(A, A)[n]$$

Definition 1.3. (Proposition 3.9) The *chain-level loop coproduct* associated to $(A, \text{co}, \eta, H, \alpha)$ is the map of complexes

$$\Delta_H: C_*(A, A) \rightarrow \overline{C}_*(A, A) \otimes \overline{C}_*(A, A)[n-1]$$

given by the composition $\Delta_H = \tilde{\Delta}_H \circ g_\alpha$. We denote equally by Δ_H the operation induced on homology

$$\Delta_H: HH_*(A, A) \rightarrow H_*(\overline{C}_*(A, A) \otimes \overline{C}_*(A, A))[n-1]$$

which we call the *homology loop coproduct*.

In the special case $[E] = 0$, one can choose $W = 0$ to get a coproduct on the whole of $HH_*(A, A)$. The pre-CY structure on A also defines a product π on this space, part of a framed E_2 -structure, which is an algebraic model of the Chas-Sullivan loop coproduct. We show in Theorem 3.14 that, for any choice of H , the homology coproduct Δ_H and homology loop product π satisfy the *infinitesimal bialgebra* relation, that is, Δ_H satisfies a version of the Leibniz rule with respect to π .

Without further assumptions, Δ_H may not have other nice properties one encounters in coproducts coming from string topology or Floer theory, namely, coassociativity and cocommutativity. A great portion of this paper is dedicated to studying what conditions one needs in order to guarantee that the homology loop coproduct has these properties.

We start by imposing a non-degeneracy condition on the pre-CY structure: such a structure is non-degenerate if α is a quasi-isomorphism of A -bimodules. The literature on pre-CY structures has been developed over a field of characteristic zero; in that case, for example, non-degenerate pre-CY structures can be produced on any A endowed with a smooth Calabi-Yau structure, using the procedure of [KTV23] (see also [Yeu18; Pri17]). Nonetheless, the definition of pre-CY structures, and the nondegeneracy condition, still make sense over any ring \mathbb{k} .

We would also like to pick the subcomplex W appropriately; we have some freedom of choice, depend on what space we want to define the homology coproduct on. Some of those choices will lead to well-behaved coproducts. Let us denote $\overline{HH}_*(A, A) = H_*(\overline{C}_*(A, A))$, with the canonical projection $HH_*(A, A) \rightarrow \overline{HH}_*(A, A)$. By pairing on the left-hand side, the class $[E]$ gives a map

$$\sharp[E] : HH^*(A, A^\vee) \rightarrow HH_0(A, A).$$

We now consider the induced pairing $\ker(\sharp[E]) \otimes HH_*(A, A) \rightarrow \mathbb{k}$.

Definition 1.4. (Definition 6.5) The subcomplex W is *balanced* if it satisfies the following two properties:

- (1) The pairing above factors through a map

$$\ker(\sharp[E]) \otimes \overline{HH}_*(A, A) \rightarrow \mathbb{k}$$

such that the induced map $\ker(\sharp[E]) \rightarrow (\overline{HH}_*(A, A))^\vee$ is a surjection.

- (2) The homology loop coproduct Δ_H factors through a map

$$\Delta_H : \overline{HH}_*(A, A) \rightarrow H_*(\overline{C}_*(A, A) \otimes \overline{C}_*(A, A))[n-1]$$

If $[E] = 0$, among the possible choices of W we have $W = 0$, which is balanced, since the two conditions above are trivially satisfied. In general, note that $HH^i(A, A^\vee) \subset \ker(\sharp[E])$ for any $i \neq 0$, so condition (1) only depends on the piece in degree zero W_0 . In any case, one can always choose W to be concentrated in degree zero, since $[E]$ is in $HH_0(A, A) \otimes HH_0(A, A)$ by the connectivity assumption on A ; we prove in Corollary 3.10 that condition (2) of the Definition above is automatically satisfied when $W = W_0$ and $n \geq 2$.

Let us assume that E can be trivialized onto a balanced subcomplex W . The space of choices for the trivialization H , modulo exact terms, has the structure of a torsor over $H_1(C_*(A, A) \otimes C_*(A, A))$. The resulting coproduct Δ_H is compatible with the differential of $\overline{C}_*(A, A)$ but is not natural with respect to maps of smooth dg categories and depends on the choice of H .

There is a certain natural symmetry condition on the space of such choices, depending on the chosen expressions for co, η, α , that we call *appropriately symmetric* in Definition 6.10. This symmetry condition simplifies in some examples (including all the ones we study in this paper) to H being $(-1)^n$ -symmetric (up to exact terms) under the $\mathbb{Z}/2$ action swapping the two $C_*(A, A)$ factors. We then study the resulting coproduct Δ_H under this symmetry assumption. Summarizing our results, we find:

Theorem 1.5 (see Theorem 6.13). *Let A be a smooth connective dg (or A_∞) category over a field \mathbb{k} equipped with a nondegenerate pre-Calabi Yau structure of dimension $n \geq 3$. Suppose*

(E_0, H) is a trivialization of E onto a balanced subspace $W \subseteq C_*(A, A)$. If H is appropriately symmetric, then $(H_*(\widehat{C}_*(A, A))[n-1], \Delta_H)$ is a graded cocommutative and coassociative coalgebra.

Let us now mention the conjectural relation to string topology. Let M be an oriented closed manifold with a triangulation (that is, a ‘combinatorial manifold’) and $A = \mathcal{C}_*(\mathcal{P}M; \mathbb{k})$ be the dg category of chains on the topological category of (Moore) paths in M with concatenation as composition. Then $C_*(A, A)$ is quasi-isomorphic to $\mathcal{C}_*(LM; \mathbb{k})$, the chains on the free loop space LM of M [Goo85]. We have some freedom in choosing the subspace W :

- (1) One option is to take W to be the a subcomplex modeling the image of the map $\mathcal{C}_*(M; \mathbb{k}) \rightarrow \mathcal{C}_*(LM; \mathbb{k})$ induced by inclusion of constant loops.
- (2) Another is to take W to be the subspace of $C_0(A, A)$ generated by $\chi(M) \cdot \text{id}_b$, for some choice of base point $b \in M$.

In a subsequent article, we will describe E , the space of all possible H ’s, and a pre-Calabi-Yau structure on $A = \mathcal{C}_*(\mathcal{P}M; \mathbb{k})$, explicitly from the triangulation of M . We conjecture that for an appropriate choice of H the coproduct Δ_H agrees with the geometrically defined Goresky-Hingston coproduct operation on a reduced version of the homology of LM . We will show that for this data, the two choices of W above are balanced; option (1) should give the usual Goresky-Hingston coproduct on the homology of loop space modulo constant loops, and choice (2) should correspond to lifting this coproduct to $H_*(LM)/\chi(M) \cdot [\text{pt}]$ using some vector field with a single zero at a point $\text{pt} \in M$; the data of this vector field is then encoded in the trivialization H .

Furthermore, we conjecture this coproduct defines a *BV-coalgebra* with respect to the operator given by rotation of loops and may be lifted to a *framed E_2 -coalgebra* structure at the level of reduced Hochschild chains.

1.3. Outline of the proof. Theorem 1.5 is obtained by analyzing the relationship (see Theorem 1.7 (3) below) between the coproduct Δ_H and a product π_H obtained from a mapping cone construction. As a result, the coassociativity (resp. $(-1)^n$ -cocommutativity) of Δ_H is deduced from the associativity (resp. $(-1)^n$ -commutativity) of π_H . The mapping cone construction is inspired by the *categorical formal punctured neighborhood of infinity* as developed by Efimov in [Efi17] and recalled in Section 4. It is similar to the Tate-Hochschild complex considered in [RW19], but suitable for smooth categories and, consequently, for non-simply connected string topology.

Given any smooth dg (or A_∞) category A , which we may think of the non-commutative analog of a smooth but possibly non-proper variety X , the categorical formal punctured neighborhood of infinity is another dg category \widehat{A}_∞ serving as the analog of the category of perfect complexes on the formal punctured neighborhood of the divisor at infinity for some compactification of X . On ‘the other side of mirror symmetry’, when A is the wrapped Fukaya category of a Weinstein domain, a relation between \widehat{A}_∞ and the *Rabinowitz Fukaya category*, an open-string analogue of the Rabinowitz Floer homology, has been recently established in [GGV22]. As an object of the derived category of A -bimodules, \widehat{A}_∞ sits in a distinguished triangle

$$A^! \otimes_A^{\mathbb{L}} A^\vee \rightarrow A \rightarrow \widehat{A}_\infty,$$

where A^\vee denotes the *linear dual* of A . Applying Hochschild chains we obtain a distinguished triangle

$$(1) \quad C^*(A, A^\vee) \cong C_*(A, A)^\vee \xrightarrow{\sharp E} C_*(A, A) \rightarrow C_*(A, \widehat{A}_\infty)$$

in the derived category of complexes of \mathbb{k} -modules. As suggested by the notation, we calculate that the first map $\sharp E$ is given by pairing against the element E we previously defined.

When A is equipped with a pre-CY structure of dimension n , we may consider another model for \widehat{A}_∞ . This model is an A -bimodule M_α defined as the mapping cone of certain A -bimodule morphism

$$f_\alpha : A^\vee[-n] \rightarrow A$$

induced by the the pre-CY structure of A , as discussed in Section 5.1. If the pre-CY structure on A is *non-degenerate*, namely the structure map $\alpha: A \rightarrow A^!$ is a quasi-isomorphism, there is a quasi-isomorphism of A -bimodules $\widehat{A}_\infty \simeq M_\alpha$ (Proposition 5.10). The Hochschild chain complex $C_*(A, M_\alpha)$ is the analog of the Tate-Hochschild complex but now in the setting of smooth pre-CY categories. In fact, $C_*(A, M_\alpha)$ is the mapping cone of the map of complexes

$$F_\alpha: C_*(A, A^\vee)[-n] \rightarrow C_*(A, A)$$

induced by f_α , so we have an isomorphism of underlying graded vector spaces

$$C_*(A, M_\alpha) \cong C_*(A, A^\vee)[1-n] \oplus C_*(A, A).$$

In Definition 5.4, we construct an algebra structure on $C_*(A, M_\alpha)$ with product

$$\pi_{M_\alpha}: C_*(A, M_\alpha) \otimes C_*(A, M_\alpha) \rightarrow C_*(A, M_\alpha)[n]$$

extending the algebraic analogue of the loop product

$$\pi: C_*(A, A) \otimes C_*(A, A) \rightarrow C_*(A, A)[n].$$

The product π is associated to the “pair of pants” in the graphical formalism of [KTV22]. The following statement, which is the main result of Section 5.2, summarizes the homological algebra meaning, as well as the main properties, of the product π_{M_α} .

Theorem 1.6. *Let A be a smooth dg (or A_∞) category equipped with a non-degenerate pre-CY structure of dimension n . The structure map $\alpha: A \rightarrow A^!$ of the pre-CY structure determines a quasi-isomorphism*

$$g^{M_\alpha}: C_*(A, M_\alpha) \xrightarrow{\cong} C^*(A, M_\alpha)$$

of degree $-n$ inducing a map of algebras on (co)homology, where the products on $HH_*(A, M_\alpha)$ and $HH^*(A, M_\alpha)$ are induced by π_{M_α} and the classical Hochschild cup product \smile_{M_α} , respectively. Consequently, π_{M_α} induces an associative and (graded) commutative product on $HH_*(A, M_\alpha) \cong HH_*(A, \widehat{A}_\infty)$.

Subsequently, we explain the sense in which the π_{M_α} relates to Δ_H . Note that, assuming the pre-CY structure on A is non-degenerate, the complex $C_*(A, A^\vee)[-n]$ (the domain of F_α) is quasi-isomorphic to $C^*(A, A^\vee)$, which is the linear dual of $C_*(A, A)$ and consequently a natural setting to consider the linear dual of the coproduct Δ_H . The product π_{M_α} does not require the additional data of a trivialization (E_0, H) . However, in the presence of such additional structure we have the following.

Theorem 1.7 (see Propositions 5.16 and 6.8). *Let A be a smooth dg (or A_∞) category over a field \mathbb{k} equipped with a pre-Calabi Yau structure of dimension n . Suppose (E_0, H) is a trivialization of E onto a balanced subspace $W \subseteq C_*(A, A)$, and write*

$$q := \#E_0 \circ g_\alpha^{A^\vee}: C_*(A, A^\vee)[-n] \rightarrow C_*(A, A).$$

Then there are two maps of complexes

$$\iota_H^1, \iota_H^2: \ker(q)[1] \rightarrow C_*(A, M_\alpha)$$

such that

- (1) the projection of graded vector spaces $p: C_*(A, M_\alpha) \rightarrow C_*(A, A^\vee)[1]$ is a left inverse for both ι_H^1 and ι_H^2 ,
- (2) the map of complexes $p \circ \pi_M \circ (\iota_H^1 \otimes \iota_H^2)$ induces a product

$$\pi_H: H_*(\ker(q)) \otimes H_*(\ker(q)) \rightarrow H_*(\ker(q)),$$

- (3) for any $x_1, x_2 \in H_*(\ker(q))$ and $y \in \overline{HH}_*(A, A)$ we have

$$\langle \pi_H(x_1 \otimes x_2), g_\alpha(y) \rangle = (-1)^{\deg(x_1) \deg(x_2)} \langle x_2 \otimes x_1, (\text{id} \otimes g_\alpha)(g_\alpha \otimes \text{id}) \Delta_H(y) \rangle,$$

where the pairings are induced from the canonical pairing $C_*(A, A^\vee) \otimes C^*(A, A) \rightarrow \mathbb{k}$.

Each of the maps ι_H^1 and ι_H^2 is constructed by “perturbing” the inclusion map of graded vector spaces $\ker(q)[1] \hookrightarrow C_*(A, M_\alpha)$ to a map of complexes by using homotopies, induced by (E_0, H) . These homotopies deform the map F_α into the map given by pairing against E_0 . Our assumption that W is balanced, together with part (3) of the theorem above, mean that the coproduct Δ_H is entirely determined by the data of π_H . Theorem 1.5 then follows by analyzing the properties of the product π_H .

We emphasize our main point: *Theorem 1.7 provides an interpretation of the dual of the algebraic loop coproduct Δ_H as a part of homological algebra operation π_{M_α} , extending the interpretation of the algebraic loop product as the classical Hochschild cup product.*

Finally, Section 7 is devoted to computing explicit examples in the context of string topology of spheres. Our computations confirm that the structure studied in this article is non-trivial in general and coincides partially with other geometrically defined constructions in the literature.

1.4. Relation to existing work. String topology has been studied in the literature through different perspectives. In particular, the loop coproduct was originally constructed in [GH09] using Morse theoretic methods, in [Abb16] using algebraic methods applicable to simply connected manifolds, in [HW22] using Thom-Pontryagin theory and a Riemannian metric, in [NW19] using configuration spaces, and in [CHO20; CHO23] using symplectic Floer theory. See also [NRW23] for a survey on three of these perspectives. Some of the constructions and computations in this paper have direct analogs in the symplectic setting [CHO23]. F. Naef and P. Safronov have been studying the loop coproduct and its relationship to Whitehead torsion and simple homotopy following an algebraic K-theoretic approach; in their very recent preprint [NS23] they give a definition of an *Euler structure*, which in the Euler characteristic zero case should be related to our data (E_0, H) , and describe how these give rise to volume forms on derived mapping stacks. Our algebraic perspective has been influenced and guided by their talks and by discussions we have had with them. However, we come to it from a different angle: we have arrived to explicit formulas for the algebraic loop coproduct by first considering a mapping cone construction inspired by Efimov’s categorical formal punctured neighborhood of infinity (taking a sort of Koszul pre-dual of the main construction of [RW19]) and using the formalism of pre-Calabi Yau structures (developed in [KTV22]) to incorporate chain-level Poincaré duality.

ACKNOWLEDGMENTS

We would like to thank Damien Calaque, Kai Cieliebak, Florian Naef, Sheel Ganatra, Ezra Getzler, Ralph Kaufmann, Maxim Kontsevich, Alexandru Oancea, Pavel Safronov, Bruno Vallette, Yiannis Vlassopoulos, and Nathalie Wahl for helpful conversations, and IHES for providing great working conditions. This project is partly supported by the Simons Collaboration on Mirror Symmetry.

Conventions. We will use *homological* grading convention throughout the article. Given a commutative ring \mathbb{k} , we denote by $(\text{Ch}(\mathbb{k}), \otimes)$ the symmetric monoidal category of (unbounded) \mathbb{k} -chain complexes with differential of degree -1 . If $(V, d) \in \text{Ch}(\mathbb{k})$ then (V^\vee, d) is the chain complex with $V_n^\vee = \text{Hom}_{\mathbb{k}}(V_{-n}, \mathbb{k})$ and $d(f)(x) = -(-1)^{\deg(f)} f(dx)$. To unclutter notation, we will often use the generic notation d for the differential on any of those complexes, such as the Hochschild chain and cochain differentials and the differentials on their tensor products.

A dg category is defined as a category enriched over $(\text{Ch}(\mathbb{k}), \otimes)$. A connective dg category is a category enriched over the symmetric monoidal category of non-negatively graded chain complexes. We refer to [Tab10; Kel06] for further generalities on dg categories. The symbol $X \cong Y$ means X and Y are “isomorphic” and $X \simeq Y$ means X and Y are “quasi-isomorphic”.

Given any $M = (M_*, d) \in (\text{Ch}(\mathbb{k}), \otimes)$, we denote by $M[n]$ the complex obtained by shifting M down by n , namely, the complex given by $M[n]_p = M_{p-n}$ with differential $(-1)^n d$. In particular, maps $M \rightarrow N$ of degree $-n$ are equivalent to maps $M \rightarrow N[n]$ of degree 0, products $M \otimes M \rightarrow M$ of degree $-n$ are equivalent to products $M[-n] \otimes M[-n] \rightarrow M[-n]$ of degree 0, and coproducts $M \rightarrow M \otimes M$ of degree $-n$ are equivalent to coproducts $M[n] \rightarrow M[n] \otimes M[n]$ of degree 0.

For simplicity, we sometimes write the Hochschild (co)chain complex $C^*(A, A)$ (resp. $C_*(A, A)$) with values on A as $C^*(A, A)$ (resp. $C_*(A, A)$).

2. PRE-CY CATEGORIES AND THEIR GRAPHICAL CALCULUS

Throughout this paper we will be working in the setting of strictly unital \mathbb{Z} -graded A_∞ -categories. For ease of exposition in this section we will just use A_∞ -algebras. Moreover, we consider differential graded algebras (dg algebras) as special types of A_∞ -algebras with trivial structure maps $\mu^{\geq 3}$. In the literature there are many different notations and sign conventions for such objects; we will be mostly following [KS08; Kel06].

2.1. The graphical calculus. We will need to write formulas for morphisms and homotopies of such objects, Hochschild cycles and cocycles etc. whose formulas are often too complicated to be enlightening.

For that, instead of formulas we will use a certain graphical calculus that was developed to deal with A_∞ -algebras/categories, bimodules over them and Hochschild co/chains. An early version of this graphical calculus, including only Hochschild cochains, appeared in Kontsevich and Soibelman's proof [KS00] of the Deligne conjecture; this was extended to include Hochschild chains in [KS08]. More recently, in [KTV22] this graphical calculus is explained more systematically in terms of 'ribbon quivers', that is, acyclic oriented ribbon graphs with markings, to include what is called in *op.cit.* 'higher Hochschild cochains', used to define pre-Calabi-Yau structures.

2.1.1. Hochschild chains and cochains. We will use the normalized complexes for Hochschild chains and cochains. Let (A, μ) be a strictly unital A_∞ -algebra over \mathbb{k} , and M an A -bimodule. Denoting $\overline{A} = A/(\mathbb{k} \cdot 1_A)$, the Hochschild chain complex of A with values on M will be denoted by

$$C_*(A, M) = \bigoplus_{k \geq 0} M \otimes \overline{A}[1]^{\otimes k}.$$

We will use the notation $m[a_1 | \dots | a_k]$ to denote an element of this complex. The Hochschild cochain complex will be denoted by

$$C^*(A, M) = \prod_{k \geq 0} \text{Hom}_{\mathbb{k}}(\overline{A}[1]^{\otimes k}, M),$$

and we will assume homological convention, meaning that $C^p(A, M)$ denotes the \mathbb{k} -module of maps of degree $-p$ in $\prod_{k \geq 0} \text{Hom}_{\mathbb{k}}(\overline{A}[1]^{\otimes k}, M)$.

We visualize a Hochschild cochain φ as living in a disc with one output on the bottom, and inputs running along the top; we denote this by the diagram



We visualize this vertex as receiving any number k of $\overline{A}[1]$ -arrows, each carrying a factor of

$$a_1 \otimes \dots \otimes a_k \in (\overline{A}[1])^{\otimes k}$$

from left to right, and outputting $\varphi(a_k, \dots, a_k) \in M$ along the bottom M -arrow, which we distinguish by color.

As for Hochschild chains, we will visualize an element $m[a_1 | \dots | a_k] \in M \otimes \overline{A}[1]^{\otimes k}$ as traveling down a cylinder with one M line and k $\overline{A}[1]$ lines running down along its length.

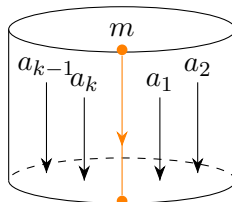

2.1.2. *Higher Hochschild cochains.* We also have vertices with multiple outgoing edges; in a vertex with k outgoing arrows, we insert an element of the graded vector space

$$(2) \quad C_{(k)}^*(A) = \prod_{\{(n_1, \dots, n_k) | n_i \geq 0\}} \text{Hom}_{\mathbb{k}}(\overline{A}[1]^{\otimes n_1} \otimes \dots \otimes \overline{A}[1]^{\otimes n_k}, A^{\otimes k})$$

which was called the space of k th higher Hochschild cochains in [KTV22]. We visualize an element φ of this space, when $k = 3$ for example, as a vertex

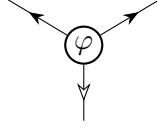

where the first outgoing factor of A is marked by the white arrowhead.

2.1.3. *Oriented ribbon quivers.* A ribbon quiver is a ribbon graph whose edges are directed; we always require that there are no directed cycles. We add some markings on this quiver: some of the valence one sources of this quiver, which we label by an \times , are places where we can input a Hochschild chain. In each other vertex with k outgoing legs we can insert a k th higher Hochschild cochain, and at each sink vertex, which we denote by \circ , we can read off a Hochschild chain. Note that each sink may have more than one incoming arrow; in that case, we mark one of its incident edges with a white arrowhead, meaning that we read the output Hochschild chain starting from it.

We make the convention that on vertices labeled with a black dot we will use the A_∞ -structure map μ . All the other vertices are either inputs or outputs; in order to fix the ambiguity we will consider all the inputs/outputs of the same type totally ordered

Example 2.1. Consider the ribbon quiver below:

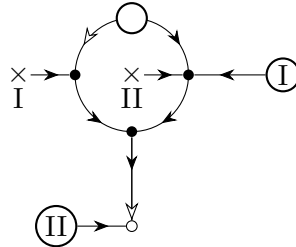

to which we give a ribbon structure by the embedding onto the page. The ribbon quiver above lives on a surface of genus zero, with two incoming \times boundary components (on which the \times vertices live) and one outgoing \circ boundary component (on which the \circ vertex lives).

Into the circle vertex on the top, we will input an element of $C_{(2)}^*(A)$, that is, a higher Hochschild cochain with two outputs. The white arrowhead marks which arrow receives the first factor of A . Into the circle vertices on the right and bottom left, we will input an element of $C^*(A, A)$, that is, a (usual) Hochschild cochain, and into the \times vertices, we will input Hochschild chains. Since there are two of them we consider an ordering of the \times vertices to be part of the data of the ribbon quiver; we indicate this on the diagram with Roman numerals. Out of the little circle on the bottom we read the outgoing Hochschild chain; the arriving white arrowhead indicates which factor of A is to be read first.

In order to interpret a ribbon quiver like the one in the above example as an operation between Hochschild co/chains, with a coherent choice of signs, one must also pick an *orientation*. There are many different ways this notion of orientation can be phrased; here we choose to follow a slight variation on the conventions of [KTV22], which brings it closer to the definition of orientation on the usual ribbon graph complex, and will be more appropriate to our ends.

For each ribbon quiver $\vec{\Gamma}$, we consider the set

$$\text{Or}_{\Gamma} = \text{Span}_{\mathbb{Z}/2\mathbb{Z}}(\{\text{total orderings of all edges of } \Gamma\})/X$$

where the $\mathbb{Z}/2\mathbb{Z}$ -submodule X is spanned by $o_1 - (-1)^{s(o_1, o_2)} o_2$ for any two total orderings o_1, o_2 of edges, with $s(o_1, o_2)$ being the sign of the permutation. Each oriented ribbon quiver gives a map between appropriate tensor products of spaces of (higher) Hochschild co/chains.

Example 2.2. Returning to Example 2.1, upon labeling all the edges we can specify an orientation, representing it by a total ordering of the edges. For example, the following data gives an oriented ribbon quiver

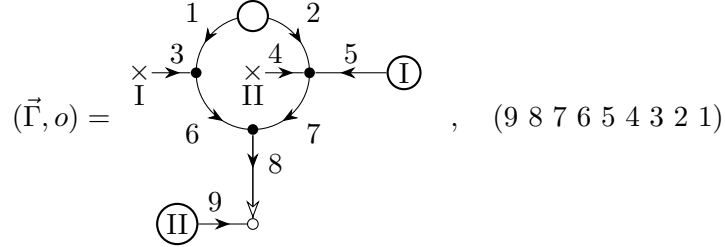

for any A_∞ -algebra, the oriented ribbon quiver $(\vec{\Gamma}, o)$ gives a map

$$C_*(A, A) \otimes C_*(A, A) \otimes C^*(A, A) \otimes C^*(A, A) \otimes C_{(2)}^*(A) \rightarrow C_*(A, A).$$

To get the appropriate sign, one follows the prescriptions of [KTV22, Subsection 2.2], using the given orientation o to determine the sign of each term. We also refer to [KTV22, Section 6.1.4] for a detailed example of how to get a map from an oriented ribbon quiver.

2.1.4. Differential on oriented ribbon quivers. Not every map given by an oriented ribbon quiver is a map of complexes, but the failure of such a map to intertwine the differentials on the source and target can be encoded itself by a differential acting on the space spanned by oriented ribbon quivers. This is described precisely in [KTV22, Section 2]. For sake of example, let us just illustrate a familiar example in our language, using the operations appearing in the *Tamarkin-Tsygan calculus* of Hochschild (co)chains [TT05].

Example 2.3. The following oriented ribbon quiver gives a ‘cap product’ between a Hochschild cochain and a Hochschild chain:

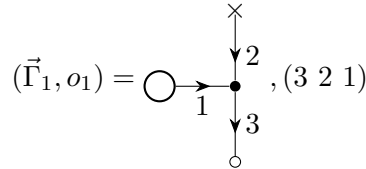

We will denote $\varphi \frown x = (\vec{\Gamma}_1, o_1)(\varphi, x)$.

There is another version of the cap product, given by the diagram

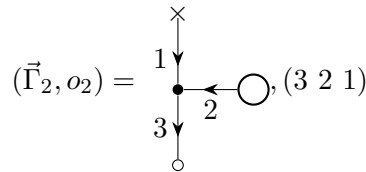

whose corresponding operation we will denote $x \frown \varphi = (\vec{\Gamma}_1, o_1)(\varphi, x)$. Both of these oriented ribbon quivers are d -closed, and the corresponding operations descend to cohomology, giving maps $HH^*(A, A) \otimes HH_*(A, A) \rightarrow HH_*(A, A)$, interpreted as ‘contraction’ of a vector field with a form.

These operations, seen as maps $C^*(A, A) \otimes C_*(A, A) \rightarrow C_*(A, A)$, are homotopic. We can write down a homotopy by giving a d -primitive of the difference, for example:

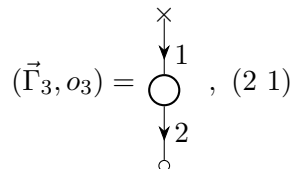

whose differential is $d(\vec{\Gamma}_3, o_3) = (\vec{\Gamma}_1, o_1) - (\vec{\Gamma}_2, o_2)$; this means that for any φ, x we have

$$d((\vec{\Gamma}_3, o_3)(\varphi, x)) + (\vec{\Gamma}_3, o_3)(\delta\varphi, x) + (-1)^{|\varphi|}(\vec{\Gamma}_3, o_3)(\varphi, dx) = (\vec{\Gamma}_1, o_1)(\varphi, x) - (\vec{\Gamma}_2, o_2)(\varphi, x)$$

We can write down another homotopy:

$$(\vec{\Gamma}_4, o_4) = \begin{array}{c} \times \\ \downarrow 1 \\ \circ \\ \uparrow 2 \\ \bigcirc \end{array}, \quad (2 \ 1)$$

whose differential is $d(\vec{\Gamma}_4, o_4) = (\vec{\Gamma}_2, o_2) - (\vec{\Gamma}_1, o_1)$. Thus the combination $(\vec{\Gamma}_3, o_3) + (\vec{\Gamma}_4, o_4)$ is d -closed: we denote the corresponding map of complexes $L_\varphi = (\vec{\Gamma}_3, o_3)(\varphi, x) + (\vec{\Gamma}_4, o_4)(\varphi, x)$. This map descends to homology and gives a map $HH^*(A, A) \otimes HH_*(A, A) \rightarrow HH_*(A, A)[-1]$, interpreted as the ‘Lie derivative’, see e.g. [TT05, Section 3.3]. The Hochschild chain differential itself is $\partial = L_\mu$.

We will also consider a slightly different class of diagrams, each of which outputs is instead a Hochschild *cochain*. To distinguish these types of outputs, we write these diagrams inside of a large circle with one outgoing M -arrow at the bottom, for some A -bimodule M . The diagrams where $M = A$ and whose vertices all have exactly one output represent exactly the operations appearing in [KS00], and giving the E_2 -algebra structure on the Hochschild cochains $C^*(A, A)$.

Example 2.4. Let M be some A -bimodule, and let us color orange the arrows carrying factors of M . The oriented ribbon quiver

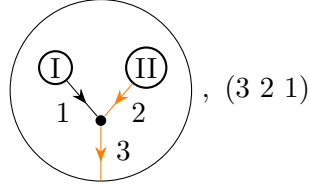

is d -closed, and thus gives a map of complexes $\smile: C^*(A, A) \otimes C^*(A, M) \rightarrow C^*(A, M)$, which can be verified to be the familiar *cup product* of Hochschild cochains when $M = A$.

Example 2.5. Let M be some A -bimodule, and let us color orange the arrows carrying factors of M . The oriented ribbon quiver below

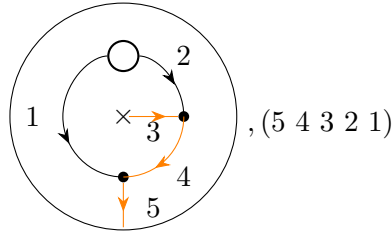

gives a map of complexes $C_{(2)}^*(A) \otimes C_*(A, M) \rightarrow C^*(A, M)$. For any fixed $\alpha \in C_{(2)}^n(A)$ which is closed under the differential $\delta = [\mu, -]$, we will denote the corresponding map of complexes by

$$g_\alpha^M: C_*(A, M) \rightarrow C^*(A, M)[n]$$

and simply by g_α when M is the diagonal bimodule A .

We can compose oriented ribbon quivers that have compatible outputs/inputs, by identifying the outgoing arrow of $\vec{\Gamma}_1$ and the incoming arrow of $\vec{\Gamma}_2$, as a new arrow f of the combined ribbon quiver $\vec{\Gamma}$. As for the orientation, we permute the sequences of edges (keeping track of the sign) so that the two arrows to be composed are adjacent [†].

[†]For more details about the composition operation in general see [KTV22, Section 6].

Remark 2.6. The attentive reader that consults [KTV22] will note that the definitions of degree and differential that we use in this paper are slightly different from the ones presented in *op.cit.* The reason for this difference is that, in this article, we are only fixing the A_∞ structure maps in the \bullet vertices and regard the other vertices (including all the ones with ≥ 2 outgoing arrows) as places where we can insert possibly other (higher) Hochschild cochains, which have to be ordered. The comparison between our conventions here and the ones in *op.cit.* is straightforward from the definition of the pre-CY structure equations.

2.2. Pre-CY structures. The notion of a pre-Calabi-Yau structure on an A_∞ -algebra or category was given by Kontsevich and Vlassopoulos and later developed in more detail by those authors together with the second-named author of this paper in [KTV22]. Let us recall the relevant definitions from that paper.

Let (A, μ) be an A_∞ -category; the conditions on the A_∞ structure maps $\mu = \mu^1 + \mu^2 + \dots$ say exactly that the element $\mu \in C^2(A)$ satisfies the equation $\mu \circ \mu = 0$, where \circ is the Gerstenhaber product. The commutator bracket $[-, -]$ associated to the Gerstenhaber product endows $C^*(A, A)[1]$ with the structure of a dg Lie algebra. The cochain complex $(C^*(A, A), \delta = [\mu, -])$ calculates the Hochschild cohomology of (A, μ) .

One can consider vertices with more outputs, and evaluate them in a similar way; the Gerstenhaber bracket $[-, -]$ then extends to vertices with more outputs. In order to discuss these extended brackets, we need to include certain shifts and signs depending on a chosen integer n . For each $k \geq 1$, we denote by $C_{(k)}^*(A)$ the vector space spanned by vertices with k outputs, see Eq. (2). This space has an action by the cyclic group $\mathbb{Z}/k\mathbb{Z}$; we twist this action by a sign, declaring that, besides the Koszul sign, the generator of $\mathbb{Z}/k\mathbb{Z}$ acts with an extra sign $(n-1)(k-1)$. We denote by $C_{(k,n)}^*(A) = C_{(k)}^*(A)^{\mathbb{Z}/k\mathbb{Z}[(n-2)(k-1)]}$ its (appropriately shifted) space of invariants. We can assemble all of these spaces as $C_{[n]}^*(A) := \prod_{k \geq 1} C_{(k,n)}^*(A)$; naturally we have $C^*(A, A) \subset C_{[n]}^*(A)$.

Proposition 2.7 ([KTV22, Proposition 10]). *For any $k, l \geq 1$, there is a ‘necklace product’ $\circ : C_{(k,n)}^*(A)[1] \otimes C_{(l,n)}^*(A)[1] \rightarrow C_{(k+l-1,n)}^*(A)[1]$ which agrees with the Gerstenhaber product when $k = l = 1$, and whose associated ‘necklace bracket’ gives $C_{[n]}^*(A)[1]$ the structure of a dg Lie algebra.*

Definition 2.8. A pre-CY structure of dimension n on (A, μ) is an element $m = \mu + m_{(2)} + \dots \in C_{[n]}^2(A)$ such that $m_{(k)} \in C_{(k,n)}^2$ and $m \circ m = 0$.

That is, $m_{(k)} \in C_{(k,n)}^2(A)$ denotes the part of the pre-CY structure with k outgoing legs. The part of the equation $m \circ m = 0$ with one output is just the usual A_∞ -structure equation $\mu \circ \mu = 0$.

2.2.1. Truncated pre-CY structures. For the purposes of this paper, it will be unnecessary to consider all the maps $m_{(k)}$; for that reason, we will use truncated versions of these structures. The space $C_{[n]}^*(A)$ on which the necklace bracket acts has a decreasing filtration given by $F^\ell C_{[n]}^*(A) = \prod_{k \geq \ell} C_{(k,n)}^*(A)$. The necklace product and bracket descend to the quotients $C_{[n]}^*(A)/F^\ell C_{[n]}^*(A)$, so we can make the definition:

Definition 2.9. A ℓ -truncated pre-CY structure of dimension n on A is a solution m of the equation $m \circ m = 0$ on $C_{[n]}^*(A)/F^{\ell+1} C_{[n]}^*(A)$.

For example, an 1-truncated pre-CY structure of any dimension is just an A_∞ -structure μ ; a 2-truncated pre-CY structure of dimension n has, in addition, a $[\mu, -]$ -closed element $m_{(2)} \in C_{(2)}^n(A)$.

2.2.2. Product on Hochschild homology of pre-CY. In [KTV22], it is described how, given a pre-CY structure m of dimension n on A , there is an action of a large PROP of chains on

moduli spaces of Riemann surfaces with framed punctures on the Hochschild homology of A . More specifically, for any $g \geq 0$, $m \geq 1$, $k \geq 1$, there is a map of complexes

$$C_*(A, A)^{\otimes m} \otimes C_*^{\text{cell}}(\mathcal{M}_{g, \vec{m}, \vec{k}}) \rightarrow C_*(A, A)^{\otimes k}[(2g + m - 1)n]$$

where $C_*^{\text{cell}}(\mathcal{M}_{g, \vec{m}, \vec{k}})$ is a certain cellular chain complex coming from a stratification of the corresponding moduli space.

Restricting attention to genus zero, and looking at operations with one output, that is, with $n = 1$, we get the action of the operad of chains on the framed little 2-disk operad; that is, $C_*(A, A)[n]$ is a framed E_2 -algebra and thus $HH_*(A, A)[n]$ is a BV algebra. We will choose a particular representative for the chain-level product

$$(3) \quad \pi : C_*(A, A) \otimes C_*(A, A) \rightarrow C_*(A, A)[n]$$

given by the following oriented ribbon quiver:

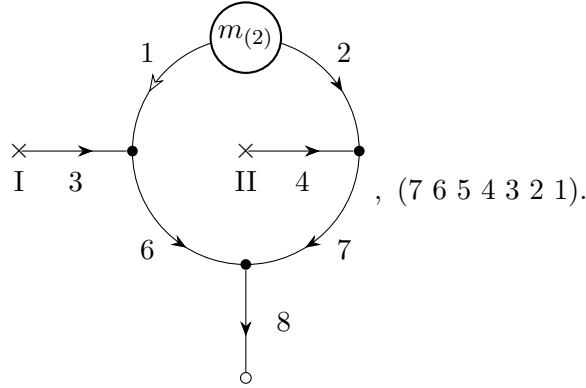

As the diagram suggests, into the vertex on the top we input the $m_{(2)}$ component of the pre-CY structure on A . We call the induced product on Hochschild homology the *algebraic loop product*; this is an associative operation, as a consequence of the statements of *op.cit.* We note that we only need a 2-truncated pre-CY structure to define this product.

2.2.3. Relations to other notions of Calabi-Yau. Let us now recall some of the relations between the notion of pre-CY structure and other notions of Calabi-Yau categories. For this section we assume that \mathbb{k} is a field of characteristic zero.

Theorem 2.10 ([KTV22, Proposition 14]). *If the category A has finite-dimensional hom spaces, then the data of a pre-CY structure of dimension n on A is equivalent to the data to a cyclic A_∞ -structure with pairing of dimension $1-n$ on $A \oplus A^\vee[1-n]$, such that A is an A_∞ -subcategory.*

By $(-)^{\vee}$ we denote the linear dual category (same objects as A and morphisms given by $A^\vee(x, y) = (A(y, x))^\vee$). The case of a finite-dimensional algebra appeared first in the work of Tradler-Zeinalian [TZ07b], under the name of ‘ \mathcal{V}_∞ -algebra’.

However, this characterization will be of limited utility for us, since we will be interested in categories that are not of finite-dimension over \mathbb{k} . Instead, our categories will be smooth; recall that A is smooth if its diagonal bimodule A is perfect [KS08]. Then, its bimodule dual $A^!$ is also perfect, and there is a quasi-isomorphism $C_*(A, A) \simeq \text{Hom}_{A^e}(A^!, A)$ between the Hochschild chains and A_∞ -bimodule morphisms between $A^!$ and A .

We recall the definition of a smooth Calabi-Yau structure on A . Let n be an integer, the ‘dimension’; a n -CY structure on A is a negative cyclic chain of degree n

$$\tilde{\omega} = \omega + \omega_1 u + \omega_2 u^2 + \cdots \in C_*(A, A)[[u]]$$

closed under the differential $\partial + uB$, whose image $\omega \in C_n(A, A)$ corresponds to a quasi-isomorphism between $A^!$ and $A[n]$ under the natural isomorphism $C_*(A, A) \simeq \mathbb{R}\text{Hom}_{A^e}(A^!, A)$, see e.g. [KTV23, Definition 1]. On the other hand, there is also a quasi-isomorphism

$$(4) \quad C_{(2)}^*(A) \simeq \mathbb{R}\text{Hom}_{A^e}(A, A^!),$$

leading to the following definition.

Definition 2.11. We say $\alpha \in C_{(2)}^n(A)$ is *non-degenerate* if it corresponds to a quasi-isomorphism $A \xrightarrow{\simeq} A^1[n]$ under the identification Eq. (4). We say a *pre-CY structure is non-degenerate* if its element $m_{(2)}$ is non-degenerate.

Remark 2.12. Note that for any non-degenerate cycle $\alpha \in C_{(2)}^n(A)$ the map g_α^M in Example 2.5 is a quasi-isomorphism.

If $\tilde{\omega}$ is an n -CY structure, there exists a closed element $\alpha \in C_{(2)}^n(A)$ whose image under the identification Eq. (4) is a quasi-inverse to the image of ω . The main result of [KTV23] is that, when ω comes from a closed negative cyclic chain $\tilde{\omega}$, one can choose such an α that extends to a full pre-CY structure of dimension n . Conversely, given a non-degenerate pre-CY structure, there is a compatible smooth CY structure. More precisely, we have:

Theorem 2.13. *If (A, μ) is a smooth A_∞ -category and $\tilde{\omega}$ a smooth n -dimensional CY structure on it, then there is a pre-CY structure $m = \mu + \alpha + m_{(3)} + \dots$ such that $g_\alpha(\omega)$ is homologous to the unit cochain $1 \in C^0(A, A)$. Here g_α is given in Example 2.5. Conversely, if we have such an m that is non-degenerate, then there is a smooth CY structure $\tilde{\omega}$ whose component ω satisfies the same condition.*

3. CHAIN-LEVEL CHERN CHARACTER AND COPRODUCT

As argued by Shklyarov in [Shk13], a perfect A -bimodule M should give a certain distinguished class $[E_M] \in HH_*(A, A) \otimes HH_*(A, A)$ of degree zero, its *Chern character*. We now propose, using the graphical calculus explained in the previous section, what we believe to be an explicit representative E_M for this class (Definition 3.3). Moreover, we show that given a smooth A satisfying appropriate conditions, a pre-CY structure m together with a trivialization of E_A onto a subcomplex $W \subseteq C_*(A, A)$ give rise to a chain-level coproduct on $C_*(A, A)/W$ Definition 3.7 and Proposition 3.9; this will be the *algebraic Goresky-Hingston loop coproduct*.

3.1. Chern character. Let A be an A_∞ -category. Given any A -bimodule M , there is an A -bimodule $M^!$ called its *bimodule dual*, see e.g. [KS08, Section 8]; if M is a perfect bimodule then $M^!$ is also perfect, there are quasi-isomorphisms $M^! \simeq M$ and

$$N \otimes_{A^e}^{\mathbb{L}} M^! \simeq \mathbb{R}\mathrm{Hom}_{A^e}(M, N), \quad N \otimes_{A^e}^{\mathbb{L}} M \simeq \mathbb{R}\mathrm{Hom}_{A^e}(M^!, N),$$

for any A -bimodule N , see [KS08, Remark 8.2.4].

3.1.1. Coevaluation vertex. Let M be a perfect bimodule.

Definition 3.1. A *coevaluation vertex* $\mathrm{co}_M \in M \otimes_{A^e}^{\mathbb{L}} M^!$ is any element representing the class corresponding to the identity morphism id_M under the quasi-isomorphism $M \otimes_{A^e}^{\mathbb{L}} M^! \simeq \mathbb{R}\mathrm{Hom}_{A^e}(M, M)$.

We call this element co_M a ‘vertex’ since we visualize it as a drawing

$$(5) \quad \begin{array}{c} \begin{array}{ccc} & \begin{array}{c} \uparrow \\ \uparrow \\ \uparrow \\ \uparrow \\ \uparrow \\ \uparrow \\ \uparrow \\ \uparrow \\ \uparrow \\ \uparrow \end{array} & \\ & \begin{array}{c} \circ \\ \text{co}_M \end{array} & \\ & \begin{array}{c} \downarrow \\ \downarrow \\ \downarrow \\ \downarrow \\ \downarrow \\ \downarrow \\ \downarrow \\ \downarrow \\ \downarrow \\ \downarrow \end{array} & \\ M \xrightarrow{\text{orange}} & & \xrightarrow{\text{blue}} M^! \end{array} \end{array}$$

where the black arrows schematically denote outgoing factors of the bar complex $B\bar{A}[1]$. Explicitly, co_M is an element of the complex $\bigoplus_{i,j \geq 0} M \otimes \bar{A}[1]^{\otimes i} \otimes M^! \otimes \bar{A}[1]^{\otimes j}$ modeling the two-sided derived tensor product $M \otimes_{A^e}^{\mathbb{L}} M^!$.

It follows from the quasi-isomorphisms above that composition with a coevaluation vertex gives a map realizing the quasi-isomorphism

$$\mathbb{R}\mathrm{Hom}_{A^e}(M^!, N) \xrightarrow{\simeq} N \otimes_{A^e}^{\mathbb{L}} M.$$

3.1.2. *The canonical pairing vertex.* Consider the complex of vertices with one M input into one side, one $M^!$ input into the other, and two A outputs on either side of the inputs, with $A[1]$ inputs into the four corners, as in the following diagram:

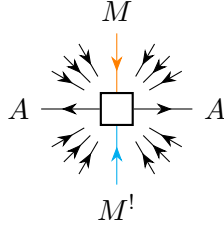

We use a square to distinguish which incoming arrows carry bimodules, and which incoming arrows carry factors of the bar complexes. The space of vertices as above is the space $\mathbb{R}\mathrm{Hom}_{A^e \otimes A^e}(M \otimes M^!, A^{op} \otimes A)$ calculated by using the bar resolution of the bimodules $M, M^!$, namely the complex $\prod_{i,j,k,l \geq 0} \mathrm{Hom}(\overline{A}[1]^{\otimes i} \otimes M \otimes \overline{A}[1]^{\otimes j} \otimes \overline{A}[1]^{\otimes k} \otimes M^! \otimes \overline{A}[1]^{\otimes l}, A \otimes A)$.

The differential on this complex can be deduced from the differential on this derived Hom space. When part of a larger diagram, this differential acts by splitting a multiplication away from the square, staying within each angle. For example:

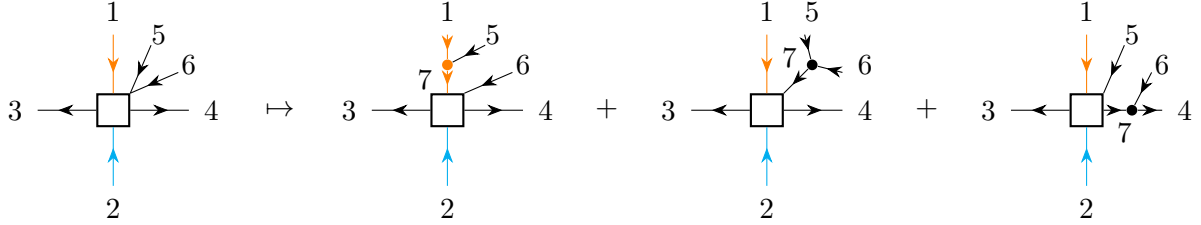

with orientation $(\dots 6 5 4 3 2 1 \dots)$ on the left-hand side and $(7 \dots 6 5 4 3 2 1 \dots)$ on the right-hand side. Consider now the quasi-isomorphisms

$$\mathbb{R}\mathrm{Hom}_{A^e \otimes A^e}(M \otimes M^!, A^{op} \otimes A) \xrightarrow{\sim} \mathbb{R}\mathrm{Hom}_{A^e}(M, A \otimes_A^{\mathbb{L}} M \otimes_A^{\mathbb{L}} A) \xrightarrow{\sim} \mathbb{R}\mathrm{Hom}_{A^e}(M, M)$$

given by composition on the bottom with the coevaluation vertex, followed by the isomorphism $A \otimes_A^{\mathbb{L}} M \otimes_A^{\mathbb{L}} A \xrightarrow{\sim} M$:

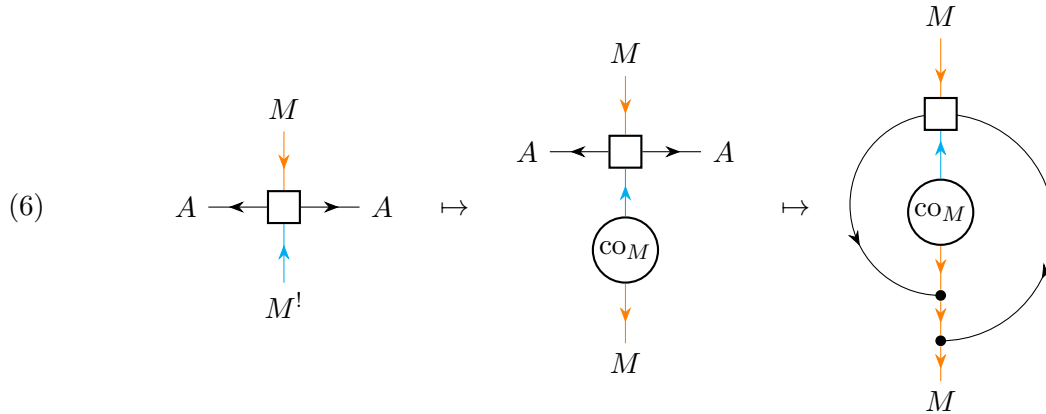

Definition 3.2. A *pairing vertex* η_M of a perfect bimodule M is a closed element of degree zero in the complex $\mathbb{R}\mathrm{Hom}_{A^e \otimes A^e}(M \otimes M^!, A^{op} \otimes A)$ which maps, in homology, to the identity morphism in $\mathbb{R}\mathrm{Hom}_{A^e}(M, M)$.

Strictly speaking, only the cohomology classes of co_M and η_M are well-defined from the data of A and M , while the chain-level representatives depend on choices. We will just fix a choice for these vertices, and refer to them as *the* coevaluation and pairing vertices.

3.1.3. *Definition of chain-level Chern character.* Let A be any A_∞ -category, not necessarily smooth, and M a perfect bimodule. In this subsection we give a chain-level expression for a certain element associated to M , using (a choice of) the vertices co_M, η_M .

Definition 3.3. The *chain-level Chern character of the perfect bimodule M with respect to co_M and η_M* is the element of degree zero

$$E_M \in C_*(A, A) \otimes C_*(A, A)$$

given by the evaluating the following oriented diagram on the ‘elbow’ (genus 0 surface with two outputs):

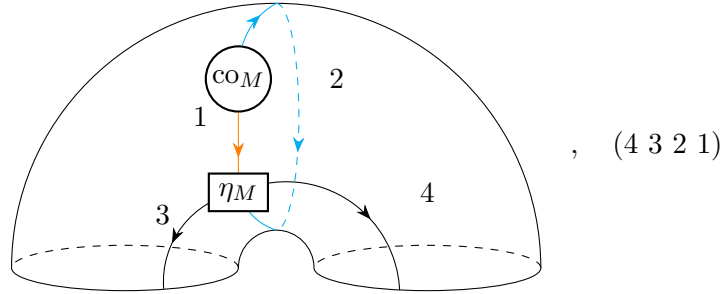

Since co_M and η_M are closed, so is $E_M \in C_*(A, A) \otimes C_*(A, A)$. We can define the Chern character class of M as the class $[E_M] \in H_0(C_*(A, A) \otimes C_*(A, A))$. The element E_M is only well-defined at the chain level once we make choices for η_M and co_M , but its homology class is canonically well-defined since those two vertices have canonically well-defined classes. Recall that the A_∞ -category A is *smooth* if its diagonal bimodule A is perfect; in that case we denote simply $\text{co} = \text{co}_A, \eta = \eta_A$ and $E = E_A$.

Remark 3.4. For a general smooth A , there is no reason for the Chern character E to have any sort of symmetry under the $\mathbb{Z}/2\mathbb{Z}$ action on $C_*(A, A) \otimes C_*(A, A)$, *even at the homology level*. On the other hand, we will see later in Theorem 6.3 that the existence of a Calabi-Yau structure on A imposes (skew)symmetry at the homology level.

Remark 3.5. We may see from [PV12, Proposition 1.2.4] that the definition of E_M above coincides with the Chern character of M of Shklyarov [Shk13].

3.2. **Coproduct.** Let A be a smooth A_∞ -category, and let us fix representatives for the vertices co and η . We define a map of graded vector spaces

$$G : C^*(A, A) \rightarrow C_*(A, A) \otimes C_*(A, A)[-1]$$

given by

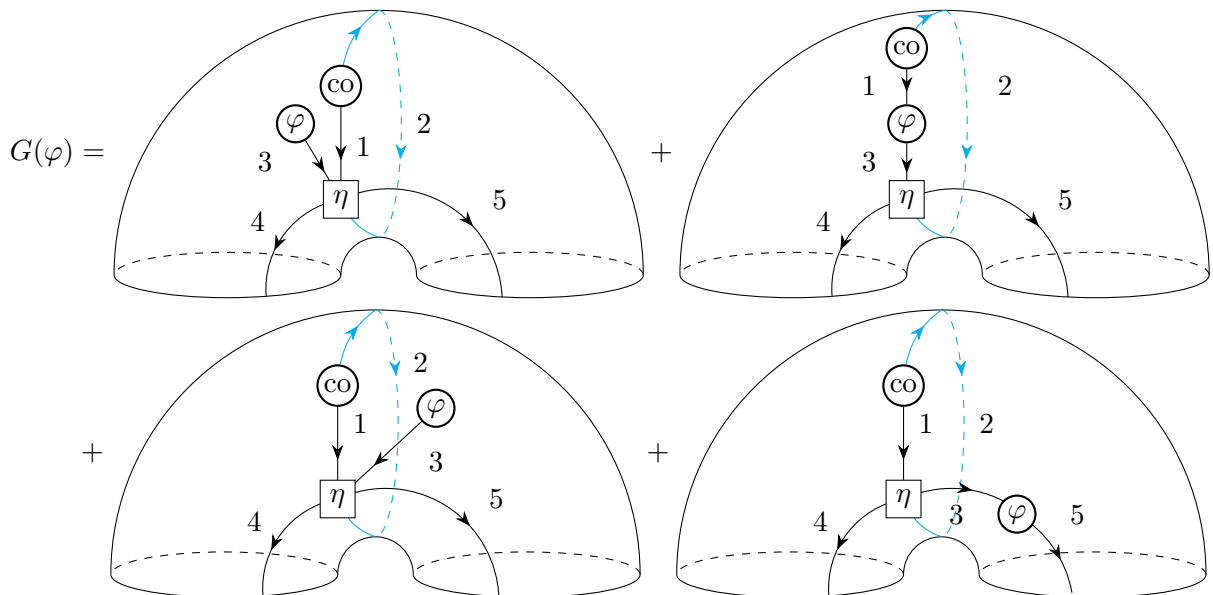

all four with orientation (5 4 3 2 1).

Note that G is *not* a map of complexes. Instead, computing the differential of its diagram, we find the following relation:

$$(7) \quad d(G(\varphi)) + G(d\varphi) = (\varphi \frown \otimes \text{id})E - (\text{id} \otimes \varphi \frown)E.$$

Here, we recall that the cap product is given in Example 2.3.

3.2.1. *The case $[E] = 0$.* When the homology class of E is zero, a choice of trivialization of this cycle gives rise to a coproduct of degree $1 - n$ as we now discuss.

Definition 3.6. A *trivialization of E* is an element H of degree 1 in $C_*(A, A) \otimes C_*(A, A)$ such that $dH = E$.

Definition 3.7. Suppose A is a smooth A_∞ -category and H is a trivialization of E .

(1) Define a map of complexes $\tilde{\Delta}_H : C^*(A, A) \rightarrow C_*(A, A) \otimes C_*(A, A)[-1]$ by

$$\tilde{\Delta}_H(\varphi) = G(\varphi) - (-1)^{\deg(\varphi)}((\varphi \frown \otimes \text{id})H - (\text{id} \otimes \varphi \frown)H).$$

(2) Suppose $\alpha \in C_{(2)}^n(A)$ is a closed element and let

$$g_\alpha : C_*(A, A) \rightarrow C^*(A, A)[n]$$

be as defined in Example 2.5. Define the (chain level) *algebraic loop coproduct* associated to this data by

$$\Delta_H = \tilde{\Delta}_H \circ g_\alpha : C_*(A, A)[n-1] \rightarrow C_*(A, A)[n-1] \otimes C_*(A, A)[n-1].$$

The above definition makes sense for any ring \mathbb{k} over which the data $(A, \text{co}, \eta, \alpha, H)$ is defined. When \mathbb{k} is a field, the Künneth map is an isomorphism and we get a coproduct on homology:

$$\Delta_H : HH_*(A, A)[n-1] \rightarrow HH_*(A, A)[n-1] \otimes HH_*(A, A)[n-1]$$

We will be interested in this coproduct when $\alpha = m_{(2)}$ is one of the structure maps of a (truncated) pre-CY structure on A . Note that the operation above is defined for any choice of α , but it will not be coassociative or (graded) cocommutative in general, compare Theorem 6.13.

3.2.2. *The case $[E] \neq 0$.* In string topology applications, one often encounters the case when the class $[E]$ is nonzero but it may be represented by a cycle E_0 living in a smaller subcomplex of $C_*(A, A) \otimes C_*(A, A)$. We use the same chain-level formula for Δ_H to define a coproduct on a quotient space.

Definition 3.8. Suppose $W \subseteq C_*(A, A)$ is a subcomplex of \mathbb{k} -modules. A *trivialization of E onto W* consists of a pair (E_0, H) such that

$$E_0 \in C_*(A, A) \otimes W + W \otimes C_*(A, A) \subseteq C_*(A, A) \otimes C_*(A, A)$$

and $H \in C_*(A, A) \otimes C_*(A, A)$ satisfies $dH = E - E_0$.

The following proposition then follows immediately from the definitions and Eq. (7).

Proposition 3.9. *Let A be a smooth A_∞ -category, $\alpha \in C_{(2)}^n(A)$ a closed element, and (E_0, H) a trivialization of E onto W . The map of graded \mathbb{k} -modules Δ_H descends to a map of complexes*

$$\Delta_H : C_*(A, A) \rightarrow \frac{C_*(A, A) \otimes C_*(A, A)}{(W \otimes C_*(A, A)) + (C_*(A, A) \otimes W)}[n-1].$$

We note that we do not require W to be concentrated in degree zero, since in some applications we may want to take quotients in other degrees as well. Nonetheless, since $[E]$ is a class of degree zero, one can always find trivializations onto some W_0 concentrated in degree zero. In that case, with some extra assumptions on A , we have the following.

Corollary 3.10. *If A is connective, $n \geq 2$, and (E_0, H) is a trivialization onto a subcomplex W concentrated in degree zero, then Δ_H automatically descends to a map of complexes*

$$\Delta_H : \frac{C_*(A, A)}{W} \rightarrow \frac{C_*(A, A) \otimes C_*(A, A)}{(W \otimes C_*(A, A)) + (C_*(A, A) \otimes W)}[n-1].$$

In other words, W satisfies part (1) of the ‘balanced’ condition we defined in Definition 1.4.

Proof. The subspace W is concentrated in degree zero, so if $n \geq 2$ the image $\Delta_H(W)$ is in negative degrees, so it vanishes (because it follows from the connectivity of A that $C_*(A, A)$ is concentrated in nonnegative degrees). \square

Again, the proposition above holds over any ring \mathbb{k} . When \mathbb{k} is a field, the Künneth map is an isomorphism and we get a coproduct of degree $1 - n$ on a quotient of Hochschild homology, that is, a map

$$\Delta_H : H_*(C_*(A, A)/W) \rightarrow H_*(C_*(A, A)/W) \otimes H_*(C_*(A, A)/W)[n-1].$$

3.3. Covariance of the space of trivializations with respect to choices. The map of complexes $\tilde{\Delta}_H$ in Definition 3.7 is well-defined on homology for a given equivalence class of the data (co, η, H) . In fact, let us be more precise and use subscripts to write

$$\tilde{\Delta}_{\text{co}, \eta, H}(\varphi) = G_{\text{co}, \eta}(\varphi) - (-1)^{\deg(\varphi)}((\varphi \frown \otimes \text{id} - \text{id} \otimes \varphi \frown)H).$$

If $H - H'$ is exact, then $\tilde{\Delta}_{\text{co}, \eta, H}$ and $\tilde{\Delta}_{\text{co}, \eta, H'}$ are chain homotopic maps of complexes and that space of choices of H modulo exact terms is a torsor over $H_1(C_*(A, A) \otimes C_*(A, A))$. We record this in the following proposition:

Proposition 3.11. *The map $\tilde{\Delta}_{\text{co}, \eta, H}$ at the homology level only depends on the class of H in the corresponding torsor over $H_1(C_*(A, A) \otimes C_*(A, A))$.*

Suppose now that we have two representatives for the coevaluation element, differing by an exact term, that is $\text{co}' = \text{co} + dz$ for some $z \in A \otimes_{A^e} A^!$. We then have

$$G_{\text{co}', \eta}(\varphi) \simeq G_{\text{co}, \eta}(\varphi) - (-1)^{\deg(\varphi)}((\varphi \frown \otimes \text{id} - \text{id} \otimes \varphi \frown)H_z)$$

where H_z is an element of degree 1 in $C_*(A, A) \otimes C_*(A, A)$, given by evaluating the same diagram as for the Chern character E (Definition 3.3) but with z in the place of co . This element satisfies $dH_z = E_{\text{co}', \eta} - E_{\text{co}, \eta}$.

In other words, changing co by an exact term shifts the space of partial trivializations. We can compensate by changing H accordingly to $H - H_z$; there is a homotopy $\Delta_{\text{co} + dz, \eta, H - H_z} \simeq \Delta_{\text{co}, \eta, H}$. An analogous description applies to changing the chain-level representative for η . We summarize these observations in the following

Proposition 3.12. *At the homology level, $\Delta_{\text{co}, \eta, H}$ only depends on the class of the data (co, η, H) under the equivalence relation generated by*

$$(\text{co}, \eta, H) \sim (\text{co} + dz, \eta + dw, H - H_{z, w})$$

where $H_{z, w}$ is an element of degree 1 in $C_*(A, A) \otimes C_*(A, A)$ satisfying $dH_{z, w} = E_{\text{co} + dz, \eta + dw} - E_{\text{co}, \eta}$.

3.4. Infinitesimal bialgebra relation. We will now study the relation between the algebraic loop coproduct we described above and the product which is part of the framed E_2 -algebra structure induced by the pre-CY structure.

Let us start by stating and proving a lemma about the operation $\tilde{\Delta}_H$. Recall the cup product operation \smile on Hochschild cochains, which is commutative on homology. We can pick an explicit homotopy realizing this commutativity: let $Q : C^*(A, A)^{\otimes 2} \rightarrow C^*(A, A)[-1]$ be the

operation given by evaluating the oriented diagram

giving the relation $[d, Q](\varphi, \psi) = \varphi \smile \psi - (-1)^{\deg(\varphi) \deg(\psi)} \psi \smile \varphi$.

Let us pick, as before, an element H such that $dH = E - E_0$.

Lemma 3.13. *For any $\varphi, \psi \in C^*(A, A)$, we have the relation*

$$\begin{aligned} \tilde{\Delta}_H(\varphi \smile \psi) &\simeq (-1)^{\deg(\varphi)}(\varphi \frown \otimes \text{id})\tilde{\Delta}_H(\psi) + (-1)^{\deg(\varphi) \deg(\psi) + \deg(\psi)}(\text{id} \otimes \psi \frown)\tilde{\Delta}_H(\varphi) \\ &\quad - (\text{id} \otimes Q(\varphi, \psi) \frown)E_0 \end{aligned}$$

Proof. Let us start with the terms involving the map G . We consider the two maps $C^*(A, A)^{\otimes 2} \rightarrow C_*(A, A)[-1]$ which take $(\varphi, \psi) \mapsto G(\varphi \smile \psi)$ and

$$(\varphi, \psi) \mapsto (-1)^{\deg(\varphi)}(\varphi \frown \otimes \text{id})G(\psi) + (-1)^{\deg(\varphi) \deg(\psi) + \deg(\psi)}(\text{id} \otimes \psi \frown)G(\varphi) - (\text{id} \otimes Q(\varphi, \psi) \frown)E$$

and find a homotopy between them, given in Appendix A.2.

As for the terms involving H , we have easier homotopies (which we omit) giving relations

$$\begin{aligned} ((\varphi \smile \psi) \frown \otimes \text{id})H &\simeq (\varphi \frown \otimes \text{id})(\psi \frown \otimes \text{id})H \\ (\text{id} \otimes (\varphi \smile \psi - (-1)^{\deg(\varphi) \deg(\psi)} \psi \smile \varphi) \frown)H &\simeq (-1)^{\deg(\varphi) + \deg(\psi)}(\text{id} \otimes Q(\varphi \smile \psi))(E - E_0) \end{aligned}$$

Combining the three relations above, and then adding and subtracting the term

$$(-1)^{\deg(\varphi) + \deg(\psi)}(\varphi \frown \otimes \text{id})(\text{id} \otimes \psi \frown)H$$

on the right-hand side gives us the desired relation. \square

Given a pre-CY structure on A , in Section 2.2.2 we described a map of complexes

$$\pi : C_*(A, A)[-n] \otimes C_*(A, A)[-n] \rightarrow C_*(A, A)[-n]$$

inducing an associative and $(-1)^n$ -commutative product on $HH_*(A, A)$. We establish a compatibility relation between π and Δ_H when $E_0 = 0$.

Theorem 3.14. *Suppose A is an A_∞ -category over a field \mathbb{k} equipped with a (2-truncated) pre-CY structure m of dimension n . Furthermore, suppose $[E] = 0$ and H is a trivialization of E . The algebraic loop product*

$$\pi : HH_*(A, A)[-n] \otimes HH_*(A, A)[-n] \rightarrow HH_*(A, A)[-n]$$

defined by m and the algebraic loop coproduct

$$\Delta_H : HH_*(A, A)[n-1] \rightarrow HH_*(A, A)[n-1] \otimes HH_*(A, A)[n-1]$$

satisfy the following relation, known as the infinitesimal bialgebra equation (also called Sullivan's relation in [CHO23]):

$$\Delta_H \circ \pi = (\pi \otimes \text{id}) \circ (\text{id} \otimes \Delta_H) + (\text{id} \otimes \pi) \circ (\Delta_H \otimes \text{id}).$$

Proof. The product π and the cap product \frown are related by means of the map g_α of Example 2.5; we can easily write down a homotopy giving the relation $\pi(x, y) \simeq g_\alpha(x) \frown y$. The desired result then follows by using this relation combined with the relation in Lemma 3.13, applied to $\varphi = g_\alpha(x), \psi = g_\alpha(y)$. \square

4. CATEGORICAL FORMAL PUNCTURED NEIGHBORHOOD OF INFINITY

In this section we recall the notion of the *categorical formal punctured neighborhood of infinity* \widehat{A}_∞ of an A_∞ -category A . This notion was first defined by Efimov for dg categories in [Efi17], as a noncommutative analog of the category of perfect complexes on the formal neighborhood of the divisor at infinity in a compactification of a noncompact smooth variety X . We also establish a relationship between \widehat{A}_∞ and the Chern character E_A of A defined in Definition 3.3.

4.1. Definition. The object \widehat{A}_∞ has recently appeared ‘on the other side of mirror symmetry’ in [GGV22] where it is proven to give an algebraic model for the ‘Rabinowitz Fukaya category’ of a noncompact symplectic manifold. We will refer the reader to Section 2 of that paper [GGV22] for the precise definition of \widehat{A}_∞ . For the purposes of this article we follow Proposition 2.11 of [GGV22] and define \widehat{A}_∞ as follows. [‡]

Definition 4.1. Let A be a smooth A_∞ -category. The bimodule \widehat{A}_∞ is the cone of the canonical map

$$\Psi : C^*(A, A^\vee \otimes A) \rightarrow C^*(A, \text{Hom}_{\mathbb{k}}(A, A)),$$

Here A^\vee is the bimodule given by the linear dual of A . We *do not* assume that A is finite-dimensional or proper; note that, without this assumption, A^\vee will be ‘bigger’ than A , in the sense that its own linear dual $A^{\vee\vee}$ will not be equivalent to A . In particular, the natural map $A^\vee \otimes A \rightarrow \text{Hom}_{\mathbb{k}}(A, A)$ is not a (quasi-)isomorphism and thus neither is Ψ in general.

Even though A is not proper, there is a canonical evaluation map $\text{ev} : A \otimes A^\vee \rightarrow \mathbb{k}$. The map ev gives a map of complexes

$$A \otimes_{A^e} A^\vee \rightarrow \mathbb{k},$$

which we represent in the graphical calculus as a vertex taking one arrow carrying the A bimodule and one arrow carrying the A^\vee bimodule.

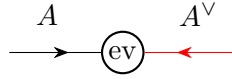

The A^\vee arrows will always be colored red from now on, to distinguish them more easily.

4.1.1. Graphical calculus definition. Let us describe the map of bimodules Ψ in our graphical calculus. The A -bimodule structure on the complex $C^*(A, A^\vee \otimes A)$ comes from the structure of an tetramodule on $A^\vee \otimes A$; the two actions of A on $C^*(A, A^\vee \otimes A)$ come from acting inside, on either side of \otimes . Again, to avoid discussing tetramodules, we just visualize an element in $C^*(A, A^\vee \otimes A)$ as a vertex of the following form.

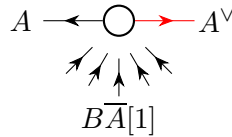

The map Ψ in Definition 4.1 is then given by the diagram

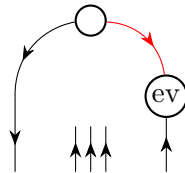

Here, the three little arrows at the bottom just schematically indicate the direction of the $\overline{A}[1]$ -arrows at the bottom (the inputs of a Hochschild cochain in $C^*(A, \text{Hom}_{\mathbb{k}}(A, A))$).

[‡]There is a slight difference between our definitions, related to taking A^{op} instead of A ; we will use the definition as stated since we want for there to be a natural map of bimodules $A \rightarrow \widehat{A}_\infty$.

4.1.2. *Cup product.* The differential and composition that endow \widehat{A}_∞ with the structure of a dg category are maps of A -bimodules.

$$\mu_\infty^1 : \widehat{A}_\infty \rightarrow \widehat{A}_\infty[1] \quad \text{and} \quad \mu_\infty^2 : \widehat{A}_\infty \otimes_A^{\mathbb{L}} \widehat{A}_\infty \rightarrow \widehat{A}_\infty$$

We note that these structure maps give a cup product on Hochschild cochains valued in this bimodule:

Definition 4.2. The cup product $\smile_\infty : C^*(A, \widehat{A}_\infty) \otimes C^*(A, \widehat{A}_\infty) \rightarrow C^*(A, \widehat{A}_\infty)$ is defined by the oriented ribbon quiver

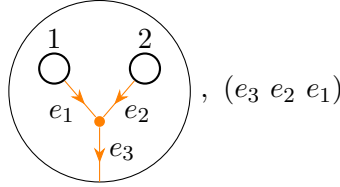

where the orange lines carry \widehat{A}_∞ and the orange dot in the middle represents μ_∞^2 .

Remark 4.3. The only difference between the conventions we use here and the definition in [GGV22] is that what we call \widehat{A}_∞ in their notation would technically be called $\widehat{(A^{op})}_\infty$, meaning the A^{op} -bimodule corresponding to the opposite A_∞ -category, but seen as an A -bimodule by reversing the two actions. This difference is mainly due to the fact that *op.cit.* (and also [Gan13], for example) uses a convention for A_∞ maps that is opposite to the one we use following [KTV22]. We choose this convention since we will be using the pre-CY formalism which was written using it, and also be consistent with Efimov's original definition [Efi17].

4.2. **Relation to Chern character of diagonal bimodule.** The definition for the bimodule \widehat{A}_∞ above makes sense for any A_∞ -category, smooth or not. But from now on, we will assume A is smooth. We show that using the vertices co, η we defined before, it is possible to give an explicit relation between the categorical formal punctured neighborhood of infinity and the Chern character we defined in Section 3.1.

4.2.1. *Another description of \widehat{A}_∞ .* Let A be a smooth A_∞ -category. We will define another bimodule \widehat{A}'_∞ associated to A that will be quasi-isomorphic to \widehat{A}_∞ . We pick vertices co and η as in Section 3.1, and also let us pick a bimodule morphism $\beta : A \rightarrow A$ of degree 1 which witnesses the relation between co and η , that is,

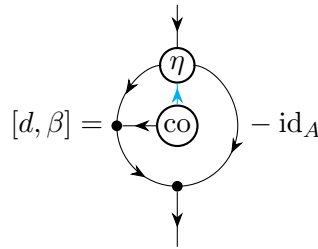

We define the bimodule \widehat{A}'_∞ to be the cone of the morphism

$$\Psi' : C^*(A, A^\vee \otimes A) \otimes_A^{\mathbb{L}} A \rightarrow A$$

given by the following diagram, with some appropriate orientation:

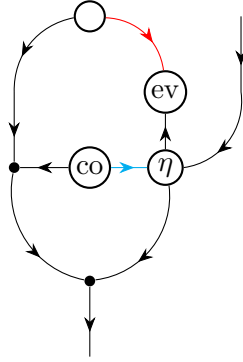

Proposition 4.4. *Let A be a smooth A_∞ -category. Then the bimodule \widehat{A}'_∞ is quasi-isomorphic to \widehat{A}_∞ .*

Proof. The natural quasi-isomorphism of bimodules $\varphi : A \rightarrow C^*(A, \text{Hom}_{\mathbb{k}}(A, A))$ can be given explicitly by the diagram

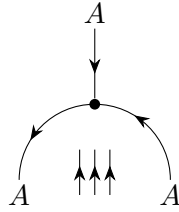

Again, the three small arrows on the bottom just indicate schematically where the inputs are in the Hochschild cochain structure. In order to see that \widehat{A}'_∞ is quasi-isomorphic to \widehat{A}_∞ , it suffices to exhibit a homotopy between the maps $\varphi \circ \Psi'$ and $\Psi \circ R$, where R is the canonical quasi-isomorphism given by $\otimes_A^{\mathbb{L}} A$. In diagrams, we need to find a homotopy

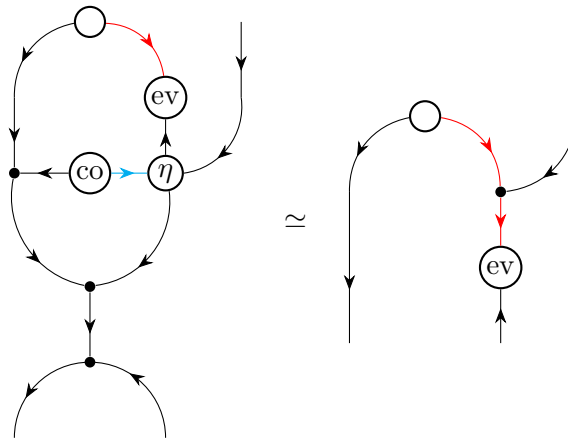

for some appropriate orientation; we do this by using the element β in Appendix A.3.1. \square

4.2.2. *Triangle of Hochschild chain complexes.* Consider the distinguished triangle of complexes

$$C_*(A, C^*(A, A^\vee \otimes A)) \xrightarrow{F} C_*(A, A) \rightarrow C_*(A, \widehat{A}_\infty)$$

obtained from applying Hochschild chains to the distinguished triangle of bimodules defining \widehat{A}_∞ . Since A is smooth, we have quasi-isomorphisms of complexes

$$C^*(A, A^\vee \otimes A) \simeq A^! \otimes_{A^e}^{\mathbb{L}} (A^\vee \otimes A) \simeq A^! \otimes_A^{\mathbb{L}} A^\vee$$

and also $C_*(A, A^! \otimes_A^{\mathbb{L}} A^\vee) = A^! \otimes_{A^e}^{\mathbb{L}} A^\vee \simeq C^*(A, A^\vee)$. Picking any inverse for these quasi-isomorphisms, we call the resulting map

$$F : C^*(A, A^\vee) \rightarrow C_*(A, A);$$

then we must have a quasi-isomorphism $C^*(A, \widehat{A}_\infty) \simeq \text{Cone}(F)$. Note also that for any A , smooth or not, we have an isomorphism of complexes $C^*(A, A^\vee) \cong (C_*(A, A))^\vee$ induced by the canonical pairing

$$\langle -, - \rangle : C^*(A, A^\vee) \otimes C_*(A, A) \rightarrow \mathbb{k}.$$

4.2.3. *Comparison.* The following result is stated by Efimov in [Efi17, Subsection 10.2], and also mentioned as a ‘folklore’ lemma in [GGV22, Lemma 6.5].

Theorem 4.5. *Let A be smooth. The map $\sharp E : C^*(A, A^\vee) \rightarrow C_*(A, A)$ defined by pairing with the first component of E , that is,*

$$\sharp E(\varphi) = \langle \varphi, E' \rangle E''$$

(where we use Sweedler’s notation $E = E' \otimes E''$) is homotopic to F . In other words, there is a quasi-isomorphism $C_*(A, \widehat{A}_\infty) \simeq \text{Cone}(\sharp E)$.

Proof. Let us now apply $C_*(A, -)$ to the distinguished triangle given by Ψ' , to get a distinguished triangle of complexes

$$C_*(A, C^*(A, A^\vee \otimes A)) \otimes_A^{\mathbb{L}} A = C^*(A, A^\vee \otimes_A^{\mathbb{L}} A \otimes_A^{\mathbb{L}} A) \xrightarrow{F'} C_*(A, A) \rightarrow C_*(A, \widehat{A}'_\infty)$$

whose map F' is given by the diagram

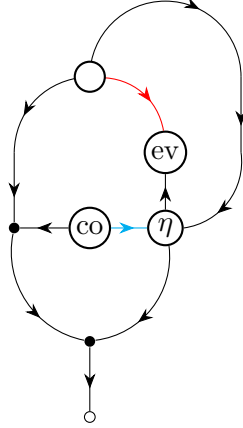

Now we look at the map given by mapping $C^*(A, A^\vee \otimes_A^{\mathbb{L}} A \otimes_A^{\mathbb{L}} A) \xrightarrow{\cong} C^*(A, A^\vee)$ and then pairing with the first term in E .

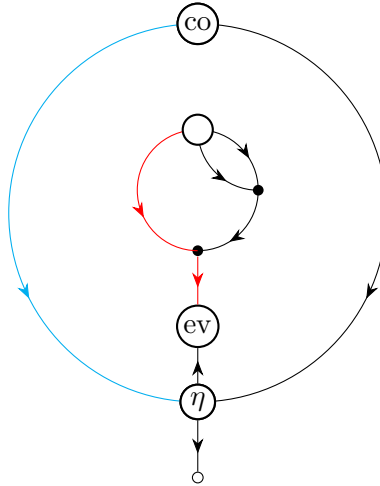

To prove the statement we must give a homotopy between the two diagrams above; we do that in Appendix A.3.2. \square

5. PRE-CY STRUCTURES AND PRODUCT ON THEIR CONE

We now address one of the main points of this paper, which is that the formalism of pre-CY structures developed in [KTV22] as we recalled in Section 2 can be used to explicitly describe a product on $C_*(A, \widehat{A}_\infty)$ when that structure is non-degenerate. The graphical calculus can then be used to show the desired properties of this product.

More generally, we will see that any (3-truncated) pre-CY structure $m = \mu + \alpha + \tau$, even if α is degenerate, already gives a product with those properties, but on $C_*(A, M_\alpha)$ for another bimodule M_α . As suggested by the notation, this bimodule depends on α ; however, we will show that when α is non-degenerate it is quasi-isomorphic to \widehat{A}_∞ .

5.1. The cone bimodule of a pre-CY category. Let $(A, m = \mu + \alpha + \tau + \sigma)$ be a 3-truncated pre-CY category. That is, we have $\alpha \in C_{(2)}^*(A)$, $\tau \in C_{(3)}^*(A)$ and $\sigma \in C_{(4)}^*(A)$ such that

$$[\mu, \alpha] = 0, \quad \alpha \circ \alpha + [\mu, \tau] = 0.$$

5.1.1. *Definition.* We use the data of α to give an A_∞ -morphism of bimodules

$$(8) \quad f_\alpha : A^\vee[-n] \rightarrow A, \quad f_\alpha = \begin{array}{c} \text{---} \circlearrowleft \text{---} \\ \text{---} \circlearrowright \text{---} \end{array} \text{---}$$

Note that the diagram above encapsulates the data of many maps of complexes, since α can take any number of $A[1]$ -arrows on each side.

Remark 5.1. We would like to point out a possible source of confusion, which is that the nondegeneracy of α , in the sense that the map $A^1 \rightarrow A$ it induces is a quasi-isomorphism, does not imply that $f_\alpha : A^\vee \rightarrow A$ will be a quasi-isomorphism. In fact, as we will see in Section 7, α can be non-degenerate at the same time that f_α is nullhomotopic.

Definition 5.2. The bimodule M_α is the cone of the map f_α above, that is, it is given by the bimodule

$$M_\alpha = (B\bar{A} \otimes A^\vee \otimes B\bar{A})[1-n] \oplus A$$

with the differential given by the usual differentials on the two summands plus f_α .

5.1.2. *Extension of pre-CY structure.* We now describe how the data of the pre-CY structure on A canonically extends to certain operations on M_α . Let $(A, m = \mu + \alpha + \tau + \sigma)$ be a 4-truncated pre-CY structure, and let us denote $M = M_\alpha$ for the cone bimodule.

Proposition 5.3. *Let $(A, m = \mu + \alpha + \tau + \sigma)$ be a 3-truncated pre-CY of dimension n . Then there are canonically defined vertices*

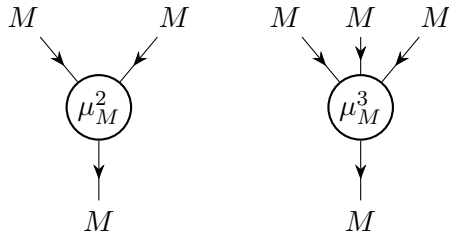

of degrees zero and one, where μ_M^2 is closed, extends the product μ^2 on A , and μ_M^3 satisfies the equation

$$[d, \mu_M^3] = \mu_M^2(\mu_M^2(-, -), -) - \mu_M^2(-, \mu_M^2(-, -))$$

that is, μ_M^2 is associative up to the boundary of μ_M^3 , and also a vertex

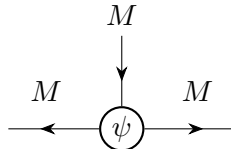

satisfying the equation

$$d\psi = \begin{array}{c} \downarrow \\ \leftarrow \textcircled{\alpha} \rightarrow \textcircled{\mu_M^2} \rightarrow \end{array} - \begin{array}{c} \downarrow \\ \leftarrow \textcircled{\mu_M^2} \leftarrow \textcircled{\alpha} \rightarrow \end{array}$$

If one does not want to phrase this in the graphical language of vertices: μ_M^2 is a map of A_∞ -bimodules

$$\mu_M^2 : M \otimes_A^{\mathbb{L}} M \rightarrow M$$

while μ_M^3 is a ‘nonclosed A_∞ -morphism’ (a pre-morphism of bimodules in the language of [KTV22])

$$\mu_M^3 : M \otimes_A^{\mathbb{L}} M \otimes_A^{\mathbb{L}} M \rightsquigarrow M[-1]$$

Likewise, ψ is a ‘nonclosed’ A_∞ -morphism’

$$\psi : M \rightsquigarrow C^*(A, M \otimes M)$$

Proof. To unclutter notation, let us denote $Z = A^\vee[1-n]$, $f = f_\alpha$, and $\tau = m_{(3)}$ (the part of the pre-CY structure on A with 3 outputs). Since $M = (\overline{BA} \otimes Z \otimes \overline{BA})[1] \oplus A$, we have to describe 8 types of vertices, with inputs either in A or in $(\overline{BA} \otimes Z \otimes \overline{BA})[1]$, which we abbreviate by subscripts A, Z , respectively. We set:

- $\mu_{AA}^2 = \mu^2$ (usual multiplication on A)
- $\mu_{AA,Z}^2 = 0$
- $\mu_{AZ,Z}^2$ and $\mu_{ZA,Z}^2$ are the A -actions on the bimodule Z .

- $\mu_{AZ,A}^2 = \begin{array}{c} \downarrow \\ \textcircled{\alpha} \end{array} \begin{array}{c} \textcircled{\text{ev}} \\ \downarrow \end{array}$, $\mu_{ZA}^2 = \begin{array}{c} \textcircled{\text{ev}} \\ \downarrow \\ \textcircled{\alpha} \end{array}$

- $\mu_{ZZ,Z}^2 = \begin{array}{c} \textcircled{\text{ev}} \quad \textcircled{\text{ev}} \\ \downarrow \\ \textcircled{\alpha} \end{array}$, by which we mean that the output is an element of Z which evaluates on an element of A by plugging it into the bottom arrow.

- $\mu_{ZZ,A}^2 = \begin{array}{c} \textcircled{\text{ev}} \quad \textcircled{\text{ev}} \\ \downarrow \\ \textcircled{\tau} \end{array}$

One can check that summing all the terms above gives an operation

$$\mu_M^2 : \overline{BA}[1] \otimes M \otimes \overline{BA}[1] \otimes M \otimes \overline{BA}[1] \rightarrow M$$

which is closed, that is, a map of complexes giving a morphism in the category of bimodules of degree zero.

In other words, the terms in μ_M^2 are systematically obtained from diagrams with the vertices $\alpha = m_{(2)}$, $\tau = m_{(3)}$, by dualizing the appropriate arrows. The formulas for μ_M^3 are analogous, and involve α, τ and σ . It remains to construct the element ψ , with one M input and two M outputs. Again, there are 8 terms to be specified.

- $\psi_{AA} = \begin{array}{c} \downarrow \\ \textcircled{\alpha} \end{array}$

- $\psi_{AZ}, \psi_{A,ZA}, \psi_{A,ZZ}, \psi_{Z,AZ}$ and $\psi_{Z,ZA}$ are all zero.

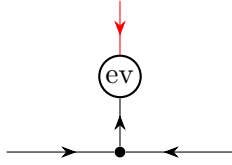
• $\psi_{Z,AA} =$  , interpreting, as we did for $\mu_{ZZ,Z}^2$ above, the bottom A

inputs as $Z \otimes Z$ outputs.

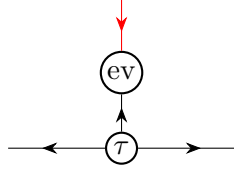
• $\psi_{Z,AA} =$ 

It follows from the equations $[\mu, \alpha] = 0$, $[\mu, \tau] = \alpha \circ \alpha$, and from the previous definition of μ_{M}^2 , that these formulas give the desired equation for $d\psi$. \square

5.2. Extending products on chains and cochains. We continue to assume that $(A, m = \mu + \alpha + \tau + \sigma)$ is a 4-truncated pre-CY category of dimension n . We will now use the vertices defined in Proposition 5.3 in order to construct a product structure on $C_*(A, M_\alpha)$, and prove some of its properties. Here, M_α is given in Definition 5.2. From now on, we make the convention that orange arrows carry the bimodule M , and all orange dot vertices represent the structure maps μ_M .

Definition 5.4. Define a product $\pi_{M_\alpha} : C_*(A, M_\alpha) \otimes C_*(A, M_\alpha) \rightarrow C_*(A, M_\alpha)[n]$ by

$$\pi_{M_\alpha}(x_1, x_2) = \Pi(\alpha, x_1, x_2),$$

where Π is the map $C_{(2)}^*(A) \otimes C_*(A, M_\alpha) \otimes C_*(A, M_\alpha) \rightarrow C_*(A, M_\alpha)$ given by the oriented ribbon quiver

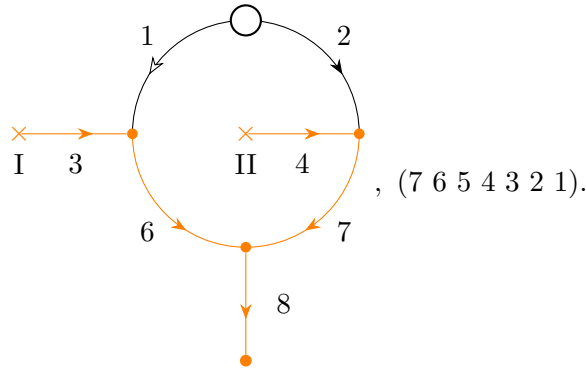

Proposition 5.5. *The chain-level product π_{M_α} is a map of complexes inducing an associative product on Hochschild homology $HH_*(A, M_\alpha)$. Furthermore, π_{M_α} extends the chain-level product π on $C_*(A, A)$ described in Eq. (3).*

Proof. The fact that π_{M_α} is a map of complexes follows from α and $\mu_{M_\alpha}^2$ being closed. To show that the induced map on Hochschild homology is associative we use the definition

$$\pi_{M_\alpha}(\pi_{M_\alpha}(x_1, x_2), x_3) = \Pi(\alpha, \Pi(\alpha, x_1, x_2), x_3), \quad \pi_{M_\alpha}(x_1, \pi_{M_\alpha}(x_2, x_3)) = \Pi(\alpha, x_1, \Pi(\alpha, x_2, x_3))$$

and draw the diagrams giving the chain-level expressions for these two maps $C_{(2)}^*(A)^{\otimes 2} \otimes (C_*(A, M_\alpha))^{\otimes 3} \rightarrow C_*(A, M_\alpha)$. We then find a homotopy between them, which we present in Appendix A.4.1.

The product π_{M_α} extends the product on $C_*(A, A)$ because $\mu_{AA,Z}^2 = 0$ and the two lines coming out of α are in the image of $A \hookrightarrow M_\alpha$. \square

5.2.1. *The cup product.* We note that the vertex $\mu_{M_\alpha}^2$ also gives a product on Hochschild cohomology $C^*(A, M_\alpha)$, analogous to the usual cup product on $C^*(A, A)$.

Definition 5.6. The chain-level cup product $\smile_{M_\alpha} : C^*(A, M_\alpha) \otimes C^*(A, M_\alpha) \rightarrow C^*(A, M_\alpha)$ is defined by the following diagram

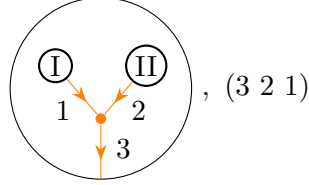

This is a map of complexes and we denote the induced map on cohomology equally by \smile_{M_α} .

It follows from the definition of $\mu_{M_\alpha}^2$ that the cup product above extends the cup product of ordinary Hochschild cochains $\smile : C_*(A, A) \otimes C_*(A, A) \rightarrow C_*(A, A)$.

Proposition 5.7. *The cohomology cup product $\smile_{M_\alpha} : HH^*(A, M_\alpha) \otimes HH^*(A, M_\alpha) \rightarrow HH^*(A, M_\alpha)$ is associative.*

Proof. The homotopy between the corresponding diagrams follows from the existence of $\mu_{M_\alpha}^3$ and the equation it satisfies together with $\mu_{M_\alpha}^2$. \square

In general, this cup product is not commutative, but it does satisfy the following compatibility with the product π_{M_α} in Definition 5.4 expressed in terms of the map of complexes

$$g_\alpha^{M_\alpha} : C_*(A, M_\alpha) \rightarrow C^*(A, M_\alpha)[n]$$

constructed in Example 2.5. For simplicity, we write $g_\alpha^{M_\alpha}$ as g_α below.

Proposition 5.8. *There is a chain homotopy*

$$g_\alpha(\pi_{M_\alpha}(-, -)) \simeq g_\alpha(-) \smile_{M_\alpha} g_\alpha(-)$$

of maps of complexes $C_*(A, M_\alpha) \otimes C_*(A, M_\alpha) \rightarrow C^*(A, M_\alpha)[-2n]$. The induced map

$$HH_*(A, M_\alpha) \otimes HH_*(A, M_\alpha) \rightarrow HH^*(A, M_\alpha)[2n]$$

is $(-1)^n$ -commutative.

Proof. To prove the first assertion, we must write both sides as maps

$$C_{(2)}^*(A) \otimes C_{(2)}^*(A) \otimes C_*(A, M_\alpha) \otimes C_*(A, M_\alpha) \rightarrow C^*(A, M_\alpha)$$

given by ribbon quivers (where we input $\alpha \otimes \alpha$ into the first two factors) and find a homotopy between them. For the $(-1)^n$ -commutativity, similarly we write the two ribbon quivers and find a homotopy that swaps the two inputs; comparing orientations at the end, we get the correct $(-1)^n$ sign. We present both of these homotopies in Appendix A.4.2. \square

Recall from Remark 2.12 that if $\alpha = m_{(2)}$ is non-degenerate, for any bimodule N the map

$$g_\alpha^N : C_*(A, N) \rightarrow C^*(A, N)[n]$$

is a quasi-isomorphism. Together with the previous proposition, this implies the following.

Corollary 5.9. *If α is non-degenerate, both the homology product π_{M_α} and the cohomology cup product \smile_{M_α} are $(-1)^n$ -commutative.*

5.2.2. *Relation to the categorical formal punctured neighborhood of infinity.* For a general pre-CY structure m on smooth A , there is no relation between \widehat{A}_∞ and the bimodule M_α in Definition 5.2. We will now show that these bimodules are quasi-isomorphic when α is non-degenerate.

Consider the map of A -bimodules given by the composition

$$A \otimes_A^{\mathbb{L}} A^\vee \xrightarrow{\sim} C_*(A, A^\vee \otimes A) \xrightarrow{g_\alpha^{A^\vee \otimes A}} C^*(A, A^\vee \otimes A)[n]$$

We also have another map of A -bimodules

$$A \otimes_A^{\mathbb{L}} A^\vee[-n] \xrightarrow{\sim} A^\vee[-n] \xrightarrow{f_\alpha} A$$

Together with the map defining \widehat{A}_∞ and the canonical map $A \rightarrow C^*(A, \text{Hom}_{\mathbb{k}}(A, A))$ (which is always a quasi-isomorphism), these maps form a square

$$\begin{array}{ccc} A \otimes_A^{\mathbb{L}} A^\vee[-n] & \longrightarrow & A \\ \downarrow & & \downarrow \\ C^*(A, A^\vee \otimes A) & \longrightarrow & C^*(A, \text{Hom}_{\mathbb{k}}(A, A)) \end{array}$$

Proposition 5.10. *There is a homotopy making the square above commute, and defining a map of bimodules $M_\alpha \rightarrow \widehat{A}_\infty$. When α is non-degenerate, this map is a quasi-isomorphism of bimodules.*

Proof. Again, for the first claim we write the ribbon quivers giving the two maps and a homotopy between them, in Appendix A.5. The second claim follows from the fact (see Remark 2.12) that if α is non-degenerate then $g_\alpha^{A^\vee \otimes A}$ is a quasi-isomorphism (and thus the vertical maps are both quasi-isomorphisms). \square

A quasi-isomorphism $M_\alpha \simeq \widehat{A}_\infty$ of bimodules induces a quasi-isomorphism $C_*(A, M_\alpha) \simeq C_*(A, \widehat{A}_\infty)$. Combining this with the previous results of this section we have:

Theorem 5.11. *Given a 4-truncated non-degenerate n -pre-CY category (A, m) , there is a product π_∞ on $HH_*(A, \widehat{A}_\infty)$ of degree n and a cup product \smile_∞ on $HH^*(A, \widehat{A}_\infty)$, both associative and $(-1)^n$ -commutative, related by $g_\alpha^{\widehat{A}_\infty}(\pi_\infty(-, -)) = g_\alpha^{\widehat{A}_\infty}(-) \smile_\infty g_\alpha^{\widehat{A}_\infty}(-)$.*

Remark 5.12. One could obtain a chain-level description of these operations by using the explicit quasi-isomorphism $M_\alpha \simeq \widehat{A}_\infty$ and picking an inverse, but the resulting calculations would be rather complicated. We take the point of view that it is simpler to just use M_α instead.

5.3. **Lift of the product.** Let us return to the chain-level product π_{M_α} on the complex $C_*(A, M_\alpha)$, which we defined in Definition 5.4 purely from the (truncated) pre-CY structure of A . By definition, this complex is a cone of maps of Hochschild chain complexes

$$C_*(A, M_\alpha) = C_*(A, A^\vee)[1-n] \oplus C_*(A, A)$$

with differential combining the Hochschild differentials with the map F_α induced by the map of bimodules f_α in (8). Namely $F_\alpha = C_*(A, f_\alpha)$.

The product π_{M_α} restricts to a product π on the subcomplex $C_*(A, A)$ by construction. However, it does not induce a chain operation on the complex $C_*(A, A^\vee)[1-n]$. Note that, when α is non-degenerate, $C_*(A, A^\vee)[1-n]$ is quasi-isomorphic to $C^*(A, A^\vee)[1]$, so a product on it is the type of operation that could be dual to a coproduct of degree $1-n$ on $C_*(A, A)$. (Recall from Section 3.2 the coproduct Δ_H on $C_*(A, A)$.)

The problem of lifting the product π_{M_α} to $C_*(A, A^\vee)[1-n]$, or to some subcomplex of it determined by a subspace $W \subseteq C_*(A, A)$, on the other hand, has nothing to do with the nondegeneracy of α . We argue that a pair of nullhomotopies of the map of complexes F_α gives such a lift. In the case where the class of $[F_\alpha]$ is not trivial, we can still get a partial lift from a ‘partial nullhomotopy’.

5.3.1. *The case $[F_\alpha] = 0$.* A sufficient condition for the existence of such a lift is the vanishing of the map on homology $(HH_*(A, A))^\vee \rightarrow HH_*(A, A)$. Though this may seem to be a condition that is dependent of α , it is actually not, as long as α is non-degenerate: by the comparison between f_α and $\sharp E$, this corresponds exactly to the case when

$$0 = [E] \in HH_0(A, A) \otimes HH_1(A, A) \oplus HH_1(A, A) \otimes HH_0(A, A)$$

which is a condition that only depends on A as a smooth A_∞ -algebra.

Once that condition is satisfied, the extra structure needed to write down such a lift is as one would expect, a homotopy of the map f_α . More generally, let us pick two such homotopies h_1, h_2 , that is, maps $h_i : C_*(A, A^\vee)[-n] \rightarrow C_*(A, A)[-1]$ satisfying $dh_i + h_i d = F_\alpha$. Denoting p for the connecting map $C_*(A, M_\alpha) \rightarrow C_*(A, A^\vee)[1-n]$, we have the following.

Proposition 5.13. *The map*

$$\pi_{h_1, h_2} : C_*(A, A^\vee)[1-n] \otimes C_*(A, A^\vee)[1-n] \rightarrow C_*(A, A^\vee)[1-n]$$

given by

$$\pi_{h_1, h_2}(x_1, x_2) = p\pi_{M_\alpha}((\text{id} - h_1)x_1, (\text{id} - h_2)x_2)$$

is a map of complexes, and thus descends to a product on $HH_*(A, A^\vee)[1-n]$, which only depends on the h_i up to $[d, -]$ -exact terms. If the homotopies h_1 and h_2 are themselves homotopic, that is, if there exists h' such that $dh' - h'd = h_1 - h_2$, then this product is $(-1)^n$ -commutative at the homology level.

Proof. The statement that π_{h_1, h_2} is a map of complexes follows straightforwardly from the fact that $p, \pi_{M_\alpha}, (\text{id} - h_i)$ are maps of complexes. Here, we stress that $(\text{id} - h_i)$ is viewed as a map, by abuse of notation, from $C_*(A, A^\vee)[1-n]$ to the cone $C_*(A, M_\alpha) = C_*(A, A^\vee)[1-n] \oplus C_*(A, A)$. It is indeed a map of complexes since $dh_i + h_i d = F_\alpha$.

Since π_{M_α} itself is $(-1)^n$ -commutative, we may construct the homotopy term for the $(-1)^n$ -commutativity of π_{h_1, h_2} given by $p\pi_{M_\alpha}((\text{id} - h_1)x_1, h'x_2) - p\pi_{M_\alpha}(h'x_1, (\text{id} - h_1)x_2)$. \square

In general, this lifted product has no reason to be associative on homology, even though we know that the product π_{M_α} on $HH_*(A, M_\alpha)$ is. However, for many cases of interest, associativity turns out to hold automatically, as long as we pick h_1 and h_2 that are differ by an exact term.

Proposition 5.14. *If $HH_*(A, A^\vee)[-n]$ is supported in degrees ≤ 0 , $HH_*(A, A)$ is supported in degrees ≥ 0 , and $n \geq 3$, then for any choice of homotopy h_1, h_2 such that $h_1 - h_2$ is $[d, -]$ -exact, the product π_{h_1, h_2} on $HH_*(A, A^\vee)[1-n]$ is associative.*

Proof. Let us denote by r the map

$$C_*(A, M_\alpha) = C_*(A, A^\vee)[1-n] \oplus C_*(A, A) \rightarrow C_*(A, A)$$

of graded vector spaces given by projection on the second summand. This is not a map of complexes in general, but choosing any homotopy h as above (such as h_1, h_2) there is a map of complexes

$$r + hp : C_*(A, M_\alpha) \rightarrow C_*(A, A)$$

which we can also compose with the inclusion of the $C_*(A, A)$ summand to get an endomorphism of $C_*(A, M_\alpha)$. By the assumption that h_1 and h_2 differ by a exact term, $(r + h_1p)$ and $(r + h_2p)$ are homotopic maps of complexes.

We then have the identity of endomorphisms of the cone

$$(\text{id} - h)p + (r + hp) = p + r = \text{id}$$

We now take any three closed elements x_1, x_2, x_3 of $C_*(A, A^\vee)[1-n]$, of homogeneous degrees, and use this identity to write

$$\begin{aligned} \pi_{h_1, h_2}(\pi_{h_1, h_2}(x_1, x_2), x_3) &= p\pi((\text{id} - h_1)p\pi((\text{id} - h_1)x_1, (\text{id} - h_2)x_2), (\text{id} - h_2)x_3) \\ &= p\pi(\pi((\text{id} - h_1)x_1, (\text{id} - h_2)x_2), (\text{id} - h_2)x_3) - p\pi((r + h_1p)\pi((\text{id} - h_1)x_1, (\text{id} - h_2)x_2), (\text{id} - h_2)x_3) \end{aligned}$$

But the element $(r+h_1p)\pi((\text{id}+h_1)x_1, (\text{id}+h_2)x_2)$ is always exact: if either $\deg(x_1)$ or $\deg(x_2)$ are ≤ 1 , then by the assumption on $HH_*(A, A^\vee)[n]$, either x_1 or x_2 are exact and so is $(r+h_1p)\pi((\text{id}+h_1)x_1, (\text{id}+h_2)x_2)$, since this is the image of $x_1 \otimes x_2$ under a map of complexes.

Otherwise, this element has degree

$$\deg(x_1) + \deg(x_2) \leq 2 - n$$

which is strictly negative if $n \geq 3$. Therefore by assumption on $HH_*(A, A)$ this element is exact, and so is $\pi((r+h_1p)\pi((\text{id}-h_1)x_1, (\text{id}-h_2)x_2), (1-h_2)x_3)$; the last term of the equation above (which can be seen as the one of the two terms in the associativity defect between π and π_h) is then zero in homology. The result then follows from the fact that π is associative on homology, together with the assumption that h_1, h_2 differ by an exact term. \square

We note that the vanishing conditions of Proposition 5.14 on $HH_*(A, A)$ and $HH_*(A, A^\vee)[-n]$ hold if A is connective, $n \geq 3$, and α is non-degenerate, since in this case $HH_*(A, A^\vee)[-n] \cong HH^*(A, A^\vee)$.

5.3.2. The case $[F_\alpha] \neq 0$. In this case, we cannot expect to be able to lift the product π_{M_α} on $C_*(A, M_\alpha)$ to $C_*(A, A^\vee)$ in a way that respects the differential and induces a product on the homology $HH_*(A, A^\vee)[1-n]$. However, under some extra assumptions, we can partially lift π_{M_α} to a product on a subspace.

Let us phrase this lifting problem more generally. Suppose that we have complexes of free \mathbb{k} -modules X, Y , where X has homology concentrated in non-positive degrees and Y has homology concentrated in non-negative degrees. Assume that we are given a map of complexes $X \xrightarrow{f} Y$ and a product $\pi : Z \otimes Z \rightarrow Z[n]$ on the cone Z of f and let us denote p the connecting map $Z \rightarrow X[1]$. Suppose we have a \mathbb{k} -submodule V of Y^0 such that the inclusion $i : V \rightarrow Y$ is a map of complexes, where V is seen as a complex of \mathbb{k} -modules concentrated in degree zero. Suppose we are also given a map of complexes $q : X \rightarrow V$.

Definition 5.15. A *partial homotopy* of f with respect to (V, i, q) is a homotopy h between f and iq , that is, $h : X \rightarrow Y[-1]$ such that $dh + hd = f - iq$.

Let us motivate this definition: since the homology of X and Y only overlap in support at zero, the image of $[f]$ is concentrated in that degree; we can pick representatives spanning a subspace V . A partial homotopy is then a homotopy going from f to a map that lands in V . Picking a pair of partial homotopies allows us to lift the product:

Proposition 5.16. *Given partial homotopies h_1, h_2 of f , the formula*

$$\pi_{h_1, h_2}(x_1, x_2) = p\pi((\text{id}-h_1)x_1, (\text{id}-h_2)x_2)$$

defines a map of complexes

$$\pi_{h_1, h_2} : \ker(q) \otimes X \cap X \otimes \ker(q) \rightarrow X[n-1]$$

which moreover gives a product

$$\pi_{h_1, h_2} : H_*(\ker(q) \otimes X \cap X \otimes \ker(q)) \rightarrow H_*(\ker(q))[n-1]$$

Proof. The proof of the first statement is similar to the proofs of the analogous statements in the $[f_\alpha] = 0$ case, and from the conditions of Definition 5.15 imposed on h_i . For the second statement, since i is injective, we can pick a left-inverse $r : Y \rightarrow V$. Looking at the maps induced in homology, we then have

$$q \circ \pi_{h_1, h_2} = r \circ i \circ q \circ \pi_{h_1, h_2} = r \circ f \circ \pi_{h_1, h_2} = 0$$

where the second equality follows since $dh + hd = f - iq$, and the last equality holds because $f \circ p = 0$. \square

We note that we always have $\ker(q) \otimes \ker(q) \subseteq \ker(q) \otimes X \cap X \otimes \ker(q)$, with equality when $X/\ker(q)$ is a flat \mathbb{k} -module. Composing with this inclusion map we get a product of degree $1-n$ on $H_*(\ker(q))$,

$$\pi_{h_1, h_2} : H_*(\ker(q)) \otimes H_*(\ker(q)) \rightarrow H_*(\ker(q))[1-n],$$

which we will denote equally by π_{h_1, h_2} .

We have the following result, analogous to Propositions 5.13 and 5.14.

Proposition 5.17. *Keep the same assumptions as above. Let h_1, h_2 be two partial homotopies of f such that the difference $h_1 - h_2$ is $[d, -]$ -exact. Then the following hold.*

- (1) *If π on $H_*(Z)$ is $(-1)^n$ -commutative, so is the induced product π_{h_1, h_2} on $H_*(\ker(q))$.*
- (2) *If $n \geq 3$ and π is associative on $H_*(Z)$, so is π_{h_1, h_2} on $H_*(\ker(q))$.*

Proof. The proof is analogous to the proofs of Propositions 5.13 and 5.14. \square

Coming back to our specific setting of Hochschild chains, if A is connective and α is non-degenerate, then we can take $X = C_*(A, A^\vee)[-n]$, $Y = C_*(A, A)$ and $f = F_\alpha$. In that case, by Remark 2.12 there is an isomorphism

$$HH_*(A, A^\vee)[-n] \cong HH^*(A, A^\vee) \cong (HH_*(A, A))^\vee$$

so picking an appropriate (V, i, q) and partial homotopies h_1, h_2 , we get a product of degree $1 - n$ on $\ker((HH_*(A, A))^\vee \rightarrow V)$, which will be associative if $n \geq 3$ and h_1, h_2 differ by a $[d, -]$ -exact term.

6. RELATIONS BETWEEN PRODUCTS ON THE DUAL AND COPRODUCTS

For simplicity, let us first return to the case where A is connective, $[E] = 0$ and α is non-degenerate. Then, $[F_\alpha] = 0$ and picking h_1, h_2 determines a product π_{h_1, h_2} of degree $1 - n$ on $(HH_*(A, A))^\vee$. However, nothing guarantees that this product will be dual to a coproduct on $HH_*(A, A)$, since this graded vector space may not have finite-dimensional homology (even degree-wise). In fact, for generic choices of homotopies h_1, h_2 , the product on the dual is ‘infinite-rank’ and does not come from dualizing a coproduct (as in Section 7.4.5 for the homology of LS^1).

In this section we establish the relation between the product π_{h_1, h_2} on $(HH_*(A, A))^\vee$ (or on a subspace when $[E] \neq 0$), which we got by choosing homotopies of f_α , and the coproduct Δ_H constructed in Section 3.2 by choosing a trivialization H of E . In the process, we prove a symmetry statement for $[E]$ under the non-degeneracy assumption on α .

6.1. Symmetry of Chern character. Recall that in Definition 3.3 we defined a chain-level Chern character $E \in C_*(A, A) \otimes C_*(A, A)$ given a smooth A_∞ -category A . We can compose both sides of E with $g_\alpha : C_*(A, A) \rightarrow C^*(A, A)[n]$ to get an element of degree $-2n$

$$(\text{id} \otimes g_\alpha)(g_\alpha \otimes \text{id})E \in C^*(A, A) \otimes C^*(A, A).$$

We specify the order of application of the g_α maps due to the possibly nontrivial sign difference $(g_\alpha \otimes \text{id})(\text{id} \otimes g_\alpha) = g_\alpha \otimes g_\alpha = (-1)^n(\text{id} \otimes g_\alpha)(g_\alpha \otimes \text{id})$.

To make the visualization easier, we cut along an arc going from one boundary component of the elbow to the other, and draw the ribbon graphs in the square as follows, namely we identify the bottom edge with the top edge of the square. We insert $\alpha \otimes \alpha$ into the circles labeled I and II:

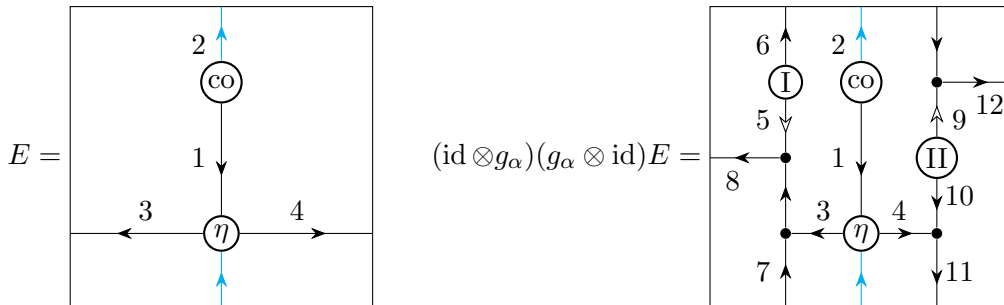

We can draw another diagram which, when also evaluated on $\alpha \otimes \alpha$, gives another closed element D_α of degree $-2n$ in $C^*(A, A) \otimes C^*(A, A)$:

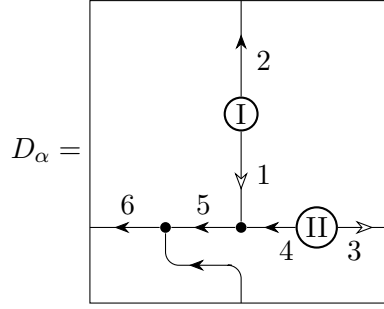

Note that pairing with the right-hand output of D_α gives a map

$$(D_\alpha)^\sharp : C_*(A, A^\vee) \rightarrow C^*(A, A)[2n]$$

which is equal at chain-level to $g_\alpha \circ F_\alpha$. Besides the chain-level expressions for co, η , recall from Section 4.2.1 that we fixed a (derived) bimodule morphism $\beta : A \rightarrow A$ of degree 1, witnessing the relation between co, η

Lemma 6.1. *The elements $(\text{id} \otimes g_\alpha)(g_\alpha \otimes \text{id})E$ and D_α are homologous, i.e. there is an explicit element $J_\alpha \in C^*(A, A) \otimes C^*(A, A)$, depending on the chain-level expressions for α, co, η and β , satisfying*

$$dJ_\alpha = (\text{id} \otimes g_\alpha)(g_\alpha \otimes \text{id})E - D_\alpha$$

Proof. We write in Appendix A.6.1 an explicit ribbon quiver giving the element J_α . □

Let us denote by $(-)^T$ the action of the generator of $\mathbb{Z}/2\mathbb{Z}$ permuting the two factors.

Lemma 6.2. *The elements D_α and D_α^T are homologous, i.e. there is an explicit element $L_\alpha \in C^*(A, A) \otimes C^*(A, A)$ satisfying $dL_\alpha = D_\alpha - D_\alpha^T$*

Proof. The element L_α given by evaluating the following combination of diagrams on $\alpha \otimes \alpha$ satisfies the desired property:

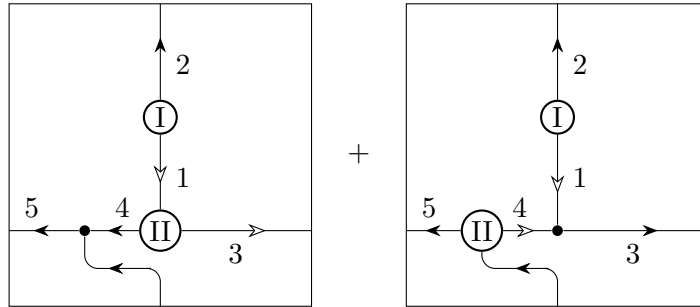

□

From the above lemmas, we conclude that the elements $(\text{id} \otimes g_\alpha)(g_\alpha \otimes \text{id})E$ and

$$(g_\alpha \otimes \text{id})(\text{id} \otimes g_\alpha)E^T = (-1)^n (\text{id} \otimes g_\alpha)(g_\alpha \otimes \text{id})E^T$$

are homologous. Therefore we can conclude a symmetry property of the class $[E]$, in the case that A admits a non-degenerate pre-CY structure.

Theorem 6.3. *If the smooth A_∞ -category A admits a nondegenerate pre-Calabi-Yau structure of dimension n , then its class $[E]$ is $(-1)^n$ -symmetric. Therefore, over a field \mathbb{k} of characteristic zero, if A admits a weak smooth Calabi-Yau structure of dimension n , that is, if there is a quasi-isomorphism of bimodules $A \simeq A^1[-n]$, then its class $[E]$ is $(-1)^n$ -symmetric.*

6.2. Compatibility relation. We will now study the compatibility between the coproducts Δ_H from Definition 3.7 and Proposition 3.9 and the dual products π_{h_1, h_2} from Propositions 5.13 and 5.16. This relation will allow us to complete the proof of Theorem 1.5. This is the most involved proof in this paper: it involves calculating some rather complicated homotopies, so we will break the proof into parts.

6.2.1. The square-filling lemma. Let us start with a lemma which holds for any smooth A with pre-CY structure, not necessarily nondegenerate. We keep this separate from the main proof since we believe it may be of future interest, e.g., when studying operations coming from a possibly degenerate pre-CY structure.

Recall that $G(\varphi)$ gives a homotopy between capping with φ onto the left factor of E and onto the right factor of E . Passing to Hochschild cochains using $(\text{id} \otimes g_\alpha)(g_\alpha \otimes \text{id})$, we have a similar description for the cup product. We define

$$\Gamma(\varphi) = (\text{id} \otimes g_\alpha)(g_\alpha \otimes \text{id})G(\varphi) +$$

where the two diagrams are taken with orientation $(13 \ 12 \ \dots \ 1)$ and evaluated with $\alpha \otimes \alpha$ input into I and II. The map $\Gamma : C^*(A, A) \rightarrow C^*(A, A) \otimes C^*(A, A)[2n - 1]$ then satisfies the equation

$$d(\Gamma(\varphi)) + \Gamma(d\varphi) = ((\smile \varphi \otimes \text{id}) - (\text{id} \otimes \varphi \smile))(\text{id} \otimes g_\alpha)(g_\alpha \otimes \text{id})E$$

The element J_α of Lemma 6.1, by capping on the left or on the right, gives a homotopy between each of the two terms on the right-hand side of the equation above and another term involving capping with the element D_α :

$$\begin{aligned} d((\smile \varphi \otimes \text{id})J_\alpha) + (\smile d\varphi \otimes \text{id})J_\alpha &= -(\smile \varphi \otimes \text{id})(\text{id} \otimes g_\alpha)(g_\alpha \otimes \text{id})(E) + (\smile \varphi \otimes \text{id})D_\alpha \\ d((\text{id} \otimes \varphi \smile)J_\alpha) + (\text{id} \otimes d\varphi \smile)J_\alpha &= -(\text{id} \otimes \varphi \smile)(\text{id} \otimes g_\alpha)(g_\alpha \otimes \text{id})(E) + (\text{id} \otimes \varphi \smile)D_\alpha \end{aligned}$$

We can easily picture another combination of diagrams which gives a homotopy between the two last terms of the equations above, by ‘passing’ the φ -vertex through the lines of the diagram. Taking K_α to be the evaluation of the following map on $\alpha \otimes \alpha$:

we have the equation

$$dK_\alpha(\varphi) + K_\alpha(d\varphi) = (\smile \varphi \otimes \text{id})D_\alpha - (\text{id} \otimes \varphi \smile)D_\alpha$$

Heuristically, the homotopies above are the *four sides of a square*, which sits inside of some topological space given by the realization of a cell complex, which should be seen as the space of operations on Hochschild (co)chains that we can realize with our calculus, the cells of which are labelled by our oriented diagrams. One can then naturally ask if there is a combination of cells that ‘fills in’ the squares, and the answer is yes:

Lemma 6.4. *There is a map*

$$N_\alpha : C^*(A, A) \rightarrow C^*(A, A) \otimes C^*(A, A)[2n - 2]$$

depending on α and β , such that we have an equality in $C^*(A, A) \otimes C^*(A, A)$

$$dN_\alpha(\varphi) - N_\alpha(d\varphi) = \Gamma(\varphi) + (\smile \varphi \otimes \text{id})J_\alpha - (\text{id} \otimes \varphi \smile)J_\alpha - K_\alpha(\varphi)$$

for every $\varphi \in C^*(A, A)$.

Proof. We give an expression for the element N_α in Appendix A.6.2. □

6.2.2. The compatibility relation. From now on, let us assume that α is nondegenerate. We return to the setting of Section 3.2.2, choosing a trivialization (E_0, H) of E onto W , see Definition 3.8. Let us recall the definition of the ‘balanced’ condition given in Definition 1.4.

Definition 6.5. The subcomplex W is *balanced* if:

- (1) The pairing between $\ker(\sharp[E]) \subset HH^*(A, A^\vee)$ and $HH_*(A, A)$ factors through the canonical map $HH_*(A, A) \rightarrow \overline{HH}_*(A, A) = H_*(C_*(A, A)/W)$ giving a pairing

$$\ker(\sharp[E]) \otimes \overline{HH}_*(A, A) \rightarrow \mathbb{k}$$

such that the induced map $\ker(\sharp[E]) \rightarrow (\overline{HH}_*(A, A))^\vee$ is a surjection.

- (2) The homology loop coproduct Δ_H factors through $HH_*(A, A) \rightarrow \overline{HH}_*(A, A)$ giving a map

$$\Delta_H : \overline{HH}_*(A, A) \rightarrow H_*(\overline{C}_*(A, A) \otimes \overline{C}_*(A, A))[n - 1]$$

We have a map $q : C_*(A, A^\vee[-n]) \rightarrow V \subseteq C_*(A, A)$ given by $\sharp E_0 \circ g_\alpha^{A^\vee}$, where V is some submodule of $C_0(A, A)$ containing the image of q . Since α is nondegenerate, it follows from Theorem 4.5 and Proposition 5.10 that $\sharp E \circ g_\alpha^{A^\vee}$ is homotopic to F_α , so abstractly we know that there will exist homotopies $h : C_*(A, A^\vee[-n]) \rightarrow C_*(A, A)[-1]$ such that h is a partial homotopy of F_α with respect to (V, i, q) , as in Definition 5.15.

We would like to choose two such homotopies h_1, h_2 such that the resulting product π_{h_1, h_2} , when restricted to $\ker(q)$, will be compatible with the coproduct Δ_H . It will be easier to find appropriate homotopies of a map to cochains instead. Let us consider the map $g_\alpha \circ F_\alpha : C_*(A, A^\vee[-n]) \rightarrow C^*(A, A)[n]$, and suppose that we are given two ‘partial homotopies’ \tilde{h}_1 and \tilde{h}_2 of $g_\alpha \circ F_\alpha$, that is, maps of graded vector spaces $C_*(A, A^\vee[-n]) \rightarrow C^*(A, A)[n - 1]$ such that $d\tilde{h}_i + \tilde{h}_i d = g_\alpha \circ F_\alpha - g_\alpha \circ q$ for $i = 1, 2$.

We can rewrite the pairing between the dual product and a Hochschild cochain in terms of the \tilde{h}_i , by using the following lemma:

Lemma 6.6. *For any pair $(\tilde{h}_1, \tilde{h}_2)$ as above, there exists a pair of partial homotopies h_1, h_2 of F_α such that for any closed elements $x_1, x_2 \in \ker(q)$ and $\varphi \in C^*(A, A)$, there is an equality*

$$\begin{aligned} \langle \pi_{h_1, h_2}(x_1, x_2), \varphi \rangle &= \Lambda_\alpha(x_1, x_2, \varphi) - (-1)^{\deg(x_1) \deg(x_2)} \langle x_1, \varphi \smile \tilde{h}_2(x_2) \rangle \\ &\quad + (-1)^{\deg(x_2) \deg(\varphi)} \langle x_2, \varphi \smile \tilde{h}_1(x_1) \rangle \end{aligned}$$

where Λ_α is a map defined by evaluating a certain combination of oriented ribbon quivers (Appendix A.6.3) on $\alpha \otimes \alpha$. Moreover, if \tilde{h}_1 and \tilde{h}_2 differ by a $[d, -]$ -exact term, we can also choose h_1, h_2 that differ by a $[d, -]$ -exact term.

Proof. Given in Appendix A.6.3. □

Suppose now that we are given a partial trivialization H of E . We define

$$(9) \quad \begin{aligned} \tilde{h}_1 &= ((\text{id} \otimes g_\alpha)(g_\alpha \times \text{id})H + J_\alpha + L_\alpha)^\sharp \\ \tilde{h}_2 &= \sharp((\text{id} \otimes g_\alpha)(g_\alpha \times \text{id})H + J_\alpha) \end{aligned}$$

that is, by pairing either on the right or the left-hand side of the specified elements of $C^*(A, A) \otimes C^*(A, A)$.

Lemma 6.7. *For any closed elements $x_1, x_2 \in \ker(q)$, $\varphi \in C^*(A, A)$, the following equation holds:*

$$\begin{aligned} &(-1)^{\deg(x_1) \deg(x_2)} \langle x_2 \otimes x_1, (\text{id} \otimes g_\alpha)(g_\alpha \otimes \text{id})\tilde{\Delta}_H(\varphi) \rangle \\ &= \Lambda_\alpha(x_1, x_2, \varphi) - (-1)^{\deg(x_1) \deg(x_2)} \langle x_1, \varphi \smile \tilde{h}_2(x_2) \rangle + (-1)^{\deg(x_2) \deg(\varphi)} \langle x_2, \varphi \smile \tilde{h}_1(x_1) \rangle \end{aligned}$$

Proof. Follows from the definition of $\tilde{\Delta}_H, \tilde{h}_1, \tilde{h}_2$, together with Lemma 6.4 and a homotopy that we give at the end of Appendix A.6.3. \square

The following proposition follows from Lemmas 6.6 and 6.7:

Proposition 6.8. *Given H as above, there are partial homotopies h_1, h_2 of F_α such that for any closed elements $x_1, x_2 \in \ker(q)$ and $y \in C_*(A, A)$ we have the equation*

$$\langle \pi_{h_1, h_2}(x_1, x_2), g_\alpha(y) \rangle = (-1)^{\deg(x_1) \deg(x_2)} \langle x_2 \otimes x_1, (\text{id} \otimes g_\alpha)(g_\alpha \otimes \text{id})\Delta_H(y) \rangle$$

Remark 6.9. If all the data used above (A, m, H etc.) is defined over a field \mathbb{k} , so is the coproduct Δ_H . The proposition above then implies that the induced homology-level coproduct Δ_H (on $HH_*(A, A)$ or $HH_*(A, A)/W$) is entirely determined by the corresponding dual product π_{h_1, h_2} . We note that if Δ_H happens to be defined over some ring \mathbb{k} , the equation of the proposition still holds at chain-level, but it may be that Δ_H contain *more information*; by dualizing we lose all the information about torsion classes.

6.2.3. Symmetry of H . Note that the statement of Proposition 6.8 does not depend on any symmetry conditions on H . Recall that we have $dH = E - E_0$, and E_0 is $(-1)^n$ -symmetric by assumption.

We know from Lemmas 6.1 and 6.2 that upon applying g_α on both sides, we have an explicit relation between E and its transpose:

$$d(J_\alpha + L_\alpha - J_\alpha^T) = (\text{id} \otimes g_\alpha)(g_\alpha \otimes \text{id})(E - (-1)^n E)$$

Therefore it is natural to consider the following symmetry condition on the space where H lives.

Definition 6.10. A (partial) trivialization H of E is *appropriately symmetric* if the expression

$$(\text{id} \otimes g_\alpha)(g_\alpha \otimes \text{id})(H - (-1)^n H^T) + J_\alpha + L_\alpha - J_\alpha^T$$

is exact in $C^*(A, A) \otimes C^*(A, A)$.

In many cases of interest, including all examples of Section 7, we have $E = E^T$ at the chain-level, with a trivial relation between them, $J_\alpha = L_\alpha = 0$. In this case, H is appropriately symmetric in the sense of the definition above if and only if it is $(-1)^n$ -symmetric. Moreover, if $E = E^T$, then the element $J_\alpha + L_\alpha - J_\alpha^T$ of degree 1 in $C_*(A, A)^{\otimes 2}$ is closed, even if it may not be zero, so we have:

Proposition 6.11. *If $E = E^T$ and $HH_1(A, A) \otimes HH_0(A, A) = 0$, then H is appropriately symmetric if and only if $H - (-1)^n H^T$ is exact.*

We have the following result:

Proposition 6.12. *If H is appropriately symmetric, then h_1 and h_2 in Proposition 6.8 can be chosen to differ by an exact term.*

Proof. The element H being appropriately symmetric implies that \tilde{h}_1 and \tilde{h}_2 in Eq. (9) differ by a $[d, -]$ -exact term. Then the result follows from the second assertion of Lemma 6.6. \square

Over a field, we can combine the propositions before into the following result.

Theorem 6.13. *Let \mathbb{k} be a field. If H is appropriately symmetric at the homology level, then the coproduct Δ_H is $(-1)^n$ -cocommutative at the homology level. If moreover A is connective and $n \geq 3$, then it is also coassociative at the homology level.*

Proof. Combining Proposition 5.16 (cf. Proposition 5.13) with Proposition 6.12, we obtain that the product π_{h_1, h_2} is $(-1)^n$ -commutative. Then the $(-1)^n$ -cocommutativity of Δ_H follows from the compatibility relation in Proposition 6.8; over a field, this relation implies that the coproduct and the product fully determine each other. Similarly, combining Proposition 5.17 (cf. Proposition 5.14) with Proposition 6.12, we see that π_{h_1, h_2} is associative and thus the coassociativity of Δ_H follows from Proposition 6.8. \square

The results above are what we stated in the Introduction as Theorem 1.5.

7. EXAMPLES

The formalism of pre-CY structures and the associated calculus developed in [KTV22] is suitable for constructing homotopies and higher structures described in terms of diagrams. Evaluating such diagrams involves taking sums over many expressions. However, in particular examples, one can perform explicit calculations by hand. We would like to present some of these calculations using examples of interest for string topology.

In this section we will study the algebraic loop product and coproduct for algebras given by the homology of the loop spaces of spheres. Spheres are formal and coformal [Ber14; BB17], so the graded algebra $A = H_*(\Omega S^N)$ is quasi-isomorphic to the dg algebra of chains on ΩS^N . We reiterate that, for some general manifold M , this homology will not be quasi-isomorphic to the algebra of chains, so looking at the homology algebra $H_*(\Omega M)$ would not give the correct answers.

One should be careful when comparing the calculations we perform below to the geometric loop coproduct, since the algebraic operation Δ_H we defined *is not invariant* with respect to quasi-isomorphisms of A . In fact, for some choices of H , Δ_H might not have a geometric interpretation and the space of “geometrically meaningful” trivializations seems to be more restricted.

Still, we believe that the examples we calculate below could be of interest for string topology. It may seem like this chain-level formalism is overly complicated for calculating such simple examples; nevertheless, we argue that it allows for a systematic treatment of signs which, in some cases, as for the even-dimensional spheres Section 7.2, allows us to work over \mathbb{Z} and understand the behavior of torsion classes.

The cases of the circle and the 2-sphere are of particular interest; in both of those cases, there are more than one possible choices of appropriately symmetric (Definition 6.10) trivialization H , some of which give non-coassociative coproducts Δ_H . These examples show that the condition $n \geq 3$ on the CY dimension in Theorem 6.13 is necessary.

7.1. Spheres of odd dimension greater or equal to 3. Let us take $A = \mathbb{k}[t]$, $\deg(t) = 2N \geq 2$, seen as a homologically graded dg algebra over \mathbb{k} with trivial differential. As mentioned above, this is the homology algebra of ΩS^{2N+1} , and since the sphere is coformal, the Hochschild homology of A calculates the homology of LS^{2N+1} . More explicitly, it is given by

$$HH_*(A, A) = \mathbb{k} \bigoplus_{k \geq 1} (\mathbb{k}[2Nk] \oplus \mathbb{k}[2Nk + 1])$$

This may be computed using the Koszul resolution of A in Eq. (10) below, and we may pick some simple representatives in the Hochschild chain complex $C_*(A, A)$ (see Section 2.1.1) for each of those classes: the chain of length one t^k for the generator in degree $2Nk$, for each $k \geq 0$, and the chain of length two $t^{k-1}[t]$ for the generator in degree $2Nk + 1$, for each $k \geq 1$. Here, $[t] \in \overline{A}[1]$.

Let us also calculate and pick explicit representatives for the non trivial classes in the Hochschild cohomology of A . Following the noncommutative geometry analogy between Hochschild

cochains and vector fields, we think of A as functions on some space with coordinates $s_k, k \geq 0$, where s_k is dual to t^k , and denote by $s_{k_1} s_{k_2} \dots s_{k_p} \partial^k$ the Hochschild cochain of length p that sends the basis element $[t^{k_1}] \otimes [t^{k_2}] \otimes \dots \otimes [t^{k_p}]$ to t^k and all other basis elements $[t^{k'_1}] \otimes \dots \otimes [t^{k'_q}]$ to zero. We note that for any $k \geq 0$, the cochain ∂^k of length zero and degree $2Nk$ is closed, and so is the cochain $\sum_i i s_i \partial^{i+k}$, of length one and degree $2Nk + 1$. It turns out that these are all the representatives for the nonzero Hochschild cohomology classes. We summarize our chosen representatives below:

chains	...	$t^2[t]$	t^3	$t[t]$	t^2	$1[t]$	t	1
deg in $HH_*(A, A)$...	$6N + 1$	$6N$	$4N + 1$	$4N$	$2N + 1$	$2N$	0
cochains	...	∂^2	$\sum_i i s_i \partial^{i+2}$	∂^1	$\sum_i i s_i \partial^{i+1}$	∂^0	$\sum_i i s_i \partial^i$	$\sum_i i s_i \partial^{i-1}$
deg in $HH^*(A, A)$...	$4N$	$4N - 1$	$2N$	$2N - 1$	0	-1	$-2N - 1$

7.1.1. Chain-level Chern character. Recall that even before we pick any notion of orientation on A (smooth CY or pre-CY structure), once we pick chain-level representatives for the canonical vertices co and η we can define the chain-level Chern character of the diagonal bimodule E and the operation $G : C^*(A, A) \rightarrow C_*(A, A) \otimes C_*(A, A)[-1]$.

First, we must choose an explicit representative for the bimodule dual $A^!$. For that, we use the following resolution for the diagonal bimodule A :

$$(10) \quad \tilde{A} = (A^e[2N + 1] \oplus A^e, d_{\tilde{A}})$$

with differential that sends elements of the first summand to the second summand by

$$d_{\tilde{A}}(t^k \otimes t^\ell) = t^{k+1} \otimes t^\ell - t^k \otimes t^{\ell+1}$$

that is, sending the generator $1 \otimes 1 \in A^e[2N + 1]$ to $t \otimes 1 - 1 \otimes t \in A^e$. We then dualize this bimodule to get a representative of $A^!$ given by

$$A^! = (A^e \oplus A^e[-2N - 1], d_{A^!}).$$

Let us denote the elements of the first and second summand by $R^{k,\ell}, S^{k,\ell}$, respectively (denoting $t^k \otimes t^\ell$ in each factor), with differential given by

$$d_{A^!}(R^{k,\ell}) = S^{k+1,\ell} - S^{k,\ell+1}$$

The bimodule structure is given by the structure maps

$$\begin{aligned} \mu(t^i, R^{k,\ell}) &= R^{k+i,\ell} \\ \mu(R^{k,\ell}, t^i) &= R^{k,\ell+i} \\ \mu(t^i, S^{k,\ell}) &= S^{k+1,\ell} \\ \mu(S^{k,\ell}, t^i) &= -S^{k,\ell+i} \end{aligned}$$

We must now find chain-level representatives for the co and η vertices. These are not unique, but we can easily find a choice that satisfies the necessary conditions. For the coevaluation $\text{co} \in A \otimes_{A^e}^{\mathbb{L}} A^!$, we have

$$(11) \quad \text{co} = 1 \otimes [\emptyset] \otimes R^{0,0} \otimes [\emptyset] - 1 \otimes [t] \otimes S^{0,0} \otimes [\emptyset] - 1 \otimes [\emptyset] \otimes S^{0,0} \otimes [t].$$

Here, co lies in $\bigoplus_{i,j \geq 0} A \otimes \bar{A}^{\otimes i} \otimes A^! \otimes \bar{A}^{\otimes j}$ and is illustrated as follows, compare Eq. (5)

$$\text{co} = 1 \leftarrow \textcircled{\alpha} \rightarrow R^{0,0} \quad - \quad \begin{array}{c} [t] \\ \uparrow \\ 1 \leftarrow \textcircled{\alpha} \rightarrow S^{0,0} \end{array} \quad - \quad \begin{array}{c} 1 \leftarrow \textcircled{\alpha} \rightarrow S^{0,0} \\ \downarrow \\ [t] \end{array}$$

We check that this element is closed and satisfies the universal property of coevaluation.

For the vertex η we can then pick the form given by

$$\begin{array}{c}
 t^n \\
 \downarrow \\
 \leftarrow \boxed{\eta} \rightarrow \\
 \uparrow \\
 R^{k,\ell}
 \end{array}
 = \eta(t^n \otimes R^{k,\ell}) = t^\ell \otimes t^{n+k}$$

$$\begin{array}{c}
 t^n \\
 \downarrow \\
 \leftarrow \boxed{\eta} \rightarrow \\
 \uparrow \\
 S^{k,\ell}
 \end{array}
 = \eta([t^m] \otimes t^n \otimes S^{k,\ell}) = - \sum_{1 \leq i \leq m} t^{\ell+i-1} \otimes t^{k+n+m-i}$$

with all other terms of η being zero. The first term, involving $R^{k,\ell}$, guarantees that η and co satisfy the required compatibility Eq. (6), and the second term, involving $S^{k,\ell}$, makes η closed under taking the necklace bracket with μ .

Using the vertices above we compute the chain-level Euler character to be $E = 0$, since it is a difference between two equal terms $1 \otimes 1$, one obtained from pairing the first term of co with the first term of η and the other from pairing the third term of co with the second term of η ; all other terms in the evaluation of the diagram are zero. Having $E = 0$ is obviously expected since the Euler characteristic of S^{2N+1} is zero, and the differential on Hochschild chains vanishes in degree one since A is commutative.

7.1.2. *The map G .* Since $E = 0$ at chain-level as explained above, the map G is a map of complexes (see Eq. (7)), and induces a map in cohomology

$$[G] : HH^*(A, A) \rightarrow HH_*(A, A) \otimes HH_*(A, A).$$

Let us calculate the chain-level map on φ ranging over the representatives we picked for the nonzero cohomology classes. We note that the only nonzero diagram to evaluate in the expression for $G(\varphi)$ is the term

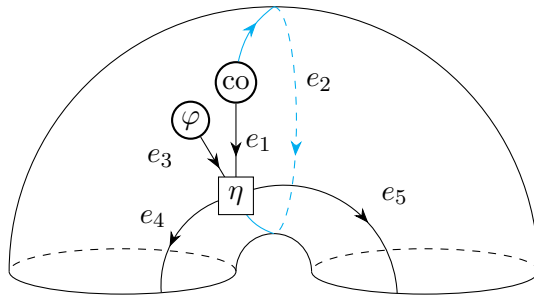

with orientation $(e_5 \ e_4 \ e_3 \ e_2 \ e_1)$. We plug in the expressions we picked for co and η , and calculate:

$$\begin{aligned}
 G(\partial_k) &= \sum_{1 \leq i \leq k} (t^{i-1} \otimes t^{k-i}[t] - t^{i-1}[t] \otimes t^{k-i}) \\
 G\left(\sum_i i s_i \partial^{i+k}\right) &= - \sum_{1 \leq j \leq k+1} (t^{j-1} \otimes t^{k+1-j})
 \end{aligned}$$

To calculate the second line above, note that co only contains terms with power of t equal to one (see Eq. (11)) so only the term $G(s_1 \partial^{1+k})$ is nonzero.

The map induced by G on cohomology does not depend on our choice of co and η ; by the discussion in Section 3.3, we could compensate a change in the chain-level expressions for those

vertices by a change in H , but the space of choices for H (i.e. the $HH_0(A, A) \otimes HH_1(A, A) \oplus HH_1(A, A) \otimes HH_0(A, A)$ -torsor) is trivial in homology.

7.1.3. The CY and pre-CY structures. Let us now pick the orientation on A , which for us will be a non-degenerate pre-CY structure. We will prove nondegeneracy by first giving a compatible smooth CY structure:

Proposition 7.1. *The Hochschild chain $\omega = 1[t] \in C_{2N+1}(A, A)$ is non-degenerate.*

Proof. We will prove this by explicitly giving its inverse pre-CY structure. Let $\alpha \in C_{(2)}^{2N+1}(A)$ be given by the formulas

$$\begin{array}{ccc} \begin{array}{c} t^k \\ \downarrow \\ \alpha(\emptyset, t^k)' \leftarrow \textcircled{\alpha} \rightarrow \alpha(\emptyset, t^k)'' \\ \uparrow \\ t^k \end{array} & & \alpha(\emptyset, t^k)' \otimes \alpha(\emptyset, t^k)'' = \sum_{0 \leq i \leq k-1} t^i \otimes t^{k-1-i} \\ \begin{array}{c} \alpha(t^k, \emptyset)' \leftarrow \textcircled{\alpha} \rightarrow \alpha(t^k, \emptyset)'' \\ \uparrow \\ t^k \end{array} & & \alpha(t^k, \emptyset)' \otimes \alpha(t^k, \emptyset)'' = - \sum_{0 \leq i \leq k-1} t^i \otimes t^{k-1-i} \end{array}$$

with all other components of α being zero. Let us explain this better; α only evaluates non-trivially on exactly one input, sending t^k to the tensor $\pm \sum t^i \otimes t^{k-1-i}$, with sign depending on which side this input is on; recall that since the CY dimension is odd, α needs to be antisymmetric under the rotation. We can check that this is a closed element of $C_{(2)}^*(A)$, under the differential given by taking necklace bracket with the Hochschild cochain giving the A_∞ structure μ (in this case just the multiplication). In this case this means explicitly verifying the following equation

$$\begin{array}{c} \begin{array}{c} t^k \quad t^\ell \\ \downarrow \quad \downarrow \\ \leftarrow \textcircled{\alpha} \rightarrow \bullet \rightarrow \end{array} + \begin{array}{c} t^k \quad t^\ell \\ \downarrow \quad \downarrow \\ \leftarrow \bullet \leftarrow \textcircled{\alpha} \rightarrow \end{array} = \begin{array}{c} t^k \quad t^\ell \\ \swarrow \quad \searrow \\ \bullet \\ \downarrow \\ \leftarrow \textcircled{\alpha} \rightarrow \end{array} \end{array}$$

for all $k, \ell \geq 0$, which holds since both sides are equal to $-\sum_{0 \leq i \leq k+\ell-1} t^i \otimes t^{k+\ell-1-i}$.

It remains to check that α is indeed an inverse to ω , that is, that the Hochschild cochain given by

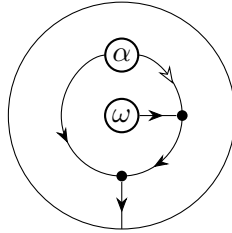

is cohomologous to the unit cochain; in this case one can calculate that it is exactly equal to the unit cochain. \square

In order to apply our results, we need the element α we found above to be part of a pre-CY structure. In this case, there is no more trivial terms.

Proposition 7.2. *Taking $m = \mu + \alpha, m_{(\geq 3)} = 0$, gives a pre-CY structure of dimension $2N + 1$ on A .*

Proof. We already verified that $[\mu, \alpha] = 0$, so the only equation left to verify is that $[\alpha, \alpha] = 0$ in $C_{(3)}^*(A)$. Since α is only nonzero evaluated on exactly one input, the only possibly nontrivial term in $[\alpha, \alpha]$ can be on exactly one input. By symmetry it is enough to place it in the first of

the three angles; we then have that the only nontrivial terms are

$$\begin{aligned}
 [\alpha, \alpha](t^k, \emptyset, \emptyset) &= \text{Diagram 1} + \text{Diagram 2} \\
 &= - \sum_{i_1+i_2+i_3=k-1} t^{i_1} \otimes t^{i_2} \otimes t^{i_3} + \sum_{i_1+i_2+i_3=k-1} t^{i_1} \otimes t^{i_2} \otimes t^{i_3} = 0
 \end{aligned}$$

□

7.1.4. *The algebraic loop coproduct.* As we mentioned above, the space of choices for H has trivial homology; combined with the fact that $E = 0$ at chain-level, we conclude that any choice of H (that is, with $dH = 0$) will only contribute zero to the homology-level coproduct.

We use the element α we found above to calculate the chain-level map $g_\alpha : C_*(A, A) \rightarrow C^*(A, A)[2N + 1]$ on the chosen representatives of the nonzero classes. We calculate that for every $k \geq 0$ we have

$$g_\alpha(t^k) = - \sum_i i s_i \partial^{i+k-1}, \quad g_\alpha(t^k[t]) = \partial_k,$$

so composing with the map G we get:

$$\begin{aligned}
 \Delta(t^k) &= \sum_{1 \leq i \leq k} t^{i-1} \otimes t^{k-i} \\
 \Delta(t^k[t]) &= \sum_{1 \leq i \leq k} (t^{i-1} \otimes t^{k-i}[t] - t^i[t] \otimes t^{k-1-i})
 \end{aligned}$$

As expected from Theorem 6.3, since the CY dimension ≥ 3 and $H = 0$ is symmetric, the coproduct above is cocommutative and coassociative. It also agrees with the coproduct on the free loop space homology defined topologically. Comparing to the expression in [CHO23], for example, the identification between our basis and theirs is given by $t^k \leftrightarrow AU^k$ and $t^k[t] \leftrightarrow U^k$.

7.1.5. *The cone bimodule.* For the sake of illustration, let us now describe the dual picture, that is, the product on $HH^*(A, A^\vee)$. For that, we use the bimodule $M = \text{Cone}(f_\alpha)$ which is quasi-isomorphic to the categorical formal punctured neighborhood of infinity since α is non-degenerate. To compute the morphism of bimodules $f_\alpha : B\overline{A}[1] \otimes A^\vee \otimes B\overline{A}[1] \rightarrow A$, let us fix some notation: we denote by s_k the element of degree $-2Nk$ in A^\vee which is dual to t^k , that is, which maps t^ℓ to $\delta_{\ell-k}$. The set $\{s_k\}_{k \in \mathbb{N}}$ is not a complete basis of the space A^\vee (which is, after all, just the algebraic dual so ‘bigger’ than A), but it will suffice to describe the map f_α on it. We have that the only nontrivial values are

$$f_\alpha(s_k \otimes t^\ell) = -\chi_{k \leq \ell-1} t^{\ell-1-k}, \quad f_\alpha(t^\ell \otimes s_k) = \chi_{k \leq \ell-1} t^{\ell-1-k}$$

where χ_{\dots} is the ‘indicator function’, that is, one if \dots is satisfied and zero if it is not. The induced map on Hochschild chains is then $F_\alpha : C_*(A, A^\vee[-2N - 1]) \rightarrow C_*(A, A)$ is then given by

$$F_\alpha(s_k[t^{k_1} | \dots | t^{k_p}]) = -\chi_{k \leq k_1-1} t^{k_1-1-k} [t^{k_2} | \dots | t^{k_p}] + (-1)^{p-1} \chi_{k \leq k_p-1} t^{k_p-1-k} [t^{k_1} | \dots | t^{k_{p-1}}]$$

We can easily show that this map is zero on cohomology. Since A is smooth $(2N + 1)$ -CY, we have $HH_*(A, A^\vee[-2N - 1]) = HH^*(A, A^\vee) = (HH_*(A, A))^\vee$ which is supported in degrees $0, -2N, -2N + 1, -4N, -4N - 1, \dots$. Meanwhile, the target of F_α has cohomology supported in degrees $0, 2N, 2N + 1, 4N, 4N + 1, \dots$. Therefore the only possible nontrivial map would be represented in degree zero, but F_α vanishes there.

7.1.6. *The product on the cone.* We have that $C_*(A, M) \simeq \text{Cone}(F_\alpha) = C^*(A, A^\vee[-2N]) \oplus C_*(A, A)$, with the extra differential given by F_α above. We calculate the extension of the pre-CY structure from A to M , which depends on α and τ (zero in this case)[§]

$$\begin{aligned}\mu_M(t^k, t^\ell) &= 0 + t^{k+\ell}, \\ \mu_M(s_k, t^\ell) &= s_{k-\ell} - \chi_{k \leq \ell-1} t^{\ell-1-k}, \\ \mu_M(t^\ell, s_k) &= s_{k-\ell} + \chi_{k \leq \ell-1} t^{\ell-1-k}, \\ \mu_M(s_k, s_\ell) &= s_{k+\ell+1} + 0.\end{aligned}$$

This allows us to calculate the product π_M for any two cochains in $C_*(A, M)$. It suffices to compute the product on the chosen representatives; besides the representatives for the classes in $HH_*(A, A)$, we can choose representatives for the nontrivial classes in $HH^*(A, A^\vee)$:

$$s_k, \deg = 2N(k+1) \quad \text{and} \quad s_k[t], \deg = 2N(k-1) - 1, \text{ for } k \geq 0$$

We compute:

$$\begin{aligned}\pi(t^k[t], t^\ell) &= -t^{k+\ell} \\ \pi(t^k[t], t^\ell[t]) &= t^{k+\ell}[t] \\ \pi(s_k[t], s_\ell) &= -s_{k+\ell+1}, \\ \pi(s_k[t], s_\ell[t]) &= s_{k+\ell+1}[t], \\ \pi(s_k[t], t^\ell) &= -s_{k-\ell} + \chi_{k \leq \ell-1} t^{\ell-1-k}, \\ \pi(s_k, t^\ell[t]) &= s_{k-\ell} - \chi_{k \leq \ell-1} t^{\ell-1-k}, \\ \pi(s_k[t], t^\ell[t]) &= s_{k-\ell}[t] - \chi_{k \leq \ell-1} t^{\ell-1-k}[t]\end{aligned}$$

with the remaining operations either determined from the above by graded skew-commutativity or zero otherwise. To lift the product to $C^*(A, A^\vee)$, one would need to pick nullhomotopies h_1, h_2 . But even though any nullhomotopy h of F_α must be nonzero, we only need to evaluate it on the cycles $s_k, s_k[t]$ above; the respective images $h(s_k)$ and $h(s_k[t])$ live in degrees $-2N(k+1)$ and $-2Nk+1$, where the complex vanishes. So for any pair of homotopies h_1, h_2 , the corresponding product on $C_*(A, A^\vee[-2N])$ is just given, up to exact terms, by:

$$\begin{aligned}\pi_{h_1, h_2}(s_k[t], s_\ell) &= -s_{k+\ell+1}, \\ \pi_{h_1, h_2}(s_k[t], s_\ell[t]) &= s_{k+\ell+1}[t].\end{aligned}$$

As expected from Proposition 6.8, this product is dual to the coproduct Δ , using the pairing

$$(s_k, t^\ell[t]) \mapsto -\delta_{k-\ell}, \quad (s_k[t], t^\ell) \mapsto \delta_{k-\ell}.$$

Note also that since there are no torsion classes in $HH_*(A, A)$, the product π_{h_1, h_2} on $HH_*(A, A^\vee)$ contains the same amount of information as the coproduct Δ on $HH_*(A, A)$.

7.2. Spheres of even dimension greater or equal to 4. Let us consider the dg algebra $A = \mathbb{k}[t]$ with $\deg(t) = 2N - 1, N \geq 2$, with trivial differential.

In order not to get confused about signs, which will be very important in this example, let us be more precise: as an A_∞ -algebra, we have $\mu^{\neq 2} = 0$, and μ^2 is given by $\mu^2(t^k, t^\ell) = (-1)^k t^{k+\ell}$, where we view $\mu^i \in C^2(A, A)$. This affects the signs in the Hochschild chain differential $\partial = L_\mu$, see Example 2.3.

The Hochschild homology $HH_*(A, A)$ will depend on our choice of ring \mathbb{k} ; the only difference between this case and the case of Section 7.1 is that the differential $C_1(A, A) \rightarrow C_0(A, A)$ does

[§]Again, M as vector space is actually the sum of the bar resolution of $A^\vee[-2N-1]$ and A ; in this case only the length zero elements have nontrivial products.

not vanish, and instead we have $d(t^{2i-1}[t]) = -2t^{2i}$ for every $i \geq 1$. Therefore, over \mathbb{Z} we do not have the classes represented by $t^{\text{odd}}[t]$, and the classes represented by t^{even} are 2-torsion:

$$HH_*(A, \mathbb{Z}) = \mathbb{Z} \oplus \bigoplus_{1 \leq k \text{ odd}} (\mathbb{Z}[(2N-1)k] \oplus \mathbb{Z}[(2N-1)k+1]) \oplus \bigoplus_{2 \leq \ell \text{ even}} \frac{\mathbb{Z}}{2\mathbb{Z}}[(2N-1)\ell]$$

Let us also calculate representatives for the nonzero classes in $HH^*(A, A)$. As in the example of Section 7.1, they can all be realized by cochains of length zero and one, except that the representatives will change. For length zero we calculate that:

$$d(\partial^k)(t^i) = \begin{cases} 0 & k \text{ even} \\ (-1 + (-1)^i)t^{k+i} & k \text{ odd} \end{cases}$$

so only the cochains ∂^k with k even represent nonzero classes, each of degree $k(2N-1)$. As for cochains of length one, denoting we have the following closed elements

$$\sum_{i \geq 1} i s_i \partial^{i+k}, k \text{ even}, \quad \sum_{i \geq 1} \frac{1 - (-1)^i}{2} s_i \partial^{i+k}, k \text{ odd}.$$

of degree $k(2N-1) - 1$. To simplify notation, let us set $\sigma_i = \frac{1 - (-1)^i}{2}$, or equivalently $\sigma_i = i \pmod{2}$; Note that for odd $k \geq 1$, $\sum_{i \geq 1} \sigma_i s_i \partial^{i+k}$ has order 2, since twice this class is equal to $-d(\partial^k)$ by the calculation above. Denoting the 2-torsion classes in red, we summarize our chosen representative chains in $HH_*(A, \mathbb{Z})$ and cochains in $HH^*(A, \mathbb{Z})$:

chains	...	t^4	$t^2[t]$	t^3	t^2	$1[t]$	t	1
deg	...	$8N-4$	$6N-2$	$6N-3$	$4N-2$	$2N$	$2N-1$	0
cochains	...	$\sum_{i \geq 1} \sigma_i s_i \partial^{i+3}$	∂^2	$\sum_i i s_i \partial^{i+2}$	$\sum_i \sigma_i s_i \partial^{i+1}$	∂^0	$\sum_i i \sigma_i \partial^i$	$\sum_i \sigma_i s_i \partial^{i-1}$
deg	...	$6N-4$	$4N-2$	$4N-3$	$2N-2$	0	-1	$-2N$

In other words, over any field $\mathbb{k}_{\neq 2}$ of characteristic $\neq 2$, the red classes are zero in (co)homology. Over a field \mathbb{k}_2 of characteristic two, the chains $t^{\text{odd}}[t]$ and cochains ∂^{even} are closed, and represent nonzero classes in $HH_*(A, \mathbb{k}_2)$ and $HH^*(A, \mathbb{k}_2)$, respectively.

7.2.1. *Chain-level Chern character and map G.* The description of A^1 and the vertices co and ev is just like in the case of odd-dimensional spheres, with the only difference being in signs. More precisely, the inverse dualizing bimodule is still given by

$$A^1 = (A^e \oplus A^e[-2N], d_{A^1})$$

with basis of first and second summand given by elements labeled $R^{k,\ell}, S^{k,\ell}$, with differential still given by $d_{A^1}(R^{k,\ell}) = S^{k+1,\ell} - S^{k,\ell+1}$. On the other hand, the bimodule structure maps also have some signs we need to take into account, for example:

$$\begin{aligned} \mu(t^i, R^{k,\ell}) &= (-1)^i R^{k+i,\ell} \\ \mu(R^{k,\ell}, t^i) &= (-1)^{k+\ell} R^{k,\ell+i} \\ \mu(t^i, S^{k,\ell}) &= (-1)^i S^{k+1,\ell} \\ \mu(S^{k,\ell}, t^i) &= (-1)^{k+\ell} S^{k,\ell+i} \end{aligned}$$

The elements co and η also differ from the case of Section 7.1 by signs; we have

$$\begin{aligned} \text{co} &= 1 \otimes R^{0,0} + 1 \otimes [t] \otimes S^{0,0} + 1 \otimes S^{0,0} \otimes [t] \\ \eta(t^n; R^{k,\ell}) &= (-1)^{n(k+\ell+1)+(k+1)\ell} t^\ell \otimes t^{k+n} \\ \eta([t^m], t^n; R^{k,\ell}) &= (-1)^{(m+n)(k+\ell+1)+k\ell+m} \sum_{i=1}^m (-1)^{(i-1)(k+\ell+1)} t^{\ell+i-1} \otimes t^{k+n+m-i} \end{aligned}$$

The complicated signs above arise from the requirement that η be closed under the correct differential d given by taking the necklace bracket with the structure maps. We recall that when exchanging terms past one another we use the reduced degree.

Using the vertices above we compute $E = 2 \times (1 \otimes 1)$, as expected for an even-dimensional sphere. Let us now calculate G on our chosen representatives:

$$G(\partial_k) = \sum_{i=1}^k (-1)^{i+1} (t^{i-1} \otimes t^{k-i}[t] + t^{i-1}[t] \otimes t^{k-i})$$

$$G\left(\sum_i i s_i \partial^{i+k}\right) = G\left(\sum_i \sigma_i s_i \partial^{i+k}\right) = \sum_{i=1}^{k+1} (-1)^{i+1} (t^{i-1} \otimes t^{k-i})$$

7.2.2. Pre-CY structure and chain-level coproduct. The CY and pre-CY structure here is also very similar to the one discussed in the case of Section 7.1, with difference in signs; here α will be symmetric with respect to the $\mathbb{Z}/2\mathbb{Z}$ -action changing the marking of the first output, since the dimension is even. That is,

$$\alpha(\emptyset, t^k) = \alpha(t^k, \emptyset) = \sum_{0 \leq i \leq k-1} t^i \otimes t^{k-i-1}$$

is the only non-zero term for $m_{(2)} = \alpha$ and there are no higher terms in the pre-CY structure, since $\alpha \circ \alpha = 0$, which is a calculation where one has to be careful with signs.

We can then calculate the chain-level map $g_\alpha : C_*(A, A) \rightarrow C^*(A, A)[2N]$ on the chosen representatives of the nonzero classes. We calculate that for every $k \geq 0$ we have

$$g_\alpha(t^k) = \begin{cases} \sum_i i s_i \partial^{i+k-1} & k \text{ odd,} \\ \sum_i \sigma_i s_i \partial^{i+k-1} & k \text{ even,} \end{cases} \quad g_\alpha(t^k[t]) = \partial^k,$$

To get a chain-level coproduct, we must pick a partial trivialization of E . We pick $E_0 = E = 2(1 \otimes 1)$ and $W = 2\mathbb{Z} \subseteq C_0(A, \mathbb{Z})$, that is, the \mathbb{Z} -submodule to be spanned by a chain of length one given by $2 \in A$; this is balanced. Any partial trivialization H satisfies $dH = 0$. Since $HH_1(A, A) = C_1(A, A) = 0$, the torsor in which H lives has trivial homology, and any choice of H will give the same coproduct; this would hold even if we picked some other quasi-isomorphism algebra $A' \simeq A$.

Therefore the chain-level coproduct is given by

$$\Delta(t^k) = \sum_{i=1}^k (-1)^{i+1} (t^{i-1} \otimes t^{k-i})$$

$$\Delta(t^k[t]) = \sum_{i=1}^k (-1)^{i+1} (t^{i-1} \otimes t^{k-i}[t] + t^{i-1}[t] \otimes t^{k-i}).$$

7.2.3. The product on the cone and lift to product on the dual. The expression for the morphism f_α is also similar to the case of Section 7.1, just differing in signs. The induced map on Hochschild chains is

$$F_\alpha(s_k[t^{k_1} | \dots | t^{k_p}]) = \chi_{k \leq k_1-1} (-1)^{\sharp_1} t^{k_1-1-k} [t^{k_2} | \dots | t^{k_p}] + \chi_{k \leq k_p-1} (-1)^{\sharp_2} t^{k_p-1-k} [t^{k_1} | \dots | t^{k_{p-1}}]$$

where $\sharp_1 = k k_1$, $\sharp_2 = (k_p + 1)(k + k_1 + \dots + k_{p-1} + p + k) + k + k_p$. We recall also that one must change the signs of the pairing between A^\vee and A , setting $\text{ev}(s_k, t^\ell) = (-1)^k \delta_{k-\ell}$

We evaluate some of the products on the cone $C_*(A, A^\vee[-2n+1]) \otimes C_*(A, A)$:

$$\begin{aligned} \pi(t^k[t], t^\ell) &= (-1)^{(k+1)\ell} t^{k+\ell} \\ \pi(t^k[t], t^\ell[t]) &= (-1)^{(k+1)\ell} t^{k+\ell}[t] \\ p\pi(t^k[t], s_\ell) &= (-1)^{(k+1)\ell} s_{\ell-k} \\ p\pi(s_k[t], t^\ell) &= (-1)^{(k+1)\ell} s_{k-\ell} \\ p\pi(s_k[t], s_\ell) &= (-1)^{k(\ell+1)} s_{k+\ell+1}, \\ p\pi(s_k[t], s_\ell[t]) &= (-1)^{k(\ell+1)} s_{k+\ell+1}[t], \end{aligned}$$

again with other products determined by commutativity or zero otherwise. We note that the resulting product on $C_*(A, A^\vee)$ does not respect the differential on all of that complex; if we take $k = 0, \ell = 2i + 1$, the product of closed chains $p\pi(s_0[t], s_{2i+1}) = s_{2i+2}[t]$ is not closed.

The cohomology of $C_*(A, A^\vee[-2N])$ is concentrated in degrees ≥ 0 and the cohomology of $C_*(A, A)$ in degrees ≤ 0 ; therefore the only nontrivial map in homology is in degree zero, where the map is multiplication by 2. Note that $s_0[t]$ is the only ‘problematic class’; this is expected, since we know that upon picking a partial homotopy of F_α , we will only be able to lift this product to a subspace of $C_*(A, A^\vee)$.

Again, we do not have much of a choice for this partial homotopy; we pick $E_0 = E = 2(1 \otimes 1)$, which gives $W = 2R \subset C_0(A, A)$, with map $q : C_*(A, A^\vee[-2N]) \rightarrow W$ given by sending $s_0[t] \rightarrow 2$ in degree zero and zero in other degrees. Making any choice of pairs h_1, h_2 of partial homotopies, that is, with $dh + hd = F_\alpha - iq$ for $h = h_1, h_2$, we can lift the product to $\ker(q)$, but in fact, though the chain-level expression for any choice of h will be nontrivial, also in this case any two such choices differ by a $[d, -]$ -exact term; moreover, when evaluated on chains of lengths one and two we already have $\sharp E_0 = F_\alpha$.

So on our representatives we can ignore the H -terms, and for any choice of H we get the following product, up to exact terms:

$$(12) \quad \pi_H(s_k, s_\ell) = 0,$$

$$(13) \quad \pi_H(s_k[t], s_\ell) = (-1)^{k(\ell+1)} s_{k+\ell+1},$$

$$(14) \quad \pi_H(s_k[t], s_\ell[t]) = (-1)^{k(\ell+1)} s_{k+\ell+1}[t],$$

As expected, the resulting product on $C_*(A, A^\vee)$ does not respect the differential on all of that complex; if we take $k = 0, \ell = 2i + 1$, the product of closed chains $p\pi(s_0[t], s_{2i+1}) = -s_{2i+2}[t]$ is not closed. Note that $s_0[t]$ is the only ‘problematic class’.

7.2.4. *Over a field of characteristic $\neq 2$.* Over $\mathbb{k} = \mathbb{k}_{\neq 2}$, we have $W \cong \mathbb{k}_{\neq 2}$, that is, the rank one vector space in degree zero. Since $\Delta_H(1) = 0$ we have a map of complexes

$$\Delta_H : C_*(A, A)/W \rightarrow C_*(A, A)/W \otimes C_*(A, A)/W$$

Let us analyze the induced coproduct in homology. the closed classes in $HH_*(A, \mathbb{k}_{\neq 2})/W$ represented by t^k , which is exact if k is even, and $t^\ell[t]$, only with ℓ even. We note that each summand in the expression for $\Delta_H(t^k)$ is closed, and since $[t^{\text{even}}] = 0$, this coproduct in homology is just given by

$$\Delta(t^k) = - \sum_{i=1}^{(k-1)/2} t^{2i-1} \otimes t^{k-2i} \quad k \text{ odd}$$

As for $\Delta(t^\ell[t])$, we note that even though some of the terms in its expression are not individually closed (since $\partial(t^{2i-1}[t]) = -2t^{2i}$), the whole sum is closed under the differential $\partial_{C_* \otimes C_*}$ on the tensor product $C_*(A, A)/\mathbb{k} \otimes C_*(A, A)/\mathbb{k}$. Moreover, we have

$$b(t^{2i-1}[t] \otimes t^{2j-1}[t]) = -2t^{2i} \otimes t^{2j-1}[t] + 2t^{2i-1}[t] \otimes t^{2j}$$

so every difference $(t^{2i} \otimes t^{2j-1}[t] - t^{2i-1}[t] \otimes t^{2j})$ is zero in homology. Thus the coproduct in homology is given by

$$\Delta(t^\ell[t]) = - \sum_{i=1}^{\ell/2} t^{2i-1} \otimes t^{\ell-2i}[t] + \sum_{i=0}^{\ell/2-1} t^{2i}[t] \otimes t^{\ell-1-2i} \quad \ell \text{ even}$$

Comparing with the product on the dual, we first calculate

$$HH_*(A, A^\vee, \mathbb{k}_{\neq 2}) = \mathbb{k}_{\neq 2}[2N] \oplus \bigoplus_{i \leq 0} (\mathbb{k}_{\neq 2}[-(2N-1)(2i)+1] \oplus \mathbb{k}_{\neq 2}[-(2N-1)(2i)+1])$$

with representatives for the nonzero classes given by

chains	$s_0[t]$	$s_1[t]$	s_0	$s_3[t]$	s_2	\dots	$s_{2i+1}[t]$	s_{2i}	\dots
deg	$2N$	1	0	$-4N+3$	$-4N+2$	\dots	$-(2N-1)(2i)+1$	$-(2N-1)(2i)$	\dots

The product induced on $H^*(\ker(q)) = \bigoplus_{i > -2n} HH_i(A, A^\vee; \mathbb{k}_{\neq 2})$ is then given by

$$(15) \quad \pi_H(s_k, s_\ell) = 0, \quad k, \ell \text{ even}$$

$$(16) \quad \pi_H(s_k[t], s_\ell) = -s_{k+\ell+1}, \quad k \text{ odd}, \ell \text{ even}$$

$$(17) \quad \pi_H(s_k[t], s_\ell[t]) = s_{k+\ell+1}[t], \quad k, \ell \text{ odd}$$

which as expected from Theorem 1.5, is commutative and associative.

Comparing the coproduct Δ_H with this product, we check that these operations satisfy the compatibility relation predicted by Proposition 6.8, and as a consequence Δ_H is cocommutative and coassociative, which can also be checked directly. As we are over a field, the homology operations Δ_H and π_H contain exactly the same information. Comparing to the product π on $HH_*(A, \mathbb{k}_{\neq 2})$, we also see that Sullivan's relation is satisfied, as expected from Theorem 3.14.

7.2.5. Over a field of characteristic 2. Over the field $\mathbb{k} = \mathbb{k}_2$, basically the same description as above holds, except that for every $i \geq 0$ we have extra nonzero classes $t^{2i+1}[t] \in HH_*(A, \mathbb{k}_2)$, which get mapped to nonzero classes ∂^{2i} . On the dual, we have two extra families of nonzero classes, represented by s_{2i+1} and $s_{2i+2}[t]$, for $i \geq 0$.

Another difference is that $E = 0$, so we do not need to worry about quotienting out by some W ; we get a coproduct

$$\Delta_H(t^k) = \sum_{i=1}^k t^{i-1} \otimes t^{k-i}$$

$$\Delta_H(t^k[t]) = \sum_{i=1}^k t^{i-1} \otimes t^{k-i}[t] + t^{i-1}[t] \otimes t^{k-i}.$$

This coproduct is dual to the product on $HH_*(A, A^\vee; \mathbb{k}_2)$, for any $k, \ell \geq 0$

$$(18) \quad \pi_H(s_k, s_\ell) = 0$$

$$(19) \quad \pi_H(s_k[t], s_\ell) = s_{k+\ell+1}$$

$$(20) \quad \pi_H(s_k[t], s_\ell[t]) = s_{k+\ell+1}[t]$$

and as a consequence, Δ_H is again cocommutative and coassociative.

7.2.6. Interaction with torsion classes for integer coefficients. Let us now return to coefficients $R = \mathbb{k}$. The chain-level coproduct Δ_H is a map of complexes and gives a map on homology:

$$\Delta_H : HH_*(A, A)/2\mathbb{Z} \rightarrow H_*(C_*(A, A)/2\mathbb{Z} \otimes C_*(A, A)/2\mathbb{Z})[-2N + 1]$$

Unlike what we had for field coefficients, the target of this map is not isomorphic to $HH_*(A, \mathbb{Z})/2\mathbb{Z} \otimes HH_*(A, \mathbb{Z})/2\mathbb{Z}$; recall the Künneth short exact sequence for the tensor product $C_*(A, A)/2\mathbb{Z} \otimes_{\mathbb{Z}} C_*(A, A)/2\mathbb{Z}$:

$$\bigoplus_{a+b=k} \frac{HH_a(A, A)}{2\mathbb{Z}} \otimes \frac{HH_b(A, A)}{2\mathbb{Z}} \rightarrow H_k \left(\frac{C_*(A, A)}{2\mathbb{Z}} \otimes \frac{C_*(A, A)}{2\mathbb{Z}} \right) \rightarrow \bigoplus_{a+b=k-1} \text{Tor}_1^{\mathbb{Z}} \left(\frac{HH_a(A, A)}{2\mathbb{Z}}, \frac{HH_b(A, A)}{2\mathbb{Z}} \right)$$

The third term is nonzero when the degrees are both even multiples of $(2N - 1)$, say $a = 2i(2N - 1)$, $b = 2j(2N - 1)$, in which case the Tor group contributes a $\mathbb{Z}/2$ summand; let us denote the corresponding 2-torsion class by $\gamma_{i,j}$, with degree $(2i + 2j)(2N - 1) + 1$. We can choose the following representatives for these classes

$$\gamma_{i,j} := t^{2i} \otimes t^{2j-1}[t] - t^{2i-1}[t] \otimes t^{2j}, \quad \text{for } i \geq 0, j \geq 1$$

Note that the classes $\gamma_{i,j}$ for $i \geq 1$ are exactly the differences that appear in the expression for the chain-level $\Delta(t^\ell[t])$, and that represented the zero class when working over $\mathbb{k}_{\neq 2}$. With the notation, the coproduct

$$\Delta : HH_*(A, A) \rightarrow H_{*-2N+1} \left(\frac{C_*(A, A)}{2\mathbb{Z}} \otimes \frac{C_*(A, A)}{2\mathbb{Z}} \right)$$

is given by

$$\begin{aligned}\Delta(t^k) &= \sum_{i=1}^k (-1)^{i-1} t^{i-1} \otimes t^{k-i} && \text{any } k \\ \Delta(t^\ell[t]) &= -\sum_{i=1}^{\ell/2} t^{2i-1} \otimes t^{\ell-2i}[t] + \sum_{i=0}^{\ell/2-1} t^{2i}[t] \otimes t^{\ell-1-2i} + \sum_{i=0}^{\ell/2-1} \gamma_{i,\ell/2-i} && \ell \text{ even}\end{aligned}$$

Therefore, from these calculations it becomes clear that the coproduct Δ_H ‘reaches’ the 2-torsion classes. The calculation of the product π_H is identical to the one in Section 7.2.4; therefore, as we pointed out in Remark 6.9, over \mathbb{Z} the coproduct Δ_H has strictly more information than its dual produce π_H .

7.3. The 2-sphere. The case of the 2-sphere is of particular interest; it is basically identical to the case of spheres of even dimension $2N \geq 4$, with the sole difference that here we have a nontrivial space of choices for the partial trivialization H , so the coproduct is not necessarily uniquely defined.

The space of choices for H , that is, $C_0(A, A) \otimes C_1(A, A) \oplus C_1(A, A) \otimes C_0(A, A)$ is rank two; we write any H as

$$H = c_+ \cdot 1 \otimes t + c_- \cdot t \otimes 1$$

for scalars $c_+, c_- \in \mathbb{k}$. The corresponding correction to the chain-level coproduct is only nontrivial on $\Delta(t^k[t])$, for even k :

$$\begin{aligned}\Delta_H(t^k[t]) &= \sum_{i=1}^k (-1)^{i+1} (t^{i-1} \otimes t^{k-i}[t] + t^{i-1}[t] \otimes t^{k-i}) \\ &\quad + c_+(t^k \otimes t + 1 \otimes t^{k+1}) + c_-(t^{k+1} \otimes 1 + t^k \otimes t)\end{aligned}$$

We see that Δ_H is cocommutative when H is symmetric, as expected from Theorem 1.5.

Let us analyze the corresponding coproduct on $HH_*(A, \mathbb{k})/2\mathbb{k}$ for different coefficients \mathbb{k} . Over a field $\mathbb{k}_{\neq 2}$ of characteristic $\neq 2$, the correction vanishes, since the classes represented by t^{even} are zero, so the coproduct Δ_H does not depend on H and is always coassociative. Over \mathbb{Z} , the correction $c_+(t^k \otimes t + 1 \otimes t^{k+1}) + c_-(t^{k+1} \otimes 1 + t^k \otimes t)$ represents a 2-torsion class in $HH_*(A, \mathbb{Z})/2\mathbb{Z}$, and is nontrivial for every ≥ 1 ; still, the pair π, Δ_H satisfies Sullivan’s relation.

7.3.1. Failure of coassociativity over a field of characteristic 2. The most interesting case is over a field \mathbb{k}_2 of characteristic two: assuming H skew-symmetric there are only two choices for H , namely $H_0 = 0$ and $H_1 = 1 \otimes t + 1 \otimes t$. The coproducts only differ when evaluated on $t^k[t]$ for any $k \geq 1$:

$$\begin{aligned}\Delta_{H_0}(t^k[t]) &= \sum_{i=1}^k (t^{i-1} \otimes t^{k-i}[t] + t^{i-1}[t] \otimes t^{k-i}) \\ \Delta_{H_1}(t^k[t]) &= \sum_{i=1}^k (t^{i-1} \otimes t^{k-i}[t] + t^{i-1}[t] \otimes t^{k-i}) + t^k \otimes t + 1 \otimes t^{k+1} + t^{k+1} \otimes 1 + t^k \otimes t\end{aligned}$$

Both of these coproducts, together with the product π , satisfy Sullivan’s relation, as expected from Theorem 3.14. We see that the coproduct Δ_{H_0} is coassociative, but the coproduct Δ_{H_1} is not. For example, evaluating on $t[t]$ we get

$$\begin{aligned}\Delta_{H_1}(\Delta_{H_1}(t[t])') \otimes \Delta_{H_1}(t[t])' &= 1 \otimes t \otimes 1 + t \otimes 1 \otimes 1, \\ \Delta_{H_1}(t[t])' \otimes \Delta_{H_1}(\Delta_{H_1}(t[t])'') &= 1 \otimes 1 \otimes t + 1 \otimes t \otimes 1\end{aligned}$$

which represent different classes in $HH_*(A, \mathbb{k}_2)$. As a corollary, we conclude that there is no automorphism of the coalgebra $HH_*(A, \mathbb{k}_2)$ intertwining these coproducts, and they are genuinely different. Note that the failure of coassociativity does not contradict Theorem 1.5, since we are not in the dimension range covered by that result.

Remark 7.3. We believe that this discrepancy between the existence of two coproducts is somehow related to the two distinct BV algebra structures on $H_*(LS^2, \mathbb{F}_2)$ found by Menichi [Men09]; see also [PT23] for a very recent perspective and explanation. In our language of CY structures, we think that the difference between the two BV algebras comes from the choice of different lifts to negative cyclic chains. Though we have not explored that circle action in this paper, we believe that there is some relation between the space of choices of trivialization H and the space of negative cyclic lifts; the two different BV algebra structures would then be related to the two nonequivalent coproducts above. We leave these question for future investigations.

7.4. The circle. Let us now describe the example of the circle, which resembles the example of higher-dimensional odd spheres, but is more complicated due to a large space of choices of trivializations. For now, let \mathbb{k} be any ring, and we take $A = \mathbb{k}[t^{\pm 1}]$, with $\deg t = 0$, which is the homology algebra $H_*(\Omega S^1)$. Its Hochschild homology is the homology of free loop space

$$HH_*(A, A) = \mathbb{k}[\mathbb{Z}] \oplus \mathbb{k}[\mathbb{Z}][1],$$

We pick representatives for the nonzero classes to be t^k , in degree zero, and $t^k[t]$ in degree 1. As for Hochschild cohomology, we have classes ∂^k and $\sum_i is_i \partial^{i+k}$, in degrees zero and -1 , respectively. All these classes are nonzero in (co)homology for any $k \in \mathbb{Z}$.

7.4.1. The maps G and $\tilde{\Delta}_H$. We can pick representatives for the bimodule A^1 exactly as in the case of Section 7.1 (taking $n = 0$) and the vertex co to be given by the same formula. On the other hand, η has to be modified to account for the negative powers of t :

$$\eta([t^m], t^n; R^{k,\ell}) = -\chi_{1 \leq m} \sum_{i=1}^m t^{\ell+i-1} \otimes t^{k+n+m-i} + \chi_{m \leq -1} \sum_{i=m+1}^0 t^{\ell+i-1} \otimes t^{k+n+m-i}$$

We calculate that $E = 0$, as expected. Calculating the map G we now have

$$\begin{aligned} G(\partial_k) &= \chi_{1 \leq k} \sum_{i=1}^k (t^{i-1} \otimes t^{k-i}[t] - t^{i-1}[t] \otimes t^{k-i}) - \chi_{k \leq -1} \sum_{i=k+1}^0 (t^{i-1} \otimes t^{k-i}[t] - t^{i+1}[t] \otimes t^{k-i}) \\ G\left(\sum_i is_i \partial^{i+k}\right) &= -\chi_{0 \leq k} \sum_{i=1}^{k+1} t^{i-1} \otimes t^{k+1-i} + \chi_{k \leq -2} \sum_{i=k+2}^0 t^{i-1} \otimes t^{k+1-i} \end{aligned}$$

Though $E = 0$ already at the chain-level, we are free to pick a trivialization H with $dH = 0$, that is, a closed element of degree -1 in $C_*(A, A) \otimes C_*(A, A)$. We write H as

$$H = \sum_{p,q \in \mathbb{Z} \oplus \mathbb{Z}} a_{p,q} t^p \otimes t^q[t] + b_{p,q} t^p[t] \otimes t^q$$

where only finitely many of the $a_{p,q}, b_{p,q}$ are nonzero.

7.4.2. The CY structure and the chain-level coproduct. There are multiple nonequivalent CY structures on the algebra A . Here we will use one that is of special importance for derived symplectic geometry; see [BCS22; BCS23] for a discussion of its relation to quasi-hamiltonian quotients.

We pick the Hochschild chain $\omega = t^{-1}[t] \in C_1(A, A)$ which is non-degenerate; this induces a map $HH^*(A, A) \rightarrow HH_*(A, A)[-1]$ given on our representatives by

$$\sum_i is_i \partial^{i+k} \mapsto t^k, \quad \partial^k \mapsto t^{k-1}[t]$$

for every $k \in \mathbb{Z}$. It turns out that the chain-level inverse g_α , with $\alpha \in C_{(2)}^1(A)$ skewsymmetric (as required for a pre-CY structure) only exists if 2 is a unit in \mathbb{k} . For now, just using the homology-level inverse of the map above (which exists for any \mathbb{k}) we can calculate the coproduct

on homology, for each choice of H as above:

$$\begin{aligned}\Delta_H(t^k[t]) &= \chi_{0 \leq k} \sum_{i=1}^{k+1} (t^{i-1} \otimes t^{k+1-i}[t] - t^{i-1}[t] \otimes t^{k+1-i}) - \chi_{k \leq -2} \sum_{i=k+2}^0 (t^{i-1} \otimes t^{k+1-i}[t] - t^{i+1}[t] \otimes t^{k+1-i}) \\ &\quad + \sum_{p,q \in \mathbb{Z} \oplus \mathbb{Z}} a_{p,q} (t^p[t] \otimes t^{q+k+1} - t^p \otimes t^{q+k+1}[t]) - b_{p,q} (t^{p+k+1}[t] \otimes t^q - t^{p+k+1} \otimes t^q[t]) \\ \Delta_H(t^k) &= \chi_{0 \leq k} \sum_{i=1}^{k+1} t^{i-1} \otimes t^{k+1-i} - \chi_{k \leq -2} \sum_{i=k+2}^0 t^{i-1} \otimes t^{k+1-i} \\ &\quad + \sum_{p,q \in \mathbb{Z} \oplus \mathbb{Z}} a_{p,q} t^p \otimes t^{q+k+1} - b_{p,q} t^{p+k+1} \otimes t^q\end{aligned}$$

Every monomial in the expressions above represents a class in $HH_*(A, A)$, so we can directly read the coproduct induced in homology. We reiterate that for any choice of H , the coproduct above, together with the product π , satisfies Sullivan's relation. As expected, if H is skew-symmetric, meaning $a_{p,q} = -b_{q,p}$, then the coproduct is skew-commutative, as expected. Even if we restrict attention to symmetric choices for H , there is still a very large family of nonequivalent coproducts, generically not coassociative, as expected since $n = 1 < 3$. We single out two choices of a, b that lead to particularly nice coproducts.

If $H = 0$, then the product obtained is moreover coassociative, and the pair (π, Δ_0) endows $HH_*(A, A)[-1]$ with the structure of an infinitesimal bialgebra. Comparing with the notation used in [CHO23, Subsection 8.3], we can identify $t^{k-1} \leftrightarrow AU^k, t^{k-1}[t] \leftrightarrow U^k$ (note the shift with respect to the case of higher-dimensional odd spheres) which gives the coproduct

$$\begin{aligned}\Delta_0(U^k) &= \chi_{1 \leq k} \sum_{i=1}^k (AU^i \otimes U^{k-i+1} - U^i \otimes AU^{k-i+1}) - \chi_{k \leq -1} \sum_{i=k+1}^0 (AU^i \otimes U^{k-i+1} - U^i \otimes AU^{k-i+1}) \\ \Delta_0(AU^k) &= \chi_{1 \leq k} \sum_{i=1}^k AU^i \otimes AU^{k-i+1} - \chi_{k \leq -1} \sum_{i=k+1}^0 AU^i \otimes AU^{k-i+1}\end{aligned}$$

We note the partial similarity of this coproduct with the coproducts on $H_*(LS^1)$ found using Floer-theoretic approaches in [CHO23]. More specifically, the coproduct Δ_0 above is a version of the coproduct denoted λ_{v_-, v_-} of Remark 8.8 in [CHO23] with a shift in k , that satisfies cocommutativity, coassociativity and Sullivan's relation.

Another particularly nice choice for H is $a_{-1,0} = -b_{0,-1} = 1$ with all other $a_{p,q}, b_{p,q}$ zero; that is, $H = t^{-1} \otimes 1[t] - 1[t] \otimes t^{-1}$. Again using the notation U^k, AU^k , we get the coproduct

$$\begin{aligned}\Delta_H(U^k) &= \chi_{1 \leq k} \sum_{i=0}^{k+1} (AU^i \otimes U^{k-i+1} - U^i \otimes AU^{k-i+1}) - \chi_{k \leq -1} \sum_{i=k+2}^{-1} (AU^i \otimes U^{k-i+1} - U^i \otimes AU^{k-i+1}) \\ \Delta_H(AU^k) &= \chi_{1 \leq k} \sum_{i=0}^{k+1} AU^i \otimes AU^{k-i+1} - \chi_{k \leq -1} \sum_{i=k+2}^{-1} AU^i \otimes AU^{k-i+1}\end{aligned}$$

which is cocommutative, satisfies Sullivan's relation with respect to π , but is not coassociative. This coproduct again is a shifted version of the coproduct denoted λ_{v_+, v_+} of *op.cit.*

Remark 7.4. We do not really understand the geometric significance of the coproducts we calculated above; that would require an investigation about how the choice of H is related to the choice of vector field that leads to all these different coproducts.

7.4.3. *The pre-CY structure and the cone bimodule.* Let us work over a field $\mathbb{k}_{\neq 2}$ of characteristic $\neq 2$. We give an explicit inverse α to ω , defined by the formulas

$$\begin{aligned} \alpha(t^k, \emptyset) &= \chi_{1 \leq k} \left(\frac{1}{2}(1 \otimes t^k + t^k \otimes 1) - \sum_{1 \leq i \leq k-1} t^i \otimes t^{k-i} \right) \\ &\quad + \chi_{k \leq -1} \left(\frac{1}{2}(1 \otimes t^k + t^k \otimes 1) + \sum_{k+1 \leq i \leq -1} t^i \otimes t^{k-i} \right) \end{aligned}$$

and $\alpha(\emptyset, t^k) = -\alpha(t^k, \emptyset)$, using the same notation from the proof of Proposition 7.1. One can check that this gives a closed element of $C_{(2)}^*(A)$, skewsymmetric and inverse to ω . In order to extend this to a full pre-CY structure, we also need an element with three outputs and zero inputs; by an explicit calculation we verify:

Proposition 7.5. *Taking $m = \mu + \alpha + \tau$, where $\tau = \frac{1}{4}(1 \otimes 1 \otimes 1)$, gives a pre-CY structure of dimension 1 on A .*

7.4.4. *Product on the cone.* We again denote s_k for the element of A^\vee dual to t^k , for $k \in \mathbb{Z}$; all these elements are of degree zero. We calculate the map f_α :

$$\begin{aligned} f_\alpha(s_k \otimes t^\ell) &= -\chi_{1 \leq \ell} \left(\frac{1}{2}\delta_k + \frac{1}{2}\delta_{k-\ell} + \chi_{1 \leq k \leq \ell-1} \right) t^{\ell-k} + \chi_{\ell \leq -1} \left(\frac{1}{2}\delta_k t^\ell + \frac{1}{2}\delta_{k-\ell} + \chi_{\ell+1 \leq k \leq -1} \right) t^{\ell-k} \\ f_\alpha(t^\ell \otimes s_k) &= +\chi_{1 \leq \ell} \left(\frac{1}{2}\delta_k + \frac{1}{2}\delta_{k-\ell} + \chi_{1 \leq k \leq \ell-1} \right) t^{\ell-k} - \chi_{\ell \leq -1} \left(\frac{1}{2}\delta_k t^\ell + \frac{1}{2}\delta_{k-\ell} + \chi_{\ell+1 \leq k \leq -1} \right) t^{\ell-k} \end{aligned}$$

and the map induced on Hochschild chains is

$$\begin{aligned} F_\alpha(s_k[t^{k_1} | \dots | t^{k_p}]) &= -\chi_{1 \leq k_1} \left(\frac{1}{2}\delta_k + \frac{1}{2}\delta_{k-k_1} + \chi_{1 \leq k \leq k_1-1} \right) t^{k_1-k}[t^{k_2} | \dots | t^{k_p}] \\ &\quad + \chi_{k_1 \leq -1} \left(\frac{1}{2}\delta_k + \frac{1}{2}\delta_{k-k_1} + \chi_{k_1+1 \leq k \leq -1} \right) t^{k_1-k}[t^{k_2} | \dots | t^{k_p}] \\ &\quad + (-1)^{p-1} \chi_{1 \leq k_p} \left(\frac{1}{2}\delta_k + \frac{1}{2}\delta_{k-k_p} + \chi_{1 \leq k \leq k_p-1} \right) t^{k_p-k}[t^{k_1} | \dots | t^{k_{p-1}}] \\ &\quad - (-1)^{p-1} \chi_{k_p \leq -1} \left(\frac{1}{2}\delta_k + \frac{1}{2}\delta_{k-k_p} + \chi_{k_p+1 \leq k \leq -1} \right) t^{k_p-k}[t^{k_1} | \dots | t^{k_{p-1}}] \end{aligned}$$

We know that the cohomology of the complex $C_*(A, A^\vee[1])$ is supported in degrees 0 and 1, with a partial basis $\mathbb{1}$ given by the classes s_k and $s_k[t]$, and the cohomology of $C_*(A, A)$ is concentrated in homological degrees 1 and 0; therefore the only nontrivial component of F_α on cohomology can be in degree zero, which we calculate to be zero. Therefore, again we know that there must be a homotopy between F_α and the zero map.

We follow the same steps as in the case of higher-dimensional odd spheres, and obtain an expression for the product π on the cone $C_*(A, A^\vee) \oplus C_*(A, A)$. The expressions get rather complicated, so let us just write the terms we will need. Let us denote $p : C_*(A, A^\vee) \oplus$

$\mathbb{1}$ note that as a vector space each one of $HH_{0,1}(A, A^\vee[1])$ is the algebraic dual vector space $k[\mathbb{Z}]^\vee$

$C_*(A, A^\vee) \rightarrow C_*(A, A^\vee)$ for the connecting map from the cone.

$$\pi(t^k[t], t^\ell) = -t^{k+\ell+1}$$

$$\pi(t^k[t], t^\ell[t]) = t^{k+\ell+1}[t]$$

$$p\pi(s_k[t], t^\ell) = -s_{k-\ell-1}$$

$$p\pi(s_k, t^\ell[t]) = s_{k-\ell-1}$$

$$p\pi(s_k[t], t^\ell[t]) = s_{k-\ell-1}[t]$$

$$\begin{aligned} p\pi(s_k[t], s_\ell) = & \left(-\frac{1}{4}\delta_{k-1}\chi_{1 \leq \ell} + \frac{1}{4}\delta_{k-1}\chi_{\ell \leq -1} - \frac{1}{4}\chi_{2 \leq k}\delta_\ell + \frac{1}{4}\chi_{k \leq 0}\delta_\ell - \frac{1}{2}\chi_{2 \leq k}\chi_{1 \leq \ell} + \frac{1}{2}\chi_{k \leq 0}\chi_{\ell \leq -1} \right. \\ & - \frac{1}{4}\delta_k\chi_{2 \leq \ell} + \frac{1}{4}\delta_k\chi_{\ell \leq 0} - \frac{1}{4}\chi_{1 \leq k}\delta_{\ell-1} + \frac{1}{4}\chi_{k \leq -1}\delta_{\ell-1} - \frac{1}{2}\chi_{1 \leq k}\chi_{2 \leq \ell} + \frac{1}{2}\chi_{k \leq -1}\chi_{\ell \leq 0} \\ & \left. - \frac{1}{4}(\delta_k + \delta_{k-1} + \delta_\ell + \delta_{\ell-1}) \right) s_{k+\ell-1} \end{aligned}$$

$$p\pi(s_k[t], s_\ell[t]) = (-p\pi(s_k[t], s_\ell))[t]$$

again with the other terms either determined by skew-commutativity, or zero otherwise. The calculation with two inputs in $C_*(A, A^\vee)$ is rather involved, and many diagrams contribute. In order to understand the last two expressions, we can simplify them into table form as

$$p\pi(s_k[t], s_\ell) = \begin{array}{c|c|c|c} 1 \leq \ell & 0 & -1/2 & -1 \\ \hline \ell = 0 & 1/2 & 0 & -1/2 \\ \hline \ell \leq -1 & 1 & 1/2 & 0 \\ \hline \hline k \leq -1 & k = 0 & 1 \leq k & \end{array} \times s_{k+\ell-1}$$

$$p\pi(s_k[t], s_\ell[t]) = \begin{array}{c|c|c|c} 1 \leq \ell & 0 & 1/2 & 1 \\ \hline \ell = 0 & -1/2 & 0 & 1/2 \\ \hline \ell \leq -1 & -1 & -1/2 & 0 \\ \hline \hline k \leq -1 & k = 0 & 1 \leq k & \end{array} \times s_{k+\ell-1}$$

7.4.5. Difference between homotopies and trivializations. We would like to use this example to illustrate the following fact: when $HH_*(A, A)$ is infinite-rank in some degree (as it is the case here), there are more homotopies h of the morphism F_α than trivializations H of the canonical element E , even if we know that the maps $\sharp E \circ g_\alpha^{A^\vee}$ and F_α are homotopic. In other words, not every homotopy h of F_α is equivalent to one that comes as $\sharp H$, that is, from pairing with some trivialization H of E .

For example, the simplest homotopy that we can write down for the map F_α above is the map $h : C_*(A, A^\vee) \rightarrow C_*(A, A)$ given by

$$h(s_k[t^{k_1} | \dots | t^{k_p}]) = \left(\frac{1}{2}\delta_k + \chi_{1 \leq k} \right) t^{-k}[t^{k_1} | \dots | t^{k_p}]$$

If we now compute the resulting product π_h on $C_*(A, A^\vee)$, for instance on $(s_k[t], s_\ell)$, the extra terms $p\pi(h(s_k[t]), s_\ell)$ and $p\pi(s_k[t], h(s_\ell))$ add $1/2$ and 1 to some rows and columns of the table above, and we get that

$$\pi_h(s_k[t], s_\ell) = s_{k+\ell-1}$$

for all values of k, ℓ . We see that this product π_h on $HH_*(A, A^\vee)$ is not the dual to any coproduct on $HH_*(A, A)$: for any integer j , there are infinitely many k, ℓ for which $\pi_h(s_k[t], s_\ell) = s_j$, namely, all the pairs with $k + \ell = j + 1$. This will be the generic behavior for a homotopy of the map f_α .

APPENDIX A. EXPLICIT DIAGRAMS

We left some of the more complicated combinations diagrams out of the main body of the text for clarity.

A.1. Conventions. In order to simplify the notation, we will make some conventions. For some of the proofs, it is unnecessary to specify signs. For example, to prove a quasi-isomorphism between complexes given by the cones of two maps, it is enough to find a homotopy between those maps up to an overall sign. For the proofs where the signs are important, following the discussion in Section 2.1.3, we can give a sign by

- (1) giving a total ordering of the edges,
- (2) giving a total ordering of the vertices where we are going to input the copies of $\alpha \in C_{(2)}^{r*}(A)$.
- (3) for each vertex with two or more outgoing arrows, specifying one of them to be the first arrow.

We specify 1. by labeling the edges from 1 to N where N is the number of edges, and always using the ordering $(e_N \dots e_1)$. We specify 2. by numbering the circles where each copy of α will be placed, and 3 by a white arrowhead.

The statements in this paper are phrased for A_∞ -structures, but in all examples of our interest in this paper, we simply have dg structures (that is, an A_∞ -structure with $\mu^{\geq 3} = 0$). For the sake of simplicity, when giving a combination of diagrams, we will omit terms that are zero for dg-structures. For example, we will omit homotopies such as

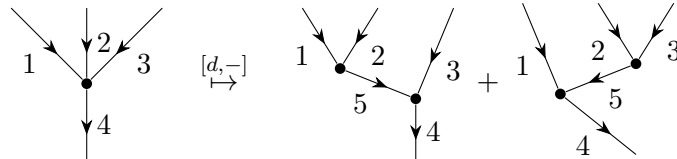

and instead just identify two diagrams that differ by something like the two terms on the right hand side with a minus sign. Similarly, we will omit diagrams where the evaluation vertex ev receives more than one factor of A .

A.2. Diagrams for infinitesimal bialgebra relation. We start by giving an explicit expression for the homotopy realizing the compatibility between G and the cup product, which appeared in the proof of Lemma 3.13. Each of the following diagrams lives on the elbow (as in Definition 3.3) but for ease of visualization we cut along the bottom of the elbow from one boundary component to the other.

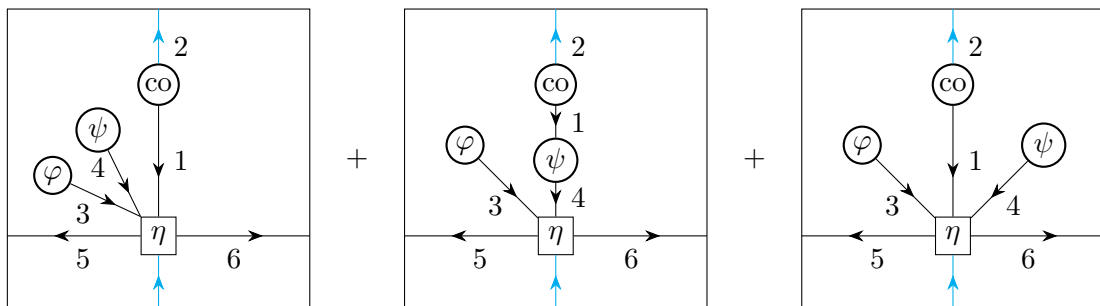

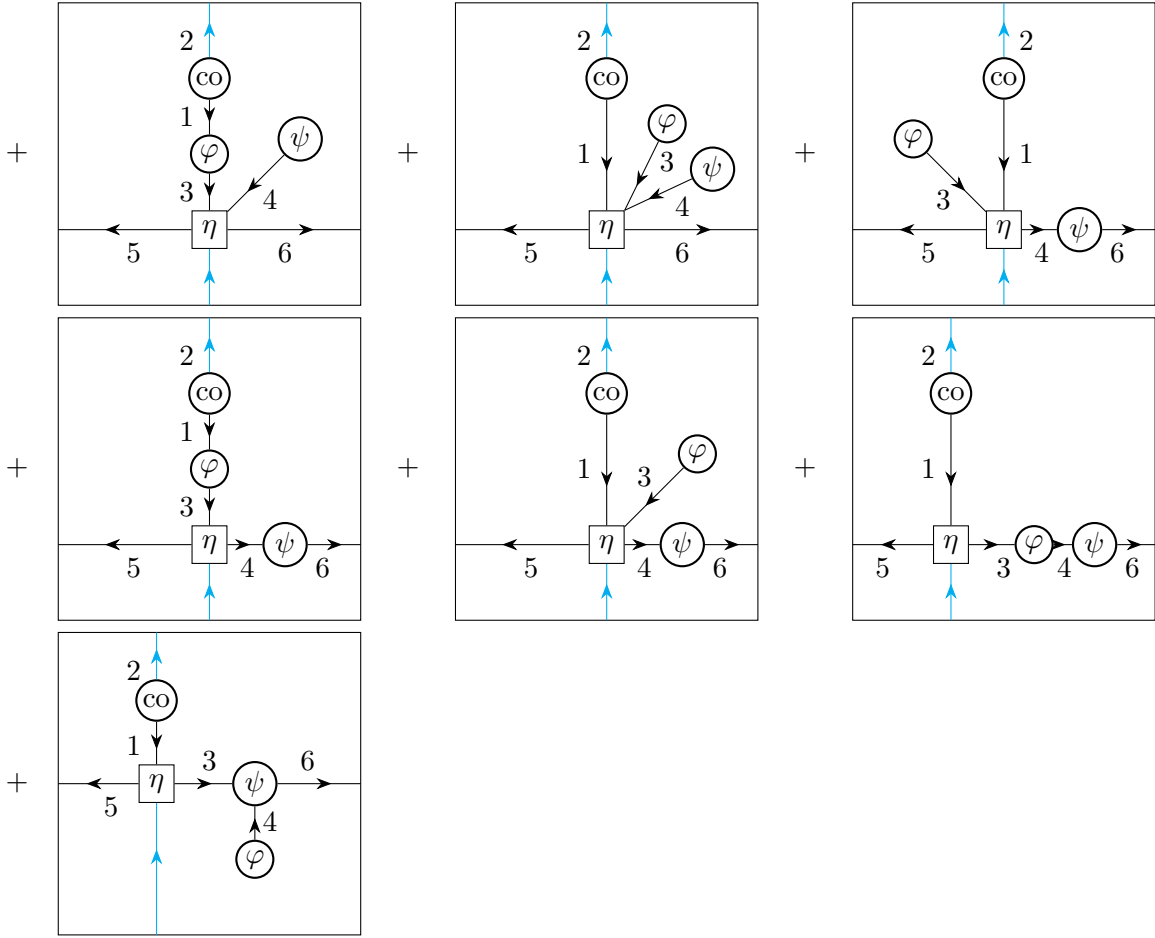

A.3. Diagrams related to \widehat{A}_∞ . Here we give two homotopies that were omitted from Section 4. For both of these cases, we can work without specifying signs, because the relevant statements, quasi-isomorphisms of cones, is independent of an overall sign, and also because the differential of each diagram will have exactly two terms, so one can always arrange the signs so that the intermediate terms cancel.

A.3.1. Homotopy relating two models for \widehat{A}_∞ . The following homotopy gives the proof of Proposition 4.4:

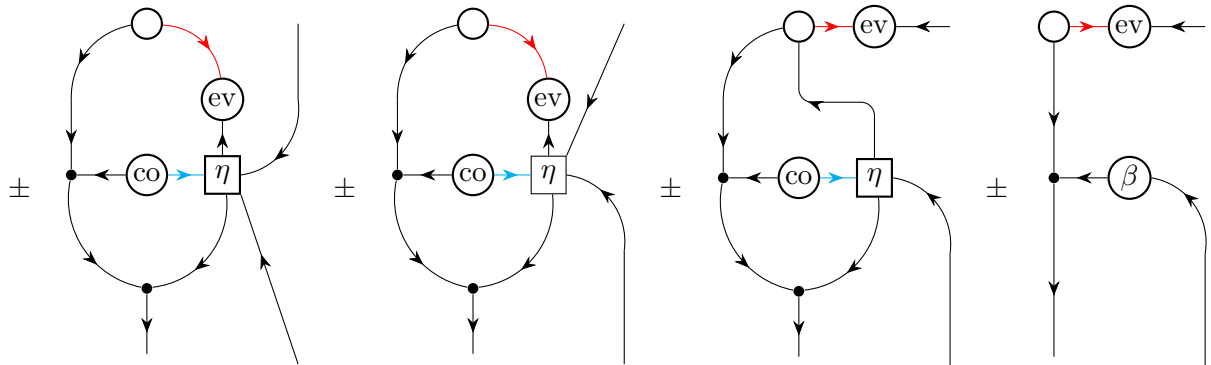

A.3.2. Homotopy relating E to map whose cone is $C_*(A, \widehat{A}_\infty)$. The following homotopy gives the proof of Theorem 4.5, relating our chain-level Chern character and the map $C^*(A, A^\vee) \rightarrow$

$C_*(A, A)$:
(21)

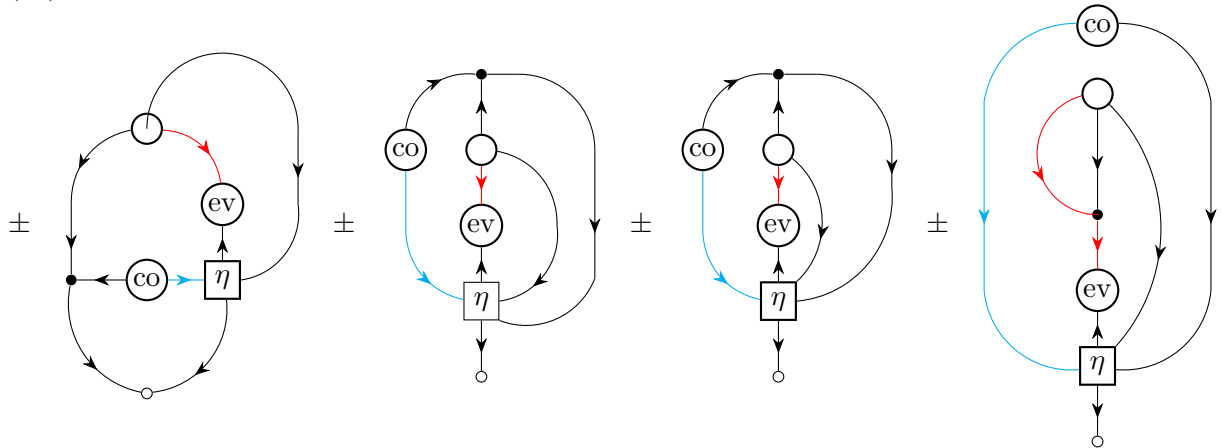

A.4. Diagrams for the cone bimodule M . Here we give some homotopies involving the cone bimodule M , which as in the text we denote with orange arrows. For some of these calculations we will need to be careful with signs, so we will include the orientation data.

A.4.1. Homotopy for associativity of product on cone. Let us make explicit the homotopy proving Proposition 5.5, that is, realizing the associativity in homology of the product π_M on $C_*(A, M)$. For this calculation we will need to be careful with signs. The expressions $\pi_M(x_1, \pi_M(x_2, x_3))$ and $\pi_M(x_1, \pi_M(x_2, x_3))$ are given respectively by evaluating the diagrams

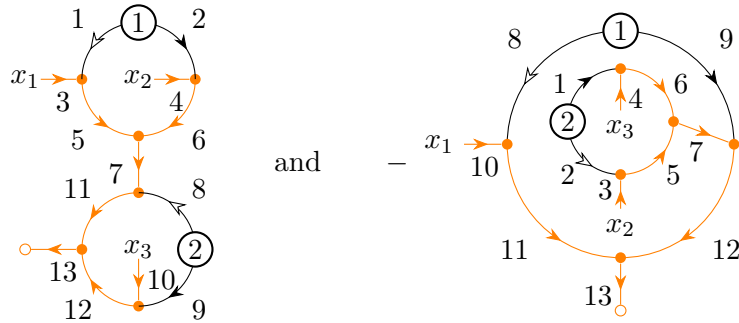

on $\alpha \otimes \alpha$; note the minus sign on the latter diagram coming from the composition rules. The homotopy between these maps $C_{(2)}^*(A)^{\otimes 2} \rightarrow C_*(A, A)$ is simply given by

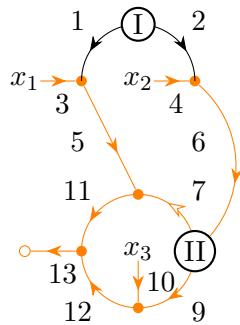

together with the diagrams involving only the μ_M vertices, that following our conventions we leave implicit. Note that we input the ψ map described in Proposition 5.3 into the vertex with one incoming factor and two outgoing factors of M . Comparing signs we get the desired associativity result.

A.4.2. Compatibility to cup product on $C^*(A, \widehat{A}_\infty)$. Now we give the two homotopies proving the claims of Proposition 5.8. For the homotopy $g_\alpha^M(\pi_M(-, -)) \simeq g_\alpha^M(-) \underset{M}{\smile} g_\alpha^M(-)$, we write

each side respectively as evaluations of the diagrams

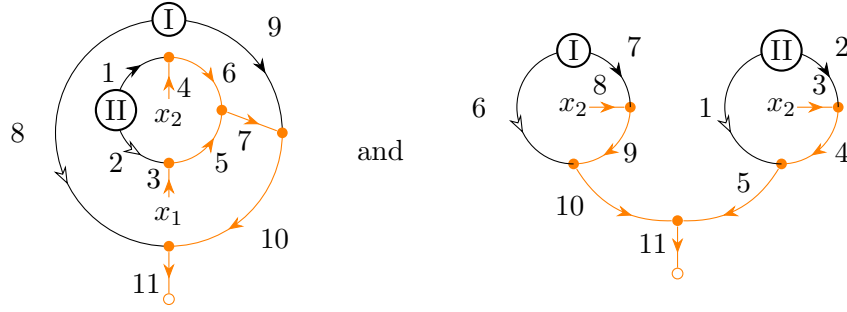

Again using our convention and omitting some of the terms, the homotopy between these maps is given by the diagram

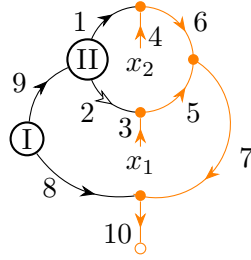

Now, for the homotopy proving the second claim, it suffices to take the diagram for $g_\alpha^M(x_1) \smile_M g_\alpha^M(x_2)$ and pass one circle over the other, using ψ :

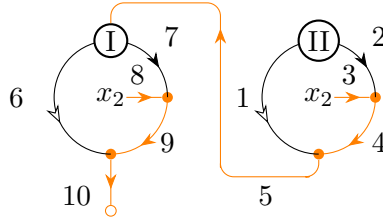

The $(-1)^n$ factor comes from comparing orientations and exchanging the two α entries, since each one of those inputs has degree $-n$ in $C_{(2)}^*(A)$.

A.5. Quasi-isomorphism between M and \widehat{A}_∞ . For this homotopy proving Proposition 5.10 we will not need signs, since we are just proving a quasi-isomorphism of cones. The map giving the composition of the left and bottom arrows, that is, $A \otimes_A^{\mathbb{L}} A^\vee[-n] \rightarrow C^*(A, A^\vee \otimes A) \rightarrow C^*(A, \text{Hom}_{\mathbb{k}}(A, A))$, and the diagram giving the composition of the top and right arrows, that is, $A \otimes_A^{\mathbb{L}} A^\vee \rightarrow A \rightarrow C^*(A, \text{Hom}_{\mathbb{k}}(A, A))$, are given respectively by the diagrams

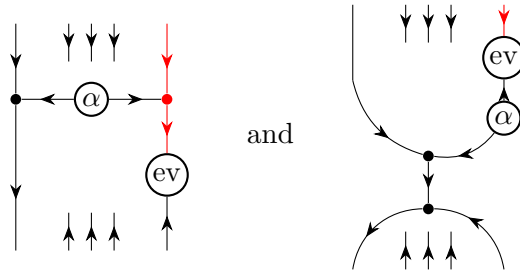

The homotopy between these diagrams is simply given by the diagram

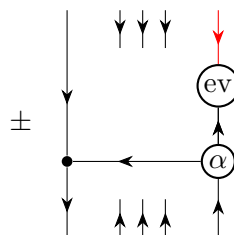

A.6. Diagrams for compatibility between products on the dual and coproducts. Here we will give the many homotopies that were omitted from Section 6. For all these homotopies we will need orientations.

A.6.1. Relation between E and D_α . Below we give the expression for a map $C_{(2)}^*(A)^{\otimes 2} \rightarrow C^*(A, A)[2n - 1]$ that, when evaluated on $\alpha \otimes \alpha$, gives the element J_α of Lemma 6.1.

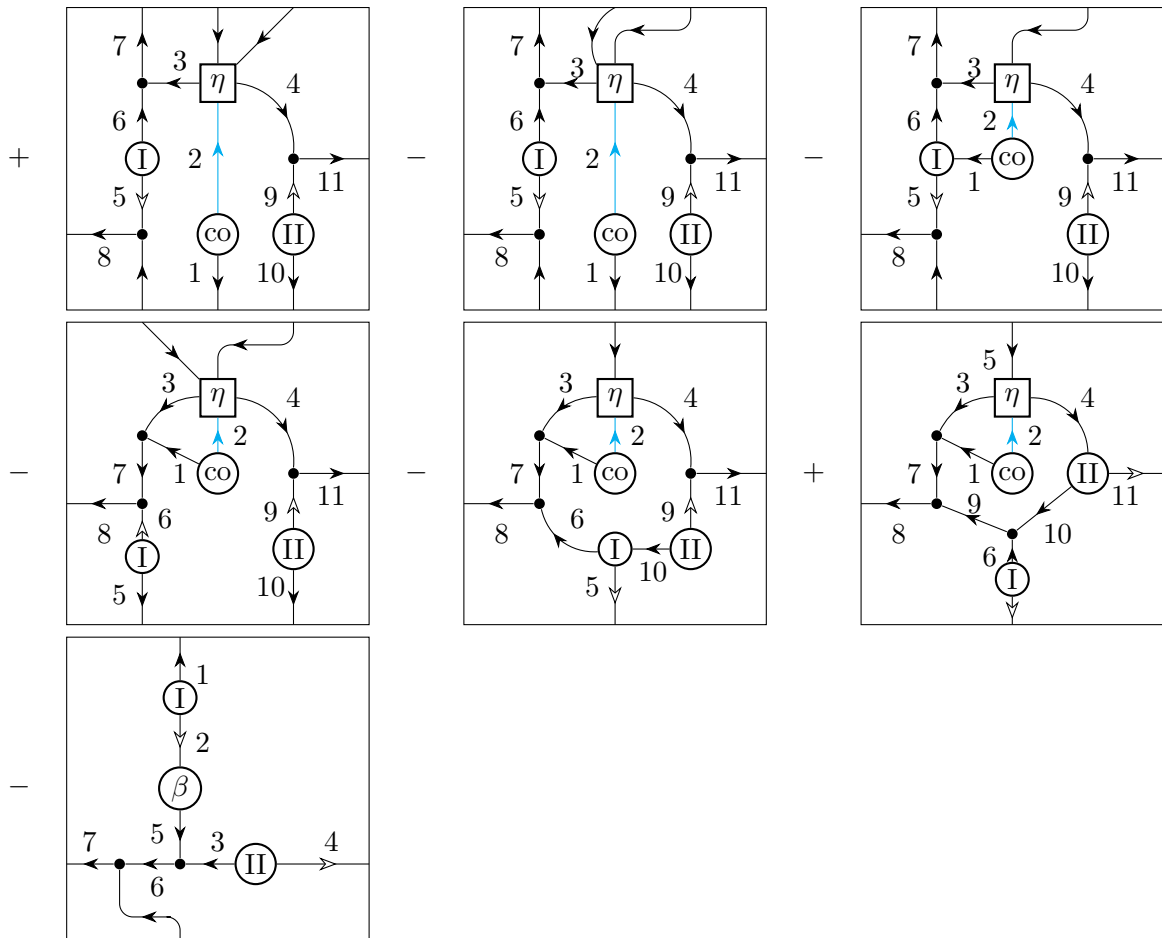

A.6.2. Homotopy for the square-filling Lemma. Here we give the combination of diagrams giving the expression for N_α in Lemma 6.4. It is rather complicated: the smallest solution we could find has no less than 53 terms. One can arrive to this solution by ‘trying to pass the φ vertex from one side to the other’ on each diagram involved in J_α , and then correcting the remaining

terms in the differential by hand, adding extra diagrams.

$$N_\alpha = +$$

+		-		-	
+		-		-	
+		-		+	
-		-		+	
+		-		-	
+		+		+	

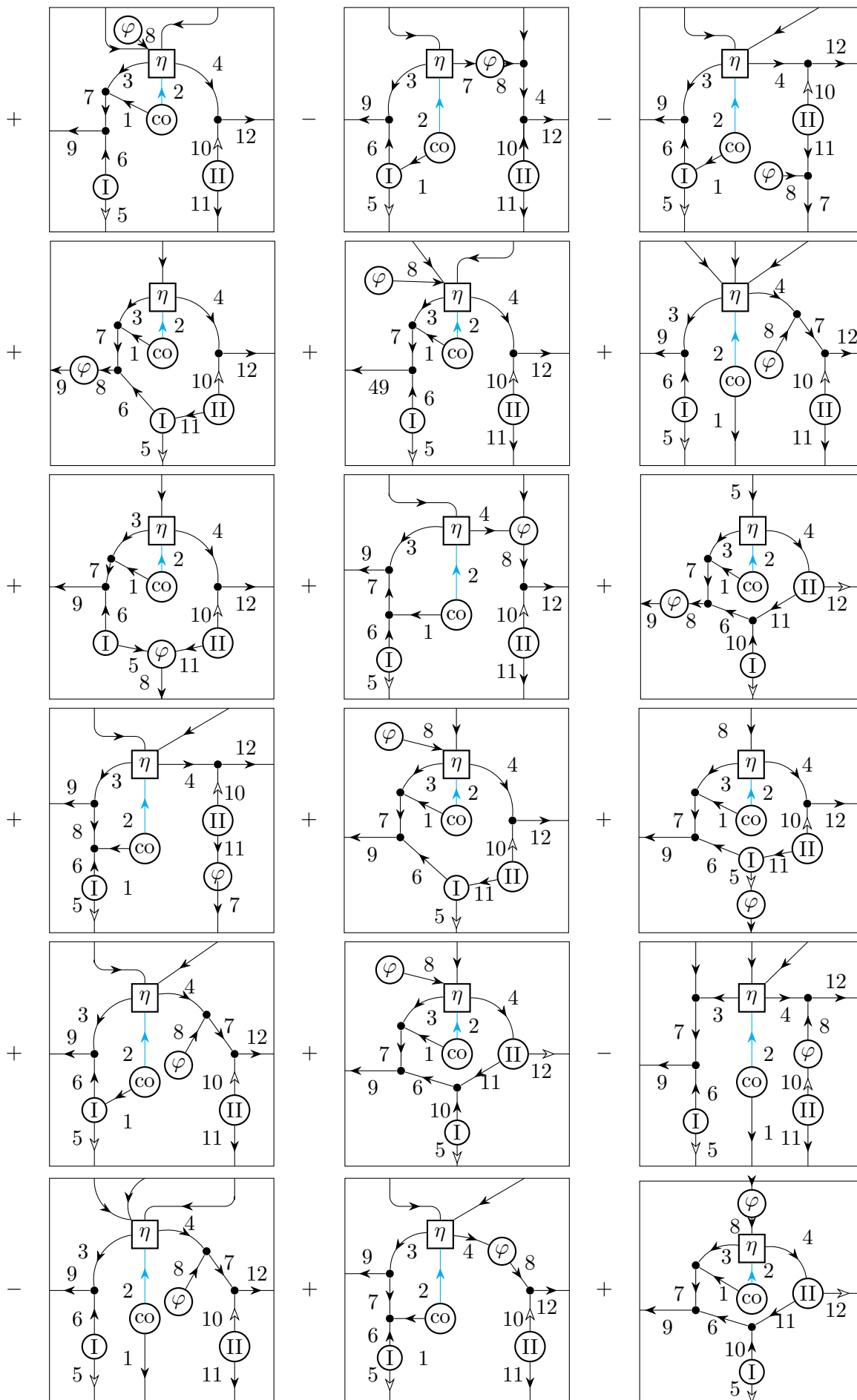

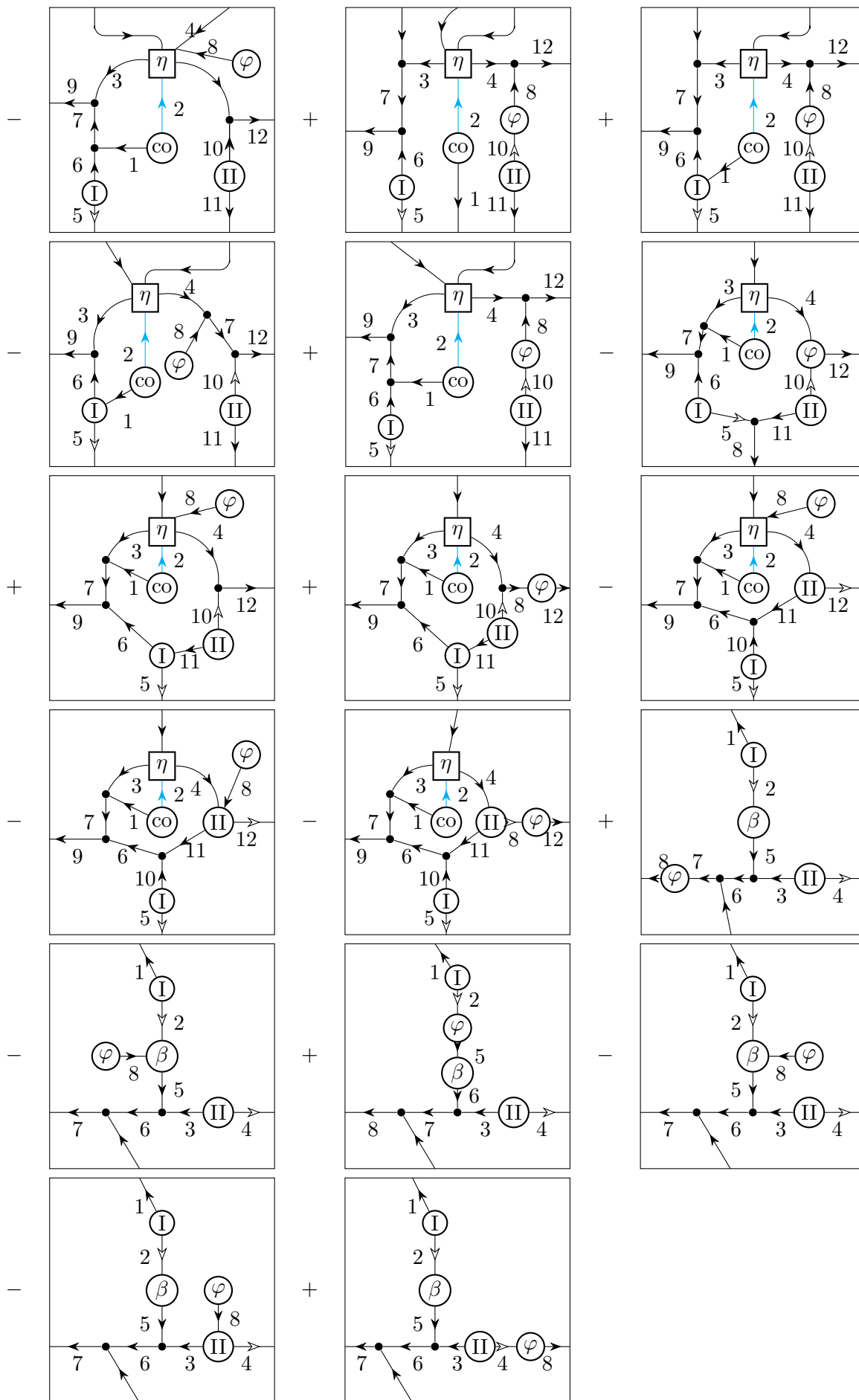

A.6.3. *Homotopies for compatibility.* Here we give the expressions that we omitted from Section 6.2. To simplify these pictures, which involve the pairing between elements in $C_*(A, A^\vee)$ and $C^*(A, A)$, we will make the abbreviation

$$\textcircled{\text{ev}_i} \leftarrow = x_i \rightarrow \textcircled{\text{ev}} \leftarrow$$

for some element $x_i \in C^*(A, A^\vee)$. \parallel

The following combination of diagrams gives a map

$$\Lambda : C_{(2)}^*(A)^{\otimes 2} \otimes C_*(A, A^\vee)^{\otimes 2} \otimes C^*(A, A) \rightarrow \mathbb{k}$$

which when evaluated on $\alpha \otimes \alpha \otimes x_1 \otimes x_2 \otimes \varphi$ gives the element $\Lambda_\alpha(x_1, x_2, \varphi)$ of Lemma 6.6:

$$\begin{aligned} \Lambda = & + \begin{array}{c} \textcircled{\text{I}} \\ \begin{array}{c} 3 \quad 4 \\ \curvearrowright \\ \text{ev}_1 \leftarrow 1 \quad \text{ev}_2 \rightarrow 2 \\ \curvearrowleft \\ 5 \quad 6 \\ \textcircled{\text{II}} \\ \uparrow 7 \\ \textcircled{\varphi} \end{array} \end{array} + \begin{array}{c} \textcircled{\text{I}} \\ \begin{array}{c} 3 \quad 4 \\ \curvearrowright \\ \text{ev}_1 \leftarrow 1 \quad \text{ev}_2 \rightarrow 2 \\ \curvearrowleft \\ 5 \quad 6 \\ \textcircled{\text{II}} \\ \uparrow 7 \\ \textcircled{\varphi} \end{array} \end{array} + \begin{array}{c} \textcircled{\text{I}} \\ \begin{array}{c} 3 \quad 4 \\ \curvearrowright \\ \text{ev}_1 \leftarrow 1 \quad \text{ev}_2 \rightarrow 2 \\ \curvearrowleft \\ 5 \quad 6 \\ \textcircled{\text{II}} \\ \uparrow 7 \\ \textcircled{\varphi} \end{array} \end{array} \\ & + \begin{array}{c} \textcircled{\text{I}} \\ \begin{array}{c} 3 \\ \curvearrowright \\ \text{ev}_1 \leftarrow 1 \quad \text{ev}_2 \rightarrow 2 \\ \curvearrowleft \\ 4 \quad 5 \\ \textcircled{\text{II}} \\ \uparrow 6 \\ \textcircled{\varphi} \end{array} \end{array} + \begin{array}{c} \textcircled{\text{I}} \\ \begin{array}{c} 4 \\ \curvearrowright \\ \text{ev}_1 \leftarrow 1 \quad \text{ev}_2 \rightarrow 2 \\ \curvearrowleft \\ 5 \quad 6 \\ \textcircled{\text{II}} \\ \uparrow 7 \\ \textcircled{\varphi} \end{array} \end{array} \\ & + \begin{array}{c} \textcircled{\text{II}} \\ \begin{array}{c} 7 \quad 4 \\ \curvearrowright \\ \text{ev}_1 \leftarrow 1 \quad \text{ev}_2 \rightarrow 2 \\ \curvearrowleft \\ 5 \quad 6 \\ \textcircled{\varphi} \\ \uparrow 2 \end{array} \end{array} - \begin{array}{c} \textcircled{\text{II}} \\ \begin{array}{c} 7 \quad 4 \\ \curvearrowright \\ \text{ev}_1 \leftarrow 1 \quad \text{ev}_2 \rightarrow 2 \\ \curvearrowleft \\ 5 \quad 6 \\ \textcircled{\varphi} \\ \uparrow 2 \end{array} \end{array} - \begin{array}{c} \textcircled{\text{II}} \\ \begin{array}{c} 4 \\ \curvearrowright \\ \text{ev}_1 \leftarrow 1 \quad \text{ev}_2 \rightarrow 2 \\ \curvearrowleft \\ 5 \quad 6 \\ \textcircled{\varphi} \\ \uparrow 7 \end{array} \end{array} \\ & + \begin{array}{c} \textcircled{\varphi} \\ \begin{array}{c} 4 \\ \curvearrowright \\ \text{ev}_1 \leftarrow 1 \quad \text{ev}_2 \rightarrow 2 \\ \curvearrowleft \\ 5 \quad 6 \\ \textcircled{\text{II}} \\ \uparrow 7 \end{array} \end{array} - \begin{array}{c} \textcircled{\text{I}} \\ \begin{array}{c} 3 \\ \curvearrowright \\ \text{ev}_1 \leftarrow 1 \quad \text{ev}_2 \rightarrow 2 \\ \curvearrowleft \\ 4 \quad 5 \\ \textcircled{\text{II}} \\ \uparrow 6 \\ \textcircled{\varphi} \end{array} \end{array} \end{aligned}$$

Let us now give the proof of Lemma 6.6 Since g_α is a quasi-isomorphism, it is enough to prove the converse statement, namely, that given (h_1, h_2) we can find appropriate $(\tilde{h}_1, \tilde{h}_2)$. The

\parallel As for the orientation, we will not be switching the order of evaluation of x_1, x_2 , so we can just fix some ordering of the edges connecting x_i to ev .

expression $\langle \pi_{h_1, h_2}(x_1, x_2), \varphi \rangle$ is given by evaluating the following combination of diagrams:

$$\langle \pi_{h_1, h_2}(x_1, x_2), \varphi \rangle =$$

We replace the term containing $h_1(x_1)$ using the following homotopy:

$$+$$

And the term containing $h_2(x_2)$ using the following homotopy:

$$-$$

Counting the remaining terms gives a combination of diagrams, which when written in terms of cup products, gives the desired result.

We now give the last homotopy that was missing, for the proof of Lemma 6.7:

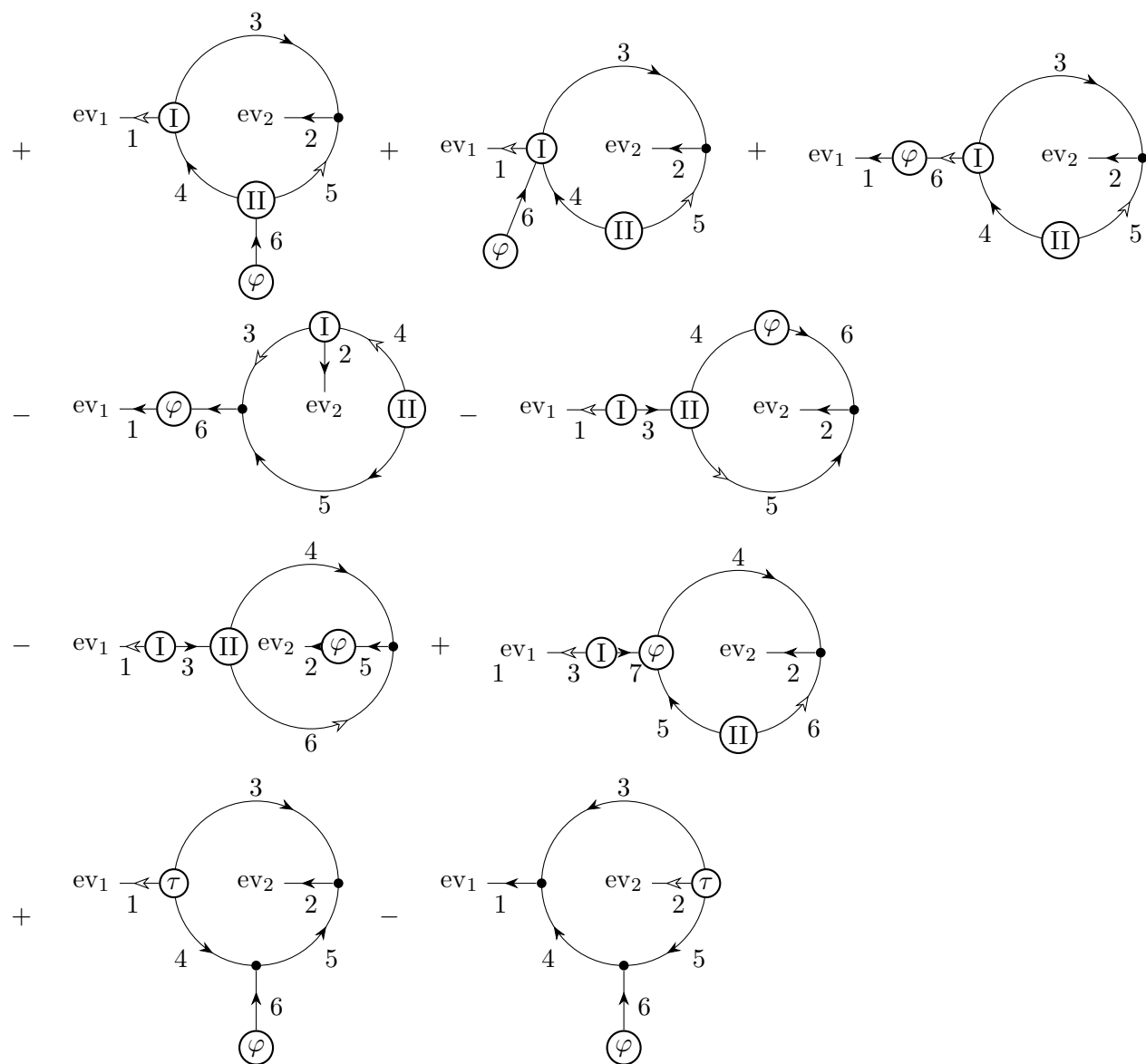

REFERENCES

- [Abb16] Hossein Abbaspour. “On the Hochschild homology of open Frobenius algebras”. In: *J. Noncommut. Geom.* 10.2 (2016), pp. 709–743.
- [BB17] Alexander Berglund and Kaj Börjesson. “Free loop space homology of highly connected manifolds”. In: *Forum Mathematicum*. Vol. 29. 1. De Gruyter. 2017, pp. 201–228.
- [BCS22] Tristan Bozec, Damien Calaque, and Sarah Scherotzke. *Calabi-Yau structures on (quasi-)bisymplectic algebras*. 2022. arXiv: 2203.14382 [math.RT].
- [BCS23] Tristan Bozec, Damien Calaque, and Sarah Scherotzke. “Calabi–Yau structures for multiplicative preprojective algebras”. In: *Journal of Noncommutative Geometry* 17.3 (2023), pp. 783–810.
- [Ber14] Alexander Berglund. “Koszul spaces”. In: *Transactions of the American Mathematical Society* 366.9 (2014), pp. 4551–4569.
- [BR23] Christopher Brav and Nick Rozenblyum. *The cyclic Deligne conjecture and Calabi-Yau structures*. 2023. arXiv: 2305.10323 [math.AT].
- [CHO20] Kai Cieliebak, Nancy Hingston, and Alexandru Oancea. *Poincaré duality for loop spaces*. 2020. arXiv: 2008.13161 [math.SG].
- [CHO23] Kai Cieliebak, Nancy Hingston, and Alexandru Oancea. “Loop coproduct in Morse and Floer homology”. In: *J. Fixed Point Theory Appl.* 25.2 (2023), Paper No. 59, 84.
- [CJ02] Ralph L. Cohen and John D. S. Jones. “A homotopy theoretic realization of string topology”. In: *Math. Ann.* 324.4 (2002), pp. 773–798.
- [CKS08] Ralph L. Cohen, John R. Klein, and Dennis Sullivan. “The homotopy invariance of the string topology loop product and string bracket”. In: *J. Topol.* 1.2 (2008), pp. 391–408.
- [CS99] Moira Chas and Dennis Sullivan. “String topology”. Preprint (arXiv:math.GT/9911159). 1999.
- [Efi17] Alexander I. Efimov. *Categorical formal punctured neighborhood of infinity, I*. 2017. arXiv: 1711.00756 [math.AG].
- [Gan13] Sheel Ganatra. *Symplectic cohomology and duality for the wrapped Fukaya category*. 2013. arXiv: 1304.7312 [math.SG].
- [GGV22] Sheel Ganatra, Yuan Gao, and Sara Venkatesh. *Rabinowitz Fukaya categories and the categorical formal punctured neighborhood of infinity*. 2022. arXiv: 2212.14863 [math.SG].
- [GH09] Mark Goresky and Nancy Hingston. “Loop products and closed geodesics”. In: *Duke Math. J.* 150.1 (2009), pp. 117–209.
- [Goo85] Thomas G. Goodwillie. “Cyclic homology, derivations, and the free loop space”. In: *Topology* 24.2 (1985), pp. 187–215.
- [Hat65] Akira Hattori. “Rank element of a projective module”. In: *Nagoya Math. J.* 25 (1965), pp. 113–120.
- [HW22] Nancy Hingston and Nathalie Wahl. “Product and coproduct in string topology”. To appear in *Ann. Sci. Éc. Norm. Supér.* 2022.
- [Iri18] Kei Irie. “A chain level Batalin-Vilkovisky structure in string topology via de Rham chains”. In: *Int. Math. Res. Not. IMRN* 15 (2018), pp. 4602–4674.
- [Kel03] Bernhard Keller. *Derived invariance of higher structures on the Hochschild complex*. 2003.

- [Kel06] Bernhard Keller. “On differential graded categories”. In: *International Congress of Mathematicians. Vol. II*. Eur. Math. Soc., Zürich, 2006, pp. 151–190.
- [KS00] Maxim Kontsevich and Yan Soibelman. “Deformations of algebras over operads and the Deligne conjecture”. In: *Conférence Moshé Flato 1999*. Vol. 1. Kluwer Acad. Publ. Dordrecht. 2000, pp. 255–307.
- [KS08] Maxim Kontsevich and Yan Soibelman. “Notes on A-infinity-algebras, A-infinity-categories and non-commutative geometry”. In: *Homological Mirror Symmetry: New Developments and Perspectives*. Springer, 2008, pp. 1–67.
- [KTV22] Maxim Kontsevich, Alex Takeda, and Yiannis Vlassopoulos. *Pre-Calabi-Yau algebras and topological quantum field theories*. 2022. arXiv: 2112.14667 [math.AG].
- [KTV23] Maxim Kontsevich, Alex Takeda, and Yiannis Vlassopoulos. *Smooth Calabi-Yau structures and the noncommutative Legendre transform*. 2023. arXiv: 2301.01567 [math.AT].
- [LV05] Wendy Lowen and Michel Van den Bergh. “Hochschild cohomology of abelian categories and ringed spaces”. In: *Advances in Mathematics* 198.1 (2005), pp. 172–221.
- [Men09] Luc Menichi. “String topology for spheres”. In: *Comment. Math. Helv.* 84.1 (2009). With an appendix by Gerald Gaudens and Menichi, pp. 135–157.
- [Nae21] Florian Naef. *The string coproduct “knows” Reidemeister/Whitehead torsion*. 2021. arXiv: 2106.11307.
- [NRW23] Florian Naef, Manuel Rivera, and Nathalie Wahl. “String topology in three flavours”. In: *to appear in EMS Surveys in Mathematical Sciences [Dennis Sullivan’s 80th birthday volume]* (2023). arXiv: 2203.02429 [math.AT].
- [NS23] Florian Naef and Pavel Safronov. *Torsion volume forms*. 2023. arXiv: 2308.08369 [math.AG].
- [NW19] Florian Naef and Thomas Willwacher. *String topology and configuration spaces of two points*. 2019. arXiv: 1911.06202.
- [Pri17] JP Pridham. “Shifted Poisson and symplectic structures on derived N-stacks”. In: *Journal of Topology* 10.1 (2017), pp. 178–210.
- [PT23] Kate Poirier and Thomas Tradler. *A Note on the string topology BV-algebra for S^2 with \mathbb{Z}_2 coefficients*. 2023. arXiv: 2301.05381.
- [PV12] Alexander Polishchuk and Arkady Vaintrob. “Chern characters and Hirzebruch-Riemann-Roch formula for matrix factorizations”. In: *Duke Math. J.* 161.10 (2012), pp. 1863–1926.
- [Riv23] Manuel Rivera. “An algebraic model for the free loop space”. In: *to appear in Higher Structures in Geometry, Topology and Physics, Contemp. Math. AMS (2023)* (2023). arXiv: 2210.10096 [math.AT].
- [RW19] Manuel Rivera and Zhengfang Wang. “Singular Hochschild cohomology and algebraic string operations”. In: *J. Noncommut. Geom.* 13.1 (2019), pp. 297–361.
- [RW22] Manuel Rivera and Zhengfang Wang. “Invariance of the Goresky-Hingston algebra on reduced Hochschild homology”. In: *Proc. Lond. Math. Soc. (3)* 125.2 (2022), pp. 219–257.
- [Shk13] Dmytro Shklyarov. “Hirzebruch–Riemann–Roch-type formula for DG algebras”. In: *Proceedings of the London Mathematical Society* 106.1 (2013), pp. 1–32.
- [Tab10] Gonçalo Tabuada. “Differential graded versus simplicial categories”. In: *Topology Appl.* 157.3 (2010), pp. 563–593.
- [Tra02] Thomas Tradler. *Poincaré duality induces a BV-structure on Hochschild cohomology*. Thesis (Ph.D.)—City University of New York. ProQuest LLC, Ann Arbor, MI, 2002, p. 103.

- [TT05] Dmitri Tamarkin and Boris Tsygan. “The ring of differential operators on forms in noncommutative calculus”. In: *Graphs and patterns in mathematics and theoretical physics*. Vol. 73. Proc. Sympos. Pure Math. Amer. Math. Soc., Providence, RI, 2005, pp. 105–131.
- [TZ06] Thomas Tradler and Mahmoud Zeinalian. “On the cyclic Deligne conjecture”. In: *J. Pure Appl. Algebra* 204.2 (2006), pp. 280–299.
- [TZ07a] Thomas Tradler and Mahmoud Zeinalian. “Algebraic string operations”. In: *K-Theory* 38.1 (2007), pp. 59–82.
- [TZ07b] Thomas Tradler and Mahmoud Zeinalian. “Infinity structure of Poincaré duality spaces”. In: *Algebr. Geom. Topol.* 7 (2007). Appendix A by Dennis Sullivan, pp. 233–260.
- [WW16] Nathalie Wahl and Craig Westerland. “Hochschild homology of structured algebras”. In: *Adv. Math.* 288 (2016), pp. 240–307.
- [Yeu18] Wai-Kit Yeung. *Pre-Calabi-Yau structures and moduli of representations*. 2018. arXiv: arXiv:1802.05398 [math.AG].

M. Rivera, PURDUE UNIVERSITY, DEPARTMENT OF MATHEMATICS, 150 N. UNIVERSITY ST. WEST LAFAYETTE, IN 47907

E-mail address: manuelr@purdue.edu

A. Takeda, INSTITUT DES HAUTES ÉTUDES SCIENTIFIQUES, 35 ROUTE DE CHARTRES, 91440 BURES-SUR-YVETTE, FRANCE

E-mail address: atakeda@ihes.fr

Z. Wang, INSTITUTE OF ALGEBRA AND NUMBER THEORY, UNIVERSITY OF STUTTGART, PFAFFENWALDRING 57, 70569 STUTTGART GERMANY

E-mail address: zhengfangw@gmail.com