

Random surfaces and lattice Yang-Mills

Sky Cao
MIT

Minjae Park
University of Chicago

Scott Sheffield
MIT

September 29, 2023

Abstract

We study Wilson loop expectations in lattice Yang-Mills models with a compact Lie group G . Using tools recently introduced in a companion paper [PPSY23], we provide alternate derivations, interpretations, and generalizations of several recent theorems about Brownian motion limits (Dahlqvist), lattice string trajectories (Chatterjee and Jafarov) and surface sums (Magee and Puder). We show further that one can express Wilson loop expectations as sums over embedded planar maps in a manner that applies to any matrix dimension $N \geq 1$, any inverse temperature $\beta > 0$, and any lattice dimension $d \geq 2$.

When $G = \mathrm{U}(N)$, the embedded maps we consider are pairs (\mathcal{M}, ϕ) where \mathcal{M} is a planar (or higher genus) map and ϕ is a graph homomorphism from \mathcal{M} to a lattice such as \mathbb{Z}^d . The faces of \mathcal{M} come in two partite classes: *edge-faces* (each mapped by ϕ onto a single edge) and *plaquette-faces* (each mapped by ϕ onto a single plaquette). The weight of a lattice edge e is the Weingarten function applied to the partition whose parts are given by half the boundary lengths of the faces in $\phi^{-1}(e)$. (The Weingarten function becomes quite simple in the $N \rightarrow \infty$ limit.) The overall weight of an embedded map is proportional to N^χ (where χ is the Euler characteristic) times the product of the edge weights. We establish analogous results for $\mathrm{SU}(N)$, $\mathrm{O}(N)$, $\mathrm{SO}(N)$, and $\mathrm{Sp}(N/2)$, where the embedded surfaces and weights take a different form. There are several variants of these constructions. In this context, we present a list of relevant open problems spanning several disciplines: random matrix theory, representation theory, statistical physics, and the theory of random surfaces, including random planar maps and Liouville quantum gravity.

Contents

1	Introduction	2
1.1	Overview	2
1.2	Random matrices	7
1.3	Continuum Yang-Mills	8
1.4	Lattice models and planar maps	9
1.5	Main results	12
1.6	Summary of paper and reading guide	14

2	Notation and background	14
2.1	Poisson point process on strand diagrams	15
2.2	Representation theory and other preliminaries	21
3	Surface-sum representation of Wilson loop expectations	31
4	Brownian motion and Poisson process exploration	37
4.1	Strand-by-strand exploration	37
4.2	Extension to general values of N	54
5	Makeenko-Migdal/Master loop/Schwinger-Dyson equations	59
6	Other groups	67
6.1	Orthogonal and Symplectic	68
6.2	Special Unitary and Special Orthogonal	97
7	Open problems	109
A	Properties of the Orthogonal Weingarten function	113

1 Introduction

1.1 Overview

On a heuristic level, Euclidean Yang-Mills theory is a “probability measure” defined by

$$d\mu_{\text{YM}}(\omega) = \frac{1}{Z} e^{-\frac{1}{2g^2} S_{\text{YM}}(\omega)} d\omega$$

where ω ranges over a space \mathcal{A} of Lie-algebra-valued connection forms on some Riemannian manifold, the Yang-Mills action S_{YM} is the L^2 -norm of the curvature of ω , g is a coupling constant, and $d\omega$ is a “Lebesgue measure” on \mathcal{A} . Making precise sense of the heuristic definition above is a famous open problem that we will not solve here [JW06].

Instead, we will study *lattice Yang-Mills theory* (a.k.a. *lattice gauge theory*), an approximation to the continuum theory introduced in 1974 by Wilson [Wil74] who also credits Polyakov and Smit for similar ideas [Wil04]. An online search for scholarly work on “lattice gauge theory” turns up tens of thousands of articles in physics and mathematics, and we cannot cover all of the variants and applications here. Wilson’s memoir and Chatterjee’s recent survey for probabilists are good places to start [Wil04, Cha19b]. See also Yang’s account of his early work with Mills in 1954 [WG01].

Lattice Yang-Mills assigns a random N -by- N matrix from some compact Lie group G — usually $U(N)$, $O(N)$, $SU(N)$, $SO(N)$, or $Sp(N/2)$ — to each directed edge of a graph Λ , which is usually \mathbb{Z}^d or a finite induced subgraph of \mathbb{Z}^d . We require this assignment to have an edge-reversal symmetry: if Q_e is the matrix assigned to a directed edge $e = (v, w)$, then $Q_{(w,v)} = Q_{(v,w)}^{-1}$. If $p = (e_1, e_2, \dots, e_k)$ is a directed path, then we write $Q_p = Q_{e_1} Q_{e_2} \dots Q_{e_k}$. A *loop* is a directed cycle ℓ defined modulo cyclical reordering (which amounts to repositioning

the starting point of the loop). We define a set \mathcal{P} of directed loops in Λ that we call *plaquettes*. Usually \mathcal{P} is the set of directed unit squares in Λ (i.e., directed cycles with four distinct vertices), but in principle \mathcal{P} can be any collection of loops that is closed under reversal (i.e. $p \in \mathcal{P}$ implies that the orientation reversal of p is in \mathcal{P}).

Let M be one of the aforementioned classical Lie groups. Define the **normalized trace** by $\text{tr}(M) := \frac{1}{N} \text{Tr}(M) = \frac{1}{N} \left(\sum_{j=1}^N M_{j,j} \right)$ and write $\text{Re}(z)$ for the real part of z . Note that if M is the identity, then $\text{Re}(\text{tr}(M)) = 1$ and $\text{Re}(\text{tr}(-M)) = -1$. In some sense $\text{Re}(\text{tr}(M)) \in [-1, 1]$ is a measure of how close M is to the identity matrix. It is large (close to 1) if M is near the identity. If ℓ is a loop then $\text{tr}(Q_\ell)$ is well-defined because the conjugacy class of $Q_{e_1} Q_{e_2} \dots Q_{e_k}$ (and hence the trace) does not change if we cyclically reorder the e_i . If ℓ^{-1} is the orientation reversal of ℓ then $\text{tr}(Q_\ell) = \overline{\text{tr}(Q_{\ell^{-1}})}$. This is because inverting a matrix inverts its eigenvalues, and (for matrices in compact Lie groups) each eigenvalue z satisfies $|z|^2 = z\bar{z} = 1$ so that $1/z = \bar{z}$. This also implies that for the matrices M in our compact Lie groups, we can write $\frac{1}{2}(\text{tr}(M) + \text{tr}(M^{-1})) = \text{Re}(\text{tr}(M))$.

The lattice Yang-Mills measure is the probability measure

$$Z^{-1} \prod_{p \in \mathcal{P}} \exp(N\beta \text{Tr}(Q_p)) \prod_{e \in E_\Lambda^+} dQ_e \quad (1.1)$$

where $\beta > 0$ is an inverse temperature, Z is a normalizing constant, each dQ_e is Haar measure on the compact Lie group G , and (to avoid counting an undirected edge twice) E_Λ^+ is the set of oriented edges of Λ for which the endpoint is lexicographically after the starting point. This is a positive measure because \mathcal{P} is closed under direction-reversal — this direction-reversal property implies that we can define a set \mathcal{P}^+ of “positively oriented plaquettes” containing exactly one element of $\{\ell, \ell^{-1}\}$ for each $\ell \in \mathcal{P}$, and then rewrite (1.1) as

$$Z^{-1} \prod_{p \in \mathcal{P}^+} \exp(2N\beta \text{Re}(\text{Tr}(Q_p))) \prod_{e \in E_\Lambda^+} dQ_e. \quad (1.2)$$

Remark 1.1. We note here that the above action differs from some previous work [Cha19a, CJ16, SSZ22] by a factor of 2: where we have 2β the previous works have just β . This slightly simplifies many of our formulas later on, where β appears instead of $\frac{\beta}{2}$.

Informally, the Yang-Mills measure on (Q_e) configurations corresponds to i.i.d. *Haar measure* (one instance of Haar measure for each positively directed edge of Λ) modified by a *weighting* that favors configurations for which Q_p is close to the identity whenever $p \in \mathcal{P}$. A *Wilson loop observable* is a quantity of the form

$$W_{\mathcal{L}}(Q) := \prod_{\ell \in \mathcal{L}} \text{tr}(Q_\ell),$$

where \mathcal{L} is some finite collection of loops in Λ . A *Wilson loop expectation* is a quantity of the form

$$\mathbb{E}[W_{\mathcal{L}}(Q)].$$

Remark 1.2. In contrast to some previous works [Cha19a, CJ16, SSZ22], our Wilson loops are defined with the normalized trace rather than the trace. Thus, our Wilson loop expectations

are $N^{-|\mathcal{L}|}$ (here $|\mathcal{L}|$ denotes the number of loops in \mathcal{L}) times the Wilson loop expectations that appear in the works mentioned above. This is a cosmetic distinction; the scaling we use is natural when taking large N limits.

The fundamental goal of lattice Yang-Mills theory is to understand these quantities. That is, one seeks to compute

$$\int \prod_{\ell \in \mathcal{L}} \text{tr}(Q_\ell) Z^{-1} \prod_{p \in \mathcal{P}} \exp(N\beta \text{Tr}(Q_p)) \prod_{e \in E_\Lambda^+} dQ_e \quad (1.3)$$

which we can Taylor expand and write as

$$Z^{-1} \int \prod_{\ell \in \mathcal{L}} \text{tr}(Q_\ell) \prod_{p \in \mathcal{P}} \left(\sum_{k=0}^{\infty} \frac{(N\beta)^k}{k!} \text{Tr}(Q_p)^k \right) \prod_{e \in E_\Lambda^+} dQ_e. \quad (1.4)$$

Given $K : \mathcal{P} \rightarrow \mathbb{Z}_+$, write $K! = \prod_{p \in \mathcal{P}} K(p)!$ and $\beta^K = \prod_{p \in \mathcal{P}} \beta^{K(p)}$. Using this notation, write

(1.4) as

$$Z^{-1} \sum_{K: \mathcal{P} \rightarrow \mathbb{Z}_+} \frac{(N\beta)^K}{K!} \int \prod_{\ell \in \mathcal{L}} \text{tr}(Q_\ell) \prod_{p \in \mathcal{P}} \left(\text{Tr}(Q_p) \right)^{K(p)} \prod_{e \in E_\Lambda^+} dQ_e. \quad (1.5)$$

This leads to a classical problem in random matrix theory, which is somehow at the heart of this subject. How can we best compute and understand the individual summands in (1.5), which can be described in words as “expected products of traces of products of matrices—each of which comes from a set of i.i.d. Haar-distributed matrices and their inverses”? This question is expressed more carefully in Section 1.2.

Variants of this question have a long history, beginning with the foundational work of 't Hooft and Brézin et al and Itzykson, Parisi, Zuber from the 1970's [tH93, BIPZ78] and expanding greatly over subsequent decades, encompassing various types of random matrices, including Gaussian ensembles (such as GUE or GOE) as well as Haar measure on compact Lie groups [Eyn11a, IZ80, Meh81, GPW91, DFGZJ95, Zvo97, BIZ80, Oko00, BDFG02, ZJZ03, GMS05, GMS05, MS06, CMSS07, EO08, CGMS09, Eyn11b, GN15, E+16]. These papers make connections to the random planar map theory developed by Tutte (and many others) [Tut68] and the continuum random surface theory developed by Polyakov (and many others) [Pol81]. The third author's recent random surface survey contains many additional references on both sides [She22].

Despite these decades of work, fundamental advances continue to be made. For example, the precise question above was recently addressed in the groundbreaking work of Magee and Puder [MP19, MP22], as explained further in Section 1.2 below. The analog of Λ in their setting is a “blossom graph” which contains a single vertex and an edge set E_Λ that consists of finitely many (distinct and labeled) self-loops. This is somehow the most general setting, because in this scenario *any* element of the free group generated by (Q_e) can be written as Q_ℓ for a loop ℓ in Λ . Their analysis treats this as a fundamental random matrix question (not necessarily motivated by Yang-Mills) and builds on the classical work of Collins and Śniady on the so-called *Weingarten calculus* which in turn builds on earlier work by Weingarten himself [Wei78, CS06, CMN22]. See also the representation-theoretic ideas due to Dahlqvist

and others [CDK18, Dah16]. Further analysis on this theme appears in recent work by Buc-d’Alché which in particular describes the $N \rightarrow \infty$ asymptotic behavior of Wilson loop expectations in terms of so-called *unitary maps* [Bd23] while also considering generalizations to mixtures of deterministic and unitary matrices.

A series of groundbreaking papers by Chatterjee and/or Jafarov has provided a different approach to identities involving (1.5) including the *Makeenko-Migdal/Master Loop/Schwinger-Dyson equations*. This approach enables them to describe the $N \rightarrow \infty$ behavior of (1.5) in terms of so-called *lattice string trajectories* [CJ16, Cha19b, Jaf16, Cha19a], see also another recent derivation by [SSZ22] and several generalizations due to Diez and Miaskiwyki [DM22]. These works build on a vast literature in this area, including early works of Makeenko and Migdal [MM79] (see also the recent physics paper [KZ23] which combines these equations with the bootstrap method in order to numerically compute Wilson loop expectations). Although they work in the setting where Λ is an induced subgraph of \mathbb{Z}^d , one may also recall a standard “gauge fixing” argument that allows one to reduce to the case that Q_e is fixed to be the identity for all e within some spanning tree of Λ . This is equivalent to identifying that entire tree with a single vertex, which reduces Λ to a blossom graph that (in the case $\beta = 0$) agrees exactly with the setting discussed by Magee and Puder.

We will provide an alternate derivation of some of the blossom graph results of Magee and Puder [MP19, MP22] as well as the master field and string trajectory results of Chatterjee and Jafarov [CJ16, Cha19b, Jaf16, Cha19a]. Our statements along these lines will be in several ways more general than those in previous works.

1. **General N :** We allow for any matrix dimension $N \geq 1$ (the results in [MP19, MP22] are stated for N sufficiently large; one has to use a slightly different definition of the Weingarten function for smaller N).
2. **General graphs:** We consider general Λ and \mathcal{P} in our derivation of the Makeenko-Migdal/Master loop/Schwinger-Dyson relations (in [CJ16, Cha19b, Jaf16, Cha19a] the plaquettes \mathcal{P} are taken to be squares, though this is not fundamental to the argument).
3. **More general recurrence formula:** We also derive a more general form of the above-mentioned relations. To roughly explain the distinction, recall that the Makeenko-Migdal/Master loop/Schwinger-Dyson relation in [CJ16, Theorem 3.6] expresses the Wilson loop expectation of a string s in terms of strings s' obtained by applying local moves to s . A stronger result [CJ16, Theorem 8.1] uses only the s' obtained from local moves involving a *single fixed edge* $e \in \Lambda$. Our slightly stronger result uses only the s' obtained from local moves involving a *single fixed edge* of s . The distinction is that there may be many edges in s that correspond to the same $e \in \Lambda$. We refer to this as the *single-location* Makeenko-Migdal/Master loop/Schwinger-Dyson equation.
4. **General matrix families:** We also include analogs of our result for the most fundamental Lie group families (namely $U(N)$, $O(N)$, $SU(N)$, $SO(N)$, $Sp(N/2)$) while some of the earlier papers focused on one or two such groups. While [CJ16, Cha19b, Jaf16, Cha19a] first frame their results in terms of $SO(N)$ and $SU(N)$ we will frame our results and discussion in terms of $U(N)$, which from our point of view is the simplest case. We then extend the theory to $O(N)$, $SU(N)$, $SO(N)$, and $Sp(N/2)$ in Section 6.

This is the longest and most technically challenging part of the paper, as each group family comes with its own interesting set of challenges.

Another straightforward generalization of our result would be to include some deterministic matrices in the words; this type of generalization is considered e.g. in [Bd23]. We expect that this should be possible in our setting as well, but we will not discuss this here.

In all of settings described above, we will explain how to express Wilson loop expectations in terms of random lattice-embedded planar maps, which give rise to convergent sums for any Λ , any $N \geq 1$, and any β . These are closely related to both the topological surface sums in [MP19, MP22] and the string trajectories in [CJ16, Cha19b, Jaf16, Cha19a], but our derivation and planar map interpretation will be rather different. The main point we want to stress in this paper is that there are powerful ways to express Wilson loop expectations as sums over embedded planar maps. Some settings are more challenging than others (certain symmetries that apply in one setting may not apply in all settings) but we will nonetheless develop a framework that is very general, and that we hope will lead to progress on some of the open problems listed in Section 7.

Remark 1.3. One of the long-term goals of this theory is to construct and understand a continuum scaling limit of quantities like (1.5) as $\beta \rightarrow \infty$ and the lattice mesh size simultaneously goes to zero at an appropriate rate. Thus, ideally one desires an understanding of the terms of (1.5) that is sufficiently robust that it allows one to make predictions about these limits.

Remark 1.4. When β is large, the function $x \rightarrow \exp(2\beta x)$, defined for $x \in [-1, 1]$, is largest for x near 1 and *much smaller* in the rest of $[-1, 1]$. In principle, one could replace the exp in (1.3) by a different function with this property: say $x \rightarrow \frac{1}{2}(x^b + x^{b+1})$ for some large b . If we took this approach, then the analog of (1.5) would have only finitely many summands, but we would still expect it to have a similar scaling limit behavior as $b \rightarrow \infty$ and the lattice mesh size simultaneously goes to zero. Somehow b is playing the role of β here: instead of taking the number of plaquettes of a given type to be *a priori* Poisson with parameter β we can take the number to be either b or $b + 1$ (each with probability $1/2$). Alternatively, one can replace (1.1) with

$$Z^{-1} \left[\left(|\mathcal{P}|^{-1} \sum_{p \in \mathcal{P}} \text{tr}(Q_p) \right)^b + \left(|\mathcal{P}|^{-1} \sum_{p \in \mathcal{P}} \text{tr}(Q_p) \right)^{b+1} \right] \prod_{e \in E_\Lambda^+} dQ_e \quad (1.6)$$

which somehow fixes the *total* number of plaquettes to be b or $b + 1$. This approach might also have a similar scaling limit if $b \rightarrow \infty$ at the right rate. If one is working toward the goal of “constructing a candidate continuum theory” one is allowed to use whatever approach turns out to be most computationally tractable.

Acknowledgements. We thank Bjoern Bringmann, Sourav Chatterjee, Hao Shen and Tom Spencer for helpful conversations. We thank the Institute for Advanced Study for hosting us while this work was completed. The first author was supported by the Minerva Research Foundation at IAS, as well as by NSF Award: DMS 2303165. The third author is supported by NSF Award: DMS 2153742.

1.2 Random matrices

At the heart of our analysis are two classical questions about the traces of random matrices. The first is the one we discussed in Section 1.1 and the second is a close variant.

1. Suppose M_1, M_2, \dots, M_k are i.i.d. samples from Haar measure on $U(N)$ (or a similar Lie group) and that W_1, \dots, W_m are words in the M_i and M_i^{-1} . Can we compute the expectation

$$\mathbb{E}\left[\prod_{i=1}^k \text{tr}(W_i)\right]$$

in a “nice” way? For example, can we express $\mathbb{E}\left[\text{tr}(M_1 M_2 M_1^{-1} M_2^{-3}) \text{tr}(M_1^3 M_2 M_1^{-1} M_2^{-1})\right]$ as a simple function of N ?

2. How does the answer to the previous question change if instead of sampling from Haar measure, we obtain each M_i by running a Brownian motion on the Lie group for t_i units of time, starting with the identity?

The second question can be understood as an “external field” version of the first question. This is because when the t_i are small, the M_i are more likely to be close to the identity, and this “bias toward the identity” is similar in spirit to the “bias toward positive spin” imposed in e.g. an Ising model with an external field. The second question also arises naturally in *two-dimensional* Yang-Mills theory and has been heavily studied in that context [GKS89, Dri89, Fin91, Wit91, Mig96, Sen97, Lév03, Lév10, Lév17, DHK17, She21, Che19, Dri19, CCHS22a, DN20, DL22].

In two dimensions, the fine-mesh scaling limit of Yang-Mills theory is well understood, but if one attempts to compute the Wilson loop expectation for a complicated collection of loops (perhaps with many intersections and self-intersections) one obtains precisely an instance of the second problem above—indeed, the problems are equivalent since one can obtain *any* instance of the second problem for *some* two-dimensional loop.

In a recent companion paper [PPSY23] (including some of the authors of this paper), it was shown that the answer to the second question can be expressed as an expectation w.r.t. a certain Poisson point process. In this paper, we will explain how the answer to the first question can be derived directly from the analysis in [PPSY23] by taking $t_i \rightarrow \infty$. This is our first main result, which we state informally as follows. For a precise version, see Theorem 2.5.

Theorem 1.5 (Recovery of Weingarten calculus via Brownian motion). *The expectations of traces of words of Unitary Brownian motion converge as the time parameter goes to infinity to an explicit limit given in terms of the Weingarten function. Similar results hold for the other classical Lie groups.*

Remark 1.6. We note that Theorem 2.5 has previously appeared in [Dah17], albeit stated in slightly different (but equivalent) terms – see Sections 4 and 5 of the paper. Dahlqvist’s proof relies heavily on representation theory. On the other hand, we believe that our proof may be easier to read for those who have a probability background but perhaps are not as familiar

with representation theory. Additionally, our proof technique differs from Dahlqvist’s in an essential way, which allows us to obtain the more general version of the Makeenko-Migdal/Master loop/Schwinger-Dyson equation for lattice Yang-Mills that we previously alluded to (Theorem 1.12). See Remark 4.13 for more discussion on the differences between the two arguments.

Our approach to this result is in some sense very straightforward. The analysis in [PPSY23] notes that when all of the t_i are less than infinity, the noise generating the Lie group Brownian motion is a Gaussian white noise on a Lie algebra; because all randomness is Gaussian, all of the relevant quantities can be easily deduced from Wick’s formula and planar maps (see the overview of these techniques [Zvo97]) which leads to a Poisson point process formulation of the theory. The analysis in this paper begins with the Poisson point process formulation obtained in [PPSY23] and shows that geometric cancellations simplify in the $t_i \rightarrow \infty$ limit, so that the *Weingarten function* (as originally introduced in [Wei78]) appears naturally without any difficult computation. This approach also provides other insights – for instance, certain single-edge analogs of the string-exploration steps in [CJ16] can be interpreted in terms of the so-called Jucys-Murphy elements [Juc74, Mur81, ZJ09, Nov10, App11, MN13].

1.3 Continuum Yang-Mills

The famous continuum *Yang-Mills problem* [JW06] is (roughly speaking) to construct and understand the basic properties of a continuum analog of the lattice model described above, which should somehow make rigorous sense of the measure in 1.1. This problem remains open for $d \geq 3$ and its solution for $d = 4$ would in some sense also yield a solution to the quantum Minkowski version of Yang-Mills that forms the basis of the standard model in physics, see the Millennium Prize description [JW06].

This paper is focused on understanding a *lattice* version of Yang-Mills theory in terms of sums over surfaces, with the aim of gaining insight into a possible continuum theory. It is not clear what kind of fine-mesh scaling limit one should expect the lattice models to have, but our hope is that the lattice analysis presented here will provide some clues, and we present several open problems along these lines in Section 7.

We remark that a number of purely continuum approaches to this problem are also being actively pursued. For example, there is an *SPDE-based approach* which aims to construct a dynamical version of continuum Yang-Mills (on a torus, say) and show that it converges to a stationary law in the large time limit. One can take as the initial value a “Lie-algebra-valued Gaussian free field connection” that one expects to approximate the correct continuum theory at small scales and try to argue that the behavior at large scales converges to a limit over time. See e.g. [CCHS22a, CCHS22b, Che22, CC21, CC23, BC23]. There has been some significant recent progress in this area, especially in two and three dimensions.

Alternatively, one can also work directly in the continuum *without* attempting to understand a dynamical process. One might regularize the continuum model in some other way—perhaps starting with a continuum Gaussian. Some form of this was implemented by Magnen, Rivasseau, and Sénéor [MRS93]. Some approaches along these lines might also be amenable to the type of random surface analysis discussed in this paper; see Section 7.

1.4 Lattice models and planar maps

Consider a pair (\mathcal{M}, ϕ) where \mathcal{M} is a planar (or higher genus) map and $\phi : \mathcal{M} \rightarrow \Lambda$ is a graph homomorphism.¹ We call this pair a **semi-folded map** or **edge-plaquette embedding** if the following hold:

1. The dual graph of \mathcal{M} is bipartite. The faces of \mathcal{M} in one partite class are designated as “edge-faces” (shown blue in figures) and those in the other class are called “plaquette-faces” (shown yellow in figures).
2. ϕ maps each plaquette-face of \mathcal{M} isometrically *onto* a plaquette in \mathcal{P} .
3. ϕ maps each edge-face of \mathcal{M} onto a single edge of Λ .

See Figures 1-4 for examples and intuition.

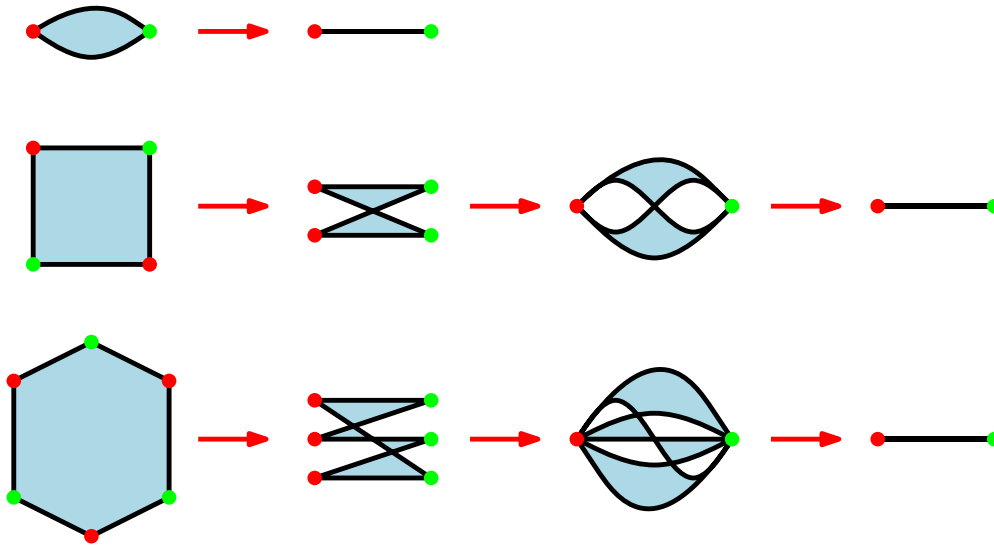

Figure 1: In an edge-plaquette embedding, we can imagine that each blue face is “twisted and collapsed” onto a single edge, see Figure 2. In the sequence above, we first twist, then collapse matching vertices, then collapse edges.

In order to construct a model of random edge-plaquette-embedding that is useful in Yang-Mills theory. We will need to assign a “weight” to every face of Λ (depending on the number of plaquettes there) and every edge (depending on the number and type of blue faces there). This weight is closely related to the so-called Weingarten function, which we discuss next.

1.4.1 Weingarten function

Note that a complex-valued function on S_n can be identified as an element in the group algebra $\mathbb{C}[S_n]$, that is $\sigma \mapsto f(\sigma)$ is identified as $\sum_{\sigma \in S_n} f(\sigma)\sigma$. Let $\mathbb{Q}[N] \subset \mathbb{C}[N]$ be the field of rational functions with rational coefficients in the variable N . When $N \geq n$ the **Weingarten function** Wg_N ² can be defined as the inverse in the group ring of $\mathbb{Q}(N)[S_n]$ of

¹In other words, if two vertices $v, w \in V(\mathcal{M})$ are adjacent in the graph \mathcal{M} , then $\phi(v), \phi(w)$ are adjacent in the graph $\phi(\mathcal{M}) \subset \Lambda$.

²We omit the dependence on n for brevity.

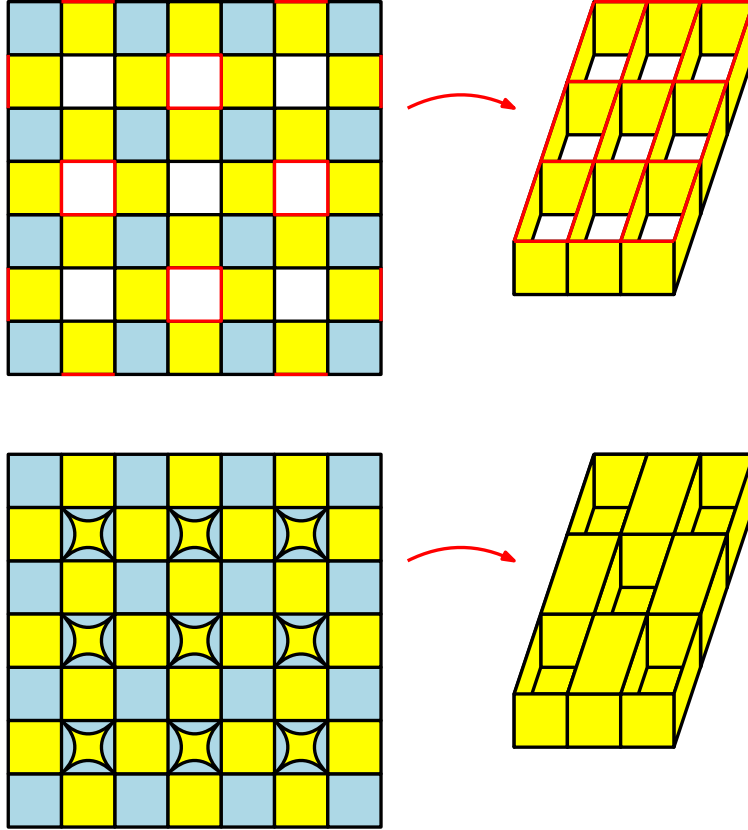

Figure 2: **Edge-plaquette embedding example:** Each of the 16 blue faces on the upper left gets mapped to a single vertical edge in the upper right, while each yellow face on the upper left gets mapped to a vertical yellow face on the upper right—the edge colored red is the one mapped to the top. On the lower left, additional yellow faces are added; their images on the right alternate between upper and layers in checkerboard fashion. Going from left to right requires “folding up” the blue squares and collapsing the blue 2-gons.

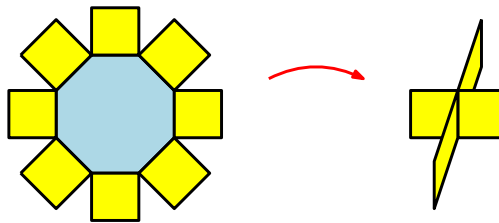

Figure 3: **Edge-plaquette embedding example:** If the blue face is an octagon, then there will be 8 yellow plaquettes meeting at the corresponding edge. In this example shown, the pre-image of each yellow face on the right may consist of two yellow faces on the left. In other words, there are two “copies” of each of the four plaquettes shown on the right.

the function $\sigma \rightarrow N^{\#\text{cycles}(\sigma)}$. (There is a slightly different definition for $N < n$, see Section 2.) Note that $\text{Wg}_N(\sigma)$ depends only on the conjugacy class of σ —i.e. on the cycle structure of σ . We can order cycles from biggest to smallest, represent this by a Young diagram, and interpret Wg_N as a function on Young diagrams. It is not the simplest function, and one

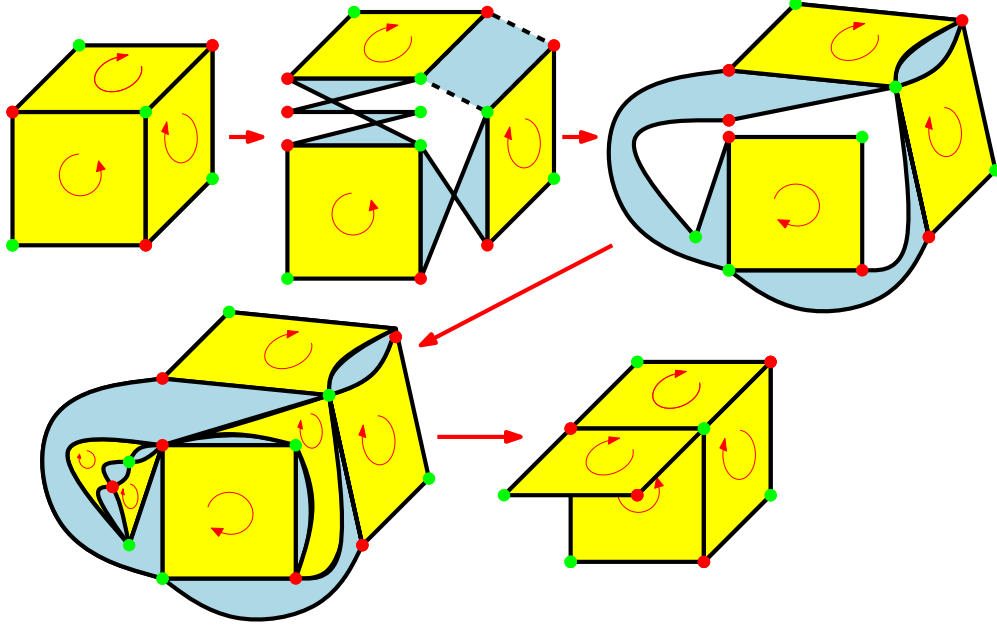

Figure 4: **Edge-embedding example showing orientations:** (1) Three oriented plaquette images in $\phi(\mathcal{M})$. (2) The blue faces connecting them have different types. (3) “Untwist” by flipping the lower-left plaquette across its red-red diagonal so that the three red and three blue faces are orientably embedded in the plane. (4) Add some new faces (three yellow squares and five blue 2-gons) to fill in the hole. Interpret the resulting colored map as a portion of \mathcal{M} orientably embedded in the plane. (5) Map this portion back into the lattice. Not all six yellow plaquettes are visible on the right because some overlap each other.

explicit formula (see the overview and additional references in [MP19]) is as follows:

$$\text{Wg}_N(\sigma) = \frac{1}{(n!)} \sum_{\lambda \vdash n} \left[\chi_\lambda(\text{id}) \chi_\lambda(\sigma) \prod_{(i,j) \in \lambda} (N + j - i)^{-1} \right] \quad (1.7)$$

where id is the identity permutation, $\lambda \vdash n$ denotes that λ is a partition of n , $\chi_\lambda(\sigma)$ is the character (trace of σ in the irreducible representation indexed by λ). Alternatively, when $N \geq n$ the Weingarten function is the group ring inverse of $f(\sigma) = \sigma \rightarrow N^{\#\text{cycles}(\sigma)}$ and can hence be formally expanded as

$$I + (I - f) + (I - f)^2 + \dots \quad (1.8)$$

The latter observation plays a key role in the derivation of [MP19, Theorem 2.9].

As will be explained in Section 3, we interpret σ as a collection of blue faces (one blue face of length $2k$ for each cycle of σ of length k). Then $\text{Wg}_N(\sigma)$ is essentially the *weight* associated to given collection of blue faces at an edge. Actually, as we detail in Section 3, the edge weights are given by the *normalized Weingarten function*, which we define as

$$\overline{\text{Wg}}_N(\sigma) := N^{2n - \#\text{cycles}(\sigma)} \text{Wg}_N(\sigma).$$

This is the normalization which leads to a nontrivial $N \rightarrow \infty$ limit (see Remark 3.2).

Given an edge-plaquette embedding (\mathcal{M}, ψ) and an edge e of our lattice Λ , we will write $\overline{\text{Wg}}_N(e)$ as shorthand for $\overline{\text{Wg}}_N(\mu_e(\mathcal{M}, \psi))$, where $\mu_e(\mathcal{M}, \psi)$ is the partition given by half the degrees of the blue faces mapped to e .

1.5 Main results

We already informally stated the first of our main results – recall Theorem 1.5. In this subsection, we proceed to state the remaining main results of this paper.

First, when computing Wilson loop expectations, we imagine the simplest setting in which we fix the number of yellow faces of each type (i.e. assign weight 1 to that number and 0 to all others). This corresponds to focusing on a single summand in (1.5), or equivalently to taking $\beta = 0$ in (1.5). In this case we have the following:

Theorem 1.7 (Surface-sum representation for word expectations). *When the gauge group is $U(N)$, the expected trace product is proportional to $\sum (\prod_e \overline{\text{Wg}}_N(e)) \cdot N^{\chi-2k}$ where the sum is over spanning edge-plaquette embeddings with given plaquette numbers, χ is the Euler characteristic and $k = |\mathcal{L}|$ is the number of loops.*

Remark 1.8. We regard Theorem 1.7 and the upcoming Corollary 1.10 as the main conceptual contribution of this paper. These results introduce the new concept of an edge-plaquette embedding, and give a fundamentally new description of Wilson loop expectations in terms of random planar maps³, thereby connecting two very different areas of research. Ultimately, we hope to prove new results about lattice gauge theories via analysis of these random planar maps, in particular building on the many advances in their understanding – see Section 7 for some open problems. See also Remark 1.11.

Remark 1.9. The results of Magee and Puder [MP19, MP22] could also be applied here to give a surface sum representation of the terms in (1.5). However, the relation to random planar maps is not as clear in their formulation. As mentioned in Remark 1.8, this is the main point of our result. For more comparison with Magee and Puder, see Section 1.5.1.

For a precise statement of this theorem, see Theorem 3.8. Even in the $U(N)$ case there are several variants to this result. The various “string trajectory moves” in [CJ16] can be interpreted in terms of the exploration of a surface built out of blue 2-gons and 4-gons and yellow squares. One can also interpret the individual Jucys-Murphy elements in these terms.

By applying Theorem 1.7 to every term in the series appearing in equation (1.5), we obtain that Wilson loop expectations may be expressed as a weighted sum over edge-plaquette embeddings. We state this informally as the following corollary.

Corollary 1.10 (Surface-sum representation of Wilson loop expectations). *When the gauge group is $U(N)$, the Wilson loop expectation $\mathbb{E}[W_{\mathcal{L}}(Q)]$ is proportional to $\sum \frac{\beta^{\text{area}}}{K!} (\prod_e \overline{\text{Wg}}_N(e)) \cdot N^{\chi-2k}$, where the sum is over spanning edge-plaquette embeddings with arbitrary plaquette numbers, area is the total number of plaquettes in the edge-plaquette embedding, $K!$ is a combinatorial factor depending only on the plaquette counts, χ is the Euler characteristic, and $k = |\mathcal{L}|$ is the number of loops.*

³This is rather loose terminology, as our surface sums are signed, and in general higher genus surfaces may appear.

For a precise statement of this corollary, see Corollary 3.11.

Remark 1.11. Recently, Taggi and coauthors [LT20, LT21, QT23] have succeeded in proving various results about spin $O(n)$ and related models by analyzing a certain related random path (or random loop) model. Starting from the spin $O(n)$ model, they arrive at their random path model in exactly an analogous manner as how we arrive at Corollary 1.10. Namely, starting from the action for the spin $O(n)$ model, which at a single edge is of the form $\exp(\beta\sigma_x \cdot \sigma_y)$, where $\sigma_x, \sigma_y \in S^n$, they expand $\exp(\beta(\sigma_x \cdot \sigma_y)) = \sum_k \frac{\beta^k}{k!} (\sigma_x \cdot \sigma_y)^k$ for each edge (x, y) , and then compute the resulting S^n -integrals. The S^n -integrals may be easily computed, with the resulting expressions only involving very explicit quantities such as factorials and Gamma functions (see [LT21, equation (2.12)]). This is one simplification compared to our setting, where the $U(N)$ -integrals lead to the appearance of the Weingarten function, which is much more complicated to understand. Another key difference is that while the S^n -integrals are always positive, the $U(N)$ -integrals may be both positive and negative. Thus the random path model of Taggi et al. may be interpreted as a genuine probability measure, while our surface sums may only be interpreted as signed measures.

Next, we give an informal statement of the Makeenko-Migdal/Master loop/Schwinger-Dyson equations satisfied by Wilson loop expectations. The corresponding precise statement is Theorem 5.6.

Theorem 1.12 (Single-location Makeenko-Migdal/Master loop/Schwinger-Dyson equation). *Wilson loop expectations satisfy the following recursion:*

$$\mathbb{E}[W_{\mathcal{L}}(Q)] = \text{splitting} + \text{merger} + \text{deformation}$$

Here, splitting, merger, and deformation correspond to certain types of operations we may apply to a given collection of loops \mathcal{L} to obtain a new collection of loops. They will be precisely defined in Section 5.

Remark 1.13. As previously mentioned, versions of this recursion for various Lie groups have previously appeared [CJ16, Cha19b, Jaf16, Cha19a, SSZ22]. We note that the precise form of our recursion is slightly different from (and more general than) the existing literature – see Remarks 5.4 and 5.7. Ultimately, the reason for this difference is due to our proof method. Whereas previous approaches are based on integration-by-parts⁴, our approach is essentially equivalent to applying a certain recursion that is satisfied by the Weingarten function (see e.g. [CM17, Proposition 2.2]), although we don't phrase our argument in this way – we prefer to proceed more probabilistically via our aforementioned Poisson point process formulation.

1.5.1 Discussion of Magee and Puder

The vocabulary in [MP21, MP19] is somewhat different from ours, but the results can be expressed in similar terms. We won't give a detailed account of those results, but let us

⁴The argument in [SSZ22] essentially reduces to integration by parts, as explained in [AN23, Appendix A.2]. To sketch the argument, the proof uses the fact that if the lattice Langevin dynamics is started at stationarity, then the expectation of any observable must be constant in time. Then, applying Itô's formula to Wilson loop observables, one obtains an identity saying that the drift term must have expectation zero. This identity is precisely integration by parts.

briefly outline a couple of key ideas to assist readers trying to compare their approach to ours. The approach in [MP21, MP19] makes heavy use of commutator words. Suppose a loop ℓ in \mathcal{L} corresponds to a commutator word $ABA^{-1}B^{-1}$ (where A and B could in principle describe paths of length longer than one). Imagine then that we have a surface S with a single boundary loop, whose boundary is mapped to ℓ . We can turn this surface into a closed surface in two ways. First, we can identify the boundary of an ordinary disk (with circular boundary) with the boundary of S , thereby gluing a circular disk onto S . Second we can glue the boundary of S to itself by first gluing the pre-images of the A and A^{-1} segments to each other and then gluing the pre-images of the B and B^{-1} segments to each other—which somehow turns the disk bounded by ℓ into a torus. It is not hard to see that the second approach produces a surface whose genus is 1 higher than the surface produced by the first approach: it effectively “adds a handle” to the surface. If we write a long loop ℓ as a product of n commutator words, then those words provide us a recipe for turning a disk bounded by ℓ into an n -holed torus (by performing gluings of the type mentioned above for each commutator).

Theorem 1.7 is closely related to [MP19, Theorem 2.8]. We remark that one could also interpret [MP19, Theorem 2.9] in terms of embedded maps (somehow involving multiple layers of blue faces). We note that [MP19, Theorem 2.9] is in some ways simpler than [MP19, Theorem 2.8] (it does not involve the Weingarten function) and in other ways more complicated (it involves another quantity called the L^2 Euler characteristic, which is in general not so trivial). We note that [MP19, Theorem 2.9] is derived from [MP19, Theorem 2.8]. We will not give an alternate derivation of this step, aside from remarking that the expansion in (1.8) plays a role.

1.6 Summary of paper and reading guide

We close this section off with a summary of the rest of the paper. In Section 2, we introduce the notation and background material that will be needed in the rest of the paper. In Section 3, we derive our surface-sum representation of Wilson loop expectations. In Section 4, we show how to recover the Weingarten calculus by taking limits of Unitary Brownian motion, using a certain strand-by-strand exploration that we introduce in the section. In Section 5, we apply our strand-by-strand exploration to obtain the single-location Makeenko-Migdal/Master loop/Schwinger-Dyson equation for Wilson loop expectations. Finally, in Section 6, we adapt our results to the cases of $G = O(N), \text{Sp}(N/2), \text{SU}(N), \text{SO}(N)$.

To the reader who wants to understand our surface-sum representation of Wilson loop expectations as quickly as possible, we recommend the following expedited reading strategy. First, read enough of Section 2 to understand the statement of Corollary 2.7. Then, proceed directly to Section 3 to see how this corollary is applied to obtain the surface-sum representation. This is roughly ten pages of material.

2 Notation and background

In this section, we introduce some basic notation and background that will be needed throughout this paper.

- For $n \in \mathbb{N}$, we denote the set $[1, n] \cap \mathbb{Z} = \{1, \dots, n\}$ by $[n]$.
- For $a, b \in \mathbb{Z}$, $a < b$, we denote $(a : b) := \{a + 1, \dots, b\}$. So $[n] = (0 : n]$.
- For a set A , we let $\binom{A}{2}$ denote the unordered set of ordered pairs of elements of A .

2.1 Poisson point process on strand diagrams

In this section, we review a result in the companion paper [PPSY23] that is necessary for this paper. In particular, we express the expected trace of unitary Brownian motions in terms of a certain Poisson point process, which we encode in a strand diagram (Definition 2.1).

Let $\Gamma = (\Gamma_1, \Gamma_2, \dots, \Gamma_k)$ be an (ordered) collection of words Γ_i on letters $\{\lambda_1, \dots, \lambda_L\}$ where

$$\Gamma_i = \lambda_{c_i(1)}^{\varepsilon_i(1)} \cdots \lambda_{c_i(M_i)}^{\varepsilon_i(M_i)}$$

for some $c_i : [M_i] \rightarrow [L]$ and $\varepsilon_i : [M_i] \rightarrow \{-1, 1\}$. By letting $M = M_1 + \dots + M_k$ and concatenating c_i 's and ε_i 's, we may define $c : [M] \rightarrow [L]$ and $\varepsilon : [M] \rightarrow \{-1, 1\}$. Our goal is to compute

$$\mathbb{E}[\text{Tr}(B(\Gamma))],$$

where

$$\text{Tr}(B(\Gamma)) := \text{Tr}(B(\Gamma_1)) \cdots \text{Tr}(B(\Gamma_k)), \text{ and } B(\Gamma_i) = B_T^{\varepsilon_i(1)}(\lambda_{c_i(1)}) \cdots B_T^{\varepsilon_i(M_i)}(\lambda_{c_i(M_i)}),$$

and where $\{B_T(\lambda_\ell)\}_{\ell \in [L]}$ is a collection of independent Brownian motions on $U(N)$ started at the identity and run for time $T > 0$. We also define

$$\mathcal{C} = \bigcup_{\ell \in [L]} \binom{c^{-1}(\ell)}{2} = \{(m, m^*) : m < m^* \text{ and } c(m) = c(m^*)\},$$

and

$$\mathcal{D}_T = \bigsqcup_{(m, m^*) \in \mathcal{C}} [0, T],$$

equipped with some parametrizing bijection $\eta : \mathcal{C} \times [0, 1] \rightarrow \mathcal{D}_T$.⁵ Given a point $x \in \mathcal{D}_T$, let $\ell(x) \in \mathcal{C}$ be the index of the interval which contains x . We now consider the Poisson point process Σ on \mathcal{D}_T with intensity given by the Lebesgue measure. Equivalently, Σ has the same law with $\Sigma_\infty \cap \mathcal{D}_T$ where Σ_∞ is the Poisson point process on

$$\mathcal{D}_\infty = \bigsqcup_{(m, m^*) \in \mathcal{C}} [0, \infty)$$

with intensity given by the Lebesgue measure. In other words, Σ_∞ is a disjoint union of i.i.d. rate 1 Poisson processes on $[0, \infty)$.

As we previously alluded to, expectations of Unitary Brownian motion may be represented by a certain diagram which is obtained from a Poisson process on \mathcal{D}_T . To begin to make this statement precise, in the following definition, we describe how to associate a diagram to a given collection of points of \mathcal{D}_T .

⁵The bijection η is only to record the location of points. In [PPSY23], the interval $[0, T_{c(m)}]$ is identified as the interior of each loop (so that η is a space-filling curve) for more geometric interpretation, but the Lebesgue measures are identical in the end.

Definition 2.1 (Strand diagram). Let $\Gamma = \lambda_{c(1)}^{\varepsilon(1)} \cdots \lambda_{c(M)}^{\varepsilon(M)}$ be a word on $\{\lambda_1, \dots, \lambda_L\}$ and Σ be a collection of points in \mathcal{D}_T . Then $\eta^{-1}(\Sigma)$ be a collection of points $((m, m^*), t) \in \mathcal{C} \times [0, 1]$ for $(m, m^*) \in \mathcal{C}$ and $t \in [0, 1]$. Let $n_\ell = |c_i^{-1}(\ell)|$ for each $\ell \in [L]$. The **strand diagram** of (Γ, Σ) is an array of right- or left-directed arrows, each of which is identified as the unit interval $[0, 1]$, placed as follows.

- There are L columns and each column is labelled by λ_ℓ for $\ell \in [L]$;
- The column labeled by λ_ℓ consists of a stack of n_ℓ unit-length arrows, each of which corresponds to an element of $c_i^{-1}(\ell)$;
- If an arrow corresponds to $m = c_i^{-1}(\ell) \in [M]$, it is right-directed (resp. left-directed) if $\varepsilon(m) = 1$ (resp. $\varepsilon(m) = -1$);
- The end of arrow corresponding to m is connected to the origin of the arrow corresponding to $m + 1$, modulo M ;
- For each point $((m, m^*), t) \in \eta^{-1}(\Sigma)$, if $\varepsilon(m)\varepsilon(m^*) = 1$, we insert a green crossing (called the “same-direction swap”) on two arrows corresponding to m and m^* at location $t \in [0, 1]$. Otherwise, we put a blue double bar (called the “opposite-direction swap”) on two arrows corresponding to m and m^* at location $t \in [0, 1]$.

In general, if $\mathbf{\Gamma} = (\Gamma_1, \dots, \Gamma_k)$ is a collection of words Γ_i on $\{\lambda_1, \dots, \lambda_L\}$, we define the strand diagram of $(\mathbf{\Gamma}, \Sigma)$ as a collection of strand diagrams of $(\Gamma_1, \Sigma_1), \dots, (\Gamma_k, \Sigma_k)$ where $\Sigma = \bigsqcup_{i=1}^k \Sigma_i$ with the same labelled columns. See Figure 5 for an example.

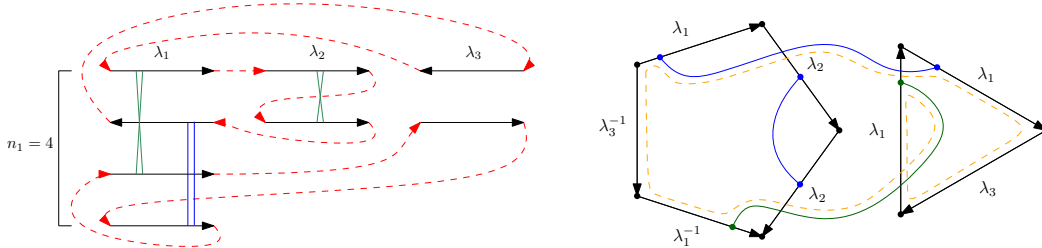

Figure 5: **Left:** The strand diagram for $((\Gamma_1, \Gamma_2), \Sigma)$ with $\Gamma_1 = \lambda_1 \lambda_2 \lambda_2 \lambda_1^{-1} \lambda_3^{-1}$, $\Gamma_2 = \lambda_1 \lambda_3 \lambda_1$, and $\eta^{-1}(\Sigma) = \{((1, 6), 1/4), ((2, 3), 1/2), ((4, 8), 3/4)\}$. For example, the first and sixth alphabet in the word Γ are λ_1 's, so we put a green crossing at the 1/4 location of two unit intervals representing those. Similarly, we put a blue double bar at the 3/4 location of two unit intervals representing λ_1^{-1} and λ_1 . **Right:** The CW-complex constructed from the left strand diagram. By following each 1-cells and closing each cycle by adding a new 2-cell, we obtain a closed surface whose Euler characteristic defines the Euler characteristic of the strand diagram. The orange dashed line is an example of a 2-cell we add. Including this face, we need 3 faces in total to obtain a closed surface with the minimum genus. Therefore, the Euler characteristic of this surface is equal to $V - E + F = 14 - 17 + 5 = 2$, and the resulting surface is a sphere.

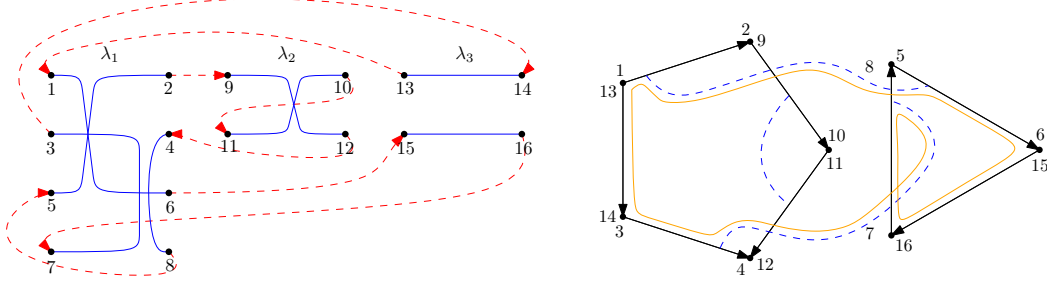

Figure 6: **Left:** The same strand diagram as Figure 5 but with ends of arrows labelled. By following all swaps, each row of the strand diagram defines a matching on $[2n_\ell]$ for $\ell = 1, 2, 3$. **Right:** The corresponding CW complex picture with labels. It is straightforward that the number of components in the left picture is exactly the number of faces in this picture.

We define a CW-complex from a strand diagram as in Figure 5. Each word Γ_i can be represented by a regular polygon with unit-length arrows (preserving the orientation), and each same-direction swap or opposite-direction swap corresponds to a path connecting two arrows at the specified location in the strand diagram. As a result, we have k 2-cells for each polygon, $M + 2|\Sigma|$ 1-cells, and $M + 2|\Sigma|$ 0-cells, where $M = n_1 + \dots + n_L$. Then there exists a *closed* surface with the minimum genus constructed by adding extra F 2-cells, that is by following every 1-cell and adding a 2-cell whenever they form a cycle. (Equivalently, it can be viewed as a *ribbon graph*.) By Euler's formula, the number F of extra 2-cells determines the minimum genus, that is $\chi = (M + 2|\Sigma|) - (M + 3|\Sigma|) + (k + F) = k + F - |\Sigma|$. We define the Euler characteristic χ of the strand diagram as the Euler characteristic of this surface with the minimum genus.

We now give a precise statement of how Unitary Brownian motion expectations reduce to certain diagrammatic sums. We quote the following result from [PPSY23].

Lemma 2.2 (Expected trace as Poisson sums [PPSY23]). Let $\mathbf{\Gamma}$ be a collection of words on $\{\lambda_1, \dots, \lambda_L\}$ and $T > 0$. Let Σ be the Poisson point process on \mathcal{D}_T . Consider the strand diagram S for $(\mathbf{\Gamma}, \eta^{-1}(\Sigma))$. Then

$$\mathbb{E}[\text{Tr}(B(\mathbf{\Gamma}))] = \exp\left(-\frac{1}{2} \sum_{m=1}^M T + \sum_{(m, m^*) \in \mathcal{C}} T\right) \mathbb{E}\left[\varepsilon(\Sigma)(-1)^{|\Sigma|} N^{-k+\chi(S)}\right].$$

Lemma 2.2 may be interpreted as follows. First, observe that for each individual letter λ_ℓ , the portion of the strand diagram corresponding to λ_ℓ may be thought of as a matching on $[2n_\ell]$, see Figure 6. In order to compute the Euler characteristic $\chi(S)$ of a given strand diagram S , it suffices to give the partitions π_1, \dots, π_L of $[2n_1], \dots, [2n_L]$, respectively. In particular, the number of vertices $V(S)$ is precisely the number of components of the diagram given by combining the exterior connections (which we have been drawing as dashed red lines) with the interior connections specified by $\pi = (\pi_1, \dots, \pi_L)$. Let $\#\text{comp}(\mathbf{\Gamma}, \pi)$ be the number of components of the diagram arising from $\mathbf{\Gamma}, \pi$. Define also

$$w_T(\pi) := \exp\left(\sum_{\ell \in [L]} \left(\binom{n_\ell}{2} - n_\ell\right) T\right) \mathbb{E}\left[\varepsilon(\Sigma)(-1/|N|)^{|\Sigma|} \mathbb{1}(\pi(S) = \pi)\right], \quad (2.1)$$

which is interpreted as the partition function of all point configurations which results in the collection of partitions π . From these considerations, combined with Lemma 2.2, we have the following.

Lemma 2.3. Let $\mathbf{\Gamma}$ be a collection of words on $\{\lambda_1, \dots, \lambda_L\}$. Let Σ be the Poisson point process on \mathcal{D}_T . Consider the strand diagram S for $(\mathbf{\Gamma}, \eta^{-1}(\Sigma))$. Then

$$\mathbb{E}[\text{Tr}(B_T(\mathbf{\Gamma}))] = \sum_{\pi=(\pi_1, \dots, \pi_L)} w_T(\pi) N^{\#\text{comp}(\mathbf{\Gamma}, \pi)}. \quad (2.2)$$

Lemma 2.3 says that in order to compute the expectations of traces of words of Unitary Brownian motion, we may perform a weighted sum over all partitions of the corresponding strand diagram, where the weights are given by $w_T(\pi)$, and the statistic we are averaging over is N raised to the number of components of the diagram made from the exterior connections specified by the collection of words $\mathbf{\Gamma}$ and the interior connections specified by the collection of partitions π . See also Figure 7 for a visualization.

We proceed to give a precise statement of Theorem 1.5, which is we are able to obtain the $T \rightarrow \infty$ limit of the right-hand side of (2.2). First, we make the following definition.

Definition 2.4 (Balanced collection of words). A collection of words $\mathbf{\Gamma} = (\Gamma_1, \dots, \Gamma_k)$ on letters $\{\lambda_1, \dots, \lambda_L\}$ is balanced if for each letter λ_i , the number of times that λ_i appears in $\mathbf{\Gamma}$ is equal to the number of times λ_i^{-1} appears in $\mathbf{\Gamma}$.

Next, we describe a certain special set of partitions that plays a key role in the limiting formula. Suppose that $\mathbf{\Gamma}$ is balanced. Then n_ℓ is even for all $\ell \in [L]$. Given a pair of bijections $\sigma, \tau : [n_\ell/2] \rightarrow (n_\ell/2 : n_\ell]$, we may obtain a partition $[\sigma \tau]$ of $[2n_\ell]$ as in Figure 8.

Clearly, the set of all partitions that arise this way is a strict subset of the set of all partitions of $[2n_\ell]$. Observe that $\sigma\tau^{-1} : [n_\ell/2] \rightarrow [n_\ell/2]$ is a bijection, and thus we may view $\sigma\tau^{-1} \in S_{n_\ell/2}$. It turns out that as $T \rightarrow \infty$, these are the only partitions that have a non-vanishing weight. This is inherent in the following theorem. Its proof is the subject of Section 4.

Theorem 2.5. Let $\mathbf{\Gamma} = (\Gamma_1, \dots, \Gamma_M)$ be a balanced collection of words on $\{\lambda_1, \dots, \lambda_L\}$. Then

$$\lim_{T \rightarrow \infty} \mathbb{E}[\text{Tr}(B_T(\mathbf{\Gamma}))] = \sum_{\pi=(\sigma_\ell \tau_\ell), \ell \in [L]} \left(\prod_{\ell \in [L]} \text{Wg}_N(\sigma_\ell \tau_\ell^{-1}) \right) N^{\#\text{comp}(\mathbf{\Gamma}, \pi)}.$$

Here, the sum in the right hand side is over π which can be obtained from pairs of bijections $\sigma_\ell, \tau_\ell : [n_\ell/2] \rightarrow (n_\ell/2 : n_\ell]$, $\ell \in [L]$.

Recall we defined the Weingarten function Wg_N when N is large in Section 1.4.1 (in particular, see (1.7)). We will give the definition for general values of N in Section 2.2 – see Definition 2.21.

Remark 2.6. In Theorem 2.5, it suffices to only look at balanced $\mathbf{\Gamma}$, because if $\mathbf{\Gamma}$ is not balanced, then $\lim_{T \rightarrow \infty} \mathbb{E}[\text{Tr}(B_T(\mathbf{\Gamma}))] = 0$, due to known properties of Haar integration.

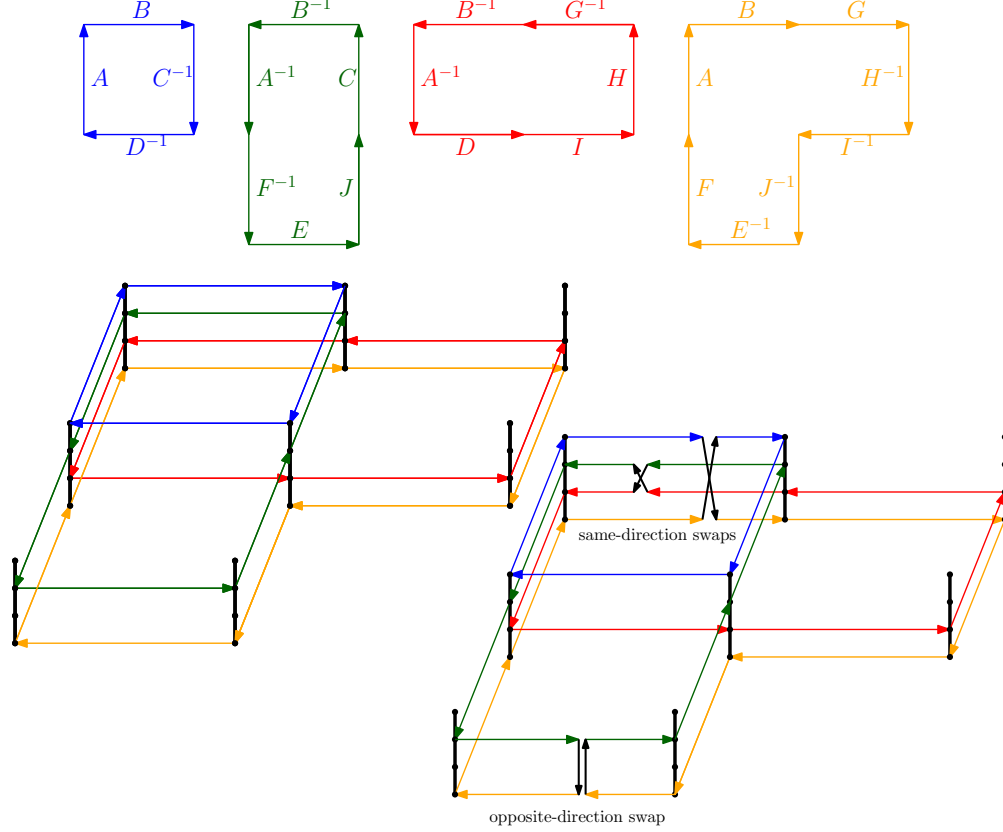

Figure 7: $\mathbb{E} \left[\text{tr}(ABC^{-1}D^{-1})\text{tr}(A^{-1}F^{-1}EJCB^{-1})\text{tr}(A^{-1}DIHG^{-1}B^{-1})\text{tr}(BGH^{-1}I^{-1}E^{-1}FA) \right]$ is the expected trace product of the four loops above, where the symbols are i.i.d. random elements of $U(N)$. [PPSY23] explains one way to compute this quantity when each symbol has the law of the time- T value of a Brownian motion on $U(N)$ started at the identity. First one stacks the strands on of each other (lower left) so that the arrows corresponding to the same symbol lie on top of each other. Then one chooses locations for “swaps” according to a certain Poisson point process (lower right). The desired expectation is a constant times $\mathbb{E} \left[(-1/N)^{\# \text{ same-dir swaps}} N^{\# \text{ components}} \right]$. As $t \rightarrow \infty$ the expected number of swaps tends to infinity. In this paper we derive the $t \rightarrow \infty$ limit by starting with the formulation above and applying simple geometric arguments and sign cancellations.

Since Unitary Brownian motion converges in distribution to the normalized Haar measure in the large-time limit, the combination of Lemma 2.3 and Theorem 2.5 allows us to obtain the Weingarten calculus as a corollary, which we state in the following form. Similar to existing notation, we denote $\text{Tr}(U(\mathbf{\Gamma})) := \text{Tr}(U(\Gamma_1)) \cdots \text{Tr}(U(\Gamma_k))$, where $U(\Gamma_i)$ is obtained by substituting an independent Haar-distributed Unitary matrix for each letter.

Corollary 2.7. Let $\mathbf{\Gamma} = (\Gamma_1, \dots, \Gamma_M)$ be a balanced collection of words on $\{\lambda_1, \dots, \lambda_L\}$. Then

$$\mathbb{E}[\text{Tr}(U(\mathbf{\Gamma}))] = \sum_{\pi = ([\sigma_\ell \tau_\ell], \ell \in [L])} \left(\prod_{\ell \in L} \text{Wg}_N(\sigma_\ell \tau_\ell^{-1}) \right) N^{\# \text{comp}(\mathbf{\Gamma}, \pi)}.$$

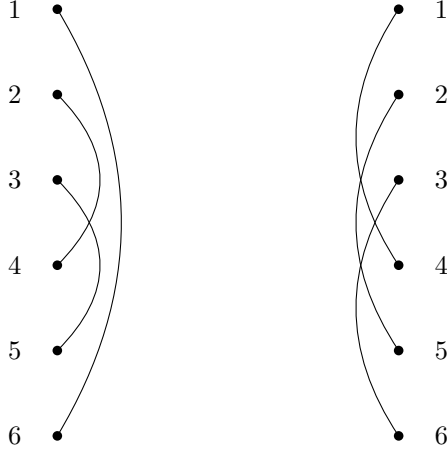

Figure 8: Example when $n_\ell = 6$. Here σ_ℓ maps $1 \mapsto 6$, $2 \mapsto 4$, $3 \mapsto 5$, and τ_ℓ maps $1 \mapsto 4$, $2 \mapsto 5$, $3 \mapsto 6$.

Here, the sum in the right hand side is over π which can be obtained from pairs of bijections $\sigma_\ell, \tau_\ell : [n_\ell/2] \rightarrow (n_\ell/2 : n_\ell]$, $\ell \in [L]$.

This corollary has a similar interpretation as Lemma 2.3 in terms of a weighted sum, with the previous weights $w_T(\pi_\ell)$ replaced by Weingarten weights $\text{Wg}_N(\sigma_\ell \tau_\ell^{-1})$.

Remark 2.8. Having understood the statement of Corollary 2.7, the reader who wants to understand the surface-sum representation of Wilson loop expectations as quickly as possible may now skip ahead to Section 3. The remainder of the material in this section is only needed starting from Section 4.

We finish off this subsection with an instructive example which illustrates how one may compute $\#\text{comp}(\Gamma, \pi)$ for a given Γ, π .

Example 2.9. Suppose our letters are $\{A, B\}$, and our words are $\Gamma_1 = \Gamma_2 = ABA^{-1}B^{-1}$. Since each of A, B, A^{-1}, B^{-1} appears twice total in Γ_1, Γ_2 , we start with the diagram in the left of Figure 9. Notice that we have labeled the vertices of each strand by a number, which will come in handy later when we want to represent the number of connected components of the resulting diagram after including the interior and exterior connections. The choice of words affects the exterior connections of the strand diagram. For instance, in our current example, we would include the exterior connections as illustrated in the right of Figure 9.

Now ignoring for the moment the exterior connections, suppose we have pairs of matchings of the strand diagrams as indicated in the left Figure 10. Now the specific statistic we need to compute is the number of connected components of the following diagram, which is essentially obtained by including both the interior (blue) and exterior (red) connections – see the right of Figure 10.

We now make use of the vertex labels. In general, the various connected components of the diagram may be indexed by the cycles of a permutation. In this case, the permutation is on 16 elements. The cycles are obtained by starting at a given vertex and alternately following the dashed red lines and solid blue lines. For instance, in the above figure, we get a single cycle: $(1\ 11\ 10\ 7\ 5\ 15\ 14\ 3\ 2\ 12\ 9\ 8\ 6\ 16\ 13\ 4)$, which implies that there is a single connected component.

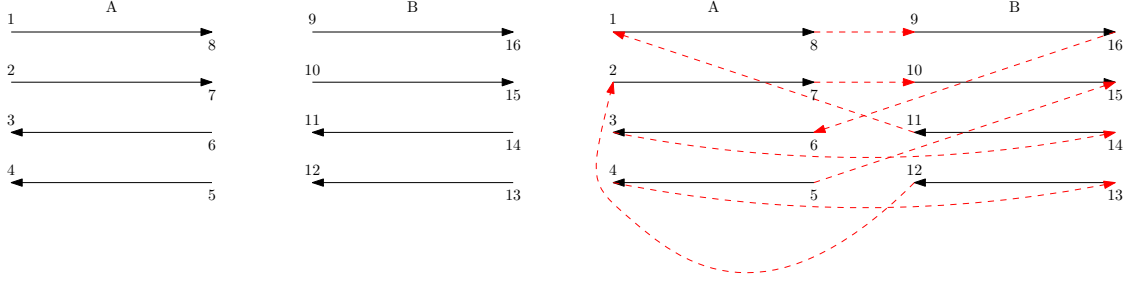

Figure 9: Left: Letters A and B with four strands each. Right: the exterior connections on the strand diagram specified by (Γ_1, Γ_2) .

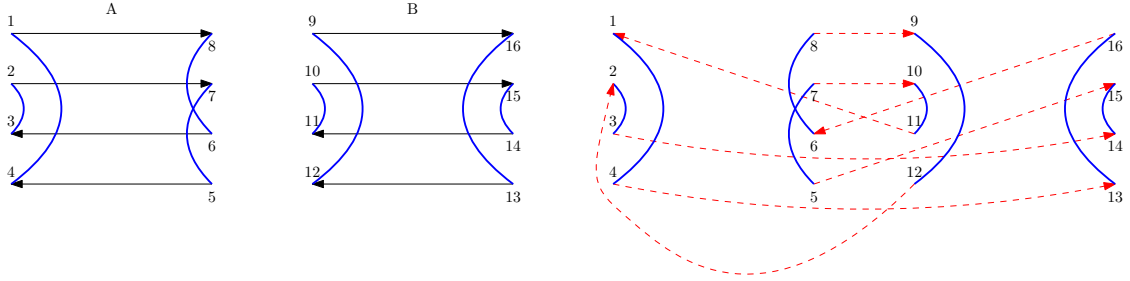

Figure 10: Left: blue interior connections. Right: combining the interior and exterior connections.

2.2 Representation theory and other preliminaries

The strand diagrams of Section 2.1 may naturally be viewed as elements of the so-called Brauer algebra, which is a well-studied object in mathematics. We proceed to introduce the Brauer algebra because this will form a convenient language when phrasing our proofs.

Definition 2.10 (Brauer algebra). For $n \geq 1$, let $\mathcal{M}(n)$ be the space of matchings of $[2n]$, i.e. partitions of $[2n]$ into two-element sets. We will view matchings pictorially as in Figure 11.

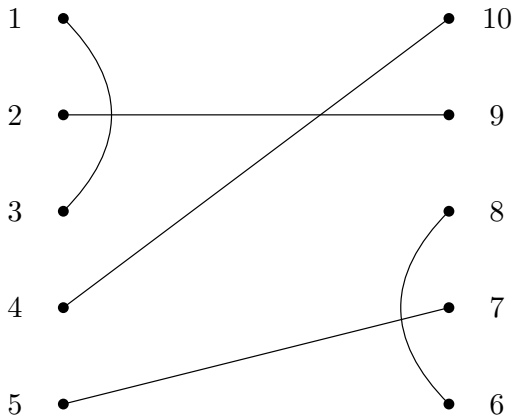

Figure 11: $\pi = \{\{1, 3\}, \{2, 9\}, \{4, 10\}, \{5, 7\}, \{6, 8\}\}$

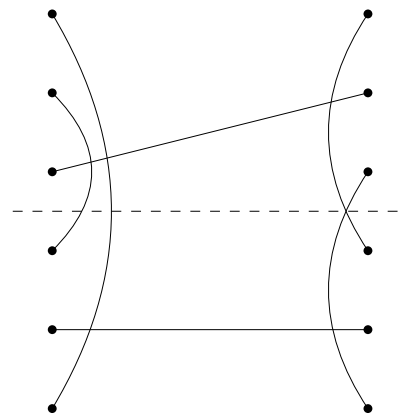

Figure 12: Element of $\mathcal{B}_{3,3}$

We refer to pairs that involve both a left and right element as “left-right pairings”, and

pairs that involve two left elements or two right elements as “same-side pairings”. In the above picture, $\{1, 3\}, \{6, 8\}$ are same-side pairings, while $\{2, 9\}, \{4, 10\}, \{5, 7\}$ are left-right pairings.

Let \mathcal{B}_n be the vector space of \mathbb{C} -valued functions on $\mathcal{M}(n)$. We will often view elements $f \in \mathcal{B}_n$ as formal sums $f = \sum_{\pi} f(\pi)\pi$, where π ranges over $\mathcal{M}(n)$.

Fix $\zeta \in \mathbb{C}$. We may define a product of matchings $\pi_1, \pi_2 \in \mathcal{M}(n)$ as in Figure 13.

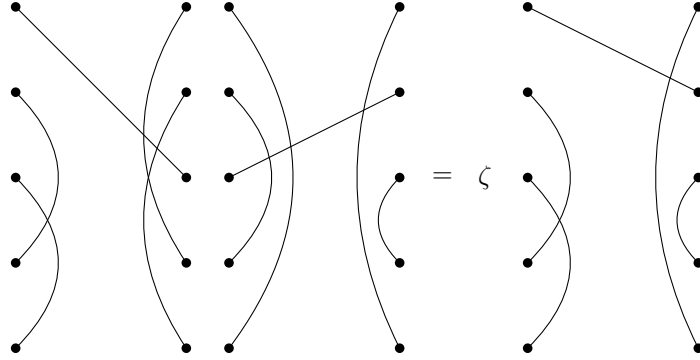

Figure 13: Example of multiplication in the Brauer algebra.

In words, we put π_1, π_2 together side-by-side, and then follow the lines to obtain a new matching. Any closed loops incur a factor of ζ . Observe that this product induces a product on \mathcal{B}_n which turns \mathcal{B}_n into an algebra. Explicitly, if we represent $f, g \in \mathcal{B}_n$ by formal linear combinations $f = \sum_{\pi_1 \in \mathcal{M}(n)} f(\pi_1)\pi_1$, $g = \sum_{\pi_2 \in \mathcal{M}(n)} g(\pi_2)\pi_2$, then the product fg is given by:

$$fg = \sum_{\pi_1, \pi_2 \in \mathcal{M}(n)} f(\pi_1)g(\pi_2)\pi_1\pi_2.$$

We refer to \mathcal{B}_n as the Brauer algebra.

Remark 2.11. Typically, elements of \mathcal{B}_n are drawn as top-bottom matchings, yet here we have chosen to draw them as left-right matchings.

In what follows, we always take $\zeta = N$. This is the choice of ζ which relates multiplication in the Brauer algebra with expectations of Unitary Brownian motion: note that the factor of N that we incur when we form a loop exactly matches the factor of N that we incur in the strand diagram when we add another connected component.

We specify a norm on \mathcal{B}_n , which will enable us to later talk about convergence in \mathcal{B}_n .

Definition 2.12 (Norm on \mathcal{B}_n). For $f \in \mathcal{B}_n$, define $\|f\|$ to be the L^1 norm, i.e. $\|f\| := \sum_{\pi \in \mathcal{M}(n)} |f(\pi)|$.

Next, we define a certain sub-algebra of the Brauer algebra, called the walled Brauer algebra. This arises naturally in computing expectations of Unitary Brownian motion, as it turns out that the strand diagrams of Section 2.1 are not only elements of the Brauer algebra, but even more they are elements of the walled Brauer algebra.

Definition 2.13 (Walled Brauer algebra). Let $n, m \geq 1$. Let $\mathcal{M}(n, m) \subseteq \mathcal{M}(n + m)$ be the subset of matchings of $[2(n + m)]$ such that every same-side pairing is between a top n element and bottom m element, while every left-right pairing is between two top n elements or two bottom m elements. Pictorially, one imagines a dashed line separating the top n elements from the bottom m elements, and the only pairings which can cross this dashed line are same-side pairings. See Figure 12 for an example when $n = m = 3$.

The walled Brauer algebra $\mathcal{B}_{n,m}$ is the sub-algebra of \mathcal{B}_{n+m} consisting of functions $f \in \mathcal{B}_{n+m}$ which are supported on the matchings $\mathcal{M}(n, m)$. One may check that given two matchings $\pi_1, \pi_2 \in \mathcal{M}(n, m)$, their product $\pi_1\pi_2$ is proportional to a matching in $\mathcal{M}(n, m)$. This implies that the product on \mathcal{B}_{n+m} descends to a product on $\mathcal{B}_{n,m}$.

Observe that S_n can be embedded in $\mathcal{M}(n) \subseteq \mathcal{B}_n$ as follows. Given $\sigma \in S_n$, we can view it as an element of $\mathcal{M}(n)$ as in Figure 14.

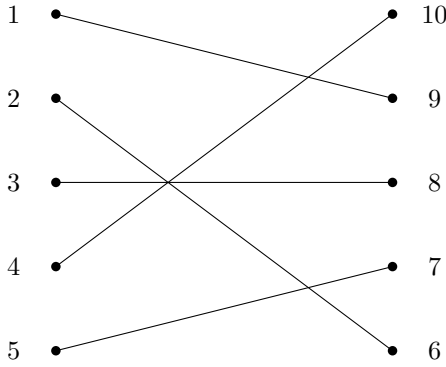

Figure 14: $\sigma = (1\ 2\ 5\ 4)$

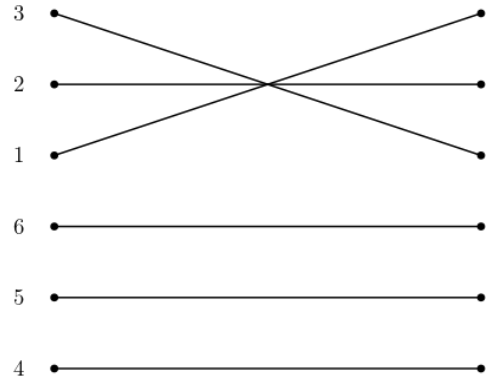

Figure 15: $(1\ 3)$

We may also embed S_n into $\mathcal{M}(n, n) \subseteq \mathcal{B}_{n,n}$ as follows. by connecting the top n vertices on the left and right as we did to embed S_n into \mathcal{B}_n , and then connecting the bottom n vertices on the left and right by straight lines.

Next, we define the following notation for certain special elements of the walled Brauer algebra $\mathcal{B}_{n,m}$. These correspond to the same-direction and opposite-direction swaps introduced in Section 2.1.

Definition 2.14. Given $1 \leq i < j \leq n$ or $n + 1 \leq i < j \leq n + m$, define $(i\ j) \in \mathcal{B}_{n,m}$ to be the pairing of $[2(n + m)]$ which swaps the i, j vertices with their corresponding versions on the right, while keeping the other vertices fixed. This is best explained by the example in Figure 15 when $n = m = 3$.

Given $1 \leq i \leq n$ and $n + 1 \leq j \leq n + m$, let $\langle i\ j \rangle$ be the pairing which has a same-side pairing between i, j on the left, as well as their corresponding versions on the right, while keeping the other vertices fixed. See Figure 16 for an example when $n = m = 3$.

Next, we define the following notation for another set of special elements of the walled Brauer algebra $\mathcal{B}_{n,n}$. These elements are matchings which have no left-right pairings.

Definition 2.15. Let $\sigma, \tau : [n] \rightarrow [n]$ be bijections. Define $[\sigma\ \tau] \in \mathcal{B}_{n,n}$ to be the element of the walled Brauer algebra which is given by σ on the left and τ on the right. See the Figure 17 for an example when $n = 3$.

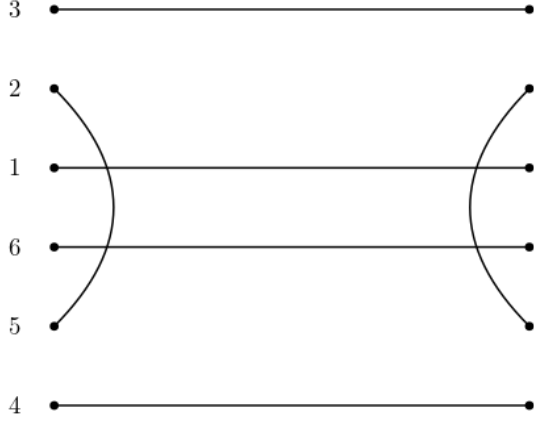

Figure 16: $\langle 2\ 5 \rangle$

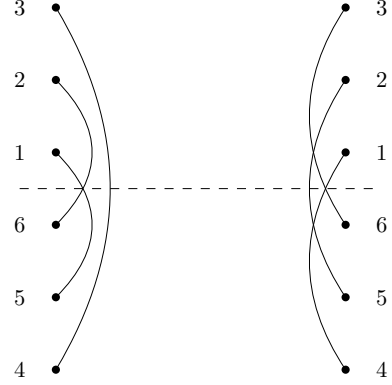

Figure 17: $\sigma = \{1 \mapsto 5, 2 \mapsto 6, 3 \mapsto 4\}$, $\tau = \{1 \mapsto 4, 2 \mapsto 5, 3 \mapsto 6\}$

Note the particular way we have chosen to label the vertices in Figure 17. From now on, this is how we will label vertices when working with the walled Brauer algebra $\mathcal{B}_{n,n}$. Ultimately the labeling will not matter, but we have chosen to label in this way to better relate to the Jucys-Murphy elements, which we next define.

Definition 2.16 (Jucys-Murphy elements). For $n \geq 2$, define the Jucys-Murphy element $J_n := (1\ n) + \cdots + (n-1\ n) \in \mathbb{C}[S_n]$. We also view $J_n \in \mathbb{C}[S_m]$ for any $n \leq m$. Define $J_1 := 0$.

Remark 2.17. One may show that the Jucys-Murphy elements commute with each other.

In the following, we will also view J_1, \dots, J_n as elements of $\mathcal{B}_{n,n}$, by using the previously mentioned embedding of $S_n \subseteq \mathcal{B}_{n,n}$. We will also need to refer to Jucys-Murphy elements which act on bottom elements rather than top elements. We define this next.

Definition 2.18. Let $n, m \geq 1$. Define $J'_1, \dots, J'_m \in \mathcal{B}_{n,m}$ by

$$J'_k := (n+1\ n+k) + \cdots + (n+k-1\ n+k), \quad k \in [m].$$

Definition 2.19 (Norm on group algebra). For $f \in \mathbb{C}[S_n]$, we define $\|f\|$ to be the L^1 norm, i.e. $\|f\| := \sum_{\pi \in S_n} |f(\pi)|$.

Note that our norm on $\mathbb{C}[S_n]$ and on \mathcal{B}_n are compatible with our embeddings $\mathbb{C}[S_n] \subseteq \mathcal{B}_n$ and $\mathbb{C}[S_n] \subseteq \mathcal{B}_{n,n} \subseteq \mathcal{B}_{2n}$.

Remark 2.20. With this definition of the norm, we have that $\|fg\| \leq \|f\| \cdot \|g\|$ for $f, g \in \mathbb{C}[S_n]$. This implies that $\|e^f\| \leq e^{\|f\|}$, which further implies that if $\|f\| < 1$, then

$$\int_0^\infty e^{-u(\text{id}+f)} du \in \mathbb{C}[S_n]$$

converges absolutely. Moreover, one has that

$$\int_0^\infty e^{-u(\text{id}+f)} du = (\text{id} + f)^{-1}.$$

Next, we discuss an alternate form of the Weingarten function Wg_N which arises naturally in the proof of Theorem 2.5. First, suppose $N \geq n$. The case of general N will be addressed a bit later. Then $\text{Wg}_N \in \mathbb{C}[S_n]$ is the following inverse:

$$\text{Wg}_N := \left(\sum_{\sigma \in S_n} N^{\#\text{cycles}(\sigma)} \sigma \right)^{-1}.$$

Jucys [Juc74] proved the following identity:

$$\sum_{\sigma \in S_n} N^{\#\text{cycles}(\sigma)} \sigma = (N + J_n) \cdots (N + J_1). \quad (2.3)$$

Note that when $N \geq n$, each $N + J_k$ for $k \in [n]$ is invertible because then $\|J_k\| = k - 1 < N$ (recall Remark 2.20), with inverse given by:

$$(N + J_k)^{-1} = N(\text{id} + J_k/N)^{-1} = N \int_0^\infty e^{-u(\text{id} + J_k/N)} du.$$

Since the J_1, \dots, J_n commute with each other, we have that (as observed by [Nov10])

$$\text{Wg}_N = (N + J_n)^{-1} \cdots (N + J_1)^{-1}, \quad \text{when } N \geq n. \quad (2.4)$$

The reason why we introduce this formula for the Weingarten function is because the terms $(N + J_k)^{-1}$, $k \in [n]$ will appear naturally in our argument.

Next, we discuss the definition of the Weingarten function in case of general N . We follow [CS06].

Definition 2.21 (Weingarten function). Let $N, n \geq 1$. Define $\text{Wg}_N \in \mathbb{C}[S_n]$ (as usual, we omit the dependence on n) by

$$\text{Wg}_N(\sigma) := \frac{1}{n!} \sum_{\substack{\lambda \vdash n \\ \ell(\lambda) \leq N}} \left[\chi_\lambda(\text{id}) \chi_\lambda(\sigma) \prod_{(i,j) \in \lambda} (N + j - i)^{-1} \right]. \quad (2.5)$$

Here, $\ell(\lambda)$ is the number of rows of λ , i.e. the number of parts in the partition of n given by λ .

Compared with the formula (1.7) for $N \geq n$, the only difference is in the restriction $\ell(\lambda) \leq N$ when summing over Young diagrams λ . Note that when $N \geq n$, every Young diagram with n boxes has at most $n \leq N$ rows, and thus the definition (2.5) reduces to (1.7) if $N \geq n$.

2.2.1 Additional technicalities for the small N case

The following material is only needed to prove Theorem 2.5 in the case $N < 2 \max_{\ell \in [L]} n_\ell$. We encourage the reader on a first reading to skip this subsection and continue on to Section 4 to first read over the proof in the case $N \geq 2 \max_{\ell \in [L]} n_\ell$, which already contains the main probabilistic ideas. The reader may come back to this section once they are ready to read Section 4.2, where the results introduced here will be needed.

Let e_1, \dots, e_N denote the standard basis of \mathbb{C}^N . The tensor space $(\mathbb{C}^N)^{\otimes n}$ has a basis given by $(e_i, i = (i_1, \dots, i_n) \in [N]^n)$, where $e_i := e_{i_1} \otimes \dots \otimes e_{i_n}$. The space $(\mathbb{C}^N)^{\otimes n}$ has a natural inner product which when restricted to basis elements is given by

$$\langle e_i, e_j \rangle = \delta_{ij} = \delta_{i_1 j_1} \cdots \delta_{i_n j_n}.$$

Let $M \in \text{End}((\mathbb{C}^N)^{\otimes n})$. One may think of M as an $N^n \times N^n$ matrix, whose matrix entries are given by:

$$M_{ij} = \langle e_i, M e_j \rangle, \quad i, j \in [N]^n.$$

In particular, if $M_1, \dots, M_n \in \text{End}(\mathbb{C}^N)$, then the matrix entries of the tensor product $M = M_1 \otimes \dots \otimes M_n$ are given by

$$\begin{aligned} M_{ij} &= \langle e_i, (M_1 \otimes \dots \otimes M_n) e_j \rangle = \langle e_{i_1} \otimes \dots \otimes e_{i_n}, (M_1 e_{j_1}) \otimes \dots \otimes (M_n e_{j_n}) \rangle \\ &= \langle e_{i_1}, M_1 e_{j_1} \rangle \cdots \langle e_{i_n}, M_n e_{j_n} \rangle \\ &= (M_1)_{i_1 j_1} \cdots (M_n)_{i_n j_n}, \end{aligned}$$

i.e. the product of the corresponding matrix entries of M_1, \dots, M_n .

Definition 2.22. Let $N, n \geq 1$. We define a representation ρ_+ of \mathcal{B}_n as follows. Given a pairing π of $[2n]$, define $\rho_+(\pi)$ to be the linear map in $\text{End}((\mathbb{C}^N)^{\otimes n})$ whose matrix entries are given by:

$$(\rho_+(\pi))_{(i_1, \dots, i_n), (j_1, \dots, j_n)} := \prod_{\{a, b\} \in \pi} \delta^{i_a j_b}.$$

For notational brevity, we omit the dependence of ρ_+ on N, n . In the following, we mostly apply ρ_+ to elements of $\mathcal{B}_{n,n} \subseteq \mathcal{B}_{2n}$. The way one visualizes this definition is as follows. Suppose $n = 5$ and we are given the pairing displayed in Figure 18.

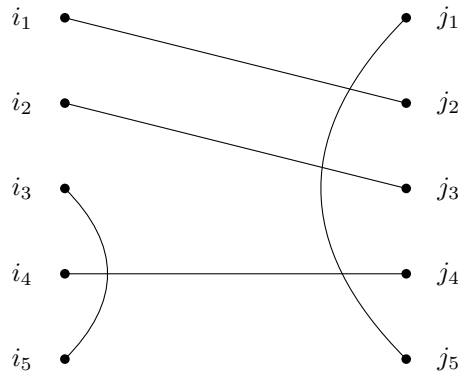

Figure 18: Visualization of matrix entries of $\rho_+(\pi)$.

Then the matrix entry corresponding to indices $(i_1, \dots, i_5), (j_1, \dots, j_5)$ is simply 1 if all constraints indicated by the pairing are satisfied (in this case, $i_1 = j_2, i_2 = j_3, i_3 = i_5, i_4 = j_4$, and $j_1 = j_5$), and 0 otherwise.

Remark 2.23. There is an alternative definition of ρ_+ that one typically sees (e.g. [Dah16]). First, let $E_{ij} \in \text{End}(\mathbb{C}^N)$ be the elementary matrix which has a 1 in its (i, j) entry and zeros everywhere else. We may write $E_{ij} = e_i e_j^T$. Then

$$\rho_+(\pi) = \prod_{\{a,b\} \in \pi} \delta^{i_a i_b} E_{i_1 i_{2n}} \otimes E_{i_2 i_{2n-1}} \otimes \cdots \otimes E_{i_n i_{n+1}}.$$

Here and in the following, repeated indices are implicitly summed over. To see why this definition is equivalent, we may compute an arbitrary matrix entry:

$$\begin{aligned} (\rho_+(\pi))_{(i_1, \dots, i_n), (i_{2n}, \dots, i_{n+1})} &= \prod_{\{a,b\} \in \pi} \delta^{j_a j_b} \langle e_{i_1} \otimes \cdots \otimes e_{i_n}, (E_{j_1 j_{2n}} \otimes \cdots \otimes E_{j_n j_{n+1}}) (e_{i_{2n}} \otimes \cdots \otimes e_{i_{n+1}}) \rangle \\ &= \prod_{\{a,b\} \in \pi} \delta^{j_a j_b} \langle e_{i_1}, e_{j_1} e_{j_{2n}}^T e_{i_{2n}} \rangle \cdots \langle e_{i_n}, e_{j_n} e_{j_{n+1}}^T e_{i_{n+1}} \rangle \\ &= \prod_{\{a,b\} \in \pi} \delta^{j_a j_b} \delta_{i_1 j_1} \delta_{j_{2n} i_{2n}} \cdots \delta_{i_n j_n} \delta_{j_{n+1} i_{n+1}} \\ &= \prod_{\{a,b\} \in \pi} \delta^{i_a i_b}. \end{aligned}$$

Recalling that we may view S_n as embedded in \mathcal{B}_n , the restriction of the representation ρ_+ to S_n defines a representation of S_n .

Definition 2.24. Let $N, n \geq 1$. Define the representation $\rho : \mathbb{C}[S_n] \rightarrow \text{End}((\mathbb{C}^N)^{\otimes n})$ to be the restriction of $\rho_+ : \mathcal{B}_n \rightarrow \text{End}((\mathbb{C}^N)^{\otimes n})$ to $\mathbb{C}[S_n] \subseteq \mathcal{B}_n$.

Again, we omit the dependence of ρ on N, n for notational brevity.

Remark 2.25. One may verify that ρ has the following explicit form on pure tensors:

$$\rho(\sigma)(v_1 \otimes \cdots \otimes v_n) = v_{\sigma(1)} \otimes \cdots \otimes v_{\sigma(n)}, \quad \sigma \in S_n, \quad v_1, \dots, v_n \in \mathbb{C}^N.$$

In words, $\rho(\sigma)$ acts by permutation of tensors.

Next, we discuss how the formula (2.4) needs to be modified when N is general. First, recall that when $N \geq n$, the Weingarten function may also be defined as the inverse of $\sum_{\sigma} N^{\#\text{cycles}(\sigma)} \sigma$ in $\mathbb{C}[S_n]$. For general N , this inverse may not exist. However, we quote the following result from [CS06], which says that the Weingarten function can still be interpreted as an inverse, in a suitable sense.

Lemma 2.26 (Section 2 of [CS06]). Let $N, n \geq 1$. We have that $\rho(\sum_{\sigma} N^{\#\text{cycles}(\sigma)} \sigma)$ is invertible, with inverse given by $\rho(\text{Wg}_N)$.

Remark 2.27. This is the whole point of introducing the representation ρ , in that $\rho(\sum_{\sigma} N^{\#\text{cycles}(\sigma)} \sigma)$ is always invertible as a matrix, even though $\sum_{\sigma} N^{\#\text{cycles}(\sigma)} \sigma$ may not be invertible in $\mathbb{C}[S_n]$. The simplest example of this difference is when $N = 1$ and $n = 2$, in which case $\sum_{\sigma} N^{\#\text{cycles}(\sigma)} \sigma = \text{id} + (1\ 2)$. Now clearly, $\text{id} + (1\ 2)$ is not invertible in $\mathbb{C}[S_2]$, because the inverse would be given in general by $a \cdot \text{id} + b \cdot (1\ 2)$, where $a, b \in \mathbb{C}$ solve the following system of equations:

$$a + b = 1,$$

$$a + b = 0.$$

On the other hand, when $N = 1$, the space $(\mathbb{C}^N)^{\otimes n}$ is one-dimensional no matter the value of n . On this space, both $\rho(\text{id})$ and $\rho((1\ 2))$ are the identity operator. (Recall that $\rho((1\ 2))(u \otimes v) = v \otimes u$. If $u, v \in \mathbb{C}$, then $v \otimes u = u \otimes v$, so that $\rho((1, 2))(u \otimes v) = u \otimes v$.) Thus $\rho(\text{id} + (1\ 2))$ acts as multiplication by 2, and thus $\rho(\text{id} + (1\ 2))^{-1}$ is multiplication by $1/2$.

Similarly, we next show that the elements $N + J_k$, $k \in [n]$ are always invertible, if we apply the representation ρ_+ .

Lemma 2.28. Let $N, n \geq 1$. Let $\rho_+ : \mathcal{B}_{n,n} \rightarrow \text{End}((\mathbb{C}^N)^{\otimes 2n})$ be the representation⁶ from Definition 2.22. For all $k \in [n]$, all eigenvalues of $\rho_+(J_k)$ are at least $-N + 1$.

Proof. Due to our embedding of S_n into $\mathcal{B}_{n,n}$, $\rho_+(J_k)$ acts as the identity on the last n coordinates of $(\mathbb{C}^N)^{\otimes 2n}$. On the first n coordinates, $\rho_+(J_k)$ acts as $\rho(J_k)$ (as defined in Definition 2.24). Thus, it suffices to show that all eigenvalues of $\rho(J_k)$ are at least $-N + 1$. This follows from the combination of two classic results in the representation theory of the symmetric group:

1. By Schur-Weyl duality (see e.g. [CS06, Theorem 2.1]), we have that in the decomposition of ρ into irreps, only those irreps corresponding to Young diagrams λ with at most N rows (i.e. $\ell(\lambda) \leq N$) appear.
2. Let ρ^λ be the irrep corresponding to λ . The eigenvalues of $\rho^\lambda(J_k)$ are explicitly known: for each Young tableaux with shape λ , let (i, j) be the coordinates of the box which contains the integer k . Here, i is the row index and j the column index. Then $\rho^\lambda(J_k)$ has an eigenvalue equal to $j - i$. Moreover, all eigenvalues of $\rho^\lambda(J_k)$ arise this way. This result was proven by Jucys [Juc74] and independently later by Murphy [Mur81].

The second fact implies that the every eigenvalue of $\rho^\lambda(J_k)$ is at least $-\ell(\lambda) + 1$, since the box with the most negative value of $j - i$ is $(\ell(\lambda), 1)$. Combining this with the first fact, the desired result now follows. \square

This lemma shows that all for all $k \in [n]$, all eigenvalues of $\rho_+(N + J_k)$, are at least 1, and thus $\rho_+(N + J_k)$ is invertible. Moreover, we have the following lemma, which generalizes (2.4) to the case of general N .

Lemma 2.29. Let $N, n \geq 1$. We have that

$$\rho_+(\text{Wg}_N) = \rho_+(N + J_n)^{-1} \cdots \rho_+(N + J_1)^{-1}.$$

Proof. Due to our embedding of S_n into $\mathcal{B}_{n,n}$, for any element $f \in \mathbb{C}[S_n]$, the matrix $\rho_+(f) \in \text{End}((\mathbb{C}^N)^{\otimes 2n})$ acts as the identity on the last n coordinates of $(\mathbb{C}^N)^{\otimes 2n}$. On the first n coordinates, $\rho_+(f)$ acts as $\rho(f) \in \text{End}((\mathbb{C}^N)^{\otimes n})$. Thus it suffices to prove the claimed identity with ρ_+ replaced by ρ . Since ρ is a representation, we have that (using that the Jucys-Murphy elements commute with each other and applying (2.3) in the final identity)

$$\rho(N + J_n)^{-1} \cdots \rho(N + J_1)^{-1} = \rho((N + J_1) \cdots (N + J_n))^{-1} = \rho\left(\sum_{\sigma} N^{\#\text{cycles}(\sigma)} \sigma\right)^{-1}.$$

The desired result now follows by Lemma 2.26. \square

⁶Recall that $\mathcal{B}_{n,n} \subseteq \mathcal{B}_{2n}$. The representation ρ_+ is originally defined on \mathcal{B}_{2n} , here we restrict it to $\mathcal{B}_{n,n}$.

In the course of proving Theorem 2.5 for general values of N , we will also need the following technical lemma.

Lemma 2.30. Let $N, n \geq 1$. All eigenvalues of

$$\frac{1}{N} \rho(J_n + \cdots + J_1) \in \text{End}((\mathbb{C}^N)^{\otimes n})$$

are at least $-\frac{n}{2} + \frac{1}{2}$. More precisely, if $n = mN + r$ with $0 \leq r \leq N - 1$, then all eigenvalues are at least

$$-\frac{n}{2} + \frac{m^2}{2} + \frac{r}{2} - \frac{1}{2} \frac{r(r-1)}{N} + \frac{mr}{N}.$$

Proof. As noted in the proof of Lemma 2.28, by Schur-Weyl duality (see e.g. [CS06, Theorem 2.1]), we have that in the decomposition of ρ into irreps, only those irreps corresponding to Young diagrams λ with at most N rows (i.e. $\ell(\lambda) \leq N$) appear. Thus letting ρ^λ be the irrep corresponding to λ , it suffices to show the claim with ρ replaced by ρ^λ , for any Young diagram λ with at most N rows.

Towards this end, let λ be a Young diagram, for example as in Figure 19. As discussed

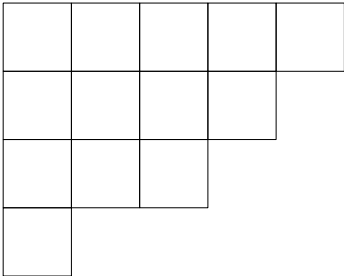

Figure 19: $5 + 4 + 3 + 1 = 13$

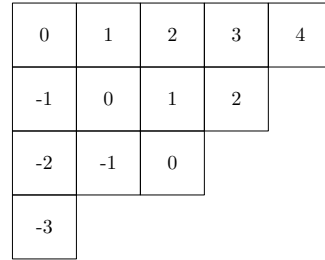

Figure 20: Young diagram with content labels

in the proof of Lemma 2.28, for $k \in [n]$ the eigenvalues of $\rho^\lambda(J_k)$ are given by the content of the k th box when we range over standard Young tableaux with shape λ . Even more, [Juc74, Mur81] show that the $(\rho^\lambda(J_k), k \in [n])$ have a joint eigenbasis indexed by standard Young tableaux with shape λ , where the eigenvalues corresponding to a given standard Young tableaux are the contents of the boxes of the Young diagram. This discussion shows that on each eigenbasis element, $\rho^\lambda(J_n + \cdots + J_1)$ acts in the same manner, that is as a whole $\rho^\lambda(J_1 + \cdots + J_n)$ acts as a multiple c_λ of the identity, where c_λ is the sum of contents of all the boxes in λ .

To envision the computation of c_λ , we label each box of λ with its content, i.e. the number $j - i$, where (i, j) is the row-column coordinate of the box. For the Young diagram in Figure 19, we have the labeling in Figure 20. The constant c_λ is then the sum of all box labels. For example, for the Young diagram in Figures 19 and 20, $c_\lambda = 6$.

Now, fix $n, N \geq 1$. To prove the lemma, we need to understand how negative the content sum c_λ may be for a Young diagram with n boxes and at most N rows. Clearly, to

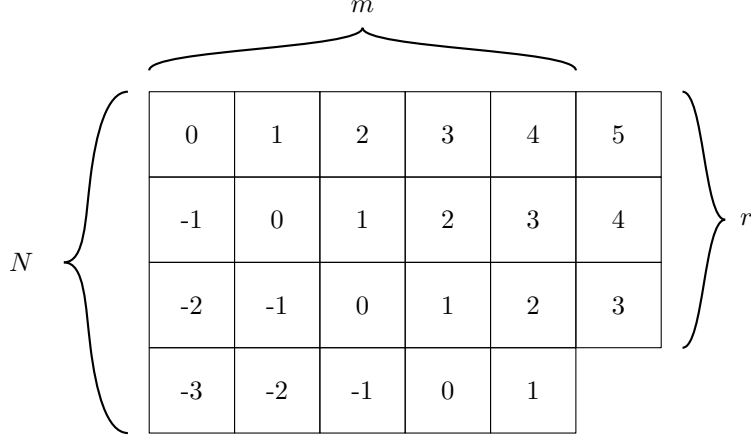

Figure 21: When $n = mN + r$, the “worst case” Young diagram in terms of smallest content sum.

minimize c_λ , we want a Young diagram with as many columns of size N as possible. Thus, if $n = mN + r$ with $0 \leq r \leq N - 1$, then the Young diagram in Figure 21 minimizes c_λ .

The content sum c_λ of such a diagram (by first summing the contents along each column) is

$$\begin{aligned}
c_\lambda &= -\binom{N}{2} + \left(-\binom{N}{2} + N\right) + \cdots + \left(-\binom{N}{2} + (m-1)N\right) + \left(-\binom{r}{2} + mr\right) \\
&= -m\binom{N}{2} + \binom{m}{2}N - \binom{r}{2} + mr.
\end{aligned}$$

From this, we may obtain

$$\begin{aligned}
\frac{1}{N}c_\lambda &= -\frac{1}{2}m(N-1) + \frac{1}{2}m(m-1) - \frac{1}{2}\frac{r(r-1)}{N} + \frac{mr}{N} \\
&= -\frac{1}{2}(mN+r) + \frac{1}{2}m^2 + \frac{1}{2}r - \frac{1}{2}\frac{r(r-1)}{N} + \frac{mr}{N}.
\end{aligned}$$

Since $n = mN + r$, this proves the second claim. Moreover, we see that if $m \geq 1$, then the above is at least $-\frac{1}{2}n + \frac{1}{2}m^2 \geq -\frac{1}{2}n + \frac{1}{2}$, as desired. Now, suppose that $m = 0$, so that $n = r$. Then the above is equal to

$$-\frac{1}{2}n + \frac{1}{2}r\left(1 + \frac{1}{N} - \frac{r}{N}\right).$$

One may check that under the restriction $1 \leq r \leq N - 1$, the above is minimized at $r = 1$ with a value of $-\frac{1}{2}n + \frac{1}{2}$, as desired. \square

Recall the Jucys-Murphy elements acting on bottom vertices defined in Definition 2.18.

Corollary 2.31. Let $N, n \geq 1$. Let $\rho_+ : \mathcal{B}_{n,n+1} \rightarrow \text{End}((\mathbb{C}^N)^{\otimes 2n+1})$. All eigenvalues of

$$\frac{1}{N}\rho_+(J_n + \cdots + J_1 + J'_{n+1} + \cdots + J'_1)$$

are strictly greater than $-n$.

Proof. Observe that $\rho_+(J_n + \cdots + J_1)$ acts as the identity on the last $n + 1$ coordinates, and on the first n coordinates, $\rho_+(J_n + \cdots + J_1)$ acts as $\rho(J_n + \cdots + J_1)$. In other words, $\rho_+(J_n + \cdots + J_1) = \rho(J_n + \cdots + J_1) \otimes I_{n+1}$, where $I_{n+1} \in \text{End}((\mathbb{C}^N)^{\otimes(n+1)})$ is the identity. Similarly, we have that $\rho_+(J'_{n+1} + \cdots + J'_1) = I_n \otimes \rho(J'_{n+1} + \cdots + J'_1)$, where $I_n \in \text{End}((\mathbb{C}^N)^{\otimes n})$ is the identity. In general, given two matrices M_1, M_2 , the eigenvalues of $M_1 \otimes M_2$ are the products of the eigenvalues of M_1 and eigenvalues of M_2 . Combining this fact with Lemma 2.30, we obtain that all eigenvalues of $\frac{1}{N}\rho(J_n + \cdots + J_1) \otimes I_{n+1}$ are at least $-\frac{1}{2}n + \frac{1}{2}$, and all eigenvalues of $I_n \otimes \frac{1}{N}\rho(J'_{n+1} + \cdots + J'_1)$ are at least $-\frac{1}{2}(n + 1) + \frac{1}{2}$. The desired result now follows. \square

3 Surface-sum representation of Wilson loop expectations

In this section, we show how to apply Corollary 2.7 to express Wilson loop expectations as sums over edge-plaquette embeddings (which were introduced in Section 1.4). We first prove a more abstract result about expectations of traces of words of Haar distributed Unitary matrices (Theorem 3.8) which has no reference to a lattice, and then apply this result to Wilson loop expectations to obtain Corollary 3.11.

Definition 3.1. Define the normalized Weingarten function $\overline{\text{Wg}}_N$ by:

$$\overline{\text{Wg}}_N(\pi) := N^{n+\|\pi\|} \text{Wg}_N(\pi), \quad \pi \in \text{S}_n.$$

Here, $\|\pi\| := n - \#\text{cycles}(\pi)$.

Remark 3.2. We will see later on that the normalized Weingarten function is the more natural quantity to work with, as it leads to nicer statements of our formulas. Another nice thing about $\overline{\text{Wg}}_N$ is that with this choice of normalization, the limit as $N \rightarrow \infty$ exists and depends on π . Indeed, we in fact have (see e.g. [CS06, Corollary 2.7])

$$\overline{\text{Wg}}_N(\pi) = \text{Möb}(\pi) + O(N^{-2}) \text{ as } N \rightarrow \infty,$$

where if π is decomposed into cycles of lengths C_1, \dots, C_k , then

$$\text{Möb}(\pi) := \prod_{i \in [k]} c_{C_i-1} (-1)^{C_i-1}, \quad \text{where } c_k := \frac{(2k)!}{k!(k+1)!} \text{ is the } k\text{th Catalan number.} \quad (3.1)$$

Recall from Corollary 2.7 that expectations of traces of words with respect to Haar measure may be expressed in terms of sums over pairs of matchings of strand diagrams, with matchings weighted by the Weingarten function. In this section, we will use this to express Wilson loop expectations in lattice gauge theories as weighted sums over edge-plaquette embeddings. The main step is to describe how to obtain a map from a given balanced collection of words Γ along with a collection of matchings of strand diagrams. Let us start with some examples.

We begin with a collection of faces corresponding to the words of Γ . Each word Γ_i gives a face whose degree (i.e. number of boundary edges) is the length of Γ_i . The boundary

edges of each such face are naturally labeled by letters in $\{\lambda_1, \dots, \lambda_L\}$. These faces can be obtained from adding the exterior connections specified by Γ to the strand diagram, as in Figure 9 (think of the red exterior connections as being shrunk down to a single vertex).

Next, consider a pair of left-right matchings of a strand diagram as displayed in the left of Figure 22. Think of this as the portion of the diagram corresponding to some letter λ in $\{\lambda_1, \dots, \lambda_L\}$. One can imagine that the two endpoints of each blue line are identified (this corresponds to “shrinking” each blue line away). In this case, one is then left with a collection of faces as in the right of Figure 22.

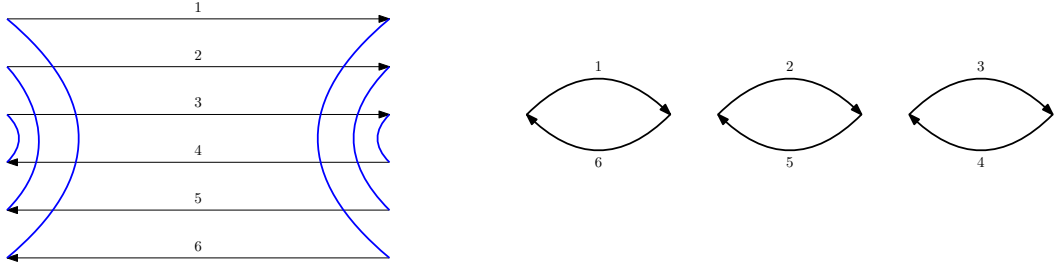

Figure 22: Left: a pair of left and right matchings. Right: the faces obtained by “shrinking away” the blue matching edges.

In Figure 23, we give another example of a pair of matchings of the strand diagram, and the corresponding collection of faces.

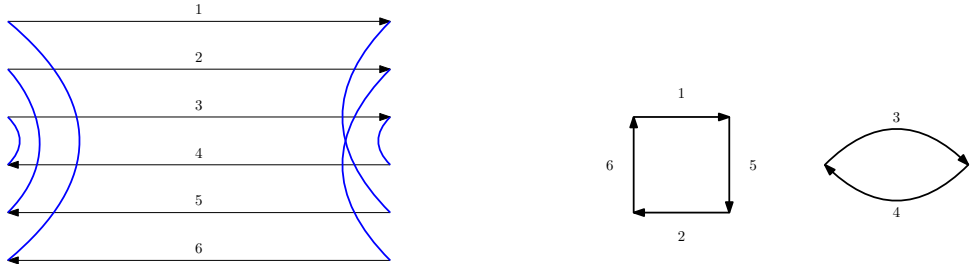

Figure 23: Left: a pair of left and right matchings. Right: the faces obtained by “shrinking away” the blue matching edges.

By specifying a pair of left-right matchings (σ_ℓ, τ_ℓ) for each letter λ_ℓ , we can obtain another collection of faces, in the manner described in Figures 22 and 23. We thus naturally have two collections of faces: the set of faces which correspond to words in Γ , and the set of faces obtained as above for every strand diagram.

Convention 3.3. We refer to the faces which correspond to words in Γ as “plaquette-faces”, or “yellow faces”. We refer to the faces which are obtained from the interior of the strand diagram as “edge-faces”, or “blue faces”.

Observe that every edge is incident to exactly two faces – one blue face and one yellow face. This naturally induces a gluing of the faces, and so we obtain a map whose dual is bipartite from the data $(\Gamma, ((\sigma_\ell, \tau_\ell), \ell \in [L]))$. Now the point is that the number of vertices of this map is precisely the number of components of the strand diagram. This relation is captured in the following lemma.

Lemma 3.4. Let $\mathbf{\Gamma} = (\Gamma_1, \dots, \Gamma_k)$ be a balanced collection of words on $\{\lambda_1, \dots, \lambda_L\}$. Suppose that for each $\ell \in [k]$, the number of occurrences of λ_ℓ is n_ℓ . For $\ell \in [k]$, let $\sigma_\ell, \tau_\ell : [n_\ell] \rightarrow (n_\ell : 2n_\ell]$ be a pair of matchings of the portion of the strand diagram corresponding to Γ_k . Then $\#\text{comp}(\mathbf{\Gamma}, ((\sigma_\ell, \tau_\ell), \ell \in [L]))$ is equal to the number of vertices in the corresponding map.

Proof. To compute the number of vertices in the map, we can proceed as follows. Recalling that the map arises from combining an interior connection with an exterior connection of the strand diagrams, we may begin by giving the vertices of the strands separate labels. For the portion of the strand diagram corresponding to λ_ℓ , we give a total of $4n_\ell$ labels, since there are $2n_\ell$ strands. Each connection (be it interior or exterior) results in the identification of two labels. In terms of the map, labels which have been identified are in fact the same vertex. Therefore the number of vertices in the map corresponds to the number of different equivalence classes of labels, after performing all label identifications indicated by the connections. The equivalence class of a given label may be obtained by starting at the label, and alternately following the exterior and interior connections, until we arrive back at the initial label. Recalling Example 2.9, observe that this is precisely the same method for computing the number of connected components of a given strand diagram with interior and exterior connections. Thus the connected components of the strand diagram are in bijection (moreover, there is a canonical identification) with the vertices of the map. \square

Definition 3.5. Let $\mathbf{\Gamma} = (\Gamma_1, \dots, \Gamma_k)$ be a balanced collection of words on $\{\lambda_1, \dots, \lambda_L\}$. Define $\text{DBM}(\mathbf{\Gamma})$ (short for “dual bipartite map”) to be the set of all possible maps which can be obtained from adding interior matchings to the strand diagram corresponding to $\mathbf{\Gamma}$. For a given map $\mathcal{M} \in \text{DBM}(\mathbf{\Gamma})$, and $\ell \in [L]$, let $\mu_\ell(\mathcal{M})$ be the partition of n_ℓ (the total number of occurrences of λ_ℓ) given by $1/2$ times the degrees of the blue faces which are glued in to the strand diagram of λ_ℓ .

Remark 3.6. Note that all maps in $\text{DBM}(\mathbf{\Gamma})$ are orientable. The faces corresponding to a word in $\mathbf{\Gamma}$ are endowed with a natural orientation (given by traversing the word). The faces coming from interior matchings can then always be endowed with a consistent orientation. For instance, in Figures 22 and 23, the orientations of these faces should be the reverse of what is drawn.

Remark 3.7. Observe that for any $\mathcal{M} \in \text{DBM}(\mathbf{\Gamma})$, we have that

$$E(\mathcal{M}) = 2 \sum_{i \in [L]} n_i, \quad F(\mathcal{M}) = k + \sum_{i \in [L]} \ell(\mu_i(\mathcal{M})). \quad (3.2)$$

Here, $\ell(\mu_i(\mathcal{M}))$ is the number of parts of the partition $\mu_i(\mathcal{M})$. The first identity says that the number of edges is equal to the total number of strands in the strand diagrams, and the second identity says that the total number of faces is equal to the number of words plus the total number of cycles of the interior matching of the strand diagram.

Theorem 3.8. Let $\mathbf{\Gamma} = (\Gamma_1, \dots, \Gamma_k)$ be a balanced collection of words on $\{\lambda_1, \dots, \lambda_L\}$. We have that

$$\mathbb{E}[\text{Tr}(U(\mathbf{\Gamma}))] = \sum_{\mathcal{M} \in \text{DBM}(\mathbf{\Gamma})} \left(\prod_{\ell \in [L]} \overline{\text{Wg}}_N(\mu_\ell(\mathcal{M})) \right) N^{\chi(\mathcal{M}) - k}.$$

Proof. By Corollary 2.7, the definition of $\text{DBM}(\Gamma)$, and Lemma 3.4, we have that

$$\mathbb{E}[\text{Tr}(U(\Gamma))] = \sum_{\mathcal{M} \in \text{DBM}(\Gamma)} \left(\prod_{\ell \in [L]} W_{\mathfrak{g}_N}(\mu_\ell(\mathcal{M})) \right) N^{V(\mathcal{M})}.$$

Applying the identities (3.2), we further obtain

$$\mathbb{E}[\text{Tr}(U(\Gamma))] = \sum_{\mathcal{M} \in \text{DBM}(\Gamma)} \left(\prod_{i \in [L]} N^{n_i + \|\mu_i(\mathcal{M})\|} W_{\mathfrak{g}_N}(\mu_i(\mathcal{M})) \right) N^{V(\mathcal{M}) - E(\mathcal{M}) + F(\mathcal{M}) - k}.$$

The desired result now follows. \square

Next, suppose that the letters $\{\lambda_1, \dots, \lambda_L\}$ are edges of the lattice Λ . In this case, a map $\mathcal{M} \in \text{DBM}(\Gamma)$ exactly corresponds to an edge-plaquette embedding (\mathcal{M}, ψ) , where the function ψ is determined by the requirement that it maps each edge of \mathcal{M} (which is canonically labeled by a letter in $\{\lambda_1, \dots, \lambda_L\}$) to the corresponding edge of Λ .

We now apply these considerations to lattice Yang-Mills. Let $s = (\ell_1, \dots, \ell_n)$ be a string. Recall equation (1.5), which we reproduce here:

$$\langle W_s \rangle_{\Lambda, \beta} = Z_{\Lambda, \beta}^{-1} \sum_{K: \mathcal{P} \rightarrow \mathbb{N}} \frac{(N\beta)^K}{K!} \int W_s(Q) \prod_{p \in \mathcal{P}} \text{Tr}(Q_p)^{K(p)} \prod_{e \in E_\Lambda} dQ_e. \quad (3.3)$$

For each fixed $K: \mathcal{P} \rightarrow \mathbb{N}$, we may apply Theorem 3.8 to obtain an expression for the integral above in terms of a sum over edge-plaquette embeddings. We first set some notation.

Definition 3.9. Let $s = (\ell_1, \dots, \ell_n)$ be a string, and let $K: \mathcal{P} \rightarrow \mathbb{N}$. Define the set $\text{EPE}(s, K)$ of edge-plaquette embeddings associated to s, K to be as follows. If s, K is unbalanced, then $\text{EPE}(s, K) := \emptyset$. If s, K is balanced, let Γ be the collection of words consisting of s and $K(p)$ copies of the plaquette p for each $p \in \mathcal{P}$. We define $\text{EPE}(s, K)$ to be the set of edge-plaquette embeddings (\mathcal{M}, ψ) obtained from maps $\mathcal{M} \in \text{DBM}(\Gamma)$. In words, $\text{EPE}(s, K)$ is the set of edge-plaquette embeddings with plaquette counts specified by K . Next, define

$$\text{EPE}(s) := \bigsqcup_{K: \mathcal{P} \rightarrow \mathbb{N}} \text{EPE}(s, K).$$

For $(\mathcal{M}, \psi) \in \text{EPE}(s)$, and $e \in E_\Lambda$, let $\mu_e(\psi)$ be the partition of $|\psi^{-1}(e)|/2$ induced by $1/2$ times the degrees of the faces of $\psi^{-1}(e)$. Define

$$\begin{aligned} \text{area}(\mathcal{M}, \psi) &:= \sum_{p \in \mathcal{P}} |\psi^{-1}(p)|, \\ (\psi^{-1})! &:= \prod_{p \in \mathcal{P}} |\psi^{-1}(p)|!. \end{aligned}$$

Note that if $(\mathcal{M}, \psi) \in \text{EPE}(s, K)$, then $\text{area}(\mathcal{M}, \psi) = \sum_p K(p)$ and $(\psi^{-1})! = K!$.

Remark 3.10 (Boundaries of edge-plaquette embeddings). One can also think of $\text{EPE}(s)$ as the set of edge-plaquette embeddings which have “boundary” s , by deleting the plaquette-faces (see Convention 3.3) of \mathcal{M} which correspond to ℓ_1, \dots, ℓ_n (i.e. the plaquette-faces whose boundary is mapped by ψ to one of edges of ℓ_1, \dots, ℓ_n). Denote by $(\overline{\mathcal{M}}, \psi)$ the map obtained in this way from a given (\mathcal{M}, ψ) . Then $\overline{\mathcal{M}}$ is a map with n boundary components (whose duals consist of neighboring edge-faces), and the boundary components are mapped by the embedding ψ to ℓ_1, \dots, ℓ_n . This is the sense in which $(\overline{\mathcal{M}}, \psi)$ has “boundary” given by s . See Figure 24 for an illustration.

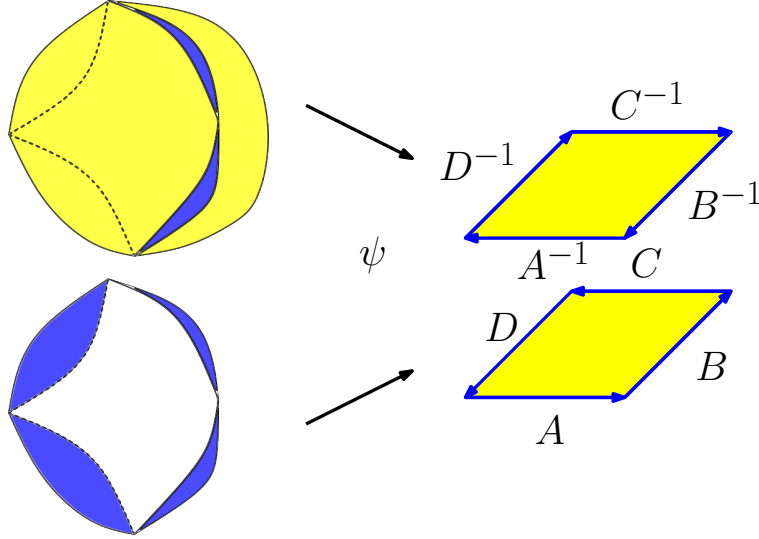

Figure 24: An example of an edge-plaquette embedding with boundary when $\ell_1 = ABCD$ and $\ell_2 = D^{-1}C^{-1}B^{-1}A^{-1}$. The top left sphere is a map \mathcal{M} whose dual is bipartite and the bottom left map $\overline{\mathcal{M}}$ is obtained by removing two yellow faces corresponding to ℓ_1 and ℓ_2 . The Euler characteristic changes from 2 to 0 after removal of the two faces. The boundary of $\overline{\mathcal{M}}$ maps onto the edges of ℓ_1 and ℓ_2 , and thus we can interpret $\overline{\mathcal{M}}$ as having boundary given by the union of ℓ_1 and ℓ_2 .

Also, note that $\chi(\overline{\mathcal{M}}) = \chi(\mathcal{M}) - n$. Thus if one wants to sum over maps $(\overline{\mathcal{M}}, \psi)$ with boundary s , then the term $\chi(\mathcal{M}) - 2n$ which appears in what follows should be replaced by $\chi(\overline{\mathcal{M}}) - n$.

Corollary 3.11. Let $s = (\ell_1, \dots, \ell_n)$ be a string. We have that

$$\langle W_s \rangle_{\Lambda, \beta} = Z_{\Lambda, \beta}^{-1} \sum_{(\mathcal{M}, \psi) \in \text{EPE}(s)} \frac{\beta^{\text{area}(\mathcal{M}, \psi)}}{(\psi^{-1})!} \left(\prod_{e \in E_\Lambda} \overline{\text{Wg}}_N(\mu_e(\psi)) \right) N^{\chi(\mathcal{M}) - 2n}.$$

Proof. Combining equation (3.3) with Theorem 3.8, we have that (recall that our Wilson loops are defined using the normalized trace)

$$\langle W_s \rangle_{\Lambda, \beta} = Z_{\Lambda, \beta}^{-1} \sum_{K: \mathcal{P} \rightarrow \mathbb{N}} \frac{(N\beta)^K}{K!} \sum_{(\mathcal{M}, \psi) \in \text{EPE}(s, K)} \left(\prod_{e \in E_\Lambda} \overline{\text{Wg}}_N(\mu_e(\psi)) \right) N^{\chi(\mathcal{M}) - 2n} N^{-K}.$$

Recalling that $\text{area}(\mathcal{M}, \psi) = \sum_p K(p)$ and $(\psi^{-1})! = K!$ for $(\mathcal{M}, \psi) \in \text{EPE}(s, K)$, the desired result now follows. \square

We close this section with some heuristic discussion of the large- N limit, where the surface sums are expected to simplify greatly. Recalling Remark 3.2, the large- N limit of the normalized Weingarten function factors into a product of Catalan numbers. This implies a nice factorization of the surface-sum weights according to connected components. For brevity, given a surface (\mathcal{M}, ψ) , let

$$w_\infty(\mathcal{M}, \psi) := \lim_{N \rightarrow \infty} \prod_{e \in E_\Lambda} \overline{\text{Wg}}_N(\mu_e(\psi)).$$

If (\mathcal{M}, ψ) splits into connected components $((\mathcal{M}_i, \psi_i), i \in [k])$, then

$$w_\infty(\mathcal{M}, \psi) = \prod_{i \in [k]} w_\infty(\mathcal{M}_i, \psi_i). \quad (3.4)$$

Now given a general $(\mathcal{M}, \psi) \in \text{EPE}(s)$, we can split (\mathcal{M}, ψ) into the union of (\mathcal{M}_0, ψ_0) and (\mathcal{M}', ψ') , where \mathcal{M}_0 contains all components of \mathcal{M} which are connected to s , and \mathcal{M}' contains everything else. Then by the factorization (3.4), we would expect that when N is large, we can factor out a copy of the partition function $Z_{\Lambda, \beta}$ from the numerator of $\langle W_s \rangle_{\Lambda, \beta}$, and then write

$$\langle W_s \rangle_{\Lambda, \beta} \approx \sum_{(\mathcal{M}_0, \psi_0) \in \text{EPE}_0(s)} \frac{\beta^{\text{area}(\mathcal{M}_0, \psi_0)}}{(\psi_0^{-1})!} w_\infty(\mathcal{M}_0, \psi_0) N^{\chi(\mathcal{M}_0) - 2n}.$$

where $\text{EPE}_0(s)$ is the subset of $\text{EPE}(s)$ consisting of the (\mathcal{M}_0, ψ_0) such that all components are connected to s .

Next, note that for $(\mathcal{M}_0, \psi_0) \in \text{EPE}_0(s)$, we have that $\lim_{N \rightarrow \infty} N^{\chi(\mathcal{M}_0) - 2n} \in \{0, 1\}$, and moreover, the limit is 1 if and only if each of the n strings s_1, \dots, s_n is part of a separate component of \mathcal{M}_0 , and all components have the topology of the sphere (this is the only situation which gives the maximal Euler characteristic $\chi(\mathcal{M}_0) = 2n$). We thus obtain that (using the factorization property of w_∞)

$$\begin{aligned} \lim_{N \rightarrow \infty} \sum_{(\mathcal{M}_0, \psi_0) \in \text{EPE}_0(s)} \frac{\beta^{\text{area}(\mathcal{M}_0, \psi_0)}}{(\psi_0^{-1})!} w_\infty(\mathcal{M}_0, \psi_0) N^{\chi(\mathcal{M}_0) - 2n} = \\ \prod_{i \in [n]} \sum_{(\mathcal{M}_{0,i}, \psi_{0,i}) \in \text{EPE}_0(s_i)} \frac{\beta^{\text{area}(\mathcal{M}_{0,i}, \psi_{0,i})}}{(\psi_{0,i}^{-1})!} w_\infty(\mathcal{M}_{0,i}, \psi_{0,i}) \end{aligned}$$

Combining the previous few displays, we thus heuristically see the factorization of Wilson loop expectations in the large- N limit:

$$\lim_{N \rightarrow \infty} \langle W_s \rangle_{\Lambda, \beta} = \prod_{i \in [n]} \lim_{N \rightarrow \infty} \langle W_{s_i} \rangle_{\Lambda, \beta}.$$

In summary, the large- N factorization of Wilson loop expectations (proven in [Cha19a, Jaf16, SZZ23]) can be seen from our surface-sum picture as follows: (1) by using that the weights factor according to connectivity, we can obtain a sum over surfaces which are connected to s (rather than a ratio of sums over surfaces), (2) we can further restrict to those surfaces which are made of n disjoint spheres, where each s_i is in a distinct sphere. Of course, some work is required to make this picture rigorous. In finite-volume, it might be possible to prove the factorization for any β . However in infinite-volume, we likely need a small β condition (as in previous works) in order to deal with absolute convergence issues.

4 Brownian motion and Poisson process exploration

In this section, we prove Theorem 2.5. First, in Section 4, we define and analyze a particular exploration process that is central to our proof. We then give the proof of the theorem in the case where N is large, where it is easier to focus on the main ideas. In Section 4.2, we extend the argument to the case of general N .

4.1 Strand-by-strand exploration

We begin towards the proof of Theorem 2.5. The main difficulty is that the weights $w_T(\pi)$ appearing in Theorem 2.5, when expressed as a series in T , do not converge absolutely when $T \rightarrow \infty$. In fact, the series is of the schematic form $\sum_k \frac{(-T)^k}{k!} c_k$, for some coefficients c_k . Clearly, to show convergence as $T \rightarrow \infty$, we need to take advantage of delicate cancellations which occur, rather than any sort of absolute summability. Uncovering these cancellations is the main technical part in the argument. This will be achieved via a certain exploration of the Poisson point process introduced in Section 2.1 which will provide an alternate form for the weights $w_T(\pi)$ which makes taking the $T \rightarrow \infty$ limit trivial.

Notation 4.1. We will often refer to the opposite-direction swaps introduced in Section 2.1 as “turnarounds”. Also, we will often use the term “matching” and “partition” interchangeably.

In the following, recall the Poisson process and strand diagram material introduced in Section 2.1. Because the Poisson processes corresponding to different letters are independent, it will suffice to just analyze the portion of the strand diagram corresponding to a single letter λ .

Notation 4.2. In this section, it will be notationally convenient for us to assume that the strand diagram corresponding to λ has $2n$ total strands, with n right-directed and left-directed strands each. This corresponds to the case that λ and λ^{-1} each appear a total of n times in the given collection of words Γ . This is in contrast to the notation of Definition 2.1, where n_ℓ is the the total number of occurrences of a given letter λ_ℓ and its inverse λ_ℓ^{-1} . To make consistent with this previous notation, we could perhaps introduce $n_+ = n_- = n/2$ and work with n_+ . However, the parameter n often appears in subscripts or superscripts, and adding a subscript “+” to n will result in iterated subscripts, which will complicate many expressions. Therefore, we decide just to use n to denote the number of right-directed (and left-directed) strands.

Having restricted to a single letter λ , let $\mathcal{C}, \mathcal{D}_T, \Sigma$ (introduced in Section 2.1) correspond to the single letter λ , with a total of n positive occurrences and n negative occurrences. Let $\Sigma(T) = \Sigma_\infty \cap \mathcal{D}_T$. By Lemma 2.3, expectations of words of Unitary Brownian motion may be expressed in terms of $w_T(\pi)$ (which is defined in (2.1)), for pairings $\pi \in \mathcal{M}(4n)$. Now that we have introduced the Brauer algebra \mathcal{B}_n in Definition 2.10, one may in fact view the pairings π as elements of \mathcal{B}_{2n} . Even more, we may restrict to the walled Brauer algebra $\mathcal{B}_{n,n} \subseteq \mathcal{B}_{2n}$, for reasons we next describe.

The weights $w_T(\pi)$ are naturally expressed in terms of a random walk on the walled Brauer algebra $\mathcal{B}_{n,n}$, as follows. We may visualize $\Sigma(T)$ as in the following picture (where

$n = 3$). The green lines represent same-swaps, the blue lines represent turnarounds, and locations of the green/blue lines correspond to the points of $\Sigma(T)$. Recalling Definition 2.14, we have that each green line corresponds to an element of the form $(i j)$, and each blue line corresponds to an element of the form $\langle i j \rangle$.

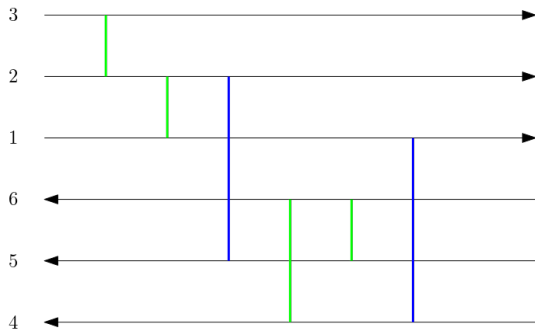

Figure 25: $(3\ 1)(2\ 1)\langle 2\ 5 \rangle(6\ 4)(6\ 5)\langle 1\ 4 \rangle$

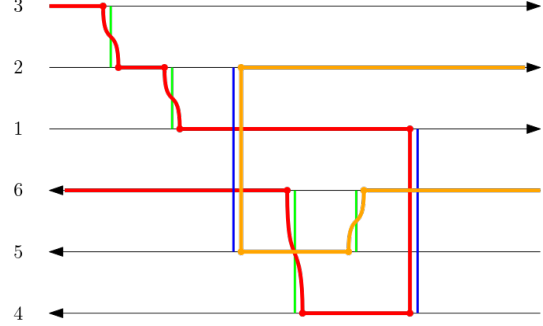

Figure 26: Exploring along strand 3 from the left and strand 6 from the right.

We can read off the element of $\mathcal{B}_{n,n}$ from the above strand diagram by exploring along each strand. For example, in Figure 26, we explore from the left of strand 3, as well as the right of strand 6. We see that 3 gets matched to 6 on the left, while 6 gets matched to 2 on the right. Clearly, if we do this for all other strands (not drawn), we can obtain the element of $\mathcal{B}_{n,n}$ that the above diagram corresponds to.

On the algebraic side, this exploration amounts to multiplying together all increments $(i j)$ or $\langle i j \rangle$ corresponding to the points of Σ , in the order that they appear. Due to the Poissonian nature of the points, each possible increment $(i j)$, $\langle i j \rangle$ is equally likely, and thus one may interpret Σ as giving a random walk on $\mathcal{B}_{n,n}$, as previously mentioned. However, there is an additional wrinkle, in that we need to keep track of more than just the final pairing, since each green line contributes a factor of $-\frac{1}{N}$ while each blue line contributes a factor of $\frac{1}{N}$. With this in mind, we make the following definition.

Definition 4.3. Given a finite collection of points $P \subseteq \mathcal{D}_T$, let $F(P) = F_N(P)$ be the element of $\mathcal{B}_{n,n}$ that P corresponds to, with the additional factors of $-\frac{1}{N}$ for same-direction swaps and $\frac{1}{N}$ for turnarounds. Let $M(P)$ be the pairing corresponding to P , i.e. the element of $\mathcal{B}_{n,n}$ obtained when ignoring the additional factors.

With this definition, observe that we may express

$$w_T(\pi) = e^{\binom{2n}{2}T - nT} \mathbb{E}[F(\Sigma(T)) \mathbb{1}(M(\Sigma(T)) = \pi)]$$

Or, as elements of the walled Brauer algebra $\mathcal{B}_{n,n}$, we have the equality

$$\sum_{\pi} w_T(\pi) \pi = e^{\binom{2n}{2}T - nT} \mathbb{E}[F(\Sigma(T))]. \quad (4.1)$$

In the following, we will mainly focus on understanding $\lim_{T \rightarrow \infty} e^{\binom{2n}{2}T - nT} \mathbb{E}[F(\Sigma(T))]$. Clearly, once we understand this, we will also know $\lim_{T \rightarrow \infty} w_T(\pi)$ for any π .

In terms of the strands, this condition says that once a blue turnaround appears, the only points which can thereafter appear that touch either of the matched strands must be the blue turnaround between the same two strands.

Lemma 4.4. Let $i_0 \in [n]$, $j_0 \in (n : 2n]$. Let $\Sigma_{-\{i_0, j_0\}}(T)$ be the Poisson point process obtained by deleting all points of $\Sigma(T)$ touching the i_0 th or j_0 th strands. Then

$$\begin{aligned}\langle i_0 j_0 \rangle \mathbb{E}[F(\Sigma(T))] &= e^{-4(n-1)T} \langle i_0 j_0 \rangle \mathbb{E}[F(\Sigma_{-\{i_0, j_0\}}(T))], \\ \mathbb{E}[F(\Sigma(T))] \langle i_0 j_0 \rangle &= e^{-4(n-1)T} \mathbb{E}[F(\Sigma_{-\{i_0, j_0\}}(T))] \langle i_0 j_0 \rangle.\end{aligned}$$

Proof. We only show the first identity as the second follows similarly. Let A_T be the event that the process $\Sigma(T)$ contains no points touching the i_0 th or j_0 th strand, besides those which give the turnaround $\langle i_0 j_0 \rangle$. Since each strand is involved in $2n - 1$ total Poisson processes, the number of Poisson processes that involve the i th or j th strand is $2(2n - 1) - 1 = 4n - 3$. On the event A_T , all but one of these processes must have zero points, and thus $\mathbb{P}(A_T) = e^{-4(n-1)T}$. Let $\Sigma_{\langle i_0 j_0 \rangle}(T)$ be the process obtained by keeping only those points which give the turnaround $\langle i_0 j_0 \rangle$. On A_T , we may split

$$\Sigma(T) = \Sigma_{-\{i_0, j_0\}}(T) \sqcup \Sigma_{\{i_0, j_0\}}(T),$$

and moreover

$$F(\Sigma(T)) = F(\Sigma_{\{i_0, j_0\}}(T))F(\Sigma_{-\{i_0, j_0\}}(T)).$$

We thus have that

$$\begin{aligned}\langle i_0 j_0 \rangle \mathbb{E}[F(\Sigma(T)) \mathbb{1}_{A_T}] &= \mathbb{P}(A_T) \langle i_0 j_0 \rangle \mathbb{E}[F(\Sigma_{\{i_0, j_0\}}(T))] \mathbb{E}[F(\Sigma_{-\{i_0, j_0\}}(T))] \\ &= e^{-4(n-1)T} \langle i_0 j_0 \rangle \mathbb{E}[F(\Sigma_{\{i_0, j_0\}}(T))] \mathbb{E}[F(\Sigma_{-\{i_0, j_0\}}(T))].\end{aligned}$$

By explicit calculation, using that $\langle i_0 j_0 \rangle^k = N^{k-1} \langle i_0 j_0 \rangle$, we have that

$$\langle i_0 j_0 \rangle \mathbb{E}[F(\Sigma_{\{i_0, j_0\}}(T))] = e^{-T} \langle i_0 j_0 \rangle \sum_{k=0}^{\infty} \frac{T^k}{k!} \left(\frac{\langle i_0 j_0 \rangle}{N} \right)^k = \langle i_0 j_0 \rangle e^{-T} \sum_{k=0}^{\infty} \frac{T^k}{k!} = \langle i_0 j_0 \rangle.$$

To finish, it suffices to show that

$$\langle i_0 j_0 \rangle \mathbb{E}[F(\Sigma(T))] = \langle i_0 j_0 \rangle \mathbb{E}[F(\Sigma(T)) \mathbb{1}_{A_T^c}],$$

or in other words,

$$\langle i_0 j_0 \rangle \mathbb{E}[F(\Sigma(T)) \mathbb{1}_{A_T^c}] = 0.$$

We show that for each $k \geq 1$, we have that

$$\langle i_0 j_0 \rangle \mathbb{E}[F(\Sigma(T)) \mathbb{1}_{A_T^c} \mid |\Sigma(T)| = k] = 0.$$

(If $k = 0$ then A_T^c cannot occur.) Let Ω_k be the set of length- k sequences of elements of the set

$$\{(i j) : 1 \leq i < j \leq n\} \cup \{(i j) : n + 1 \leq i < j \leq 2n\} \cup \{\langle i j \rangle : i \in [n], j \in (n : 2n)\},$$

such that there exists some element not equal to $\langle i_0 j_0 \rangle$ that involves either i_0 or j_0 . For each $(x_1, \dots, x_k) \in \Omega_k$, let $n_T(x_1, \dots, x_k)$ be the number of transpositions (i.e. elements of the form $(i j)$) in the sequence. Observe that

$$\langle i_0 j_0 \rangle \mathbb{E}[F(\Sigma(T)) \mathbb{1}_{A_T^c} \mid |\Sigma(T)| = k] = \langle i_0 j_0 \rangle \frac{1}{\binom{2n}{2}^k N^k} \sum_{(x_1, \dots, x_k) \in \Omega_k} (-1)^{n_T(x_1, \dots, x_k)} x_1 \cdots x_k.$$

We now define a bijection $h : \Omega_k \rightarrow \Omega_k$ such that if $h(x_1, \dots, x_k) = (y_1, \dots, y_k)$, then

$$\langle i_0 j_0 \rangle (-1)^{n_T(y_1, \dots, y_k)} y_1 \cdots y_k = -\langle i_0 j_0 \rangle (-1)^{n_T(x_1, \dots, x_k)} x_1 \cdots x_k.$$

Note that this immediately implies that

$$\langle i_0 j_0 \rangle \sum_{(x_1, \dots, x_k) \in \Omega_k} (-1)^{n_T(x_1, \dots, x_k)} x_1 \cdots x_k = -\langle i_0 j_0 \rangle \sum_{(x_1, \dots, x_k) \in \Omega_k} (-1)^{n_T(x_1, \dots, x_k)} x_1 \cdots x_k,$$

which implies that the above is zero, which would give the desired result. To define h , given a sequence (x_1, \dots, x_k) , let $1 \leq r \leq k$ be index of the first element x_r which causes the sequence (x_1, \dots, x_n) to be in Ω_k . Then either x_r is a transposition of the form $(i_0 k)$ or $(k j_0)$, or x_r is a turnaround of the form $\langle i_0 k \rangle$ or $\langle k j_0 \rangle$. If x_r is a transposition, we set

$$h(x_1, \dots, x_k) := \begin{cases} (x_1, \dots, x_{r-1}, \langle k j_0 \rangle, x_{r+1}, \dots, x_k) & x_r = (i_0 k) \\ (x_1, \dots, x_{r-1}, \langle i_0 k \rangle, x_{r+1}, \dots, x_k) & x_r = (k j_0). \end{cases}$$

and if x_r is a turnaround, we set

$$h(x_1, \dots, x_k) := \begin{cases} (x_1, \dots, x_{r-1}, (k j_0), x_{r+1}, \dots, x_k) & x_r = \langle i_0 k \rangle \\ (x_1, \dots, x_{r-1}, (i_0 k), x_{r+1}, \dots, x_k) & x_r = \langle k j_0 \rangle. \end{cases}$$

In words, if x_r is a transposition involving i_0 (resp. j_0), then h switches x_r to a turnaround involving j_0 (resp. i_0). Similarly, if x_r is a turnaround involving i_0 (resp. j_0), then h switches x_r to a transposition involving j_0 (resp. i_0). Note that h is an involution, and thus a bijection. Also, we clearly have by construction that

$$(-1)^{n_T(x_1, \dots, x_k)} = -(-1)^{n_T(h(x_1, \dots, x_k))}.$$

Thus to finish, it suffices to show that with $h(x_1, \dots, x_k) = (y_1, \dots, y_k)$, we have that $\langle i_0 j_0 \rangle x_1 \cdots x_k = \langle i_0 j_0 \rangle y_1 \cdots y_k$. By construction of h , it just suffices to show that $\langle i_0 j_0 \rangle x_1 \cdots x_r = \langle i_0 j_0 \rangle x_1 \cdots x_{r-1} y_r$. By the assumption on r , we have that $x_1 \cdots x_{r-1}$ commutes with $\langle i_0 j_0 \rangle$, and so

$$\langle i_0 j_0 \rangle x_1 \cdots x_r = x_1 \cdots x_{r-1} \langle i_0 j_0 \rangle x_r, \quad \langle i_0 j_0 \rangle x_1 \cdots x_{r-1} y_r = x_1 \cdots x_{r-1} \langle i_0 j_0 \rangle y_r.$$

To finish, we claim that $\langle i_0 j_0 \rangle x_r = \langle i_0 j_0 \rangle y_r$, i.e. the switching procedure used to define h does not change the overall matching. This follows by the identities $\langle i k \rangle \langle i j \rangle = \langle i k \rangle \langle j k \rangle$ and $\langle i k \rangle \langle i j \rangle = \langle i k \rangle \langle j k \rangle$. For the first identity, observe that the two products of matchings in Figure 27 are equal.

The second identity follows similarly. □

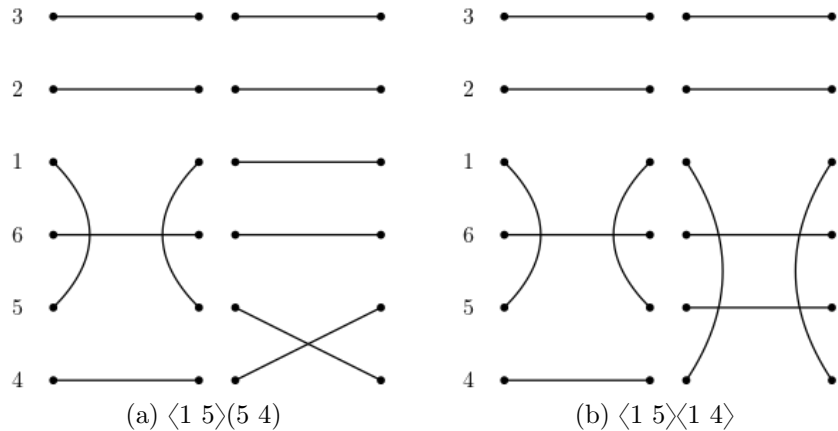

Figure 27: The above two products of matchings are equal.

We now finally describe our exploration of the strand diagram corresponding to Σ . The exploration proceeds strand-by-strand. We first give an informal description with accompanying figures before proceeding to the formal mathematical definition. The main feature of the exploration is that we explore only a single strand at a time, rather than all strands at once. That is, we start at (say) the top strand, and explore left-to-right until we see a swap or a turnaround involving this strand. If we see a swap between the top strand and another strand, then we begin exploring the other strand. If we see a turnaround, then the current exploration era ends, and we begin to explore the next strand. To visualize this exploration, suppose we want to explore the the diagram in Figure 28.

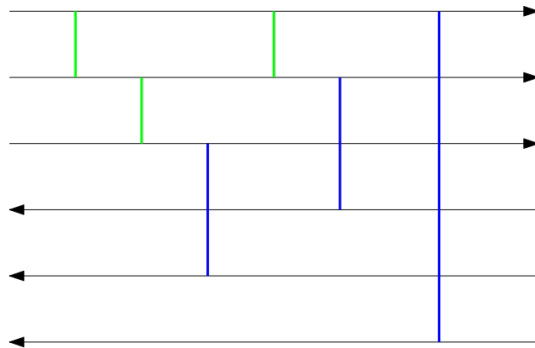

Figure 28: Before the strand-by-strand exploration.

Our exploration proceeds in three separate eras, drawn as in Figure 29.

Note that at the start of the second era, we begin exploring the top strand instead of the second-to-top strand, because of the previous swap between these two strands. Likewise, at the start of the third era, we also begin exploring from the top strand, because this is effectively the bottom strand due to the previously seen swaps. Another thing to note is that in principle, during the first exploration era, it is certainly possible for the point process to have swaps that involve two non-top strands. However, our exploration process does not see these swaps. It turns out that by exploring the random environment in the manner we described, we can in fact assume that in every exploration era, every swap in the point

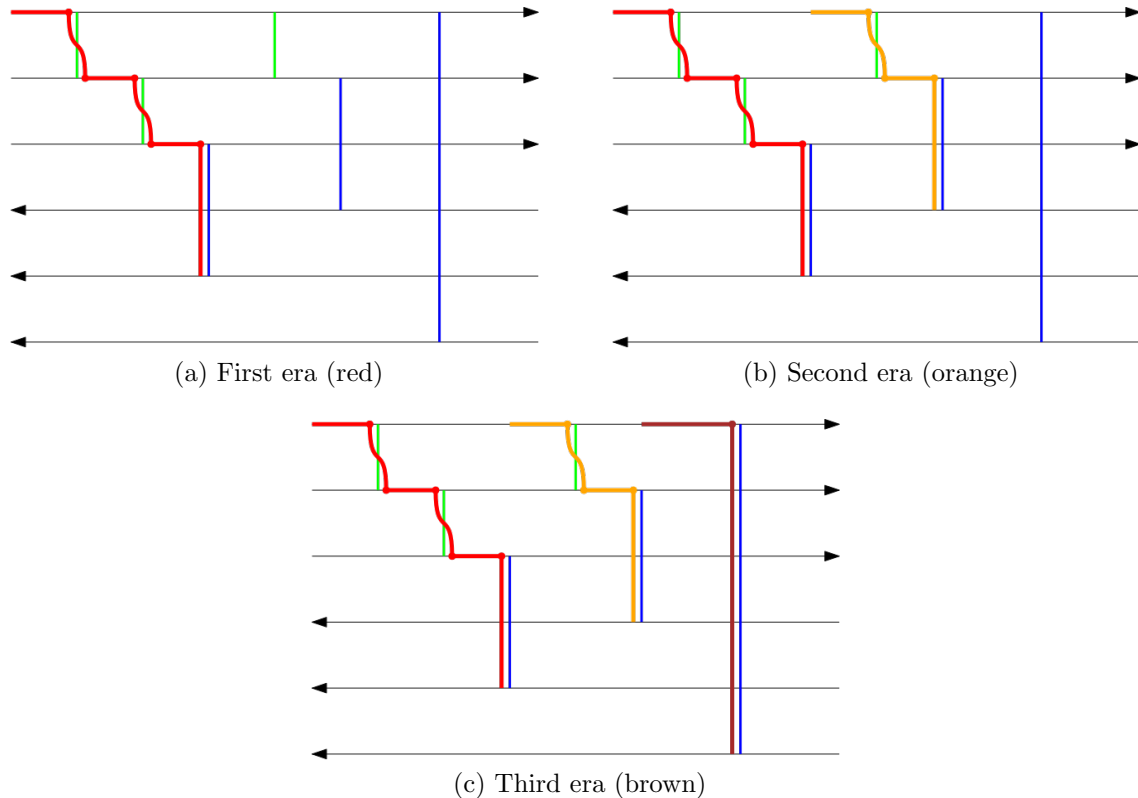

Figure 29: The successive eras of our strand-by-strand exploration.

process involves the current exploration strand, so that we don't need to worry about such "unseen swaps". This property is due to certain cancellations that we may take advantage of, which are very similar in spirit to the cancellations observed in the proof of Lemma 4.4.

At the end of the last exploration era, we have built up an element of $\mathcal{B}_{n,n}$ (we have omitted the additional factors of $\pm \frac{1}{N}$ and only drawn the left and right matchings), as displayed in Figure 30.

Here, the colors are for visual purposes and don't affect the end element of $\mathcal{B}_{n,n}$: we have colored the matching edges to denote the exploration era in which these pairing were discovered. Now here is why we chose to explore as we did: conditioned on everything we have seen up to the end of the last exploration era, the expectation of $F(\Sigma(T))$ is *essentially given*⁷ by the matching in Figure 30. This property is intimately related to our previous comment that we can assume that there are no unseen swaps, i.e. swaps which do not involve the current exploration strand. This key property of our exploration enables us to give a rather explicit closed-form expression for the overall expectation of $F(\Sigma(T))$. Even more, it is almost trivial to take the $T \rightarrow \infty$ limit of the closed-form expression, and this allows us to recover the Weingarten calculus.

⁷Technically, this is only true up to some explicit factors, but this is more of a technical detail.

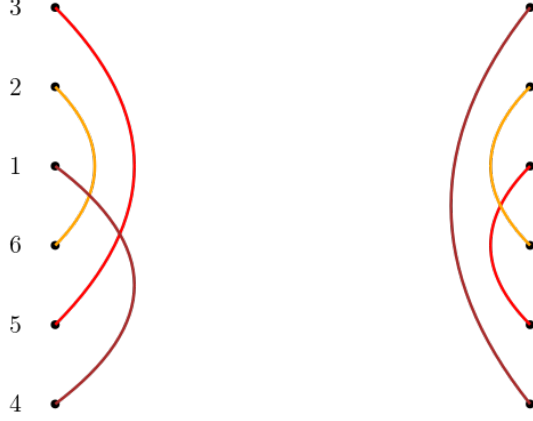

Figure 30: The matching discovered by our strand-by-strand exploration.

We now proceed to the precise definition of the exploration. First, for $i \in [2n]$, define

$$\Sigma_i := \bigcup_{j \in [2n] \setminus \{i\}} \Sigma_{\{i,j\}},$$

i.e. Σ_i collects all Poisson processes with which i is involved. In terms of the strands, Σ_i collects all swaps and turnarounds touching the i th strand. The exploration is described by two processes $(E_t)_{t \geq 0}$, $(\pi_t)_{t \geq 0}$, the first of which takes values in $[n]$, and the second of which takes values in S_n (which we view as the set of bijections of $[n]$). One should think of E_t as tracking the current exploration era, and π_t as tracking the current strand of exploration.

We start with $E_0 := 1$, $\pi_0 := \text{id}$. We begin exploring $\Sigma_{\pi_0(E_0)} = \Sigma_1$ until we see the first point, which we denote by U_1 . At time U_1 , we update E and π as follows. There is some $j \in [2n] \setminus \{E_0\}$ such that $\mathfrak{l}(U_1) = \pi_0(E_0, j)$. For $t \in (0, U_1)$, we set $E_t := E_0$, $\pi_t := \pi_0$. Now if $j \in [n]$, then we set $E_{U_1} := E_0$ and $\pi_{U_1} := (\pi_0(1) j)\pi_0$. We then continue exploring $\Sigma_{\pi_{U_1}(E_{U_1})}$ from time U_1 . Otherwise, if $j \in [n : 2n]$, then we set $E_{U_1} := E_0 + 1$ (i.e. a new exploration era begins) and $\pi_{U_1} := \pi_0$. Additionally, we remove all points of $\Sigma_{\pi_0(E_0)} \cup \Sigma_j$ from Σ . The exploration then continues on this reduced point process. In terms of the strands, the removal of points corresponds to only looking at those swaps or turnarounds which do not involve $\pi_0(E_0), j$. The exploration stops once all exploration eras have ended, i.e. once we have explored all strands up to their first time of turnaround. This is the first time t such that $E_t = n + 1$.

For $i \in [n]$, let $T_i := \inf\{t \geq 0 : E_t = i + 1\}$, i.e. the time at which the i th exploration era ends. Let \mathcal{Q}_t be the set of points that the exploration has seen up to time t . Let $(\mathcal{F}_t, t \geq 0)$ be the filtration generated by the processes E, π .

The following key proposition makes precise the key property of our exploration that we described earlier.

Proposition 4.5. We have that

$$e^{\binom{2n}{2}T - nT} \mathbb{E}[F(\Sigma(T)) \mathbb{1}(T_n \leq T)] = \mathbb{E}[F(\mathcal{Q}(T_n)) \mathbb{1}(T_n \leq T) e^{2(n-1)T_1} e^{2(n-2)(T_2 - T_1)} \dots e^{2(n-n)(T_n - T_{n-1})}].$$

Proof. Fix N . We proceed by induction on n . When $n = 1$, the result is true for all $T \geq 0$, because then A_T always occurs, and furthermore when $T_1 \leq T$, we have that $F(\Sigma(T)) = F(\mathcal{Q}(T_1))$. Now suppose that for some general $n \geq 1$, the result is true for all $T \geq 0$. We proceed to show that the case $n + 1$ also holds. We start by conditioning on \mathcal{F}_{T_1} . Pictorially, this corresponds to exploring until the end of the first era, see the left of Figure 31. One should think of the two parallel vertical red lines as occurring at the same

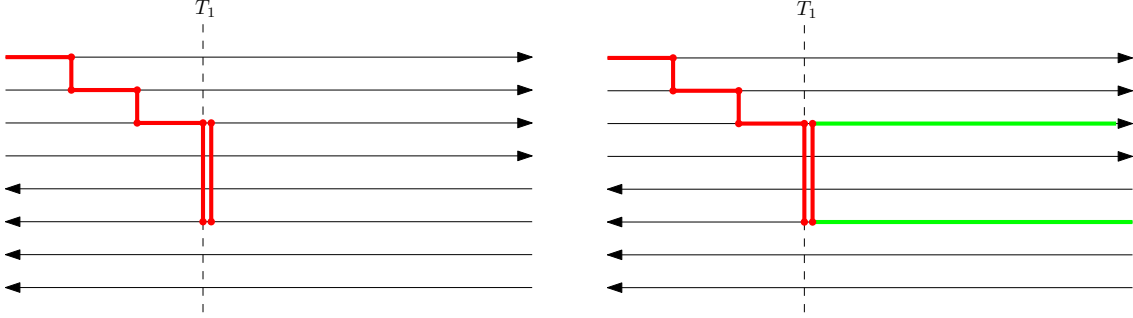

Figure 31: Left: We start at the first strand and explore until we see a turnaround. Right: Once we have seen a turnaround, we may treat the two strands involved in the turnaround as “out of the game”.

time (namely T_1), although for visual purposes we have drawn them to be slightly separated. Next, naturally, we may split the diagram in Figure 31 into two parts: the part to the left of T_1 , and the part to the right of T_1 . This corresponds to splitting

$$\Sigma(T) = \Sigma(T_1) \cup (\Sigma(T) \setminus \Sigma(T_1)).$$

Since the Poisson processes before T_1 and after T_1 are conditionally independent, we have that

$$\begin{aligned} \mathbb{E}[F(\Sigma(T)) \mathbb{1}(T_{n+1} \leq T) \mid \mathcal{F}_{T_1}] = \\ \mathbb{E}[F(\Sigma(T_1)) \mid \mathcal{F}_{T_1}] \mathbb{E}[F(\Sigma(T) \setminus \Sigma(T_1)) \mathbb{1}(T_{n+1} - T_1 \leq T - T_1) \mid \mathcal{F}_{T_1}]. \end{aligned}$$

We first use our inductive assumption to rewrite the second conditional expectation on the right hand side above. By our cancellation lemma (Lemma 4.4), we may assume that there are no swaps or turnarounds which involve either of the two matched strands after T_1 , as long as we multiply by the explicit exponential factor $e^{-(4(n+1)-1)(T-T_1)} = e^{-4n(T-T_1)}$. Pictorially, after T_1 , the two segments which are colored bright green in the right Figure 31 are no longer connected to the other strands in the diagram. The point now is that after having taken out the two green strands, the expectation of the remainder of the diagram after T_1 is exactly given by our inductive assumption. Thus, we have the identity

$$\begin{aligned} e^{\binom{2n}{2}(T-T_1) - n(T-T_1)} \mathbb{E}[F(\Sigma(T) \setminus \Sigma(T_1)) \mathbb{1}(T_{n+1} - T_1 \leq T - T_1) \mid \mathcal{F}_{T_1}] = \\ e^{-4n(T-T_1)} \mathbb{E}[F(\mathcal{Q}_T \setminus \mathcal{Q}_{T_1}) \mathbb{1}(T_{n+1} - T_1 \leq T - T_1) e^{2(n-1)(T_2-T_1)} e^{2(n-2)(T_3-T_2)} \dots e^{2(n-n)(T_{n+1}-T_n)}]. \end{aligned}$$

Applying this identity, as well as the identity $\binom{2(n+1)}{2} - (n+1) = 4n + \binom{2n}{2} - n$, we obtain

$$e^{\binom{2(n+1)}{2}T - (n+1)T} \mathbb{E}[F(\Sigma(T)) \mathbb{1}(T_{n+1} \leq T)] =$$

$$\mathbb{E}\left[F(\Sigma(T_1))F(\mathcal{Q}_{T_{n+1}} \setminus \mathcal{Q}_{T_1})\mathbb{1}(T_{n+1} \leq T)e^{(4n+\binom{2n}{2}-n)T_1}e^{2(n+1-2)(T_2-T_1)} \dots e^{2(n+1-(n+1))(T_{n+1}-T_n)}\right].$$

To finish, we now argue that

$$\begin{aligned} e^{(4n+\binom{2n}{2}-n)T_1}\mathbb{E}\left[F(\Sigma(T_1))F(\mathcal{Q}_{T_{n+1}} \setminus \mathcal{Q}_{T_1}) \mid \mathcal{F}_{T_{n+1}}\right] &= e^{2nT_1}F(\mathcal{Q}_{T_1})F(\mathcal{Q}_{T_{n+1}} \setminus \mathcal{Q}_{T_1}) \quad (4.2) \\ &= e^{2nT_1}F(\mathcal{Q}_{T_{n+1}}). \end{aligned}$$

Note that this would complete the proof of the inductive step. For a picture of what we have in mind when conditioning on $\mathcal{F}_{T_{n+1}}$, see Figure 32.

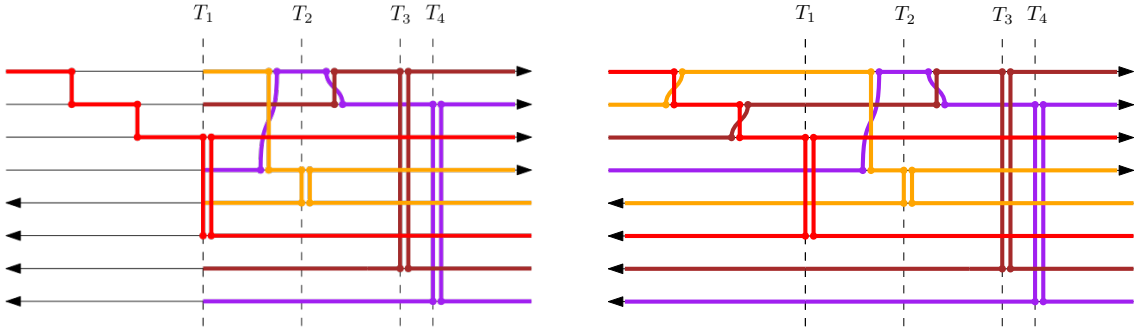

Figure 32: Left: we can assume that our exploration process looks like this after applying the inductive assumption. Right: completing the inductive step by arguing that after cancellation, we may assume that there are no other points before T_1 , besides the previously seen red swaps.

In the left of Figure 32, we treat the portion of the diagram to the right of T_1 as fixed, whereas the portions of the strands before T_1 which are black have not been fully explored. The identity (4.2) says that after averaging over this randomness, we may simply assume that there are no additional swaps or turnarounds in $[0, T_1]$, so that the expectation is given by the right of Figure 32 (which corresponds to the right hand side of the identity).

The identity (4.2) follows by cancellations similar to those exploited in the proof of the cancellation lemma (Lemma 4.4). Indeed, observe that the two diagrams in Figure 33 equal, in the sense that the final matching is the same (the red and orange strands are unchanged, so one only needs to track the brown and purple strands). Note however that the left

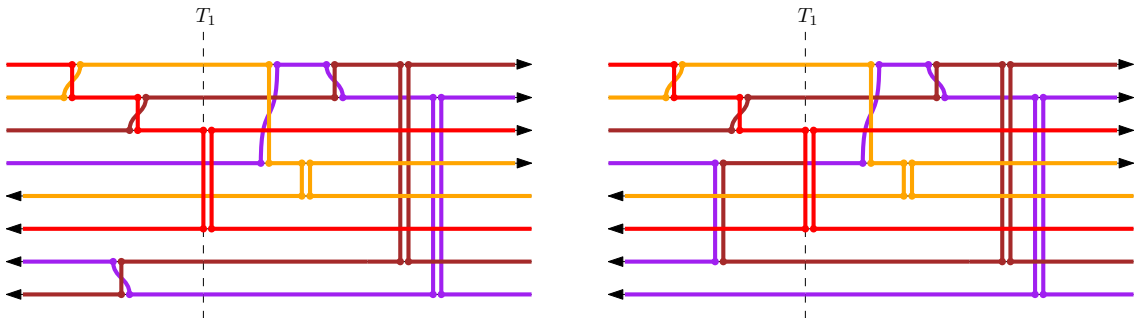

Figure 33: The above two diagrams are equal as elements of $\mathcal{B}_{n,n}$

diagram will have an opposite sign compared to the right diagram, because swaps incur a factor of -1 while turnarounds do not. This gives the desired cancellation between swaps and turnaround which do not connect two strands which have been matched by the portion of the diagram after T_1 . Thus the total number of Poisson processes which must have zero points is $\binom{n}{2} + \binom{n+1}{2} + n^2$. Here, $\binom{n}{2}$ counts the possible swaps between two top strands, $\binom{n+1}{2}$ counts the possible swaps between two bottom strands, and $n^2 = n(n+1) - n$ counts the turnarounds which connect a top and bottom strand which are not already connected by the diagram to the right of T_1 . We now finish by noting the identity

$$4n + \binom{2n}{2} - n - \binom{n}{2} - \binom{n+1}{2} - n^2 = 2n. \quad \square$$

Next, to extract the Jucys-Murphy elements, it is helpful to think of all the swaps in the i th exploration era as involving the i th strand. Towards this end, we show that the expectation of $F(\mathcal{Q}(T_n))$ appearing in Proposition 4.5 may be computed by following a slightly different exploration, one in which each exploration era stays on a single strand, and in each era, we keep track of all swaps that touch the strand we are currently exploring. First, we define processes $(\bar{E}_t)_{t \geq 0}$ and $(\bar{\pi}_t)_{t \geq 0}$ as follows. As before, we start with $\bar{E}_0 = 1$ and $\bar{\pi}_0 = \text{id}$. We proceed to explore $\mathcal{P}_{\bar{E}_0}$ (in contrast to before, where we explored $\mathcal{P}_{\pi_0(E_0)}$). When we see a swap of the form $\{1, j\}$, $j \in [n]$, we update $\bar{\pi} \mapsto \bar{\pi}(1 \ j)$. When we see a turnaround $\langle 1 \ j \rangle$, $j \in (n : 2n]$, the first exploration era ends, we update \bar{E} to be 2, and we remove from \mathcal{P} all points in \mathcal{P}_{E_0} . We then continue until the end of the n th exploration era. See Figure 34 for how one may visually compare this alternative exploration with our original exploration.

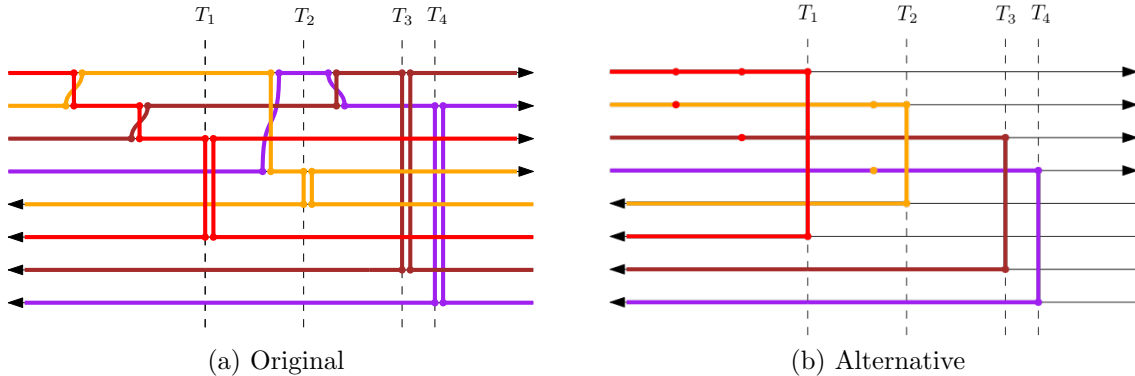

Figure 34: If, every time we see a swap, we imagine we “cut and swap” the two strands which were involved, we go from the left picture to the right picture. Note that the left matching is unchanged. The original right matching can be reconstructed from the left matching and the swaps. In the right picture, all swaps in the first era involve the top strand, all swaps in the second era involve the second-top strand, etc.

Formally, we may define a bijection on sets of points $P \mapsto P'$, which preserves the Poisson measure, and moreover if we follow our original exploration process on the set P , then that amounts to following the alternative exploration on the set P' . Under this bijection, the

left matching found by the original exploration is equal to the left matching found by the alternative exploration, whereas the right matchings of the two explorations differ in a precise way, which is exactly encoded in the process $\bar{\pi}$. As an example, observe that in the previous picture, just before time T_1 , we have that $\bar{\pi}_t = (4\ 3)(4\ 2) = (2\ 3\ 4)$. Observe that $\bar{\pi}_t(4) = 2$, and on the right hand side of the original exploration, 2 is matched to 6. More generally, the rule is as follows. Let $\sigma(\mathcal{Q})$ be the left matching found by the alternative exploration process. Then the right matching $\tau(\mathcal{Q})$ is given by $\sigma(Q)\bar{\pi}_t$. Finally, because the bijection preserves the Poisson measure, when we apply the two explorations to a Poisson process, then they have the same law. We have thus arrived at the following result.

Lemma 4.6. We have that

$$\mathbb{E}[F(\mathcal{Q}(T_n))\mathbb{1}(T_n \leq T)e^{2(n-1)T_1}e^{2(n-2)(T_2-T_1)} \dots e^{2(n-n)(T_n-T_{n-1})}] = \frac{1}{N^n n!} \sum_{\sigma: [n] \rightarrow (n:2n)} \left[\sigma \mathbb{E}[\bar{\pi}_{T_n} e^{2(n-1)T_1} \mathbb{1}(T_n \leq T) e^{2(n-2)(T_2-T_1)} \dots e^{2(n-n)(T_n-T_{n-1})}] \right]$$

Remark 4.7. The factor of $\frac{1}{N^n}$ arises because each turnaround incurs factor of $\frac{1}{N}$, and there are n total turnarounds on the event $T_n \leq T$. The factor $\frac{1}{n!}$ arises because the first turnaround is equally likely to touch any of the n bottom strands, the second turnaround is equally likely to touch any of the $n-1$ remaining bottom strands, etc.

Lemma 4.8. Let $U_1, \dots, U_n \stackrel{i.i.d.}{\sim} \text{Exp}(1)$. We have that

$$\mathbb{E}[\bar{\pi}_{T_n} e^{2(n-1)T_1} \mathbb{1}(T_n \leq T) e^{2(n-2)(T_2-T_1)} \dots e^{2(n-n)(T_n-T_{n-1})}] = n! \mathbb{E}[\exp(-U_n J_n / N) \dots \exp(-U_1 J_1 / N) \mathbb{1}(U_1 + \dots + U_n \leq T)].$$

Proof. Note that the duration $T_k - T_{k-1}$ of the k th exploration process is an exponential random variable with rate $n - k + 1$. We thus have the explicit formula

$$\begin{aligned} \mathbb{E}[\bar{\pi}_{T_n} \mathbb{1}(T_n \leq T) e^{2(n-1)T_1} e^{2(n-2)(T_2-T_1)} \dots e^{2(n-n)(T_n-T_{n-1})}] = \\ \int_0^T dt_1 \int_{t_1}^T dt_2 \dots \int_{t_{n-1}}^T dt_n (n e^{-nt_1}) ((n-1) e^{-(n-1)(t_2-t_1)}) \dots e^{-(t_n-t_{n-1})} \times \\ f_n(t_1) f_{n-1}(t_2-t_1) \dots f_1(t_n-t_{n-1}) \times \\ e^{2(n-1)t_1} e^{2(n-2)(t_2-t_1)} \dots e^{2(n-n)(t_n-t_{n-1})}. \end{aligned}$$

Here, $f_n(t_1)$ is the expected contribution of all same-direction swaps in the first exploration era, conditioned on $T_1 = t_1$, $f_{n-1}(t_2 - t_1)$ is the expected contribution of all same-direction swaps in the second exploration era, conditioned on $T_2 - T_1 = t_2 - t_1$, etc. Conditioned on $T_1 = t_1$, the number of total same-direction swaps is $\text{Poi}((n-1)t_1)$, and conditional on the total number of same-direction swaps being equal to k , the expected contribution is uniformly distributed on all possible sequences of k swaps, i.e. $(-J_n/N(n-1))^k$. We thus have the explicit formula

$$f_n(t_1) = e^{-(n-1)t_1} \sum_{k=0}^{\infty} \frac{((n-1)t_1)^k}{k!} \left(\frac{-J_n}{N(n-1)} \right)^k$$

$$= e^{-(n-1)t_1} \sum_{k=0}^{\infty} \frac{(-t_1 J_n/N)^k}{k!} = e^{-(n-1)t_1} e^{-t_1 J_n/N}.$$

More generally, we have the formula

$$f_{n-k+1}(t_k - t_{k-1}) = e^{-(n-k)(t_k - t_{k-1})} e^{-(t_k - t_{k-1})J_{n-k+1}/N}, \quad k \in [n].$$

Inserting this into our first display, we obtain

$$\begin{aligned} \mathbb{E}[\bar{\pi}_{T_n} \mathbb{1}(T_n \leq T) e^{2(n-1)T_1} e^{2(n-2)(T_2 - T_1)} \dots e^{2(n-n)(T_n - T_{n-1})}] = \\ n! \int_0^T dt_1 \int_{t_1}^T dt_2 \dots \int_{t_{n-1}}^T dt_n e^{-t_1} \dots e^{-(t_n - t_{n-1})} e^{-t_1 J_n/N} e^{-(t_2 - t_1)J_{n-1}/N} \dots e^{-(t_n - t_{n-1})J_1/N}. \end{aligned}$$

To finish, observe that the right hand side above is precisely the right hand side of the claimed identity. \square

Up to now, we did not need to make any assumption on the size of N . We begin to do so here. Later, in Section 4.2, we will show how to remove these assumptions, but for now we prefer to work in a simplified setting where the main ideas are more transparent.

Lemma 4.9. Suppose that $N \geq n$. Then

$$\lim_{T \rightarrow \infty} \mathbb{E}[\bar{\pi}_{T_n} \mathbb{1}(T_n \leq T) e^{2(n-1)T_1} e^{2(n-2)(T_2 - T_1)} \dots e^{2(n-n)(T_n - T_{n-1})}] = n! N^n (N + J_n)^{-1} \dots (N + J_1)^{-1}.$$

Proof. By Lemma 4.8, we may compute

$$\begin{aligned} \mathbb{E}[\bar{\pi}_{T_n} \mathbb{1}(T_n \leq T) e^{2(n-1)T_1} e^{2(n-2)(T_2 - T_1)} \dots e^{2(n-n)(T_n - T_{n-1})}] = \\ n! \int_0^T du_n \int_0^{T - u_n} du_{n-1} \dots \int_0^{T - (u_n + \dots + u_2)} du_1 (e^{-u_n} e^{-u_n J_n/N}) \dots (e^{-u_1} e^{-u_1 J_1/N}). \end{aligned}$$

Since $N \geq n$, we have that $\|J_k/N\| < 1$ for all $k \in [n]$. This implies that the following integral is absolutely convergent (recall Remark 2.20):

$$\int_0^\infty du_n \int_0^\infty du_{n-1} \dots \int_0^\infty du_1 (e^{-u_n} e^{-u_n J_n/N}) \dots (e^{-u_1} e^{-u_1 J_1/N}),$$

and moreover, the limit in question is equal to $n!$ times the above. To finish, simply observe that the above splits into a product of n integrals, where the k th integral may be evaluated:

$$\int_0^\infty du_k e^{-u_k} e^{-u_k J_k/N} = \int_0^\infty du_k e^{-u_k (\text{id} + J_k/N)} = \left(\text{id} + \frac{J_k}{N} \right)^{-1} = N(N + J_k)^{-1}.$$

The desired result follows. \square

Next, we argue why the contribution to the partition function $e^{\binom{2n}{2}T - nT} \mathbb{E}[F(\Sigma(T))]$ coming from the event $\{T_n > T\}$ vanishes in the $T \rightarrow \infty$ limit (that is, as T becomes large, we can assume that all exploration eras have finished by time T). We first show that when the numbers of top strands and bottom strands are mismatched, the expectation vanishes as $T \rightarrow \infty$. This will be needed in the proof of Proposition 4.19 later.

Lemma 4.10. Suppose that $n \geq 2$ and $N \geq 2n$. Suppose that Σ is a Poisson process arising from having $n - 1$ top strands and n bottom strands. Then

$$\sup_{T \geq 0} e^{(2n-1)T - (n-1)T} \|\mathbb{E}[F(\Sigma(T))]\| < \infty.$$

Proof. We proceed by induction. First, consider the base case $n = 2$. In this case, by conditioning on the first time of turnaround, we can explicitly compute

$$e^{2T} \mathbb{E}[F(\Sigma(T))] = e^{2T} \int_0^T 2e^{-2u} X(u) Y Z(u) du + e^{2T} e^{-2T} e^{-T} e^{-T J'_2/N},$$

where $X(u)$ is the expected contribution of all swaps up to time u , and $Z(u)$ is the expected contribution of all points after time u , where both are conditioned on the first turnaround happening at time u . Also, $Y = \frac{1}{2}(\langle 1 \ 2 \rangle + \langle 1 \ 3 \rangle)$ is the expected contribution of the turnaround, since each of the two turnarounds is equally likely. Note that the time of first turnaround is exponential of rate 2, which explains the presence of the $2e^{-2u}$ term. The second term above corresponds to the case where the first turnaround happens after time T .

We have the explicit formulas

$$X(u) = e^{-u} e^{-u J'_2/N}, \quad Z(u) = e^{-2(T-u)},$$

where J'_2 is the Jucys-Murphy element which we view as acting on the bottom two strands (recall Definition 2.18). This formula follows because the number of swaps up to time u is $\text{Poisson}(u)$, and each swap incurs a factor $-J'_2/N$. The fact that $Z(u) = e^{-2(T-u)}$ follows because once a turnaround occurs, we can argue via cancellation as in the proof of Lemma 4.4 that the only points which can occur thereafter are turnarounds between the same two strands. Plugging in the formulas for $X(u), Z(u)$, we may obtain the expression

$$\int_0^T e^{-u(\text{id} + J'_2/N)} du (\langle 1 \ 2 \rangle + \langle 1 \ 3 \rangle) + e^{-T(\text{id} + J'_2/N)}.$$

Since $N \geq 2n$ is sufficiently large, as $T \rightarrow \infty$ the above stays bounded (in fact, it converges to some explicit expression involving $(\text{id} + J'_2/N)^{-1}$, as in the proof of Lemma 4.8). This shows the case $n = 2$.

Now suppose the claim is true for some n . Suppose also that $N \geq 2(n+1)$. We show that the claim is true for $n+1$. As in the base case, by conditioning on the first time of turnaround, we may express (note that $\binom{2n+1}{2} - n = 2n^2$)

$$e^{(2n+1)T - nT} \mathbb{E}[F(\Sigma(T))] = e^{2n^2 T} \int_0^T n(n+1) e^{-n(n+1)u} X_n(u) Y_n Z_n(u) du + \tag{4.3}$$

$$e^{2n^2 T} e^{-n(n+1)T} e^{-\binom{n}{2} T} e^{-T(J_n + \dots + J_1)/N} e^{-\binom{n+1}{2} T} e^{-T(J'_{n+1} + \dots + J'_1)/N},$$

where $X_n(u)$ is the expected contribution of all swaps up to time u and $Z_n(u)$ is the expected contribution of all points after time u , where both are conditioned on the first turnaround happening at time u . Also, $Y_n = \frac{1}{n(n+1)} \sum_{i \in [n], j \in (n:2n+1]} \langle i \ j \rangle$ is the expectation of the first

turnaround. Let J'_1, \dots, J'_{n+1} be the Jucys-Murphy elements which act on the bottom $n+1$ strands, as in Definition 2.18. Similar to before, we may explicitly compute

$$\begin{aligned} X_n(u) &= e^{-\binom{n}{2}u} e^{-\binom{n+1}{2}u} e^{-u(J_n + \dots + J_1)/N} e^{-u(J'_{n+1} + \dots + J'_1)/N}, \\ Z_n(u) &= e^{-2(2n-1)(T-u)} f_n(T-u), \end{aligned}$$

where $f_n(T-u)$ is the expected contribution of the points involving the remaining $n-1$ top and n bottom strands after time u , conditioned on the first turnaround happening at time u . Observe that the $e^{-2(2n-1)(T-u)}$ factor in $Z_n(u)$ arises due to similar cancellations as in the proof of Lemma 4.4, which allows us to restrict to the event that after the first turnaround $\langle i j \rangle$, the only points which can involve either of the two matched strands are exactly the turnarounds of the form $\langle i j \rangle$. This means that a total of $2(2n-1)$ rate-1 Poisson processes must have zero points on the interval $[u, T]$.

Plugging in our formulas for $X_n(u)$, $Z_n(u)$, and using the identities $2n^2 - n(n+1) - \binom{n}{2} - \binom{n+1}{2} = -n$, $2n^2 - 2(2n-1) = 2(n-1)^2$, we have that the first term on the right hand side of (4.3) is equal to

$$n(n+1) \int_0^T e^{-nu} e^{-u(J_n + \dots + J_1)/N} e^{-u(J'_{n+1} + \dots + J'_1)/N} Y e^{2(n-1)^2(T-u)} f_n(T-u) du.$$

By the inductive assumption, we have that $\sup_{S \geq 0} e^{2(n-1)^2 S} \|f_n(S)\| < \infty$. Also, since $N \geq 2(n+1)$, we have that $\|(J_n + \dots + J_1)/N\| < n/2$ and $\|(J'_{n+1} + \dots + J'_1)/N\| < n/2$, which implies

$$\int_0^\infty e^{-nu} \|e^{-u(J_n + \dots + J_1)/N} e^{-u(J'_{n+1} + \dots + J'_1)/N}\| du < \infty.$$

Combining the two facts, we obtain that the first term on the right hand side of (4.3) is uniformly bounded in T . The second term in the right hand side of (4.3) may be expressed

$$e^{-nT} e^{-T(J_n + \dots + J_1)/N} e^{-T(J'_{n+1} + \dots + J'_1)/N}.$$

By arguing as before, we may show that this stays bounded as $T \rightarrow \infty$ (in fact, it converges to zero). This completes the proof of the inductive step. \square

Combining this lemma with an inductive argument, we can obtain the following.

Proposition 4.11. Suppose that $N \geq 2n$. We have that

$$\lim_{T \rightarrow \infty} e^{\binom{2n}{2}T - nT} \mathbb{E}[F(\Sigma(T)) \mathbb{1}(T_n > T)] = 0.$$

Proof. Fix N . First, when $n = 1$, we have that

$$\mathbb{E}[F(\Sigma(T)) \mathbb{1}(T_1 > T)] = e^{-T} \text{id},$$

where id here denotes the identity element of $\mathcal{B}_{n,n}$. The right hand side above clearly goes to zero as $T \rightarrow \infty$. This shows the base case $n = 1$. Now suppose the result is true for some

general $n \geq 1$. Suppose also that $N \geq 2(n+1)$. We proceed to show that the $n+1$ case is true. Towards this end, observe that we may decompose

$$\mathbb{1}(T_{n+1} > T) = \mathbb{1}(T_1 > T) + \mathbb{1}(T_1 \leq T < T_{n+1}).$$

We split into the two cases indicated above. In the first case, we condition on the exploration at time T :

$$e^{\binom{2(n+1)}{2}T - (n+1)T} \mathbb{E}[\mathbb{E}[F(\Sigma(T)) \mid \mathcal{F}_T] \mathbb{1}(T_1 > T)].$$

To help visualize, imagine we have the situation in Figure 35, where we explore the first strand until time T , and we have not yet seen a turnaround.

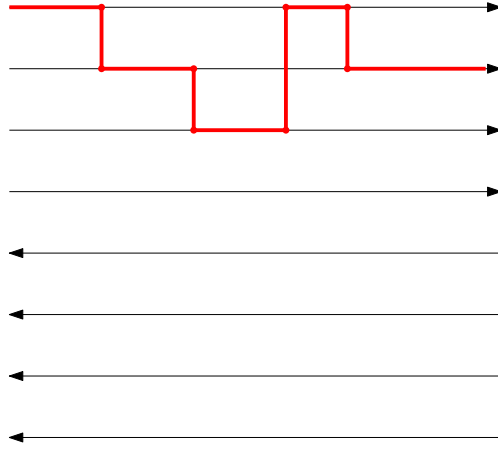

Figure 35: We explore the top strand, and do not see a turnaround before time T .

Conditioned on this picture, the expectation of the diagram can be computed as follows. First, since we have already explored one strand, the remaining points effectively form a Poisson process corresponding to n top strands and $n+1$ bottom strands. Call this modified process $\bar{\Sigma}(T)$. We visualize this in Figure 36, where the top-most strand in the left diagram is dashed, to signify that there are no points touching this strand.

Having computed the expectation of the modified diagram in the left of Figure 36, to obtain the conditional expectation of $F(\Sigma(T))$ we simply need to multiply by the right diagram in the figure, which captures the effect of all swaps seen by our exploration up to time T . This discussion corresponds to the following identity for the conditional expectation:

$$\mathbb{E}[F(\Sigma(T)) \mid \mathcal{F}_T] = \mathbb{E}[F(\bar{\Sigma}(T))]F(Q_T).$$

We may then compute

$$\begin{aligned} & e^{\binom{2(n+1)}{2}T - (n+1)T} \mathbb{E}[\mathbb{E}[F(\Sigma(T)) \mid \mathcal{F}_T] \mathbb{1}(T_1 > T)] \\ &= e^{\binom{2(n+1)}{2}T - (n+1)T} \mathbb{E}[F(\bar{\Sigma}(T))] \mathbb{E}[F(Q_T) \mathbb{1}(T_1 > T)] \\ &= e^{\binom{2(n+1)}{2}T - (n+1)T} \mathbb{E}[F(\bar{\Sigma}(T))] e^{-(n+1)T} e^{-nT} e^{-TJ_{n+1}/N} \end{aligned}$$

T_1 , we may compute the conditional expectation:

$$\mathbb{E}[F(\Sigma(T))\mathbb{1}(T_1 \leq T < T_{n+1}) \mid \mathcal{F}_{T_1} = u] = \mathbb{E}[F(\bar{\Sigma}(u))]e^{-4n(T-u)}F(\mathcal{Q}_{T_1})f_n(T-u),$$

where $\bar{\Sigma}$ is a Poisson process corresponding to having n top strands and $n+1$ bottom strands, and $f_n(T-u)$ is the expectation of the remaining n top and n bottom strands after time u , on the event that not all n exploration eras end before time is up. Observe that by our inductive assumption, we have that for any $u \geq 0$,

$$\lim_{T \rightarrow \infty} e^{\binom{2n}{2}(T-u)-n(T-u)}f_n(T-u) = 0. \quad (4.4)$$

Since T_1 is an exponential random variable of rate $n+1$, we may compute the expectation:

$$\begin{aligned} & e^{\binom{2(n+1)}{2}T-(n+1)T}\mathbb{E}[F(\Sigma(T))\mathbb{1}(T_1 \leq T < T_{n+1})] = \\ & e^{\binom{2(n+1)}{2}T-(n+1)T}\int_0^T du (n+1)e^{-(n+1)u}(\mathbb{E}[F(\bar{\Sigma}(u))]) (e^{-nu}e^{-uJ_{n+1}/N})Y(e^{-4n(T-u)}f_n(T-u)) \end{aligned}$$

Here, the term $e^{-nu}e^{-uJ_{n+1}/N}$ arises from taking the expectation of all swaps in the first exploration era (i.e. $F(\mathcal{Q}(T_1))$), conditioned on $T_1 = u$, and Y is the expectation of the first turnaround. Since

$$\begin{aligned} & \binom{2(n+1)}{2} - (n+1) = 2n^2 + 2n \\ & \binom{2(n+1)}{2} - (n+1) - 4n = \binom{2n}{2} - n, \end{aligned}$$

we have that the above is further equal to

$$(n+1)\int_0^T du (e^{2n^2u}\mathbb{E}[F(\bar{\Sigma}(u))]) (e^{-u}e^{-uJ_{n+1}/N})Ye^{-4n(T-u)}f_n(T-u).$$

Now since $N \geq 2n$, by Lemma 4.10, we have that $e^{2n^2u}\mathbb{E}[F(\bar{\Sigma}(u))] = O(1)$ and $e^{-u}e^{-uJ_{n+1}/N}$ is integrable. Combining this with (4.4) and dominated convergence, we finally obtain

$$\lim_{T \rightarrow \infty} e^{\binom{2(n+1)}{2}T-(n+1)T}\mathbb{E}[F(\Sigma(T))\mathbb{1}(T_1 \leq T < T_{n+1})] = 0.$$

This completes the proof of the inductive step, and thus the desired result now follows. \square

We can now finally take the $T \rightarrow \infty$ limit.

Proposition 4.12. Suppose that $N \geq 2n$. Then as $T \rightarrow \infty$, we have that

$$\lim_{T \rightarrow \infty} e^{\binom{2n}{2}T-nT}\mathbb{E}[F(\Sigma(T))] = \sum_{\sigma, \tau: [n] \rightarrow (n:2n)} \text{Wg}_N(\sigma\tau^{-1})[\sigma \ \tau].$$

Proof. By combining Proposition 4.5, Lemmas 4.6 and 4.9, and Proposition 4.11, we obtain

$$\begin{aligned} \lim_{T \rightarrow \infty} e^{\binom{2n}{2}T - nT} \mathbb{E}[F(\Sigma(T))] &= \sum_{\sigma: [n] \rightarrow (n:2n)} [\sigma \ \sigma] \text{Wg}_N \\ &= \sum_{\sigma: [n] \rightarrow (n:2n)} \sum_{\pi \in \mathcal{S}_n} [\sigma \ \sigma \pi] \text{Wg}_N(\pi) \\ &= \sum_{\sigma, \tau: [n] \rightarrow (n:2n)} [\sigma \ \tau] \text{Wg}_N(\sigma^{-1}\tau). \end{aligned}$$

To finish, recall that $\text{Wg}_N(\sigma^{-1}\tau) = \text{Wg}_N(\sigma\tau^{-1})$, because Wg_N is a class function. \square

We can now prove Theorem 2.5 in the case $N \geq 2n$.

Proof of Theorem 2.5 when $N \geq n$. Recall from (4.1) that

$$e^{\binom{2n}{2}T - nT} \mathbb{E}[F(\mathcal{P}(T))] = \sum_{\pi} w_T(\pi) \pi.$$

By Proposition 4.12, we obtain

$$\lim_{T \rightarrow \infty} w_T(\pi) = \mathbb{1}(\pi = [\sigma \ \tau] \text{ for some } \sigma, \tau : [n] \rightarrow (n : 2n)) \text{Wg}_N(\sigma\tau^{-1}).$$

Since $w_T(\pi_1, \dots, \pi_L) = w_T(\pi_1) \cdots w_T(\pi_L)$, the desired result now follows. \square

Remark 4.13 (Comparison to [Dah17]). If one translates Dahlqvist’s proof to the language of Poisson point processes, then his strategy amounts to an exploration of the Poisson process which simultaneously explores all strands. This is certainly a natural exploration to try. [Dah17, Lemma 5.1] amounts to the statement that the main contribution comes from the event that all exploration eras end for this “simultaneous exploration”. [Dah17, Lemma 5.2] gives a formula for the limiting contribution on this main event. He then extracts the Weingarten function from this formula by [Dah17, Lemma 5.3].

We believe that our proof technique via strand-by-strand exploration is intrinsically interesting, because first of all it is rather surprising that such an exploration actually works. Recall that this was Proposition 4.5, whose proof rested on certain cancellations that could be uncovered (Lemma 4.4). Moreover, the strand-by-strand exploration naturally uncovers the Jucys-Murphy elements, thus giving an alternative perspective on the appearance of the Weingarten function. Finally, the strand-by-strand exploration naturally leads to a single-strand recursion that results in a slightly more general version of the Makeenko-Migdal/Master loop/Schwinger-Dyson equation – see Remarks 5.4 and 5.7 for more discussion.

4.2 Extension to general values of N

Recall that in the proof of Proposition 4.12, we deduced the existence of $\lim_{T \rightarrow \infty} e^{\binom{2n}{2}T - nT} \mathbb{E}[F(\Sigma(T))]$ from the existence of $\lim_{T \rightarrow \infty} \mathbb{E}[\bar{\pi}_{T_n} \mathbb{1}(T_n \leq T)] \in \mathbb{C}[\mathcal{S}_n]$. However, when $N \leq n$, the trouble is that the latter limit no longer exists. Thus to prove Theorem 2.5 in the case where N is

small, we need some alternative argument which does not rely on convergence in the group algebra. Indeed, we will show that although $\lim_{T \rightarrow \infty} \mathbb{E}[\bar{\pi}_{T_n} \mathbb{1}(T_n \leq T)]$ does not necessarily exist in $\mathbb{C}[S_n]$, once we apply the representation ρ_+ (Definition 2.22), the limit *does exist*. Moreover, the limit $\lim_{T \rightarrow \infty} \rho_+(\mathbb{E}[\bar{\pi}_{T_n} \mathbb{1}(T_n \leq T)])$ already contains enough information in order to compute expectations of traces of words. Once we have built up enough background, the actual proof of Theorem 2.5 for general values of N will be a small variation of the proof for large N , as the major technical steps were already covered in Section 4 (and any additional background covered in Section 2.2).

Towards this end, it will be useful to recall why expectations of traces of words may be reduced to weighted sums over the Brauer algebra, i.e. why Lemma 2.3 is true. Let Γ be a word on letters $\{\lambda_1, \dots, \lambda_L\}$. We may assume $\Gamma = \lambda_{c(1)}^{\varepsilon(1)} \cdots \lambda_{c(n)}^{\varepsilon(n)}$, where $\varepsilon : [n] \rightarrow \{\pm 1\}$ and $c : [n] \rightarrow [L]$. Let $M = (M_1, \dots, M_L)$ be a given collection of $N \times N$ Unitary matrices. The computation of $\text{Tr}(M(\Gamma)) = \text{Tr}(M_{c(1)}^{\varepsilon(1)} \cdots M_{c(n)}^{\varepsilon(n)})$ may be visualized in terms of the strand diagram as in Figure 38, where we consider the concrete case $\Gamma = \lambda_1^2 \lambda_2 \lambda_1^{-2} \lambda_2^{-1}$.

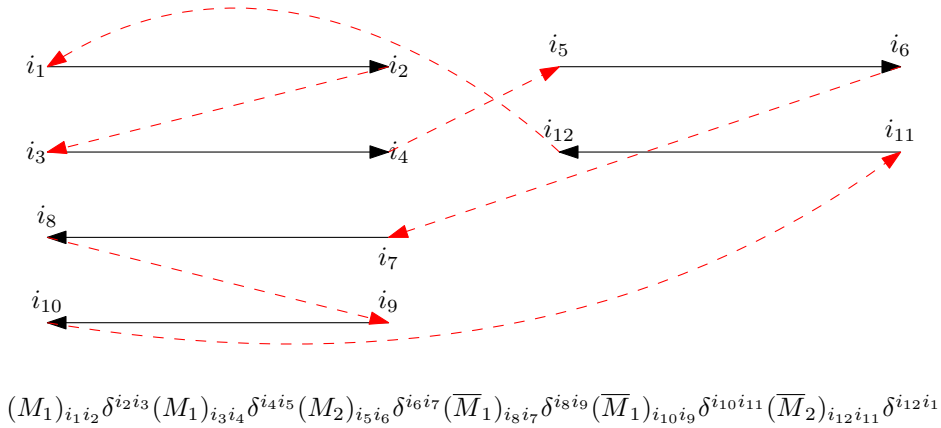

Figure 38: Visualization of the calculation of $\text{Tr}(M_1^2 M_2 M_1^{-2} M_2^{-1})$.

In Figure 38, we can imagine we are traversing the strand diagram. Every black strand contributes a matrix element, and every dashed red strand enforces an identification of indices. In the end we sum over all indices which appear. Of course, we could have written the trace more succinctly as

$$\text{Tr}(M_1^2 M_2 M_1^{-2} M_2^{-1}) = (M_1)_{i_1 i_2} (M_1)_{i_2 i_3} (M_2)_{i_3 i_4} (\bar{M}_1)_{i_5 i_4} (\bar{M}_1)_{i_6 i_5} (\bar{M}_2)_{i_1 i_6},$$

but we prefer to keep the δ functions because they correspond to the dashed red lines. We now want to give an expression as above for general words and strand diagrams. Given the strand diagram of a word Γ , note that the diagram has a single component, with a unique ordering of its vertices x_1, \dots, x_V up to cyclic equivalence. This ordering is such that the edges alternate between black strands and dashed red lines. Let $B(\Gamma)$ be the set of black strands, and $R(\Gamma)$ be the set of dashed red lines. Further split $B(\Gamma) = B_+(\Gamma) \cup B_-(\Gamma)$, where $B_+(\Gamma), B_-(\Gamma)$ are the set of positive (i.e. right) and negative (i.e. left)-oriented black strands. In the previous example,

$$B_+(\Gamma) = \{(x_1, x_2), (x_3, x_4), (x_5, x_6)\}, \quad B_-(\Gamma) = \{(x_7, x_8), (x_9, x_{10}), (x_{11}, x_{12})\},$$

$$R(\Gamma) = \{(x_2, x_3), (x_4, x_5), (x_6, x_7), (x_8, x_9), (x_{10}, x_{11})\}.$$

Given a collection of indices $i = (i_1, \dots, i_V) \in [N]^V$, and an edge $e = (x_j, x_{j+1})$, let $i_e = (i_j, i_{j+1})$, $i_{-e} = (i_{j+1}, i_j)$. Let $r(e) \in [L]$ be the index of the letter that e corresponds to. Then the general formula for $\text{Tr}(M(\Gamma))$ in terms of the strand diagram is:

$$\text{Tr}(M(\Gamma)) = \prod_{e \in B_+(\Gamma)} (M_{r(e)})_{i_e} \prod_{e \in B_-(\Gamma)} (\overline{M}_{r(e)})_{i_{-e}} \prod_{e \in R(\Gamma)} \delta^{i_e},$$

where we implicitly sum over $i = (i_1, \dots, i_V) \in [N]^V$. Now the point is as follows. If M_1, \dots, M_L are independent $U(N)$ -valued Brownian motions, then upon taking expectations of the above, we may obtain that $\mathbb{E}[\text{Tr}(M(\Gamma))]$ is equal to a weighted sum of diagrams as follows.

First, for $\ell \in [L]$, let $B_+(\Gamma, \ell)$, $B_-(\Gamma, \ell)$ be the sets of positively and negatively oriented edges corresponding to the letter λ_ℓ . Since the M_1, \dots, M_L are independent, we have that

$$\mathbb{E}[\text{Tr}(M(\Gamma))] = \prod_{\ell \in [L]} \mathbb{E} \left[\prod_{e \in B_+(\Gamma, \ell)} (M_{r(e)})_{i_e} \prod_{e \in B_-(\Gamma, \ell)} (\overline{M}_{r(e)})_{i_{-e}} \right] \prod_{e \in R(\Gamma)} \delta^{i_e}.$$

We recall the following lemma from [PPSY23, Appendix A] (see also (2.1)) which gives a formula for each of the expectations appearing in the right hand side above.

Proposition 4.14. Let $i_1, \dots, i_n, i'_1, \dots, i'_n, j_1, \dots, j_n, j'_1, \dots, j'_n \in [N]$. We have that

$$\mathbb{E}[(B_T)_{i_1 j_1} \cdots (B_T)_{i_n j_n} (\overline{B}_T)_{i'_1 j'_1} \cdots (\overline{B}_T)_{i'_n j'_n}] = \sum_{\pi} w_T(\pi) \mathbb{1}(\text{indices match with } \pi).$$

Here, the sum is over walled pairings $\pi \in \mathcal{M}(n, n)$ (recall Definition 2.13).

Using this, we may write

$$\mathbb{E}[\text{Tr}(M(\Gamma))] = \sum_{\pi = (\pi_1, \dots, \pi_L)} w_T(\pi_1) \cdots w_T(\pi_L) \prod_{\ell \in [L]} \prod_{\{a, b\} \in \pi_\ell} \delta^{i_a i_b} \prod_{e \in R(\Gamma)} \delta^{i_e}.$$

Now, observe that

$$\prod_{\ell \in [L]} \prod_{\{a, b\} \in \pi_\ell} \delta^{i_a i_b} \prod_{e \in R(\Gamma)} \delta^{i_e} = N^{\#\text{comp}(\Gamma, \pi)},$$

where recall $\#\text{comp}(\Gamma, \pi)$ is the number of components obtained by deleting all black strands but including all interior matchings specified by π_1, \dots, π_L . For instance, in our previous example, suppose our matchings were as in Figure 39. Since each edge in Figure 39 (be it red or black) imposes a constraint on the indices, the total number of free summation indices is exactly equal to the number of connected components in the above diagram. Each free summation index may take one of N values, whence the term $N^{\#\text{comp}(\Gamma, \pi)}$. Lemma 2.3 follows directly from these considerations⁸.

⁸In our discussion, we have only considered a single word, but everything extends directly to the case of multiple words.

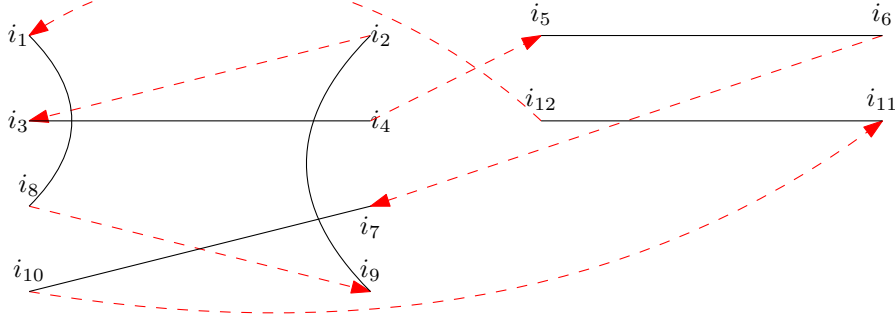

Figure 39: Visualization of the calculation of $\text{Tr}(M_1^2 M_2 M_1^{-2} M_2^{-1})$, where now $M_1 = \rho_+(\pi_1)$, $M_2 = \rho_+(\pi_2)$, for the matchings $\pi_1 \in \mathcal{M}(4)$, $\pi_2 \in \mathcal{M}(2)$ displayed in the figure.

Now recall from Definition 2.22 that the matrix elements of the representation $\rho_+(\pi)$ are exactly given by

$$(\rho_+(\pi))_{i \sqcup i', j \sqcup j'} = \mathbb{1}(\text{indices match with } \pi).$$

Here, $i \sqcup i'$ denotes the length- $2n$ vector of indices given by concatenation: $(i_1, \dots, i_n, i'_1, \dots, i'_n)$, and similarly for $j \sqcup j'$. Combining this with the previous discussion, we have the following result. First, for some notation, let $\mathbf{i}_\ell, \mathbf{j}_\ell$ respectively collect all left and right indices which appear in the strand diagram corresponding to λ_ℓ . For the example in Figure 39, we have that $\mathbf{i}_1 = (i_1, i_3, i_8, i_7)$, $\mathbf{j}_1 = (i_2, i_4, i_7, i_9)$, $\mathbf{i}_2 = (i_5, i_{12})$, $\mathbf{j}_2 = (i_6, i_{11})$.

Lemma 4.15. Let Γ be a balanced collection of words on letters $\{\lambda_1, \dots, \lambda_L\}$. Let $\pi = (\pi_\ell, \ell \in [L])$. Then

$$\prod_{\ell \in [L]} \rho_+(\pi_\ell)_{\mathbf{i}_\ell \mathbf{j}_\ell} \prod_{e \in R(\Gamma)} \delta^{i_e} = N^{\#\text{comp}(\Gamma, \pi)}.$$

Using this lemma and the previous discussion, we could have written $\mathbb{E}[\text{Tr}(M(\Gamma))]$ in terms of $\rho_+(\pi_1), \dots, \rho_+(\pi_L)$, as follows.

Lemma 4.16. Let $\Gamma = (\Gamma_1, \dots, \Gamma_n)$ be a balanced collection of words with letters $\{\lambda_1, \dots, \lambda_L\}$. We have that

$$\mathbb{E}[\text{Tr}(B_T(\Gamma))] = \left(\sum_{\pi_1 \in \mathcal{B}_{n_1, n_1}} w_T(\pi_1) \rho_+(\pi_1) \right)_{\mathbf{i}_1 \mathbf{j}_1} \cdots \left(\sum_{\pi_L \in \mathcal{B}_{n_L, n_L}} w_T(\pi_L) \rho_+(\pi_L) \right)_{\mathbf{i}_L \mathbf{j}_L} \prod_{e \in R(\Gamma)} \delta^{i_e},$$

As mentioned at the beginning of this subsection, we have rewritten expectations of traces of words of Unitary Brownian motion in terms of some function (namely, ρ_+) of weighted sums over the Brauer algebra. The point now is that $\lim_{T \rightarrow \infty} \rho_+(\mathbb{E}[\bar{\pi}_{T_n} \mathbb{1}(T_n \leq T)])$ exists for all N . Once we show this, the rest of the proof of Theorem 2.5 in the case of general N is exactly the same.

Lemma 4.17 (Analog of Lemma 4.9). We have that

$$\lim_{T \rightarrow \infty} \rho_+(\mathbb{E}[\bar{\pi}_{T_n} e^{2(n-1)T_1} \mathbb{1}(T_n \leq T) e^{2(n-2)(T_2-T_1)} \cdots e^{2(n-n)(T_n-T_{n-1})}]) = n! N^n \rho_+(\text{Wg}_N).$$

Proof. By Lemma 4.8, we may compute

$$\begin{aligned} & \rho_+ \left(\mathbb{E} \left[\bar{\pi}_{T_n} e^{2(n-1)T_1} \mathbb{1}(T_n \leq T) e^{2(n-2)(T_2-T_1)} \dots e^{2(n-n)(T_n-T_{n-1})} \right] \right) = \\ & n! \int_0^T du_n \int_0^{T-u_1} du_{n-1} \dots \int_0^{T-(u_1+\dots+u_{n-1})} du_1 e^{-u_n \rho_+(\text{id}+J_n/N)} \dots e^{-u_1 \rho_+(\text{id}+J_1/N)}. \end{aligned}$$

By Lemma 2.28, for all $k \in [n]$, all eigenvalues of $\rho_+(J_k)$ are at least $-N + 1$, and thus all eigenvalues of $\rho_+(\text{id} + J_k/N)$ are at least $1/N$, and in particular all eigenvalues are strictly positive. Thus as we send $T \rightarrow \infty$ the above converges to (applying Lemma 2.29 in the final identity)

$$\begin{aligned} n! \int_0^\infty e^{-u_n \rho_+(\text{id}+J_n/N)} du_n \dots \int_0^\infty e^{-u_1 \rho_+(\text{id}+J_1/N)} du_1 &= n! \rho_+(\text{id} + J_n/N)^{-1} \dots \rho_+(\text{id} + J_1/N)^{-1} \\ &= n! N^n \rho_+(N + J_n)^{-1} \dots \rho_+(N + J_1)^{-1} \\ &= n! N^n \rho_+(\text{Wg}_N), \end{aligned}$$

as desired. \square

We also have the following analogs of Lemma 4.10 and Proposition 4.11.

Lemma 4.18 (Analog of Lemma 4.10). Suppose that Σ is a Poisson process arising from having $n - 1$ top strands and n bottom strands. Then

$$\sup_{T \geq 0} e^{\binom{2n-1}{2}T - (n-1)T} \|\rho_+(\mathbb{E}[F(\Sigma(T))])\| < \infty.$$

Proof. In the proof of Lemma 4.10, the condition on N was needed to show that

$$\begin{aligned} & \int_0^\infty e^{-nu} \|e^{-u(J_n+\dots+J_1)/N} e^{-u(J'_{n+1}+\dots+J'_1)/N}\| du < \infty, \\ & \sup_{T \geq 0} e^{-nT} \|e^{-T(J_n+\dots+J_1)/N} e^{-T(J'_{n+1}+\dots+J'_1)/N}\| < \infty. \end{aligned}$$

When we apply ρ_+ , we instead need to show that

$$\begin{aligned} & \int_0^\infty e^{-nu} \|e^{-u\rho_+(J_n+\dots+J_1)/N} e^{-u\rho_+(J'_{n+1}+\dots+J'_1)/N}\| du < \infty, \\ & \sup_{T \geq 0} e^{-nT} \|e^{-T\rho_+(J_n+\dots+J_1)/N} e^{-T\rho_+(J'_{n+1}+\dots+J'_1)/N}\| < \infty. \end{aligned}$$

These claims both follow from Corollary 2.31, which gives that the eigenvalues of $\frac{1}{N}\rho_+(J_n + \dots + J_1) + \frac{1}{N}\rho_+(J'_{n+1} + \dots + J'_1)$ are all strictly greater than $-n$. \square

Proposition 4.19 (Analog of Proposition 4.11). We have that

$$\lim_{T \rightarrow \infty} e^{\binom{2n}{2}T - nT} \rho_+(\mathbb{E}[F(\Sigma(T))\mathbb{1}(T_n > T)]) = 0.$$

Proof. The points in the proof of Proposition 4.11 where we needed N to be large were in the application of Lemma 4.10 and in arguing that $e^{-u}e^{-uJ_{n+1}/N}$ is integrable. For the present proposition, we may apply Lemma 4.18 which does not require N to be large. The fact that $e^{-u}e^{-u\rho_+(J_{n+1})/N}$ is integrable follows from Lemma 2.28, as noted in the proof of Lemma 4.17. \square

Proposition 4.20 (Analog of Proposition 4.12). We have that

$$\lim_{T \rightarrow \infty} e^{\binom{2n}{2}T - nT} \mathbb{E}[\rho_+(F(\Sigma(T)))] = \sum_{\sigma, \tau: [n] \rightarrow (n:2n)} \rho_+([\sigma \ \tau]) \text{Wg}_N(\sigma\tau^{-1}).$$

Proof. We argue exactly as in the proof of Proposition 4.12, except we replace the applications of Lemma 4.9 and Proposition 4.11 with Lemma 4.17 and Proposition 4.19. \square

Proof of Theorem 2.5. Combining Lemma 4.16 and Proposition 4.20, we have that

$$\lim_{T \rightarrow \infty} \mathbb{E}[\text{Tr}(B_T(\mathbf{\Gamma}))] = \prod_{\ell \in L} \left(\sum_{\sigma_\ell, \tau_\ell: [n] \rightarrow (n:2n)} \rho_+([\sigma_\ell \ \tau_\ell]) \text{Wg}_N(\sigma_\ell \tau_\ell^{-1}) \right) \prod_{i \in \mathbf{j}, \ell \in R(\mathbf{\Gamma})} \delta^{i_\ell}.$$

By Lemma 4.15, the right hand side above may be written

$$\sum_{\pi = ([\sigma_\ell \ \tau_\ell], \ell \in [L])} \left(\prod_{\ell \in L} \text{Wg}_N(\sigma_\ell \tau_\ell^{-1}) \right) N^{\#\text{comp}(\mathbf{\Gamma}, \pi)},$$

as desired. \square

5 Makeenko-Migdal/Master loop/Schwinger-Dyson equations

In this section, we utilize the Process process formulation described in Section 2.1 and analyzed in Section 4 to prove a recursion relation (Proposition 5.2) on expectations of products of traces of words in independent Haar-distributed Unitary matrices. We then apply this recursion to deduce the Makeenko-Migdal/Master loop/Schwinger-Dyson equations (Theorem 5.6) for Wilson loop expectations.

First, we describe the terms which will appear in our recursion. Let $\mathbf{\Gamma} = (\Gamma_1, \dots, \Gamma_k)$ be a collection of words on $\{\lambda_1, \dots, \lambda_L\}$. We will often refer to the edge at the (i, j) location of $\mathbf{\Gamma}$, which is meant to be the j th letter of Γ_i .

Definition 5.1 (Splittings and mergers). Let $\mathbf{\Gamma} = (\Gamma_1, \dots, \Gamma_k)$ be a collection of words on $\{\lambda_1, \dots, \lambda_L\}$. Let (i, j) be a location of $\mathbf{\Gamma}$. Define the set of positive and negative splittings $\mathbb{S}_+((i, j), \mathbf{\Gamma})$ and $\mathbb{S}_-((i, j), \mathbf{\Gamma})$, as well as the set of positive and negative mergers $\mathbb{M}_+^U((i, j), \mathbf{\Gamma})$ and $\mathbb{M}_-^U((i, j), \mathbf{\Gamma})$, as follows.

The set of positive splittings $\mathbb{S}_+((i, j), \mathbf{\Gamma})$ is the set of collections of words $\mathbf{\Gamma}'$ obtained by splitting Γ_i into two words as follows. Let (i, k) , $k \neq j$ be another location of Γ_i which has the same letter as at location (i, j) . Suppose Γ_i is of the form $A\lambda B\lambda C$, where λ is the

letter at locations (i, j) and (i, k) . We may split Γ_i into $\Gamma_{i,1} = A\lambda C$ and $\Gamma_{i,2} = B\lambda$. The set $\mathbb{S}_+((i, j), \mathbf{\Gamma})$ is the set of all collections of words that may be obtained this way.

Similarly, the set of negative splittings $\mathbb{S}_-((i, j), \mathbf{\Gamma})$ is the set of collections of words $\mathbf{\Gamma}'$ obtained by splitting Γ_i into two words as follows. Let (i, k) , $k \neq j$ be a location of Γ_i which has inverse of the letter at location (i, j) . We may write $\Gamma_i = A\lambda B\lambda^{-1}C$ or $\Gamma_i = A\lambda^{-1}B\lambda C$. In either case, we split Γ_i into $\Gamma_{i,1} = AC$ and $\Gamma_{i,2} = B$. The set $\mathbb{S}_-((i, j), \mathbf{\Gamma})$ is the set of all collections of words that may be obtained this way.

The set of positive mergers $\mathbb{M}_+^U((i, j), \mathbf{\Gamma})$ is the set of collections of words $\mathbf{\Gamma}'$ obtained by merging Γ_i with some Γ_ℓ , $\ell \neq i$, as follows. Let (ℓ, m) be a location which has the same letter as at location (i, j) . Suppose $\Gamma_i = A\lambda B$ and $\Gamma_\ell = C\lambda D$. Then Γ_i, Γ_ℓ are replaced by their positive merger $A\lambda DC\lambda B$. The set $\mathbb{M}_+^U((i, j), \mathbf{\Gamma})$ is the set of all collections of words that may be obtained this way.

Similarly, the set of negative mergers $\mathbb{M}_-^U((i, j), \mathbf{\Gamma})$ is the set of collections of collections of words $\mathbf{\Gamma}'$ obtained by merging Γ_i with some Γ_ℓ , $\ell \neq i$, as follows. Let (ℓ, m) be a location which has the inverse of the letter at location (i, j) . Suppose $\Gamma_i = A\lambda B$ and $\Gamma_\ell = C\lambda^{-1}D$. Then Γ_i, Γ_ℓ are replaced by their negative merger $A\lambda DCB$. The set $\mathbb{M}_-^U((i, j), \mathbf{\Gamma})$ is the set of all collections of words that may be obtained this way.

In the following, let $\text{tr}(U(\mathbf{\Gamma})) = \prod_{i \in [k]} \text{tr}(U(\Gamma_i))$, where $U(\Gamma_i)$ is obtained by substituting into Γ_i an independent Haar-distributed Unitary matrix for each letter $\{\lambda_1, \dots, \lambda_L\}$. Note that in contrast to previous results, we are using the normalized trace here, which we find to be more natural for stating the recursion.

Proposition 5.2 (Single-location word recursion). Let $\mathbf{\Gamma} = (\Gamma_1, \dots, \Gamma_k)$ be a collection of words on $\{\lambda_1, \dots, \lambda_L\}$. For any location (i, j) of $\mathbf{\Gamma}$, we have that

$$\begin{aligned} \mathbb{E}[\text{tr}(U(\mathbf{\Gamma}))] &= - \sum_{\mathbf{\Gamma}' \in \mathbb{S}_+((i, j), \mathbf{\Gamma})} \mathbb{E}[\text{tr}(U(\mathbf{\Gamma}'))] + \sum_{\mathbf{\Gamma}' \in \mathbb{S}_-((i, j), \mathbf{\Gamma})} \mathbb{E}[\text{tr}(U(\mathbf{\Gamma}'))] \\ &\quad - \frac{1}{N^2} \sum_{\mathbf{\Gamma}' \in \mathbb{M}_+^U((i, j), \mathbf{\Gamma})} \mathbb{E}[\text{tr}(U(\mathbf{\Gamma}'))] + \frac{1}{N^2} \sum_{\mathbf{\Gamma}' \in \mathbb{M}_-^U((i, j), \mathbf{\Gamma})} \mathbb{E}[\text{tr}(U(\mathbf{\Gamma}'))]. \end{aligned}$$

Proof. Without loss of generality, take $(i, j) = (1, 1)$, so that we look at the first letter of Γ_1 . Let $\lambda \in \{\lambda_1, \dots, \lambda_L\}$ be this letter. Recall from Corollary 2.7 that $\mathbb{E}[\text{Tr}(U(\mathbf{\Gamma}))]$ is equal to a sum over pairs of matchings of strand diagrams, weighted by the Weingarten function applied to each pair, as well as N raised to the number of components of the resulting strand diagram. For each strand diagram corresponding to a letter $\lambda' \neq \lambda$, fix a pair of matchings $\sigma_{\lambda'}, \tau_{\lambda'}$. We apply our strand-by-strand Poisson process exploration from Section 4 to the strand diagram corresponding to λ , but stop at the first time we see any point in the first exploration era. This will result in the claimed recursion.

Let n be the number of times that λ appears in $\mathbf{\Gamma}$, so that the portion of the strand diagram corresponding to λ has n right-directed strands and n left-directed strands. Let all notation be as in Section 4. Now, suppose that $N \geq 2n$. (As was the case for the proof of Theorem 2.5, the case of general N will follow by small modifications from the case of large N , by applying the representation ρ_+ and using the various general N results proven in Section 4.2.) By combining Lemma 4.4 and Propositions 4.5, 4.11, and Proposition 4.12,

we have that

$$\sum_{\sigma, \tau: [n] \rightarrow (n:2n)} \text{Wg}_N(\sigma\tau^{-1})[\sigma \tau] = \lim_{T \rightarrow \infty} \mathbb{E}[F(\mathcal{Q}(T_n)) \mathbb{1}(T_n \leq T) e^{2(n-1)T_1} e^{2(n-2)(T_2-T_1)} \dots e^{2(n-n)(T_n-T_{n-1})}].$$

We will derive a recursion for the left hand side above by looking at the first point seen by our exploration process \mathcal{Q} . For brevity, let

$$f_n(T) := \mathbb{E}[F(\mathcal{Q}(T_n)) \mathbb{1}(T_n \leq T) e^{2(n-1)T_1} e^{2(n-2)(T_2-T_1)} \dots e^{2(n-n)(T_n-T_{n-1})}].$$

Let U_1 be the time of the first swap seen by \mathcal{Q} . Note that U_1 is an exponential random variable with rate $2n - 1$ (since there are $n - 1$ possible same-direction swaps and n possible opposite-direction swaps). By conditioning on this time, we may obtain a recursion like

$$\begin{aligned} f_n(T) &= -\frac{1}{N} \sum_{j=1}^{n-1} \int_0^T e^{-(2n-1)u} \langle n \ j \rangle e^{2(n-1)u} f_n(T-u) du + \\ &\quad \frac{1}{N} \sum_{j=n+1}^{2n} \int_0^T e^{-(2n-1)u} \langle n \ j \rangle e^{2(n-1)u} f_{n-1}(j, T-u) du. \end{aligned}$$

Note the factor $e^{2(n-1)u}$ comes from the $e^{2(n-1)T_1}$ term. The first sum corresponds to the case that we first see a same-direction swap, and the second sum corresponds to the case that we first see an opposite-direction swap. Here, $f_{n-1}(j, T-u)$ denotes the corresponding expectation where we take out the top and bottom strand which are matched by the opposite-direction swap $\langle n \ j \rangle$ and continue the exploration on the remaining strands. The point now is that when we send $T \rightarrow \infty$, we obtain the recursion:

$$\begin{aligned} \sum_{\sigma, \tau: [n] \rightarrow (n:2n)} \text{Wg}_N(\sigma\tau^{-1})[\sigma \tau] &= -\frac{1}{N} \sum_{j=1}^{n-1} \sum_{\sigma, \tau: [n] \rightarrow (n:2n)} \text{Wg}_N(\sigma\tau^{-1})(n \ j)[\sigma \tau] + \\ &\quad \frac{1}{N} \sum_{j=n+1}^{2n} \sum_{\substack{\sigma, \tau: [n] \rightarrow (n:2n) \\ \sigma(n)=\tau(n)=j}} \text{Wg}_N(\sigma\tau^{-1})[\sigma \tau]. \end{aligned}$$

(In the case of general N the above is true after applying ρ_+ to both sides.) We now claim that by inserting this equation into the sum over pairs of matchings in the portion of the strand diagram corresponding to λ (and then applying Corollary 2.7 to compute the expectation), we obtain the claimed recursion. To help visualize why, note that before having explored the Poisson process, the strand diagram looks as in Figure 40.

Here, the top strand corresponds to the first letter of Γ_1 . The dashed red strands indicate the exterior connections which are determined by the words involving the letter λ . When we follow our exploration process until the first point of any kind, there are several possibilities that can occur. The first point can be (1) a same-direction swap which connects the top-most strand with another right-directed strand (2) an opposite-direction swap (i.e. turnaround) which connects the top-most strand with a left-directed strand. Also, the two strands which

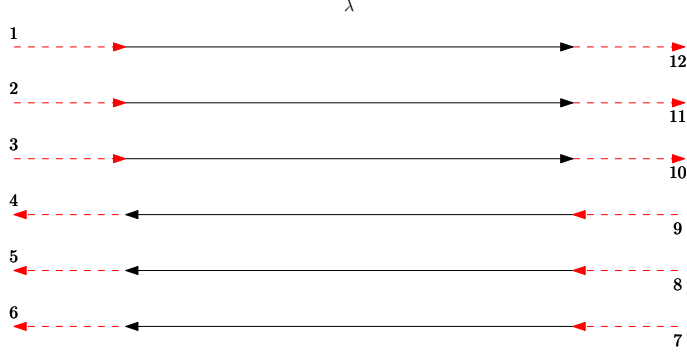

Figure 40: Strand diagram before exploration.

are connected can (1) be in the same word (2) be in different words. Any combination of these two things can happen, and so all told there are four different scenarios to account for. These four scenarios correspond to the four different categories of strings appearing in the right hand side of the loop equation: positive/negative splittings and positive/negative mergers. We proceed on a case-by-case basis. Throughout, let U_1 denote the time of the first point.

Suppose that the first point we see is a swap which connects the top-most strand with another right-directed strand, and moreover the two strands are in the same word. See Figure 41.

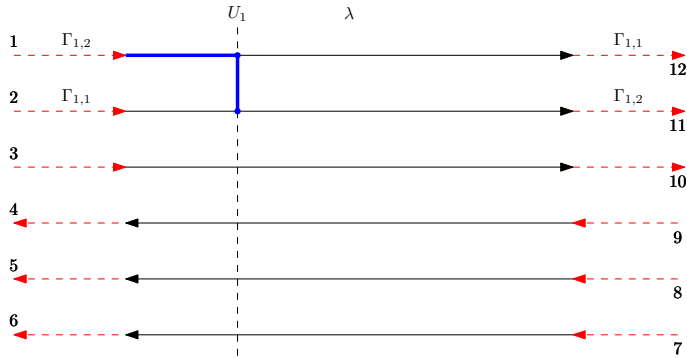

Figure 41: The first point is a swap which connects two strands in the same word.

Since the top two strands belong in the same word Γ_1 , we can write $\Gamma_1 = \lambda\Gamma_{1,1}\lambda\Gamma_{1,2}$, where $\Gamma_{1,1}$ collects all letters which appear in between the dashed red line labeled 12 and the dashed red line labeled 2, while $\Gamma_{1,2}$ collects all letters which appear in between the dashed red line labeled 11 and the dashed red line labeled 1. After accounting for the same-direction swap we saw, we may treat the part of the diagram after time U_1 as in Figure 42.

Notice here that the dashed red lines labeled 1 and 2 have been swapped. The effect of this is that the top and second-top strands are now in different words: $\lambda\Gamma_{1,1}$ and $\lambda\Gamma_{1,2}$. Note that the resulting string $s' = (\lambda\Gamma_{1,1}, \lambda\Gamma_{1,2}, \Gamma_2, \dots, \Gamma_k)$ is precisely a positive splitting of s at

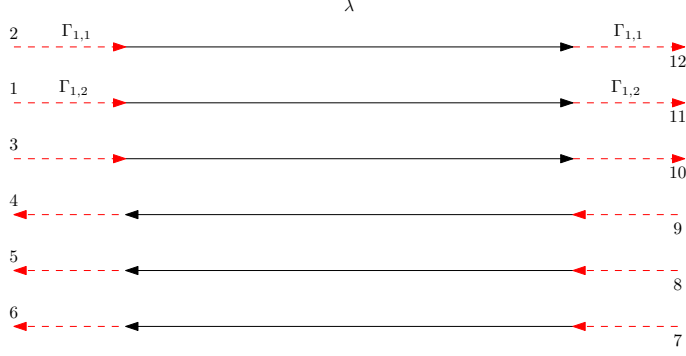

Figure 42: After accounting for the swap, we have the above effective strand diagram.

λ. We thus see that this case contributes the term

$$-\frac{1}{N} \sum_{\Gamma' \in \mathcal{S}_+((i,j), \Gamma)} \mathbb{E}[\text{Tr}(U(\Gamma'))].$$

If the first point is a swap but the two matched strands are in different words (say $\Gamma_1 = \lambda\Gamma'$ and $\Gamma_2 = \lambda\Gamma'_2$), then we would have the two diagrams in Figure 43.

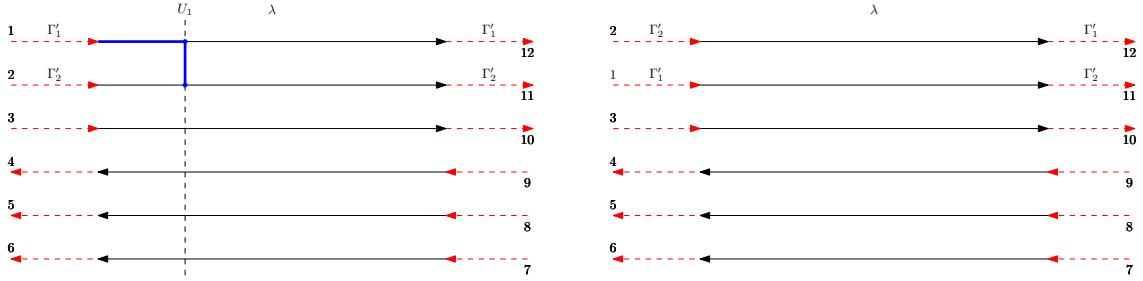

Figure 43: Left: the first point is a swap between strands in different words. Right: the resulting effective strand diagram.

Note that the two matched strands are now effectively in the same word: $\lambda\Gamma'_1\lambda\Gamma'_2$. Thus the case where the first point is a swap and the two matched strands are in different words contributes the positive merger term:

$$-\frac{1}{N} \sum_{\Gamma' \in \mathcal{M}_+^U(\lambda, \Gamma)} \mathbb{E}[\text{Tr}(U(\Gamma'))].$$

Next, suppose that the first point is a turnaround and the two matched strands are in the same word. We then have the two diagrams in Figure 44.

Originally, we have the word $\Gamma = \lambda\Gamma_{1,1}\lambda^{-1}\Gamma_{1,2}$. After seeing the turnaround swap, we may treat the rest of the diagram after U_1 as in the right figure, where the two matched strands have been deleted, and the word Γ has been replaced by two words $\Gamma_{1,1}$ and $\Gamma_{1,2}$. This case corresponds to a negative splitting, and contributes the term

$$\frac{1}{N} \sum_{\Gamma' \in \mathcal{S}_-(\lambda, \Gamma)} \mathbb{E}[\text{Tr}(U(\Gamma'))].$$

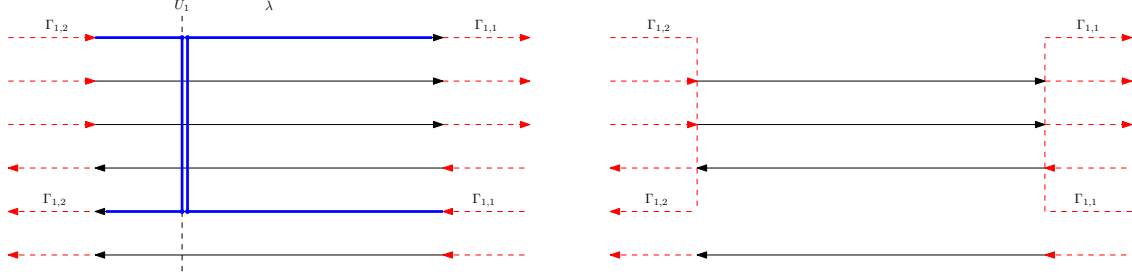

Figure 44: Left: the first point is a turnaroun between two strands in the same word. Right: the resulting effective strand diagram.

The final case is when the first point is a parallel swap and the two matched strands are in different words. The two pictures are as in Figure 45.

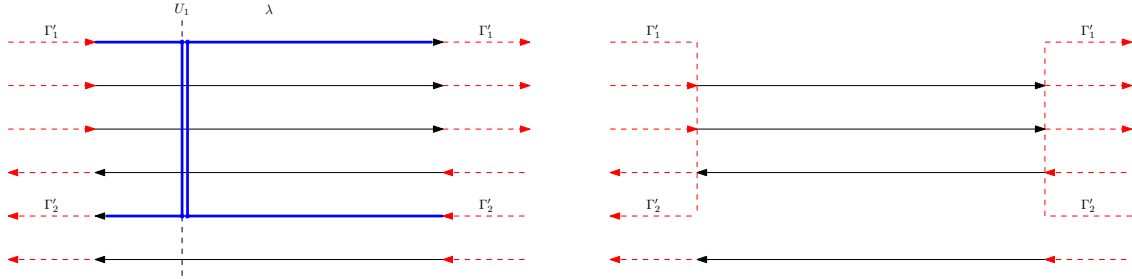

Figure 45: Left: the first point is a turnaroun between two strands in different words. Right: the resulting effective strand diagram.

Originally, the top strand is part of the word $\Gamma_1 = \lambda\Gamma'_1$, while the bottom strand is part of the word $\Gamma_2 = \lambda\Gamma'_2$. After the turnaroun swap, the two words Γ_1, Γ_2 merge to form the word $\Gamma'_1\Gamma'_2$. Thus, this case contributes the term

$$\frac{1}{N} \sum_{\Gamma' \in \mathbb{M}_+^U(\lambda, \Gamma)} \mathbb{E}[\text{Tr}(U(\Gamma'))].$$

In summary, we have obtained the following recursion (stated using the usual trace):

$$\begin{aligned} \mathbb{E}[\text{Tr}(U(\Gamma))] &= -\frac{1}{N} \sum_{\Gamma' \in \mathbb{S}_+((i,j), \Gamma)} \mathbb{E}[\text{Tr}(U(\Gamma'))] + \frac{1}{N} \sum_{\Gamma' \in \mathbb{S}_-((i,j), \Gamma)} \mathbb{E}[\text{Tr}(U(\Gamma'))] \\ &\quad - \frac{1}{N} \sum_{\Gamma' \in \mathbb{M}_+^U((i,j), \Gamma)} \mathbb{E}[\text{Tr}(U(\Gamma'))] + \frac{1}{N} \sum_{\Gamma' \in \mathbb{M}_-^U((i,j), \Gamma)} \mathbb{E}[\text{Tr}(U(\Gamma'))]. \end{aligned}$$

To convert to the normalized trace, we need to multiply both sides by $N^{-|k|}$, and then observe that in the splitting terms, a factor of $\frac{1}{N}$ gets absorbed due to the fact that $\Gamma' \in \mathbb{S}_\pm((i,j), \Gamma)$ has one more word than Γ , and in the merger terms, a factor of $\frac{1}{N}$ pops out because $\Gamma' \in \mathbb{M}_\pm^U((i,j), \Gamma)$ has one less word than Γ . \square

Next, we apply the loop recursion Proposition 5.2 to obtain a recursion for Wilson loop expectations. In contrast to the notation of Section 1, we denote collections of loops by s instead of \mathcal{L} , and we refer to s as a string. Recall the notation that $W_s(Q) = \prod_{k \in [n]} \text{tr}(Q_{\ell_k})$.

Notation 5.3. Given a string $s = (\ell_1, \dots, \ell_n)$, let $\phi(s) := \langle W_s \rangle_{\Lambda, \beta}$, where $\langle \cdot \rangle_{\Lambda, \beta}$ denotes expectation with respect to the lattice Yang-Mills measure defined in (1.1). We omit the dependence of ϕ on Λ, β, N .

Note that Definition 5.1 specializes to the case of loops on a lattice: given a string s , we have the sets of positive/negative splittings/mergers $\mathbb{S}_{\pm}((k, i), s)$ and $\mathbb{M}_{\pm}^U((k, i), s)$.

Remark 5.4. We remark that our definition of the set of splittings and mergers is slightly different than what appears in [Cha19a, SSZ22]. In our definition, we consider all possible splittings/mergers that involve the specific location (k, i) , whereas in the earlier works, the authors consider any splitting/merger that involves any two locations of the string which correspond to the same lattice edge.

We need to define another type of string operation which appears for lattice Yang-Mills.

Definition 5.5 (Deformations). Let $s = (\ell_1, \dots, \ell_n)$ be a string. Let (k, i) be a location in s . We define the sets of positive and negative deformations $\mathbb{D}_+((k, i), s)$ and $\mathbb{D}_-((k, i), s)$ as follows.

The set of positive deformations $\mathbb{D}_+((k, i), s)$ is the set of all possible strings which can be obtained by a positive merger between s at location (k, i) and some oriented plaquette $p \in \mathcal{P}$. The set of negative deformations $\mathbb{D}_-((k, i), s)$ is the set of possible strings which can be obtained by a negative merger between s at location (k, i) and some oriented plaquette $p \in \mathcal{P}$.

Let e be the oriented edge of Λ that is at location (k, i) in s . Let $p \in \mathcal{P}$. In order for their to exist a positive merger between s and p , note that p must contain e . In this case, we denote by $s \oplus_{(k, i)} p$ to be the positive merger of s and p at location (k, i) . Similarly, in order for their to exist a negative merger between s and p , note that p must contain $-e$. In this case, we denote by $s \ominus_{(k, i)} p$ to be the negative merger of s and p at location (k, i) .

Let $p \succ e$ denote that the plaquette p contains the edge e . Note then that (here e is the edge at location (k, i) of s)

$$\begin{aligned} \mathbb{D}_+((k, i), s) &= \{s \oplus_{(k, i)} p : p \in \mathcal{P}, p \succ e\} \\ \mathbb{D}_-((k, i), s) &= \{s \ominus_{(k, i)} p : p \in \mathcal{P}, p \succ -e\}. \end{aligned} \tag{5.1}$$

Theorem 5.6 (Single-location Makeenko-Migdal/Master loop/Schwinger-Dyson equation). *Let $s = (\ell_1, \dots, \ell_n)$ be a string. Let (k, i) be a location in s . We have that*

$$\begin{aligned} \phi(s) &= - \sum_{s' \in \mathbb{S}_+((k, i), s)} \phi(s') + \sum_{s' \in \mathbb{S}_-((k, i), s)} \phi(s') - \frac{1}{N^2} \sum_{s' \in \mathbb{M}_+^U((k, i), s)} \phi(s') + \frac{1}{N^2} \sum_{s' \in \mathbb{M}_-^U((k, i), s)} \phi(s') \\ &\quad - \beta \sum_{s' \in \mathbb{D}_+((k, i), s)} \phi(s') + \beta \sum_{s' \in \mathbb{D}_-((k, i), s)} \phi(s'). \end{aligned}$$

Remark 5.7. We re-emphasize here that the above recursion is slightly more general than previous literature [Cha19a, CJ16, SSZ22], because we defined the string operations appearing on the right hand side of the equation in a slightly more restrictive manner – recall Remark 5.4. In particular, the right hand side of our formula formally depends on i while the ‘unsymmetrized’ version stated in [Cha19a, Theorem 8.1] does not. The Makeenko-Migdal/Master loop/Schwinger-Dyson equation of the previous works may be recovered from our equation by summing over all locations of s .

Also, recall Remark 1.1 that our scaling is so that β in our paper corresponds to 2β in previous papers. This explains why β appears in the above recursion, while $\beta/2$ appears in [SSZ22, Equation (1.7)].

Proof. Recall from equation (1.5) that

$$\phi(s) = Z_{\Lambda, \beta}^{-1} \sum_{K: \mathcal{P} \rightarrow \mathbb{N}} \frac{(N\beta)^K}{K!} \int W_s(Q) \prod_{p \in \mathcal{P}} \text{Tr}(Q_p)^{K(p)} \prod_{e \in E_\Lambda} dQ_e.$$

For brevity, let

$$I(s, K) := \int W_s(Q) \prod_{p \in \mathcal{P}} \text{Tr}(Q_p)^{K(p)} \prod_{e \in E_\Lambda} dQ_e.$$

Fix $K : \mathcal{P} \rightarrow \mathbb{N}$. It may help to keep in mind that $K(p)$ counts the number of copies of p that are present. Before we apply Proposition 5.2, let us set some notation. Let e be the oriented edge of Λ that is traversed at location (k, i) in the string s . Recall that $p > e$ means that p contains e , and $p > -e$ means that p contains e with the opposite orientation. Recall also that if $p > e$ or $p > -e$, let $s \oplus_{(k, i)} p$ and $s \ominus_{(k, i)} p$ be the positive and negative deformations of s by p at location (k, i) . For $p \in \mathcal{P}$, let $\delta_p : \mathcal{P} \rightarrow \mathbb{N}$ be the delta function at p . Now applying the word recursion Proposition 5.2, we have that

$$\begin{aligned} I(s, K) &= -\frac{1}{N} \sum_{s' \in \mathbb{S}_+((k, i), s)} I(s', K) + \frac{1}{N} \sum_{s' \in \mathbb{S}_-((k, i), s)} I(s', K) \\ &\quad - \frac{1}{N} \sum_{s' \in \mathbb{M}_+^U((k, i), s)} I(s', K) + \frac{1}{N} \sum_{s' \in \mathbb{M}_-^U((k, i), s)} I(s', K) \\ &\quad - \frac{1}{N} \sum_{\substack{p \in \mathcal{P} \\ p > e}} K(p) I(s \oplus_{(k, i)} p, K - \delta_p) + \frac{1}{N} \sum_{\substack{p \in \mathcal{P} \\ p > -e}} K(p) I(s \ominus_{(k, i)} p, K - \delta_p). \end{aligned}$$

(Here, the factor of $K(p)$ arising in the last two terms arises because there are $K(p)$ copies of the plaquette p which can possibly be used to deform s .) From this, we obtain (note that in the splitting terms, the $1/N$ factor gets absorbed due to the fact that s' has one more loop than s , while in the merging terms, there is an extra $1/N$ factor because s' has one less loop than s)

$$\phi(s) = - \sum_{s' \in \mathbb{S}_+((k, i), s)} \phi(s) + \sum_{s' \in \mathbb{S}_-((k, i), s)} \phi(s) - \frac{1}{N^2} \sum_{s' \in \mathbb{M}_+^U((k, i), s)} \phi(s') + \frac{1}{N^2} \sum_{s' \in \mathbb{M}_-^U((k, i), s)} \phi(s')$$

$$+ D_1 + D_2,$$

where

$$D_1 := -Z_{\Lambda, \beta}^{-1} \frac{1}{N} \sum_{\substack{p \in \mathcal{P} \\ p > e}} \sum_{\substack{K: \mathcal{P} \rightarrow \mathbb{N} \\ K(p) \geq 1}} \frac{(N\beta)^K}{K!} K(p) I(s \oplus_{(k,i)} p, K - \delta_p),$$

$$D_2 := Z_{\Lambda, \beta}^{-1} \frac{1}{N} \sum_{\substack{p \in \mathcal{P} \\ p > -e}} \sum_{\substack{K: \mathcal{P} \rightarrow \mathbb{N} \\ K(p) \geq 1}} \frac{(N\beta)^K}{K!} K(p) I(s \ominus_{(k,i)} p, K - \delta_p)$$

Observe that we may write (by changing variables $K \mapsto K - \delta_p$ and then recalling (5.1))

$$D_1 = -Z_{\Lambda, \beta}^{-1} \frac{1}{N} (N\beta) \sum_{\substack{p \in \mathcal{P} \\ p > e}} \sum_{K: \mathcal{P} \rightarrow \mathbb{N}} \frac{(N\beta)^K}{K!} I(s \oplus_{(k,i)} p, K)$$

$$= -\beta \sum_{\substack{p \in \mathcal{P} \\ p > e}} \phi(s \oplus_{(k,i)} p) = -\beta \sum_{s' \in \mathbb{D}_+((k,i), s)} \phi(s'),$$

and similarly

$$D_2 = \beta \sum_{\substack{p \in \mathcal{P} \\ p > -e}} \phi(s \ominus_{(k,i)} p) = \beta \sum_{s' \in \mathbb{D}_-((k,i), s)} \phi(s').$$

The desired result now follows. □

6 Other groups

In this section, we adapt our results to the cases $G = \mathrm{O}(N), \mathrm{Sp}(N/2), \mathrm{SU}(N), \mathrm{SO}(N)$. In Section 6.1, we address the cases $G = \mathrm{O}(N), \mathrm{Sp}(N/2)$, and in Section 6.2, we address the cases $G = \mathrm{SU}(N), \mathrm{SO}(N)$. Define the matrix J by

$$J := \begin{pmatrix} 0 & I_{N/2} \\ -I_{N/2} & 0 \end{pmatrix}. \tag{6.1}$$

We quickly recall the definitions of the various groups.

$$\begin{aligned} \mathrm{O}(N) &:= \{O \in \mathrm{GL}(N, R) : O^T O = I_N\} \\ \mathrm{Sp}(N/2) &:= \{S \in \mathrm{U}(N) : S^T J S = J\} \\ \mathrm{SU}(N) &:= \{U \in \mathrm{U}(N) : \det(S) = 1\} \\ \mathrm{SO}(N) &:= \{O \in \mathrm{SO}(N) : \det(O) = 1\}. \end{aligned}$$

Notation 6.1. Let $\mathbf{\Gamma} = (\Gamma_1, \dots, \Gamma_M)$ be a collection of words on $\{\lambda_1, \dots, \lambda_L\}$. Given a compact Lie group G , we will denote $\mathrm{Tr}(G(\mathbf{\Gamma})) = \mathrm{Tr}(G(\Gamma_1)) \cdots \mathrm{Tr}(G(\Gamma_M))$, where $G(\Gamma_i)$ is obtained by substituting an independent Haar-distributed element of G for each of the letters $\{\lambda_1, \dots, \lambda_L\}$.

6.1 Orthogonal and Symplectic

In this section, we adapt our previous results to $G = O(N), Sp(N/2)$. These two cases are at times very similar, and thus we choose to place them in the same section. However, they are also at times very different, which prevents us from handling the two cases completely simultaneously – there are certain parts which require special attention in the $O(N)$ case, and certain parts in the $Sp(N/2)$ case.

Notation 6.2. In this section, we will denote matchings on $[n]$ (i.e. partitions of $[n]$ into two-element sets) by $\pi, \pi', \pi'',$ etc., and often write $\pi : [n] \rightarrow [n]$.

6.1.1 Orthogonal surface sums

First, we discuss the surface sums that arise in the $O(N)$ case. We begin by introducing the needed setup in order to state the analog of Corollary 2.7 (the Unitary Weingarten calculus) for $O(N)$.

Definition 6.3 (Unoriented-balanced collection of words). Let $\mathbf{\Gamma} = (\Gamma_1, \dots, \Gamma_M)$ be a collection of words on letters $\{\lambda_1, \dots, \lambda_L\}$. For $\ell \in [L]$, let n_ℓ be the total number of times λ_ℓ or λ_ℓ^{-1} occurs in $\mathbf{\Gamma}$. We say that $\mathbf{\Gamma}$ is unoriented-balanced if n_ℓ is even for each $\ell \in [L]$.

Remark 6.4. By $O \mapsto -O$ distributional symmetry of Haar-distributed $O(N)$ matrices, if $\mathbf{\Gamma}$ is not unoriented-balanced then $\mathbb{E}[\text{Tr}(O(\mathbf{\Gamma}))] = 0$. Thus when computing $\mathbb{E}[\text{Tr}(O(\mathbf{\Gamma}))]$, we may assume $\mathbf{\Gamma}$ is unoriented-balanced.

Definition 6.5. Let $n \geq 1$ be even. Let $\pi, \pi' : [n] \rightarrow [n]$ be matchings. Visually, we will think of π, π' as giving left and right matchings, as in the Figure 46. This defines an element of the Brauer algebra \mathcal{B}_n , which we denote by $[\pi \pi']$.

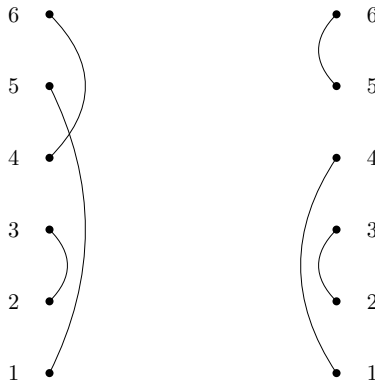

Figure 46: Here, $n = 6$. The left matching is $\pi = \{\{4, 6\}, \{1, 5\}, \{2, 3\}\}$. The right matching is $\pi' = \{\{5, 6\}, \{1, 4\}, \{2, 3\}\}$. The left and right matchings together define an element $[\pi \pi']$ of \mathcal{B}_n .

Let $\#\text{cycles}(\pi, \pi')$ be the number of connected components in the graph one obtains by adding in the strands connecting the left and right vertices - see Figure 47 for an example.

Definition 6.6. Let $n \geq 1$ be even. Given left and right matchings $\pi, \pi' : [n] \rightarrow [n]$, the face profile $\ell(\pi, \pi')$ is the partition of n induced by the cycles of $\pi\pi'$.

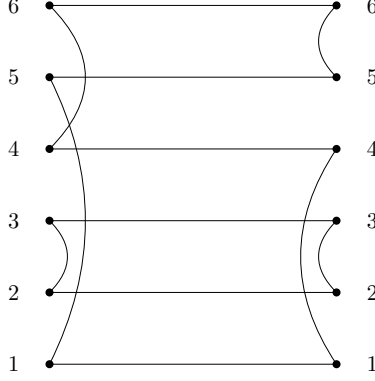

Figure 47: For the left and right matchings π, π' from Figure 46, there are two connected components in the graph obtained by adding the strands, and thus $\#\text{cycles}(\pi, \pi') = 2$.

We note that all parts of $\ell(\pi, \pi')$ are even, and thus $\frac{1}{2}\ell(\pi, \pi')$ is a partition of $\frac{n}{2}$. For the matchings π, π' in Figures 46 and 47, the face profile $\ell(\pi, \pi') = \{4, 2\}$. Note also that $\#\text{cycles}(\pi, \pi')$ is exactly the number of parts of $\ell(\pi, \pi')$.

Definition 6.7 (Orthogonal Weingarten function). Let $\zeta \in \mathbb{C}$. Let $n \geq 1$ be even. We define the Orthogonal Weingarten function $\text{Wg}_{\zeta, n}^{\text{O}}$ as follows. The input is a pair of matchings $\pi, \pi' : [n] \rightarrow [n]$, and the output is a number $\text{Wg}_{\zeta, n}^{\text{O}}(\pi, \pi') \in \mathbb{C}$. First, define the Gram matrix

$$\mathbf{G}_{\zeta, n}^{\text{O}}(\pi, \pi') := \zeta^{\#\text{cycles}(\pi, \pi')}, \quad \pi, \pi' : [n] \rightarrow [n] \text{ matchings.}$$

We define $\text{Wg}_{\zeta, n}^{\text{O}}$ to be the pseudo-inverse of $\mathbf{G} = \mathbf{G}_{\zeta, n}^{\text{O}}(\pi, \pi')$, that is the symmetric matrix W which satisfies

$$WGW = W \text{ and } GWG = \mathbf{G}.$$

We typically omit the n variable and write $\text{Wg}_{\zeta}^{\text{O}}$. The normalized Orthogonal Weingarten function is defined to be

$$\overline{\text{Wg}}_{\zeta}^{\text{O}}(\pi, \pi') = \zeta^{n - \#\text{cycles}(\pi, \pi')} \text{Wg}_{\zeta}^{\text{O}}(\pi, \pi').$$

Remark 6.8. From [CS06, Theorem 3.13], the normalized Orthogonal Weingarten function has the following large- N asymptotics:

$$\lim_{N \rightarrow \infty} \overline{\text{Wg}}_N^{\text{O}}(\pi, \pi') = \prod_{a \in \frac{1}{2}\ell(\pi, \pi')} (-1)^{a-1} c_{a-1},$$

where c_k is the k th Catalan number as in (3.1), and the product is over all parts in the face profile of $\frac{1}{2}\ell(\pi, \pi')$ (which recall is a partition of $\frac{n}{2}$).

In fact, the proof of the cited theorem extends without change to a general complex parameter $\zeta \rightarrow \infty$, and thus we have that

$$\lim_{\zeta \rightarrow \infty} \overline{\text{Wg}}_{\zeta}^{\text{O}}(\pi, \pi') = \prod_{a \in \frac{1}{2}\ell(\pi, \pi')} (-1)^{a-1} c_{a-1}.$$

We state the following lemma which says that the Orthogonal Weingarten function is a function of the face profile of (π, π') . It essentially follows from [Mat13], although we haven't found a precise statement in the literature. Thus for the reader's convenience, we give more detail as to why the lemma is true in Appendix A.

Lemma 6.9. The Orthogonal Weingarten function $\text{Wg}_\zeta^\text{O}(\pi, \pi')$ is a function of the face profile $\ell(\pi, \pi')$ of π, π' .

Remark 6.10. We defined the Orthogonal Weingarten function in a slightly different manner than the Unitary Weingarten function (Definition 2.21). For an expression of Wg_ζ^O in terms of characters, see [CS06, Theorem 3.9] or [ZJ09, Proposition 5]. The interpretation of the Weingarten function which is most relevant for us is as a weight assigned to pairs of left and right matchings, and the most direct definition of Wg_ζ^O from this point of view is as the pseudo-inverse of the Gram matrix.

Also, note that we defined the Orthogonal Weingarten function for a general complex parameter $\zeta \in \mathbb{C}$. This did not require any extra considerations. For Orthogonal Haar integration, this level of generality is not needed and we could have restricted to $\zeta = N$ a positive integer. However, it turns out that the Symplectic Weingarten function is related to the Orthogonal Weingarten function with $\zeta = -N$ a negative integer – see Lemma 6.21. Moreover, it will be more convenient to work with Wg_{-N}^O rather than the Symplectic Weingarten function, due to a certain sign issue. See Remark 6.27 for more discussion.

Definition 6.11. Let $n \geq 1$ be even. Let $\pi_0 : [n] \rightarrow [n]$ be the matching given by $\{\{n, n-1\}, \{n-2, n-3\}, \dots, \{2, 1\}\}$. One may visualize π_0 as in Figure 48. We omit the dependence of π_0 on n .

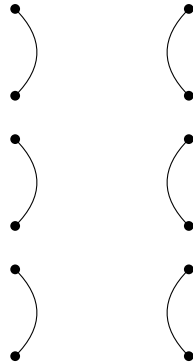

Figure 48: $[\pi_0 \ \pi_0]$ when $n = 6$

Definition 6.12. Let n be even. For each matching $\pi : [n] \rightarrow [n]$, we define a permutation $\sigma_\pi \in S_n$ such that $\sigma_\pi[\pi \ \pi]\sigma_\pi^{-1} = [\pi_0 \ \pi_0]$ as follows. We may write $\pi = \{\{\pi(1), \pi(2)\}, \dots, \{\pi(n-1), \pi(n)\}\}$, where $1 = \pi(1) < \pi(3) < \dots < \pi(n-1)$, and $\pi(2j-1) < \pi(2j)$ for $j \in [n/2]$. We then define $\sigma_\pi(j) := \pi(j)$.

See Figure 49 for an example of σ_π . Visually, σ_π can be thought of as a permutation of the vertices which takes $[\pi \ \pi]$ to the “standard form” $[\pi_0 \ \pi_0]$. In general, there may be many such permutations; the definition of σ_π makes a particular choice for each π . This

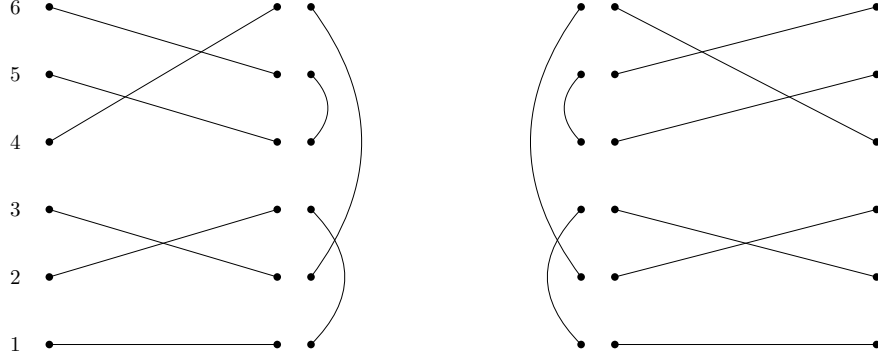

Figure 49: In the middle, we have $[\pi \pi]$ where $\pi = \{\{1, 3\}, \{2, 6\}, \{4, 5\}\}$. Thus $\sigma_\pi = (1\ 3\ 2\ 6\ 4\ 5)$ (written in one-line notation). We see that upon conjugating $[\pi \pi]$ by σ_π , we get the “standard form” $[\pi_0 \pi_0]$.

particular way of choosing the permutation does not matter so much for $O(N)$, however for $\text{Sp}(N/2)$ it is important that σ_π be defined as it is, due to the fact that $\text{sgn}(\sigma_\pi)$ appears in the definition of the Symplectic Gram matrix (see Definition 6.19), and thus also the Symplectic Weingarten function. (Different permutations which take $[\pi \pi]$ to the standard form $[\pi_0 \pi_0]$ may have opposite signs.)

Let $\mathbf{\Gamma} = (\Gamma_1, \dots, \Gamma_M)$ be an unoriented-balanced collection of words on $\{\lambda_1, \dots, \lambda_L\}$. Recall that in the Unitary case, the choice of $\mathbf{\Gamma}$ specifies a choice of red exterior connections in our strand diagram. In the orthogonal case, the situation is similar, except now we specify that all strands point in the same direction (right). By doing so, the dashed red strands that we add may not have a consistent orientation with the black strands. This is a reflection of the fact that in the Orthogonal case, the surfaces we obtain may be unorientable. We explain through an example how to obtain the red exterior connections from $\mathbf{\Gamma}$ – see Figure 50.

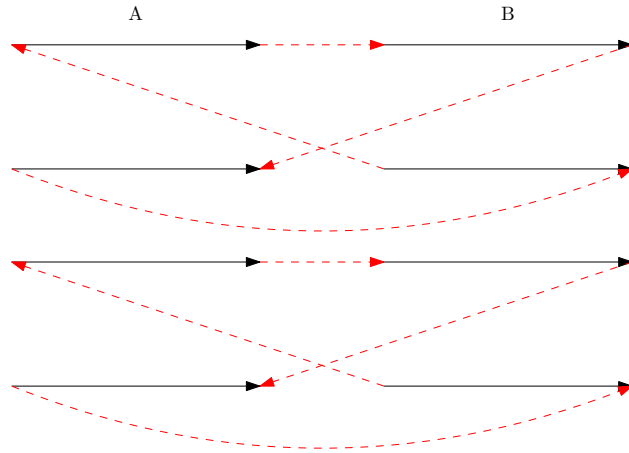

Figure 50: The red exterior connections arising from the words $\mathbf{\Gamma} = (ABA^{-1}B^{-1}, ABA^{-1}B^{-1})$. Compare with the right of Figure 9 in the Unitary case with the exact same $\mathbf{\Gamma}$.

For each $\ell \in [L]$, let $\pi_\ell, \pi'_\ell : [n_\ell] \rightarrow [n_\ell]$ be matchings. Similar to the Unitary case,

we may form the diagram obtained by Γ and $\pi = (\pi_\ell, \pi'_\ell, \ell \in [L])$ by starting with the red exterior connections specified by π , and then adding in the blue interior connections specified by π . Let $\#\text{comp}(\Gamma, \pi)$ be the number of components of this diagram. See Figure 51 for an example.

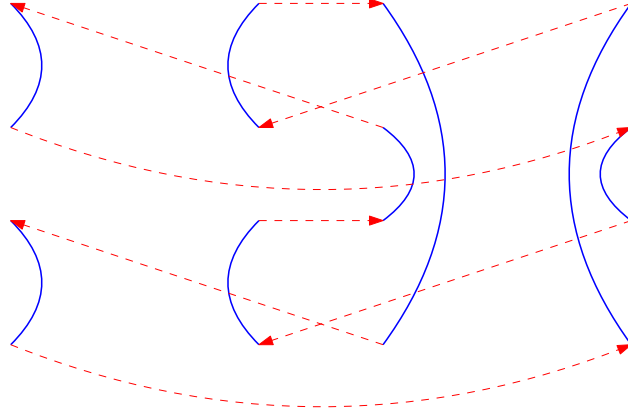

Figure 51: Let Γ be the same as in Figure 50. For some particular choice of π , we may end up with the blue interior connections as displayed. In this case, $\#\text{comp}(\Gamma, \pi) = 2$.

Proposition 6.13 (Orthogonal Weingarten calculus). Let $G = O(N)$. Let $\Gamma = (\Gamma_1, \dots, \Gamma_k)$ be an unoriented-balanced collection of words on $\{\lambda_1, \dots, \lambda_L\}$. Then

$$\mathbb{E}[\text{Tr}(G(\Gamma))] = \sum_{\pi = (\{\pi_\ell, \pi'_\ell\}, \ell \in [L])} \left(\prod_{\ell \in L} \text{Wg}_N^O(\pi_\ell, \pi'_\ell) \right) N^{\#\text{comp}(\Gamma, \pi)}.$$

Here, the sum in the right hand side is over π which is a collection of pairs of matchings $\pi_\ell, \pi'_\ell : [n_\ell] \rightarrow [n_\ell]$, $\ell \in [L]$.

We proceed towards applying Proposition 6.13 to give expressions for Wilson loop expectations of $O(N)$ lattice gauge theories. First, we need some setup. Exactly as in the Unitary case, given (Γ, π) , we may obtain a map whose dual is bipartite as follows. We start with one yellow face for each word in Γ . For each letter λ_ℓ , the left and right matchings π_ℓ, π'_ℓ giving the interior connections in the portion of the diagram corresponding to λ_ℓ then specify an additional collection of blue faces which are glued to the yellow faces which contain the letter λ_ℓ or its inverse.

Definition 6.14. Let $\Gamma = (\Gamma_1, \dots, \Gamma_k)$ be an unoriented-balanced collection of words on $\{\lambda_1, \dots, \lambda_L\}$. Define $\text{DBM}_{\text{OS}}(\Gamma)$ to be the set of all possible maps which can be obtained from adding interior left and right matchings to the strand diagram corresponding to Γ . For a given map $\mathcal{M} \in \text{DBM}_{\text{OS}}(\Gamma)$, and $\ell \in [L]$, let $\mu_\ell(\mathcal{M})$ be the partition of n_ℓ (the total number of occurrences of λ_ℓ and λ_ℓ^{-1}) given by the degrees of the blue faces which are glued in to the strand diagram of λ_ℓ (this is the same as the face profile of the left and right matchings $\pi = (\pi_\ell, \pi'_\ell, \ell \in [L])$ used to construct \mathcal{M}).

Here, the subscript ‘‘OS’’ is short for Orthogonal and Symplectic, since DBM_{OS} is the set of maps that one obtains in these cases.

Remark 6.15. Unlike in the Unitary case, the maps in DBM_{OS} may be unorientable.

Proposition 6.16. Let $G = \text{O}(N)$. Let $\mathbf{\Gamma} = (\Gamma_1, \dots, \Gamma_k)$ be an unoriented-balanced collection of words on $\{\lambda_1, \dots, \lambda_L\}$. We have that

$$\mathbb{E}[\text{Tr}(G(\mathbf{\Gamma}))] = \sum_{\mathcal{M} \in \text{DBM}_{\text{OS}}(\mathbf{\Gamma})} \left(\prod_{\ell \in [L]} \overline{\text{Wg}}_N^{\text{O}}(\mu_\ell(\mathcal{M})) \right) N^{\chi(\mathcal{M}) - k}.$$

As in the Unitary case, when the letters $\{\lambda_1, \dots, \lambda_L\}$ are edges of the lattice Λ , then any map $\mathcal{M} \in \text{DBM}_{\text{OS}}(\mathbf{\Gamma})$ naturally gives an edge-plaquette embedding (\mathcal{M}, ψ) , where ψ is determined by the requirement that it maps edges of \mathcal{M} to the corresponding edges of the lattice.

Definition 6.17. Let $s = (\ell_1, \dots, \ell_n)$ be a string, and let $K : \mathcal{P} \rightarrow \mathbb{N}$. Define the set $\text{EPE}_{\text{OS}}(s, K)$ of edge-plaquette embeddings associated to s, K to as follows. If s, K is not unoriented-balanced, then $\text{EPE}(s, K) := \emptyset$. If s, K is unoriented-balanced, let $\mathbf{\Gamma}$ be the collection of words consisting of s and $K(p)$ copies of the plaquette p for each $p \in \mathcal{P}$. We define $\text{EPE}_{\text{OS}}(s, K)$ to be the set of edge-plaquette embedding (\mathcal{M}, ψ) obtained from maps $\mathcal{M} \in \text{DBM}_{\text{OS}}(\mathbf{\Gamma})$.

Next, define

$$\text{EPE}_{\text{OS}}(s) := \bigsqcup_{K: \mathcal{P} \rightarrow \mathbb{N}} \text{EPE}_{\text{OS}}(s, K).$$

For $(\mathcal{M}, \psi) \in \text{EPE}_{\text{OS}}(s)$, and $e \in E_\Lambda$, let $\mu_e(\psi)$ be the partition of $|\psi^{-1}(e)|/2$ induced by $1/2$ times the degrees of the faces of $\psi^{-1}(e)$. Define

$$\begin{aligned} \text{area}(\mathcal{M}, \psi) &:= \sum_{p \in \mathcal{P}} |\psi^{-1}(p)|, \\ (\psi^{-1})! &:= \prod_{p \in \mathcal{P}} |\psi^{-1}(p)|!. \end{aligned}$$

Note that if $(\mathcal{M}, \psi) \in \text{EPE}_{\text{OS}}(s, K)$, then $\text{area}(\mathcal{M}, \psi) = \sum_p K(p)$ and $(\psi^{-1})! = K!$.

We now arrive at the following theorem, which is the analog of Corollary 3.11. Since the proof is very similar to the proof of the corollary, it is omitted.

Theorem 6.18. Let $s = (\ell_1, \dots, \ell_n)$ be a string. For $\text{O}(N)$ lattice gauge theory, we have that

$$\langle W_s \rangle_{\Lambda, \beta} = Z_{\Lambda, \beta}^{-1} \sum_{(\mathcal{M}, \psi) \in \text{EPE}_{\text{OS}}(s)} \frac{\beta^{\text{area}(\mathcal{M}, \psi)}}{(\psi^{-1})!} \left(\prod_{e \in E_\Lambda} \overline{\text{Wg}}_N^{\text{O}}(\mu_e(\psi)) \right) N^{\chi(\mathcal{M}) - 2n}.$$

6.1.2 Symplectic surface sums

Next, we discuss the surface sums in the Symplectic case. This case is more complicated than before due to a certain sign issue. We start by working towards the definition of the Symplectic Weingarten function.

Definition 6.19 (Symplectic Weingarten function). Define the Symplectic Weingarten function $\text{Wg}_{N,n}^{\text{Sp}}$ as follows. First, define the Gram matrix

$$\mathbf{G}_{N,n}^{\text{Sp}}(\pi, \pi') := (-1)^{n/2} \text{sgn}(\sigma_\pi) \text{sgn}(\sigma_{\pi'}) (-N)^{\#\text{cycles}(\pi, \pi')}, \quad \pi, \pi' : [n] \rightarrow [n] \text{ matchings.}$$

We define $\text{Wg}_{N,n}^{\text{Sp}}$ to be the pseudo-inverse of $\mathbf{G}_{N,n}^{\text{Sp}}$. We typically omit the dependence on n and write Wg_N^{Sp} .

Remark 6.20. This definition of the Symplectic Weingarten function is not so easy to find in the literature. For instance, the first paper on the topic [CS06] does not give an explicit formula for the Symplectic Weingarten function, nor does the recent survey [CMN22]. The paper [MP22] which applies the Symplectic Weingarten calculus only posits the existence of some function which can be used to compute Symplectic matrix integrals (see [MP22, Theorem 3.1]). The paper [Mat13] defines the Symplectic Weingarten function as a certain element W of the group algebra $\mathbb{C}[S_n]$ (Matsumoto denotes this element by Wg^{Sp}). The relation between Matsumoto's definition and our definition via pseudo-inverses is precisely stated in [Mat13, Lemma 2.5], which says that the Weingarten weight $\text{Wg}_N^{\text{Sp}}(\pi, \pi')$ assigned to a pair of matchings π, π' is precisely $W(\sigma_\pi^{-1} \sigma_{\pi'})$. We prefer to give the pseudo-inverse definition in the present paper, because it is the most easy to state and understand. This way, the reader who only wishes to be able to understand the weights that appear in our surface sums can do so without having to spend too much time on background material.

By comparing the definitions of the Orthogonal (Definition 6.7) and Symplectic Weingarten functions, the next lemma follows immediately. (Here we also use the uniqueness of the pseudo-inverse of a matrix.)

Lemma 6.21. We have that

$$\text{Wg}_N^{\text{Sp}}(\pi, \pi') = (-1)^{n/2} \text{sgn}(\sigma_\pi) \text{sgn}(\sigma_{\pi'}) \text{Wg}_{-N}^{\text{O}}(\pi, \pi'), \quad \pi, \pi' : [n] \rightarrow [n].$$

Remark 6.22. This relation between the Orthogonal and Symplectic Weingarten functions has previously been observed, see for instance the end of [Mat13, Section 2.3.2]. When $N \geq n$, this identity is also stated as [MP22, Lemma 3.2]. We note that by defining Weingarten functions as pseudo-inverses of the appropriate Gram matrices, it is trivial to see that the relation holds for general N (indeed, even general $\zeta \in \mathbb{C}$).

Remark 6.23. Recall that $\text{Wg}_{-N}^{\text{O}}(\pi, \pi')$ is a function of the face profile $\ell(\pi, \pi')$. Lemma 6.21 shows that $\text{Wg}_N^{\text{Sp}}(\pi, \pi')$ is *not* a function of the face profile $\ell(\pi, \pi')$, because $\text{sgn}(\sigma_\pi) \text{sgn}(\sigma_{\pi'})$ is not determined by $\ell(\pi, \pi')$. For a simple example, see Figure 52. Thus to obtain weighted sums over surfaces in the Symplectic case, we will use Lemma 6.21 to replace Wg_N^{Sp} by $\text{Wg}_{-N}^{\text{O}}$, which will allow us to express our weights purely in terms of the surfaces. We note that this was also done in [MP22] – see Theorem 1.2 and Appendix A of the paper.

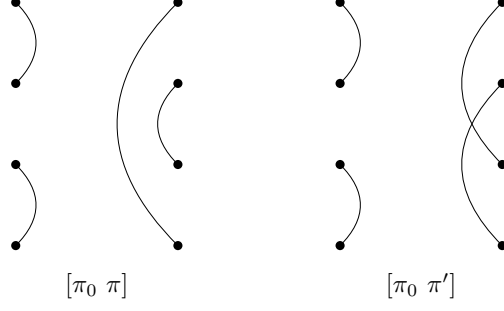

Figure 52: Left: $[\pi_0 \pi]$ with $\pi = \{\{1, 4\}, \{2, 3\}\}$. Thus $\sigma_\pi = (1\ 4\ 2\ 3)$, and so $\text{sgn}(\sigma_\pi) = 1$. Right: $[\pi_0 \pi']$ with $\pi' = \{\{1, 3\}, \{2, 4\}\}$. Thus $\sigma_{\pi'} = (1\ 3\ 2\ 4)$, and so $\text{sgn}(\sigma_{\pi'}) = -1$. Consequently, we see that $\text{Wg}_N^{\text{Sp}}(\pi_0, \pi) = (-1)^2 \text{sgn}(\sigma_{\pi_0}) \text{sgn}(\sigma_{\pi'}) \text{Wg}_{-N}^{\text{O}}(\pi_0, \pi') = \text{Wg}_{-N}^{\text{O}}(\pi_0, \pi')$, whereas $\text{Wg}_N^{\text{Sp}}(\pi_0, \pi') = -\text{Wg}_{-N}^{\text{O}}(\pi_0, \pi')$. Note that the face profiles $\ell(\pi_0, \pi) = \ell(\pi_0, \pi') = \{4\}$, and so $\text{Wg}_{-N}^{\text{O}}(\pi_0, \pi) = \text{Wg}_{-N}^{\text{O}}(\pi_0, \pi')$. This shows that $\text{Wg}_N^{\text{Sp}}(\pi_0, \pi) = -\text{Wg}_N^{\text{Sp}}(\pi_0, \pi')$, even though (π_0, π) has the same face profile as (π_0, π') .

Recall the matrix $J = \begin{pmatrix} 0 & I_{N/2} \\ -I_{N/2} & 0 \end{pmatrix}$ from the definition of $\text{Sp}(N/2)$.

Definition 6.24. For indices $i_1, i_2 \in [N]$, define $\langle i_1, i_2 \rangle_J := J_{i_1 i_2}$. For $n \geq 1$ even and a permutation $\sigma \in S_n$, define

$$\Delta'_\sigma(\mathbf{i}) := \prod_{k=1}^{n/2} \langle i_{\sigma(2k-1)}, i_{\sigma(2k)} \rangle_J = \langle i_{\sigma(1)}, i_{\sigma(2)} \rangle_J \cdots \langle i_{\sigma(n-1)}, i_{\sigma(n)} \rangle_J, \quad \mathbf{i} = (i_1, \dots, i_n) \in [N]^n.$$

For a matching $\pi : [n] \rightarrow [n]$, we abuse notation and write Δ'_π for Δ'_{σ_π} .

We next state the matrix-entry version of the Symplectic Weingarten calculus. This is essentially [Mat13, Theorem 2.4] (see also [Mat13, Lemma 2.5]).

Proposition 6.25 (Symplectic Weingarten calculus). Let $G = \text{Sp}(N/2)$. Let $n \geq 1$ be even. For any $\mathbf{i} = (i_1, \dots, i_n), \mathbf{j} = (j_1, \dots, j_n) \in [N]^n$, we have that

$$\mathbb{E}[G_{i_1 j_1} \cdots G_{i_n j_n}] = \sum_{\pi, \pi' : [n] \rightarrow [n]} \Delta'_\pi(\mathbf{i}) \Delta'_{\pi'}(\mathbf{j}) \text{Wg}_N^{\text{Sp}}(\pi, \pi').$$

By applying Proposition 6.25 and Lemma 6.21, one can obtain the following word-expectation version of the Symplectic Weingarten calculus. We remark that going from the matrix-entry version to the word-expectation version of Weingarten calculus is not as simple as in the Unitary or Orthogonal cases (where one may use the argument described in Section 4.2), and one has to carefully handle signs. The proof is omitted – see [MP22, Appendix A] for the relevant details.

Proposition 6.26. Let $G = \text{Sp}(N/2)$. Let $\Gamma = (\Gamma_1, \dots, \Gamma_k)$ be an unoriented-balanced collection of words on $\{\lambda_1, \dots, \lambda_L\}$. We have that

$$\mathbb{E}[\text{Tr}(G(\Gamma))] = (-1)^k \sum_{\pi = ([\pi_\ell, \pi'_\ell], \ell \in [L])} \prod_{\ell \in [L]} \text{Wg}_{-N}^{\text{O}}(\pi_\ell, \pi'_\ell) (-N)^{\#\text{comp}(\Gamma, \pi)}.$$

Consequently, we have that

$$\mathbb{E}[\mathrm{Tr}(G(\Gamma))] = (-1)^k \sum_{\mathcal{M} \in \mathrm{DBM}_{OS}(\Gamma)} \left(\prod_{\ell \in [L]} \overline{\mathrm{Wg}}_{-N}^{\mathrm{O}}(\mu_{\ell}(\mathcal{M})) \right) (-N)^{\chi(M)-k}.$$

Remark 6.27. To obtain the second claim in Proposition 6.26, it was crucial that we used the Orthogonal Weingarten function rather than the Symplectic Weingarten function, since the former is a function of the face profile but the latter is not (recall Remark 6.23). In other words, $\mathrm{Wg}_N^{\mathrm{Sp}}$ is not a function of $\mu_{\ell}(\mathcal{M})$, so we could not have replaced $\mathrm{Wg}_N^{\mathrm{Sp}}(\pi_{\ell}, \pi_{\ell'})$ with $\mathrm{Wg}_N^{\mathrm{Sp}}(\mu_{\ell}(\mathcal{M}))$.

We can now give a representation of Wilson loop expectations in $\mathrm{Sp}(N/2)$ lattice gauge theories as Weingarten-weighted surface sums.

Theorem 6.28. *Let $s = (\ell_1, \dots, \ell_n)$ be a string. For $\mathrm{Sp}(N/2)$ lattice gauge theory, we have that*

$$\langle W_s \rangle_{\Lambda, \beta} = (-1)^n Z_{\Lambda, \beta}^{-1} \sum_{(\mathcal{M}, \psi) \in \mathrm{EPE}_{OS}(s)} \frac{\beta^{\mathrm{area}(\mathcal{M}, \psi)}}{(\psi^{-1})!} \left(\prod_{e \in E_{\Lambda}} \overline{\mathrm{Wg}}_{-N}^{\mathrm{O}}(\mu_e(\psi)) \right) (-N)^{\chi(M)-2n}.$$

6.1.3 Exploration process

In this subsection, we detail how to obtain the Orthogonal and Symplectic Weingarten calculus from taking limits of Brownian motion, much as we did in Section 4 for the Unitary case. The key is to use a variant of the exploration process we defined in Section 4.1. This will again allow us to extract the Jucys-Murphy elements, which as before will relate to the Weingarten function. First, we work towards describing the analog of Proposition 4.14 for $\mathrm{O}(N)$, $\mathrm{Sp}(N/2)$.

Remark 6.29. Note that $\mathrm{SO}(N)$ is connected while $\mathrm{O}(N)$ is not. Thus an $\mathrm{O}(N)$ Brownian motion started at the identity (or more generally, any element of $\mathrm{SO}(N)$) is exactly the same as an $\mathrm{SO}(N)$ Brownian motion. Thus to reprove the Orthogonal Weingarten calculus, we will need to take the initial value O_0 of the $\mathrm{O}(N)$ Brownian motion to lie in the two connected components of $\mathrm{O}(N)$ with equal probability. This amounts to multiplying an $\mathrm{SO}(N)$ Brownian motion started at the identity by O_0 .

Notation 6.30. In the following, to discuss the cases $G = \mathrm{O}(N)$, $\mathrm{Sp}(N/2)$ simultaneously, we set the notation $\varepsilon = 1$ when $G = \mathrm{O}(N)$ and $\varepsilon = -1$ when $G = \mathrm{Sp}(N/2)$. We found this useful notation from [Dah17].

Next, we define a representation $\rho_- : \mathcal{B}_n(-N) \rightarrow \mathrm{End}((\mathbb{C}^N)^{\otimes n})$ which is needed to relate expectations of Symplectic Brownian motion to weighted sums over Brauer algebra elements. Recall the definition of $\langle \cdot, \cdot \rangle_J$ and Δ'_π from Definition 6.24.

Definition 6.31. Define the representation $\rho_- : \mathcal{B}_n(-N) \rightarrow \mathrm{End}((\mathbb{C}^N)^{\otimes n})$ as follows. It suffices to define ρ_- on the generating set $\{(i j), \langle i j \rangle, 1 \leq i < j < n\}$ of \mathcal{B}_n . We let $\rho_-((i j)) := -\rho_+((i j))$. We let $\rho_-((\langle i j \rangle))$ be the matrix whose (\mathbf{k}, \mathbf{l}) (with $\mathbf{k} = (k_1, \dots, k_n)$, $\mathbf{l} = (l_1, \dots, l_n) \in [N]^n$) matrix entry is

$$(\rho_-((\langle i j \rangle)))_{\mathbf{k}\mathbf{l}} := -\langle k_i, k_j \rangle_J \langle l_i, l_j \rangle_J \prod_{r \neq i, j} \delta_{k_r l_r}.$$

Remark 6.32. The minus sign in the definition of ρ_- is crucial, since ρ_- is supposed to be a representation of $\mathcal{B}_n(-N)$, which implies that $\rho_-(\langle i j \rangle)^2 = (-N)\rho_-(\langle i j \rangle)$ (since $\langle i j \rangle^2 = (-N)\langle i j \rangle$). The minus sign ensures that this is the case.

Remark 6.33. For a matching $\pi : [n] \rightarrow [n]$, observe that

$$[\pi \pi] = \langle \pi(1) \pi(2) \rangle \cdots \langle \pi(2n-1) \pi(2n) \rangle.$$

This implies that

$$\rho_-([\pi \pi])_{\mathbf{i}, \mathbf{j}} = (-1)^{n/2} \Delta'_\pi(\mathbf{i}) \Delta'_\pi(\mathbf{j}).$$

More generally, we have that

$$\rho_-([\pi \pi'])_{\mathbf{i}, \mathbf{j}} = (-1)^{n/2} \text{sgn}(\sigma_\pi) \text{sgn}(\sigma_{\pi'}) \Delta'_\pi(\mathbf{i}) \Delta'_{\pi'}(\mathbf{j}). \quad (6.2)$$

Notation 6.34. We will take ρ_1 to mean ρ_+ and ρ_{-1} to mean ρ_- . This way we can write ρ_ε .

Let $n \geq 1$. Consider a strand diagram with n total strands. We define a Poisson point process Σ_{OS} on the strand diagram as follows. We imagine we have n right-directed strands homeomorphic to $[0, \infty)$. Between any pair of strands, there are two independent rate-1 Poisson processes: one which gives the swaps between the two strands, and one which gives the turnarounds between the two strands. The Poisson processes corresponding to different pairs of strands are also independent. Let $\Sigma_{\text{OS}}(T)$ be process obtained by keeping only those points of Σ_{OS} which occur before time T . See Figure 53 for an example realization of $\Sigma_{\text{OS}}(T)$.

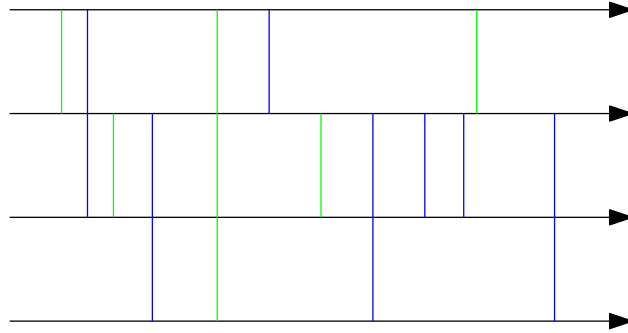

Figure 53: An example realization of $\Sigma_{\text{OS}}(T)$ for some finite T . The green lines represent swaps and blue lines represent turnarounds.

Remark 6.35 (Comparison with the Unitary case). In the Orthogonal and Symplectic cases, all strands point the same direction, and there may be turnarounds between same-direction strands. Whereas in the Unitary case, there were only swaps between same-direction strands, and turnarounds between opposite-direction strands.

Definition 6.36. Define $F_\pm = F_{\pm 1}$ as follows. Set $F_+ := F_1 := F$ (where F is as defined in Definition 4.3). Define F_- to be a map which takes point process realizations to elements of $\mathcal{B}_n(-N)$ as follows. Define F_- almost exactly as F , except same-direction swaps incur a $\frac{1}{N}$ factor and turnarounds incur a $-\frac{1}{N}$ factor (note that this is the reverse of how F was defined).

The following proposition is the analog of Proposition 4.14. It says that for $G = \text{SO}(N), \text{Sp}(N/2)$, expectations of G -valued Brownian motion may be expressed in terms of the Poisson point process Σ_{OS} . See [PPSY23, Appendix A] for the proof.

Proposition 6.37. Let $n \geq 1$. Let $G = \text{SO}(N), \text{Sp}(N/2)$. Let B_T be a G -valued Brownian motion at time T . We have that

$$\mathbb{E}[B_T^{\otimes n}] = e^{2\binom{n}{2}T - \frac{n}{2}(1 - \frac{\varepsilon}{N})} \rho_\varepsilon(\mathbb{E}[F_\varepsilon(\Sigma_{\text{OS}}(T))]).$$

Equivalently, for $\mathbf{i} = (i_1, \dots, i_n), \mathbf{j} = (j_1, \dots, j_n) \in [N]^n$, we have that

$$\mathbb{E}[(B_T)_{i_1 j_1} \cdots (B_T)_{i_n j_n}] = e^{2\binom{n}{2}T - \frac{n}{2}(1 - \frac{\varepsilon}{N})} \rho_\varepsilon(\mathbb{E}[F_\varepsilon(\Sigma_{\text{OS}}(T))])_{\mathbf{ij}}.$$

Next, we state the following lemma which relates the Orthogonal Weingarten function to Jucys-Murphy elements. This may essentially be found in [Mat13], however it may not be so clear why this is the case without actually reading the paper. Thus, for the reader's convenience, we provide some discussion in Appendix A of why the following lemma follows from the results of [Mat13].

Lemma 6.38 (Relation of Weingarten function to Jucys-Murphy elements). Let $\pi : [n] \rightarrow [n]$ be a matching. We have that

$$\rho_\varepsilon([\pi \ \pi_0]) \rho_\varepsilon((\varepsilon N + J_{n-1})(\varepsilon N + J_{n-3}) \cdots (\varepsilon N + J_1))^{-1} = \sum_{\pi': [n] \rightarrow [n]} \text{Wg}_{\varepsilon N}^{\text{O}}(\pi_0, \pi') \rho_\varepsilon([\pi \ \pi']).$$

As in the Unitary case, the main theorem that we will prove using our exploration process is the recovery of the Weingarten calculus, stated as follows.

Theorem 6.39 (Weingarten recovery). Let $n \geq 1$ be even. Let $O_0 \in \text{O}(N)$ be a random matrix which has equal probability of being in the two connected components of $\text{O}(N)$, or equivalently $\mathbb{E}[\det(O_0)] = 0$. For $G = \text{O}(N)$, we have that

$$\lim_{T \rightarrow \infty} \mathbb{E}[B_T^{\otimes n}] \mathbb{E}[O_0^{\otimes n}] = \sum_{\pi, \pi': [n] \rightarrow [n]} \text{Wg}_N^{\text{O}}(\pi, \pi') \rho_+([\pi \ \pi']).$$

For $G = \text{Sp}(N/2)$, we have that

$$\lim_{T \rightarrow \infty} \mathbb{E}[B_T^{\otimes n}] = \sum_{\pi, \pi': [n] \rightarrow [n]} \text{Wg}_{-N}^{\text{O}}(\pi, \pi') \rho_-([\pi \ \pi']). \quad (6.3)$$

Remark 6.40. To see why equation (6.3) is equivalent to the matrix-entry version of the Symplectic Weingarten calculus (Proposition 6.25), recall by Remark 6.33 that

$$(\rho_-([\pi \ \pi']))_{\mathbf{ij}} = (-1)^{n/2} \text{sgn}(\sigma_\pi) \text{sgn}(\sigma_{\pi'}) \Delta'_\pi(\mathbf{i}) \Delta'_{\pi'}(\mathbf{j}).$$

Then by the relation between the Orthogonal and Symplectic Weingarten functions (Lemma 6.21), it follows that

$$\begin{aligned} \text{Wg}_{-N}^{\text{O}}(\pi, \pi') (\rho_-([\pi \ \pi']))_{\mathbf{ij}} &= ((-1)^{n/2} \text{sgn}(\sigma_\pi) \text{sgn}(\sigma_{\pi'}) \text{Wg}_{-N}^{\text{O}}(\pi, \pi')) \Delta'_\pi(\mathbf{i}) \Delta'_{\pi'}(\mathbf{j}) \\ &= \text{Wg}_N^{\text{Sp}}(\pi, \pi') \Delta'_\pi(\mathbf{i}) \Delta'_{\pi'}(\mathbf{j}). \end{aligned}$$

Next, we define the analog $\mathcal{Q}_T^{\text{OS}}$ of the strand-by-strand exploration process \mathcal{Q}_T from Section 4.1. As before, the exploration is encoded by two processes $(E_t)_{t \geq 0}$, $(\pi_t)_{t \geq 0}$. Here, E takes values in $[n/2]$ and tracks the current exploration era, and π takes values in S_n . In words, the exploration starts at the top strand, and follows swaps until the first turnaround. At this time, the exploration proceeds to the next-highest strand which hasn't been matched. The exploration continues until all strands have been matched (i.e. until the end of the $n/2$ th exploration era).

Notation 6.41. For notational brevity in what follows, define

$$h_n(t_1, \dots, t_{n/2}) := e^{(2(n-1)-(1-\frac{\varepsilon}{N}))t_1} e^{(2(n-3)-(1-\frac{\varepsilon}{N}))(t_2-t_1)} \dots e^{(2(1)-(1-\frac{\varepsilon}{N}))(t_{n/2}-t_{n/2-1})}$$

The following is the analog of Proposition 4.5 which recall encoded the key cancellation property of our strand-by-strand exploration process.

Proposition 6.42. Let $n \geq 1$ be even. Let $G = \text{SO}(N), \text{Sp}(N/2)$. We have that

$$e^{2\binom{n}{2}T - \frac{n}{2}(1-\frac{\varepsilon}{N})T} \mathbb{E}[F_\varepsilon(\Sigma_{\text{OS}}(T)) \mathbb{1}(T_{n/2} \leq T)] = \mathbb{E}[F_\varepsilon(\mathcal{Q}_{T_{n/2}}^{\text{OS}}) \mathbb{1}(T_{n/2} \leq T) h_n(T_1, \dots, T_{n/2})].$$

Proof. The proof is very similar to the proof of Proposition 4.5, in that we proceed by induction, except now the combinatorics is slightly different. Throughout, we write Σ and \mathcal{Q} instead of Σ_{OS} and \mathcal{Q}^{OS} for brevity.

The base case $n = 2$ may be handled by direct calculation, which we omit. Suppose that the proposition is true for $n - 2 \geq 2$ and any $T \geq 0$. As before, we condition on the time T_1 , which is the time of first turnaround, which results in two strands being matched. After this time, we may assume that any swaps or turnarounds involving either of the matched strands must involve precisely the two matched strands (by essentially the same argument as in the proof of the cancellation lemma, Lemma 4.4). Each strand is involved in $2(n - 1)$ independent Poisson processes, and thus the number of independent Poisson processes which must have zero points on the interval $[T_1, T]$ is $2(2(n - 1)) - 4 = 4n - 8$. The Poisson process which gives the turnarounds between the two matched strands contributes a factor 1, and the Poisson process which gives the swaps between the two matched strands contributes a factor $e^{-(T-T_1)} e^{-\varepsilon(T-T_1)/N}$ (when we condition on T_1). We thus obtain

$$\begin{aligned} \mathbb{E}[F_\varepsilon(\Sigma(T)) \mathbb{1}(T_n \leq T) \mid \mathcal{F}_{T_1}] &= \\ \mathbb{E}[F_\varepsilon(\Sigma(T_1)) \mid \mathcal{F}_{T_1}] \mathbb{E}[F_\varepsilon(\Sigma(T)/\Sigma(T_1)) \mathbb{1}(T_n \leq T) \mid \mathcal{F}_{T_1}] &e^{-(4n-8)(T-T_1)} e^{-(T-T_1)} e^{-\varepsilon(T-T_1)/N}. \end{aligned}$$

Now observe that

$$\begin{aligned} 2\binom{n}{2} - \frac{n}{2}\left(1 - \frac{\varepsilon}{N}\right) - (4n - 7) - \frac{\varepsilon}{N} &= n^2 - 5n + 6 - \frac{n}{2}\left(1 - \frac{\varepsilon}{N}\right) + 1 - \frac{\varepsilon}{N} \\ &= 2\binom{n-2}{2} - \frac{n-2}{2}\left(1 - \frac{\varepsilon}{N}\right). \end{aligned}$$

From this, we obtain

$$e^{2\binom{n}{2}T - \frac{n}{2}(1-\frac{\varepsilon}{N})T} \mathbb{E}[F_\varepsilon(\Sigma(T)) \mathbb{1}(T_{n/2} \leq T) \mid \mathcal{F}_{T_1}] = \left(e^{2\binom{n}{2}T_1 - \frac{n}{2}(1-\frac{\varepsilon}{N})T_1} \mathbb{E}[F_\varepsilon(\Sigma(T_1)) \mid \mathcal{F}_{T_1}] \right) \times$$

$$\left(e^{2\binom{n-2}{2}(T-T_1) - \frac{n-2}{2}(1-\frac{\varepsilon}{N})(T-T_1)} \mathbb{E}[F_\varepsilon(\Sigma(T) \setminus \Sigma(T_1)) \mathbb{1}(T_{n/2} \leq T) \mid \mathcal{F}_{T_1}] \right).$$

At this point, we recognize that the second factor is exactly given by the inductive assumption:

$$e^{2\binom{n-2}{2}(T-T_1) - \frac{n-2}{2}(1-\frac{\varepsilon}{N})(T-T_1)} \mathbb{E}[F_\varepsilon(\Sigma(T) \setminus \Sigma(T_1)) \mathbb{1}_{A_T} \mathbb{1}(T_{n/2} \leq T) \mid \mathcal{F}_{T_1}] = \\ \mathbb{E}[F_\varepsilon(\mathcal{Q}_{T_{n/2}} \setminus \mathcal{Q}_{T_1}) \mathbb{1}(T_{n/2} \leq T) h_{n-2}(T_2, \dots, T_{n/2}) \mid \mathcal{F}_{T_1}]$$

Thus, to finish the induction, we just need to show that

$$e^{2\binom{n}{2}T_1 - \frac{n}{2}(1-\frac{\varepsilon}{N})T_1} \mathbb{E}[F_\varepsilon(\Sigma(T_1)) F(\mathcal{Q}_{T_{n/2}} \setminus \mathcal{Q}_{T_1}) \mid \mathcal{F}_{T_{n/2}}] = e^{(2(n-1) - (1-\frac{\varepsilon}{N}))T_1} F_\varepsilon(\mathcal{Q}_{T_1}) F_\varepsilon(\mathcal{Q}_{T_{n/2}} \setminus \mathcal{Q}_{T_1}).$$

Again, this follows by accounting for the contributions before time T_1 of all the swaps and turnarounds not involving the top strand. There are a total of $2\binom{n-1}{2}$ such processes. Out of these, there are $\frac{n-2}{2}$ processes which contribute 1 (the turnarounds between two strands which are matched on the right), there are $\frac{n-2}{2}$ processes which contribute $e^{-T_1} e^{-\varepsilon T_1/N}$ (the swaps between two strands which are matched on the right), and every other process must have zero points on $[0, T_1]$, and thus contributes e^{-T_1} . In total, we get

$$\mathbb{E}[F_\varepsilon(\Sigma(T_1)) F_\varepsilon(\mathcal{Q}_{T_{n/2}} \setminus \mathcal{Q}_{T_1}) \mid \mathcal{F}_{T_{n/2}}] = e^{-(2\binom{n-1}{2} - (n-2))T_1} e^{-\frac{n-2}{2}T_1} e^{-\varepsilon \frac{n-2}{2}T_1/N} F_\varepsilon(\mathcal{Q}_{T_1}) F_\varepsilon(\mathcal{Q}_{T_{n/2}} \setminus \mathcal{Q}_{T_1}).$$

To finish, note that (using that $2\binom{n}{2} - 2\binom{n-1}{2} = 2(n-1)$)

$$2\binom{n}{2} - \frac{n}{2}\left(1 - \frac{\varepsilon}{N}\right) - \left(2\binom{n-1}{2} - (n-2)\right) - \frac{n-2}{2} - \frac{n-2}{2} \frac{\varepsilon}{N} = 2(n-1) - \left(1 - \frac{\varepsilon}{N}\right). \quad \square$$

Next, we give an explicit expression for the right hand side of Proposition 6.42. First, let E_{π_0} be the event that in the exploration process, n gets matched to $n-1$, $n-2$ gets matched to $n-3$, \dots , 2 gets matched to 1. In other words, E_{π_0} is the event that the left matching discovered by our exploration is π_0 (which was defined in Definition 6.11, see also Figure 48).

For notational brevity, we make the following definition.

Notation 6.43. Define

$$I(T, n) := \int_0^T du_1 \int_0^{T-u_1} du_2 \cdots \int_0^{T-(u_1+\dots+u_{n/2-1})} du_{n/2} (e^{-u_1} e^{-\varepsilon u_1 J_{n-1}/N}) \times (e^{-u_2} e^{-\varepsilon u_2 J_{n-3}/N}) \\ \times \cdots \times (e^{-u_{n/2}} e^{-\varepsilon u_{n/2} J_1/N}).$$

We will need the following lemma.

Lemma 6.44. We have that

$$[\pi_0 \pi_0] J_n = [\pi_0 \pi_0] (1 + J_{n-1}).$$

Proof. In the case $n = 4$, Figure 54 contains the proof by explicitly identifying the terms which appear on the left and right hand sides of the claimed identity. The proof when $n \geq 6$ is essentially same as the case $n = 4$. The case $n = 2$ is trivial. \square

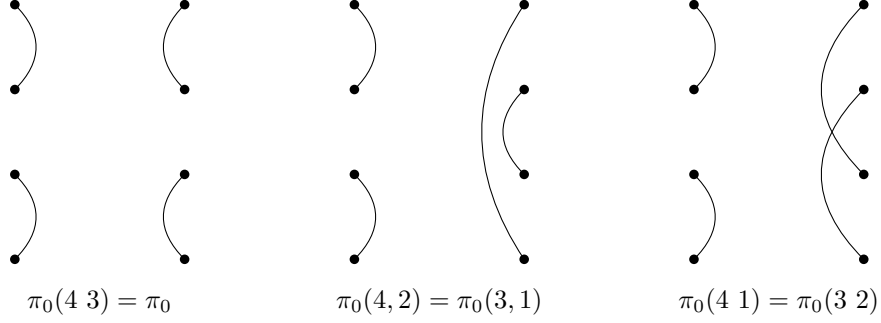

Figure 54: Term-by-term identification of the three terms in each of $\pi_0 J_4$ and $\pi_0(1 + J_3)$.

Lemma 6.45. We have that

$$\mathbb{E}[F_\varepsilon(\mathcal{Q}_{T_{n/2}}^{\text{OS}})\mathbb{1}(T_{n/2} \leq T)h_n(T_1, \dots, T_{n/2})\mathbb{1}_{E_{\pi_0}}] = (\varepsilon N)^{-n/2}[\pi_0 \pi_0]I(T, n).$$

Proof. By considering an alternative exploration as in Section 4.1, we may explicitly compute

$$\mathbb{E}[F_\varepsilon(\mathcal{Q}_{T_{n/2}}^{\text{OS}})\mathbb{1}(T_{n/2} \leq T)h_n(T_1, \dots, T_{n/2})\mathbb{1}_{E_{\pi_0}}] = (\varepsilon N)^{-n/2}[\pi_0 \pi_0]I',$$

where

$$I' = \int_0^T du_1 \int_0^{T-u_1} du_2 \cdots \int_0^{T-(u_1+\dots+u_{n/2-1})} du_{n/2} (e^{-2(n-1)u} e^{-\varepsilon u_1 J_n/N}) \times \\ (e^{-2(n-3)u_2} e^{-\varepsilon u_2 J_{n-2}/N}) \times \dots \times (e^{-2u_{n/2}} e^{-\varepsilon u_{n/2} J_2/N}) h_n(u_1, \dots, u_{n/2}).$$

We explain how $e^{-2(n-1)u} e^{-\varepsilon u_1 J_n/N}$ arises. One factor of $e^{-(n-1)u}$ comes from the density of T_1 , which is an exponential random variable with rate $n-1$. Conditioned on $T_1 = u_1$, we need to average over all swaps involving the top strand before time u , which contributes $e^{-(n-1)u} e^{-u_1 \varepsilon J_n/N}$.

Next, observe that the formula for I' may be simplified to

$$I' = \int_0^T du_1 \int_0^{T-u_1} du_2 \cdots \int_0^{T-(u_1+\dots+u_{n/2-1})} du_{n/2} (e^{-(1-\frac{\varepsilon}{N})u_1} e^{-\varepsilon u_1 J_n/N}) \times \\ (e^{-(1-\frac{\varepsilon}{N})u_2} e^{-\varepsilon u_2 J_{n-2}/N}) \cdots \times (e^{-(1-\frac{\varepsilon}{N})u_{n/2}} e^{-\varepsilon u_{n/2} J_2/N}).$$

Next, by Lemma 6.44 we have that $[\pi_0 \pi_0]J_n = [\pi_0 \pi_0](1 + J_{n-1})$. Since the Jucys-Murphy elements commute, we may then obtain that

$$[\pi_0 \pi_0]J_n^k = [\pi_0 \pi_0](1 + J_{n-1})^k \text{ for all } k \geq 0.$$

This implies that $[\pi_0 \pi_0]e^{uJ_n} = e^u[\pi_0 \pi_0]e^{uJ_{n-1}}$ for any $u \in \mathbb{R}$. More generally, by the same argument as in the proof of Lemma 6.44, we may obtain that $[\pi_0 \pi_0]e^{uJ_{2r}} = e^u[\pi_0 \pi_0]e^{uJ_{2r-1}}$ for $1 \leq r \leq n/2$. By applying these identities, we obtain $[\pi_0 \pi_0]I' = [\pi_0 \pi_0]I(T, n)$, and the desired result follows. \square

Now suppose that the left matching discovered by our strand-by-strand exploration is some arbitrary π . Then we may first permute the strands so that π becomes π_0 , apply

Lemma 6.45 to compute the expectation of our strand-by-strand-exploration in the case where the left matching is π_0 , and then permute the strands back. This gives a formula for the expectation of our strand-by-strand exploration in the case where the left matching is π , which then leads to the following lemma. Recall from Definition 6.12 that for each matching $\pi : [n] \rightarrow [n]$, we fixed a permutation $\sigma_\pi \in S_n$ such that $\sigma_\pi[\pi \ \pi]\sigma_\pi^{-1} = [\pi_0 \ \pi_0]$.

Lemma 6.46. We have that

$$\mathbb{E}[F_\varepsilon(\mathcal{Q}_{T_{n/2}}^{\text{OS}})\mathbb{1}(T_{n/2} \leq T)h_n(T_1, \dots, T_{n/2})] = (\varepsilon N)^{-n/2} \sum_{\pi: [n] \rightarrow [n]} [\pi \ \pi_0]I(T, n)\sigma_\pi.$$

Proof. By summing over all possible left machings π , we obtain

$$\mathbb{E}[F_\varepsilon(\mathcal{Q}_{T_{n/2}}^{\text{OS}})\mathbb{1}(T_{n/2} \leq T)h_n(T_1, \dots, T_{n/2})] = (\varepsilon N)^{-n/2} \sum_{\pi: [n] \rightarrow [n]} [\pi \ \pi]I(T, n, \pi),$$

where $I(T, n, \pi)$ is the analog of $I(T, n)$ defined for a general π . Writing $[\pi \ \pi] = \sigma_\pi^{-1}[\pi_0 \ \pi_0]\sigma_\pi$, we may write

$$[\pi \ \pi]I(T, n, \pi) = \sigma_\pi^{-1}[\pi_0 \ \pi_0](\sigma_\pi I(T, n, \pi)\sigma_\pi^{-1})\sigma_\pi.$$

Since conjugating by σ_π corresponds to permuting the strands according to σ_π , we have that $\sigma_\pi I(T, n, \pi)\sigma_\pi^{-1} = I(T, n)$. I.e., after permuting the strands according to σ_π , $I(T, n, \pi)$ gets taken to $I(T, n)$. To finish, note that $\sigma_\pi^{-1}[\pi_0 \ \pi_0] = [\pi \ \pi_0]$ (since if we only permute the labels on the left, then only the left matching gets changed). \square

Lemma 6.47. We have that

$$\lim_{T \rightarrow \infty} \rho_\varepsilon(I(T, n)) = \varepsilon^{n/2} N^{n/2} \rho_\varepsilon((\varepsilon N + J_{n-1})(\varepsilon N + J_{n-3}) \cdots (\varepsilon N + J_1))^{-1}.$$

Proof. We have that

$$\begin{aligned} \lim_{T \rightarrow \infty} \rho_\varepsilon(I(T, n)) &= \int_0^\infty du_1 e^{-u_1} e^{-\varepsilon u_1 \rho_\varepsilon(J_{n-1})/N} \cdots \int_0^\infty du_{n/2} e^{-u_{n/2}} e^{-\varepsilon u_{n/2} \rho_\varepsilon(J_1)/N} \\ &= \rho_\varepsilon\left(\text{id} + \varepsilon \frac{J_{n-1}}{N}\right)^{-1} \rho_\varepsilon\left(\text{id} + \varepsilon \frac{J_{n-3}}{N}\right)^{-1} \cdots \rho_\varepsilon\left(\text{id} + \varepsilon \frac{J_1}{N}\right)^{-1} \\ &= \varepsilon^{n/2} N^{n/2} \rho_\varepsilon(\varepsilon N + J_{n-1})^{-1} \rho_\varepsilon(\varepsilon N + J_{n-3})^{-1} \cdots \rho_\varepsilon(\varepsilon N + J_1)^{-1}. \end{aligned}$$

Here, the operators $\rho_\varepsilon(\text{id} + \varepsilon J_{n-2k}/N)$, $1 \leq k < n/2$, have strictly positive eigenvalues (and thus are invertible) by Lemma 2.28 (recall that $\rho_-((i \ j)) = -\rho((i \ j))$ for any transposition $(i \ j)$). \square

Lemma 6.48. For any matching $\pi : [n] \rightarrow [n]$, we have that

$$\rho_\varepsilon([\pi \ \pi_0])\rho_\varepsilon((\varepsilon N + J_{n-1})(\varepsilon N + J_{n-3}) \cdots (\varepsilon N + J_1))^{-1} \rho_\varepsilon(\sigma_\pi) = \sum_{\pi': [n] \rightarrow [n]} \text{Wg}_{\varepsilon N}^{\text{O}}(\pi, \pi') \rho_\varepsilon([\pi \ \pi']).$$

Proof. Applying Lemma 6.38, we have that

$$\rho_\varepsilon([\pi \ \pi_0])\rho_\varepsilon((\varepsilon N + J_{n-1})(\varepsilon N + J_{n-3}) \cdots (\varepsilon N + J_1))^{-1}\rho_\varepsilon(\sigma_\pi) = \sum_{\pi':[n] \rightarrow [n]} \text{Wg}_{\varepsilon N}^{\text{O}}(\pi_0, \pi')\rho_\varepsilon([\pi \ \pi']\sigma_\pi).$$

Since $[\pi \ \pi] = \sigma_\pi^{-1}[\pi_0 \ \pi_0]\sigma_\pi$, we have that $[\pi \ \pi']\sigma_\pi = \sigma_\pi^{-1}[\pi_0 \ \pi']\sigma_\pi$. Changing variables $\pi' = \pi'\sigma_\pi$, we obtain that the above is further equal to

$$\sum_{\pi':[n] \rightarrow [n]} \text{Wg}_{\varepsilon N}^{\text{O}}(\pi_0, \pi'\sigma_\pi^{-1})\rho_\varepsilon([\pi \ \pi']).$$

To finish, observe that $\text{Wg}_{\varepsilon N}^{\text{O}}(\pi_0, \pi'\sigma_\pi^{-1}) = \text{Wg}_{\varepsilon N}^{\text{O}}(\sigma_\pi^{-1}\pi_0, \pi') = \text{Wg}_{\varepsilon N}^{\text{O}}(\pi, \pi')$. The first identity follows since $\sigma_\pi^{-1}[\pi_0 \ \pi'\sigma_\pi^{-1}]\sigma_\pi = [\sigma_\pi^{-1}\pi_0 \ \pi']$, which implies that $(\pi_0, \pi'\sigma_\pi^{-1})$ has the same face profile as $(\sigma_\pi^{-1}\pi_0, \pi')$, and the second identity follows since $\sigma_\pi^{-1}\pi_0 = \pi$. \square

Combining Proposition 6.42 and Lemmas 6.46, 6.47, and 6.48, we obtain the following result.

Proposition 6.49. We have that

$$\lim_{T \rightarrow \infty} e^{2\binom{n}{2}T - \frac{n}{2}(1 - \frac{\varepsilon}{N})T} \rho_\varepsilon(\mathbb{E}[F_\varepsilon(\Sigma_{\text{OS}}(T))\mathbb{1}(T_{n/2} \leq T)]) = \sum_{\pi, \pi':[n] \rightarrow [n]} \text{Wg}_{\varepsilon N}^{\text{O}}(\pi, \pi')\rho_\varepsilon([\pi \ \pi']).$$

To complete the proof of Theorem 6.39, we need to show that it suffices to restrict to the event that all exploration eras have finished before time T . This turns out to be much harder to show for $\text{O}(N)$ than for $\text{Sp}(N/2)$ – see Remarks 6.53 and 6.55 for some discussion as to why. We begin by introducing some concepts which are needed to handle the $\text{O}(N)$ case.

Definition 6.50. Let $G = \text{O}(N)$. Define $P_n := \mathbb{E}[G^{\otimes n}] \in \text{End}((\mathbb{C}^N)^{\otimes n})$.

By properties of Haar integration, we have that P_n is symmetric and $P_n^2 = P_n$. Thus, P_n is the orthogonal projection onto its image, which is precisely the subspace of $\text{O}(N)$ -invariant vectors $\{v \in (\mathbb{C}^N)^{\otimes n} : O^{\otimes n}v = v\}$. Observe moreover that with O_0 as in Theorem 6.39, we have that

$$\lim_{T \rightarrow \infty} \mathbb{E}[B_T^{\otimes n}]\mathbb{E}[O_0^{\otimes n}] = \mathbb{E}[G^{\otimes n}] = P_n.$$

We thus have that

$$\lim_{T \rightarrow \infty} \mathbb{E}[B_T^{\otimes n}]\mathbb{E}[O_0^{\otimes n}]P_n = P_n^2 = P_n.$$

This discussion shows that when taking limits of $\text{SO}(N)$ Brownian motion to recover results about $\text{O}(N)$ Haar integration, we may first project to the space of invariant vectors, and this does not change the limit. This projection is a technical convenience that will make it easier to argue why the contribution from the case where not all eras end by time T goes to zero as $T \rightarrow \infty$.

With this discussion in mind, we state the following proposition.

Proposition 6.51. We have that

$$\begin{aligned} \lim_{T \rightarrow \infty} \left\| e^{2\binom{n}{2}T - \frac{n}{2}(1 - \frac{1}{N})T} \rho_+ \left(\mathbb{E}[F(\Sigma_{\text{OS}}(T)) \mathbb{1}(T_{n/2} > T)] \right) P_n \right\|_{op} &= 0, \quad G = \text{O}(N) \\ \lim_{T \rightarrow \infty} \left\| e^{2\binom{n}{2}T - \frac{n}{2}(1 + \frac{1}{N})T} \rho_- \left(\mathbb{E}[F_-(\Sigma_{\text{OS}}(T)) \mathbb{1}(T_{n/2} > T)] \right) \right\|_{op} &= 0, \quad G = \text{Sp}(N/2). \end{aligned}$$

We will prove this proposition by an inductive argument, which rests on the following technical lemmas. The proofs are deferred to Section 6.1.4.

Lemma 6.52. Let n be even. For any $u \geq 0$, we have that

$$\begin{aligned} \|e^{-u\rho(J_n)}\|_{op} &\leq e^{(N-1)u}, \\ \|e^{-u\rho(J_n)}P_n\|_{op} &\leq e^{(N-2)u}. \end{aligned}$$

Remark 6.53. The first estimate of Lemma 6.52 immediately follows from Lemma 2.28, which says that all eigenvalues of $\rho_+(J_n) = \rho(J_n)$ are at least $-N + 1$. However, this estimate is not good enough for the proof of Proposition 6.51 when $G = \text{O}(N)$. The point of the second estimate of Lemma 6.52 is that if we restrict to the subspace of $\text{O}(N)$ -invariant vectors (which is the effect of adding the P_n term), then we can in fact obtain a better estimate for $\|e^{-u\rho(J_n)}\|_{op}$.

Lemma 6.54. Let n be even. For any $T \geq 0$, we have that

$$\begin{aligned} \|(I \otimes \mathbb{E}[B_T^{\otimes(n-1)}])P_n\|_{op} &\lesssim_{N,n} T^{\frac{n}{2}-1} e^{-\frac{1}{2}(1 - \frac{1}{N})u}, \quad G = \text{O}(N), \\ \|I \otimes \mathbb{E}[B_T^{\otimes(n-1)}]\|_{op} &\lesssim_{N,n} T^{\frac{n}{2}-1} e^{-\frac{1}{2}(1 + \frac{1}{N})u}, \quad G = \text{Sp}(N/2). \end{aligned}$$

Remark 6.55. Another reason why $\text{O}(N)$ is more delicate than $\text{Sp}(N/2)$ may be seen in the statement of Lemma 6.54. For $\text{O}(N)$, we need to add in the additional projection P_n in order to obtain the stated estimate. Indeed, in certain cases $\lim_{T \rightarrow \infty} I \otimes \mathbb{E}[B_T^{\otimes(n-1)}]$ is not even zero – note that this limit is equal to $I \otimes \mathbb{E}[S^{\otimes(n-1)}]$, where S is a Haar-distributed $\text{SO}(N)$ random matrix. If N is odd and $n - 1 \geq N$ is also odd, then $\mathbb{E}[S^{\otimes(n-1)}]$ may be nonzero. The most direct example of this is when $n - 1 = N$, because if $\mathbb{E}[S^{\otimes N}]$ were equal to zero, then this would imply that any matrix entry has expectation zero:

$$(\mathbb{E}[S^{\otimes N}])_{\mathbf{j}} = \mathbb{E}[S_{i_1 j_1} \cdots S_{i_n j_n}] = 0, \quad \mathbf{i} = (i_1, \dots, i_N), \mathbf{j} = (j_1, \dots, j_N) \in [N]^N.$$

This would further imply that $\mathbb{E}[\det(S)] = 0$. On the other hand, $\det(S) = 1$ deterministically. Thus $\mathbb{E}[S^{\otimes N}] \neq 0$. Thus to prove Lemma 6.54, we will need to argue why we still have convergence to zero at an exponential rate, if we restrict to the subspace of $\text{O}(N)$ -invariant vectors.

On the other hand, since $-I \in \text{Sp}(N/2)$, we have by parity that $I \otimes \mathbb{E}[S^{\otimes(n-1)}] = 0$ if S is a Haar-distributed $\text{Sp}(N/2)$ random matrix (and n is even). It then isn't too hard to further prove that the convergence of $I \otimes \mathbb{E}[B_T^{\otimes(n-1)}]$ to zero happens at an exponential rate – one can argue similar to the Unitary case.

Lemma 6.56. Let n be even. We have that

$$\rho_+(\langle n \ n - 1 \rangle)P_n = I^{\otimes 2} \otimes P_{n-2}.$$

In the following, we will also use without explicit reference the fact that for any $O \in \mathcal{O}(N)$, $O^{\otimes n}$ commutes with any element of $\rho_+(\mathcal{B}_n)$. As a consequence, P_n also commutes with any element of $\rho_+(\mathcal{B}_n)$.

Proof of Proposition 6.51. First, assume $G = \mathcal{O}(N)$. We proceed by induction. First, in the base case $n = 2$, we may obtain by explicit calculation

$$e^{2T - (1 - \frac{1}{N})T} \rho_+ \left(\mathbb{E}[F(\Sigma_{\text{OS}}(T)) \mathbb{1}(T_1 > T)] \right) = e^{-(1 - \frac{1}{N})T} e^{-T\rho(J_2)/N}.$$

Now by Lemma 6.52, we have that $\|e^{-T\rho(J_2)/N} P_2\|_{op} \leq e^{(1 - \frac{2}{N})T}$. The desired result when $n = 2$ then follows by combining the two estimates.

Next, suppose the result is true for some even $n \geq 2$. Consider the case $n + 2$. We first show that there is no contribution when the first era doesn't end, that is

$$\lim_{T \rightarrow \infty} \left\| e^{2\binom{n+2}{2}T - \frac{n+2}{2}(1 - \frac{1}{N})T} \rho_+ \left(\mathbb{E}[F(\Sigma_{\text{OS}}(T)) \mathbb{1}(T_1 > T)] \right) P_{n+2} \right\|_{op} = 0. \quad (6.4)$$

Towards this end, consider a realization of $\Sigma_{\text{OS}}(T)$ on the event $T_1 > T$, as in the left of Figure 55. By imagining that every time we see a swap involving the current strand of exploration, we “cut and swap” the current strand and the other strand involved in the swap, we obtain a map on point configurations which preserves the law of $\Sigma_{\text{OS}}(T)$. After applying this map (see the right of Figure 55), we obtain another Poisson point process $\tilde{\Sigma}_{\text{OS}}(T)$, which has the property that all swaps which involve the first strand of exploration touch the top strand.

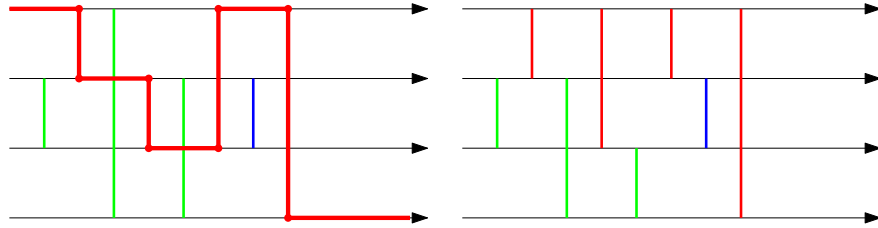

Figure 55: The green lines represent swaps, and the blue lines represent turnarounds. On the event $\{T_1 > T\}$, the exploration of the first strand makes it all the way to the right (see left). We may map the left point process into the right point process, which has the property that during the first exploration era, all swaps which are seen by the exploration involve the top strand.

To determine $F(\Sigma_{\text{OS}}(T))$ from $\tilde{\Sigma}_{\text{OS}}(T)$, we split $\tilde{\Sigma}_{\text{OS}}(T)$ into two parts: all points not involving the top strand, and all points involving the top strand – see Figure 56. Here, the points involving the top strand must be read in reverse order.

If we now multiply together the two matchings in Figure 56, we obtain the matching in Figure 57, which is precisely the same matching one obtains by following all the swaps/turnaround in the original points process $\Sigma_{\text{OS}}(T)$ (recall the left of Figure 55).

Let $\Sigma_{\text{OS}}^{\text{top}}(T)$ be the process obtained by keeping only those points of $\Sigma_{\text{OS}}(T)$ which involve the top strand. Let $\Sigma^{\text{rest}}(T)$ be the process made of all other points, i.e. $\Sigma^{\text{rest}}(T) = \Sigma_{\text{OS}}(T) / \Sigma_{\text{OS}}^{\text{top}}(T)$. The preceding discussion shows that

$$\mathbb{E}[F(\Sigma_{\text{OS}}(T)) \mathbb{1}(T_1 > T)] = e^{-(n+1)T} \mathbb{E}[F(\Sigma_{\text{OS}}^{\text{rest}}(T))] \mathbb{E}[F(\Sigma_{\text{OS}}^{\text{top}}(T))],$$

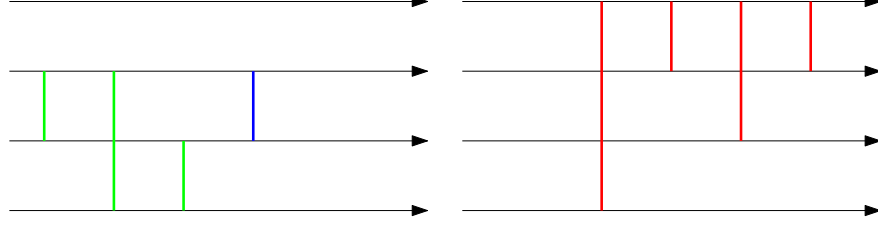

Figure 56: Left: the points of $\tilde{\Sigma}_{\text{OS}}(T)$ not involving the top strand. Right: the points of $\tilde{\Sigma}_{\text{OS}}(T)$ involving the top strand, arranged in reverse order.

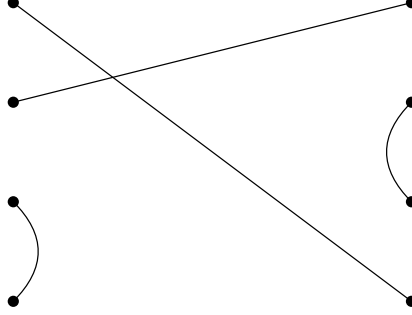

Figure 57: The matching one obtains from following all the swaps/turnarounds in $\Sigma_{\text{OS}}(T)$, or equivalently by first following all swaps/turnarounds not involving the top strand in $\tilde{\Sigma}_{\text{OS}}(T)$, and then following in reverse order all swaps involving the top strand in $\tilde{\Sigma}_{\text{OS}}(T)$.

By an explicit calculation, we have that

$$e^{(n+1)T - \frac{1}{2}(1 - \frac{1}{N})T} \rho_+ (\mathbb{E}[F(\Sigma_{\text{OS}}^{\text{top}}(T))]) = e^{-\frac{1}{2}(1 - \frac{1}{N})T} e^{-T J_{n+2}/N}.$$

We also have that

$$e^{2\binom{n+2}{2} - 2(n+1)T - \frac{n+1}{2}(1 - \frac{1}{N})T} \rho_+ (\mathbb{E}[F(\Sigma_{\text{OS}}^{\text{rest}}(T))]) = I \otimes \mathbb{E}[B_T^{\otimes(n+1)}].$$

Combining, we thus obtain

$$\begin{aligned} e^{2\binom{n+2}{2}T - \frac{n+2}{2}(1 - \frac{1}{N})T} \rho_+ (\mathbb{E}[F(\Sigma_{\text{OS}}(T)) \mathbb{1}(T_1 > T)]) P_{n+2} \\ = (I \otimes \mathbb{E}[B_T^{\otimes(n+1)}]) e^{-\frac{1}{2}(1 - \frac{1}{N})T} e^{-T \rho(J_{n+2})/N} P_{n+2} \\ = ((I \otimes \mathbb{E}[B_T^{\otimes(n+1)}]) P_{n+2}) (e^{-\frac{1}{2}(1 - \frac{1}{N})T} e^{-T \rho(J_{n+2})/N} P_{n+2}). \end{aligned}$$

The second identity follows since $P_{n+2}^2 = P_{n+2}$, and P_{n+2} commutes with $\rho(J_{n+2})$. By applying Lemmas 6.52 and 6.54, the last term above has operator norm which is bounded by

$$\begin{aligned} \|(I \otimes \mathbb{E}[B_T^{\otimes(n+1)}]) P_{n+2}\|_{\text{op}} \|e^{-\frac{1}{2}(1 - \frac{1}{N})T} e^{-T \rho(J_{n+2})/N} P_{n+2}\|_{\text{op}} &\lesssim T^{n+2} e^{-\frac{1}{2}(1 - \frac{1}{N})T} e^{-\frac{1}{2}(1 - \frac{1}{N})T} e^{(1 - \frac{2}{N})T} \\ &\lesssim T^{n+2} e^{-\frac{1}{N}T}, \end{aligned}$$

which converges to zero as $T \rightarrow \infty$. This shows the claim (6.4).

Thus to finish, it suffices to show that

$$\lim_{T \rightarrow \infty} \left\| e^{2\binom{n+2}{2}T - \frac{n+2}{2}(1 - \frac{1}{N})T} \rho_+ \left(\mathbb{E}[F(\Sigma_{\text{OS}}(T)) \mathbb{1}(T_1 \leq T, T_{(n+2)/2} > T)] \right) \mathbb{P}_{n+2} \right\|_{op} = 0.$$

On the event $T_1 \leq T$, we may follow the exploration until the end of the first era. Let E be the event that the first era ends with the turnaround $\langle n+2 \ n+1 \rangle$. We will focus on this case, as the case of a general turnaround may either be reduced to the case by permuting the strands, or may be similarly argued, just with more notation. By a discussion similar to that outlined in Figures 55 - 57, we may compute

$$\begin{aligned} & e^{2\binom{n+2}{2}T - \frac{n+2}{2}(1 - \frac{1}{N})T} \rho_+ \left(\mathbb{E}[F(\Sigma_{\text{OS}}(T)) \mathbb{1}(T_1 \leq T, T_{(n+2)/2} > T) \mathbb{1}_E] \right) \mathbb{P}_{n+2} \\ &= \int_0^T du \left(I \otimes \mathbb{E}[B_u^{\otimes(n+1)}] \right) \rho_+(\langle n+2 \ n+1 \rangle) (I^{\otimes 2} \otimes f_n(T-u)) e^{-u\rho(J_{n+2})/N} \mathbb{P}_{n+2}, \end{aligned}$$

where here $f_n(T-u)$, is the total partition function for a system with n strands, not all exploration eras end by time $T-u$. For brevity, let $I(T)$ denote the term on the right hand side above. Observe that our inductive assumption implies that for any $u \geq 0$,

$$\lim_{T \rightarrow \infty} \|f_n(T-u) \mathbb{P}_n\|_{op} = 0.$$

To insert \mathbb{P}_n , note by Lemma 6.56 that $\rho_+(\langle n+2 \ n+1 \rangle) \mathbb{P}_{n+2} = I^{\otimes 2} \otimes \mathbb{P}_n$. Using this and the fact that $\mathbb{P}_{n+2}^2 = \mathbb{P}_{n+2}$, we have that

$$I(T) = \int_0^T du \left((I \otimes \mathbb{E}[B_u^{\otimes(n+1)}]) \mathbb{P}_{n+2} \right) \rho_+(\langle n+2 \ n+1 \rangle) (I^{\otimes 2} \otimes (f_n(T-u) \mathbb{P}_n)) e^{-u\rho(J_{n+2})/N} \mathbb{P}_{n+2}.$$

By the inductive assumption, the operator norm of the integrand above converges pointwise to zero as $T \rightarrow \infty$. Recall also the previously obtained bound (via Lemmas 6.52 and 6.54)

$$\left\| (I \otimes \mathbb{E}[B_u^{\otimes(n+1)}]) \mathbb{P}_{n+2} \right\|_{op} \left\| e^{-u\rho(J_{n+2})/N} \mathbb{P}_{n+2} \right\|_{op} \lesssim u^{n+2} e^{-\frac{1}{N}u}.$$

We may thus apply dominated convergence to conclude that $\lim_{T \rightarrow \infty} \|I(T)\|_{op} = 0$. This finishes the proof of the inductive step. Thus the case $G = \text{O}(N)$ is proven.

The case $G = \text{Sp}(N/2)$ follows in a similar (and indeed, simpler) fashion. By a similar discussion, in the inductive step we may obtain the following identity when the first exploration era does not end:

$$\begin{aligned} e^{2\binom{n+2}{2}T - \frac{n+2}{2}(1 + \frac{1}{N})T} \rho_- \left(\mathbb{E}[F_-(\Sigma_{\text{OS}}(T)) \mathbb{1}(T_1 > T)] \right) &= (I \otimes \mathbb{E}[B_T^{\otimes(n+1)}]) e^{-\frac{1}{2}(1 + \frac{1}{N})T} e^{T\rho(J_{n+2})/N} \\ &= (I \otimes \mathbb{E}[B_T^{\otimes(n+1)}]) e^{-\frac{1}{2}(1 + \frac{1}{N})T} e^{-T\rho(J_{n+2})/N}, \end{aligned}$$

where in the second identity we used that (by definition) $\rho_-((i \ j)) = -\rho((i \ j))$ for transpositions $(i \ j)$. Then applying Lemmas 6.52 and 6.54, we may bound

$$\left\| (I \otimes \mathbb{E}[B_T^{\otimes(n+1)}]) e^{-\frac{1}{2}(1 + \frac{1}{N})T} e^{-T\rho(J_{n+2})/N} \right\|_{op} \lesssim T^{\frac{n}{2}} e^{-(1 + \frac{1}{N})T} e^{(1 - \frac{1}{N})T} \rightarrow 0 \text{ as } T \rightarrow \infty.$$

Thus as before, we may work on the event $\{T_1 \leq T, T_{(n+2)/2} > T\}$. The contribution from this event may be bounded similar to before. We omit the details. \square

Before we combine everything and prove Theorem 6.39, we state the following lemma which is needed for the case $G = O(N)$, whose proof is deferred to Section 6.1.4.

Lemma 6.57. For every pair of matchings $\pi, \pi' : [n] \rightarrow [n]$, $\rho_+([\pi \ \pi'])$ maps into the subspace of $O(N)$ -invariant vectors, i.e. $\text{Im}(\rho_+([\pi \ \pi'])) \subseteq \text{Im}(P_n)$.

Proof of Theorem 6.39. First, consider the case $G = O(N)$. By combining Propositions 6.49 and 6.51, we obtain

$$\begin{aligned} \lim_{T \rightarrow \infty} \mathbb{E}[B_T^{\otimes n}] \mathbb{E}[O_0^{\otimes n}] &= \lim_{T \rightarrow \infty} \mathbb{E}[B_T^{\otimes n}] \mathbb{E}[O_0^{\otimes n}] P_n \\ &= \lim_{T \rightarrow \infty} e^{2\binom{n}{2}T - \frac{n}{2}(1 - \frac{1}{N})T} \rho_\varepsilon(\mathbb{E}[F(\Sigma_{\text{OS}}(T)) \mathbb{1}(T_{n/2} \leq T)]) \mathbb{E}[O_0^{\otimes n}] P_n \\ &= \sum_{\pi, \pi' : [n] \rightarrow [n]} \text{Wg}_N^G(\pi, \pi') \rho_\varepsilon([\pi \ \pi']) P_n. \end{aligned}$$

Let $A = \sum_{\pi, \pi' : [n]} \text{Wg}_N^O(\pi, \pi') \rho_\varepsilon([\pi \ \pi'])$. To conclude that $\lim_{T \rightarrow \infty} \mathbb{E}[B_T^{\otimes n}] = A$, use that (by Lemma 6.57) $\text{Im}(A) \subseteq \text{Im}(P_n)$, and $AP_n = P_nA$. This implies $AP_n = P_nA = A$. Thus the case $G = O(N)$ is proven. The case $G = \text{Sp}(N/2)$ follows similarly (without the extra considerations involving P_n). \square

6.1.4 Technical proofs

In this section, we prove Lemmas 6.52 and 6.54. The main difficulty is in proving the estimates that involve the projection P_n , because as mentioned in Remarks 6.53 and 6.55, the addition of the P_n term leads to better estimates. We proceed to introduce the additional representation theory elements that are needed to see why these improved estimates hold. We note that everything we introduce is classical.

We first describe a spanning set for the space of $O(N)$ -invariant vectors. From classical representation theory (see e.g. [Dah17, Section 3]), when n is even, the space of $O(N)$ -invariants $\{v \in (\mathbb{C}^N)^{\otimes n} : O^{\otimes n}v = v\}$ is spanned by a family of vectors $\{u_\pi, \pi : [n] \rightarrow [n]\}$ which are indexed by matchings π . The vector $u_\pi \in (\mathbb{C}^N)^{\otimes n}$ is given by (with implicit summation over repeated indices)

$$u_\pi := \prod_{\{a,b\} \in \pi} \delta^{ia^{ib}} e_{i_1} \otimes \cdots \otimes e_{i_n}.$$

Remark 6.58. Dahqvist [Dah17] uses Brownian motion to prove this fact that $\{u_\pi, \pi : [n] \rightarrow [n]\}$ is a spanning set for the space of $O(N)$ -invariants (i.e. the First Fundamental Theorem of invariant theory). Thus one may wonder if we are cheating a bit in using this explicit knowledge of $O(N)$ -invariants in order to Proposition 6.51. We don't think our argument is circular, because our focus is not to re-prove representation theory results using Brownian motion, but rather to show that our particular strand-by-strand exploration process indeed suffices to recover the Weingarten calculus. Moreover, we find our strand-by-strand exploration intrinsically interesting, for the reasons given in Remark 4.13.

Observe that for any π , there exists a permutation $\sigma \in S_n$ such that $\rho(\sigma)u_{\pi_0} = u_\pi$. Indeed, recall that we previously fixed σ_π such that $\sigma_\pi[\pi \ \pi]\sigma_\pi^{-1} = [\pi_0 \ \pi_0]$, and that visually,

this had the interpretation that $[\pi \ \pi]$ may be taken to $[\pi_0 \ \pi_0]$ by permuting the left labels according to σ_π and the right labels by σ_π^{-1} – recall Figure 49. From this, we can obtain that

$$\rho(\sigma_\pi)u_\pi = u_{\pi_0}, \text{ or } \rho(\sigma_\pi^{-1})u_{\pi_0} = u_\pi. \quad (6.5)$$

For matchings $\pi, \pi' : [n] \rightarrow [n]$, the matrix elements of $\rho_+([\pi \ \pi'])$ are given by

$$\rho_+([\pi \ \pi'])_{\mathbf{i}\mathbf{j}} = \prod_{\{a,b\} \in \pi} \delta_{i_a i_b} \prod_{\{a,b\} \in \pi'} \delta_{j_a j_b}, \quad \mathbf{i} = (i_k, k \in [n]), \mathbf{j} = (j_k, k \in [n]) \in [N]^n.$$

The right hand side above is precisely $\langle u_\pi, e_{\mathbf{i}} \rangle \langle u_{\pi'}, e_{\mathbf{j}} \rangle$. In other words, we have that $\rho_+([\pi \ \pi'])$ is the rank-one matrix given by

$$\rho_+([\pi \ \pi']) = u_\pi u_{\pi'}^T$$

Proof of Lemma 6.57. The preceding discussion shows $\text{Im}(\rho_+([\pi \ \pi'])) \subseteq \text{span}(u_\pi) \subseteq \text{Im}(P_n)$. \square

Definition 6.59. Let \mathcal{H}_n be the subgroup of S_n such that $\sigma[\pi_0 \ \pi_0]\sigma^{-1} = [\pi_0 \ \pi_0]$. In words, \mathcal{H}_n is the subgroup of S_n which leaves π_0 fixed upon permutation of the vertices. Let $P_{\mathcal{H}_n} := \frac{1}{|\mathcal{H}_n|} \sum_{h \in \mathcal{H}_n} h \in \mathbb{C}[S_n]$.

Next, we recall the following classic results from the representation theory of the symmetric group. We closely follow the discussion from [ZJ09, Section 1.3]. There is a family of group algebra elements e_T indexed by standard Young tableau T with n boxes such that

$$e_T e_{T'} = \delta_{TT'} e_T, \quad \sum_{T:|T|=n} e_T = 1.$$

The e_T are known as Young's orthogonal idempotents. These elements have the additional property that they diagonalize the Jucys-Murphy elements. That is,

$$J_k e_T = e_T J_k = c(T, k) e_T, \quad k \in [n],$$

where $c(T, k)$ is the content of box k in T , i.e. $c(T, k) = j - i$ if box k has coordinates (i, j) in T . For a Young diagram λ , let $\text{SYT}(\lambda)$ be the set of all standard Young tableau with shape λ . Define

$$P_\lambda := \sum_{T \in \text{SYT}(\lambda)} e_T \in \mathbb{C}[S_n].$$

From the given properties of e_T , P_λ acts on $\mathbb{C}[S_n]$ as the projection onto the subspace V_λ corresponding to the irrep λ . An explicit formula for this projection is given by

$$P_\lambda = \frac{\chi_\lambda(\text{id})}{n!} \sum_{\sigma \in S_n} \chi_\lambda(\sigma) \sigma. \quad (6.6)$$

Since χ_λ is constant on conjugacy classes, P_λ is central, i.e. it commutes with all elements of $\mathbb{C}[S_n]$.

We note that for any Young diagram $\lambda \vdash n$, the matrix $\rho(P_\lambda) \in \text{End}((\mathbb{C}^N)^{\otimes n})$ is the orthogonal projection onto its image. Similarly, for any Young tableau with n boxes, $\rho(e_T)$ is the orthogonal projection onto its image. Moreover, the subspaces $\text{Im}(\rho(P_\lambda))$ and $\text{Im}(\rho(P_{\lambda'}))$ are orthogonal for $\lambda \neq \lambda'$. Similarly, the subspaces $\text{Im}(\rho(e_T))$, $\text{Im}(\rho(e_{T'}))$ are orthogonal for $T \neq T'$.

Notation 6.60. Given λ , let 2λ be the Young tableau obtained by “doubling”, i.e. by multiplying each part in the partition by 2.

The following lemma is the key observation which leads to improved estimates for $e^{-u\rho(J_n)}P_n$.

Lemma 6.61 (Proposition 4 of [ZJ09]). In order for $e_T P_{\mathcal{H}_n} \neq 0$, T must have shape 2λ for some $\lambda \vdash \frac{n}{2}$.

Lemma 6.62. For all $O(N)$ -invariant vectors $v \in (\mathbb{C}^N)^{\otimes n}$, we have that

$$v = \sum_{\lambda \vdash \frac{n}{2}} \rho(P_{2\lambda})v.$$

Proof. In general, we may write (recall (6.5))

$$v = \sum_{\pi} \alpha_{\pi} u_{\pi} = \sum_{\pi} \alpha_{\pi} \rho(\sigma_{\pi}^{-1})u_{\pi_0} = \rho\left(\sum_{\pi} \alpha_{\pi} \sigma_{\pi}^{-1}\right)u_{\pi_0}.$$

For brevity, let $X := \sum_{\pi} \alpha_{\pi} \sigma_{\pi}^{-1} \in \mathbb{C}[S_n]$. Now, since \mathcal{H}_n stabilizes u_{π_0} , we have that

$$\begin{aligned} \rho(X)u_{\pi_0} &= \rho(X)\rho(P_{\mathcal{H}_n})u_{\pi_0} = \rho(X) \sum_T \rho(e_T P_{\mathcal{H}_n})u_{\pi_0} = \rho(X) \sum_{\lambda \vdash \frac{n}{2}} \sum_{\lambda \in \text{SYT}(2\lambda)} \rho(e_T P_{\mathcal{H}_n})u_{\pi_0} \\ &= \rho(X)\rho\left(\sum_{\lambda \vdash \frac{n}{2}} \sum_{T \in \text{SYT}(2\lambda)} e_T\right)\rho(P_{\mathcal{H}_n})u_{\pi_0} \\ &= \rho(X)\rho\left(\sum_{\lambda \vdash \frac{n}{2}} P_{2\lambda}\right)u_{\pi_0} = \rho\left(\sum_{\lambda \vdash \frac{n}{2}} P_{2\lambda}\right)\rho(X)u_{\pi_0}. \end{aligned}$$

In the second identity, we used Lemma 6.61, and in the last identity, we used that $P_{2\lambda}$ is central. \square

Proof of Lemma 6.52. The first estimate follows immediately from the fact that all eigenvalues of $\rho(J_n)$ are at least $-N+1$ (by Lemma 2.28). We proceed to prove the second estimate. By Lemma 6.62, we have that

$$e^{-u\rho(J_n)}P_n = e^{-u\rho(J_n)} \sum_{\lambda \vdash \frac{n}{2}} \rho(P_{2\lambda})P_n.$$

It suffices to show that

$$\left\| e^{-u\rho(J_n)} \sum_{\lambda \vdash \frac{n}{2}} \rho(P_{2\lambda}) \right\|_{op} \leq e^{(N-2)u}.$$

Since $(\rho(P_{2\lambda}), \lambda \vdash \frac{n}{2})$ is a family of projections onto orthogonal subspaces, it suffices to show that for each $\lambda \vdash \frac{n}{2}$, we have that

$$\|e^{-u\rho(J_n)}\rho(P_{2\lambda})\|_{op} \leq e^{(N-2)u}.$$

To see this, first note that in order for $\rho(P_{2\lambda}) \neq 0$, 2λ must have at most N rows. Thus, we will assume that this is the case. Recalling that $P_{2\lambda} = \sum_{T \in \text{SYT}(2\lambda)} e_T$, and $(\rho(e_T), T \in \text{SYT}(2\lambda))$ is a family of projections onto orthogonal subspaces, it suffices to show that for each $T \in \text{SYT}(2\lambda)$, we have that

$$\|e^{-u\rho(J_n)}\rho(e_T)\|_{op} \leq e^{(N-2)u}.$$

Since $J_n e_T = c(T, n)e_T$, we have that

$$e^{-u\rho(J_n)}\rho(e_T) = e^{-uc(T, n)}\rho(e_T),$$

and so it is enough to argue that $c(T, n) \geq -(N-2)$. This follows because T has shape 2λ , and 2λ has at most N rows, which implies that the location of n in T cannot be $(N, 1)$. Any other location in T must have content at least $-(N-2)$. \square

Proof of Lemma 6.56. Since $\rho_+(\langle n \ n-1 \rangle)$ acts as the identity on the last $n-2$ tensor coordinates, it is enough to assume $n=2$ and prove $\rho_+(\langle 2 \ 1 \rangle)O^{\otimes 2} = \rho_+(\langle 2 \ 1 \rangle)$. Since $O^{\otimes 2}$ commutes with $\rho_+(\langle 2 \ 1 \rangle)$, we have that $\rho_+(\langle 2 \ 1 \rangle)O^{\otimes 2} = O^{\otimes 2}\rho_+(\langle 2 \ 1 \rangle)$. Now observe that when $n=2$, we have that $\langle 2 \ 1 \rangle = [\pi_0 \ \pi_0]$. Since $\rho_+([\pi_0 \ \pi_0])$ maps into the subspace of $O(N)$ -invariants (by Lemma 6.57), it follows that $O^{\otimes 2}\rho_+([\pi_0 \ \pi_0]) = \rho_+([\pi_0 \ \pi_0])$. \square

Definition 6.63. Following the notation of [Dah17], let $\varepsilon_N \in \mathbb{C}[\mathbb{S}_N]$ be given by

$$\varepsilon_N := \frac{1}{N!} \sum_{\sigma \in \mathbb{S}_N} \text{sgn}(\sigma)\sigma.$$

Remark 6.64. Observe that ε_N is precisely $P_{\lambda_{\min}}$, where $\lambda_{\min} = (1, \dots, 1)$ is the Young tableau corresponding to the sign representation of \mathbb{S}_N .

Lemma 6.65. Suppose $N \geq 3$ is odd. We have that $(I \otimes \rho(\varepsilon_N))P_{N+1} = 0$. Also, for any $1 \leq i < j \leq N$, $\varepsilon_N \langle i \ j \rangle = 0 \in \mathcal{B}_N$. Here, to be clear $\rho: \mathcal{B}_N \rightarrow \text{End}((\mathbb{C}^N)^{\otimes N})$.

Proof. It suffices to show that for any matching $\pi: [N+1] \rightarrow [N+1]$, the corresponding invariant vector u_π is annihilated by $I \otimes \rho(\varepsilon_N)$, i.e. $(I \otimes \rho(\varepsilon_N))u_\pi = 0$. To see this, note that for any π , there is some pair of vertices $\{i, j\}$ matched by π , with both $i, j \leq N$ (here we use the assumption that $N \geq 3$). Since these vertices are matched, swapping them does not change the matching, and so we have that $(I \otimes \rho(\langle i \ j \rangle))u_\pi = u_\pi$. On the other hand, we have that $\varepsilon_N \langle i \ j \rangle = -\varepsilon_N$, and thus $(I \otimes \rho(\varepsilon_N))\rho(\langle i \ j \rangle) = I \otimes \rho(\varepsilon_N \langle i \ j \rangle) = -I \otimes \rho(\varepsilon_N)$. We thus have

$$(I \otimes \rho(\varepsilon_N))u_\pi = (I \otimes \rho(\varepsilon_N))\rho(\langle i \ j \rangle)u_\pi = -(I \otimes \rho(\varepsilon_N))u_\pi,$$

and thus $(I \otimes \rho(\varepsilon_N))u_\pi = 0$. The second claim follows by the a similar argument, i.e. we start from the observation $(i \ j)\langle i \ j \rangle = \langle i \ j \rangle$. \square

Lemma 6.66. We have that $\frac{1}{N}\rho(J_N + \dots + J_1) \in \text{End}((\mathbb{C}^N)^{\otimes N})$ has eigenvalue $-\frac{N}{2} + \frac{1}{2}$ with eigenspace $\text{Im}(\rho(\varepsilon_N))$. All other eigenvalues are at least $-\frac{N}{2} + \frac{3}{2}$.

Proof. From the discussion in Lemma 2.30, recall that for each $\lambda \vdash N$, $\rho(P_\lambda)$ projects onto an eigenspace of $\rho(J_N + \cdots + J_1)$ with eigenvalue given by the content sum c_λ . The minimal content sum in this case is achieved when $\lambda = \lambda_{\min} = (1, \dots, 1)$, i.e. the Young diagram with N parts of size 1, or equivalently a single column of height N . The content sum in this case is

$$-(N-1) - (N-2) - \cdots - 1 = -\frac{N(N-1)}{2}.$$

Thus the minimal eigenvalue of $\frac{1}{N}\rho(J_N + \cdots + J_1)$ is $-\frac{N-1}{2} = -\frac{N}{2} + \frac{1}{2}$. The associated eigenspace is $\text{Im}(\rho(P_{\lambda_{\min}}))$. The first claim now follows upon recalling that $P_{\lambda_{\min}} = \varepsilon_N$. The next smallest eigenvalue is given by moving the box $(N, 1)$ to $(1, 2)$, i.e. by the Young diagram $\lambda = (2, 1, \dots, 1)$. The content sum in this case is

$$-(N-2) - \cdots - 1 + 1 = -\frac{N(N-1)}{2} + N.$$

The second claim now follows. □

Definition 6.67. Define

$$\Delta_\varepsilon^n(n-1) := -\frac{(n-1)}{2} \left(1 - \frac{\varepsilon}{N}\right) I^{\otimes n} - \frac{1}{N} I \otimes \rho_{N,n-1}(J_{n-1} + \cdots + J_1) \in \text{End}((\mathbb{C}^N)^{\otimes n}).$$

Here, we write the subscripts $\rho_{N,n-1}$ to be clear that $\rho_{N,n-1} : S_{n-1} \rightarrow \text{End}((\mathbb{C}^N)^{\otimes(n-1)})$.

Lemma 6.68. For any $n \geq 2$ such that $n-1 \neq N$, we have that

$$\|e^{u\Delta_\varepsilon^n(n-1)}\|_{op} \leq e^{-\frac{1}{2}(1-\frac{\varepsilon}{N})u}, \quad u \geq 0.$$

If $n-1 = N$, we have that

$$\|e^{u\Delta_1^n(n-1)} P_n\|_{op} \leq e^{-u}, \quad \|e^{u\Delta_1^n(n-1)} \rho_+(\langle 2 \ 1 \rangle)\|_{op} \leq N e^{-u}, \quad \|e^{u\Delta_{-1}^n(n-1)}\|_{op} \leq e^{-u}, \quad u \geq 0.$$

Proof. For brevity, write ρ instead of $\rho_{N,n-1}$. For the first estimate, note that the case $\varepsilon = -1$ readily follows from the case $\varepsilon = 1$ because

$$\Delta_{-1}^n(n-1) = \Delta_1^n(n-1) - \frac{n-1}{N}.$$

Thus, we focus on the case $\varepsilon = 1$. Define

$$\Delta_1^{n-1}(n-1) := -\frac{(n-1)}{2} \left(1 - \frac{1}{N}\right) I^{\otimes(n-1)} - \frac{1}{N} \rho(J_{n-1} + \cdots + J_1) \in \text{End}((\mathbb{C}^N)^{\otimes(n-1)}) \quad (6.7)$$

Then $\Delta_1^n(n-1) = I \otimes \Delta_1^{n-1}(n-1)$. Thus, it suffices to just look at $\Delta_1^{n-1}(n-1)$. By Lemma 2.30, the eigenvalues of $\rho(J_{n-1} + \cdots + J_1)$ are lower-bounded by

$$-\frac{1}{2}(n-1) + \frac{1}{2}m^2 + \frac{1}{2}r - \frac{1}{2} \frac{r(r-1)}{N} + \frac{mr}{N}.$$

From this, it follows that all eigenvalues of $\Delta_1^{n-1}(n-1)$ are at most

$$-\frac{n-1}{2} \left(1 - \frac{1}{N}\right) + \frac{1}{2}(n-1) - \frac{1}{2}m^2 - \frac{1}{2}r + \frac{1}{2} \frac{r(r-1)}{N} - \frac{mr}{N}.$$

Using that $n-1 = mN + r$, this may be simplified to

$$\frac{1}{2}m(1-m) - \frac{1}{2}r \left(1 - \frac{r}{N}\right) - \frac{mr}{N}.$$

If $(m, r) \neq (1, 0)$, then the above is easily seen to be at most $-\frac{1}{2}(1 - \frac{1}{N})$, which implies

$$\|e^{u\Delta_1^{n-1}}\|_{op} = \|e^{u(I \otimes \Delta_1^{n-1}(n-1))}\|_{op} = \|e^{u\Delta_1^{n-1}(n-1)}\|_{op} \leq e^{-\frac{1}{2}(1-\frac{1}{N})u}.$$

If $(m, r) = (1, 0)$, then $n-1 = N$. We may split

$$e^{T\Delta_1^N(N)} = e^{T\Delta_1^N(N)}(1 - \rho(\varepsilon_N)) + \rho(\varepsilon_N).$$

By Lemma 6.66, we have that on $\text{Im}(1 - \rho(\varepsilon_N))$, all eigenvalues of $\Delta_1^N(N)$ are at most -1 , and thus

$$\|e^{T\Delta_1^N(N)}(1 - \rho(\varepsilon_N))\|_{op} \leq e^{-T}.$$

By Lemma 6.65, we have that for $M = P_{N+1}$ or $\rho_+(\langle i j \rangle)$, $(I \otimes \rho(\varepsilon_N))M = 0$. Combining these two, it follows that

$$\|e^{T\Delta_1^{n-1}}M\|_{op} \leq e^{-T}\|M\|_{op}.$$

We have that $\|P_{N+1}\|_{op} \leq 1$ since P_{N+1} is an orthogonal projection. Since $\langle i j \rangle^2 = N\langle i j \rangle$, we obtain $\rho_+(\langle i j \rangle)^2 = N\rho_+(\langle i j \rangle)$, which implies $\|\rho_+(\langle i j \rangle)\|_{op} = N$.

Finally, when $n-1 = N$, we have by (6.7) that $\Delta_{-1}^n(n-1) = \Delta_1^n(n-1) - 1$. By the preceding discussion, all eigenvalues of $\Delta_1^n(n-1)$ are at most 0, and thus by equation (6.7) all eigenvalues of $\Delta_{-1}^n(n-1)$ are at most -1 , and thus the estimate $\|e^{u\Delta_{-1}^n(n-1)}\|_{op} \leq e^{-u}$ immediately follows. \square

Proof of Lemma 6.54. First, consider the case $G = O(N)$. We proceed by induction. First, in the base case $n = 2$, we have that $\mathbb{E}[B_u] = e^{-\frac{1}{2}(1-\frac{1}{N})u}$, and so

$$I \otimes \mathbb{E}[B_u] = e^{-\frac{1}{2}(1-\frac{1}{N})u} I^{\otimes 2}.$$

The desired estimate in this case immediately follows.

Now, suppose that the result is true for some even $n \geq 2$. Consider the case $n+2$. We have that

$$I \otimes \mathbb{E}[B_u^{\otimes(n+1)}] = e^{2\binom{n+2}{2}T - \frac{n+2}{2}(1-\frac{1}{N})T} \rho_+(\mathbb{E}[F(\Sigma_{OS}(T))\mathbb{1}_{E_1}]),$$

where E_1 is the event that there are no points touching the top strand. Let E_2 be the event that there is some turnaround in $\Sigma_{OS}(T)$. Then on the complement of E_2 , there are only swaps, and we may compute

$$e^{2\binom{n+2}{2}T - \frac{n+2}{2}(1-\frac{1}{N})T} \rho_+(\mathbb{E}[F(\Sigma_{OS}(T))\mathbb{1}_{E_1}\mathbb{1}_{E_2^c}]) = e^{T\Delta_1^{n+2}(n+1)}.$$

By Lemma 6.68, we have that

$$\|e^{T\Delta_1^{n+2}(n+1)}\mathbf{P}_{n+2}\|_{op} \leq e^{-\frac{1}{2}(1-\frac{1}{N})T}.$$

Combining, we thus obtain

$$\|e^{2\binom{n+2}{2}T-\frac{n+2}{2}(1-\frac{1}{N})T}\rho_+(\mathbb{E}[F(\Sigma_{\text{OS}}(T))\mathbb{1}_{E_1}\mathbb{1}_{E_2^c}])\mathbf{P}_{n+2}\|_{op} \leq e^{-\frac{1}{2}(1-\frac{1}{N})T}.$$

To finish, it suffices to show a similar estimate with $\mathbb{1}_{E_2^c}$ replaced by $\mathbb{1}_{E_2}$. Let $E_2^0 \subseteq E_2$ be the event that the first turnaround in $\Sigma_{\text{OS}}(T)$ is $\langle 2 \ 1 \rangle$. We will show the estimate with $\mathbb{1}_{E_2}$ replaced by $\mathbb{1}_{E_2^0}$. The general estimate will follow by the same argument, just with more notation. On the event E_2^0 , we may condition on the time of the first turnaround to obtain

$$\begin{aligned} e^{2\binom{n+2}{2}T-\frac{n+2}{2}(1-\frac{1}{N})T}\rho_+(\mathbb{E}[F(\Sigma_{\text{OS}}(T))\mathbb{1}_{E_1}\mathbb{1}_{E_2^0}]) &= \\ &= \int_0^T du e^{u\Delta_1^{n+2}(n+1)}\rho_+(\langle 2 \ 1 \rangle)(I \otimes \mathbb{E}[B_{T-u}^{\otimes(n-1)}] \otimes I^{\otimes 2}). \end{aligned}$$

Here, the $e^{u\Delta_1^{n+2}(n+1)}$ term arises because given that the first turnaround happens at time u , we average over the contribution from all swaps which happen before u . The term $I \otimes \mathbb{E}[B_{T-u}^{\otimes(n-1)}] \otimes I^{\otimes 2}$ arises because once we see the turnaround $\langle 2 \ 1 \rangle$ at time u , we can ignore those strands after time u , and only look at the top $n-2$ strands on the interval $[u, T]$.

Now, observe that (by a variant of Lemma 6.56)

$$\rho_+(\langle 2 \ 1 \rangle)\mathbf{P}_{n+2} = \mathbf{P}_n \otimes I^{\otimes 2}.$$

From this, we obtain

$$\begin{aligned} e^{2\binom{n+2}{2}T-\frac{n+2}{2}(1-\frac{1}{N})T}\rho_+(\mathbb{E}[F(\Sigma_{\text{OS}}(T))\mathbb{1}_{E_1}\mathbb{1}_{E_2^0}])\mathbf{P}_{n+2} &= \\ &= \int_0^T du e^{u\Delta_1^{n+2}(n+1)}\rho_+(\langle 2 \ 1 \rangle)I \otimes \mathbb{E}[B_{T-u}^{\otimes(n-1)}] \otimes I^{\otimes 2}\mathbf{P}_{n+2} \\ &= \int_0^T du e^{u\Delta_1^{n+2}(n+1)}\rho_+(\langle 2 \ 1 \rangle)\left(\left((I \otimes \mathbb{E}[B_{T-u}^{\otimes(n-1)}])\mathbf{P}_n\right) \otimes I^{\otimes 2}\right). \end{aligned}$$

By our inductive assumption, we have that

$$\|((I \otimes \mathbb{E}[B_{T-u}^{\otimes(n-1)}])\mathbf{P}_n)\|_{op} \lesssim (T-u)^{\frac{n}{2}-1}e^{-\frac{1}{2}(1-\frac{1}{N})(T-u)}.$$

By Lemma 6.68, we have that

$$\|e^{u\Delta_1^{n+2}(n+1)}\rho_+(\langle 2 \ 1 \rangle)\|_{op} \lesssim e^{-\frac{1}{2}(1-\frac{1}{N})u}.$$

Putting our two estimates, together, we obtain

$$\begin{aligned} \|e^{2\binom{n+2}{2}T-\frac{n+2}{2}(1-\frac{1}{N})T}\rho_+(\mathbb{E}[F(\Sigma_{\text{OS}}(T))\mathbb{1}_{E_1}\mathbb{1}_{E_2^0}])\|_{op} &\lesssim \int_0^T du (T-u)^{\frac{n}{2}-1}e^{-\frac{1}{2}(1-\frac{1}{N})T} \\ &\lesssim T^{\frac{n+2}{2}-1}e^{-\frac{1}{2}(1-\frac{1}{N})T}, \end{aligned}$$

which proves the inductive step. Thus the case $G = O(N)$ is proven.

The case $G = \mathrm{Sp}(N/2)$ is similar (and indeed, simpler). We sketch the changes. In the first part of the inductive step, we may compute

$$\begin{aligned} e^{2\binom{n+2}{2}T - \frac{n+2}{2}(1+\frac{1}{N})T} \rho_- (\mathbb{E}[F_- (\Sigma_{\mathrm{OS}}(T)) \mathbb{1}_{E_1} \mathbb{1}_{E_2^c}]) &= e^{-\frac{n+2}{2}(1+\frac{1}{N})T} e^{\frac{T}{N}\rho_-(J_{n+2}+\dots+J_1)} \\ &= e^{-\frac{n+2}{2}(1+\frac{1}{N})T} e^{-\frac{T}{N}\rho(J_{n+2}+\dots+J_1)} = e^{T\Delta_{-1}^{n+2}(n+1)}, \end{aligned}$$

where we used that (by definition) $\rho_-((i\ j)) = -\rho((i\ j))$ for transpositions $(i\ j)$. By Lemma 6.68, we have that $\|e^{T\Delta_{-1}^{n+2}(n+1)}\|_{op} \leq e^{-\frac{1}{2}(1+\frac{1}{N})T}$. The contribution from the case $\mathbb{1}_{E_1} \mathbb{1}_{E_2}$ may be handled similar to before. We omit the details. \square

6.1.5 Makeenko-Migdal/Master loop/Schwinger-Dyson equation

We next discuss the Makeenko-Migdal/Master loop/Schwinger-Dyson equation for $G = O(N), \mathrm{Sp}(N/2)$. First, we introduce additional string operations which appear for these groups.

Definition 6.69 (Mergers, Twistings). Let $\mathbf{\Gamma} = (\Gamma_1, \dots, \Gamma_k)$ be a collection of words on $\{\lambda_1, \dots, \lambda_L\}$. Let (i, j) be a location of $\mathbf{\Gamma}$. Define the set of positive and negative mergers $\mathbb{M}_+((i, j), \mathbf{\Gamma})$ and $\mathbb{M}_-((i, j), \mathbf{\Gamma})$, as well as the set of positive and negative twistings $\mathbb{T}_+((i, j), \mathbf{\Gamma})$ and $\mathbb{T}_-((i, j), \mathbf{\Gamma})$, as follows. Throughout, denote the letter at location (i, j) by λ , and suppose $\Gamma_i = A\lambda B$.

The set of positive mergers $\mathbb{M}_+((i, j), \mathbf{\Gamma})$ is the set of collections of words $\mathbf{\Gamma}'$ obtained by merging Γ_i with some Γ_ℓ , $\ell \neq i$, in one of two ways. The first way: let (ℓ, m) be a location which also has letter λ . Suppose $\Gamma_\ell = C\lambda D$. Then Γ_i, Γ_ℓ are replaced by $A\lambda D C \lambda B$. The second way: let (ℓ, m) be a location which has λ^{-1} . Suppose $\Gamma_\ell = C\lambda^{-1}D$. Then Γ_i, Γ_ℓ are replaced by $A\lambda C^{-1}D^{-1}\lambda B$.

The set of negative mergers $\mathbb{M}_-((i, j), \mathbf{\Gamma})$ is the set of collections of words $\mathbf{\Gamma}'$ obtained by merging Γ_i with some Γ_ℓ , $\ell \neq i$, in one of two ways. The first way: let (ℓ, m) be a location which also has letter λ . Suppose $\Gamma_\ell = C\lambda D$. Then Γ_i, Γ_ℓ are replaced by $A C^{-1} D^{-1} B$. The second way: let (ℓ, m) be a location which has λ^{-1} . Suppose $\Gamma_\ell = C\lambda^{-1}D$. Then Γ_i, Γ_ℓ are replaced by $A D C B$.

The set of positive twistings $\mathbb{T}_+((i, j), \mathbf{\Gamma})$ is the set of collections of words $\mathbf{\Gamma}'$ obtained by replacing Γ_i with another word as follows. If λ^{-1} does not appear in Γ_i , the set $\mathbb{T}_-((i, j), \mathbf{\Gamma})$ is empty. Thus, suppose λ^{-1} also appears in Γ_i . Let (i, k) be a location which has λ^{-1} . If $k > j$ then recalling that $\Gamma_i = A\lambda B$, we may write $B = C\lambda^{-1}D$. We then replace $\Gamma_i = A\lambda C\lambda^{-1}D$ by $A\lambda C^{-1}\lambda^{-1}D$. If $k < j$ then we may write $A = E\lambda^{-1}F$. We then replace $\Gamma_i = E\lambda^{-1}F\lambda B$ by $E\lambda^{-1}F^{-1}\lambda B$.

The set of negative twistings $\mathbb{T}_-((i, j), \mathbf{\Gamma})$ is the set of collections of words $\mathbf{\Gamma}'$ obtained by replacing Γ_i with another word as follows. If λ appears only once in Γ_i , the set $\mathbb{T}_-((i, j), \mathbf{\Gamma})$ is empty. Thus, suppose λ appears at least twice in Γ_i . Denote (i, k) be another location which has λ . If $k > j$ then recalling that $\Gamma_i = A\lambda B$, we may write $B = C\lambda D$. We then replace $\Gamma_i = A\lambda C\lambda D$ by $A C^{-1} D$. If $k < j$ then we may write $A = E\lambda F$. We then replace $\Gamma_i = E\lambda F\lambda C$ by $E F^{-1} C$.

Remark 6.70. From the perspective of our Poisson point process on strand diagrams, the reason why the $O(N)$ and $Sp(N/2)$ cases result in additional loop operations is because there may now be turnarounds between two same-direction strands, and swaps between two opposite-direction strands. (Recall that in the Unitary case, same-direction strands only had swaps and opposite-direction strands only had turnarounds.)

Proposition 6.71 (Single-location $O(N)$, $Sp(N/2)$ word recursion). Let $G = O(N)$, $Sp(N/2)$. Let $\Gamma = (\Gamma_1, \dots, \Gamma_k)$ be a collection of words on $\{\lambda_1, \dots, \lambda_L\}$. For any location (i, j) of Γ , we have that

$$\begin{aligned} \varepsilon \left(1 - \frac{\varepsilon}{N} \right) \mathbb{E}[\text{tr}(G(\Gamma))] &= - \sum_{\Gamma' \in \mathbb{S}_+((i,j),\Gamma)} \mathbb{E}[\text{tr}(G(\Gamma'))] + \sum_{\Gamma' \in \mathbb{S}_-((i,j),\Gamma)} \mathbb{E}[\text{tr}(G(\Gamma'))] \\ &\quad - \frac{1}{N^2} \sum_{\Gamma' \in \mathbb{M}_+((i,j),\Gamma)} \mathbb{E}[\text{tr}(G(\Gamma'))] + \frac{1}{N^2} \sum_{\Gamma' \in \mathbb{M}_-((i,j),\Gamma)} \mathbb{E}[\text{tr}(G(\Gamma'))] \\ &\quad - \frac{1}{N} \sum_{\Gamma' \in \mathbb{T}_+((i,j),\Gamma)} \mathbb{E}[\text{tr}(G(\Gamma'))] + \frac{1}{N} \sum_{\Gamma' \in \mathbb{T}_-((i,j),\Gamma)} \mathbb{E}[\text{tr}(G(\Gamma'))] \end{aligned}$$

Proof (sketch). The proof proceeds by stopping our strand-by-strand exploration process at the time of the first point, as in the proof of the $U(N)$ word recursion (Proposition 5.2). The main ideas are very similar but the details are a bit different – we sketch out where the differences lie. When we explore the strand-by-strand exploration until the first point, we see either a turnaround or a swap, which may connect same-direction or opposite-direction strands. Moreover, the two strands may be part of the same word or different words. We present the two tables in Figure 58 which indicate which of the loop operations each of these cases contributes to. \square

		same dir.	opp. dir.			same dir.	opp. dir.
different words	same word	\mathbb{S}_+	\mathbb{T}_+	different words	same word	\mathbb{T}_-	\mathbb{S}_-
	different words	\mathbb{M}_+	\mathbb{M}_+		different words	different words	\mathbb{M}_-
				swap			
				turnaround			

Figure 58: Left: the various cases when the first point is a swap. Right: the various cases when the first point is a turnaround.

The word recursion then immediately implies the Makeenko-Migdal/Master loop/Schwinger-Dyson equation. The proof is omitted, as it is very similar to the proof of the Unitary

Makeenko-Migdal/Master loop/Schwinger-Dyson equation using the Unitary word recursion (see Section 5).

Theorem 6.72 (Single-location $O(N)$ and $Sp(N/2)$ Makeenko-Migdal/Master loop/Schwinger-Dyson equation). *Let $s = (\ell_1, \dots, \ell_n)$ be a string. Let (k, i) be a location in s . For $G = O(N), Sp(N/2)$ lattice Yang-Mills theory, we have that*

$$\begin{aligned} \varepsilon \left(1 - \frac{\varepsilon}{N} \right) \phi(s) = & - \sum_{s' \in \mathbb{S}_+((k,i),s)} \phi(s') + \sum_{s' \in \mathbb{S}_-((k,i),s)} \phi(s') \\ & - \frac{1}{N^2} \sum_{s' \in \mathbb{M}_+((k,i),s)} \phi(s') + \frac{1}{N^2} \sum_{s' \in \mathbb{M}_-((k,i),s)} \phi(s') \\ & - \frac{1}{N} \sum_{s' \in \mathbb{T}_+((k,i),s)} \phi(s') + \frac{1}{N} \sum_{s' \in \mathbb{T}_-((k,i),s)} \phi(s') \\ & - 2\beta \sum_{s' \in \mathbb{D}_+((k,i),s)} \phi(s') + 2\beta \sum_{s' \in \mathbb{D}_-((k,i),s)} \phi(s'). \end{aligned}$$

Remark 6.73. In the Unitary case, we had the factor β in front of the deformation terms, whereas in the Orthogonal and Symplectic cases, we have the factor 2β . This difference is ultimately due to the fact that there may be swaps and turnaround between any two strands, no matter their directions.

6.2 Special Unitary and Special Orthogonal

The Weingarten calculus for $SU(N)$ and $SO(N)$ is far less developed than for $U(N), O(N), Sp(N/2)$. The only formula we have seen for the $SU(N)$ Weingarten function is in the physics literature [BVC20, Equation (20)]. We have not seen a formula for the $SO(N)$ Weingarten function. Therefore, in this paper we will not do as much for $SU(N)$ and $SO(N)$ as we did for the previous three groups. In particular, we will not recover the Weingarten calculus via large-time limits of Brownian motion. Instead, we will focus on giving surface-sum representations of Wilson loop expectations and proving the Makeenko-Migdal/Master loop/Schwinger-Dyson equations.

We first show that although we don't have explicit formulas for the $SU(N)$ and $SO(N)$ Weingarten functions, we can still relate (via soft arguments) $SU(N)$ and $SO(N)$ Haar expectations to some elements of the Brauer algebra. These ‘‘Weingarten elements’’ will then provide the weights that appear in our surface-sum representations.

Definition 6.74. Given a matching $\pi \in \mathcal{M}(n)$, let π^T be the reflection of π , or i.e. the matching obtained by swapping the left and right vertices.

Proposition 6.75. For $n, m \geq 0$, there exist elements $Wg_N^{\text{SU}} \in \mathcal{B}_{n,m}, Wg_N^{\text{SO}} \in \mathcal{B}_n$ such that

$$\begin{aligned} \mathbb{E}[G^{\otimes n} \otimes \bar{G}^{\otimes m}] &= \rho_+(Wg_N^{\text{SU}}), \quad G = SU(N), \\ \mathbb{E}[G^{\otimes n}] &= \rho_+(Wg_N^{\text{SO}}), \quad G = SO(N). \end{aligned}$$

Moreover, these elements are invariant under reflection:

$$Wg_N^\bullet(\pi) = Wg_N^\bullet(\pi^T), \quad \bullet \in \{SU(N), SO(N)\},$$

as well as invariant under conjugation:

$$\begin{aligned}\sigma \text{Wg}_N^{\text{SU}} \sigma^{-1} &= \text{Wg}_N^{\text{SU}} \text{ for all } \sigma \in S_n \times S_m \subseteq \mathcal{B}_{n,m}, \\ \sigma \text{Wg}_N^{\text{SO}} \sigma^{-1} &= \text{Wg}_N^{\text{SO}} \text{ for all } \sigma \in S_n.\end{aligned}$$

There are various ways one can prove this proposition. The representation-theoretic way would be to note that in the $\text{SU}(N)$ case, $\mathbb{E}[S^{\otimes n} \otimes \bar{S}^{\otimes m}]$ commutes with $U^{\otimes n} \otimes \bar{U}^{\otimes m}$ for any $U \in \text{SU}(N)$, and then to use the fact that any such operator must be of the form $\rho(W)$ for some $W \in \mathcal{B}_{n,m}$. The fact that W may be assumed to be invariant under conjugation can be ensured by averaging over all possible conjugations, since this does not change $\mathbb{E}[S^{\otimes n} \otimes \bar{S}^{\otimes m}]$. The $\text{SO}(N)$ case can be handled similarly.

Another way to show the proposition is via $\text{SU}(N)$ and $\text{SO}(N)$ Brownian motion. We have already introduced how $\text{SO}(N)$ Brownian motion is related to the Brauer algebra (Proposition 6.37), and we will need to introduce $\text{SU}(N)$ Brownian motion in order to derive the Makeenko-Migdal/Master loop/Schwinger-Dyson equations for $\text{SU}(N)$. Thus we will supply a proof of Proposition 6.75 using Brownian motion. The first step is to introduce the analog of Proposition 6.37 for $\text{SU}(N)$, i.e. to state how expectations of $\text{SU}(N)$ Brownian motion are related to Brauer algebra elements. We begin with the necessary setup.

Definition 6.76 (Poisson point process for $\text{SU}(N)$). Let $n, m \geq 0$. Define a Poisson point process Σ_{SU} as follows. We imagine we have n right-directed strands and m left-directed strands. Let Σ_{U} be the Poisson point process on this strand diagram corresponding to the Unitary case, i.e. between any two same-direction strands, there is a rate-1 Poisson process giving same-direction swaps, and between any two opposite-direction strands, there is a rate-1 Poisson process giving turnarounds. We define $\Sigma_{\text{SU}} := \Sigma_{\text{U}} \sqcup \Sigma'_{\text{SU}}$, where Σ'_{SU} is an independent Poisson process which is made of independent rate-1 Poisson processes between any two pairs of strands, not necessarily distinct⁹. We differentiate between the various types of points by assigning the color green to same-direction swaps, blue to turnarounds, and purple to the points of Σ'_{SU} .

Definition 6.77. Define F^{SU} which maps point process realizations P to elements of the Brauer algebra $\mathcal{B}_{n,m}$ as follows. We may split our point process realization $P = P_{\text{U}} \sqcup P'$, where P_{U} collects all same-direction swaps and turnarounds, and P' collects all purple points. We define $F^{\text{SU}}(P) := F(P_{\text{U}})F'(P')$, where $F(P_{\text{U}}) \in \mathcal{B}_{n,m}$ is exactly as in the Unitary case, and $F'(P') \in \mathbb{R}$ is a scalar defined as follows. Let K be the number of points in P' between same-direction strands, and K' be the number of points in P' between opposite-direction strands. Then

$$F'(P') := \left(\frac{1}{N^2}\right)^K \left(-\frac{1}{N^2}\right)^{K'}.$$

One should think of this as saying that each point in P' between same-direction strands incurs a factor of N^{-2} , while each point in P' between opposite-direction strands incurs a factor of $-N^{-2}$.

See Figure 59 for an example realization of Σ_{SU} .

⁹Whereas the processes for same-direction swaps and turnarounds are always between distinct strands.

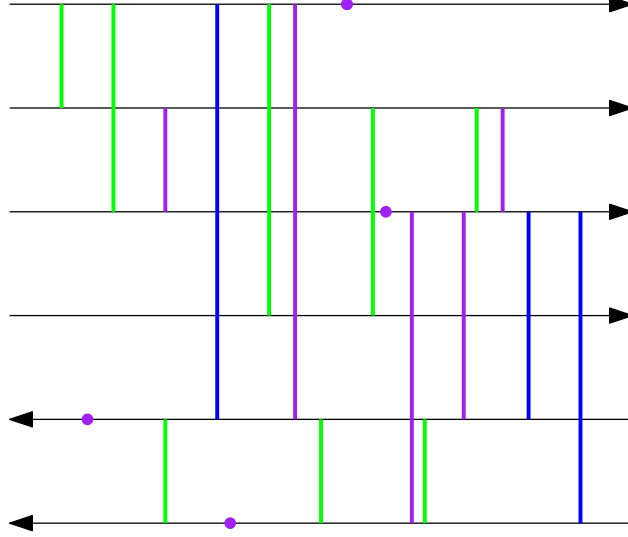

Figure 59: Example realization of $\Sigma_{\text{SU}}(T)$. The green lines represent same-direction swaps, blue lines represent turnarounds, and purple lines/points represent the points of Σ'_{SU} . In particular, a purple point on a given strand belongs to the Poisson process that encodes points between that strand and itself.

We can now state how $\text{SU}(N)$ Brownian motion is related to the Brauer algebra $\mathcal{B}_{n,m}$. See [PPSY23, Appendix A] for the proof.

Proposition 6.78. We have that

$$\mathbb{E}[B_T^{\otimes n} \otimes \bar{B}_T^{\otimes m}] = e^{(n+m)^2 T - \frac{n+m}{2} T} \rho_+(\mathbb{E}[F^{\text{SU}}(\Sigma_{\text{SU}}(T))]), \quad T \geq 0.$$

Proposition 6.78 immediately implies Proposition 6.75, as we next show.

Proof of Proposition 6.75. First, consider the $\text{SU}(N)$ case. Note that $\rho_+ : \mathcal{B}_{n,m} \rightarrow \text{End}((\mathbb{C}^N)^{\otimes(n+m)})$ is a linear map into a finite-dimensional vector space. This implies that its image $\rho_+(\mathcal{B}_{n,m})$ is a closed subspace of $\text{End}((\mathbb{C}^N)^{\otimes(n+m)})$ (as every subspace of a finite-dimensional vector space is closed).

By Proposition 6.78, we have that $\mathbb{E}[B_T^{\otimes n} \otimes \bar{B}_T^{\otimes m}] \in \rho_+(\mathcal{B}_{n,m})$ for all $T \geq 0$. Thus by the preceding discussion, we also have that $\mathbb{E}[G^{\otimes n} \otimes \bar{G}^{\otimes m}] = \lim_{T \rightarrow \infty} \mathbb{E}[B_T^{\otimes n} \otimes \bar{B}_T^{\otimes m}] \in \rho_+(\mathcal{B}_{n,m})$. Therefore there exists $W \in \mathcal{B}_{n,m}$ such that $\mathbb{E}[S^{\otimes n} \otimes \bar{S}^{\otimes m}] = \rho_+(W)$. Using W , we construct Wg_N^{SU} which possesses the claimed symmetries.

Let $W^T \in \mathcal{B}_{n,m}$ be defined by $W^T(\pi) := W(\pi^T)$. We have that

$$\begin{aligned} \rho_+(W^T) &= (\rho_+(W))^T = (\rho_+(W))^* = (\mathbb{E}[G^{\otimes n} \otimes \bar{G}^{\otimes m}])^* \\ &= \mathbb{E}[(G^*)^{\otimes n} \otimes \overline{G^*}^{\otimes m}] = \mathbb{E}[(G^{-1})^{\otimes n} \otimes \overline{G^{-1}}^{\otimes m}] \\ &= \mathbb{E}[G^{\otimes n} \otimes \bar{G}^{\otimes m}] = \rho_+(W), \end{aligned}$$

where the first identity follows by the definition of ρ_+ , the second follows because ρ_+ has real-valued matrix entries, the fourth follows by linearity, the fifth follows since $G^* = G^{-1}$

when $G \in \text{SU}(N)$, and the sixth follows by the inversion-invariance of Haar measure on compact groups.

Next, for any $\sigma \in \text{S}_n \times \text{S}_m$, we have that

$$\rho_+(\sigma W \sigma^{-1}) = \rho_+(\sigma) \mathbb{E}[S^{\otimes n} \otimes \bar{S}^{\otimes m}] \rho_+(\sigma)^{-1} = \mathbb{E}[S^{\otimes n} \otimes \bar{S}^{\otimes m}].$$

We may thus define

$$\text{Wg}_N^{\text{SU}} := \frac{1}{n!m!} \sum_{\sigma \in \text{S}_n \times \text{S}_m} \sigma \left(\frac{W + W^T}{2} \right) \sigma^{-1} \in \mathcal{B}_{n,m}.$$

Then Wg_N^{SU} satisfies all the required properties. This shows the $\text{SU}(N)$ case. The $\text{SO}(N)$ case follows in the exact same manner. \square

Suppose we have a collection of words $\mathbf{\Gamma} = (\Gamma_1, \dots, \Gamma_n)$ on letters $\{\lambda_1, \dots, \lambda_L\}$, along with a collection of Brauer algebra elements $\boldsymbol{\pi} = (\pi_\ell, \ell \in [L])$, where $\pi_\ell \in \mathcal{B}_{n_\ell+m_\ell}$, where n_ℓ, m_ℓ are the respective number of times $\lambda_\ell, \lambda_\ell^{-1}$ appears in $\mathbf{\Gamma}$. In the $\text{SU}(N)$ case, we may further assume $\pi_\ell \in \mathcal{B}_{n_\ell, m_\ell} \subseteq \mathcal{B}_{n_\ell+m_\ell}$. Now as noted in previous sections, the choice of $\mathbf{\Gamma}$ specifies the exterior connections of the strand diagram, while the choice of $\boldsymbol{\pi}$ specifies the interior connections. Let $\#\text{comp}(\mathbf{\Gamma}, \boldsymbol{\pi})$ be the number of components of the graph one obtains by including both the exterior and exterior connections. This slightly generalizes our previous definition of $\#\text{comp}$ to the case where the π_ℓ are not of the special form of a combined left and right matching.

Proposition 6.75 implies the following proposition about $\text{SU}(N)$ and $\text{SO}(N)$ word expectations. The proof is essentially the same as the discussion in Section 4.2, and thus it is omitted.

Proposition 6.79. Let $\mathbf{\Gamma} = (\Gamma_1, \dots, \Gamma_n)$ be a collection of words on letters $\{\lambda_1, \dots, \lambda_L\}$. Then

$$\begin{aligned} \mathbb{E}[\text{Tr}(G(\mathbf{\Gamma}))] &= \sum_{\boldsymbol{\pi}=(\pi_\ell, \ell \in [L])} \left(\prod_{\ell \in L} \text{Wg}_N^{\text{SU}}(\pi_\ell) \right) N^{\#\text{comp}(\mathbf{\Gamma}, \boldsymbol{\pi})}, \quad G = \text{SU}(N), \\ \mathbb{E}[\text{Tr}(G(\mathbf{\Gamma}))] &= \sum_{\boldsymbol{\pi}=(\pi_\ell, \ell \in [L])} \left(\prod_{\ell \in L} \text{Wg}_N^{\text{SO}}(\pi_\ell) \right) N^{\#\text{comp}(\mathbf{\Gamma}, \boldsymbol{\pi})}, \quad G = \text{SO}(N). \end{aligned}$$

Here, the first sum is over $\pi_\ell \in \mathcal{B}_{n_\ell, m_\ell}$, $\ell \in [L]$, where n_ℓ, m_ℓ are the respective number of times that $\lambda_\ell, \lambda_\ell^{-1}$ appear in $\mathbf{\Gamma}$, and the second sum is over $\pi_\ell \in \mathcal{B}_{n_\ell+m_\ell}$, $\ell \in [L]$.

Remark 6.80. Unlike in the Unitary case, the collection of words $\mathbf{\Gamma}$ is not required to be balanced when $G = \text{SU}(N)$, or unoriented-balanced when $G = \text{SO}(N)$. Ultimately, this is due to the fact that $\mathbb{E}[G^{\otimes n} \otimes \bar{G}^{\otimes m}]$ may be nonzero even if $m \neq n$ when $G = \text{SU}(N)$, and $\mathbb{E}[G^{\otimes n}]$ may be nonzero for odd n when $G = \text{SO}(N)$. Recall Remark 6.55 for an example of the latter. Ultimately, the reason for this is because the elements of $\text{SU}(N), \text{SO}(N)$ must have determinant 1.

Next, we apply Proposition 6.79 to give a surface-sum expression for $SU(N)$ and $SO(N)$ lattice gauge theories. To do this, we need to explain how an arbitrary element of $\mathcal{B}_{n,m}$ or \mathcal{B}_{n+m} can be interpreted as giving a collection of blue faces that are glued in to the existing yellow faces. This contrasts with all the previous cases, where we could restrict to those elements of $\mathcal{B}_{n,n}$ (Unitary) or \mathcal{B}_n (Orthogonal and Symplectic) which are given by a pair of left and right matchings. We cannot do the same here, because the element Wg_N^{SU} (resp. Wg_N^{SO}) may in general give nonzero weight to elements of $\mathcal{B}_{n,m}$ (resp. \mathcal{B}_{n+m}) which are not of this special form. In Figure 60, we explain how to go from the interior connections specified by π to a collection of faces with specified gluings.

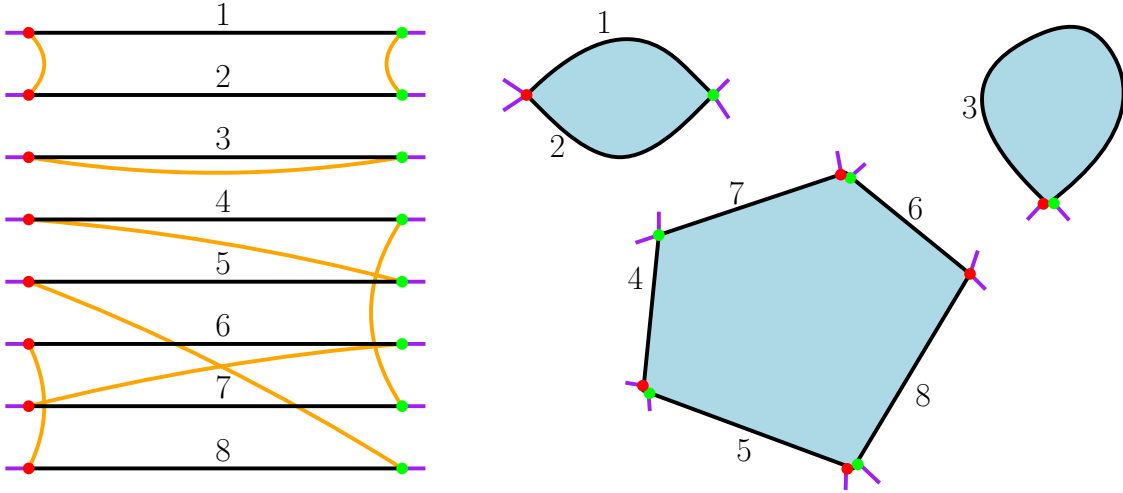

Figure 60: **A priori setting:** Imagine that at first, the orange paths at the left are not present and each black edge represents the boundary of a (not shown) yellow face. In this *a priori* picture every purple segment on the left is connected to a purple segment on the right by a horizontal black line. **Constructing blue faces from orange matching:** Let the orange curves indicate an arbitrary matching of the 16 red and green vertices. There are certain cycles obtained by alternating between orange paths and black paths; if we shrink the orange paths to points, these cycles become the polygons shown on the right, whose interiors are shaded blue. If an orange edge on the left connects a green and red vertex, then the corresponding vertex on the right is colored both red and green. **Gluing interpretation:** If we start with the *a priori* set up and then *glue the blue faces into the diagram* this has the effect of changing the purple-to-purple matching from the black one to the orange one.

For $\pi \in \mathcal{B}_{n+m}$, we define the “face profile” of π to be the collection of faces that one obtains from π , as described in Figure 60, additionally with the coloring of the vertices by red, green, or red and green, as specified in the figure.

Remark 6.81. The invariance of Wg_N^{SU} under conjugation implies that it is a function of the face profile of $\pi \in \mathcal{B}_{n,m} \subseteq \mathcal{B}_{n+m}$, and similarly the invariance of Wg_N^{SO} under conjugation implies that it is a function of the face profile of $\pi \in \mathcal{B}_{n+m}$. To see this, note that invariance under conjugation is the same as invariance under permutation of the strands (where in the $SU(N)$ case, we mean invariance under separate permutations of the top right-directed

strands and bottom left-directed strands). If π, π' have the same face profile, then there exists a permutation of the strands which takes one to the other.

Put another way, starting only from the blue faces in Figure 60, we may reconstruct a matching π' which will be related to the displayed orange matching by a reflection and permutation of the strands. The vertices of the blue face which are red and green indicate that the corresponding orange edge connects a left vertex to a right vertex, while vertices which are only red or only green indicate that the corresponding orange matching edge connects same-side vertices.

We now make the following definition which captures the types of surfaces that one obtains from the gluing procedure described in Figure 60.

Definition 6.82 (Flexible semi-folded maps). Consider a pair (\mathcal{M}, ϕ) where \mathcal{M} is a planar (or higher genus) map and $\phi : \mathcal{M} \rightarrow \Lambda$ is a map from the edges of \mathcal{M} to the edges of Λ , and from the faces of \mathcal{M} to the plaquettes of Λ . We call this pair a **flexible semi-folded map** if the following hold:

1. The dual graph of \mathcal{M} is bipartite. The faces of \mathcal{M} in one partite class are designated as “edge-faces” (shown blue in figures) and those in the other class are called “plaquette-faces” (shown yellow in figures).
2. ϕ maps each plaquette-face of \mathcal{M} isometrically *onto* a plaquette in \mathcal{P} .
3. ϕ maps each edge-face of \mathcal{M} onto a single edge of Λ .

Remark 6.83. Comparing the definitions of flexible semi-folded map and semi-folded map, the main difference is that in the flexible case, ϕ is not necessarily a graph homomorphism. See Figures 61 and 62 for examples and intuition.

In anticipation of the eventual application to lattice gauge theory, now suppose that the letters $\{\lambda_1, \dots, \lambda_L\}$ are edges of the lattice Λ . In this case, the preceding discussion shows that the pair $(\mathbf{\Gamma}, \boldsymbol{\pi})$ is equivalent to a flexible semi-folded map (\mathcal{M}, ψ) .

Definition 6.84. Let $s = (\ell_1, \dots, \ell_n)$ be a string in Λ . Let $K : \mathcal{P} \rightarrow \mathbb{N}$. Define $\text{FSFM}_{\text{SU}}(s, K)$ to be the set of flexible semi-folded maps (\mathcal{M}, ψ) that one can obtain when there are $K(p)$ copies of the plaquette p , for each $p \in \mathcal{P}$. That is, if we let $\mathbf{\Gamma}(K)$ be the collections of words consisting of s along with $K(p)$ copies of p for each $p \in \mathcal{P}$, then $\text{FSFM}_{\text{SU}}(s, K)$ is the set of flexible semi-folded maps that one may obtain by ranging over $\boldsymbol{\pi} = (\pi_e, e \in E_{\Lambda}^+)$, where $\pi_e \in \mathcal{B}_{n_e(+), n_e(-)}$, using our correspondence between $(\mathbf{\Gamma}(K), \boldsymbol{\pi}) \leftrightarrow (\mathcal{M}, \psi)$. Here, $n_e(+), n_e(-)$ are the respective number of times that e, e^{-1} appear in $\mathbf{\Gamma}(K)$. Let

$$\text{FSFM}_{\text{SU}}(s) := \bigsqcup_{K: \mathcal{P} \rightarrow \mathbb{N}} \text{FSFM}_{\text{SU}}(s, K).$$

For $(\mathcal{M}, \psi) \in \text{FSFM}_{\text{SU}}(s)$ and $e \in E_{\Lambda}$, let $\mu_e(\psi)$ be the profile of edge-faces of (\mathcal{M}, ψ) at the edge e .

Define $\text{FSFM}_{\text{SO}}(s, K)$ and $\text{FSFM}_{\text{SO}}(s)$ in the same way, except we only require $\pi_e \in \mathcal{B}_{n_e(+)+n_e(-)}$ for each e .

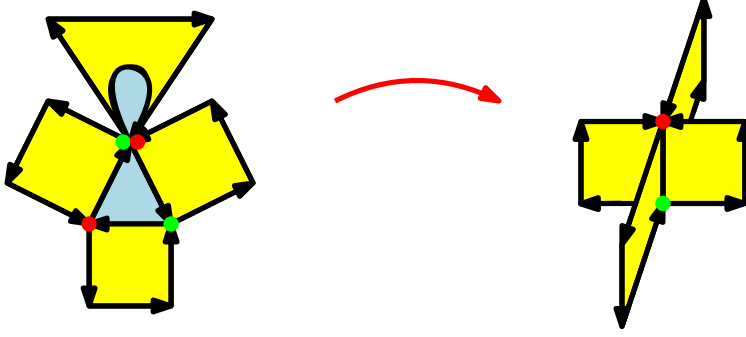

Figure 61: **Flexible semi-folded map example:** Shown left is part of an oriented planar map. In a flexible semi-folded map, the embedding function ψ maps directed edges of the map to directed edges of the lattice, but it is not required that ψ extends to a single-valued function on vertices of the map. Here the edges of the blue triangle and blue 1-gon all map to the red-green edge on the right; the vertex shared by the triangle and 1-gon is colored both red and green to illustrate that it does not map to a single vertex on the right. Recall that when $U(N)$ is replaced by $O(N)$ the corresponding surfaces become *non-orientable*. When $U(N)$ or $O(N)$ is replaced by $SU(N)$ or $SO(N)$ the corresponding surfaces become *flexible* in the sense illustrated here.

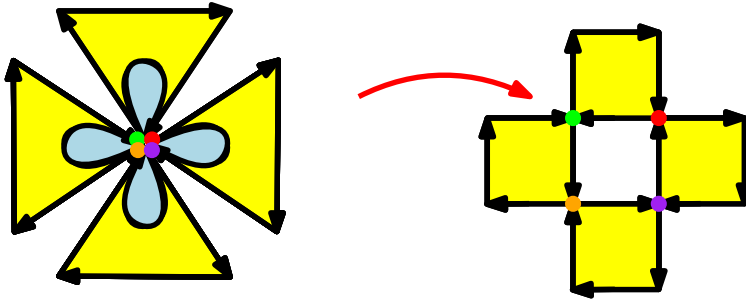

Figure 62: **Flexible semi-folded map example:** In a flexible semi-folded map, a single vertex in the map (left) can in principle correspond to several vertices in the lattice (right). But each plaquette (directed edge) on the left has a uniquely defined image plaquette (directed edge) on the right, and the boundary edges of any single blue face on the left all map to the same undirected blue edge on the right. In some sense, the image of a single vertex on the left is a closed cycle on the right, because as one “moves around the vertex on the left clockwise” one passes through a sequence of plaquette corners whose images on the right trace a cycle (possibly with some repeated vertices).

Definition 6.85. Let $n, m \geq 0$. Define the normalized Weingarten function

$$\begin{aligned} \overline{Wg}_N^{\text{SU}}(\pi) &:= N^{n+m-\#\text{cycles}(\pi)} Wg_N^{\text{SU}}(\pi), \quad \pi \in \mathcal{B}_{n,m}, \\ \overline{Wg}_N^{\text{SO}}(\pi) &:= N^{n-\#\text{cycles}(\pi)} Wg_N^{\text{SO}}(\pi), \quad \pi \in \mathcal{B}_n \end{aligned}$$

where $\#\text{cycles}(\pi)$ is the number of faces in the face profile of π .

We can now state the following theorem which expresses Wilson loop expectations in $SU(N)$ lattice gauge theory as sums over flexible semi-folded maps.

Theorem 6.86. *Let $s = (\ell_1, \dots, \ell_n)$ be a string. For $SU(N)$ lattice gauge theory, we have that*

$$\langle W_s \rangle_{\Lambda, \beta} = Z_{\Lambda, \beta}^{-1} \sum_{(\mathcal{M}, \psi) \in \text{FSFM}_{SU(s)}} \frac{\beta^{\text{area}(\mathcal{M}, \psi)}}{(\psi^{-1})!} \prod_{e \in E_\Lambda} \overline{W}_N^{\text{SU}}(\mu_e(\psi)) N^{\chi(M) - 2n}.$$

For $SO(N)$ lattice gauge theory, we have that

$$\langle W_s \rangle_{\Lambda, \beta} = Z_{\Lambda, \beta}^{-1} \sum_{(\mathcal{M}, \psi) \in \text{FSFM}_{SO(s)}} \frac{\beta^{\text{area}(\mathcal{M}, \psi)}}{(\psi^{-1})!} \prod_{e \in E_\Lambda} \overline{W}_N^{\text{SO}}(\mu_e(\psi)) N^{\chi(M) - 2n}.$$

6.2.1 Makeenko-Migdal/Master loop/Schwinger-Dyson equation

To obtain the single-strand Makeenko-Migdal/Master loop/Schwinger-Dyson equation, we will need to modify the previous argument for $U(N), O(N), Sp(N/2)$, because in those cases we had the strand-by-strand exploration, while in the $SU(N)$ and $SO(N)$ cases we do not. Ultimately, this is due to the fact that when $G = SU(N), SO(N)$, there is some nonzero contribution from the event that all exploration eras do not end by time T (even when we send $T \rightarrow \infty$). On the other hand, the delicate cancellation properties that we took advantage of when $G = U(N), O(N), Sp(N/2)$ were only on the event that all exploration eras have ended. Thus when $G = SU(N), SO(N)$, we cannot expect that the same strand-by-strand exploration will suffice – in particular, the key property of the strand-by-strand exploration (Propositions 4.5 and 6.42) no longer holds for $SU(N), SO(N)$.

We begin our alternate approach by introducing analogs of Jucys-Murphy elements for the Brauer and walled Brauer algebras. See [Naz96, JK20] for more discussion on these elements.

Definition 6.87. Let $n \geq 1$. Define the Brauer algebra elements $x_1, \dots, x_n \in \mathcal{B}_n$ by

$$x_k := J_k - \sum_{i=1}^{k-1} \langle k \ i \rangle = \sum_{i=1}^{k-1} ((k \ i) - \langle k \ i \rangle), \quad k \in [n].$$

These elements are the generalizations of the Jucys-Murphy elements for the Brauer algebra. In particular, they are mutually commuting (see [Naz96, Corollary 2.2]).

Additionally, let $m \geq 1$. Define the walled Brauer algebra elements $z_1, \dots, z_{n+m} \in \mathcal{B}_{n,m}$ by

$$z_k := \begin{cases} \sum_{i=1}^{k-1} \langle k \ i \rangle - \sum_{i=n+1}^{n+m} \langle k \ i \rangle & k \in [n] \\ \sum_{i=n+1}^{k-1} \langle k \ i \rangle & k \in (n : n+m). \end{cases}$$

These elements are the generalizations of the Jucys-Murphy elements for the walled Brauer algebra. In particular, they are mutually commuting (see [JK20, Proposition 2.6]).

Lemma 6.88. Let $Z := z_1 + \dots + z_{n+m}$ for brevity. For $G = SU(N)$, we have that

$$\mathbb{E}[B_T^{\otimes n} \otimes \overline{B}_T^{\otimes m}] = e^{\frac{(n-m)^2}{2N^2} T} e^{-\frac{n+m}{2} T} e^{-\frac{T}{N} \rho_+(Z)}$$

$$= e^{\frac{(n-m)^2}{2N^2}T} e^{-\frac{n+m}{2}T} e^{-\frac{T}{N}\rho_+(z_n)} e^{-\frac{T}{N}\rho_+(Z-z_n)}.$$

Let $X := x_1 + \cdots + x_n$ for brevity. For $G = \text{SO}(N)$, we have that

$$\begin{aligned} \mathbb{E}[B_T^{\otimes n}] &= e^{-\frac{n}{2}(1-\frac{1}{N})T} e^{-\frac{T}{N}X} \\ &= e^{-\frac{n}{2}(1-\frac{1}{N})T} e^{-\frac{T}{N}\rho_+(x_n)} e^{-\frac{T}{N}\rho_+(X-x_n)} \end{aligned}$$

Proof. In both cases, the second identity follows from the first by mutual commutativity of the Jucys-Murphy elements. The first identity for $G = \text{SU}(N)$ (resp. $\text{SO}(N)$) follows by Proposition 6.78 (resp. 6.37) and an explicit Poisson calculation. \square

Remark 6.89. In terms of our Poisson point process, this lemma has the following interpretation: we may first explore all points involving the top strand, and then all points which do not involve the top strand.

Definition 6.90. Let $\Sigma_{\text{SU}}^{\text{top}}(T) \subseteq \Sigma_{\text{SU}}(T)$ be the process defined by keeping only those points which involve the top strand. Define $\Sigma_{\text{SU}}^{\text{rest}}$ to be the complement of $\Sigma_{\text{SU}}^{\text{top}}$, i.e. the process defined by keeping only those points which do not involve the top strand. Define $\Sigma_{\text{SO}}^{\text{top}}, \Sigma_{\text{SO}}^{\text{rest}}$ in the same manner.

Remark 6.91. By Poisson thinning, $\Sigma_{\text{SU}}^{\text{top}}$ and $\Sigma_{\text{SU}}^{\text{rest}}$ are independent Poisson processes.

By Lemma 6.88 and explicit calculation, we have the following identity, which states Lemma 6.88 in terms of our Poisson point process. The proof is omitted.

Lemma 6.92. For $G = \text{SU}(N)$, we have that

$$\mathbb{E}[B_T^{\otimes n} \otimes \bar{B}_T^{\otimes m}] = e^{-\frac{n+m}{2}(1+\frac{1}{N^2})T} \rho_+ \left(e^{2(n+m-1)T} \mathbb{E}[F_{\text{SU}}(\Sigma_{\text{SU}}^{\text{top}}(T))] e^{(n+m-1)^2T} \mathbb{E}[F_{\text{SU}}(\Sigma_{\text{SU}}^{\text{rest}}(T))] \right).$$

For $G = \text{SO}(N)$, we have that

$$\mathbb{E}[B_T^{\otimes n}] = e^{-\frac{n}{2}(1-\frac{1}{N})T} \rho_+ \left(e^{2(n-1)T} \mathbb{E}[F(\Sigma_{\text{SO}}^{\text{top}}(T))] e^{2\binom{n-1}{2}T} \mathbb{E}[F(\Sigma_{\text{OS}}^{\text{rest}}(T))] \right).$$

Remark 6.93. In the above, when $G = \text{SU}(N)$ we choose to split the exponential prefactor $(n+m)^2T = (2(n+m)-1)T + (n+m-1)^2T$, since $2(n+m)-1$ is the number of independent rate 1 Poisson processes contributing to $\Sigma_{\text{SU}}^{\text{top}}(T)$, and $(n+m-1)^2$ is the number of independent rate 1 Poisson processes contributing to $\Sigma_{\text{SU}}^{\text{rest}}(T)$. Similar considerations hold when $G = \text{SO}(N)$.

Notation 6.94. For notational brevity in what follows, define

$$\begin{aligned} X_{\text{SU}}(T) &:= e^{-\frac{1}{2}(1+\frac{1}{N^2})T} e^{(2(n+m)-1)T} \mathbb{E}[F(\Sigma_{\text{SU}}^{\text{top}}(T))] \in \mathcal{B}_{n,m}, \\ Y_{\text{SU}}(T) &:= e^{-\frac{n+m-1}{2}(1+\frac{1}{N^2})T} e^{(n+m-1)^2T} \mathbb{E}[F(\Sigma_{\text{SU}}^{\text{rest}}(T))] \in \mathcal{B}_{n,m}, \\ X_{\text{SO}}(T) &:= e^{-\frac{1}{2}(1-\frac{1}{N})T} e^{2(n-1)T} \mathbb{E}[F(\Sigma_{\text{SO}}^{\text{top}}(T))] \in \mathcal{B}_n, \\ Y_{\text{SO}}(T) &:= e^{-\frac{n-1}{2}(1-\frac{1}{N})T} e^{2\binom{n-1}{2}T} \mathbb{E}[F(\Sigma_{\text{OS}}^{\text{rest}}(T))] \in \mathcal{B}_n. \end{aligned}$$

By Lemma 6.92, we have that

$$\begin{aligned}\mathbb{E}[B_T^{\otimes n} \otimes \bar{B}_T^{\otimes m}] &= \rho_+(X_{\text{SU}}(T)Y_{\text{SU}}(T)), \quad G = \text{SU}(N) \\ \mathbb{E}[B_T^{\otimes n}] &= \rho_+(X_{\text{SO}}(T)Y_{\text{SO}}(T)), \quad G = \text{SO}(N).\end{aligned}\tag{6.8}$$

The starting point to deriving an eventual recursion for $\text{SU}(N)$ or $\text{SO}(N)$ Haar measure is the following recursion for X .

Lemma 6.95. We have that

$$\begin{aligned}X_{\text{SU}}(T) &= e^{-\frac{1}{2}(1+\frac{1}{N^2})T} + \left(\frac{n-m}{N^2} - \frac{z_n}{N}\right) \int_0^T du e^{-\frac{1}{2}(1+\frac{1}{N^2})u} X_{\text{SU}}(T-u), \\ X_{\text{SO}}(T) &= e^{-\frac{1}{2}(1-\frac{1}{N})T} - \frac{x_n}{N} \int_0^T du e^{-\frac{1}{2}(1-\frac{1}{N})u} X_{\text{SO}}(T-u).\end{aligned}$$

Proof. This follows by considering the time of the first point in $\Sigma_{\text{SU}}^{\text{top}}(T)$ (resp. $\Sigma_{\text{SO}}^{\text{top}}(T)$). \square

For $\bullet \in \{\text{SU}, \text{SO}\}$, if we substitute the identities given by Lemma 6.95 into $X_{\bullet}(T)Y_{\bullet}(T)$, the term $X_{\bullet}(T-u)Y_{\bullet}(T)$ for $U \in [0, T]$ appears. The following lemma interprets this term as an appropriate Brownian motion expectation.

Lemma 6.96. For any $0 \leq u \leq T$, we have that

$$\begin{aligned}\rho_+(X_{\text{SU}}(T-u)Y_{\text{SU}}(T)) &= \mathbb{E}[(B_T B_u^{-1}) \otimes B_T^{\otimes(n-1)} \otimes \bar{B}_T^{\otimes m}], \\ \rho_+(X_{\text{SO}}(T-u)Y_{\text{SO}}(T)) &= \mathbb{E}[(B_T B_u^{-1}) \otimes B_T^{\otimes(n-1)}].\end{aligned}$$

Proof. We only prove the $\text{SU}(N)$ case as the $\text{SO}(N)$ is very similar. We may write

$$(B_T B_u^{-1}) \otimes B_T^{\otimes(n-1)} \otimes \bar{B}_T^{\otimes m} = \left((B_T B_u^{-1})^{\otimes n} \otimes \overline{B_T B_u^{-1}}^{\otimes m} \right) (I \otimes B_u^{\otimes(n-1)} \otimes \bar{B}_u^{\otimes m}).$$

Since B_u and $B_T B_u^{-1}$ are independent, upon taking expectations we obtain

$$\begin{aligned}\mathbb{E}[(B_T B_u^{-1}) \otimes B_T^{\otimes(n-1)} \otimes \bar{B}_T^{\otimes m}] &= \left(\mathbb{E}[(B_T B_u^{-1})^{\otimes n} \otimes \overline{B_T B_u^{-1}}^{\otimes m}] \right) (I \otimes \mathbb{E}[B_u^{\otimes(n-1)} \otimes \bar{B}_u^{\otimes m}]) \\ &= \mathbb{E}[B_{T-u}^{\otimes n} \otimes \bar{B}_{T-u}^{\otimes m}] (I \otimes \mathbb{E}[B_u^{\otimes(n-1)} \otimes \bar{B}_u^{\otimes m}]).\end{aligned}$$

Writing $Z = z_1 + \dots + z_{n+m}$ for brevity, we have by Lemma 6.88 that

$$\begin{aligned}\mathbb{E}[B_{T-u}^{\otimes n} \otimes \bar{B}_{T-u}^{\otimes m}] &= e^{\frac{(n-m)^2}{2N^2}(T-u)} e^{-\frac{n+m}{2}(T-u)} e^{-\frac{T-u}{N}\rho_+(Z)}, \\ I \otimes \mathbb{E}[B_u^{\otimes(n-1)} \otimes \bar{B}_u^{\otimes m}] &= e^{\frac{(n-m-1)^2}{2N^2}u} e^{-\frac{n+m-1}{2}u} e^{-\frac{u}{N}\rho_+(Z-z_n)}.\end{aligned}$$

Combining, we obtain (using the mutual commutativity of z_1, \dots, z_{n+m})

$$\mathbb{E}[(B_T B_u^{-1}) \otimes B_T^{\otimes(n-1)}] = e^{\frac{2(n-m)-1}{2N^2}(T-u)} e^{-\frac{1}{2}(T-u)} e^{-\frac{T-u}{N}\rho_+(z_n)} e^{\frac{(n-m-1)^2}{2N^2}u} e^{-\frac{n+m-1}{2}u} e^{-\frac{u}{N}\rho_+(Z-z_n)}.$$

By an explicit calculation, we have that the right hand side above is exactly

$$\rho_+ \left(e^{-\frac{1}{2}(1+\frac{1}{N^2})(T-u)} e^{(2(n+m)-1)(T-u)} \mathbb{E}[F(\Sigma_{\text{SU}}^{\text{top}}(T-u))] e^{-\frac{n+m-1}{2}(1+\frac{1}{N^2})T} e^{(n+m-1)^2 T} \mathbb{E}[F(\Sigma_{\text{SU}}^{\text{rest}}(T))] \right),$$

which is exactly $\rho_+(X_{\text{SU}}(T-u)Y_{\text{SU}}(T))$, and thus the desired result follows. \square

Next, we show that the Brownian motion expectation which appears in Lemma 6.96 has a nice limit as $T \rightarrow \infty$. We prove this for more general G than needed, as the argument is exactly the same.

Lemma 6.97. Let $G = \mathrm{U}(N), \mathrm{SU}(N), \mathrm{SO}(N), \mathrm{Sp}(N/2)$. For any $u \geq 0$, we have that

$$\lim_{T \rightarrow \infty} \mathbb{E}[(B_T B_u^{-1}) \otimes B_T^{\otimes(n-1)} \otimes \bar{B}_T^{\otimes m}] = e^{\frac{c_G}{2}u} \mathbb{E}[G^{\otimes n} \otimes \bar{G}^{\otimes m}].$$

Proof. We may write

$$(B_T B_u^{-1}) \otimes B_T^{\otimes(n-1)} \otimes \bar{B}_T^{\otimes m} = (B_T^{\otimes n} \otimes \bar{B}_T^{\otimes m}) (B_u^{-1} \otimes I^{\otimes(n+m-1)}).$$

For fixed u , the conditional distribution $B_T \mid B_u$ converges to normalized Haar measure on G as $T \rightarrow \infty$. We thus obtain

$$\lim_{T \rightarrow \infty} \mathbb{E}[(B_T B_u^{-1}) \otimes B_T^{\otimes(n-1)} \otimes \bar{B}_T^{\otimes m}] = \mathbb{E}[G^{\otimes n} \otimes \bar{G}^{\otimes m}] (\mathbb{E}[B_u^{-1}] \otimes I^{\otimes(n+m-1)}).$$

By an explicit calculation, we have that

$$\mathbb{E}[B_u^{-1}] = \mathbb{E}[B_u^*] = (\mathbb{E}[B_u])^* = (e^{\frac{c_G}{2}u} I)^* = e^{\frac{c_G}{2}u} I.$$

The desired result now follows. \square

Now by combining the previous few preliminary results, we obtain the following recursions for expectations with respect to $\mathrm{SU}(N)$ or $\mathrm{SO}(N)$ Haar measure.

Proposition 6.98. For $n \geq 1, m \geq 0$, we have that

$$\begin{aligned} \mathbb{E}[G^{\otimes n} \otimes \bar{G}^{\otimes m}] &= \rho_+ \left(\frac{n-m}{N^2} - \frac{z_n}{N} \right) \mathbb{E}[G^{\otimes n} \otimes \bar{G}^{\otimes m}], \quad G = \mathrm{SU}(N), \\ \left(1 - \frac{1}{N} \right) \mathbb{E}[G^{\otimes n}] &= -\frac{\rho_+(x_n)}{N} \mathbb{E}[G^{\otimes n}], \quad G = \mathrm{SO}(N). \end{aligned}$$

Proof. We prove the $\mathrm{SU}(N)$ case as the $\mathrm{SO}(N)$ is very similar. For brevity, let $E_T(n, m) = \mathbb{E}[B_T^{\otimes n} \otimes \bar{B}_T^{\otimes m}]$. Combining equation (6.8) with Lemma 6.95, we obtain

$$E_T(n, m) = e^{-\frac{1}{2}(1+\frac{1}{N^2})T} \rho_+(Y_{\mathrm{SU}}(T)) + \left(\frac{n-m}{N^2} - \frac{\rho_+(z_n)}{N} \right) \int_0^T e^{-\frac{1}{2}(1+\frac{1}{N^2})u} \rho_+(X_{\mathrm{SU}}(T-u) Y_{\mathrm{SU}}(T)).$$

Note that $\rho_+(Y_{\mathrm{SU}}(T)) = I \otimes E_T(n-1, m)$, which is $O(1)$ as $T \rightarrow \infty$. Thus as $T \rightarrow \infty$, the first term in the right hand side above is $o(1)$. Combining this with Lemmas 6.96 and 6.97, we obtain upon taking $T \rightarrow \infty$,

$$\mathbb{E}[G^{\otimes n} \otimes \bar{G}^{\otimes m}] = \left(\frac{n-m}{N^2} - \frac{\rho_+(z_n)}{N} \right) \int_0^\infty du e^{-\frac{1}{2}(1+\frac{1}{N^2})u} e^{\frac{c_{\mathrm{su}(N)}}{2}u} \mathbb{E}[G^{\otimes n} \otimes \bar{G}^{\otimes m}].$$

To finish, we use that $c_{\mathrm{su}(N)} = -1 + \frac{1}{N^2}$. \square

Definition 6.99. Let $\mathbf{\Gamma} = (\Gamma_1, \dots, \Gamma_k)$ be a collection of words on $\{\lambda_1, \dots, \lambda_L\}$. For each letter λ_i , $i \in [L]$, let $t(\lambda_i)$ be equal to the number of occurrences of λ_i in $\mathbf{\Gamma}$ minus the number of occurrences of λ_i^{-1} in $\mathbf{\Gamma}$. Let $t(\lambda_i^{-1}) := -t(\lambda_i)$. Given a location (i, j) of $\mathbf{\Gamma}$, let $t(i, j) := t(\lambda_k^s)$, where λ_k^s , $s \in \{\pm 1\}$, is the letter at location (i, j) .

Proposition 6.98 leads immediately (by similar considerations as in the proof of Proposition 5.2) to the following recursions for expectations of words. The proof is omitted. In the following, recall the various string operations defined in Definitions 5.1 and 6.69.

Proposition 6.100 (Single-location $SU(N)$ and $SO(N)$ word recursion). Let $\mathbf{\Gamma} = (\Gamma_1, \dots, \Gamma_k)$ be a collection of words on $\{\lambda_1, \dots, \lambda_L\}$. For any location (i, j) of $\mathbf{\Gamma}$, we have that for $G = SU(N)$,

$$\begin{aligned} \left(1 - \frac{t(i, j)}{N^2}\right) \mathbb{E}[\text{tr}(G(\mathbf{\Gamma}))] = & - \sum_{\mathbf{\Gamma}' \in \mathcal{S}_+((i, j), \mathbf{\Gamma})} \mathbb{E}[\text{tr}(G(\mathbf{\Gamma}'))] + \sum_{\mathbf{\Gamma}' \in \mathcal{S}_-((i, j), \mathbf{\Gamma})} \mathbb{E}[\text{tr}(G(\mathbf{\Gamma}'))] \\ & - \frac{1}{N^2} \sum_{\mathbf{\Gamma}' \in \mathcal{M}_+^U((i, j), \mathbf{\Gamma})} \mathbb{E}[\text{tr}(G(\mathbf{\Gamma}'))] + \frac{1}{N^2} \sum_{\mathbf{\Gamma}' \in \mathcal{M}_-^U((i, j), \mathbf{\Gamma})} \mathbb{E}[\text{tr}(G(\mathbf{\Gamma}'))]. \end{aligned}$$

For $G = SO(N)$, we have that

$$\begin{aligned} \left(1 - \frac{1}{N}\right) \mathbb{E}[\text{tr}(G(\mathbf{\Gamma}))] = & - \sum_{\mathbf{\Gamma}' \in \mathcal{S}_+((i, j), \mathbf{\Gamma})} \mathbb{E}[\text{tr}(G(\mathbf{\Gamma}'))] + \sum_{\mathbf{\Gamma}' \in \mathcal{S}_-((i, j), \mathbf{\Gamma})} \mathbb{E}[\text{tr}(G(\mathbf{\Gamma}'))] \\ & - \frac{1}{N^2} \sum_{\mathbf{\Gamma}' \in \mathcal{M}_+((i, j), \mathbf{\Gamma})} \mathbb{E}[\text{tr}(G(\mathbf{\Gamma}'))] + \frac{1}{N^2} \sum_{\mathbf{\Gamma}' \in \mathcal{M}_-((i, j), \mathbf{\Gamma})} \mathbb{E}[\text{tr}(G(\mathbf{\Gamma}'))] \\ & - \frac{1}{N} \sum_{\mathbf{\Gamma}' \in \mathcal{T}_+((i, j), \mathbf{\Gamma})} \mathbb{E}[\text{tr}(G(\mathbf{\Gamma}'))] + \frac{1}{N} \sum_{\mathbf{\Gamma}' \in \mathcal{T}_-((i, j), \mathbf{\Gamma})} \mathbb{E}[\text{tr}(G(\mathbf{\Gamma}'))] \end{aligned}$$

By applying Proposition 6.100 to lattice Yang-Mills theories, we may obtain the single-location $SU(N)$ and $SO(N)$ Makeenko-Migdal/Master loop/Schwinger-Dyson equation. The proof is entirely analogous to the proof of the $U(N)$ Makeenko-Migdal/Master loop/Schwinger-Dyson equation (Theorem 5.6) using the $U(N)$ word recursion (Proposition 5.2), and thus it is omitted. Before we state the theorem, we first define the following new string operation which appears for $SU(N)$.

Definition 6.101 (Expansion). Let $s = (\ell_1, \dots, \ell_n)$ be a string. Let (k, i) be a location in s . We define the sets of positive and negative expansions $\mathbb{E}_+((k, i), s)$ and $\mathbb{E}_-((k, i), s)$ as follows. Denote by e the oriented edge of the lattice at location (k, i) in s .

The set of positive expansions $\mathbb{E}_+((k, i), s)$ is the set of all possible strings s' which can be obtained by adding an oriented plaquette $p \in \mathcal{P}$ which contains e^{-1} to the collection of loops s .

The set of negative expansions $\mathbb{E}_-((k, i), s)$ is the set of all possible strings s' which can be obtained by adding an oriented plaquette $p \in \mathcal{P}$ which contains e to the collection of loops s .

Theorem 6.102 (Single-location $SU(N)$ and $SO(N)$ Makeenko-Migdal/Master loop/Schwinger-Dyson equation). *Let $s = (\ell_1, \dots, \ell_n)$ be a string. Let (k, i) be a location in s . For $SU(N)$ lattice Yang-Mills theory, we have that*

$$\begin{aligned} \left(1 - \frac{t(k, i)}{N^2}\right)\phi(s) = & - \sum_{s' \in \mathbb{S}_+((k, i), s)} \phi(s') + \sum_{s' \in \mathbb{S}_-((k, i), s)} \phi(s') \\ & - \frac{1}{N^2} \sum_{s' \in \mathbb{M}_+((k, i), s)} \phi(s') + \frac{1}{N^2} \sum_{s' \in \mathbb{M}_-((k, i), s)} \phi(s') \\ & - \beta \sum_{s' \in \mathbb{D}_+((k, i), s)} \phi(s') + \beta \sum_{s' \in \mathbb{D}_-((k, i), s)} \phi(s') \\ & - \beta \sum_{s' \in \mathbb{E}_+((k, i), s)} \phi(s') + \beta \sum_{s' \in \mathbb{E}_-((k, i), s)} \phi(s'). \end{aligned}$$

For $SO(N)$ lattice Yang-Mills theory, we have that

$$\begin{aligned} \left(1 - \frac{1}{N}\right)\phi(s) = & - \sum_{s' \in \mathbb{S}_+((k, i), s)} \phi(s') + \sum_{s' \in \mathbb{S}_-((k, i), s)} \phi(s') \\ & - \frac{1}{N^2} \sum_{s' \in \mathbb{M}_+((k, i), s)} \phi(s') + \frac{1}{N^2} \sum_{s' \in \mathbb{M}_-((k, i), s)} \phi(s') \\ & - \frac{1}{N} \sum_{s' \in \mathbb{T}_+((k, i), s)} \phi(s') + \frac{1}{N} \sum_{s' \in \mathbb{T}_-((k, i), s)} \phi(s') \\ & - 2\beta \sum_{s' \in \mathbb{D}_+((k, i), s)} \phi(s') + 2\beta \sum_{s' \in \mathbb{D}_-((k, i), s)} \phi(s'). \end{aligned}$$

Remark 6.103. Observe that the $SO(N)$ Makeenko-Migdal/Master loop/Schwinger-Dyson equation is exactly the $O(N)$ one. This is natural since $O(N)$ Brownian motion is essentially $SO(N)$ Brownian motion (recall Remark 6.29).

7 Open problems

Although lattice gauge theory has been very thoroughly studied in physics, there are many simple ideas about the relationship between random surfaces and Yang-Mills theory that have not been so thoroughly explored on the math side. There is also room for innovation: producing clever variants and toy models whose limits might be easier to describe in terms of continuum random surfaces (including those related to Liouville quantum gravity and conformal field theory). If the ultimate goal is to get a handle on a continuum theory, there is a good deal of flexibility in how one sets up the discrete models that are meant to approximate that theory. We present a series of open problems along those lines, ranging from very general and open-ended to very technical and specific.

1. For which lattice models can we establish a version of the “area law” using the surface sum point of view? Recall that the area law states that the Wilson loop expectation

decays exponentially in the minimal area spanned by the loop, at least for reasonably nice loops; see the definitions and discussion in [Cha19b] about the relationship between the area law and “quark confinement.” Many such results are known (from various points of view) for small β , and these results apply in any dimension $d \geq 2$, see e.g. [OS78] for the proof of the $SU(N)$ area law for small β and general N , and the discussion in [Cha19a] which explains a string-trajectory-based derivation of such a result in the $N \rightarrow \infty$ limit for small β . For general β , the known results are dimension-dependent:

- (a) When $d = 2$ the area law is well-known for general groups for any β [Lév03, Lév10, Lév17].
 - (b) When $d = 3$ and $N = 1$, the area law holds for all β , see [GM81]. Because $U(1)$ is the center of $U(N)$ for general N , this appears to also imply that the $U(N)$ area law holds for all β when $N > 1$, see [Frö79]. It is not known whether the $SU(N)$ area law holds for large β when $N > 1$.
 - (c) When $d = 4$, interestingly enough, the $U(1)$ area law holds for small β but *fails* for large β , see [FS82]. It remains a major open problem to prove the area law for any non-commutative group when β is large, $N \geq 2$ and $d = 4$.
2. For which lattice models can we establish exponential decay of correlations for the Wilson loop traces using the surface sum point of view? This is related to the so-called “mass gap” problem, see e.g. discussion in [Cha19b]. In the settings above, one is usually able to prove exponential decay of correlations in the same settings where one is able to prove the area law. (See [Cha21] for an argument that certain strong forms of exponential decay imply the area law.) In particular, it remains a major open problem to prove exponential decay of correlations for any non-commutative group when β is large, $N \geq 2$ and $d = 4$.
 3. In the $U(N)$ setting, what can we say about the *conditional* law of the surface *given* the number and type of blue plaquettes at each edge? Once the blue plaquettes are fixed, we no longer need to consider the Weingarten function, and the remaining combinatorics are simpler: in fact one obtains precisely the sort of model used to study words in GUE matrices using Wick’s formula [Zvo97]. In this setting all ways of hooking up yellow to blue along edges are allowed and all contribute with the same sign, but there is still a weighting according to the genus, which leads the surface to concentrate around minimal genus configurations in the large N limit. As a simplified model, we could even imagine that we fix the number of blue faces of each type to be exactly the same at each edge. Can we say anything about the scaling limits in this setting? Is the GUE correspondence at all helpful here?
 4. Within a three-dimensional lattice like \mathbb{Z}^3 , one way to try to understand the scaling limit of an oriented random surface (which could become space-filling in the fine mesh limit, with genus tending to infinity) is to try to understand the limit of the “height function” on the dual lattice that changes by ± 1 (depending on orientation) each time one crosses a layer of the surface. Is there a setting in which such a limit can be obtained? The gradient of such a function is in some sense the normal vector field

corresponding to the surface. (It is a flow in which one unit of current is assigned for each face of the surface, in the direction orthogonal to that face; the flow is not divergence free but it is curl-free except along the boundary loops.) Is there a qualitative difference between $N = 1$ and general N in the limit? The $N = 1$ case has been understood by Frölich and Spencer [FS82] and has an interesting β -dependent phase transition (from area law to perimeter law, as mentioned above) that we would not expect to see for larger N .

5. Can we prove anything interesting about the variants in which there are many plaquettes but only three can meet along any given edge? For example \mathcal{L} might be the truncated octahedron tessellation (one example of a tessellation by cells where only three cells ever meet along the same edge, see [SY14]) and \mathcal{P} can be the collection of square and hexagonal faces in the tessellation. If we require that each plaquette appears zero times or once, then the only non-zero terms in the surface expansion involve surface in which either zero or two of the three plaquettes contain each given interior edge (i.e. each edge not on the Wilson loop). In this case the surfaces we obtain are simpler: all of the blue faces are 2-gons and the surfaces are self-avoiding. There is no need to consider the Weingarten function in this simplified setting. We remark that this would be the surface analog of the loop $O(n)$ model, studied for instance in [DCPSS17]. (Requiring the number of copies of a given plaquette to be small—here either 0 or 1—is somehow related to taking a small β in the unrestricted-plaquette-number setting.)
6. Recall that in certain contexts it is enough to consider *connected surfaces*, such as when there is a single Wilson loop and $N \rightarrow \infty$ (recall the discussion just after Corollary 3.11). Are there other contexts in which it is sufficient to consider connected surfaces?
7. A surface sum like the one in Corollary 1.10 includes many terms of both signs. Our intuition is that most of these surfaces somehow “cancel each other out.” For example, there may be local changes one can make to a surface that change the sign of the associated Weingarten product but do not change the genus of the surface. Is there a clean way to group together the surfaces in this sum that makes this cancellation more transparent? One could begin with the case $d = 2$, and aim to show that the surfaces that are not locally flat somehow cancel each other out.
8. Is there a simpler expression (or at least asymptotic expression in the limit of a large number of plaquettes) for the Weingarten function in the case that N is a small integer? Recall that in this case, the sum over representations in (2.5) involves only those corresponding to Young tableaux with at most N rows.
9. What is the most natural way to express the finite- T (i.e. Brownian motion at time T , as in Section 2.1) analog of the Weingarten function and the corresponding random planar maps? Note that adding a few single-edge loops may have a similar effect to switching to finite T . This is because weighting Haar measure on $U(N)$ by a power of the real part of the trace *biases* the measure toward matrices that are near the identity; Brownian motion on a Lie group stopped at a finite time T is also (compared to Haar measure) biased toward matrices that are near the identity.

10. Are there any natural random surface models emerging in the lattice Yang-Mills framework that lead to planar maps similar to those whose limits (can be conjectured to) correspond to Liouville quantum gravity surfaces with $c \in (1, 25)$? Those surfaces are multi-ended and infinite, see e.g. [GHPR20, DG21, APPS22, DG23].
11. There have been many recent results about random planar maps of high genus and/or random hyperbolic planar maps, see, e.g. [ACCR13, Cur16, BL21, BL22, DGZZ22, JL23]. Which of these results can be extended to embedded random planar maps of the type that emerge in our analysis?
12. Can we interpret Wilson loops in terms of Liouville quantum gravity at least in the critical $c = 1$ setting where we have a “ladder graph” and have gauge fixed so that we have the identity on the left and right sides of the ladder, and each yellow plaquette can be treated as a 2-gon (since the left and right edges can be shrunk to points)? Since the yellow plaquettes are all 2-gons, we can interpret them as edges between blue faces: each blue face comes with a “height” (the height of the ladder rung) and its neighboring blue faces have heights that are one unit higher or one unit lower. Essentially one has a planar map of blue faces decorated by a one-dimensional height function, which one might expect to converge to Liouville quantum gravity with parameter $c = 1$ in the $N = \infty$ limit. We note there are some physics connections between the large- N 2D Yang-Mills and $c = 1$ matrix model [MP93] whose double scaling limit is related to the Liouville gravity with matter central charge $c = 1$.
13. Two-dimensional lattice gauge theory can also be reduced to a ladder graph (if one gauge fixes along a spiral, one essentially obtains a ladder) as in the setting of the previous question. But is there any sense in which the Liouville quantum gravity surfaces for $c = 2$ (as mentioned above in the 10th question) can be recovered in these models?
14. What can we learn from models in which there is some correlation between the noise defining distinct edges, so that the analogs of the blue faces are perhaps not mapped to a single edge? In an extreme case, one can take different edges to be perfectly correlated, so that one has the same random matrix at different locations. For example, one could assign the same random matrix to all edges that are parallel to each other, as is done in [EK82].
15. What is the fine-mesh scaling limit of the random surface we obtain when we fix exactly b yellow plaquettes of each type and take $N = \infty$ (so that the surface is simply connected)? Does it look like a continuum random tree (a.k.a. Brownian tree or branched polymer) conditioned to fill out Λ in some even way?
16. We alert the reader that the “spin-foam” constructions in [OP01, Con05] provide another approach for converting non-abelian lattice gauge theory into a statistical physical model. We can then pose a general question: what new properties of lattice Yang-Mills theory and/or its continuum scaling limits can be deduced from the spin-foam perspective?

17. The abelian versions of “spin foam” are simpler and were used e.g. by Frölich and Spencer [FS82] to understand the phase transition structure of $U(1)$ lattice gauge theory. Can an alternative proof of these results be given using the surface expansion described in this paper?
18. Adding extra single-edge faces in both directions has the effect of changing the underlying measure from Haar measure to another conjugation-invariant measure on $U(N)$ (which can be a signed measure if we add associate sign weights to different edge configurations). Can one obtain a natural connection between a signed-measure variant of Yang-Mills theory and the sort of random surfaces that arise in conformal field theory?
19. What can one say about supersymmetric variants of this question? Can a supersymmetric version of Yang-Mills theory be connected to random planar maps whose scaling limits can be understood in terms of Liouville quantum gravity or some other probabilistic continuum random surface model? What about fermionic variants or variants involving Higgs fields? On the latter point, let us remark that the introduction to [CCHS22b] contains a list of references about the lattice Yang-Mills-Higgs model. A configuration in this context assigns a vector to each lattice vertex (in addition to assigning a matrix to each directed edge). In this context, one also considers open Wilson paths (whose endpoints are lattice vertices) in addition to closed Wilson loops.

A Properties of the Orthogonal Weingarten function

In this appendix, we give more detail on why Lemmas 6.9 and 6.38 are true, and in particular why it essentially follows from [Mat13]. Fix $n \geq 1$ even and $\zeta \in \mathbb{C}$. To help the reader, we indicate how to translate between our notation and the notation of [Mat13, Section 2.2.2]. Our ζ translates to z . Our n is the equivalent of $2k$. The subgroup $\mathcal{H}_n \subseteq S_n$ we defined in Definition 6.59 is H_k in [Mat13]. One can show that $|\mathcal{H}_n| = 2^{n/2}(n/2)!$, which translates to $|H_k| = 2^k k!$.

Matsumoto defines the Orthogonal Weingarten function $\text{Wg}^{\text{O}}(\cdot; \zeta)$ as an element of the group algebra $\mathbb{C}[S_n]$. As part of its definition, this element is \mathcal{H}_n bi-invariant, i.e.

$$\text{Wg}^{\text{O}}(h\sigma; \zeta) = \text{Wg}^{\text{O}}(\sigma; \zeta) = \text{Wg}^{\text{O}}(\sigma h; \zeta) \text{ for all } \sigma \in \mathbb{C}[S_n], h \in \mathcal{H}_n. \quad (\text{A.1})$$

The relation between Matsumoto’s definition and our definition via pseudo-inverses is as follows:

$$\text{Wg}_{\zeta}^{\text{O}}(\pi, \pi') = \text{Wg}^{\text{O}}(\sigma_{\pi}^{-1} \sigma_{\pi'}; \zeta), \quad (\text{A.2})$$

where σ_{π} is the permutation associated to π as in Definition 6.12. Here and in the following, we will write $\text{Wg}_{\zeta}^{\text{O}}$ for definition of the Weingarten function as a pseudo-inverse, and $\text{Wg}^{\text{O}}(\cdot; \zeta)$ for Matsumoto’s definition of the Weingarten function as a group algebra element. Now, one can show that the face profile $\ell(\pi, \pi')$ is precisely the coset-type of $\sigma_{\pi}^{-1} \sigma_{\pi'}$ (which is defined in [Mat13, Section 2.2.1]). As mentioned in in [Mat13, Section 2.2.1], two permutations σ, σ' have the same coset-type if and only if they are part of the same double \mathcal{H}_n coset, i.e. $\mathcal{H}_n \sigma \mathcal{H}_n = \mathcal{H}_n \sigma' \mathcal{H}_n$. By the \mathcal{H}_n bi-invariance (A.1), it follows that $\text{Wg}^{\text{O}}(\sigma; \zeta)$ is a

function of the coset-type of σ , and then by (A.2), it follows that $\text{Wg}_\zeta^{\text{O}}(\pi, \pi')$ is a function of the face profile $\ell(\pi, \pi')$ of π, π' . This shows Lemma 6.9.

Next, we discuss Lemma 6.38. Recall we defined (Definition 6.59) $P_{\mathcal{H}_n} = \frac{1}{|\mathcal{H}_n|} \sum_{h \in \mathcal{H}_n} h$. This translates to $(2^k k!)^{-1} \mathbf{1}_k$. The ‘‘zonal spherical function’’ ω^λ from the paper is for us $\chi^{2\lambda} P_{\mathcal{H}_n} \in \mathbb{C}[\mathbb{S}_n]$ (where here $\lambda \vdash \frac{n}{2}$). We have that (by Lemma 6.61, as argued in the proof of Lemma 6.62)

$$P_{\mathcal{H}_n} = P_{\mathcal{H}_n} \sum_{\lambda \vdash \frac{n}{2}} P_{2\lambda}, \quad (\text{A.3})$$

where recall that (equation (6.6)) $P_{2\lambda} = \frac{\chi_{2\lambda}(\text{id})}{n!} \sum_{\sigma \in \mathbb{S}_n} \chi_{2\lambda}(\sigma) \sigma \in \mathbb{C}[\mathbb{S}_n]$.

Next, as in [Mat13], we define for $\lambda \vdash \frac{n}{2}$ the quantity $D_\lambda(\zeta)$ as

$$D_\lambda(\zeta) := \prod_{(i,j) \in \lambda} (\zeta + 2j - i - 1).$$

This quantity relates to Jucys-Murphy elements as follows. Define $X_\varepsilon := (\varepsilon N + J_{n-1})(\varepsilon N + J_{n-3}) \cdots (\varepsilon N + J_1)$.

Lemma A.1. For any $\lambda \vdash \frac{n}{2}$, we have that

$$P_{\mathcal{H}_n} P_{2\lambda} X_\varepsilon = D_\lambda(\varepsilon N) P_{\mathcal{H}_n} P_{2\lambda}. \quad (\text{A.4})$$

Proof. This is proven towards the end of [ZJ09, Section 3]. For the reader’s convenience, we reproduce the argument here. Recalling the discussion of Young’s orthogonal idempotents from Section 6.1.4, we may expand

$$P_{2\lambda} = \sum_{\lambda \in \text{SYT}(2\lambda)} e_T.$$

By [ZJ09, Proposition 4], $P_{\mathcal{H}_n} e_T \neq 0$ implies that T is obtained by the ‘‘doubling’’ procedure described on [ZJ09, Page 7]. As noted in the paper, by direct calculation, for any such T , we have that $e_T X_\varepsilon = D_\lambda(\varepsilon N) e_T$. The desired result now follows by combining these observations. \square

In our notation, Matsumoto defines the Orthogonal Weingarten function as an element $\text{Wg}^{\text{O}}(\cdot; \zeta) \in \mathbb{C}[\mathbb{S}_n]$ given by the formula

$$\text{Wg}^{\text{O}}(\cdot; \zeta) := |\mathcal{H}_n| \sum_{\substack{\lambda \vdash \frac{n}{2} \\ D_\lambda(\zeta) \neq 0}} D_\lambda(\zeta)^{-1} P_{2\lambda} P_{\mathcal{H}_n}. \quad (\text{A.5})$$

This element is \mathcal{H}_n bi-invariant, that is $h \text{Wg}^{\text{O}}(\cdot; \zeta) = \text{Wg}^{\text{O}}(\cdot; \zeta) = \text{Wg}^{\text{O}}(\cdot; \zeta) h$ for all $h \in \mathcal{H}_n$ (these identities are equivalent to (A.1)). The second identity follows since $P_{\mathcal{H}_n} h = P_{\mathcal{H}_n}$ for any $h \in \mathcal{H}_n$. The first identity follows since $P_{2\lambda}$ is central, so that $P_{2\lambda} P_{\mathcal{H}_n} = P_{\mathcal{H}_n} P_{2\lambda}$, combined with $h P_{\mathcal{H}_n} = P_{\mathcal{H}_n}$ for all $h \in \mathcal{H}_n$.

Combining the \mathcal{H}_n bi-invariance with the fact that the collection $(\sigma_\pi, \pi : [n] \rightarrow [n])$ forms a complete set of coset representatives of \mathcal{H}_n as a subgroup of S_n (as mentioned in the beginning of [Mat13, Section 2.2.1]), we may express

$$\text{Wg}^{\text{O}}(\cdot; \zeta) = \sum_{\pi: [n] \rightarrow [n]} \text{Wg}^{\text{O}}(\sigma_\pi; \zeta) \mathcal{H}_n \sigma_\pi.$$

From this, we obtain (using that by definition, \mathcal{H}_n stabilizes π_0 for the first identity, and equation (A.2) for the second)

$$[\pi \ \pi_0] \text{Wg}^{\text{O}}(\cdot; \zeta) = |\mathcal{H}_n| \sum_{\pi': [n] \rightarrow [n]} [\pi \ \pi_0] \sigma_{\pi'} \text{Wg}^{\text{O}}(\sigma_{\pi'}; \zeta) = |\mathcal{H}_n| \sum_{\pi': [n] \rightarrow [n]} [\pi \ \pi'] \text{Wg}^{\text{O}}_\zeta(\pi_0, \pi').$$

On the other hand, inserting equation (A.5), we have the formula

$$[\pi \ \pi_0] \text{Wg}^{\text{O}}(\cdot; \zeta) = |\mathcal{H}_n| [\pi \ \pi_0] \sum_{\substack{\lambda \vdash \frac{n}{2} \\ D_\lambda(z) \neq 0}} D_\lambda(\zeta)^{-1} P_{2\lambda} P_{\mathcal{H}_n}.$$

Upon equating the previous two identities (and using that $P_{2\lambda}$ is central), we obtain

$$\sum_{\pi': [n] \rightarrow [n]} \text{Wg}^{\text{O}}_\zeta(\pi_0, \pi') [\pi \ \pi'] = [\pi \ \pi_0] \sum_{\substack{\lambda \vdash \frac{n}{2} \\ D_\lambda(\zeta) \neq 0}} D_\lambda(\zeta)^{-1} P_{\mathcal{H}_n} P_{2\lambda}.$$

Setting $\zeta = \varepsilon N$ and applying the representation ρ_ε to both sides of the identity, we obtain

$$\sum_{\pi': [n] \rightarrow [n]} \text{Wg}^{\text{O}}_{\varepsilon N}(\pi_0, \pi') \rho_\varepsilon([\pi \ \pi']) = \rho_\varepsilon([\pi \ \pi_0]) \sum_{\substack{\lambda \vdash \frac{n}{2} \\ D_\lambda(\varepsilon N) \neq 0}} D_\lambda(\varepsilon N)^{-1} \rho_\varepsilon(P_{\mathcal{H}_n}) \rho_\varepsilon(P_{2\lambda}). \quad (\text{A.6})$$

We now claim that

$$\sum_{\substack{\lambda \vdash \frac{n}{2} \\ D_\lambda(\varepsilon N) \neq 0}} D_\lambda(\varepsilon N)^{-1} \rho_\varepsilon(P_{\mathcal{H}_n}) \rho_\varepsilon(P_{2\lambda}) = \sum_{\lambda \vdash \frac{n}{2}} \rho_\varepsilon(P_{\mathcal{H}_n}) \rho_\varepsilon(P_{2\lambda}) \rho_\varepsilon(X_\varepsilon)^{-1}. \quad (\text{A.7})$$

Given this claim, we obtain that (A.6) is further equal to

$$\begin{aligned} \rho_\varepsilon([\pi \ \pi_0]) \sum_{\lambda \vdash \frac{n}{2}} \rho_\varepsilon(P_{\mathcal{H}_n}) \rho_\varepsilon(P_{2\lambda}) \rho_\varepsilon(X_\varepsilon)^{-1} &= \rho_\varepsilon([\pi \ \pi_0]) \rho_\varepsilon(P_{\mathcal{H}_n}) \rho_\varepsilon(X_\varepsilon)^{-1} \\ &= \rho_\varepsilon([\pi \ \pi_0]) \rho_\varepsilon(X_\varepsilon)^{-1}, \end{aligned}$$

where we used (A.3) in the second equality and the fact that \mathcal{H}_n by definition stabilizes π_0 in the second. Combining the previous few identities, we see that

$$\sum_{\pi': [n] \rightarrow [n]} \text{Wg}^{\text{O}}_\zeta(\pi_0, \pi') \rho_\varepsilon([\pi \ \pi']) = \rho_\varepsilon([\pi \ \pi_0]) \rho_\varepsilon(X_\varepsilon)^{-1},$$

which is precisely Lemma 6.38.

To see the claim (A.7), first note that by (A.4), we have that

$$\sum_{\substack{\lambda \vdash \frac{n}{2} \\ D_\lambda(\varepsilon N) \neq 0}} D_\lambda(\varepsilon N)^{-1} \rho_\varepsilon(P_{\mathcal{H}_n}) \rho_\varepsilon(P_{2\lambda}) \rho_\varepsilon(X_\varepsilon) = \sum_{\substack{\lambda \vdash \frac{n}{2} \\ D_\lambda(\varepsilon N) \neq 0}} \rho_\varepsilon(P_{\mathcal{H}_n}) \rho_\varepsilon(P_{2\lambda}).$$

As mentioned in the proof of Lemma 6.47, $\rho_\varepsilon(X_\varepsilon)$ is always invertible, and thus the above implies

$$\sum_{\substack{\lambda \vdash \frac{n}{2} \\ D_\lambda(\varepsilon N) \neq 0}} D_\lambda(\varepsilon N)^{-1} \rho_\varepsilon(P_{\mathcal{H}_n}) \rho_\varepsilon(P_{2\lambda}) = \sum_{\substack{\lambda \vdash \frac{n}{2} \\ D_\lambda(\varepsilon N) \neq 0}} \rho_\varepsilon(P_{\mathcal{H}_n}) \rho_\varepsilon(P_{2\lambda}) \rho_\varepsilon(X_\varepsilon)^{-1}.$$

To finish, it suffices to show that for any $\lambda \vdash \frac{n}{2}$ such that $D_\lambda(\varepsilon N) = 0$, we have that $\rho_\varepsilon(P_{2\lambda}) = 0$. In the case $\varepsilon = 1$, this follows because (as observed in the proof of Lemma 2.30) $\rho(P_{2\lambda}) = 0$ unless $\ell(2\lambda) \leq N$, and one may directly check that $\ell(2\lambda) \leq N$ implies $D_\lambda(N) \neq 0$ (the worst case is the box at location $(i, j) = (\ell(2\lambda), 1)$).

Next, suppose $\varepsilon = -1$. We claim that $\rho_-(P_{2\lambda}) = \rho(P_{(2\lambda)'})$, where $(2\lambda)'$ is the conjugate partition to 2λ . Given this claim, we obtain that $\rho_-(P_{2\lambda}) = 0$ unless $\ell((2\lambda)') \leq N$. Note that $\ell((2\lambda)') = w(2\lambda) = 2w(\lambda)$, where $w(\lambda)$ is the number of columns of λ . By direct calculation, $2w(\lambda) \leq N$ implies that $D_\lambda(-N) \neq 0$ (the worst case is the box at location $(i, j) = (1, w(\lambda))$).

To see why $\rho_-(P_{2\lambda}) = \rho(P_{(2\lambda)'})$, note that $\rho_-(\sigma) = \text{sgn}(\sigma)\rho(\sigma)$, and so

$$\rho_-(P_{2\lambda}) = \rho\left(\frac{\chi_{2\lambda}(\text{id})}{n!} \sum_{\sigma \in S_n} \text{sgn}(\sigma) \chi_{2\lambda}(\sigma) \sigma\right).$$

Using the classical fact that $\chi_{(2\lambda)' }(\sigma) = \text{sgn}(\sigma) \chi_{2\lambda}(\sigma)$, the above is seen to be equal to $\rho(P_{(2\lambda)'})$, as desired.

References

- [ACCR13] O. Angel, G. Chapuy, N. Curien, and G. Ray. The local limit of unicellular maps in high genus. *Electronic Communications in Probability*, 18(none):1 – 8, 2013.
- [AN23] O. Abdelghani and R. Nissim. Geometric Derivation of the Finite N Master Loop Equation, 2023, arXiv:2309.07399.
- [App11] D. Applebaum. Infinitely divisible central probability measures on compact Lie groups-regularity, semigroups and transition kernels. *The Annals of Probability*, 39(6):2474–2496, 2011.
- [APPS22] M. Ang, M. Park, J. Pfeffer, and S. Sheffield. Brownian loops and the central charge of a Liouville random surface. *The Annals of Probability*, 50(4):1322–1358, 2022.
- [BC23] B. Bringmann and S. Cao. A para-controlled approach to the stochastic Yang-Mills equation in two dimensions. *arXiv preprint arXiv:2305.07197*, 2023.

- [Bd23] T. Buc-d’Alché. Topological expansion of unitary integrals and maps. *arXiv preprint arXiv:2304.12785*, 2023.
- [BDFG02] J. Bouttier, P. Di Francesco, and E. Guitter. Census of planar maps: from the one-matrix model solution to a combinatorial proof. *Nuclear Physics B*, 645(3):477–499, 2002.
- [BIPZ78] E. Brézin, C. Itzykson, G. Parisi, and J.-B. Zuber. Planar diagrams. *Communications in Mathematical Physics*, 59:35–51, 1978.
- [BIZ80] D. Bessis, C. Itzykson, and J.-B. Zuber. Quantum field theory techniques in graphical enumeration. *Advances in Applied Mathematics*, 1(2):109–157, 1980.
- [BL21] T. Budzinski and B. Louf. Local limits of uniform triangulations in high genus. *Inventiones mathematicae*, 223:1–47, 2021.
- [BL22] T. Budzinski and B. Louf. Local limits of bipartite maps with prescribed face degrees in high genus. *The Annals of Probability*, 50(3):1059–1126, 2022.
- [BVC20] O. Borisenko, S. Voloshyn, and V. Chelnokov. SU (N) polynomial integrals and some applications. *Reports on Mathematical Physics*, 85(1):129–145, 2020.
- [CC21] S. Cao and S. Chatterjee. A state space for 3D Euclidean Yang-Mills theories. *arXiv preprint arXiv:2111.12813*, 2021.
- [CC23] S. Cao and S. Chatterjee. The Yang-Mills heat flow with random distributional initial data. *Communications in Partial Differential Equations*, 48(2):209–251, 2023.
- [CCHS22a] A. Chandra, I. Chevyrev, M. Hairer, and H. Shen. Langevin dynamic for the 2D Yang–Mills measure. *Publications mathématiques de l’IHÉS*, pages 1–147, 2022.
- [CCHS22b] A. Chandra, I. Chevyrev, M. Hairer, and H. Shen. Stochastic quantisation of Yang-Mills-Higgs in 3d. *arXiv preprint arXiv:2201.03487*, 2022.
- [CDK18] B. Collins, A. Dahlqvist, and T. Kemp. The spectral edge of unitary Brownian motion. *Probability Theory and Related Fields*, 170(1-2):49–93, 2018.
- [CGMS09] B. Collins, A. Guionnet, and E. Maurel-Segala. Asymptotics of unitary and orthogonal matrix integrals. *Advances in Mathematics*, 222(1):172–215, 2009.
- [Cha19a] S. Chatterjee. Rigorous solution of strongly coupled $SO(N)$ lattice gauge theory in the large N limit. *Communications in Mathematical Physics*, 366(1):203–268, 2019.
- [Cha19b] S. Chatterjee. Yang-Mills for probabilists. In *Probability and Analysis in Interacting Physical Systems*, pages 1–16. Springer, Cham: Springer, 2019.

- [Cha21] S. Chatterjee. A probabilistic mechanism for quark confinement. *Communications in Mathematical Physics*, 385(2):1007–1039, 2021.
- [Che19] I. Chevyrev. Yang-Mills measure on the two-dimensional torus as a random distribution. *Communications in Mathematical Physics*, 372(3):1027–1058, 2019. MR4034782
- [Che22] I. Chevyrev. Stochastic quantization of Yang–Mills. *Journal of Mathematical Physics*, 63(9):091101, 2022.
- [CJ16] S. Chatterjee and J. Jafarov. The $1/N$ expansion for $SO(N)$ lattice gauge theory at strong coupling. *arXiv preprint arXiv:1604.04777*, 2016.
- [CM17] B. Collins and S. Matsumoto. Weingarten calculus via orthogonality relations: new applications. *arXiv preprint arXiv:1701.04493*, 2017.
- [CMN22] B. Collins, S. Matsumoto, and J. Novak. The weingarten calculus. *arXiv preprint arXiv:2109.14890*, 2022.
- [CMSS07] B. Collins, J. A. Mingo, P. Śniady, and R. Speicher. Second order freeness and fluctuations of random matrices. III: Higher order freeness and free cumulants. *Documenta Mathematica*, 12:1–70, 2007.
- [Con05] F. Conrady. Geometric spin foams, Yang-Mills theory and background-independent models. *arXiv preprint gr-qc/0504059*, 2005.
- [CS06] B. Collins and P. Śniady. Integration with respect to the Haar measure on unitary, orthogonal and symplectic group. *Communications in Mathematical Physics*, 264(3):773–795, 2006.
- [Cur16] N. Curien. Planar stochastic hyperbolic triangulations. *Probability Theory and Related Fields*, 165:509–540, 2016.
- [Dah16] A. Dahlqvist. Free energies and fluctuations for the unitary Brownian motion. *Communications in Mathematical Physics*, 348(2):395–444, 2016.
- [Dah17] A. Dahlqvist. Integration formulas for Brownian motion on classical compact Lie groups. *Annales de l’Institut Henri Poincaré. Probabilités et Statistiques*, 53(4):1971–1990, 2017.
- [DCPSS17] H. Duminil-Copin, R. Peled, W. Samotij, and Y. Spinka. Exponential decay of loop lengths in the loop $O(n)$ model with large n . *Communications in Mathematical Physics*, 349:777–817, 2017.
- [DFGZJ95] P. Di Francesco, P. Ginsparg, and J. Zinn-Justin. 2D gravity and random matrices. *Physics Reports*, 254(1-2):1–133, 1995.
- [DG21] J. Ding and E. Gwynne. Regularity and confluence of geodesics for the supercritical Liouville quantum gravity metric. *arXiv preprint arXiv:2104.06502*, 2021.

- [DG23] J. Ding and E. Gwynne. Uniqueness of the critical and supercritical Liouville quantum gravity metrics. *Proceedings of the London Mathematical Society*, 126(1):216–333, 2023.
- [DGZZ22] V. Delecroix, E. Goujard, P. Zograf, and A. Zorich. Large genus asymptotic geometry of random square-tiled surfaces and of random multicurves. *Inventiones mathematicae*, 230(1):123–224, 2022.
- [DHK17] B. K. Driver, B. C. Hall, and T. Kemp. Three proofs of the Makeenko-Migdal equation for Yang-Mills theory on the plane. *Communications in Mathematical Physics*, 351(2):741–774, 2017.
- [DL22] A. Dahlqvist and T. Lemoine. Large N limit of the Yang-Mills measure on compact surfaces II: Makeenko-Migdal equations and planar master field. *arXiv preprint arXiv:2201.05886*, 2022.
- [DM22] T. Diez and L. Miaskiwski. Expectation values of polynomials and moments on general compact Lie groups. *arXiv preprint arXiv:2203.11607*, 2022.
- [DN20] A. Dahlqvist and J. R. Norris. Yang-Mills measure and the master field on the sphere. *Communications in Mathematical Physics*, 377(2):1163–1226, 2020.
- [Dri89] B. K. Driver. YM_2 : Continuum expectations, lattice convergence, and lassos. *Communications in Mathematical Physics*, 123(4):575–616, 1989.
- [Dri19] B. K. Driver. A Functional Integral Approaches to the Makeenko–Migdal Equations. *Communications in Mathematical Physics*, 370:49–116, 2019.
- [E⁺16] B. Eynard et al. Counting surfaces. *Progress in Mathematical Physics*, 70:414, 2016.
- [EK82] T. Eguchi and H. Kawai. Reduction of Dynamical Degrees of Freedom in the Large- N Gauge Theory. *Phys. Rev. Lett.*, 48:1063–1066, Apr 1982.
- [EO08] B. Eynard and N. Orantin. Algebraic methods in random matrices and enumerative geometry. *arXiv preprint arXiv:0811.3531*, 2008.
- [Eyn11a] B. Eynard. Formal matrix integrals and combinatorics of maps. In *Random matrices, random processes and integrable systems*, CRM Ser. Math. Phys., pages 415–442. Berlin: Springer, 2011. MR2858440
- [Eyn11b] B. Eynard. Formal matrix integrals and combinatorics of maps. In *Random matrices, random processes and integrable systems*, pages 415–442. Springer, 2011.
- [Fin91] D. S. Fine. Quantum Yang-Mills on a Riemann surface. *Communications in Mathematical Physics*, 140(2):321–338, 1991.
- [Frö79] J. Fröhlich. Confinement in Zn lattice gauge theories implies confinement in SU(n) lattice Higgs theories. *Physics Letters B*, 83(2):195–198, 1979.

- [FS82] J. Fröhlich and T. Spencer. Massless phases and symmetry restoration in abelian gauge theories and spin systems. *Communications in Mathematical Physics*, 83:411–454, 1982.
- [GHPR20] E. Gwynne, N. Holden, J. Pfeffer, and G. Remy. Liouville quantum gravity with matter central charge in $(1, 25)$: a probabilistic approach. *Communications in Mathematical Physics*, 376(2):1573–1625, 2020.
- [GKS89] L. Gross, C. King, and A. Sengupta. Two dimensional Yang-Mills theory via stochastic differential equations. *Annals of Physics*, 194(1):65–112, 1989.
- [GM81] M. Göpfert and G. Mack. Proof of confinement of static quarks in 3-dimensional $U(1)$ lattice gauge theory for all values of the coupling constant. *Communications in Mathematical Physics*, 82(4):545 – 606, 1981.
- [GMS05] A. Guionnet and E. Maurel-Segala. Combinatorial aspects of matrix models. *arXiv preprint math/0503064*, 2005.
- [GN15] A. Guionnet and J. Novak. Asymptotics of unitary multimatrix models: The Schwinger–Dyson lattice and topological recursion. *Journal of Functional Analysis*, 268(10):2851–2905, 2015.
- [GPW91] D. J. Gross, T. Piran, and S. Weinberg. *Two dimensional quantum gravity and random surfaces-8th Jerusalem winter school for theoretical physics*, volume 8. World Scientific, 1991.
- [IZ80] C. Itzykson and J.-B. Zuber. The planar approximation. II. *Journal of Mathematical Physics*, 21(3):411–421, 1980.
- [Jaf16] J. Jafarov. Wilson loop expectations in $SU(N)$ lattice gauge theory. *arXiv preprint arXiv:1610.03821*, 2016.
- [JK20] J. H. Jung and M. Kim. Supersymmetric polynomials and the center of the walled Brauer algebra. *Algebras and Representation Theory*, 23:1945–1975, 2020.
- [JL23] S. Janson and B. Louf. Unicellular maps vs. hyperbolic surfaces in large genus: Simple closed curves. *The Annals of Probability*, 51(3):899–929, 2023.
- [Juc74] A.-A. Jucys. Symmetric polynomials and the center of the symmetric group ring. *Reports on Mathematical Physics*, 5(1):107–112, 1974.
- [JW06] A. Jaffe and E. Witten. Quantum Yang-Mills theory. *The millennium prize problems*, 1:129–152, 2006.
- [KZ23] V. Kazakov and Z. Zheng. Bootstrap for lattice Yang-Mills theory. *Physical Review D*, 107(5):L051501, 2023.
- [Lév03] T. Lévy. *Yang-Mills measures on compact surfaces*, volume 790 of *Mem. Am. Math. Soc.* Providence, RI: American Mathematical Society (AMS), 2003.

- [Lév10] T. Lévy. *Two-dimensional Markovian holonomy fields.*, volume 329 of *Astérisque*. Paris: Société Mathématique de France (SMF), 2010.
- [Lév17] T. Lévy. The master field on the plane. *Asterisque*, 388, 2017.
- [LT20] B. Lees and L. Taggi. Site monotonicity and uniform positivity for interacting random walks and the spin $O(N)$ model with arbitrary N . *Communications in Mathematical Physics*, 376(1):487–520, 2020.
- [LT21] B. Lees and L. Taggi. Exponential decay of transverse correlations for $O(N)$ spin systems and related models. *Probability Theory and Related Fields*, 180(3-4):1099–1133, 2021.
- [Mat13] S. Matsumoto. Weingarten calculus for matrix ensembles associated with compact symmetric spaces. *arXiv preprint arXiv:1301.5401*, 2013.
- [Meh81] M. L. Mehta. A method of integration over matrix variables. *Communications in Mathematical Physics*, 79:327–340, 1981.
- [Mig96] A. A. Migdal. Recursion equations in gauge field theories. In *30 Years Of The Landau Institute—Selected Papers*, pages 114–119. World Scientific, 1996.
- [MM79] Y. M. Makeenko and A. A. Migdal. Exact equation for the loop average in multicolor QCD. *Physics Letters B*, 88(1-2):135–137, 1979.
- [MN13] S. Matsumoto and J. Novak. Jucys–Murphy elements and unitary matrix integrals. *International Mathematics Research Notices*, 2013(2):362–397, 2013.
- [MP93] J. A. Minahan and A. P. Polychronakos. Equivalence of two-dimensional QCD and the $C=1$ matrix model. *Physics Letters B*, 312(1-2):155–165, 1993.
- [MP19] M. Magee and D. Puder. Matrix group integrals, surfaces, and mapping class groups. I. $U(N)$. *Inventiones Mathematicae*, 218(2):341–411, 2019.
- [MP21] M. Magee and D. Puder. Surface words are determined by word measures on groups. *Israel Journal of Mathematics*, 241(2):749–774, 2021.
- [MP22] M. Magee and D. Puder. Matrix Group Integrals, Surfaces, and Mapping Class Groups II: $O(N)$ and $Sp(N)$. *Mathematische Annalen*, 2022, 1904.13106.
- [MRS93] J. Magnen, V. Rivasseau, and R. Sénéor. Construction of YM 4 with an infrared cutoff. *Communications in mathematical physics*, 155:325–383, 1993.
- [MS06] E. Maurel-Segala. High order expansion of matrix models and enumeration of maps. *arXiv preprint math/0608192*, 2006.
- [Mur81] G. E. Murphy. A new construction of Young’s seminormal representation of the symmetric groups. *Journal of Algebra*, 69(2):287–297, 1981.

- [Naz96] M. Nazarov. Young’s orthogonal form for Brauer’s centralizer algebra. *Journal of Algebra*, 182(3):664–693, 1996.
- [Nov10] J. Novak. Jucys-Murphy elements and the unitary Weingarten function. *Banach Center Publications*, 1(89):231–235, 2010.
- [Oko00] A. Okounkov. Random matrices and random permutations. *International Mathematics Research Notices*, 2000(20):1043–1095, 2000.
- [OP01] R. Oeckl and H. Pfeiffer. The dual of pure non-Abelian lattice gauge theory as a spin foam model. *Nuclear Physics B*, 598(1-2):400–426, 2001.
- [OS78] K. Osterwalder and E. Seiler. Gauge field theories on a lattice. *Annals of Physics*, 110(2):440–471, 1978.
- [Pol81] A. M. Polyakov. Quantum geometry of bosonic strings. *Physics Letters B*, 103(3):207–210, 1981.
- [PPSY23] M. Park, J. Pfeffer, S. Sheffield, and P. Yu. Wilson loop expectations as sums over surfaces on the plane. *arXiv preprint arXiv:2305.02306*, 2023.
- [QT23] A. Quitmann and L. Taggi. Macroscopic loops in the Bose gas, Spin O (N) and related models. *Communications in Mathematical Physics*, pages 1–56, 2023.
- [Sen97] A. Sengupta. *Gauge theory on compact surfaces*, volume 600 of *Mem. Am. Math. Soc.* Providence, RI: American Mathematical Society (AMS), 1997.
- [She21] H. Shen. Stochastic quantization of an abelian gauge theory. *Communications in Mathematical Physics*, 384(3):1445–1512, 2021.
- [She22] S. Sheffield. What is a random surface? *arXiv preprint arXiv:2203.02470*, 2022.
- [SSZ22] H. Shen, S. A. Smith, and R. Zhu. A new derivation of the finite N master loop equation for lattice Yang-Mills. *arXiv preprint arXiv:2202.00880*, 2022.
- [SY14] S. Sheffield and A. Yadin. Tricolor percolation and random paths in 3D. *Electronic Journal of Probability*, 19(none):1 – 23, 2014.
- [SZZ23] H. Shen, R. Zhu, and X. Zhu. A stochastic analysis approach to lattice Yang–Mills at strong coupling. *Communications in Mathematical Physics*, 400(2):805–851, 2023.
- [tH93] G. ’t Hooft. A planar diagram theory for strong interactions. In *The Large N Expansion In Quantum Field Theory And Statistical Physics: From Spin Systems to 2-Dimensional Gravity*, pages 80–92. World Scientific, 1993.
- [Tut68] W. T. Tutte. On the enumeration of planar maps. *Bulletin of the American Mathematical Society*, 74(1):64 – 74, 1968.

- [Wei78] D. Weingarten. Asymptotic behavior of group integrals in the limit of infinite rank. *Journal of Mathematical Physics*, 19(5):999–1001, 1978.
- [WG01] R. Wilson and J. Gray. *Mathematical conversations: selections from The mathematical intelligencer*. Springer Science & Business Media, 2001.
- [Wil74] K. G. Wilson. Confinement of quarks. *Physical review D*, 10(8):2445, 1974.
- [Wil04] K. G. Wilson. The origins of lattice gauge theory. *arXiv preprint hep-lat/0412043*, 2004.
- [Wit91] E. Witten. On quantum gauge theories in two dimensions. *Communications in Mathematical Physics*, 141(1):153–209, 1991.
- [ZJ09] P. Zinn-Justin. Jucys-Murphy elements and Weingarten matrices. *arXiv preprint arXiv:0907.2719*, 2009.
- [ZJZ03] P. Zinn-Justin and J.-B. Zuber. On some integrals over the $U(N)$ unitary group and their large N limit. *Journal of Physics A: Mathematical and General*, 36(12):3173, 2003.
- [Zvo97] A. Zvonkin. Matrix integrals and map enumeration: an accessible introduction. *Mathematical and Computer Modelling*, 26(8-10):281–304, 1997.