

# The Renoir Dataflow Platform: Efficient Data Processing without Complexity

Luca De Martini<sup>a,\*</sup>, Alessandro Margara<sup>a</sup>, Gianpaolo Cugola<sup>a</sup>, Marco Donadoni<sup>a</sup>, Edoardo Morassutto<sup>a</sup>

<sup>a</sup>Politecnico di Milano, Piazza Leonardo da Vinci 32, 20133, Milano, Italy

---

## Abstract

Today, data analysis drives the decision-making process in virtually every human activity. This demands for software platforms that offer simple programming abstractions to express data analysis tasks and that can execute them in an efficient and scalable way. State-of-the-art solutions range from low-level programming primitives, which give control to the developer about communication and resource usage, but require significant effort to develop and optimize new algorithms, to high-level platforms that hide most of the complexities of parallel and distributed processing, but often at the cost of reduced efficiency.

To reconcile these requirements, we developed Renoir, a novel distributed data processing platform written in Rust. Renoir provides a high-level dataflow programming model as mainstream data processing systems. It supports static and streaming data, it enables data transformations, grouping, aggregation, iterative computations, and time-based analytics, and it provides all these features incurring in a low overhead.

In this paper, we present the programming model and the implementation details of Renoir. We evaluate it under heterogeneous workloads. We compare it with state-of-the-art solutions for data analysis and high-performance computing, as well as alternative research products, which offer different programming abstractions and implementation strategies. Renoir programs are compact and easy to write: developers need not care about low-level concerns such as resource usage, data serialization, concurrency control, and communication. At the same time, Renoir consistently presents comparable or better performance than competing solutions, by a large margin in several scenarios.

We conclude that Renoir offers a good tradeoff between simplicity and performance, allowing developers to easily express complex data analysis tasks and achieve high performance and scalability.

*Keywords:* data analytics, distributed processing, batch processing, stream processing, dataflow model

---

## 1. Introduction

Today, companies heavily rely on data analytics to extract actionable knowledge from static and dynamic (streaming) datasets. Over the last decade, this need has driven the surge of several distributed platforms designed to process data at scale [1, 2, 3, 4, 5]. Despite their differences, they all rely on the dataflow programming and execution model. Pioneered by the MapReduce framework [6], this model defines data analytics jobs as directed graphs of operators, each applying a functional transformation to its input data and feeding downstream operators with its output. This approach brings twofold benefits: (i) It enables a high degree of parallelism: different operators may execute simultaneously on the same or different hosts (task parallelism), and each operator may itself be decomposed into parallel instances, each one working independently on one partition of the input data (data parallelism). (ii) It exposes a simple programming interface that abstracts away most of the complexity associated to the distribution of data and processing: developers focus on the behavior of operators and how the input data is partitioned across parallel instances, while the runtime automates deployment, scheduling, synchronization, and communication. Some platforms

further increase the level of abstraction by offering custom API or domain specific languages for some areas, such as relational data processing [7, 8, 9] or graph processing [10].

However, despite offering a simple and effective way to scale-out data analytics, state-of-the-art platforms cannot provide a level of performance that is comparable to custom programs optimized for the specific problem at hand. As recognized in recent literature [11, 12, 13], custom implementations using hand-crafted code or low-level programming primitives, such as MPI, can yield more than one order of magnitude performance improvements. But this comes at a price: a much greater difficulty in software validation, debugging, and maintenance, as programmers are exposed to concerns related to memory management, data serialization communication, and synchronization.

In this paper, we investigate the possibility to reduce this gap. To do so, we introduce Renoir, a new distributed data processing platform that provides a lightweight and highly efficient implementation of the dataflow model. In terms of programming model, Renoir retains the same ease of use as mainstream dataflow platforms, but has the flexibility to write optimized solutions when necessary. It supports the analysis of static and dynamic data (batch and stream processing jobs), it offers a rich library of operators for data transformation, partitioning, aggregation, and iterative computations. Moreover, developers may customize the behavior of operators via user-defined functions, that are deeply integrated within the programming model.

Applications written in a few lines of code using Renoir have been shown to deliver similar or even better performance than much

---

\*Corresponding author

Email addresses: luca.demartini@polimi.it

(Luca De Martini), alessandro.margara@polimi.it

(Alessandro Margara), gianpaolo.cugola@polimi.it

(Gianpaolo Cugola), marco.donadoni@mail.polimi.it (Marco

Donadoni), edoardo.morassutto@mail.polimi.it (Edoardo Morassutto)

more, complex custom MPI implementations. This is made possible by some key design and implementation choices that enable programs written in Renoir to be compiled to highly efficient code, comparable to what can be achieved with hand-written optimized code. In particular, Renoir abandons JVM-based languages, typically adopted by mainstream competitors, in favor of Rust [14], a compiled programming language that offers high-level abstractions at virtually no cost. This enables Renoir to work alongside the Rust compiler to generate efficient code: it avoids dynamic dispatching, it maximises the possibilities of inlining and monomorphization, it adopts data structures that minimize the use of pointers and indirections to increase memory locality.

Moreover, Renoir adopts a lightweight approach to resource management, which leverages the services offered by the operating system when possible. For example, it co-locates operators that perform different steps of a processing job on the same host, letting them compete for CPU time based on their dynamic requirements, while it leverages the mechanisms embedded into TCP to implement backpressure. While originally developed for distributed deployment with multiple machines, Renoir also proved effective in parallelizing computations within a single-process, performing on par with dedicated software libraries such as OpenMP. Renoir has been used in practice to compete to the Grand Challenge in the 2022 ACM International Conference of Distributed and Event-Based Systems, winning the performance award for the solution with the highest throughput and lowest latency [15].

In summary, the careful co-design of the programming model and execution platform makes Renoir unique in terms of its balance between simplicity, expressivity, and performance. As discussed above, mainstream dataflow platforms sacrifice performance for simplicity. Solutions that aim to further simplify use by offering higher-level API or domain specific languages restrict expressivity and often rely on standard platforms for the execution of tasks, which puts a bound to their level of performance. Other systems such as Timely Dataflow [16] aim to improve performance, but offer more complex programming model that hamper usability. Engines optimized for specific tasks such as Dask [17] offer simple programming models but cannot provide the same generality as Renoir.

Our work brings several contributions to the research on distributed data processing: (1) It introduces Renoir, a new dataflow platform that combines the simplicity of mainstream data analytic systems with a level of efficiency that is close or even better than custom low-level code. Renoir is available as an open-source project<sup>1</sup>. (2) It presents the key design and implementation choices that affect the efficiency and scalability of Renoir. (3) It presents an extensive experimental evaluation that analyzes the effectiveness of Renoir with highly heterogeneous workloads and compares it with mainstream dataflow platforms, low-level custom solutions, alternative research proposals, and libraries for parallel computations.

The paper is organized as follows. Section 2 provides background on distributed data processing platforms and Rust. Section 3 and Section 4 present the programming model and the design of Renoir, and Section 5 evaluates its performance and scalability, comparing them with alternative data processing platforms and cus-

tom MPI programs. Section 6 discusses related work and Section 7 draws conclusive remarks.

## 2. Background

This section presents the programming model of distributed data processing platforms and the key features of Rust that Renoir exploits to attain simplicity and efficiency.

### 2.1. Distributed data processing

Modern platforms for distributed data processing rely on a dataflow programming model [4, 1] first introduced by Google’s MapReduce [6]. Computation is organized into a directed graph, whose vertices represent operators and edges represent the flow of data from operator to operator. Since operators do not share any state, the model promotes distribution and parallelism by deploying operators in multiple instances, each processing an independent partition of the input data in parallel with the others, on the same or on different hosts.

The famous example used to illustrate the model is “word count”, a program to count the number of occurrences of each word in a large set of documents. It can be expressed using two operators, the first operates in parallel on various partitions of the input documents splitting them in words and emitting partial counts for each word. These partial results are then regrouped by word and passed to the second operator that sums the occurrences of each word. Developers need only to express how to operate on an individual document (first operator) and how to integrate partial results for each word (second operator). The runtime takes care of operator deployment, synchronization, scheduling, and data communication: the most complex and critical aspects in distributed applications.

The dataflow model accommodates stream processing computations with only minor adjustments. Due to the unbounded nature of streams, developers need to specify when certain computations are triggered and what is their scope, which is typically expressed using *windows*. For instance, developers could implement a streaming word count computation over a window of one hour that advances every ten minutes, meaning that the count occurs every ten minutes and considers only new documents produced in the last hour.

Data processing systems implemented the dataflow model using two orthogonal execution strategies. Systems such as Hadoop [18] and Apache Spark [2] dynamically schedule operator instances over the nodes of the compute infrastructure. Communication between operators occurs by saving intermediate results on some shared storage, with operators deployed as close as possible to the input data they consume. Systems such as Apache Flink [5] and Google Dataflow [4] deploy all operators instances before starting the computation. Communication takes place as message passing among instances. Renoir adopts the second strategy, which enables lower latency for streaming computations, as it does not incur the overhead of operator scheduling at runtime.

### 2.2. Rust

Renoir heavily relies on some key features of the Rust programming language to offer a high-level API with limited performance overhead.

<sup>1</sup><https://github.com/deib-polimi/renoir>

**Generics and static dispatch.** In Rust, developers can express data structures and functions that are *generic* over one or more types. For instance, all Renoir operators consume and produce a generic `Stream<T>`, which represents a bounded or unbounded dataset of a generic type `T`. This high-level construct is implemented at virtually no cost by Rust, which adopts static dispatching. The compiler generates a separate version of each generic structure or function for each different way in which it is instantiated in the program, while invocations to generic functions are translated into direct calls to the correct version [19].

**Memory management.** Rust provides automatic and safe deallocation of memory without the overhead of garbage collection. It achieves this goal through an *ownership and borrowing* model [20], which represents Rust’s most distinctive feature. In Rust, every value has an *owning scope* (for instance, a function), and passing or returning a value transfers its ownership to a new scope. When a scope ends, all its owned values are automatically destroyed. A scope can lend out a value to the functions it calls: the Rust compiler checks that a lease does not outlive the borrowed object. All together, this model allows Rust to fully check safety of memory accesses at compile time, also avoiding the need for (costly) runtime garbage collection.

**Iterators and closures.** The iterator pattern is heavily used in idiomatic Rust code and enables chaining operations over a collection of items without manually implementing the logic to traverse the collection. In practice, operations on collections are implemented as *iterator adapters* that take in input an iterator and produce a new iterator. Moreover, iterator adapters are often defined as higher-order functions that accept *closures* defining their behavior as parameters. This iterator pattern strongly resembles the dataflow model discussed above. For this reason, we used iterators as the blueprint for Renoir’s model and implementation, making its API intuitive both for Rust developers and for users of data processing platforms.

**Traits and serialization.** Traits represent a collection of functionalities (methods) that any data type implementing that trait should offer. Traits are widely used in Rust to bound generics, for instance to restrict the use of a generic function only to parameters that implement certain traits. Renoir leverages traits to transparently implement parameter passing among distributed instances of operators. More specifically, Renoir requires all data types to implement the `Serialize` and `Deserialize` traits, and automatically generates the code that efficiently implements these traits.

### 3. Programming Interface

Renoir offers a high-level programming interface that hides most of the complexities related to data distribution, communication, serialization, and synchronization.

#### 3.1. Streams

Streams are the core programming abstraction of Renoir. A generic `Stream<T>` represents a dataset of elements of type `T`, which can be any type that implements the `Serialize` and `Deserialize` traits. Since these traits can be automatically derived at compile time by the `Serde` library [21], developers can use their custom data types without manually implementing the serialization

logic. Streams model both static (bounded) datasets (e.g., the content of a file) and dynamic (unbounded) datasets, where new elements get continuously appended (e.g., data received from a TCP link). Streams are created by *sources*, processed by *operators* that produce output streams from input streams by applying functional transformations, and collected by *sinks*. Streams can be partitioned, enabling those partitions to be processed in parallel. The partitions can be distributed on multiple hosts, each one being able to process multiple partitions in parallel within the same process using threads.

#### 3.2. Creating and consuming streams

In Renoir, a `StreamEnvironment` holds the system configuration and generates streams from sources. Renoir comes with a library of sources. For instance, the following snippet uses the `IteratorSource`, which takes an iterator in input and builds a source that emits all the elements returned by the iterator. In the example, the iterator is `0..100`, consequently the source will emit all integers in the range from 0 to 99.

```
let env = StreamEnvironment::new(config);
let source = IteratorSource::new(0..100);
let stream = env.stream(source);
```

Similarly, the `ParallelIteratorSource` builds a source consisting of multiple instances that emit elements in parallel. It takes in input a closure with two parameters: the total number of parallel instances (`instances` in the code snippet below) and a unique identifier for each instance (`id`). The closure is executed in parallel on every instance, getting a different `id` from 0 to `instances-1`. The closure must return an iterator for each instance, with the elements that the instance emits. In the example below, each source instance runs in parallel with the others and produces 10 integers, the first one starting from 0, the second one starting from 10, and so on.

```
let source = ParallelIteratorSource::new(
    move |id, instances| {
        let start = 10*id;
        let end = 10*(id + 1);
        start..end
    });
```

Since iterators are widespread in Rust, the sources above have wide applicability. For example, iterators are used in the Apache Kafka API for Rust, making it straightforward for developers to build sources that read elements from Kafka topics.

Sinks consume output data from Renoir and may be used to print the results or store them into files or external systems, such as a database. Renoir provides three main sinks: `for_each` applies a function to each and every element in the stream, `collect` gathers all elements in a collection and returns it as output, `collect_channel` returns a multi-producer multi-consumer channel that can be used by external code to receive the outputs. For example, the following code snippet prints all elements in the stream:

```
stream.for_each(|i| println!("{}", i));
```

#### 3.3. Transforming streams with operators

Operators define functional transformations of streams. We first present *single stream* operators, which operate on one stream and produce one stream. We distinguish stateless and stateful single

stream operators and we discuss how they are executed in parallel over partitions of the input stream. Next, we generalize to *multiple stream* operators that process data coming from multiple streams or produce multiple streams.

### 3.3.1. Single-stream operators

Single stream operators ingest a single stream to produce a new stream. Examples of single stream operators are `map`, `flat_map`, `filter` and `fold`. A `map` operator transforms each element of the input stream into one element of the output stream, as specified in a user-defined closure. For instance, the following code snippet transforms a stream of integers doubling each element to produce the output stream.

```
stream.map(|i| i * 2);
```

A `flat_map` operator may produce zero, one, or more elements in the output stream for each element in the input stream. For instance, for each integer `i` in the input stream, the following code outputs three integers: `i`, `i` multiplied by 2, and `i` multiplied by 3. The developer packs the output elements produced when processing an input element into a vector and Renoir automatically “flattens” these results into the output stream.

```
stream.flat_map(|i: u32| vec![i, i * 2, i * 3]);
```

A `filter` operator takes a predicate and retains only the input elements that satisfy it. For instance, the code snippet below retains only the even numbers from the input stream.

```
stream.filter(|i: u32| v % 2 == 0);
```

A `fold` operator combines all elements into an *accumulator* by applying a provided closure to each element in the stream. The closure takes as parameters a mutable reference to the accumulator and an input element, and updates the value of the accumulator using the input. For instance, the example below sums all input elements: the initial value of the accumulator is 0 and each element `i` is added to the accumulator `sum`.

```
stream.fold(0, |sum: &mut u32, i: u32| *sum += i);
```

The `reduce` operator provides a more compact way to express the same kind of computations as `fold` when the elements in the input and in the output streams are of the same types, as exemplified by the code below, which uses a `reduce` operator to sum the elements of a stream.

```
stream.reduce(|sum, i| sum + i);
```

Renoir also supports stateful operators, which can access and modify some state during processing. This way, developers may implement computations where the evaluation of an element depends on the state of the system after processing all previous elements in the input stream. As an example, let us consider the `rich_map` operator, which is the stateful version of a `map` operator. The evaluation of an element depends on the input element and on the state of the operator. The listing below adopts a `rich_map` to output the difference between the current element and the previous one. The value of the previous element is stored inside the `prev` variable, which is initialized to 0 and moved inside the closure. When processing a new element `x`, the closure computes the difference (`diff`), updates the state (`prev`) with the new element, and finally outputs the difference.

```
stream.rich_map({
    let mut prev = 0;
    move |x: u32| {
        let diff = x - prev;
        prev = x;
        diff
    } });
```

### 3.3.2. User defined functions

As the above operators well exemplify, Renoir allows developers to fully customize the logic of operators by passing user defined functions in the form of closures. In JVM-based dataflow systems, this degree of flexibility comes with the performance overhead of dynamic dispatching to execute the specific code supplied by the user. On the contrary, Renoir leverages Rust monomorphization, which translates operators to type-specific code, avoiding the runtime cost of dynamic dispatching, while also offering opportunities for further compile-time optimization such as inlining and loop fusion. This degree of optimization is typically available only in specialized engines, which work on specific data structured and offer predefined operations that cannot be customized with user-defined code. This is the case of engines that expose a SQL-like API, (see Section 6). By working in a restricted domain, they can pre-compile each operation to high-performance code. The software architecture of Renoir extends these performance benefits to user defined functions.

As closures can express arbitrarily complex operations, including calls to external libraries or even external systems in the middle of the dataflow computation, they bring vast potentials to extend the system without requiring a deep knowledge of its internals. This means that developers can customize the behavior of Renoir by using its high-level API and their customization will be compiled and optimized together with the framework code.

### 3.3.3. Parallelism and partitioning

In Renoir streams usually consist of multiple partitions. For instance, the `ParallelIteratorSource` builds a partitioned stream, where each partition holds the data produced by a different instance of the iterator. Partitioning is key to improve performance, as it enables multiple instances of the same operator to work in parallel, each on a different partition. For instance, the `map` example described above processes data in parallel, using as many instances of the `map` operator as the number of partitions in the input stream. This form of parallel execution is not possible in presence of operators, like `fold` and `reduce`, which intrinsically need to operate on the entire set of elements in the stream. To overcome this potential bottleneck, in presence of associative operations, Renoir provides an optimized, associative version of the `fold` and `reduce` operators, which splits the computation in two stages. First, the operation is performed on each partition, producing a set of intermediate results, then these partial results are combined to produce the final results. The example below shows the associative version of the summing job introduced in the previous section:

```
stream.reduce_assoc(|sum, i| sum + i);
```

In some cases, it may be necessary to control the way in which stream elements are associated to partitions. For instance, given a stream of sensor readings, if we want to count the number of

readings *for each sensor*, we need to ensure that all the readings of a given sensor are always processed by the same operator instance, which computes and stores the count. To support these scenarios, Renoir allows developers to explicitly control stream partitioning with the `group_by` operator. It takes in input a closure that computes a *key* for each element in the stream and repartitions the stream to guarantee that all elements having the same key will be in the same partition. This allows performing stateful operations with the guarantee that the instance responsible for a given key will receive all elements with that key.

Keys can be of any type that implements the `Hash` and `Eq` traits. As an example, the code below organizes an input stream of integers in two partitions, even and odd, by associating each element with a key that is 0 for even numbers and 1 for odd numbers. Then, it sums all elements in each partition. The result will be a stream with two partitions, each one made of a single element, representing the sum of all even (respectively, odd) numbers in the original stream.

```
stream.group_by(|i| i % 2)
    .reduce(|sum, i| sum + i);
```

Since the summing operation is associative, Renoir allows obtaining the same result in a more efficient way, using an optimized operator that combines `group_by` and `reduce` in a more parallel, associative way. In particular, the following code:

```
stream.group_by_reduce(
    |i| i % 2,
    |sum, i| *sum += i
);
```

creates a separate, keyed (sub)partitioning for each original partition of the input stream, applies the summing closure to each one of those (sub)partitions, producing a set of intermediate results (one for each key and each original partition of the input stream), then combines these partial results by key, producing the final stream composed of just two partitions, each one made of a single element: the sum of all even (respectively, odd) numbers in the original stream. When the key partitioning is not needed anymore (or when we want to re-partition a non-partitioned stream) the `shuffle` operator evenly redistributes input elements across a number of partitions decided by a configuration parameter or by a previous invocation of the `max_parallelism` operator.

### 3.3.4. Multi-stream operators

Renoir manages the definition of multiple streams within the same environment through the `split`, `zip`, `merge`, and `join` operators.

The `split` operator creates multiple copies of the same stream: each copy is independent of the others and may undergo a different sequence of transformations. In the code below, `s1` and `s2` are two copies of `stream`.

The `zip` operator combines two streams, associating each element of the first stream with one of the second and producing a stream of pairs (tuples with two elements). Elements are paired in order of arrival. In the code below, after traversing independent transformations (not shown) `s1` and `s2` are combined together using `zip`.

```
let mut splits = stream.split(2);
let s1 = splits.pop().unwrap();
```

```
let s2 = splits.pop().unwrap();
...
let s3 = s1.zip(s2);
```

Likewise, the `merge` operator applies to streams that transport the same type of elements to produce a new stream that outputs elements as they arrive in the input streams.

The `join` operator matches elements of a stream to those of another stream based on their value. It does so by using a closure to extract a key from the elements of the first and the second stream and matching elements with the same key. For instance, the listing below joins a stream of users and a stream of purchases (both made of pairs with user id as first entry and user or purchase information as second) using the user id as the joining key for both streams. Renoir supports inner, outer and left joins and different joining algorithms.

```
s1.join(s2,
    |(u_id, user_info)| *u_id, // u_id as key
    |(u_id, purchase_info)| *u_id // u_id as key
).map(|((u_id, user_info), (_, purchase_info))|
    (u_id, user_info, purchase_info));
```

### 3.4. Windows and time

Windows identify finite portions of unbounded datasets [22]. As common in stream processing systems [23], Renoir defines windows with two parameters: *size* determines how many elements they include and *slide* determines how frequently they are evaluated. Renoir offers both *count* windows, where *size* and *slide* are expressed in terms of number of elements, and *time* windows, where *size* and *slide* are expressed in terms of time. After defining the windowing on data, the next operator will apply its logic to each window to produce elements that will be sent along the stream. For instance, the code below uses a count window to compute, every 2 elements, the sum of the last 5 elements received.

```
stream.window_all(CountWindow::sliding(5, 2)).sum();
```

Windowing can also be performed on a stream that has been partitioned by key, using a `group_by` operator, in this case, the windowing logic is applied independently for each partition. For instance, the code below applies one window to even numbers and one to odd numbers. The example uses time windows that are evaluated every 20 ms over the elements received in the last 100 ms.

```
let window_def = ProcessingTimeWindow::sliding(
    Duration::from_millis(100),
    Duration::from_millis(20));
stream.group_by(|v| v % 2)
    .window(window_def)
    .max(); // Compute the max of the window
```

When dealing with time windows, Renoir supports two definitions of time: *processing* and *event* time. Processing time is the wall clock time of the machine computing the window. For instance, when executing the code snippet above, the process responsible for the partition of even numbers computes the sum of elements received in the last 100 ms according to the clock of the machine hosting that process. However, many scenarios need to decouple application time from execution time [4] to guarantee consistent results even in the case of delays or when processing historical data. To handle these cases, Renoir supports event time semantics. First, a timestamp is associated to the elements using the `add_timestamps`

operator. This is typically done at the source. Then, the window can be defined using the `EventTimeWindow`.

Renoir also supports *transaction windows*, whose opening and closing logic is based on the content of elements actually received through the stream. With this kind of windows, the user specifies a closure that determines when the current window should be opened and closed. For instance, the following code snippet defines a windowing logic that closes a window (and opens a new one) upon receiving an element greater than 100. The windowing logic seamlessly integrates with other operators like `group_by` and `sum`.

```
let window_def = TransactionWindow::new(|v|
  if v > 100 {
    TxCommand::Commit
  } else {
    TxCommand::None
  });
stream.group_by(|v| v % 2)
  .window(window_def)
  .sum(); // Compute the sum of the window
```

The examples presented above exploited pre-defined operators on windows, such as `sum` and `max`. To implement custom operators, Renoir provides two approaches. The first approach exposes an accumulator interface, such that the result of a computation over a window can be calculated incrementally as new elements enter the window one by one. The second approach exposes the entire content of the window when it closes, for those operators that cannot be implemented incrementally.

### 3.5. Iterations

Several algorithms for data analytics are iterative in nature. For instance, many machine learning algorithms iteratively refine a solution until certain quality criteria are met. Renoir supports iterative computations with two operators.

The `iterate` operator repeats a chain of operators until a terminating condition is met or a maximum number of iterations is reached. In the first iteration, the chain consumes elements from the input stream, while at each subsequent iteration, the chain operates on the results of the previous iteration. It holds a state variable that is updated at each iteration using a local (per partition) and a global folding logic, specified via closures. In the end, the operator returns two streams: one with the final value of the state variable, the other with the elements exiting the last iteration. For instance, the following code snippet repeats the `map` operator, that multiplies all elements by 2 at each iteration and computes their sum in the state variable. The iteration terminates when either 100 iterations have been executed or the sum is greater than 1000.

```
let (state, items) = s.iterate(
  100, // max iterations
  0, // initial state
  |s, state| s.map(|n| n * 2), // body
  |l_state: &mut i32, n|
    *l_state += n, // local fold (sum),
  |state, l_state|
    *state += l_state, // global fold (sum),
  |state| state < 1000, // terminating condition
);
```

The `replay` operator takes the same parameters, but instead of feeding the output of the current iteration as input of the next one, it

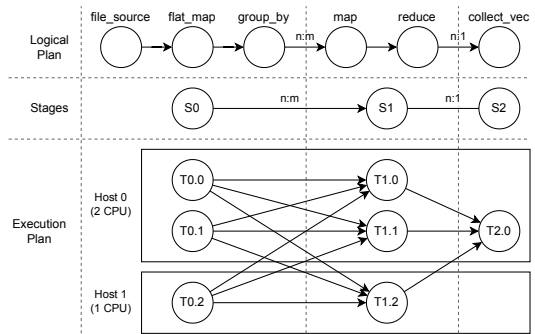

Figure 1: Deployment of the word count example.

replays the input stream until the termination condition is reached and returns the final value of the state variable.

## 4. Design and Implementation

Renoir is implemented as a Rust framework that offers the API discussed in Section 3. It is designed to scale horizontally by exploiting the resources of different machines, which we denote as *hosts*. Each host runs a *worker* process and each worker adopts multiple threads to run the computation in parallel.

To run a data processing job on a set of *hosts*, developers: (i) write and compile a Rust *driver program*, which defines the job using Renoir API; (ii) provide a configuration file that specifies the list of hosts and the computational resources (number of CPU cores) available; (iii) run the driver program, which starts the computation on the hosts. The driver program reads the configuration file and uses `ssh/scp` to: (i) connect to the hosts; (ii) send them the program executable, if needed; (iii) spawn one worker process per host. Workers connect to each other and coordinate to collectively execute the job. This workflow is inspired by MPI, the standard for compute-intensive tasks [24].

### 4.1. Job translation and deployment

To illustrate the process of translating a job into executable tasks and deploying them onto threads, we use the classic word count example, which counts the occurrences of each word in a large document. The following code snippet shows its implementation in Renoir<sup>2</sup>.

```
let result = env
  .stream_file(&file_path)
  .flat_map(|line| split_words(line))
  .group_by(|word: &String| word.clone())
  .map(|_| 1)
  .reduce(|(count, w)| *count += w)
  .collect_vec();
```

The `stream_file` helper method creates a parallel source that reads a file and produces a stream of text lines; `flat_map` extracts the words from each line (this is done by the `split_words` closure passed to the `flat_map` operator); `group_by` groups identical

<sup>2</sup>The proposed implementation works best for illustrating the translation process. More compact and efficient implementations are possible and will be used as part of our evaluation of Renoir in Section 5.

words together (the key is the entire word); `map` transforms each word into number 1; `reduce` sums up all numbers per partition (i.e., per word); finally, `collect_vec` gathers the final results (that is, the counts for each word) into a vector.

The translation and deployment process takes place when the driver program is executed and works in four steps, as illustrated in Fig. 1: (i) the job is analyzed to extract its *logical plan*; (ii) the logical plan is organized into *stages* of computation; (iii) each stage is instantiated as one or more *tasks*; (iv) tasks are deployed onto hosts as independent threads.

**Logical plan.** The logical plan is a graph representation of the job, where vertices are operators and edges are flows of data between operators. It contains the logical operators that transform the input streams generated by sources into the output streams consumed by sinks. In most cases, there is a one-to-one mapping between the operators defined in the driver program using Renoir API and the vertices in the logical plan, as in the word count example presented in Fig. 1. However, some high-level operators part of Renoir API translate into multiple operators in the logical plan. For instance, a `group_by_reduce` translates to three operators: a `key_by` that organizes data by key, a local `reduce` performed within each partition, and a global `reduce` that combines all partial results for each key together.

**Stages.** Operators in the logical plan are combined into *stages*: each stage consists of contiguous operators that do not change the partitioning of data. For instance, the word count example in Fig. 1 contains three stages: the first one (S0) starts at the source and terminates when the `group_by` operator repartitions data by word; the second one (S1) performs the mapping and reduction in parallel for each word; the third one (S2) brings the results of all partitions together.

Since stages represent the minimal unit of deployment and execution in Renoir, by combining operators into stages we avoid inter-task communication when it is not strictly necessary, that is, when the partitioning of data does not change when moving from the upstream operator to the downstream operator. In this case, passing of data from one operator to the next one takes place within the same stage as a normal function invocation. Additionally, this choice results in the code of stages being a monomorphized version of the Job code provided by the programmer, allowing for inlining and other compiler optimizations that involve the code of multiple operators.

**Execution plan and task deployment.** As anticipated above, each stage is instantiated multiple times into units of execution that we denote as *tasks*, which are deployed as independent threads within the workers running on hosts. For instance, Fig. 1 shows an execution plan deployed onto two hosts, where Host 0 runs two tasks for each stage (for instance, tasks T0.0 and T0.1 for stage S0) and Host 1 runs one task for each stage (for instance, task T0.2 for stage S0).

Knowing the number of tasks per stage to allocate into each host, each worker can autonomously determine, in a deterministic way, the set of tasks it is responsible for and how they should be connected to build the execution plan. This removes the need for coordination and synchronization at initialization time: each worker can start working independently from the others and the connections between different hosts can happen asynchronously.

## 4.2. Use of resources

By default, Renoir instantiates one task for each stage for each CPU core. Consequently, a host with  $n$  cores will execute  $n$  tasks for each stage. For instance, in Fig. 1, Host 0 has 2 CPU cores and is assigned 2 tasks for each stage, and Host 1 has 1 CPU core and is assigned a single task for each stage. While this default behavior can be changed by setting the number of tasks to be instantiated for each stage at each host in the configuration file, our experiments show that this default strategy most often yields the best performance. Indeed, by instantiating tasks as kernel threads, Renoir delegates task scheduling to the operating system, and the default strategy leaves a high degree of flexibility to the scheduler, which may adapt task interleaving to the heterogeneous demands of the different processing stages and of the different tasks within the same stage. If a stage is particularly resource demanding, its tasks may obtain all CPU cores for a large fraction of execution time; likewise, if data is not evenly distributed, tasks associated to larger partitions can get a larger fraction of execution time.

The downside of this approach is that it overcommits resources by spawning multiple threads for each CPU core, which increases the frequency of context switching. Our empirical evaluation shows that this is not a problem, especially considering that the overall design of Renoir contributes to alleviate this cost: for instance, as we explain in Section 4.3, tasks exchange batches of data instead of individual elements, thus ensuring that a task acquires CPU resources only when it has enough work to justify the context switch.

Other stream processing platforms such as Flink and Kafka Streams allocate a similar number of threads, but they use JVM threads, paying the overhead of the JVM architectural layer.

## 4.3. Communication

In Renoir, tasks communicate in one of two ways: in-memory channels or TCP sockets. Tasks running on the same host exploit shared memory through multiple-producer single-consumer (MPSC) channels<sup>3</sup> to achieve fast communication avoiding serialization. Tasks that run on different hosts use TCP channels.

To reduce the overhead of inter-task communication (both within the same host and across hosts), Renoir supports batching of data elements. With batching, subsequent elements that need to be delivered to the same recipient task are grouped in a batch. Renoir supports two batching policies: *fixed* and *adaptive*. With fixed batching, a batch is sent when it reaches the exact size that was specified. This policy guarantees that a fixed number of elements are delivered together over a channel, but may increase latency, as it needs to wait to complete a batch before sending it to the recipient. Adaptive batching also limits latency by sending a batch if a maximum timeout expires after the last batch was sent, regardless of the number of elements in the batch. Developers can configure the system with different batch sizes and different timeouts for adaptive batching, depending on their needs, potentially choosing different batching policies for different parts of the job graph.

The combined effect of using batching and in-memory channels is the fact that sending a batch of messages to a local worker consists of a single channel operation that puts the reference to the batch

<sup>3</sup><https://github.com/zesterer/flume>.

on the queue, transferring its ownership without any serialization or memory transfer. As anticipated, the use of batching is also beneficial for task scheduling. Indeed, when a task is scheduled for execution, it is guaranteed to have a minimum number of elements ready, which reduces the frequency of context switching. In addition, as data is always moved in batches, operators are compiled to code that operates on input vectors and produces output vectors of elements, and the compiler is free to merge multiple instructions into faster vectorized alternatives when possible.

#### 4.3.1. Flow control

In designing inter-task communication, we adopted an approach that is similar to what we presented for task scheduling and resource allocation: we delegate as much as possible to the operating system without replicating its functionalities within our framework. In particular, we delegate flow control to the underlying TCP implementation: if the receiving task cannot sustain the rate of data coming from the sending task, the sender will be automatically suspended until the receiver has processed previous data. This design differs from the typical approach of alternative dataflow engines, which implement flow control within the framework. For instance, Apache Flink adopts a mechanism denoted as back pressure<sup>4</sup>.

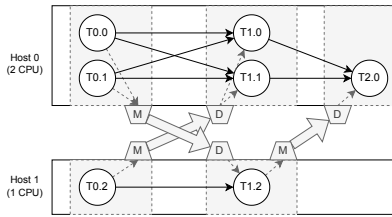

Figure 2: Communication between tasks in the word count example.

To limit the number of TCP connections, Renoir forces all tasks running on a host and belonging to the same stage to share the same TCP channel to communicate with tasks running on a different host and part of the downstream stage. For instance, Fig. 2 shows the communication channels for the word count example in Fig. 1. Host 0 has two tasks for stage 0: T0.0 and T0.1. They communicate with the tasks for stage 1 deployed on the same host (T1.0 and T1.1) using in-memory channels (black arrows), while they share the same TCP connection (large gray arrows) to communicate with task T1.2, deployed on Host 1. Likewise, T0.2 communicates with T1.2 using an in-memory channel and with T1.0 and T1.1 over a single TCP connection. Elements M and D in Fig. 2 represent multiplexer and demultiplexer components that allow multiple tasks to share the same TCP channel for communication.

Fig. 3 provide further details on this mechanism by focusing on the architectural components involved in the communication. As anticipated above, each Renoir worker includes a demultiplexer for each stage: this component receives batches of input elements for that stage from a TCP channel. Each batch is annotated with the

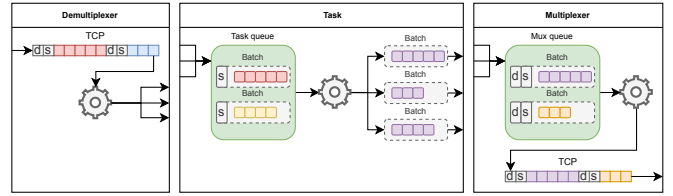

Figure 3: Communication between tasks on different processes.

sending task and the destination task (s and d in Fig. 3). The demultiplexer exploits this information to dispatch batches to recipient tasks. Each demultiplexer runs on a separate thread. Next, each task (as exemplified in the middle block in Fig. 3) receives incoming batches in a task queue, processes them according to the specific logic of the task, and delivers them to a multiplexer component (one per host and stage). Each multiplexer runs on a separate thread. It stores incoming batches in a mux queue, serializes them using the binary serialization format bincode [25], and forwards them to remote tasks of the next stage using a TCP channel.

#### 4.3.2. Timestamped streams and watermarks

When using event time, sources associate a *timestamp* metadata to each element in the stream they generate, and the runtime needs to guarantee timestamp order during processing. However, as the tasks of a stage evolve in parallel, they may not guarantee order. Renoir solves this problem with *watermarks* [5], an established mechanism in dataflow platforms. Watermarks are special elements periodically emitted by sources that contain a single timestamp  $t$  indicating that no elements with timestamp lower than  $t$  will be produced in the future. Under event time semantics, tasks are required to process data in order, so they buffer and reorder incoming elements before processing them. In particular, when a task T in a stage S receives a watermark greater than  $t$  from all incoming channels, it can be sure that it will not receive any other element with timestamp lower than or equal to  $t$ . At that point, it can process all elements up to timestamp  $t$ , and propagate the watermark  $t$  downstream.

#### 4.3.3. Iterations

Iterations (see Section 3.5) enable repeating a set of operations (the *body* of the iteration) until a given condition is met. This requires distributed coordination across the tasks that implement the iteration body to decide whether to start a new iteration.

Renoir implements this coordination logic using two implicit operators: an *Iteration* operator is put before the body and an *IterationLeader* operator is added after the body. The *Iteration* operator implements a barrier logic to synchronize all body tasks at each iteration. The *IterationLeader* collects updates from all hosts and computes a global state to decide whether the iteration should continue. In that case, the new state is broadcast to all *Iteration* operators through a *feedback link* and made available to all tasks. Inputs for the next iteration are also sent with feedback links, and the tasks in the body wait for the barrier from the *Iteration* operator before processing inputs for the next iteration.

#### 4.4. Discussion

To reach our current level of performance, we carefully designed and step-wise refined our system to exploit the benefits that come

<sup>4</sup>[https://nightlies.apache.org/flink/flink-docs-stable/docs/ops/monitoring/back\\_pressure/](https://nightlies.apache.org/flink/flink-docs-stable/docs/ops/monitoring/back_pressure/)



from the Rust programming language.

In JVM-based dataflow engines, operators accept the code defining their behavior in the form of functional interfaces. Developers define the logic of operators by creating custom implementations of these interfaces, and the engine selects the correct implementation at runtime through dynamic dispatch. The first versions of `Renoir` relied on similar design strategies, but we soon moved from dynamic dispatch to statically compiled generics to capture user-defined logic for operators, resulting in significant performance improvements. Rust generics are monomorphized and compiled to type-specific and optimized code for each version of the generic call. Starting from this insight, we decided to make operators generics also with respect to their upstream operators. This way, operators that are chained to form stages of execution are compiled together, allowing optimizations such as inlining that cross the boundaries of individual operators. Moreover, being `Renoir` a library that is compiled together with user-defined code, compile-time optimizations can also take place between library code and user code. We used the higher-kind polymorphism capabilities of Rust to enable generics even in presence of complex operators. As a concrete example, the windowing logic is generic over both the windowing strategy and the type of the state being accumulated during window evaluation. We implemented it as a Rust Trait with generic associated types, which enable developers to easily extend the API with new strategies and new accumulators, while still avoiding dynamic dispatching.

In summary, our implementation entirely avoids dynamic dispatching for task execution, communication, and serialization, and enables the compiler to produce type-specific code with holistic optimizations that span library code and user-defined code across multiple operators. Thanks to the safety guarantees and strict aliasing rule typical of the Rust language, the Rust compiler may automatically inline and perform loop fusion and fission more freely than the C++ compilers, and this becomes even more relevant on modern hardware where the compiler can exploit vectorized instructions.

## 5. Evaluation

The goal of this evaluation is to assess the performance and ease of use of `Renoir`, in absolute terms and in comparison with: (i) state-of-the-art data processing platforms, and (ii) lower-level programming primitives used to implement high-performance parallel and distributed computations.

To do so, we implemented various data processing tasks, which cover the key functionalities offered by `Renoir` and other state-of-the-art data processing platforms. We measure performance in terms of throughput, latency, and (horizontal and vertical) scalability. We evaluate the complexity of each implementation both quantitatively, by counting the lines of code, and qualitatively, by observing the aspects that the different programming interfaces can abstract away. The section is organized as follows: Section 5.1 presents the setup we use in our experiments. Section 5.2 compares the programming model of `Renoir` with that of alternative solutions. Section 5.3 and Section 5.4 measure the performance and horizontal scalability for batch and stream processing workloads, respectively. Section 5.5 measures vertical scalability within a single machine. Finally, Section 5.6 summarizes and discusses our findings.

### 5.1. Experiment setup

We present the experiment setup in terms of systems under test, benchmarks adopted, hardware and software configurations, and evaluation methodology.

#### 5.1.1. Systems under test

We compare `Renoir` with the following alternative solutions for distributed data processing and high-performance parallel and distributed computations.

**Apache Flink.** Apache Flink (`Flink` from now on) is a state-of-the-art dataflow processing system, widely used in industrial settings. It is written in Java and offers a high-level API to define batch and stream processing computations and deploy them on a cluster of nodes. We consider Flink as representative of high-level data processing platforms, because it is frequently adopted as a reference in the recent literature, and offers a level of performance that is comparable or better than competing commercial systems [26].

**OpenMPI.** OpenMPI (`MPI` from now on) is an implementation of the Message Passing Interface specification for C/C++. It is used in high-performance computing and scientific computations to distribute a computational workload among multiple machines in a cluster. We consider MPI as representative of the level of performance that can be achieved with custom C++ solutions and low-level communication primitives for data distribution.

**Timely Dataflow.** First introduced in the Naiad system [27], Timely Dataflow (`Timely` from now on) is a generalization of the dataflow model to better express computations that iteratively and incrementally update some mutable state. Like the dataflow model, it is designed to run parallel computations on a cluster of nodes. The implementation we consider for our comparison is written in Rust<sup>5</sup>. To implement some benchmarks, we use Differential Dataflow [28], a higher-level programming interface for incremental computations written on top of `Timely`. We consider `Timely` for two reasons. First, it shares with `Renoir` the goal of finding a balance between the expressiveness and ease of use of the programming model and the performance of the implementing platform. As such, it represents another point in the design space of data processing systems. Second, it relies on the same Rust programming language as `Renoir`, allowing for a comparison of programming interfaces and system design that build on a common ground. We found that fully utilizing the potential of the system requires a deep understanding of how its timestamping logic and that improper use of timestamps often lead to degraded performance. For this reason, we compare `Renoir` and `Timely` on a subset of benchmarks for which we found an implementation from the authors, thus ensuring a proper use of the system.

**OpenMP.** OpenMP<sup>6</sup> (`OMP` from now on) is a specification of an API considered the de-facto standard for high-performance parallel computations. We adopt the implementation of `OMP` provided by the gcc compiler and we use it as a reference comparison for the performance of `Renoir` within a single machine.

<sup>5</sup><https://github.com/TimeleyDataflow/timely-dataflow>

<sup>6</sup><https://www.openmp.org>

**Rayon.** Rayon<sup>7</sup> (Rayon from now on) is a Rust library for parallel processing. It is one of the most popular tools used to perform data-parallel computations on a single host in Rust. We consider Rayon for two reasons. First, it enables comparing the programming interface of Renoir with a simple and idiomatic way to express data-parallel computations in Rust. Second, it allows us to measure the overhead of Renoir when used within a single host and to compare it with a widely adopted library designed specifically for this purpose.

### 5.1.2. Benchmarks

The set of benchmarks has been chosen to highlight different patterns of computations that are common in batch and stream processing applications.

**Word count.** Word count (*wc*) is the classic example used to present the dataflow model, as it well emphasizes key features of the model such as data parallelism and repartitioning of data by key. The task consists in reading words from a file and counting the occurrences of each word. The input used for this task contains 4GB of books in plain text format from the project Gutenberg repository of books [29].

**Vehicle collisions.** The vehicle collisions (*coll*) benchmark requires computing multiple queries of increasing complexity over a large set of data. The input used for this benchmark is a public dataset of vehicle collisions [30] in the form of a CSV file containing 4.2GB of data. The queries are the following: 1. compute the number of lethal accidents per week; 2. compute the number of accidents and percentage of lethal accidents per contributing factor; 3. compute the number of accidents and average number of lethal accidents per week per borough.

**K-Means.** K-Means (*k-means*) is a clustering algorithm that partitions a set of  $d$ -dimensional points in  $k$  non-overlapping clusters. It is an iterative, machine learning algorithm that closes in to a local optimum at each iteration. We use a dataset of up to 100 million 2D points (2GB of data).

**Connected components.** Connected components (*conn*) takes in input a graph and computes the maximal sub-graphs whose nodes are all reachable from each other. It is an iterative graph algorithm that performs a join operation inside the loop body. We use a dataset of 20k nodes and 5M edges, where nodes are represented as integer numbers.

**Transitive closure.** Transitive closure (*tr-clos*) is another iterative graph algorithm, which computes the transitive closure of a relation graph. Differently from the *conn* example, the number of edges in the set grows at each iteration, reaching  $O(n^2)$  nodes at the end of the execution. We use a dataset of 2k nodes and 3k edges, where nodes are represented as integer numbers.

**Enumeration of triangles.** Enumeration of triangles (*tri*) is an example of a non-iterative graph algorithm: it computes the number of node triplets that are directly connected in an undirected graph. We use a dataset of 1.5k nodes and 900k edges, where nodes are represented as integer numbers.

**Pagerank.** Pagerank (*pagerank*) is a well known graph algorithm used to estimate the importance of a node in a graph. Each node starts with the same *rank* and at each iteration, the rank is redistributed along the edges to other nodes. We use a dataset of 80k nodes and 2.5M edges, where nodes are represented as integer numbers.

**Collatz conjecture.** The collatz conjecture (*collatz*) benchmark computes the collatz conjecture steps for all the numbers from 1 to 1 billion to find which number takes the highest number of steps before converging to 1. This is an iterative algorithm that does not require intermediate synchronization. Accordingly, it is embarrassingly parallel but the workload for each number is very different, which makes this algorithm well suited to evaluate the ability of a solution to cope with unbalanced workloads. We use it to compare solutions for parallel computations.

**Nexmark.** The Nexmark (*nexmark*) benchmark suite [31] is increasingly being used for benchmarking stream processing platforms. It includes streaming queries with various complexities, ranging from simple stateless transformations of the input elements to stateful joins of multiple streams.

### 5.1.3. Hardware and software configuration

Unless otherwise specified, we run the experiments on an AWS cluster composed of *c5.2xlarge* instances, equipped with 4-cores/8-threads processors and 16GB of RAM each, running Ubuntu server 22.04, residing in the *us-east-2* zone, and communicating through the internal AWS network with an average ping time of 0.1ms. Renoir, Timely and Rayon programs are compiled with *rustc* 1.66.1 in release mode with *thin* link-time optimization active and *cpu-target=native*. We use *Flink* 1.16.0 executed on the *OpenJDK* 11.0.17, with 12GB of RAM allocated to *TaskManagers*. To offer a fair comparison, we disable checkpointing to durable storage in *Flink*, as Renoir currently does not support persistence or fault-tolerance. We compile *MPI* and *OMP* programs with *gcc* 11.3.0 using *OpenMPI* 4.1.2 and *OpenMP* 4.5 and maximum optimization level.

### 5.1.4. Metrics and methodology

We use finite input datasets and measure the total execution time for both batch and stream processing tasks, which measures the maximum throughput of data a system can handle. For the streaming benchmarks we also measure latency of processing, defined as the difference between the arrival time, at the source, of the input element that triggered a certain output and the time at which that output element was delivered to the sink. To measure this form of latency, we use a single source and a single sink deployed on the same physical machine, and exploit the real-time clock of this machine to compute the timing. Each experiment is executed at least 4 times, discarding the result of the first run, which is used as a warm-up, allowing the operating system to cache the input in memory. We measure horizontal scalability from 1 to 4 hosts (that is, from 8 to 32 cores). For the batch benchmarks, our measurements include the cost of job deployment, calculating the time between submission of the job and its completion, rather than only measuring the processing time. Indeed, in real-world settings, deployment time contributes to the cost of running a dataflow application. For the streaming benchmarks, which

<sup>7</sup><https://docs.rs/rayon/latest/rayon/>

represent long running, continuous computations, we only consider the time required to process data, excluding job deployment.

## 5.2. Programming model

In this section, we analyze the programming models of the systems under test. We recognize that assessing code complexity is difficult and highly subjective, and we approach the problem by (i) measuring the number of lines of code for each benchmark as a coarse-grained indication of complexity; (ii) reporting the key features that some programming models expose to the developers and may contribute to code complexity.

Table 1 reports the lines of code for each benchmark. It follows the same structure as the remainder of the paper. First, it presents batch processing workloads, which we use to compare `Renoir`, `Flink`, `MPI`, and `Timely` in Section 5.3. Then, it presents the `nexmark` stream processing benchmark, which we use to compare `Renoir`, `Flink`<sup>8</sup>, and `Timely` in Section 5.4. Finally, it presents benchmarks for parallel computations on a single host, which we use to compare `Renoir`, `OMP`, and `Rayon` in Section 5.5. To ensure a fair comparison, we adopted the following approach: we excluded comments, imports, input parsing and output formatting, we formatted the Rust, Java and C/C++ code using the default formatter provided with the respective language extensions in Visual Studio Code. In addition, Fig. 4 reports the average size in bytes of the source files for each solution after being compressed with `gzip`: the compression algorithm limits the contribution of common language keywords, and partially masks the differences in verbosity between languages.

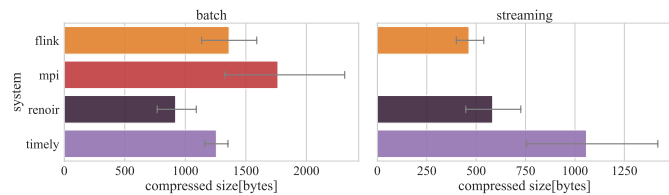

Figure 4: Bytes of the Gzip compressed source files: average and 90% confidence interval.

For both batch and streaming benchmarks, solutions written in `Renoir` have roughly the same numbers of lines of code as those written in `Flink`. Overall, the `Flink` versions are slightly longer, with a total of 1037 lines of code to implement all batch and streaming benchmarks, with respect to 853 lines of code for `Renoir`. Similar differences appear in the size of the compressed source files (Fig. 4), indicating that the gap may not be completely attributed to the different verbosity of the programming languages adopted.

Solutions written in `Renoir` present a similar structure as those in `Flink`, but also closely resemble the syntax of Rust standard iterators, making it easy for developers to port sequential Rust code to `Renoir`. Some differences between `Renoir` and `Flink` appear in iterative algorithms. For instance, in `k-means`, `Flink` uses broadcast variables to propagate shared state, while `Renoir` operators can interact with the shared state through a smart pointer passed to the closure that defines the inner loop.

<sup>8</sup>For the `nexmark` benchmarks we report the lines of code of the queries using the `Flink SQL API`

Conversely, `MPI` requires more coding effort and results in significantly more lines of code than `Renoir`: 4.9 $\times$  more lines in `wc`, 2.6 $\times$  in `coll`, 1.77 $\times$  in `k-means`, 4.6 $\times$  in `tri`. The compressed source files (Fig. 4) are about twice as large in `MPI` than in `Renoir`. Only `pagerank` presents almost the same lines of code, as in this case the programming model of `MPI`, based on mutable state, helps simplifying the implementation. Most importantly, `MPI` developers need to deal with low-level concerns that are abstracted away in `Renoir` and `Flink`: they need to select the data structures that encode input data and store intermediate results, they need to decide and implement serialization and deserialization strategies, they need to decide how communication and serialization overlaps with processing. As we will show in the following, exposing these concerns gives a high degree of freedom to developers, but may also be an obstacle to achieve high performance, as code optimization may become a difficult task. In fact, `Renoir` can outperform `MPI` in several benchmarks, mainly due to better serialization and deserialization strategies that exploit procedural macros, which would be hard to replicate in `MPI`.

In terms of code safety, the low-level communication primitives of `MPI` must be used with care to prevent deadlocks and data races. Additionally, C++ requires developers to manually allocate and manage the memory used to store data moving through the system, a complex task vulnerable to errors such as memory leaks or invalid references. Rust (used to develop `Renoir` and `Timely`) avoids most of these issues with its automatic memory model and without incurring the overhead of garbage collection as in Java (used to develop `Flink`).

The programming model of `Timely` represents a different trade-off between ease of use and performance. It generalizes the dataflow model by exposing the management of timestamps and watermarks to the application, thus allowing it to control how the computation and its results evolve over time. However, its generality comes at the price of additional complexity, which reflects in a higher number of lines of code. Our experience also shows that properly handling the programming abstractions it exposes (e.g., timestamps to govern the evolution of a computation) may not be easy, and improper use may lead to poor performance. In principle, the architecture of `Renoir` could support the same abstraction, but we decided to hide the watermarking logic from the application layer to simplify the programming model. In practice, we only used `Timely` with benchmarks for which we could find an available implementation, to be confident about their correctness and avoid misuse of the programming model, which could be detrimental for performance. In some cases, we had to adapt our implementation to make it comparable with that of `Timely`. For instance, the `Timely` implementation of `pagerank` adopts a higher-level library (differential dataflow) that hides some of the complexities of `Timely`, but introduces additional constraints as the impossibility of using floating point numbers to express ranks.

When compared with libraries for parallel computations, we observe that `Renoir` has nearly the same number of lines of code as `Rayon`. Indeed, both systems mimic the interface of standard Rust iterators, leading to compact and paradigmatic Rust code. The higher number of lines of code in `OMP` are mainly due to the language being used (C++), which brings the same verbosity and safety concerns discussed for `MPI`. However, `OMP` code is simpler

Batch (Section 5.3)				
	Renoir	Flink	MPI	Timely
wc	28	26	138	93
coll	192	139	503	n.a.
k-means	125	158	222	n.a.
pagerank	59	125	74	73
conn	70	97	85	n.a.
tri	44	159	204	n.a.
tr-clos	39	82	162	n.a.

Streaming (Section 5.4)			
	Renoir	Flink	Timely
nexmark_common	67	80	217
nexmark.Q0	3	11	7
nexmark.Q1	9	17	9
nexmark.Q2	6	8	11
nexmark.Q3	23	15	59
nexmark.Q4	58	21	125
nexmark.Q5	20	39	119
nexmark.Q6	64	17	128
nexmark.Q7	17	19	70
nexmark.Q8	29	24	65

Single host (Section 5.5)			
	Renoir	OMP	Rayon
wc	29	84	39
k-means	125	142	131
collatz	30	48	23

Table 1: Lines of code used to implement each benchmark.

than the equivalent MPI code, as the use of shared memory avoids serialization and inter-process communication concerns.

Notice that the programming and execution model of Renoir and MPI requires compiling and running a separate executable for each data processing job, whereas platforms such as Flink can run multiple jobs simultaneously, potentially optimizing the provisioning of resources.

### 5.3. Performance: batch workloads

In this section, we evaluate the performance and scalability of Renoir and alternative solutions for batch processing workloads. For each workload, we measure the execution time while moving from one to 4 hosts. Fig. 5 presents the results we measured.

#### 5.3.1. Word count (*wc*)

Fig. 5a shows the execution time and scalability for *wc*. Renoir completes the task in 34.97s on a single host, and in 9.56s on 4 hosts. In comparison, Flink is more than 6× slower: 217.14s on a single host and 60.79s on 4 hosts.

We optimized the MPI code in many ways. In the reduction phase, Renoir and Flink partition the dataset by word and perform the reduction in parallel, before collecting all the results in a single process and saving the results. Given the limited size of the partial results, in the MPI implementation, we skip the intermediate phase and collect all partial results directly in a single process, saving one communication step. We also made different experiments to exploit thread-level parallelism using OpenMP, but we obtained better results with one MPI process per core, with each process using a single thread. Despite these custom-made optimizations, MPI is still about 2.5× slower than Renoir. A detailed analysis showed a bottleneck when reading data from file using functions from the standard C++ library and parsing using regular expressions (the same we do in Flink and Renoir).

Thus, we implemented an additional version with ad-hoc file reading (by mapping the file in memory with `mmap`) and a simplified parser that only considers 7-bit ASCII instead of UTF-8 encoded text. This version is presented in Fig. 5b and is labeled MPI-`mmap`. It reduces the gap with Renoir, but at the cost of additional code complexity and reduced generality and reusability, and remains about 1.5× slower with 4 hosts. We attribute this difference to the different serialization strategy: MPI uses fixed-size arrays to represent strings whereas Renoir uses a more compact binary serialization format. Fig. 5b also shows the performance of an optimized version of *wc* in Renoir, which exploits the same strategy as MPI by skipping the intermediate reduction phase. This version only

requires 10 additional lines of code: in particular, it does not exploit a `group_by_count` operator, but it implements the count using an associative `fold`. This small change reduces the execution time by nearly 30%, and Renoir can complete the task in 6.7s with 4 hosts.

Going back to the comparison in Fig. 5a, Timely completes the task in 51.24s on one host and 22.33s on 4 hosts, which means up to 2.3× higher execution time than Renoir. Timely adopts a different execution model with respect to Renoir, where each worker thread is responsible for part of the dataflow graph, it loops through the operators within that part of the graph, and it executes one operator at a time. This architectural difference leads to different performance and scalability characteristics in the experiments we performed.

In terms of horizontal scaling, Renoir and Flink achieve near linear scalability: when moving from 1 to 4 hosts, we measure a speedup of 3.65× for Renoir and 3.57× for Flink. Indeed, the most expensive operations, namely reading and parsing the file, and performing a partial count, are executed in parallel without synchronization across processes. MPI has a speedup of 2.59× and the MPI-`mmap` version has a scalability of only 1.39×: again, we suspect this may be due to a less efficient serialization strategy that introduces more network traffic. However, further optimizing serialization for the specific problem at hand would require significant effort, while Renoir offers better performance without any complexity about serialization being exposed to the developer. Timely presents a similar speedup of 2.29×. This is a general characteristic we observed in our experiments: Timely exhibits a lower scalability than Renoir. As an additional metric of the performance of the systems, we measured weak scalability for *wc*, reporting the results in Fig. 6. In this experiment, we used a dataset of 1GB when running on a single host and increased the size of the dataset proportionally to the number of hosts, thus keeping a ratio of 1GB per host. When considering the non-optimized version of the benchmark (Fig. 6a), all systems under test show near constant execution time when moving to more hosts. For instance, the execution time of Renoir increases by only 5% when moving from 1 to 4 hosts. When considering the optimized version (Fig. 6b), both Renoir and MPI increase the execution time by more than 65% when moving from 1 to 4 hosts. This is due to the limited complexity of the task, which makes the overhead of communication and coordination across hosts more visible.

#### 5.3.2. Vehicle collisions (*coll*)

This workload presents two differences with respect to *wc*: (i) it computes three distinct output results starting from the same input

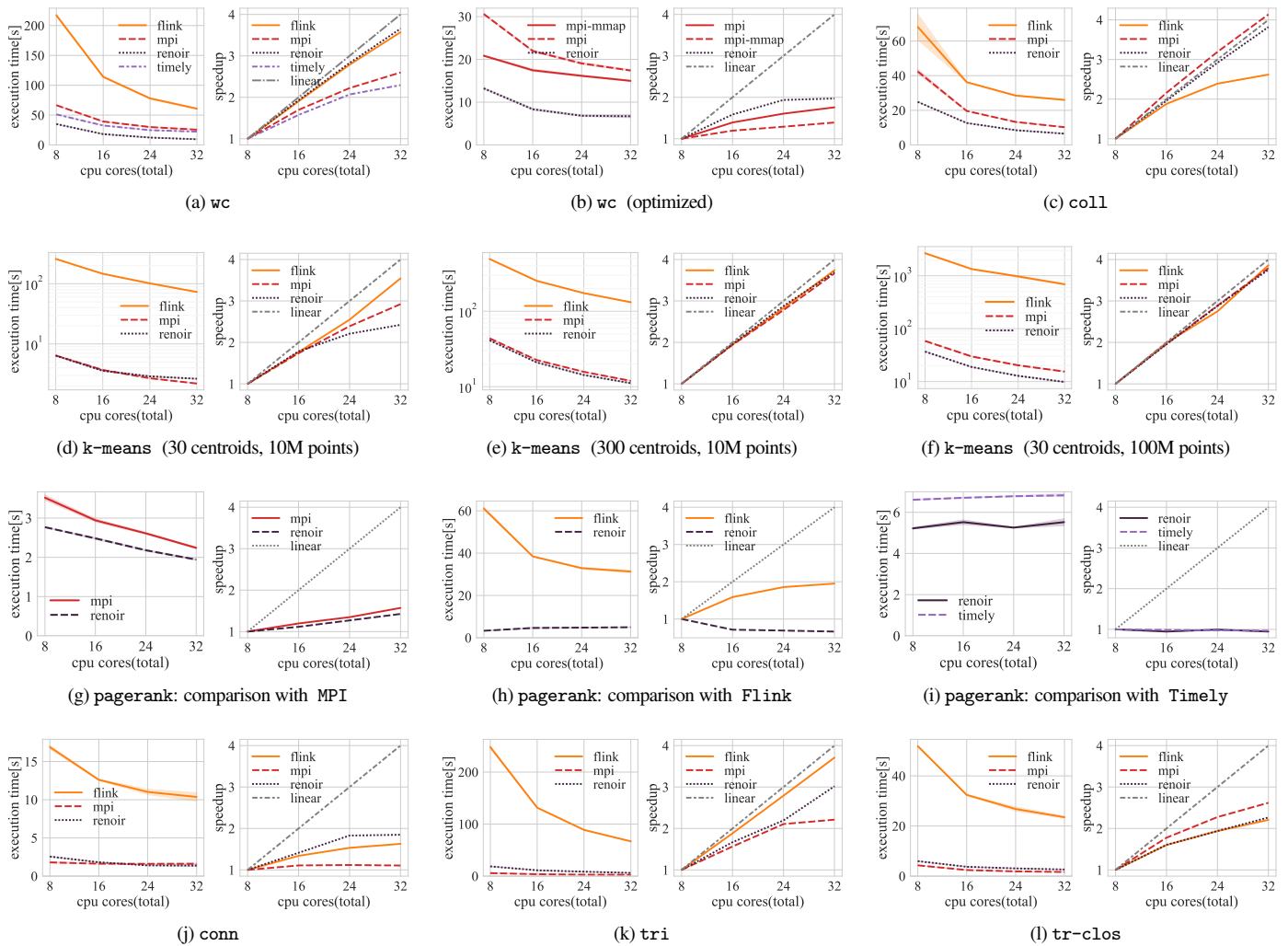

Figure 5: Performance with batch workloads. For each workload we show execution time (left) and scalability (right).

data; (ii) each computation involves more operators.

Renoir remains the fastest system, completing the task in 24.87s on a single host and in 6.51s on 4 hosts. In comparison, Flink requires 68.15s on one host and 26.02s on 4 hosts, while MPI requires 42.41s on a single host and 10.25s on 4 hosts. With respect to *wc*, the increased computational complexity of the operators partially masks the overhead of Flink, reducing the gap with respect to MPI and Renoir. One possible explanation for the lower performance of MPI is that the computations required to obtain the three output results are executed one after the other: indeed, implementing the strategies to run them in parallel would require a radical change of the code and would expose the additional complexity of managing parallel execution. Conversely, in Flink and Renoir, the computations of different output results can be executed in parallel without any additional code complexity. Furthermore, intermediate results can be reused: in the specific case of *coll*, Flink only parses the input once, and reuses the parsed input for all computations. We avoided this optimization in Renoir to enable a more fair comparison with MPI.

### 5.3.3. KMeans (*k-means*)

We used *k-means* to assess the performance of Renoir and competing platforms in executing a machine learning algorithm. Recall that the algorithm takes in input 2D points and clusters them around a set of centroids. At each iteration, the algorithm analyzes all points and computes the distance with the current set of centroids. It updates the position of centroids until they become stable. New centroids are broadcast at each iteration. We performed various experiments changing the size of the input and the number of centroids. We set a maximum number of 30 iterations to limit the execution time of experiments.

Fig. 5d shows the performance and scalability of the systems under test when using an input of 10M points (about 200MB of data) and 30 centroids. Renoir and MPI show comparable performance: their execution time is almost identical on a single host, but MPI scales slightly better and becomes about 30% faster on 4 hosts. Flink is significantly less efficient (notice the log-scale in Fig. 5d, Fig. 5e, Fig. 5f) in performing this iterative task, with an execution time that is from 25× to 40× higher than Renoir.

Fig. 5e shows the performance of the three systems when

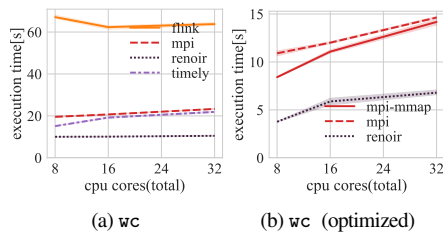

Figure 6: Weak scalability for `wc` (1GB per host).

increasing the number of centroids from 30 to 300. Increasing the number of centroids adds computational complexity, as input points need to be compared with each centroid at each iteration. This decreases the gap between Flink and the other two systems, as the cost of communication and synchronization becomes smaller in comparison with the cost of computing. Renoir remains the fastest system, with MPI being marginally (at most 10%) slower, and Flink reducing its gap but still remaining more than 10 $\times$  slower than Renoir.

Fig. 5f shows the performance of the three systems when increasing the number of points from 10M to 100M (about 2GB of data). This workload stresses communication, as points are transferred at each iteration. Also in this case, Renoir shows a level of performance that is comparable to MPI, with a slightly better scalability, while Flink is about 70 times slower, indicating the effectiveness of Renoir in terms of communication.

#### 5.3.4. Pagerank (*pagerank*)

The pagerank benchmark may be implemented in different ways. We present three different implementations, each of them mimicking a reference implementation in one of the other systems under test. This enables us to explore a larger area of design and implementation strategies, while offering a comparison with other systems that is as fair as possible.

The first approach stores the current rank of nodes in a mutable state. The list of adjacent nodes is replicated within each process as an additional immutable state. At each iteration, each process distributes part of its current rank to adjacent nodes, which will use it to update their rank in the next iteration. We implemented this approach in MPI and we present a performance comparison in Fig. 5g. MPI uses messages between nodes to distribute the current rank. Renoir mimics the same behavior by storing the current rank in a stateful operator (a `rich_map`) and keeping a single copy of the list of adjacent nodes per process; the rank is distributed to adjacent nodes by propagating it back in the feedback stream of an iteration. This is the most efficient implementation of the algorithm: Renoir and MPI show similar performance, with Renoir completing the task about 10% faster than MPI.

The second approach mimics the reference implementation found in the official repository of Flink. Flink considers both the list of adjacent nodes and the current rank of nodes as two streams that are joined together at each iteration to produce the new rank for each node (a new stream). It then compares the current and previous rank to check convergence and terminate the loop. Fig. 5h shows the performance of this implementation for Flink and

Renoir. Clearly, this implementation is not optimal for Renoir, which can store the list of adjacent nodes as part of the state of each process, as exemplified in the first approach. Yet, Renoir remains at least 6 $\times$  faster than Flink when using the same implementation strategy. However, the need to repeatedly join the input streams and transfer them over the network affects scalability, which in this case is even negative.

The ability to replicate the strategies used in MPI speaks of the flexibility of the Renoir execution model. Renoir spawns a process for each host, which shares the same address space with all the tasks running on the same host. Combined with the safety guarantees of the Rust programming language, this allows developers to implement optimized patterns of memory access. In the specific case of pagerank, all tasks within a host can access the same copy of the list of adjacent nodes. This is simply not possible in engines like Flink, where users code is shipped to remote executors that are not under the control of developers.

Finally, Fig. 5i uses the reference implementation of pagerank for Differential Dataflow, an abstraction built on top of Timely. We mimic the same approach in Renoir and we adopt the same workload to ensure a fair comparison. Specifically, this version of pagerank uses integer numbers instead of floating point numbers to represent the rank of the nodes. The choice to use integers is forced by Timely, which requires that the types used in the feedback of a loop have mathematical characteristics which floats do not have. Interestingly, this implementation shows a speedup close to zero for Renoir but also for Timely. Also in this case, Renoir is consistently at least 20% faster than Timely.

#### 5.3.5. Connected components (*conn*)

`conn` is an iterative algorithm to compute the connected components of a graph. The algorithm iteratively updates the component to which each node belongs: a component  $c$  is represented by the numerical identifier of the smallest node currently part of  $c$ . If the algorithm discovers that a node  $n$  is connected to a component  $c$  with an identifier smaller than  $n$ , it assigns  $n$  to  $c$  and propagates the new association to the next iteration, where nodes directly connected to  $n$  are evaluated and possibly included into  $c$ . Flink natively supports this type of iterations that continuously update a mutable state. They are defined as *delta-iterations* in the Flink documentation. In Renoir, we implement a similar logic using the `iterate` operator: we store the association of nodes to components in the iteration state, and we propagate to the next iteration only the associations that have changed during the current iteration.

Fig. 5j shows the execution time and scalability of the systems under test. Scalability in `conn` is limited by the need to propagate state changes to all hosts at each iteration. This is visible for all the systems under test, but in particular for MPI, which has a maximum speedup of only 1.1 $\times$  when moving from 1 to 4 hosts. In comparison, Flink and Renoir have a speedup of 1.63 $\times$  and 1.85 $\times$ , respectively. In absolute terms, Renoir is almost identical to MPI on a single host (1.81s vs 1.80s) but becomes faster on 4 hosts (1.38s vs 1.62s). Flink remains about an order of magnitude slower with total execution time that moves from 16.89s on a single host to 10.37s on 4 hosts.

### 5.3.6. Enumerate triangles (*tri*)

*tri* is a graph algorithm that does not require multiple iterative steps, as it needs to verify a local property: which triples of nodes are directly connected with each other, forming a triangle.

*Flink* implements this algorithm with a join operation to complete the triangle. Instead, *MPI* stores the complete adjacency list in memory, which is more efficient as it enables random access. In principle, *Renoir* could also exploit shared state within processes to optimize the job. However, we decided to implement the same approach used by *Flink*, which is easier to express in a dataflow engine.

Fig. 5k shows the execution time and scalability of the systems under test when computing *tri*. *MPI* is the fastest systems, more than 3× faster than *Renoir* on a single host. Thanks to a better scalability (3× vs 2.2× speedup), *Renoir* reduces the gap on 4 hosts, where *Renoir* and *MPI* complete the task in 6.19s and 2.61s, respectively. *Flink* remains significantly slower, with an execution time of 66.8s on 4 hosts.

### 5.3.7. Transitive closure (*tr-clos*)

*tr-clos* is an iterative graph algorithm that presents different characteristics with respect to *conn*. In particular, it iteratively enriches a partial result that is proportional to the number of edges (quadratic with respect to the number of nodes).

Fig. 5l shows the execution time and scalability of the systems under test when performing this task. *Renoir* shows execution times from 5.98s on 1 host to 2.63s on 4 hosts (2.26× speedup), while *Flink* is about 8 times slower, with a maximum speedup of 2.4× when moving from 1 to 4 hosts. Consistently with what we reported for *tri*, the *MPI* implementation yields better results by saving the adjacency list as mutable state, leading to an execution time of 1.64s on 4 hosts (2.61× speedup).

## 5.4. Performance: streaming workloads

In this section, we evaluate the performance of *Renoir* and alternative solutions for stream processing workloads using *nexmark*. We consider all original *nexmark* queries (Q1–Q8) and the passthrough query Q0, which measures the monitoring overhead, that is, the time for analyzing the entire input data without performing any concrete data transformation.

We compare *Renoir* with other stream processing platforms: *Flink* and *Timely*. We exclude from this analysis *MPI* as it is not designed for streaming workloads. We adopt the reference *Flink* implementation available in the *nexmark* repository<sup>9</sup>, and the *Timely* implementation made available by the authors as part of the Megaphone project<sup>10</sup>. For *Renoir*, we generate input data using a parallel iterator source, making sure that it is consistent with the specification of the benchmark.

Fig. 7 shows the time required to process the entire workload for all queries using 4 hosts (32 cores). *Renoir* consistently outperforms *Flink*, completing queries from 3.4× to 57.8× faster, depending on the query. *Flink* cannot even terminate query Q6, which *Renoir* computes in about 17.7s. The execution times of

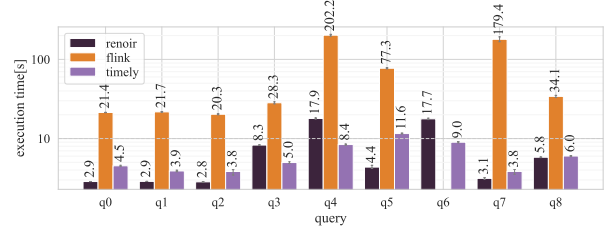

Figure 7: *nexmark* queries: execution time with 32 cores.

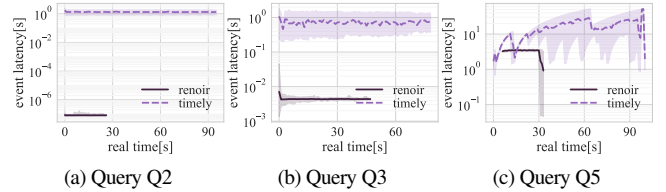

Figure 8: *nexmark*: latency for queries Q2, Q3, Q5.

*Renoir* and *Timely* are comparable, and *Renoir* is faster in 6 out of 9 queries. In queries Q4 and Q6 *Timely* is about twice as fast as *Renoir*. We attribute these results to the different ways in which the two systems implement the windowing logic required in the queries: the *Timely* implementation adopts a custom windowing implementation that simplifies the way in which watermarks are handled. While we could replicate the same approach in *Renoir* by writing ad-hoc windowing operators for the specific queries, we decided to use the standard window operator offered by the framework, which simplifies the code.

Fig. 8 shows the latency of *Renoir* for three representative queries with heterogeneous characteristics (Q2, Q3, and Q5), and compares it with *Timely*, the system that presents a similar execution time. Fig. 8 plots the mean latency over time in 1s windows, with the 99th percentile band (shaded area around each line). Recall that, to measure latency, we use a single source and a single sink placed on the same machine, consequently, the results in Fig. 8 are not directly comparable with those in Fig. 7.

For *Timely*, due to the cooperative scheduling implementation, developers need to explicitly use timestamps to indicate how frequently to alternate between sending (batches of) events and processing them, which clearly affects latency. We experimented with different fixed and dynamic intervals as detailed below, Fig. 8 reports the results when processing 100ms of events at each round.

Query Q2 (Fig. 8a) requires a single stage of stateless computations. In this setting, *Renoir* never splits the input data into partitions after reading from the sources, and executes the entire computation sequentially, which leads to a latency of about 80ms. Instead, the latency in *Timely* is dominated by the evaluation interval, which is set to 100ms: reducing this interval to 1ms indeed improves latency, but it still remains around 10ms, while the overall execution time further increases to more than 140s. In comparison, the execution time of *Renoir* is below 30s.

Query Q3 (Fig. 8b) includes multiple stages of computation and a join. In *Renoir*, this introduces inter-stage communication, which increases the latency to about 5.5ms. The latency of *Timely*

<sup>9</sup><https://github.com/nexmark/nexmark>

<sup>10</sup><https://github.com/strymon-system/megaphone>

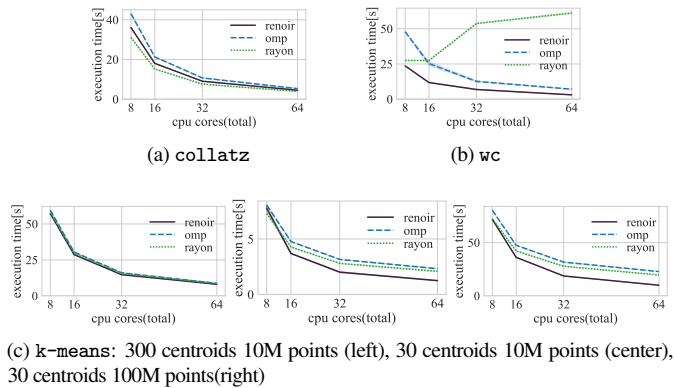

Figure 9: Scalability on a single host.

is about 900ms. We considered an evaluation interval of 100ms as in Query Q2, which leads to a throughput that is comparable to that of Renoir.

In query Q5 (Fig. 8c), the latency is dominated by the presence of windows. The average latency is below 3s for Renoir and over 12.5s for Timely. Also, the latency is more stable in Renoir, with a standard deviation of 1.1s compared to 14.3s of Timely.

### 5.5. Scalability on a single host

Renoir is designed to enable large-scale data analysis on a cluster of machines. However, it can also be used as an efficient library for parallel computations within a single process. This section focuses on this capability and compares the performance of Renoir with alternative state-of-the-art solutions for parallel processing: OMP and Rayon. With OMP, developers annotate blocks of C/C++ code that can be executed in parallel, the compiler then generates the parallel implementation using a fork-join model of execution. With Rayon, developers use an iterator-like api that is translated to a set of tasks executed by a fixed size thread pool. All three systems are configured to use a level of parallelism equal to the number of processors available.

For the experiments presented in this section, we use c6a EC2 instances, which offer 3rd generation AMD EPYC processors. For each experiment, we use a single instance and we configure the systems under test for optimal exploitation of the compute resources available. We start from a c6a.2xlarge instance (8 CPUs, 16GB RAM) and run the experiments scaling up to a c6a.16xlarge instance (64 CPUs, 128GB RAM).

We use the collatz, wc and k-means benchmarks to cover different scenarios. collatz is an iterative algorithm that process numbers in parallel. It does not require synchronization across numbers, but presents highly heterogeneous execution times for different numbers. wc includes data transformations (to split lines into words) and an associative aggregation (to count the number of occurrences). k-means is an iterative algorithm that requires synchronization at each iteration.

Fig. 9a shows the performance we measure for collatz. The execution time is comparable for all the systems under test: Rayon is about 30% faster than OMP and about 15% faster than Renoir, and the relative gap remains almost constant when changing the number of cores. Due to the unbalanced nature of the task, these

differences may be attributed at least in part to different partitioning strategies: static in Renoir and dynamic in OMP and Rayon.

Fig. 9b shows the performance we measure for wc. Renoir shows consistently better performance than OMP. With this workload, Rayon exhibits a strange behavior, with execution time increasing when using more cores. This kind of problem when using many threads has been documented and may be caused by the scheduler<sup>11</sup>.

Fig. 9c shows the performance we measure for k-means. When considering 300 centroids (Fig. 9c, left), all systems under test show nearly identical performance and scalability. When considering 30 centroids and 10M points (Fig. 9c, center) both Rayon and Renoir show better performance than OMP. Renoir also scales better, and becomes almost twice as fast as Rayon with 64 cores. The same pattern emerges when increasing the number of points to 100M (Fig. 9c, right): the execution times increase, but the relative performance between the systems remains similar. The performance advantage may be explained by the native support for iterations and partitioning: while OMP and Rayon need to join to the main thread after each iteration, Renoir keeps the points partitioned, processes partitions independently from each other, and only synchronizes the tasks to collect the new centroids.

### 5.6. Discussion

We evaluated Renoir with very heterogeneous workloads, ranging from batch to streaming and even parallel computations, including iterative, graph processing and machine learning algorithms. We compared it with state-of-the-art solutions in each field.

First of all, our analysis reveals the benefits of the programming interface of Renoir. Indeed, writing programs with Renoir (and Flink, which adopts a similar programming abstraction) was considerably simple than using MPI or Timely. Frequently, the added complexity may also become detrimental for performance: despite experimenting alternative solutions, in several benchmarks MPI shows higher execution times than Renoir. Writing efficient MPI solutions requires significant effort in designing parts of the code that are outside the scope of the task at hand, such as communication and buffering, and most solutions may be sub-optimal with respect to what Renoir achieves automatically with efficient default strategies. Moreover, when we found possible optimizations in MPI, we could frequently replicate them in Renoir. While Timely also offers a high-level programming interface, it is more complex than the one in Renoir. Even when starting from implementations provided by Timely developers, it was difficult for us to ensure that the final algorithm was equivalent to that of the other platforms: for instance, in pagerank, we could not modify the provided implementation to use floating point numbers as rank; similarly, in nexmark, the results were highly dependent on the strategies used to define timestamps. In terms of absolute performance and scalability, Renoir was always comparable or faster than alternative solutions in all the scenarios we tested, showing that it is suitable for a wide range of problems and diverse hardware configurations.

In summary, our evaluation shows that Renoir provides a good balance between ease of use and performance, allowing to

<sup>11</sup><https://github.com/rayon-rs/rayon/issues/795#issuecomment-1155652842>



easily develop code that solves the problem at hand in a way that outperforms more complex solutions, developed with lower-level programming primitives.

## 6. Related Work

Our work focuses on programming models and platforms for parallel, distributed data processing. In this context we can demark four main categories of related systems.

**General purpose dataflow platforms.** The dataflow model we consider in this paper has attracted increasing attention over the last several years, and most mainstream data processing platforms rely on this model [32, 33, 4, 34, 17]. The Flink system we use for our evaluation is a mature commercial product, representative of these platforms, and often cited for its good level of performance [26]. Dataflow platforms provide general API that work well with structured and unstructured data, but they have large margins of improvements in terms of performance, as shown in our evaluation.

**Specialized libraries for dataflow platforms.** To simplify the implementation of complex algorithms, some platforms also offer higher-level libraries for specific domains. Prominent examples are the libraries to process structured data [9], which convert declarative queries from SQL-like languages to dataflow programs, often providing unified abstractions for batch and stream processing of structured data [35, 36]. The conversion enables automated query optimizations, which are common in database systems. Other examples of libraries range from machine learning [37] to graph processing [10], to pattern recognition in streams of events [38]. As all these libraries generate programs that are executed on an existing dataflow engine, their performance is limited by that of the underlying platform. This kind of abstractions could also be implemented on top of Renoir. Given the performance advantages we demonstrated, we believe Renoir has the potential to bring significant improvements in domains like structured data or graph data processing. We are currently developing a library for machine learning on top of Renoir. Preliminary experiments show promising results, in line with those measured for the k-means machine learning algorithm we analyzed in Section 5.

**Specialized engines.** To overcome the performance limitations of the previously cited systems, an alternative is to build an optimized engine using a compiled language and expose a domain-specific high-level API. Some systems choose a structured query language [39, 40, 41], others define operations on dataframes [42]. Previous works also showed promising results using a single multi-core machine [43, 44]. By restricting to a specific domain, this kind of systems trades expressiveness in favor of performance: high-level abstractions are translated to calls to a set of prepared, optimized components that often outperform current general purpose dataflow systems. Renoir chooses a more general approach, allowing user defined functions that can work effectively in multiple domains and with both structured and unstructured data.

**Single machine dataflow platforms.** Some systems optimize the use of resources on a single machine. For instance, StreamBox and BriskStream target multi-core machines [45, 46], while SABER considers heterogeneous hardware platforms consisting of multi-core CPUs and GPUs, which are increasingly available in modern

heterogeneous servers [47]. By building on a compiled language, Renoir simplifies the access to hardware resources with respect to JVM-based systems. In fact, we already experimented with OpenCL-based implementations of operators that exploit GPUs, and we plan to further explore this line of research in future work.

**Extensions to the dataflow programming model.** Fernandez et al. [48] introduce an imperative programming model with explicit mutable state and annotations for data partitioning and replication. TSpool [49] extends the dataflow abstraction with additional features and guarantees, such as transactional semantics. These efforts are orthogonal to our work, which mostly targets efficient system design and implementation, rather than investigating new models. Naiad [27] and its timely dataflow model enrich dataflow computations with explicit timestamps that enable implementing efficient coordination mechanisms. We compared Renoir with the Rust implementation of the timely dataflow model in Section 5. Finally, modern data processing systems provide fault-tolerance mechanisms to recover from software and hardware failures. In Renoir we are implementing fault-tolerance mechanisms building on consolidated approaches such as asynchronous snapshots [50], which bring negligible runtime overhead. However, as fault-tolerance is still in an experimental state in Renoir, we disabled it in all the systems used in our evaluation (see Section 5) for a fair comparison.

## 7. Conclusions

This paper introduced Renoir, a novel data processing framework written in Rust. Renoir provides all core features of state-of-the-art data processing platforms – unified batch and stream processing, iterative computations, windowing, time-based data analytics – within the same, high-level processing model. At the same time, its design and implementation choices – compiled language, efficient memory and communication management, task allocation that maximizes the use of processing resources – yields up to more than an order of magnitude improvements in throughput with respect to existing data processing systems, rivaling and even outperforming custom MPI solutions in some workloads.

Our research shows that the advantages of a high-level programming model are not restricted to the simplicity in defining data analysis tasks. If the model is supported by an efficient execution platform, it can unlock performance improvement that are hard to achieve with custom, manual optimizations.

Moving from this observation, we plan to further contribute to the research on data processing platforms focusing both on enriching the programming model, for instance to support domain-specific operators, and on improving the capabilities of the processing engines, such as supporting hardware accelerators and dynamic scaling.

## References

- [1] A. Margara, G. Cugola, N. Felicioni, S. Cilloni, A model and survey of distributed data-intensive systems, *ACM Comput. Surv.* 56 (1) (2023).
- [2] M. Zaharia, R. S. Xin, P. Wendell, T. Das, M. Armbrust, A. Dave, X. Meng, J. Rosen, S. Venkataraman, M. J. Franklin, A. Ghodsi, J. Gonzalez, S. Shenker, I. Stoica, Apache spark: A unified engine for big data processing, *Communications of the ACM* 59 (11) (2016) 56–65.

- [3] M. Zaharia, T. Das, H. Li, T. Hunter, S. Shenker, I. Stoica, Discretized streams: Fault-tolerant streaming computation at scale, in: *Symposium on Operating Systems Principles, SOSP '13*, ACM, 2013, pp. 423–438.
- [4] T. Akidau, R. Bradshaw, C. Chambers, S. Chernyak, R. J. Fernández-Moctezuma, R. Lax, S. McVeety, D. Mills, F. Perry, E. Schmidt, S. Whittle, The dataflow model: A practical approach to balancing correctness, latency, and cost in massive-scale, unbounded, out-of-order data processing, *Proceedings of VLDB Endow.* 8 (12) (2015) 1792–1803.
- [5] P. Carbone, A. Katsifodimos, S. Ewen, V. Markl, S. Haridi, K. Tzoumas, Apache flink™: Stream and batch processing in a single engine, *IEEE Data Engineering Bulletin* 38 (4) (2015) 28–38.
- [6] J. Dean, S. Ghemawat, Mapreduce: Simplified data processing on large clusters, *Communications of the ACM* 51 (1) (2008) 107–113.
- [7] A. Abouzeid, K. Bajda-Pawlikowski, D. Abadi, A. Silberschatz, A. Rasin, Hadoopdb: An architectural hybrid of mapreduce and dbms technologies for analytical workloads, *Proceedings of VLDB Endow.* 2 (1) (2009) 922–933.
- [8] J. Camacho-Rodríguez, A. Chauhan, A. Gates, E. Koifman, O. O'Malley, V. Garg, Z. Haindrich, S. Shelukhin, P. Jayachandran, S. Seth, D. Jaiswal, S. Bouguerra, N. Bangarwa, S. Hariappan, A. Agarwal, J. Dere, D. Dai, T. Nair, N. Dembla, G. Vijayaraghavan, G. Hagleitner, Apache hive: From mapreduce to enterprise-grade big data warehousing, in: *International Conf. on Management of Data, SIGMOD '19*, ACM, 2019, p. 1773–1786.
- [9] M. Armbrust, R. S. Xin, C. Lian, Y. Huai, D. Liu, J. K. Bradley, X. Meng, T. Kaftan, M. J. Franklin, A. Ghodsi, M. Zaharia, Spark sql: Relational data processing in spark, in: *International Conf. on Management of Data, SIGMOD '15*, ACM, 2015, p. 1383–1394.
- [10] J. E. Gonzalez, R. S. Xin, A. Dave, D. Crankshaw, M. J. Franklin, I. Stoica, Graphx: Graph processing in a distributed dataflow framework, in: *USENIX Symposium on Operating Systems Design and Implementation, SOSP '14*, USENIX Association, 2014, pp. 599–613.
- [11] J. L. Reyes-Ortiz, L. Oneto, D. Anguita, Big data analytics in the cloud: Spark on hadoop vs mpi/openmp on beowulf, *Procedia Computer Science* 53 (2015) 121–130, *iNNS Conf. on Big Data*.
- [12] P. González, X. C. Pardo, D. R. Penas, D. Teijeiro, J. R. Banga, R. Doallo, Using the cloud for parameter estimation problems: Comparing spark vs mpi with a case-study, in: *International Symposium on Cluster, Cloud and Grid Computing, CCGrid '17*, IEEE Press, 2017, pp. 797–806.
- [13] S. Zeuch, B. D. Monte, J. Karimov, C. Lutz, M. Renz, J. Traub, S. Breß, T. Rabl, V. Markl, Analyzing efficient stream processing on modern hardware, *VLDB Endowment* 12 (5) (2019) 516–530.
- [14] S. Klabnik, C. Nichols, *The rust programming language* (2018).
- [15] L. De Martini, A. Margara, G. Cugola, Analysis of market data with noir: Debs grand challenge, in: *International Conf. on Distributed and Event-Based Systems, DEBS '22*, ACM, 2022, p. 139–144.
- [16] Timely dataflow, <https://github.com/TimelyDataflow/timely-dataflow>.
- [17] M. Rocklin, Dask: Parallel Computation with Blocked algorithms and Task Scheduling, Austin, Texas, 2015, pp. 126–132.
- [18] T. White, *Hadoop: The Definitive Guide*, Yahoo! Press, 2010.
- [19] A. Turon, Abstraction without overhead: traits in rust, <https://blog.rust-lang.org/2015/05/11/traits.html> (2015).
- [20] A. Turon, Fearless concurrency with rust, <https://blog.rust-lang.org/2015/04/10/Fearless-Concurrency.html> (2015).
- [21] Serde framework, <https://serde.rs>.
- [22] A. Arasu, S. Babu, J. Widom, The cql continuous query language: Semantic foundations and query execution, *The VLDB Journal* 15 (2) (2006) 121–142.
- [23] I. Botan, R. Derakhshan, N. Dindar, L. Haas, R. J. Miller, N. Tatbul, Secret: A model for analysis of the execution semantics of stream processing systems, *VLDB Endowment* 3 (1–2) (2010) 232–243.
- [24] W. Gropp, R. Thakur, E. Lusk, *Using MPI-2: Advanced Features of the Message Passing Interface*, 2nd Edition, MIT Press, 1999.
- [25] Bincode crate, <https://docs.rs/bincode/>.
- [26] O.-C. Marcu, A. Costan, G. Antoniu, M. S. Perez-Hernandez, Spark vs flink: Understanding performance in big data analytics frameworks, in: *International Conf. on Cluster Computing, CLUSTER '16*, IEEE, 2016, pp. 433–442.
- [27] D. G. Murray, F. McSherry, R. Isaacs, M. Isard, P. Barham, M. Abadi, Naiad: A timely dataflow system, in: *Symposium on Operating Systems Principles, SOSP '13*, ACM, 2013, p. 439–455.
- [28] D. G. Murray, F. McSherry, M. Isard, R. Isaacs, P. Barham, M. Abadi, Incremental, iterative data processing with timely dataflow, *Commun. ACM* 59 (10) (2016) 75–83.
- [29] Project gutenber, <https://www.gutenberg.org>.
- [30] Nyc open data – motor vehicle collisions dataset, <https://data.cityofnewyork.us/Public-Safety/Motor-Vehicle-Collisions-Crashes/h9gi-nx95>.
- [31] P. Tucker, K. Tuftte, V. Papadimos, D. Maier, Nexmark – a benchmark for queries over data streams, Tech. rep. (2008).
- [32] T. Akidau, A. Balikov, K. Bekiroğlu, S. Chernyak, J. Haberman, R. Lax, S. McVeety, D. Mills, P. Nordstrom, S. Whittle, Millwheel: Fault-tolerant stream processing at internet scale, *Proc. VLDB Endow.* 6 (11) (2013) 1033–1044.
- [33] A. Toshniwal, S. Taneja, A. Shukla, K. Ramasamy, J. M. Patel, S. Kulkarni, J. Jackson, K. Gade, M. Fu, J. Donham, N. Bhagat, S. Mittal, D. Ryaboy, Storm@twitter, in: *International Conf. on Management of Data, SIGMOD '14*, ACM, 2014, pp. 147–156.
- [34] S. Kulkarni, N. Bhagat, M. Fu, V. Kedigehalli, C. Kellogg, S. Mittal, J. M. Patel, K. Ramasamy, S. Taneja, Twitter heron: Stream processing at scale, in: *International Conf. on Management of Data, SIGMOD '15*, ACM, 2015, p. 239–250.
- [35] M. J. Sax, G. Wang, M. Weidlich, J.-C. Freytag, Streams and tables: Two sides of the same coin, in: *International Workshop on Real-Time Business Intelligence and Analytics, BIRTE '18*, ACM, 2018.
- [36] E. Begoli, T. Akidau, F. Hueske, J. Hyde, K. Knight, K. Knowles, One sql to rule them all - an efficient and syntactically idiomatic approach to management of streams and tables, in: *International Conf. on Management of Data, SIGMOD '19*, ACM, 2019, p. 1757–1772.
- [37] X. Meng, J. Bradley, B. Yavuz, E. Sparks, S. Venkataraman, D. Liu, J. Freeman, D. Tsai, M. Amde, S. Owen, D. Xin, R. Xin, M. J. Franklin, R. Zadeh, M. Zaharia, A. Talwalkar, Milib: Machine learning in apache spark, *Journal of Machine Learning Research* 17 (1) (2016) 1235–1241.
- [38] N. Giatrikos, E. Alevizos, A. Artikis, A. Deligiannakis, M. Garofalakis, Complex event recognition in the big data era: a survey, *The VLDB Journal* 29 (1) (2020) 313–352.
- [39] B. Dageville, T. Cruanes, M. Zukowski, V. Antonov, A. Avanes, J. Bock, J. Claybaugh, D. Engovatov, M. Hentschel, J. Huang, A. W. Lee, A. Motivala, A. Q. Munir, S. Pelley, P. Povinec, G. Rahn, S. Triantafyllis, P. Unterbrunner, The Snowflake Elastic Data Warehouse, in: *International Conf. on Management of Data, SIGMOD '16*, ACM, San Francisco California USA, 2016, pp. 215–226.
- [40] GitHub - rlink-rs/rlink-rs: High-performance Stream Processing Framework. An alternative to Apache Flink., <https://github.com/rlink-rs/rlink-rs>.
- [41] SurrealDB/The ultimate serverless cloud database, <https://surrealdb.com/>.
- [42] D. Petersohn, S. Macke, D. Xin, W. Ma, D. Lee, X. Mo, J. E. Gonzalez, J. M. Hellerstein, A. D. Joseph, A. Parameswaran, Towards Scalable Dataframe Systems, <http://arxiv.org/abs/2001.00888> (2020).
- [43] Polars, <https://www.pola.rs/>.
- [44] M. Raasveldt, H. Mühleisen, DuckDB: an Embeddable Analytical Database, in: *International Conf. on Management of Data, SIGMOD '19*, ACM, Amsterdam Netherlands, 2019, pp. 1981–1984.
- [45] H. Miao, H. Park, M. Jeon, G. Pekhimenko, K. S. McKinley, F. X. Lin, Streambox: Modern stream processing on a multicore machine, in: *USENIX Annual Technical Conf., USENIX ATC '17*, USENIX Association, 2017, p. 617–629.
- [46] S. Zhang, J. He, A. C. Zhou, B. He, BriskStream: Scaling Data Stream Processing on Shared-Memory Multicore Architectures, in: *International Conf. on Management of Data, SIGMOD '19*, ACM, Amsterdam Netherlands, 2019, pp. 705–722.
- [47] A. Kolioussis, M. Weidlich, R. Castro Fernandez, A. L. Wolf, P. Costa, P. Pietzuch, Saber: Window-based hybrid stream processing for heterogeneous architectures, in: *International Conf. on Management of Data, SIGMOD '16*, ACM, 2016, p. 555–569.
- [48] R. C. Fernandez, M. Migliavacca, E. Kalyvianaki, P. Pietzuch, Making state explicit for imperative big data processing, in: *USENIX Annual Technical Conf., ATC '14*, USENIX Association, 2014, p. 49–60.
- [49] L. Affetti, A. Margara, G. Cugola, Tspoon: Transactions on a stream processor, *Journal of Parallel and Distributed Computing* 140 (2020) 65–79.
- [50] P. Carbone, G. Fóra, S. Ewen, S. Haridi, K. Tzoumas, Lightweight asynchronous snapshots for distributed dataflows, *CoRR abs/1506.08603* (2015).