

# DECOMPOSITION OF THE LONGEST ELEMENT OF THE WEYL GROUP USING FACTORS CORRESPONDING TO THE HIGHEST ROOTS

RAFAEL STEKOLSHCHIK

ABSTRACT. Let  $\Phi$  be a root system of a finite Weyl group  $W$  with simple roots  $\Delta$  and corresponding simple reflections  $S$ . For  $J \subseteq S$ , denote by  $W_J$  the standard parabolic subgroup of  $W$  generated by  $J$ , and by  $\Delta_J \subseteq \Delta$  the subset corresponding to  $J$ . We show that the longest element of  $W$  is decomposed into a product of several ( $\leq |\Delta|$ ) reflections corresponding to mutually orthogonal roots, each of which is either the highest root of some subset  $\Delta_J \subseteq \Delta$  or is a simple root. For each type of the root system, the factors of the specified decomposition are listed. The relationship between the longest elements of different types is found out. The uniqueness of the considered decomposition is shown. It turns out that subsets of highest roots, which give the decomposition of longest elements in the Weyl group, coincide with the cascade of orthogonal roots constructed by B.Kostant and A.Joseph for calculations in the universal enveloping algebra.

## 1. Introduction

1.1. **The longest element.** Let  $\Phi$  be a root system of a finite Weyl group  $W$  with simple roots  $\Delta = \{\alpha_1, \dots, \alpha_n\}$  and the corresponding simple reflections  $S = \{s_{\alpha_1}, \dots, s_{\alpha_n}\}$ ,  $\Phi^+$  be the subset of positive roots in  $\Phi$ .

For  $w \in W$ , define  $l(w)$  (resp.,  $l_a(w)$ ) to be the minimal number of factors occurring amongst all expressions of  $w$  as a product of simple reflections  $S$  (resp., reflections). The function  $l$  (resp.,  $l_a$ ) is called the standard (resp., absolute) length function of  $(W, S)$ . An expression  $w = s_1 \dots s_n$  with  $s_i \in S$  and  $n = l(w)$  is called a *reduced expression* for  $w$ .

There exists an element  $w_0 \in W$  sending the subset of positive roots  $\Phi^+$  to the subset of negative roots  $\Phi^-$ . Such an element  $w_0$  is unique in  $W$ . The length  $l(w_0)$  coincides with the number of roots in  $\Phi^+$ . No other element of  $W$  has such a large length as  $w_0$ . So, the element  $w_0$  is said to be the *longest element*. The element  $w_0$  transforms the fundamental chamber  $C$  to the chamber  $-C$ ,  $w_0$  is involution and

$$l(w_0 w) = l(w_0) - l(w) \text{ for all } w \in W.$$

The element  $w_0$  is the unique element  $w \in W$  satisfying the condition

$$l(ws_\alpha) < l(w) \text{ for all } \alpha \in \Delta.$$

The longest element  $w$  is  $-1$  except for the following 3 cases<sup>1</sup>:

- (1)  $A_n$ ,  $n \geq 2$ ,  $w_0 = -\varepsilon$ , where  $\varepsilon(\alpha_i) = \alpha_{n-i+1}$ ,
- (2)  $D_n$ ,  $n$  is odd,  $w_0 = -\varepsilon$ , where  $\varepsilon(\alpha_{n-1}) = \alpha_n$ ,  $\varepsilon(\alpha_{n-1}) = \alpha_n$ ,  
 $\varepsilon(\alpha_i) = \alpha_i$  for other  $\alpha_i$ .
- (3)  $E_6$ ,  $w_0 = -\varepsilon$ , where  $\varepsilon(\alpha_1) = \alpha_6$ ,  $\varepsilon(\alpha_6) = \alpha_1$ ,  
 $\varepsilon(\alpha_3) = \alpha_5$ ,  $\varepsilon(\alpha_5) = \alpha_3$ ,  $\varepsilon(\alpha_2) = \alpha_2$ ,  $\varepsilon(\alpha_4) = \alpha_4$ ,

see [4, Ch.VI,§1, $n^\circ 6$ ,Cor.6], [4, Plates I-X], [9, §1.8], [2, §2.3].

## 1.2. The main results.

1.2.1. *Decomposition of the longest element.* For any  $J \subseteq S$ , denote by  $W_J$  the subgroup of  $W$  generated by  $J$ , and by  $\Delta_J \subseteq \Delta$  the subset corresponding to  $J$ . The subgroups of the form  $W_J$  are referred as *standard parabolic subgroups*.

**Theorem 1.1.** *The longest element  $w_0 \in W$  is decomposed into a product of several ( $\leq n$ ) reflections corresponding to mutually orthogonal roots, each of which is either the highest root of some subset  $\Delta_J \subseteq S$  or is a simple root, see Tables 1.1 and 1.2.*

*Proof.* The theorem is proved by a case-by-case analysis: see Propositions 3.3 ( $A_n$ ), 4.3 ( $B_n$ ), 5.1 ( $C_n$ ), 6.2 ( $D_n$ ), 7.1 ( $E_6$ ), 8.3 ( $E_7$ ), 9.2 ( $E_8$ ), 10.1 ( $F_4$ ), 11.2 ( $G_2$ ).  $\square$

1.2.2. *Relationship between the longest elements.* Let  $W$  be a finite Weyl group and  $\Phi$  be the corresponding root system, in this case we will write  $W = W(\Phi)$ . Denote by  $w_0(W)$  the longest element in  $W$ . We also use the notation  $w_0(\Phi)$  instead of  $w_0(W)$ .

**Theorem 1.2.** *For any root system  $\Phi$  with the Weyl group  $W = W(\Phi)$ , there exists a root subsystem  $\Phi' \subset \Phi$  with the standard parabolic subgroup  $W' = W(\Phi')$  in  $W$ , such that the longest elements  $w_0(\Phi)$  and  $w_0(\Phi')$  are related as follows:*

$$\begin{aligned}
 w_0(A_n) &= w_0(A_{n-2})s_{\alpha_{max}} && \text{for } n \geq 3, \\
 w_0(B_n) &= w_0(B_{n-2})s_{\alpha_{max}}s_{\alpha_1} && \text{for } n \geq 4, \\
 w_0(C_n) &= w_0(C_{n-1})s_{\alpha_{max}} && \text{for } n \geq 3, \\
 w_0(D_n) &= w_0(D_{n-2})s_{\alpha_{max}}s_{\alpha_1} && \text{for } n \geq 6, \\
 w_0(E_6) &= w_0(A_5)s_{\alpha_{max}}, \\
 w_0(E_7) &= w_0(D_6)s_{\alpha_{max}}, \\
 w_0(E_8) &= w_0(E_7)s_{\alpha_{max}}, \\
 w_0(F_4) &= w_0(C_3)s_{\alpha_{max}}.
 \end{aligned} \tag{1.1}$$

In eq. (1.1), the reflection  $s_{\alpha_{max}}$  corresponds to the highest root  $\alpha_{max}$  in the root system  $\Phi$ .

*Proof.* Let us consider, for example, the case  $W = W(F_4)$ ,  $W' = W(C_3)$ . By Proposition 10.1

$$w_0(F_4) = s_{\alpha_2}s_{\alpha_2+2\alpha_3}s_{\alpha_2+2\alpha_3+2\alpha_4}s_{\alpha_{max}}.$$

<sup>1</sup>In all these cases  $\varepsilon$  is the involutive automorphism of the corresponding Dynkin diagram. For the numbering of vertices, see Fig. 5.

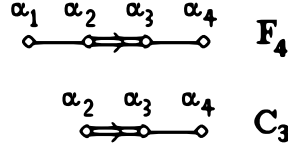

FIGURE 1. Numbering of  $C_3$  vertices which is different from Bourbaki's numbering

The roots  $\alpha_2 + 2\alpha_3$  and  $\alpha_2 + 2\alpha_3 + 2\alpha_4$  are the highest roots for the root systems  $C_2$  and  $C_3$ , see Fig. 1. Denote them as follows:

$$\alpha_{max}^{c_2} := \alpha_2 + 2\alpha_3, \quad \alpha_{max}^{c_3} := \alpha_2 + 2\alpha_3 + 2\alpha_4,$$

although they differ from definitions of  $\alpha_{max}^{c_2}$  and  $\alpha_{max}^{c_3}$  for case  $C_3$  in Table 1.1. So,

$$w_0(F_4) = s_{\alpha_2} s_{\alpha_{max}^{c_2}} s_{\alpha_{max}^{c_3}} s_{\alpha_{max}} = w_0(C_3) s_{\alpha_{max}}.$$

Such a difference in definitions of the highest roots also takes place in other cases, see Remark 1.7. The definition of the highest roots of root subsystems depends on the root system in which this root is considered.

Other cases in eq. (1.1) are treated in a similar way.  $\square$

### 1.2.3. Uniqueness of decomposition.

**Definition 1.3.** Let  $T = \{\tau_1, \tau_2, \dots, \tau_m\}$  be the subset of distinct roots in  $\Phi$ . This set is said to be *max-orthogonal* if

- (a) the roots of  $T$  are *mutually orthogonal*,
- (b) all non-simple roots in  $T$  form a *linearly ordered subset* in  $\Phi$ .
- (c) each non-simple root  $\tau_i$  is the *highest root* in some root subsystem  $J \subset \Phi$  corresponding to a standard parabolic subgroup  $W_J \subset W$ .  
The root  $\tau_1$  is the highest root in  $\Phi$ , i.e.,  $\tau_1 = s_{\alpha_{max}}$ .

Note that each root subset used in decompositions of Theorem 1.1 is max-orthogonal.

**Theorem 1.4.** For any longest element  $w_0$ , there exists a unique max-orthogonal subset  $\{\tau_1, \tau_2, \dots, \tau_m\}$ , where  $m \leq n$ , such that

$$w_0 = \prod_{i=1}^m s_{\tau_i}. \quad (1.2)$$

**Definition 1.5.** The decomposition (1.2) corresponding to some max-orthogonal subset  $\{\tau_1, \tau_2, \dots, \tau_m\}$  is said to be the *max-orthogonal decomposition*.

We will construct the max-orthogonal decomposition for each type of root systems, see Tables 1.1 and Table 1.2.

*Proof of Theorem 1.4.* In eq. (1.1), for each relation, there exists a factor that connects two different longest elements. We refer to this factor as the *linking factor*. Denote it by  $\mathcal{L}$ . There are two cases for the linking factor  $\mathcal{L}$ :

- (a)  $\mathcal{L} = s_{\alpha_{max}}$ , this holds for  $A_n, C_n, E_n$  and  $F_4$ ,
- (b)  $\mathcal{L} = s_{\alpha_{max}} s_{\alpha_1}$ , this holds for  $B_n$  and  $D_n$ .

The uniqueness of the max-orthogonal decomposition (1.2) will be proved by induction on the length of the longest element.

(a) Let  $w_0(\Phi) = w_0(\Phi')s_{\alpha_{max}}$ . By definition of the max-orthogonal decomposition, the decomposition (1.2) of  $w_0(\Phi)$  contains the factor  $s_{\alpha_{max}}$ . By induction hypothesis  $w_0(\Phi')$  has an unique max-orthogonal decomposition. Then, the max-orthogonal decomposition of  $w_0(\Phi)$  is unique.

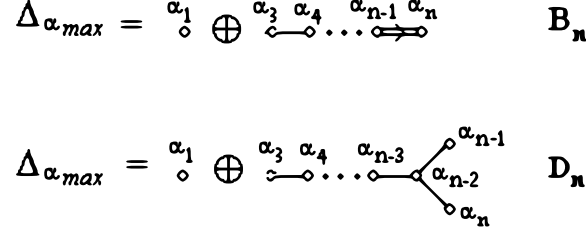

FIGURE 2. Subsets  $\Delta_{\alpha_{max}}$  for  $B_n$  and  $D_n$

(b) Let  $w_0(\Phi) = w_0(\Phi')s_{\alpha_{max}}s_{\alpha_1}$ . In the root systems  $B_n$  and  $D_n$ , the only simple root non-orthogonal to the highest root  $\alpha_{max}$  is  $\alpha_2$ . Consider the root subset  $\Delta_{\alpha_{max}}$  consisting of roots orthogonal to  $\alpha_{max}$ . The subset  $\Delta_{\alpha_{max}}$  consists of two mutually orthogonal subsets:  $\{\alpha_1\}$  and  $V(\alpha_3, \dots, \alpha_n)$ , the subset of roots spanned by the roots  $\{\alpha_3, \dots, \alpha_n\}$ :

$$\Delta_{\alpha_{max}} = \{\alpha_i \in \Phi \mid (\alpha_i, \alpha_{max}) = 0\} = \{\alpha_1\} \oplus V(\alpha_3, \dots, \alpha_n), \quad (1.3)$$

see Fig. 2. Since  $s_{\alpha_1}$  is the factor in the max-orthogonal decomposition of  $w_0(\Phi)$  given by (1.1) and  $\alpha_1$  is disconnected from  $V(\alpha_3, \dots, \alpha_n)$ , then  $s_{\alpha_1}$  is the factor in any other max-orthogonal decomposition of  $w_0(\Phi)$ . Thus, any max-orthogonal decomposition of  $w_0(\Phi)$  contains  $s_{\alpha_{max}}s_{\alpha_1}$ . Further, we apply induction as in case (a).  $\square$

The proof of uniqueness in Theorem 1.4 echoes with the cascade of orthogonal roots constructed by B.Kostant and A.Joseph. It turns out that subsets of highest roots in the max-orthogonal decomposition coincide with the cascade of orthogonal roots constructed by B.Kostant and A.Joseph for calculations in the universal enveloping algebra, see §1.4.

**Remark 1.6** (notations). (i) We follow Bourbaki's numbering for simple roots in Dynkin diagrams. see Fig. 5.

(ii) Table 1.1 contains definitions of highest roots  $\alpha_{max}^{xi}$  ( $= \alpha_{max}^{x,i}$ ), where  $x$  is one of the indices  $a, b, c, d, e, f, g$ , and  $i$  is the number of vertices in the corresponding Dynkin diagram.

(iii) In Tables A.3 and A.4, for each root system  $\Phi$ , we list the highest roots of the root subsystems used in Table 1.1.

(iv) The reflection corresponding to  $\alpha_{max}$  is denoted by  $s_{\alpha_{max}}$ .

(v) Sometimes we prefer to use the notation  $s_i$  instead of  $s_{\alpha_i}$ , which is the same.

**Remark 1.7** (summands in  $\alpha_{max}^{xi}$ ). The indices of simple roots that appears as summands in  $\alpha_{max}^{a5}$  for the case  $E_6$  are different from the indices contained in  $\alpha_{max}^{a5}$  for the case  $A_n$ , see Fig. 3.



FIGURE 3. Root systems  $A_5 \subset A_7$  and  $A_5 \subset E_6$ .

The indices of simple roots that appears as summands in  $\alpha_{max}^{d4}$  (resp.  $\alpha_{max}^{d6}$ ) for the case  $E_7$  are different from the indices contained in  $\alpha_{max}^{d4}$  (resp.  $\alpha_{max}^{d6}$ ) for the case  $D_n$ , see Fig. 3.

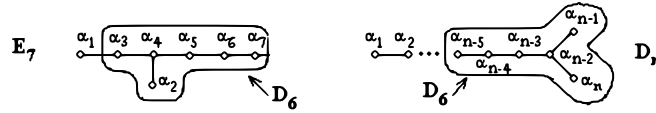

FIGURE 4. Root systems  $D_6 \subset E_7$  and  $D_6 \subset D_n$ .

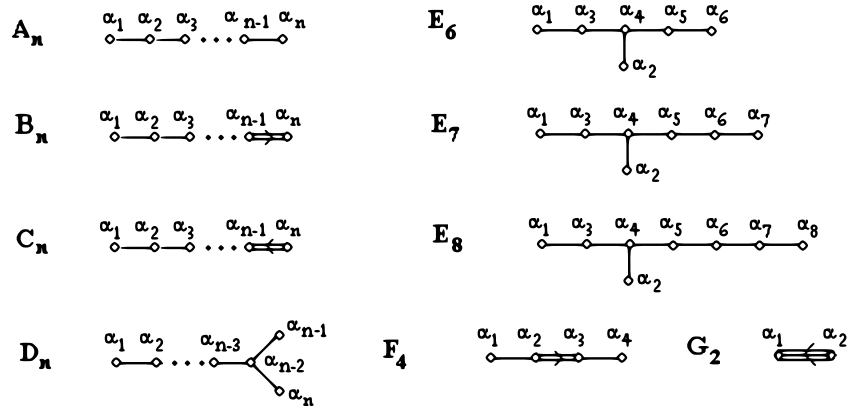

FIGURE 5. Bourbaki's numbering of simple roots, [4]

**1.3. Acknowledgments.** I thank Valdemar Tsanov for pointing out on papers [8], [14], as well as the connection between *max-orthogonal subsets* from Theorem 1.4 and *Kostant's cascade* construction, see §1.4.

Weyl group	Longest element $w_0$	$l(w_0)$
$W(A_n)$	$\prod_{i=1}^k s_{\alpha_{max}^{a,2i}}, \text{ where } \alpha_{max}^{a,2i} := \sum_{j=k-i+1}^{k+i} \alpha_j, \quad n = 2k.$ $s_{\alpha_{k+1}} \prod_{i=1}^k s_{\alpha_{max}^{a,2i+1}}, \text{ where } \alpha_{max}^{a,2i+1} := \sum_{j=k-i+1}^{k+i+1} \alpha_j, \quad n = 2k + 1,$	$\frac{n(n+1)}{2}$
$W(B_n)$	$\prod_{\substack{i=1 \\ i\text{-odd}}}^{n-1} (s_{\alpha_i} s_{\alpha_{max}^{b,n-i+1}}) \quad \text{for } n = 2k,$ $s_{\alpha_n} \prod_{\substack{i=1 \\ i\text{-odd}}}^{n-2} (s_{\alpha_i} s_{\alpha_{max}^{b,n-i+1}}) \quad \text{for } n = 2k + 1,$ $\text{where } \alpha_{max}^{bi} := \alpha_{n-i+1} + 2 \sum_{j=n-i+2}^n \alpha_j.$	$n^2$
$W(C_n)$	$s_{\alpha_n} \prod_{i=1}^{n-1} s_{\alpha_{max}^{c,n-i+1}}, \text{ where } \alpha_{max}^{c,n-i+1} := \alpha_n + 2 \sum_{j=i}^{n-1} \alpha_j.$	$n^2$
$W(D_n)$	$s_{\alpha_n} s_{\alpha_{n-1}} \prod_{\substack{i=1 \\ i\text{-odd}}}^{n-3} (s_{\alpha_i} s_{\alpha_{max}^{d,n-i+1}}) \quad \text{for } n = 2k,$ $\prod_{\substack{i=1 \\ i\text{-odd}}}^{n-2} (s_{\alpha_i} s_{\alpha_{max}^{d,n-i+1}}) \quad \text{for } n = 2k + 1,$ $\text{where } \alpha_{max}^{di} := \alpha_{n-i+1} + 2 \sum_{j=n-i+2}^{n-2} \alpha_j + \alpha_{n-1} + \alpha_n \text{ for } i \geq 4,$ $\alpha_{max}^{d3} := \alpha_{max}^{a3} := \alpha_{n-2} + \alpha_{n-1} + \alpha_n.$	$n(n-1)$
$W(E_6)$	$s_{\alpha_4} s_{\alpha_{max}^{a3}} s_{\alpha_{max}^{a5}} s_{\alpha_{max}}, \text{ where}$ $\alpha_{max}^{a3} := \alpha_3 + \alpha_4 + \alpha_5, \quad \alpha_{max}^{a5} := \alpha_1 + \alpha_3 + \alpha_4 + \alpha_5 + \alpha_6,$ $\alpha_{max} = \alpha_1 + 2\alpha_2 + 2\alpha_3 + 3\alpha_4 + 2\alpha_5 + \alpha_6.$	36
$W(E_7)$	$s_{\alpha_2} s_{\alpha_3} s_{\alpha_5} s_{\alpha_7} s_{\alpha_{max}^{d4}} s_{\alpha_{max}^{d6}} s_{\alpha_{max}},$ $\text{where } \alpha_{max}^{d4} := \alpha_2 + \alpha_3 + 2\alpha_4 + \alpha_5,$ $\alpha_{max}^{d6} := \alpha_2 + \alpha_3 + 2\alpha_4 + 2\alpha_5 + 2\alpha_6 + \alpha_7,$ $\alpha_{max} = 2\alpha_1 + 2\alpha_2 + 3\alpha_3 + 4\alpha_4 + 3\alpha_5 + 2\alpha_6 + \alpha_7.$	63
$W(E_8)$	$s_{\alpha_2} s_{\alpha_3} s_{\alpha_5} s_{\alpha_7} s_{\alpha_{max}^{d4}} s_{\alpha_{max}^{d6}} s_{\alpha_{max}^{e7}} s_{\alpha_{max}},$ $\text{where } \alpha_{max}^{d4} := \alpha_2 + \alpha_3 + 2\alpha_4 + \alpha_5,$ $\alpha_{max}^{d6} := \alpha_2 + \alpha_3 + 2\alpha_4 + 2\alpha_5 + 2\alpha_6 + \alpha_7,$ $\alpha_{max}^{e7} := 2\alpha_1 + 2\alpha_2 + 3\alpha_3 + 4\alpha_4 + 3\alpha_5 + 2\alpha_6 + \alpha_7,$ $\alpha_{max} = 2\alpha_1 + 3\alpha_2 + 4\alpha_3 + 6\alpha_4 + 5\alpha_5 + 4\alpha_6 + 3\alpha_7 + 2\alpha_8.$	120
$W(F_4)$	$s_{\alpha_2} s_{\alpha_2+2\alpha_3} s_{\alpha_2+2\alpha_3+2\alpha_4} s_{\alpha_{max}},$ $\text{where } \alpha_{max} = 2\alpha_1 + 3\alpha_2 + 4\alpha_3 + 2\alpha_4.$	24
$W(G_2)$	$s_{\alpha_1+\alpha_2} s_{\alpha_2+3\alpha_1}$	6

TABLE 1.1. Longest elements in Weyl groups, see Tables A.3 and A.4. See Remark 1.7 on definitions of  $\alpha_{max}^{a5}$ ,  $\alpha_{max}^{d4}$  and  $\alpha_{max}^{d6}$ .

Root system	Max-orthogonal set	$n$	$l_a(w_0)$
$A_n$	$\alpha_{max}^{a2} < \alpha_{max}^{a4} < \cdots < \alpha_{max}^{a,2k}$	$n = 2k$	$\frac{n}{2}$
	$\alpha_{k+1} < \alpha_{max}^{a3} < \alpha_{max}^{a5} < \cdots < \alpha_{max}^{a,2k+1}$	$n = 2k + 1$	$\frac{n+1}{2}$
$B_n$	$\alpha_{max}^{b2} < \alpha_{max}^{b4} < \cdots < \alpha_{max}^{bn}$ , simple roots: $\alpha_1, \alpha_3, \dots, \alpha_{n-1}$ ,	$n = 2k$	$n$
	$\alpha_{max}^{b3} < \alpha_{max}^{b5} < \cdots < \alpha_{max}^{bn}$ , simple roots: $\alpha_1, \alpha_3, \dots, \alpha_{n-2}, \alpha_n$ .	$n = 2k + 1$	
$C_n$	$\alpha_n < \alpha_{max}^{c2} < \alpha_{max}^{c3} < \cdots < \alpha_{max}^{cn}$ .	any	$n$
$D_n$	$\alpha_{max}^{d4} < \alpha_{max}^{d6} < \cdots < \alpha_{max}^{d,n-2} < \alpha_{max}^{dn}$ simple roots: $\alpha_1, \alpha_3, \dots, \alpha_{n-3}$ and $\alpha_{n-1}, \alpha_n$ ,	$n = 2k$	$n$
	$\alpha_{max}^{d3} < \alpha_{max}^{d5} < \cdots < \alpha_{max}^{d,n-2} < \alpha_{max}^{dn}$ simple roots: $\alpha_1, \alpha_3, \dots, \alpha_{n-4}, \alpha_{n-2}$	$n = 2k + 1$	$n - 1$
$E_6$	$\alpha_4 < \alpha_{max}^{a3} < \alpha_{max}^{a5} < \alpha_{max}^{e6}$ .	6	4
$E_7$	$\alpha_{max}^{d4} < \alpha_{max}^{d6} < \alpha_{max}^{e7}$ , simple roots: $\alpha_2, \alpha_3, \alpha_5, \alpha_7$	7	7
$E_8$	$\alpha_{max}^{d4} < \alpha_{max}^{d6} < \alpha_{max}^{e7} < \alpha_{max}^{e8}$ . simple roots: $\alpha_2, \alpha_3, \alpha_5, \alpha_7$ ,	8	8
$F_4$	$\alpha_2 < \alpha_{max}^{c2} < \alpha_{max}^{c3} < \alpha_{max}$ .	4	4
$G_2$	$\alpha_1 < \alpha_{max}$	2	2

 TABLE 1.2. Max-orthogonal set and absolute length function  $l_a(w_0)$ .

#### 1.4. B.Kostant and A.Joseph: The cascade of orthogonal roots.

1.4.1. *The cascade construction.* A subset  $\{\beta_1, \beta_2, \dots, \beta_r \in \Phi\}$  is said to be a *strongly orthogonal* set of roots if  $\beta_i \pm \beta_j$  is not a root for all pairs  $\{i, j\}$ . Denote by  $\Delta_\lambda$  the subset of roots orthogonal to  $\lambda$ . The sequence of roots obtained by taking the highest root  $\alpha_{max}$  of  $\Phi$ , the corresponding highest roots of components of  $\Delta_{\alpha_{max}}$  and so on (see §1.4.2), is a strongly orthogonal set. In [10, p.5], Joseph refers to a private communication with Kostant, where the latter notes that: “. . . any orthogonal set of roots determines a strongly orthogonal set (by taking sums and differences) and any maximal strongly orthogonal set is unique up to  $W$ ”. In his following paper [11], Joseph finds maximal such sets for each root system and uses them for calculations in the universal enveloping algebra  $U(\mathfrak{g})$ , where  $\mathfrak{g}$  is a semisimple Lie algebra. Apparently, these maximal subsets were first presented in [11, Table III]. Today they are known as *Kostant’s cascade*.

Kostant and Joseph using the cascade construction, see [15, §1.1], independently of each other, using very different methods, obtained a number of structure theorems for the center  $U(\mathfrak{n})$ , where  $\mathfrak{n}$  is the span of the positive root spaces in  $\mathfrak{g}$ . In [8], Dimitrov and Tsanov obtained a complete list of homogeneous hypercomplex structures on the compact Lie groups using root subsets called *stem*, which were later recognized as the cascade constructed by Kostant and Joseph. The cascade is also used in [18] by Lipsman and Wolf for constructing certain elements in symmetric algebra  $S(\mathfrak{g})$  and by

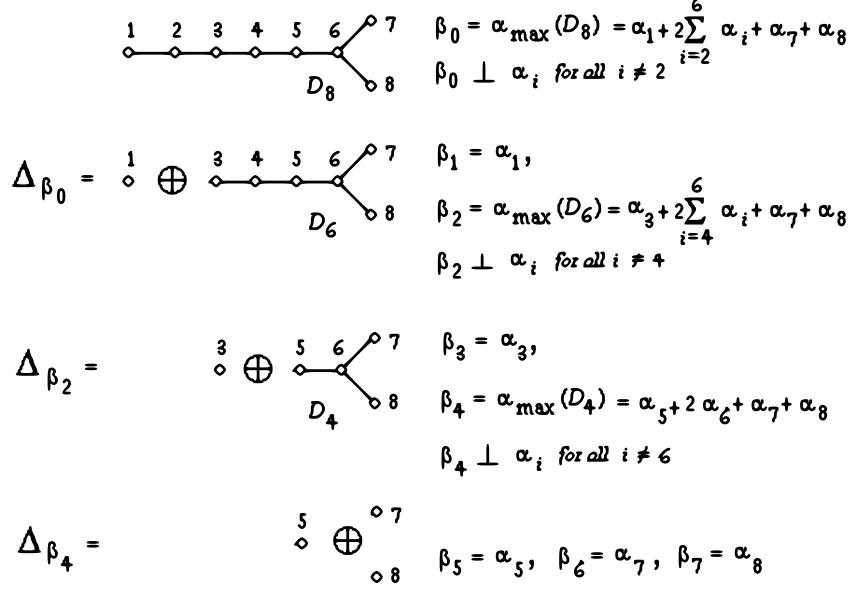

FIGURE 6. The  $D_8$ -cascade:  $\{\beta_0, \beta_1, \beta_2, \beta_3, \beta_4, \beta_5, \beta_6, \beta_7\}$

Panyushev in [25] for classification of a certain class parabolic subalgebras of  $\mathfrak{g}$ .

1.4.2. *Example: the  $D_8$ -cascade.* The  $D_8$ -cascade of orthogonal roots is constructed as follows:

- (1) The element  $\beta_0$  of cascade is the highest root  $\beta_0 = \alpha_{\max}(\Phi)$ .
- (2) Consider the root subset  $\Delta_{\beta_0}$  consisting of roots orthogonal to  $\beta_0$ :

$$\Delta_{\beta_0} = \{\alpha_i \in \Phi \mid (\alpha_i, \beta_0) = 0\}.$$

This subset splits into 2 connected components:

$$\Delta_{\beta_0} = \bigcup_{i_1} \Delta_{0i_1}, \text{ where } \Delta_{00} = \{\alpha_1\} \text{ and } \Delta_{01} = \Phi(D_6).$$

see Fig. 6.

(3) For each  $\Delta_{0i_1}$ , we recursively repeat steps (1) and (2). In other words, we find the highest root  $\beta_{0i_1}$  for each component  $\Delta_{0i_1}$  which splits into components  $\bigcup_{i_2} \Delta_{0i_1i_2}$  and so on. For details, see [11, §2.2] or [18, §3].

(4) For construction of  $D_8$ -cascade, see Fig. 6. The result  $D_8$ -cascade is as follows:

$$\begin{aligned} \beta_0 &= \alpha_{\max}(D_8), \beta_1 = \alpha_1, \beta_2 = \alpha_{\max}(D_6), \beta_3 = \alpha_3, \\ \beta_4 &= \alpha_{\max}(D_4), \beta_5 = \alpha_5, \beta_6 = \alpha_6, \beta_7 = \alpha_7. \end{aligned}$$

## 1.5. Bibliographic references.

1.5.1. *Applications of the longest element.* Let us list a few applications of the longest element.

- In the theory of algebraic groups, the longest element  $w_0$  connects the Borel subgroup  $B$  with the opposite Borel subgroup  $B^-$  as follows:  $B^- = w_0 B w_0$ , [9].



- In the representation theory of Lie algebras,  $w_0$  maps the highest weight  $\lambda$  (corresponding to simple representation  $L_\lambda$ ) to the highest weight  $-w_0\lambda$  (corresponding to the dual representation  $L_\lambda^*$ )<sup>1</sup>.
- The longest element of the finite Weyl group plays a special role in the decomposition formula of elements  $C_w$  of canonical basis (or Kazhdan-Lusztig basis) in the Hecke algebra  $\mathcal{H}(W)$ , see [3], [31].
- In the context of the  $q$ -analogue of the universal enveloping algebra  $\mathcal{U}$ , it was defined the canonical basis  $\mathcal{B}$  of  $\mathcal{U}^+$  (the positive part of  $\mathcal{U}$ ), which carries a natural coloured graph structure  $\mathcal{G}$ . Lusztig gave a description of  $\mathcal{G}$  using the Weyl group longest element, see [6], [12], [20], [21], [26].
- In the quiver varieties area, Nakajama introduced the reflection functor for the longest element of the Weyl group and identified it with the Lusztig's *new symmetry* for cases  $ADE$ , see [13], [24], [22].
- For more references on applications of the longest elements, see [2], [16], [23], [30].

### 1.5.2. Decompositions.

- Information about the reduced expressions of the longest elements is obtained from my calculations, see [29], and partly from [17], [19] and [1, Table 1].
- Perhaps Carter was the first who noticed that *each involution* in the Weyl group can be decomposed into a product of reflections corresponding to mutually orthogonal roots, and the number of these reflections can be very small. However, Carter's decomposition is not unique. [5, Lemma 5].
- In [28], Stanley proposed the simple formula for the number of reduced decompositions of the longest element in  $W(A_n)$ . The number of these decompositions reaches quite large numbers. For example, for  $W(A_5)$  this number is 292864.
- The so-called *totally orthogonal set* of roots was introduced by Deodhar. It was proved that for any involution  $w \in W$ , there exists a unique totally orthogonal set  $\{\varphi_1, \dots, \varphi_k\}$ , such that  $w_0 = s_{\varphi_1} \dots s_{\varphi_k}$ , [7, Theorem 5.4]. Deodhar's decomposition assumes the existence of some lexicographic order in the root system.
- After all the calculations for this paper were completed, I realized that the idea of the decomposition implemented here is close to that considered by Springer in [27]: *Let  $w \in W$  be an involution. There is a unique special parabolic subsystem  $J$  such that  $w$  is the longest element of  $W_J$* , see the proof in [27, Prop.3].

## 2. Relations in the Weyl groups

**Lemma 2.1** ( $\Lambda V$ -relation). *Let  $\{\alpha_k, \alpha_{k+1}, \dots, \alpha_{n-1}, \alpha_n\}$  is the sequence of simple roots corresponding to the connected subdiagram  $A_{n-k+1}$  of the Dynkin*

---

<sup>1</sup>See J. Humphreys' article "Longest element of a finite Coxeter group" (2015) available at <http://people.math.umass.edu/~yeh/pub/longest.pdf>

diagram  $A_l$ , such that only roots with adjacent indices are non-orthogonal. Let  $s_i$  be reflections in the Weyl group  $W(A_{n-k+1})$  associated with roots  $\alpha_i$ , where  $k \leq i \leq n$ . Then,

$$s_k s_{k+1} \cdots s_{n-1} s_n s_{n-1} \cdots s_{k+1} s_k = s_n s_{n-1} \cdots s_{k+1} s_k s_{k+1} \cdots s_{n-1} s_n. \quad (2.1)$$

Relation (2.1) is said to be the  $\Lambda V$ -relation in accordance with the stepwise form by which the indices are formed, see Fig. 7.

**Example 2.2.**

$$n = 1, \quad s_{n-1} s_n s_{n-1} = s_n s_{n-1} s_n, \text{ braid relation,}$$

$$n = 2, \quad s_{n-2} s_{n-1} s_n s_{n-1} s_{n-2} = s_n s_{n-1} s_{n-2} s_{n-1} s_n, \quad k = n - 2,$$

$$n = 3, \quad s_1 s_2 s_3 s_4 s_3 s_2 s_1 = s_4 s_3 s_2 s_1 s_2 s_3 s_4, \quad k = 1, n = 4, \text{ since}$$

$$s_1 s_2 (s_3 s_4 s_3) s_2 s_1 = s_1 s_2 s_{\alpha_3 + \alpha_4} s_2 s_1 = s_1 s_{\alpha_2 + \alpha_3 + \alpha_4} s_1 = s_{\alpha_1 + \alpha_2 + \alpha_3 + \alpha_4}, \text{ and}$$

$$s_4 s_3 (s_2 s_1 s_2) s_3 s_4 = s_4 s_3 s_{\alpha_1 + \alpha_2} s_3 s_4 = s_4 s_{\alpha_1 + \alpha_2 + \alpha_3} s_4 = s_{\alpha_1 + \alpha_2 + \alpha_3 + \alpha_4}. \quad \square$$

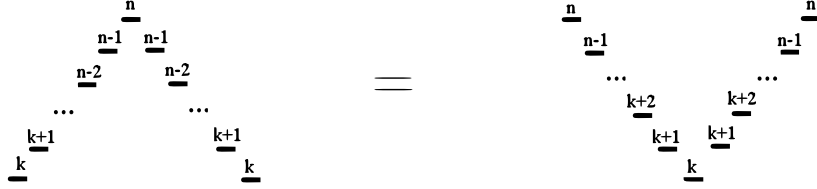

FIGURE 7. The stepwise shape of indices in  $\Lambda V$ -relations.

*Proof of Lemma 2.1.* Note that expressions standing in both sides of the  $\Lambda V$ -relation coincide with the reflection associated with the root

$$\alpha_k + \alpha_{k+1} + \cdots + \alpha_{n-1} + \alpha_n.$$

Eq. (2.1) is equivalent to 2 following equalities:

$$s_k s_{k+1} \cdots s_{n-1} s_n s_{n-1} \cdots s_{k+1} s_k = s_{\alpha_k + \alpha_{k+1} + \cdots + \alpha_{n-1} + \alpha_n} \quad (2.2)$$

$$s_n s_{n-1} \cdots s_{k+1} s_k s_{k+1} \cdots s_{n-1} s_n = s_{\alpha_k + \alpha_{k+1} + \cdots + \alpha_{n-1} + \alpha_n}$$

The induction step for the first (resp. second) equality in (2.2) is conjugation with  $s_k$  (resp.  $s_n$ ) and using Proposition B.2:

$$s_k s_{\alpha_{k+1} + \cdots + \alpha_{n-1} + \alpha_n} s_k = s_{\alpha_k + \alpha_{k+1} + \cdots + \alpha_{n-1} + \alpha_n},$$

$$s_n s_{\alpha_k + \alpha_{k+1} + \cdots + \alpha_{n-1}} s_n = s_{\alpha_k + \alpha_{k+1} + \cdots + \alpha_{n-1} + \alpha_n}. \quad \square$$

**Lemma 2.3** (on permutation). Let  $\{\alpha_k, \alpha_{k+1}, \dots, \alpha_n\}$  be the sequence of simple roots in the root system  $A_l$  corresponding to the set of consecutive vertices  $\{k, k+1, \dots, n\}$  in the Dynkin diagram  $A_l$ ,  $k \leq n \leq l$ . Then,

$$s_{\alpha_k + \dots + \alpha_{n-2} + \alpha_{n-1}} \prod_{n \geq j \geq k} s_j = \left( \prod_{n-1 \geq j \geq k+1} s_j \right) s_{\alpha_k + \alpha_{k+1} + \dots + \alpha_{n-1} + \alpha_n} \quad (2.3)$$

**Example 2.4.** Let us check eq. (2.3) for  $n = 5$ ,  $k = 1$ .

Since  $s_{\alpha_1 + \alpha_2 + \alpha_3 + \alpha_4} = s_4 s_3 s_2 s_1 s_2 s_3 s_4$ , then

$$s_{\alpha_1 + \alpha_2 + \alpha_3 + \alpha_4} s_5 s_4 s_3 s_2 s_1 = s_4 s_3 s_2 (s_1 s_2 s_3 s_4 s_5 s_4 s_3 s_2 s_1) =$$

$$s_4 s_3 s_2 s_{\alpha_1 + \alpha_2 + \alpha_3 + \alpha_4 + \alpha_5}. \quad \square$$

*Proof of Lemma 2.3.* As in Example 2.4, using Lemma 2.1, we have

$$\begin{aligned}
 s_{\alpha_k+\dots+\alpha_{n-2}+\alpha_{n-1}} \prod_{n \geq j \geq k} s_j &= s_{\alpha_k+\dots+\alpha_{n-2}+\alpha_{n-1}} s_n s_{n-1} \dots s_k = \\
 s_{\alpha_{n-1}} s_{\alpha_{n-2}} \dots s_{\alpha_{k+1}} s_{\alpha_k} s_{\alpha_{k+1}} \dots s_{\alpha_{n-1}} (s_{\alpha_n} s_{\alpha_{n-1}} \dots s_{k+1} s_k) &= \\
 (s_{\alpha_{n-1}} s_{\alpha_{n-2}} \dots s_{\alpha_{k+1}}) (s_{\alpha_k} s_{\alpha_{k+1}} \dots s_{\alpha_{n-1}} s_{\alpha_n} s_{\alpha_{n-1}} \dots s_{k+1} s_k) &= \\
 \left( \prod_{n-1 \geq j \geq k+1} s_j \right) s_{\alpha_k+\alpha_{k+1}+\dots+\alpha_{n-1}+\alpha_n}. &\quad \square
 \end{aligned}$$

### 3. Decomposition in $W(A_n)$

Let us introduce the notation for the highest roots in the root subsystems  $A_i \subset A_n$ , see Table 1.1. The numbering of the vertices of the Dynkin diagram  $A_n$  is shown in Fig. 8.

$$\alpha_{max}^{a,2i} := \sum_{j=k-i+1}^{k+i} \alpha_j, \quad \alpha_{max}^{a,2i+1} := \sum_{j=k-i+1}^{k+i+1} \alpha_j, \quad \text{where } i \geq 1. \quad (3.1)$$

see Remark 1.6. For  $i = 0$ , we put  $\alpha_{max}^{a1} := \alpha_{k+1}$ . By (3.1), the root  $\alpha_{max}^{ap}$  is the highest root in the root system  $A_p$  for any  $p \geq 0$ .

**Proposition 3.1.** (i) *The element*

$$w_0 = s_1(s_2s_1)(s_3s_2s_1) \dots (s_n s_{n-1} \dots s_2 s_1) \quad (3.2)$$

*is the longest element in  $W(A_n)$ .*

(ii) *The following equality holds:*

$$\begin{aligned}
 s_1(s_2s_1)(s_3s_2s_1) \dots (s_n s_{n-1} \dots s_2 s_1) &= \\
 s_n(s_{n-1}s_n)(s_{n-2}s_{n-1}s_n) \dots (s_1s_2 \dots s_{n-1}s_n). &\quad (3.3)
 \end{aligned}$$

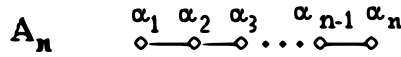

FIGURE 8. Numbering of simple roots in  $A_n$

*Proof.* (i) Let us denote the factors entering in (3.2) as follows:

$$w_1 = s_1, \quad w_2 = s_2s_1, \quad \dots, \quad w_{n-1} = s_{n-1} \dots s_2s_1, \quad w_n = s_n \dots s_2s_1. \quad (3.4)$$

Then,  $w_0 = w_1w_2 \dots w_n$ . For any integer  $k$  such that  $1 \leq k \leq n$ , we have

$$\begin{aligned}
 w_n : \alpha_k &\longrightarrow \alpha_{k-1}, \\
 w_{n-1} : \alpha_{k-1} &\longrightarrow \alpha_{k-2}, \\
 &\dots \\
 w_{n-k+2} : \alpha_2 &\longrightarrow \alpha_1,
 \end{aligned} \quad (3.5)$$

$$w_{n-k+1} : \alpha_1 \longrightarrow -(\alpha_1 + \alpha_2 + \dots + \alpha_{n-k+1}),$$

$$w_{n-k} : -(\alpha_1 + \alpha_2 + \dots + \alpha_{n-k+1}) \longrightarrow -\alpha_{n-k+1}.$$

Elements  $w_{n-k-1}, w_{n-k-2}, \dots, w_1$  preserve  $\alpha_{n-k+1}$ .

Let us explain (3.5). We have

$$\begin{aligned} w_n(\alpha_k) &= s_{\alpha_n} s_{\alpha_{n-1}} \dots s_{\alpha_k} s_{\alpha_{k-1}} \dots s_{\alpha_2} s_{\alpha_1}(\alpha_k) = \\ &= s_{\alpha_n} s_{\alpha_{n-1}} \dots s_{\alpha_k} s_{\alpha_{k-1}}(\alpha_k) = s_{\alpha_n} s_{\alpha_{n-1}} \dots s_{\alpha_k}(\alpha_k + \alpha_{k-1}) = \\ &= s_{\alpha_n} s_{\alpha_{n-1}} \dots s_{\alpha_{k+1}}(\alpha_{k-1}) = \alpha_{k-1}. \end{aligned}$$

Similarly,

$$\begin{aligned} w_{n-1}(\alpha_{k-1}) &= \alpha_{k-2}, \dots, w_{n-k+2}(\alpha_2) = \alpha_1, \\ w_{n-k+1}(\alpha_1) &= s_{\alpha_{n-k+1}} \dots s_{\alpha_1}(\alpha_1) = s_{\alpha_{n-k+1}} \dots s_{\alpha_2}(-\alpha_1) = \\ &= -(\alpha_1 + \dots + \alpha_{n-k+1}). \\ w_{n-k}(-(\alpha_1 + \dots + \alpha_{n-k+1})) &= s_{\alpha_{n-k}} \dots s_{\alpha_1}(-(\alpha_1 + \alpha_2 + \dots + \alpha_{n-k+1})) = \\ &= s_{\alpha_{n-k}} \dots s_{\alpha_2}(-(\alpha_2 + \dots + \alpha_{n-k+1})) = \dots = \\ &= s_{\alpha_{n-k}} s_{\alpha_{n-k-1}}(-(\alpha_{n-k-1} + \alpha_{n-k} + \alpha_{n-k+1})) = \\ &= s_{\alpha_{n-k}}(-(\alpha_{n-k} + \alpha_{n-k+1})) = -\alpha_{n-k+1}. \end{aligned}$$

By (3.5)  $w_0$  transforms  $\alpha_i$  to  $-\alpha_{n-i+1}$  for  $i = 1, 2, \dots, n$  and  $n \geq 2$ , see [4, Plate 1]. Because the longest element is unique in  $W(A_4)$ ,  $w_0$  is the longest.

(ii) Here, we just rename  $s_i$  to  $s_{n-i+1}$ .  $\square$

### Example 3.2.

$$\begin{aligned} n = 2, \quad w_0 &= s_1(s_2s_1) = \underline{s_{\alpha_1+\alpha_2}}, \\ n = 3, \quad w_0 &= s_1(s_2s_1)(s_3s_2s_1) = (s_2s_1s_2)(s_3s_2s_1) = \underline{s_{\alpha_2} s_{\alpha_1+\alpha_2+\alpha_3}}, \\ n = 4, \quad &\text{by Lemma 2.3, using the relation for } n = 3 : \\ w_0 &= s_1(s_2s_1)(s_3s_2s_1)(s_4s_3s_2s_1) = s_{\alpha_2} s_{\alpha_1+\alpha_2+\alpha_3}(s_4s_3s_2s_1) = \\ &= s_2(s_3s_2)s_{\alpha_1+\alpha_2+\alpha_3+\alpha_4} = \underline{s_{\alpha_2+\alpha_3} s_{\alpha_1+\alpha_2+\alpha_3+\alpha_4}}, \\ n = 5, \quad &\text{by Lemma 2.3, using the relation for } n = 4 : \\ w_0 &= s_1(s_2s_1)(s_3s_2s_1)(s_4s_3s_2s_1)(s_5s_4s_3s_2s_1) = \\ &= s_{\alpha_2+\alpha_3} s_{\alpha_1+\alpha_2+\alpha_3+\alpha_4}(s_5s_4s_3s_2s_1) = \\ &= s_{\alpha_2+\alpha_3}(s_4s_3s_2)s_{\alpha_1+\alpha_2+\alpha_3+\alpha_4+\alpha_5} = \underline{s_{\alpha_3} s_{\alpha_2+\alpha_3+\alpha_4} s_{\alpha_1+\alpha_2+\alpha_3+\alpha_4+\alpha_5}}. \end{aligned}$$

**Proposition 3.3** (decomposition in  $W(A_n)$ ). (i) *The longest element in  $W(A_n)$  is decomposed into  $\lfloor \frac{n+1}{2} \rfloor$  factors as follows:*

$$\begin{aligned} w_0 &= s_1(s_2s_1)(s_3s_2s_1) \dots (s_n s_{n-1} \dots s_2 s_1) = \\ &= \begin{cases} \prod_{i=1}^k s_{\alpha_{max}^{a,2i}} & \text{for } n = 2k, \\ s_{\alpha_{k+1}} \prod_{i=1}^k s_{\alpha_{max}^{a,2i+1}} & \text{for } n = 2k + 1. \end{cases} \end{aligned} \quad (3.6)$$

(ii) *The roots appearing in the decomposition (3.6) are mutually orthogonal. Thus, the factors in (3.6) commute with each other. The roots  $\alpha_{max}^{ap}$  are ordered as follows:*

$$\begin{aligned} \alpha_{max}^{a2} &< \alpha_{max}^{a4} < \dots < \alpha_{max}^{a,2k} & \text{for } n = 2k, \\ \alpha_{k+1} &< \alpha_{max}^{a3} < \alpha_{max}^{a5} < \dots < \alpha_{max}^{a,2k+1} & \text{for } n = 2k + 1. \end{aligned}$$

*Proof.* (i) The product of eq. (3.6) is  $w_0 = w_1 \dots w_n$ , see (3.2), (3.4). Let us discard the last factor  $w_n$ :  $w'_0 = w_1 \dots w_{n-1}$ . Using the induction step, we replace  $w'_0$  with the second line of (3.6), while  $n$  is replaced by  $n-1$  and

$k + 1$  by  $k$ . Further, we use relation of Lemma 2.3 and eq. (3.1):

$$\begin{aligned}
 & s_1(s_2s_1)(s_3s_2s_1)\dots(s_ns_{n-1}\dots s_2s_1) = \\
 & s_{\alpha_k}s_{\alpha_{k-1}+\alpha_k+\alpha_{k+1}}\dots s_{\alpha_2+\dots+\alpha_{n-2}}s_{\alpha_1+\dots+\alpha_{n-1}}(s_ns_{n-1}\dots s_2s_1) = \\
 & s_{\alpha_k}s_{\alpha_{k-1}+\alpha_k+\alpha_{k+1}}\dots s_{\alpha_3+\dots+\alpha_{n-3}}s_{\alpha_2+\dots+\alpha_{n-2}}(s_{n-1}\dots s_2)s_{\alpha_{max}} = \\
 & s_{\alpha_k}s_{\alpha_{k-1}+\alpha_k+\alpha_{k+1}}\dots s_{\alpha_3+\dots+\alpha_{n-3}}(s_{n-2}\dots s_3)\prod_{i=k-1}^k s_{\alpha_{max}^{a,2i}} = \\
 & s_{\alpha_k}s_{\alpha_{k-1}+\alpha_k+\alpha_{k+1}}\dots s_{\alpha_4+\dots+\alpha_{n-4}}(s_{n-3}\dots s_4)\prod_{i=k-2}^k s_{\alpha_{max}^{a,2i}} = \\
 & \dots \\
 & s_{\alpha_k}s_{\alpha_{k-1}+\alpha_k+\alpha_{k+1}}(s_{k+2}s_{k+1}s_k s_{k-1})\prod_{i=3}^k s_{\alpha_{max}^{a,2i}} = \\
 & s_{\alpha_k}(s_{k+1}s_k)s_{\alpha_{k-1}+\alpha_k+\alpha_{k+1}+\alpha_{k+2}}\prod_{i=3}^k s_{\alpha_{max}^{a,2i}} = s_{\alpha_k}(s_{k+1}s_k)s_{\alpha_{max}^{a,4}}\prod_{i=3}^k s_{\alpha_{max}^{a,2i}} = \\
 & (s_k s_{k+1} s_k)\prod_{i=2}^k s_{\alpha_{max}^{a,2i}} = s_{\alpha_k+\alpha_{k+1}}\prod_{i=2}^k s_{\alpha_{max}^{a,2i}} = \prod_{i=1}^k s_{\alpha_{max}^{a,2i}}.
 \end{aligned}$$

Similarly, the second equality of (3.6) is proved.

(ii) The orthogonality relations are verified directly.  $\square$

#### 4. Decomposition in $W(B_n)$

Let us introduce the notation for the highest roots in the root subsystem  $B_i \subset B_n$ , see Table 1.1. The numbering of vertices of the Dynkin diagram  $B_n$  is shown in Fig. 9.

$$\alpha_{max}^{bi} := \alpha_{n-i+1} + 2 \sum_{j=n-i+2}^n \alpha_j, \text{ where } i \geq 2.$$

see Remark 1.6. The root  $s_{\alpha_{max}^{bp}}$  is the highest root in the root system  $B_p$  for any  $p \geq 2$ . Let

$$\{\varepsilon_i \mid i = 1, 2, \dots, n\}$$

be the orthogonal basis of unit vectors in the linear space  $\mathbb{E}_n$ . The simple roots  $\{\alpha_i \mid i = 1, \dots, n\}$  in  $B_n$  are as follows:

$$\begin{aligned}
 & \alpha_i = \varepsilon_i - \varepsilon_{i+1} \text{ for } i = 1, \dots, n-1, \text{ and } \alpha_n = \varepsilon_n, \\
 & \|\alpha_i\| = \sqrt{2} \text{ for } i = 1, \dots, n-1, \text{ and } \|\alpha_n\| = 1,
 \end{aligned} \tag{4.1}$$

see [4, Plate II]. Then,

$$\varepsilon_i = \alpha_n + \alpha_{n-1} + \dots + \alpha_i, \text{ for } i < n, \text{ and } \varepsilon_n = \alpha_n. \tag{4.2}$$

**Proposition 4.1.** *The element*

$$w_0 = s_n(s_{n-1}s_ns_{n-1})(s_{n-2}s_{n-1}s_ns_{n-1}s_{n-2})\dots(s_1s_2\dots s_n\dots s_2s_1) \tag{4.3}$$

*is the longest element in  $W(B_n)$ .*

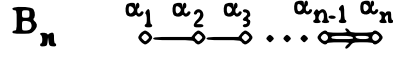
FIGURE 9. Numbering of simple roots in  $B_n$ 

*Proof.* Denote the factors of (4.3) as follows:

$$w_n = s_n, w_{n-1} = s_{n-1}s_n s_{n-1}, \dots, w_1 = s_1 s_2 \dots s_n \dots s_2 s_1.$$

The following relations hold:

$$\begin{aligned} w_i &= s_i w_{i+1} s_i & \text{for } i = 1, \dots, n-1, \\ w_i &= s_{\alpha_n + \alpha_{n-1} + \dots + \alpha_i} & \text{for } i = 1, \dots, n. \end{aligned} \quad (4.4)$$

By (4.2)  $w_i = s_{\varepsilon_i}$  for  $i = 1, \dots, n$ . The roots  $\varepsilon_i$  are short, and we use Proposition B.2 for conjugation in (4.4). Then,

$$w_0 = \prod_{i=1}^n s_{\varepsilon_i}. \quad (4.5)$$

where all  $s_{\varepsilon_i}$  commute with each other. The element  $w_0$  acts on  $\varepsilon_i$  as  $s_{\varepsilon_i}$ :

$$w_0(\varepsilon_i) = s_{\varepsilon_i}(\varepsilon_i) = -\varepsilon_i.$$

Thus,  $w_0 = -1$  on  $\mathbb{E}_n$ , see [4, Plate II]. Since the longest element in the Weyl group is unique,  $w_0$  is the longest.  $\square$

The roots  $\varepsilon_i = \alpha_n + \dots + \alpha_i$  are not highest roots, so the decomposition (4.5) is not max-orthogonal, see §1.2.3. We consider another decomposition for the longest element in  $W(B_n)$  that satisfies the max-orthogonality conditions (Proposition 4.3). Let us start with the following example using Propositions B.2 and B.4.

#### Example 4.2.

$$\begin{aligned} n = 2, \quad w_0 &= (s_2 s_1 s_2) s_1 = \underline{s_{\alpha_1 + 2\alpha_2} s_{\alpha_1}}, \\ n = 3, \quad w_0 &= s_3 s_2 (s_3 s_2 s_1 s_2 s_3) s_2 s_1 = s_3 (s_2 s_{\alpha_1 + \alpha_2 + 2\alpha_3} s_2) s_1 = \underline{s_3 (s_{\alpha_1 + 2\alpha_2 + 2\alpha_3}) s_1}, \\ n = 4, \quad w_0 &= s_4 (s_3 s_4 s_3) s_2 s_3 (s_4 s_3 s_2 s_1 s_2 s_3 s_4) s_3 s_2 s_1 = \\ &= (s_4 s_3 s_4) s_3 (s_2 s_3 (s_{\alpha_1 + \alpha_2 + \alpha_3 + 2\alpha_4}) s_3 s_2) s_1 = \underline{s_{\alpha_3 + 2\alpha_4} s_{\alpha_3} s_{\alpha_1 + 2\alpha_2 + 2\alpha_3 + 2\alpha_4} s_{\alpha_1}}, \\ n = 5, \quad w_0 &= s_5 (s_4 s_5 s_4) (s_3 s_4 s_5 s_4 s_3) (s_2 s_3 s_4 s_5 s_4 s_3 s_2) (s_1 s_2 s_3 s_4 s_5 s_4 s_3 s_2 s_1) = \\ &= s_5 (s_4 (s_5 s_4 s_3 s_4 s_5) s_4) (s_3) (s_2 s_3 s_4 (s_5 s_4 s_3 s_2 s_1 s_2 s_3 s_4 s_5) s_4 s_3 s_2) s_1 = \\ &= s_5 (s_4 s_{\alpha_3 + \alpha_4 + 2\alpha_5} s_4) (s_3) (s_2 s_3 s_4 s_{\alpha_1 + \alpha_2 + \alpha_3 + \alpha_4 + 2\alpha_5} s_4 s_3 s_2) s_1 = \\ &= \underline{s_5 (s_{\alpha_3 + 2\alpha_4 + 2\alpha_5}) s_3 (s_{\alpha_1 + 2\alpha_2 + 2\alpha_3 + 2\alpha_4 + 2\alpha_5}) s_1}. \end{aligned}$$

**Proposition 4.3** (decomposition in  $W(B_n)$ ). (i) *The longest element in  $W(B_n)$  is decomposed into  $n$  factors as follows:*

$$\begin{aligned} w_0 &= s_n (s_{n-1} s_n s_{n-1}) (s_{n-2} s_{n-1} s_n s_{n-1} s_{n-2}) \dots (s_1 s_2 \dots s_n \dots s_2 s_1) = \\ &= \begin{cases} \prod_{\substack{i=1 \\ i-\text{odd}}}^{n-1} (s_{\alpha_i} s_{\alpha_{max}^{b,n-i+1}}) & \text{for } n = 2k, \\ s_{\alpha_n} \prod_{\substack{i=1 \\ i-\text{odd}}}^{n-2} (s_{\alpha_i} s_{\alpha_{max}^{b,n-i+1}}) & \text{for } n = 2k + 1. \end{cases} \quad (4.6) \end{aligned}$$

(ii) *The roots appearing in the decomposition (4.6) are mutually orthogonal. Thus, the factors in (4.6) commute with each other. The roots  $s_{\alpha_{max}^{bp}}$  are ordered as follows:*

$$\begin{aligned} \alpha_{max}^{b2} &< \alpha_{max}^{b4} < \cdots < \alpha_{max}^{bn} && \text{for } n = 2k, \\ \alpha_{max}^{b3} &< \alpha_{max}^{b5} < \cdots < \alpha_{max}^{bn} && \text{for } n = 2k + 1. \end{aligned}$$

*Proof.* (i) Let us divide all factors in (4.6) into groups consisting of pairs of neighboring factors. Consider one such pair:

$p_i := (s_{i+1}s_{i+2} \cdots s_{n-1}s_n s_{n-1} \cdots s_{i+1})(s_i s_{i+1} \cdots s_{n-1}s_n s_{n-1} \cdots s_{i+2}s_{i+1}s_i)$ ,  
where  $i = 1 = 1, 3, \dots, n-1$  for  $n = 2k$  and  $i = 1, 3, \dots, n-2$  for  $n = 2k+1$ , see eq. (4.6). The element  $p_i$  is transformed as follows:

$$\begin{aligned} p_i &= s_{i+1}s_{i+2} \cdots s_{n-1}(s_n s_{n-1} \cdots s_{i+1}s_i s_{i+1} \cdots s_{n-1}s_n) s_{n-1} \cdots s_{i+2}s_{i+1}s_i = \\ &= s_{i+1}s_{i+2} \cdots s_{n-1}(s_n(s_{\alpha_i + \alpha_{i+1} + \cdots + \alpha_{n-1}})s_n) s_{n-1} \cdots s_{i+2}s_{i+1}s_i = \\ &= s_{i+1}s_{i+2} \cdots s_{n-1}(s_{\alpha_i + \alpha_{i+1} + \alpha_{i+2} + \cdots + \alpha_{n-1} + 2\alpha_n}) s_{n-1} \cdots s_{i+2}s_{i+1}s_i = \\ &= s_{i+1}s_{i+2} \cdots (s_{\alpha_i + \alpha_{i+1} + \alpha_{i+2} + \cdots + 2\alpha_{n-1} + 2\alpha_n}) \cdots s_{i+2}s_{i+1}s_i = \\ &= s_{i+1}(s_{\alpha_i + \alpha_{i+1} + 2\alpha_{i+2} + \cdots + 2\alpha_{n-1} + 2\alpha_n}) s_{i+1}s_i = \\ &= s_{\alpha_i + 2\alpha_{i+1} + 2\alpha_{i+2} + \cdots + 2\alpha_{n-1} + 2\alpha_n} s_i. \end{aligned} \tag{4.7}$$

In eq. (4.7), we use the following two relations:

- (1)  $(\alpha_i + \alpha_{i+1} + 2\alpha_{i+2} + \cdots + 2\alpha_n, \alpha_{i+1}) = -1 + 2 - 2 = -1$ , then  
 $s_{i+1}(s_{\alpha_i + \alpha_{i+1} + 2\alpha_{i+2} + \cdots + 2\alpha_n}) s_{i+1} = s_{(\alpha_i + \alpha_{i+1} + 2\alpha_{i+2} + \cdots + 2\alpha_n) + \alpha_{i+1}} =$   
 $s_{\alpha_i + 2\alpha_{i+1} + 2\alpha_{i+2} + \cdots + 2\alpha_n}$ ,
- (2)  $(\alpha_i + 2\alpha_{i+1} + 2\alpha_{i+2} + \cdots + 2\alpha_n, \alpha_i) = 2 - 2 = 0$ , then  
 $s_i$  and  $s_{\alpha_i + 2\alpha_{i+1} + 2\alpha_{i+2} + \cdots + 2\alpha_n}$  commute.

(ii) By (4.2) we get

$$\begin{aligned} \varepsilon_i + \varepsilon_{i+1} &= \alpha_i + 2\alpha_{i+1} + \cdots + 2\alpha_{n-1} + 2\alpha_n, \\ p_i &= s_{\varepsilon_i + \varepsilon_{i+1}} s_{\alpha_i}. \end{aligned}$$

The roots  $\varepsilon_i + \varepsilon_{i+1}$  are highest in the root subsystem  $B_{n-i+1}$ . Then, for  $n = 2k$ , relation (4.6) has  $n$  factors and looks as follows:

$$w_0 = \prod_{i=1,3,\dots,n-1} s_{\varepsilon_i + \varepsilon_{i+1}} s_{\alpha_i}, \tag{4.8}$$

For  $n = 2k + 1$ , relation (4.6) also has  $n$  factors and is equivalent to the following:

$$w_0 = s_{\alpha_n} \prod_{i=1,3,\dots,n-2} s_{\varepsilon_i + \varepsilon_{i+1}} s_{\alpha_i}, \tag{4.9}$$

The orthogonality of roots corresponding to reflections in (4.8) (resp. (4.9)) is verified directly. For example, since  $(\varepsilon_i, \varepsilon_j) = 0$  for  $i \neq j$ , we have

$$(\varepsilon_i + \varepsilon_{i+1}, \varepsilon_{i+2} + \varepsilon_{i+3}) = 0, \quad i + 3 \leq n.$$

In addition, for  $i + 1 < n$ , the following relation holds:

$$(\varepsilon_i + \varepsilon_{i+1}, \alpha_i) = (\alpha_i, \alpha_i) + 2(\alpha_i, \alpha_{i+1}) = 2 - 2 = 0,$$

and for  $i + 3 \leq n$ ,

$$(\varepsilon_i + \varepsilon_{i+1}, \alpha_{i+2}) = 2(\alpha_{i+1} + \alpha_{i+2} + \alpha_{i+3}, \alpha_{i+2}) = 0. \quad \square$$

### 5. Decomposition in $W(C_n)$

We introduce the notation for the highest roots in the root subsystems  $C_i \subset C_n$  see Table 1.1. The numbering of vertices of  $C_n$  is shown in Fig. 10.

$$\alpha_{max}^{ci} := 2 \sum_{j=n-i+1}^{n-1} \alpha_j + \alpha'_n, \text{ where } i \geq 2, \text{ and } \alpha_{max}^{c1} := \alpha'_n. \quad (5.1)$$

see Remark 1.6. The root  $\alpha_{max}^{ci}$  is the highest root in the root system  $C_i$  for any  $i \geq 2$ .

Recall that the Weyl groups  $W(B_n)$  and  $W(C_n)$  coincide, however the decompositions of the longest elements are specialized for the cases  $B_n$  and  $C_n$ . Consider the root systems  $B_n$  and  $C_n$  in the same linear space  $\mathbb{E}_n$  with an orthogonal basis of unit vectors

$$\{\varepsilon_i \mid i = 1, 2, \dots, n\}.$$

The simple roots in  $B_n$  are denoted by  $\alpha_i$ , see (4.1). Denote simple roots in  $C_n$  by  $\alpha'_i$ . The simple roots  $\{\alpha'_i \mid i = 1, \dots, n\}$  in  $C_n$  are as follows:

$$\begin{aligned} \alpha'_i &= \varepsilon_i - \varepsilon_{i+1} \text{ for } i = 1, \dots, n-1, \text{ and } \alpha'_n = 2\varepsilon_n, \\ \|\alpha_i\| &= \sqrt{2} \text{ for } i = 1, \dots, n-1, \text{ and } \|\alpha_n\| = 2. \end{aligned}$$

We have

$$\alpha'_i = \alpha_i \text{ for } i < n, \text{ and } \alpha'_n = 2\alpha_n$$

Put  $\varepsilon'_i = 2\varepsilon_i$  for  $i = 1, \dots, n$ . Then,

$$\begin{aligned} \varepsilon_i &= \alpha_n + \alpha_{n-1} + \dots + \alpha_i, \quad \text{for } i < n, \\ \varepsilon'_i &= \alpha'_n + 2\alpha_{n-1} + \dots + 2\alpha_i \quad \text{for } i < n, \\ \varepsilon_n &= \alpha_n, \quad \varepsilon'_n = 2\varepsilon_n = 2\alpha_n = \alpha'_n. \end{aligned} \quad (5.2)$$

By (5.1) and (5.2),  $\varepsilon'_i$  is the highest root in  $C_i$ , i.e.,

$$\varepsilon'_i = \alpha_{max}^{c,n-i+1} \text{ for } i \geq 2, \text{ and } \varepsilon'_n = \alpha_{max}^{c1} = \alpha'_n.$$

**Proposition 5.1** (decomposition in  $W(C_n)$ ). *The element  $w_0$  is decomposed into  $n$  factors as follows:*

$$w_0 = \prod_{i=1}^n s_{\varepsilon'_i} = s_{\alpha'_n} \prod_{i=1}^{n-1} s_{\alpha_{max}^{c,n-i+1}}. \quad (5.3)$$

*The roots corresponding to factors (5.3) are mutually orthogonal. Thus, the factors in (5.3) commute with each other. The roots  $\varepsilon'_i$  are ordered as follows:*

$$\alpha'_n < \alpha_{max}^{c2} < \alpha_{max}^{c3} < \dots < \alpha_{max}^{cn}. \quad (5.4)$$

*Proof.* Since the Weyl groups  $W(B_n) = W(C_n)$  coincide, the longest element  $w_0$  is the same for  $B_n$  and  $C_n$ . Recall that  $\varepsilon'_i = 2\varepsilon_i$ , i.e., reflections  $s_{\varepsilon_i}$  and  $s_{\varepsilon'_i}$  coincide for  $i = 1, \dots, n$ . Then, taking into account (4.5), we obtain

$$w_0 = \prod_{i=1}^n s_{\varepsilon_i} = \prod_{i=1}^n s_{\varepsilon'_i},$$



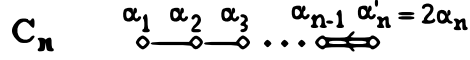

FIGURE 10. Numbering of simple roots in  $C_n$ . Here,  $\alpha_n$  (resp.  $\alpha'_n$ ) is the simple root in  $B_n$  (resp.  $C_n$ )

where all  $s_{\varepsilon_i}$  (resp.  $s_{\varepsilon'_i}$ ) commute with each other. The element  $w_0$  acts on  $\varepsilon'_i$  as  $s_{\varepsilon'_i}$ :

$$w_0(\varepsilon_i) = s_{\varepsilon'_i}(\varepsilon'_i) = -\varepsilon'_i.$$

Thus,  $w_0 = -1$  on  $\mathbb{E}_n$ , see [4, Plate III]. Since the longest element is unique, then  $w_0$  is the longest.  $\square$

## 6. Decomposition in $W(D_n)$ , $n \geq 4$

Let us introduce the notation for the highest roots in the root subsystem  $D_i \subset D_n$ , see Table 1.1. The numbering of vertices in the Dynkin diagram  $D_n$  is shown in Fig. 11.

$$\begin{aligned} \alpha_{max}^{di} &:= \alpha_{n-i+1} + 2 \sum_{j=n-i+2}^{n-2} \alpha_j + \alpha_{n-1} + \alpha_n \quad \text{for } i \geq 4, \\ \alpha_{max}^{d3} &:= \alpha_{max}^{a3} := \alpha_{n-2} + \alpha_{n-1} + \alpha_n. \end{aligned} \quad (6.1)$$

see Remark 1.6. The root  $\alpha_{max}^{dp}$  is the highest root in the root system  $D_p$  for any  $p \geq 3$ . We shall regard the following element  $w_0$  in  $W(D_n)$ :

$$w_0 = s_n s_{n-1} (s_{n-2} s_n s_{n-1} s_{n-2}) \cdots (s_1 s_2 \cdots s_{n-2} s_n s_{n-1} s_{n-2} \cdots s_2 s_1). \quad (6.2)$$

In Proposition 6.2, we find the max-orthogonal decomposition of  $w_0$  and prove that  $w_0$  is the longest element in  $W(D_n)$ . First of all, let us start with examples of decomposition of  $w_0$  for small values of  $n$ .

### Example 6.1.

$$\begin{aligned} n = 4, \quad w_0 &= s_4 s_3 (s_2 s_4 s_3 s_2) (s_1 s_2 s_4 s_3 s_2 s_1) = s_4 s_3 s_2 (s_4 s_3 (s_2 s_1 s_2) s_4 s_3) s_2 s_1 = \\ &= s_4 s_3 s_2 s_{\alpha_1 + \alpha_2 + \alpha_3 + \alpha_4} s_2 s_1 = s_4 s_3 s_{\alpha_1 + 2\alpha_2 + \alpha_3 + \alpha_4} s_1 = \underline{s_3 s_4 s_{\alpha_{max}} s_1}, \\ n = 5, \quad w_0 &= s_5 s_4 (s_3 s_5 s_4 s_3) (s_2 s_3 s_5 s_4 s_3 s_2) (s_1 s_2 s_3 s_5 s_4 s_3 s_2 s_1) = \\ &= (s_5 s_4 s_3 s_5 s_4) s_3 (s_2 s_3 s_5 s_4 (s_3 s_2 s_1 s_2 s_3) s_5 s_4 s_3 s_2) s_1 = \\ &= s_{\alpha_3 + \alpha_4 + \alpha_5} s_3 s_{\alpha_1 + 2\alpha_2 + 2\alpha_3 + \alpha_4 + \alpha_5} s_1 = \underline{(s_{\alpha_3 + \alpha_4 + \alpha_5}) s_3 (s_{\alpha_{max}}) s_1}, \\ n = 6, \quad w_0 &= s_6 s_5 (s_4 s_6 s_5 (s_4 s_3 s_4) s_6 s_5 s_4) s_3 \times \\ &= (s_2 s_3 s_4 (s_6 s_5 s_4 (s_3 s_2 s_1 s_2 s_3) s_4 s_6 s_5) s_4 s_3 s_2) s_1 = \\ &= s_5 s_6 (s_{\alpha_3 + 2\alpha_4 + \alpha_5 + \alpha_6}) s_3 (s_{\alpha_1 + 2\alpha_2 + 2\alpha_3 + 2\alpha_4 + \alpha_5 + \alpha_6}) s_1 = \\ &= \underline{s_5 s_6 (s_{\alpha_3 + 2\alpha_4 + \alpha_5 + \alpha_6}) s_3 (s_{\alpha_{max}}) s_1}, \\ n = 7, \quad w_0 &= s_7 s_6 (s_5 s_7 s_6 s_5) (s_4 s_5 s_7 s_6 s_5 s_4) (s_3 s_4 s_5 s_7 s_6 s_5 s_4 s_3) \times \\ &= (s_2 s_3 s_4 s_5 s_7 s_6 s_5 s_4 s_3 s_2) (s_1 s_2 s_3 s_4 s_5 s_7 s_6 s_5 s_4 s_3 s_2 s_1) = \\ &= \cdots (s_2 s_3 s_4 s_5 (s_{\alpha_1 + \alpha_2 + \alpha_3 + \alpha_4 + \alpha_5 + \alpha_6 + \alpha_7}) s_5 s_4 s_3 s_2) s_1 = \\ &= s_7 s_6 (s_5 s_7 s_6 s_5) (s_4 s_5 s_7 s_6 (s_5 s_4 s_3 s_4 s_5) s_7 s_6 s_5 s_4) s_3 (s_{\alpha_1 + 2\alpha_2 + 2\alpha_3 + 2\alpha_4 + 2\alpha_5 + \alpha_6 + \alpha_7}) s_1 = \\ &= (s_7 s_6 s_5 s_7 s_6) s_5 (s_{\alpha_3 + 2\alpha_4 + 2\alpha_5 + \alpha_6 + \alpha_7}) s_3 (s_{\alpha_1 + 2\alpha_2 + 2\alpha_3 + 2\alpha_4 + 2\alpha_5 + \alpha_6 + \alpha_7}) s_1 = \\ &= (s_{\alpha_5 + \alpha_6 + \alpha_7}) s_5 (s_{\alpha_3 + 2\alpha_4 + 2\alpha_5 + \alpha_6 + \alpha_7}) s_3 (s_{\alpha_1 + 2\alpha_2 + 2\alpha_3 + 2\alpha_4 + 2\alpha_5 + \alpha_6 + \alpha_7}) s_1 = \\ &= \underline{(s_{\alpha_5 + \alpha_6 + \alpha_7}) s_5 (s_{\alpha_3 + 2\alpha_4 + 2\alpha_5 + \alpha_6 + \alpha_7}) s_3 (s_{\alpha_{max}}) s_1}. \end{aligned}$$

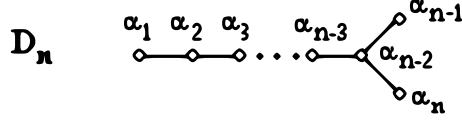
FIGURE 11. Numbering of simple roots in  $D_n$ 

Example 6.1 prompts us the general form of the element  $w_0$ .  $\square$

**Proposition 6.2** (decomposition in  $W(D_n)$ ). (i) *The element  $w_0$  in  $W(D_n)$  can be decomposed into  $n$  (resp.  $n-1$ ) factors for  $n = 2k$  (resp.  $n = 2k+1$ ):*

$$w_0 = \begin{cases} s_{\alpha_n} s_{\alpha_{n-1}} \prod_{\substack{i=1 \\ i\text{-odd}}}^{n-3} (s_{\omega_i} s_{\alpha_i}), & \text{where } \omega_i = \alpha_{max}^{d,n-i+1}. \\ \prod_{\substack{i=1 \\ i\text{-odd}}}^{n-2} (s_{\omega_i} s_{\alpha_i}), & \text{where } \omega_i = \alpha_{max}^{d,n-i+1}. \end{cases} \quad (6.3)$$

The root corresponding to factors in (6.3) are as follows:

$$\begin{aligned} \text{For } n = 2k : & \begin{cases} \alpha_{max}^{d4}, \alpha_{max}^{d6}, \dots, \alpha_{max}^{d,n-2}, \alpha_{max}, \\ \alpha_1, \alpha_3, \dots, \alpha_{n-5}, \alpha_{n-3}, \alpha_{n-1}, \alpha_n. \end{cases} \\ \text{For } n = 2k + 1 : & \begin{cases} \alpha_{max}^{d3}, \alpha_{max}^{d5}, \alpha_{max}^{d7}, \dots, \alpha_{max}^{d,n-2}, \alpha_{max}, \\ \alpha_1, \alpha_3, \dots, \alpha_{n-4}, \alpha_{n-2}. \end{cases} \end{aligned} \quad (6.4)$$

(ii) *The roots in the decomposition (6.3) are mutually orthogonal. Thus, factors in (6.3) commute with each other. The roots  $\alpha_{max}^{dp}$  are ordered as follows:*

$$\begin{aligned} \alpha_{max}^{d4} &< \alpha_{max}^{d6} < \dots < \alpha_{max}^{d,n-2} < \alpha_{max}^{dn} = \alpha_{max} & \text{for } n = 2k, \\ \alpha_{max}^{d3} &< \alpha_{max}^{d5} < \dots < \alpha_{max}^{d,n-2} < \alpha_{max}^{dn} = \alpha_{max} & \text{for } n = 2k + 1. \end{aligned} \quad (6.5)$$

Here,  $\alpha_{max}^{d3} = \alpha_{max}^{a3}$ , see (6.1).

(iii) *The element  $w_0$  acts as  $-1$  if  $n = 2k$ , and as  $-\varepsilon$  if  $n = 2k + 1$ , where  $\varepsilon$  is the automorphism that interchanges roots  $\alpha_n$  and  $\alpha_{n-1}$  and fixes all other simple roots. In other words, is the longest element in  $W(D_n)$ , see [4, Plate IV].*

Before proving Proposition 6.2, we need the following lemma:

**Lemma 6.3.** (i) *Let  $D_k \subset D_n$  be the root system corresponding to the highest root  $\alpha_{max}^{dk}$  in (6.5). The index of the leftmost root, see Fig. 12, for the root system  $D_k$  is odd and it is equal to  $n - k + 1$ .*

(ii) *Let  $i$  be even. The roots  $\alpha_{max}^{d,n-i}$  and  $\alpha_{max}^{d,n-i+2}$  are the only 2 roots among the highest roots  $\alpha_{max}^{dp}$  in (6.5) that are not orthogonal to  $\alpha_i$ .*

(iii) *Let  $i$  be odd. All roots  $\alpha_{max}^{dp}$  in (6.5) are orthogonal to  $\alpha_i$ .*

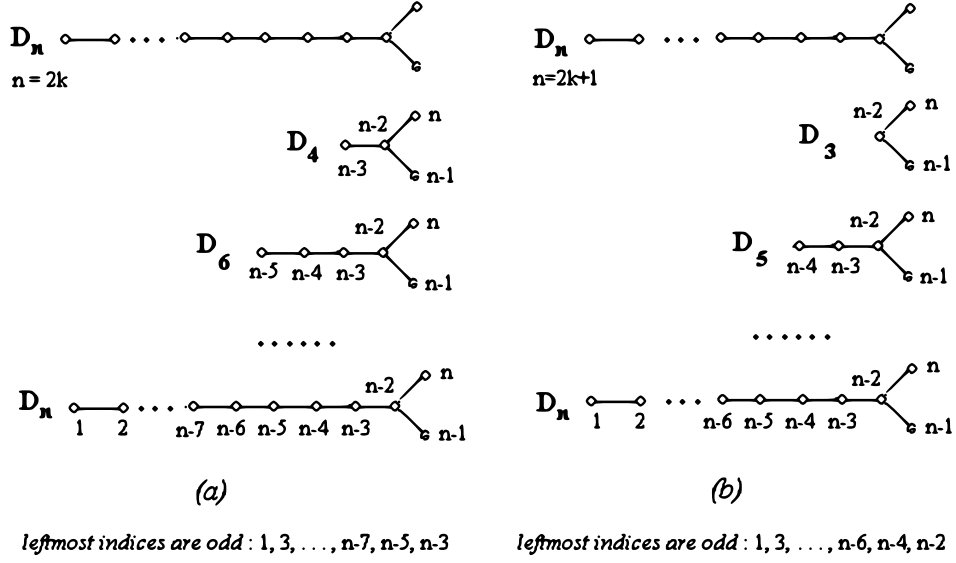

FIGURE 12. The leftmost indices for diagrams  $D_{2p}$  (side (a)) and  $D_{2p+1}$  (side (b)) are odd

*Proof.* (i) In the list of (6.4) with  $n = 2k$ , the leftmost root of  $D_{2p}$  is  $n - 2p + 1$ , i.e., all leftmost roots have odd indices, see Fig. 12(a). In the list of (6.4) with  $n = 2k + 1$ , the leftmost of  $D_{2p+1}$  is  $n - 2p$ , i.e., again, all leftmost roots have odd indices, see Fig. 12(b).

(ii) Adjacent roots for  $\alpha_i$ , where  $i$  is even, are  $\alpha_{i-1}$  and  $\alpha_{i+1}$ . By (i) they correspond to the leftmost roots of  $D_{n-i+2}$  and  $D_{n-i}$ . Among all the highest roots of the list (6.5) only the highest roots corresponding to  $D_{n-i+2}$  and  $D_{n-i}$  are not orthogonal to  $\alpha_i$ . These roots are  $\alpha_{max}^{d,n-i}$  and  $\alpha_{max}^{d,n-i+2}$ .

(iii) It holds because the only simple root not orthogonal to  $\alpha_{max}^{dp}$  is the root adjacent to the leftmost root with index  $n - p + 1$ , but such a root has even index  $n - p + 2$ .  $\square$

*Proof of Proposition 6.2.*

(i) Let us divide all the factors in brackets in (6.2) into pairs of neighboring factors. Each such pair is converted into two neighboring factors in (6.3). Taking into account that  $s_n$  and  $s_{n-1}$  commute and repeatedly applying Proposition B.2, we get:

$$\begin{aligned}
 & (s_{i+1} \dots s_{n-2} s_n s_{n-1} s_{n-2} \dots s_{i+1}) (s_i s_{i+1} \dots s_{n-2} s_n s_{n-1} s_{n-2} \dots s_{i+1} s_i) = \\
 & s_{i+1} \dots s_{n-2} (s_n s_{n-1} s_{n-2} \dots s_{i+1} s_i s_{i+1} \dots s_{n-2} s_{n-1} s_n) s_{n-2} \dots s_{i+1} s_i = \\
 & s_{i+1} \dots s_{n-3} s_{n-2} (s_{\alpha_n + \alpha_{n-1} + \alpha_{n-2} + \alpha_{n-3} + \dots + \alpha_{i+1} + \alpha_i}) s_{n-2} s_{n-3} \dots s_{i+1} s_i = \\
 & s_{i+1} \dots s_{n-3} (s_{\alpha_n + \alpha_{n-1} + 2\alpha_{n-2} + \alpha_{n-3} + \dots + \alpha_{i+1} + \alpha_i}) s_{n-3} \dots s_{i+1} s_i = \\
 & s_{i+1} \dots (s_{\alpha_n + \alpha_{n-1} + 2\alpha_{n-2} + 2\alpha_{n-3} + \dots + \alpha_{i+1} + \alpha_i}) \dots s_{i+1} s_i = \dots \\
 & (s_{\alpha_n + \alpha_{n-1} + 2\alpha_{n-2} + 2\alpha_{n-3} + \dots + 2\alpha_{i+1} + \alpha_i}) s_i.
 \end{aligned}$$

(ii) The only simple root not orthogonal to  $\alpha_{max}$  is  $\alpha_2$ , which is not a component in any root of list (6.4). Then, the highest root  $\alpha_{max} = \alpha_{max}^{dn}$  is orthogonal to all other roots of list (6.4). Further, the only simple root

not orthogonal to  $\alpha_{max}^{d,n-2}$  is  $\alpha_4$ , which is not a component in any roots of list (6.4), except of  $\alpha_{max}$ . Then, the root  $\alpha_{max}^{d,n-2}$  is orthogonal to all other roots of list (6.4), except of  $\alpha_{max}$ . But orthogonality  $\alpha_{max}$  and  $\alpha_{max}^{d,n-2}$  has already been proved. Continuing in this way, we obtain orthogonality for all remaining roots in (6.4).

(iii) We consider the action of  $w_0$  on the following 4 types of simple roots  $\alpha_i$  in  $D_n$ .

(a) Actions on  $\alpha_i$  with odd  $i < n - 2$ . By Lemma 6.3(iii) among the factors associated with (6.4) only  $s_{\alpha_i}$  acts not trivially on  $\alpha_i$ , i.e.,

$$w_0(\alpha_i) = s_{\alpha_i}(\alpha_i) = -\alpha_i.$$

(b) Actions on  $\alpha_i$  with even  $i < n - 2$ . In this section, we use a shorter notation:

$$s_{n-i,max} \text{ instead of } s_{\alpha_{max}^{d,n-i}} \text{ and } s_{n-i+2,max} \text{ instead of } s_{\alpha_{max}^{d,n-i+2}}.$$

By Lemma 6.3, among roots (6.4) only the following reflections non-trivially act on  $\alpha_i$ :

$$s_{\alpha_{i-1}}, s_{\alpha_{i+1}}, s_{n-i+2,max}, s_{n-i,max}$$

Using eq. (6.1) we get the following:

$$\begin{aligned} \alpha^{d,n-i} &= \alpha_{i+1} + 2(\alpha_{i+2} + \dots + \alpha_{n-2}) + \alpha_{n-1} + \alpha_n, \\ \alpha^{d,n-i+2} &= \alpha_{i-1} + 2(\alpha_i + \dots + \alpha_{n-2}) + \alpha_{n-1} + \alpha_n. \end{aligned}$$

Then,

$$\begin{aligned} (\alpha_{max}^{d,n-i}, \alpha_i) &= (\alpha_{i+1}, \alpha_i) = -1, \\ (\alpha_{max}^{d,n-i+2}, \alpha_i) &= (\alpha_{i-1} + 2\alpha_i + 2\alpha_{i+1}, \alpha_i) = -1 + 4 - 2 = 1, \\ \alpha_{max}^{d,n-i+2} - \alpha_{max}^{d,n-i} &= \alpha_{i-1} + 2\alpha_i + \alpha_{i+1}. \end{aligned} \quad (6.6)$$

see Fig. 12. By (6.6) we have

$$\begin{aligned} w_0(\alpha_i) &= s_{n-i,max} s_{n-i+2,max} s_{i-1} s_{i+1}(\alpha_i) = \\ &= s_{n-i,max} s_{n-i+2,max}(\alpha_i + \alpha_{i-1} + \alpha_{i+1}). \end{aligned}$$

Since  $i + 1$  and  $i - 1$  are odd, by Lemma 6.3(iii) reflections  $s_{n-i,max}$  and  $s_{n-i+2,max}$  preserve  $\alpha_{i-1} + \alpha_{i+1}$ . Then, by (6.6)

$$\begin{aligned} w_0(\alpha_i) &= \alpha_{i-1} + \alpha_{i+1} + s_{n-i,max} s_{n-i+2,max}(\alpha_i) = \\ &= \alpha_{i-1} + \alpha_{i+1} + s_{n-i,max}(\alpha_i - \alpha_{max}^{d,n-i+2}) = \\ &= \alpha_{i-1} + \alpha_{i+1} + \alpha_i + (\alpha_{max}^{d,n-i} - \alpha_{max}^{n-i+2}) = \\ &= \alpha_{i-1} + \alpha_i + \alpha_{i+1} - (\alpha_{i-1} + 2\alpha_i + \alpha_{i+1}) = -\alpha_i. \end{aligned}$$

(c) Actions on  $\alpha_{n-1}$  and  $\alpha_n$ . Let  $n$  be even. Among the factors associated with (6.4) only  $s_{\alpha_{n-1}}$  acts on  $\alpha_{n-1}$ , and only  $s_{\alpha_n}$  acts on  $\alpha_n$ . Thus,

$$w_0(s_{\alpha_{n-1}}) = -s_{\alpha_{n-1}}, \quad w_0(s_{\alpha_n}) = -s_{\alpha_n}.$$

Let  $n$  be odd. Among the factors associated with (6.4) only  $s_{\alpha_{n-2}}$  and  $\alpha_{max}^{d3}$  acts on  $\alpha_{n-1}, \alpha_n$ . Then,

$$\begin{aligned} w_0(\alpha_{n-1}) &= s_{\alpha_{max}^{d3}} s_{n-2}(\alpha_{n-1}) = s_{\alpha_{max}^{d3}}(\alpha_{n-1} + \alpha_{n-2}) = \\ & s_{\alpha_n + \alpha_{n-1} + \alpha_{n-2}}(\alpha_{n-1} + \alpha_{n-2}) = -\alpha_n, \text{ and} \\ w_0(\alpha_n) &= s_{\alpha_{max}^{d3}} s_{n-2}(\alpha_n) = s_{\alpha_{max}^{d3}}(\alpha_n + \alpha_{n-2}) = \\ & s_{\alpha_n + \alpha_{n-1} + \alpha_{n-2}}(\alpha_n + \alpha_{n-2}) = -\alpha_{n-1}. \end{aligned}$$

Thus, if  $n$  is odd,  $w_0 = -\varepsilon$ , where  $\varepsilon$  acts on as the automorphism that interchanges  $\alpha_n$  and  $\alpha_{n-1}$ , see [4, Plate IV].

(d) Actions on the branch point  $\alpha_{n-2}$ . Let  $n$  is even. Among the factors associated with (6.4) only  $s_{\alpha_n}, s_{\alpha_{n-1}}, s_{\alpha_{n-3}}$  and  $s_{\alpha_{max}^{d4}}$  act on  $\alpha_{n-2}$ . Note that  $\alpha_{max}^{d4} \perp \{\alpha_{n-1}, \alpha_n, \alpha_{n-3}\}$ , then

$$\begin{aligned} w_0(\alpha_{n-2}) &= s_{\alpha_{max}^{d4}} s_{\alpha_n} s_{\alpha_{n-1}} s_{\alpha_{n-3}}(\alpha_{n-2}) = \\ & s_{\alpha_{max}^{d4}}(\alpha_{n-2} + \alpha_{n-3} + \alpha_{n-1} + \alpha_n) = \\ & \alpha_{n-3} + \alpha_{n-1} + \alpha_n + s_{\alpha_{max}^{d4}}(\alpha_{n-2}) = \\ & \alpha_{n-3} + \alpha_{n-1} + \alpha_n + (\alpha_{n-2} - \alpha_{max}^{d4}) = -\alpha_{n-2}. \end{aligned}$$

Let  $n$  is odd. Among the factors of (6.4) only  $s_{\alpha_{n-2}}$  acts on  $\alpha_{n-2}$ . Then,  $w_0(\alpha_{n-2}) = s_{\alpha_{n-2}}(\alpha_{n-2}) = -\alpha_{n-2}$ .  $\square$

## 7. Decomposition in $W(E_6)$

Let us denote the highest roots in the root subsystems  $A_3 \subset A_5 \subset E_6$  as follows:

$$\begin{aligned} \alpha_{max}^{a3} &:= \alpha_3 + \alpha_4 + \alpha_5, \\ \alpha_{max}^{a5} &:= \alpha_1 + \alpha_3 + \alpha_4 + \alpha_5 + \alpha_6, \end{aligned} \tag{7.1}$$

see Table 1.1 and Remark 1.6. Note that indices of simple roots for  $\alpha_{max}^{a5}$  in (7.1) differ from the indices of simple roots that appears as summands in  $\alpha_{max}^{a5}$  defined in (3.1), see Remark 1.7.

The numbering of vertices of the Dynkin diagram  $E_6$  is shown in Fig. 13. Consider the following two elements in the Weyl group  $W(E_6)$ :

$$\begin{aligned} w_1 &= s_2 s_4 s_5 s_3 s_4 (s_6 s_5 s_2 (s_4 s_3 s_1 s_3 s_4) s_2 s_5 s_6) s_4 s_3 s_5 s_4 s_2, \\ w_2 &= s_6 (s_5 s_6) (s_4 s_5 s_6) (s_3 s_4 s_5 s_6) (s_1 s_3 s_4 s_5 s_6). \end{aligned}$$

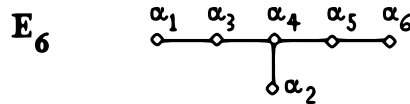

FIGURE 13. Numbering of simple roots in  $E_6$

**Proposition 7.1** (decomposition in  $W(E_6)$ ). (i) *The element  $w_1$  is the reflection associated with the highest root  $\alpha_{max}$ :*

$$w_1 = s_{\alpha_{max}}. \quad (7.2)$$

(ii) *The element  $w_2$  is the product of 3 reflections associated with positive roots  $\alpha_4$ ,  $\alpha_{max}^{a3}$ ,  $\alpha_{max}^{a5}$ :*

$$w_2 = s_{\alpha_4} s_{\alpha_{max}^{a3}} s_{\alpha_{max}^{a5}}. \quad (7.3)$$

(iii) *The element  $w_0 = w_1 w_2$  is the product of 4 reflections associated with mutually orthogonal roots*

$$\alpha_4, \quad \alpha_{max}^{a3}, \quad \alpha_{max}^{a5}, \quad \alpha_{max}. \quad (7.4)$$

The roots (7.4) are ordered as follows:

$$\alpha_4 < \alpha_{max}^{a3} < \alpha_{max}^{a5} < \alpha_{max}^{e6}.$$

(iv) *The element  $w_0$  is the longest element in  $W(E_6)$ .*

*Proof.* (i) We consequentially apply Proposition B.2 from §B:

$$\begin{aligned} s_3 s_1 s_3 &= s_{\alpha_1 + \alpha_3}, \\ s_4 s_3 s_1 s_3 s_4 &= s_4 s_{\alpha_1 + \alpha_3} s_4 = s_{\alpha_1 + \alpha_3 + \alpha_4}, \\ s_2 s_4 s_3 s_1 s_3 s_4 s_2 &= s_2 s_{\alpha_1 + \alpha_3 + \alpha_4} s_2 = s_{\alpha_1 + \alpha_3 + \alpha_4 + \alpha_2}, \\ s_5 s_2 s_4 s_3 s_1 s_3 s_4 s_2 s_5 &= s_5 s_{\alpha_1 + \alpha_3 + \alpha_4 + \alpha_2} s_5 = s_{\alpha_1 + \alpha_3 + \alpha_4 + \alpha_2 + \alpha_5}, \\ s_6 s_5 s_2 s_4 s_3 s_1 s_3 s_4 s_2 s_5 s_6 &= s_{\alpha_1 + \alpha_3 + \alpha_4 + \alpha_2 + \alpha_5 + \alpha_6}, \\ s_4 s_6 s_5 s_2 s_4 s_3 s_1 s_3 s_4 s_2 s_5 s_6 s_4 &= s_{\alpha_1 + \alpha_3 + 2\alpha_4 + \alpha_2 + \alpha_5 + \alpha_6}, \\ s_3 s_4 s_6 s_5 s_2 s_4 s_3 s_1 s_3 s_4 s_2 s_5 s_6 s_4 s_3 &= s_{\alpha_1 + 2\alpha_3 + 2\alpha_4 + \alpha_2 + \alpha_5 + \alpha_6}, \\ s_5 s_3 s_4 s_6 s_5 s_2 s_4 s_3 s_1 s_3 s_4 s_2 s_5 s_6 s_4 s_3 s_5 &= s_{\alpha_1 + 2\alpha_3 + 2\alpha_4 + \alpha_2 + 2\alpha_5 + \alpha_6}, \\ s_4 s_5 s_3 s_4 s_6 s_5 s_2 s_4 s_3 s_1 s_3 s_4 s_2 s_5 s_6 s_4 s_3 s_5 s_4 &= s_{\alpha_1 + 2\alpha_3 + 3\alpha_4 + \alpha_2 + 2\alpha_5 + \alpha_6}, \\ s_2 s_4 s_5 s_3 s_4 s_6 s_5 s_2 s_4 s_3 s_1 s_3 s_4 s_2 s_5 s_6 s_4 s_3 s_5 s_4 s_2 &= s_{\alpha_1 + 2\alpha_3 + 3\alpha_4 + 2\alpha_2 + 2\alpha_5 + \alpha_6}. \end{aligned}$$

The last reflection corresponds to  $\alpha_{max}$ .

(ii) Applying Proposition 3.1(ii) and eq.(3.6) from Proposition 3.3 to the sequence of reflections  $\{s_1, s_3, s_4, s_5, s_6\}$ , we get

$$w_2 = s_{\alpha_4} s_{\alpha_{max}^{a3}} s_{\alpha_{max}^{a5}}.$$

(iii) Since  $\alpha_{max}$  is orthogonal to all simple roots  $\alpha_i$  except  $\alpha_2$ , then  $\alpha_{max}$  is orthogonal to  $\alpha_4$ ,  $\alpha_{max}^{a3}$ , and  $\alpha_{max}^{a5}$ , see (7.1). The orthogonality relations for roots  $\alpha_4$ ,  $\alpha_{max}^{a3}$  and  $\alpha_{max}^{a5}$  are verified directly.

(iv) It suffices to prove that  $w_0$  acts on simple roots in the same way as the longest element. The reflection  $s_{\alpha_{max}}$  acts only on the simple root  $\alpha_2$ , the reflection  $\alpha_{max}^{a5}$  acts only on simple roots  $\alpha_1$ ,  $\alpha_2$ ,  $\alpha_6$ .

$$\begin{aligned} s_{\alpha_{max}^{a5}} s_{\alpha_{max}^{a3}} s_{\alpha_4}(\alpha_1) &= s_{\alpha_{max}^{a5}}(\alpha_1 + \alpha_3 + \alpha_4 + \alpha_5) = -\alpha_6, \\ s_{\alpha_{max}^{a5}} s_{\alpha_{max}^{a3}} s_{\alpha_4}(\alpha_3) &= s_{\alpha_{max}^{a5}} s_{\alpha_{max}^{a3}}(\alpha_3 + \alpha_4) = s_{\alpha_{max}^{a5}}(-\alpha_5) = -\alpha_5, \\ s_{\alpha_{max}^{a5}} s_{\alpha_3 + \alpha_4 + \alpha_5} s_{\alpha_4}(\alpha_4) &= s_{\alpha_{max}^{a5}}(-\alpha_4) = -\alpha_4, \end{aligned}$$

By (iii)  $w_0$  is an involution, so we do not have to check the action of  $w_0$  on  $\alpha_5$  and  $\alpha_6$ . It remains only to check the action of  $w_0$  on  $\alpha_2$ :

$$s_{\alpha_{max}^{a3}} s_4(\alpha_2) = s_{\alpha_{max}^{a3}}(\alpha_2 + \alpha_4) = \alpha_2 + \alpha_3 + 2\alpha_4 + \alpha_5$$

It is easy to check that  $(\alpha_{max}^{a5}, \alpha_2 + \alpha_3 + 2\alpha_4 + \alpha_5) = -1$ , then

$$s_{\alpha_{max}^{a5}}(\alpha_2 + \alpha_3 + 2\alpha_4 + \alpha_5) = \alpha_{max}^{a5} + \alpha_2 + \alpha_3 + 2\alpha_4 + \alpha_5 = \alpha_{max} - \alpha_2.$$

Further, since  $(\alpha_{max}, \alpha_2) = 1$ , we get

$$\begin{aligned} s_{\alpha_{max}}(\alpha_{max} - \alpha_2) &= -\alpha_{max} - s_{\alpha_{max}}(\alpha_2) = \\ &= -\alpha_{max} - (\alpha_2 - (\alpha_{max}, \alpha_2)\alpha_{max}) = -\alpha_2. \end{aligned}$$

Thus,  $w_0$  maps

$$\alpha_1, \alpha_2, \alpha_3, \alpha_4, \alpha_5, \alpha_6 \quad \text{to} \quad -\alpha_6, -\alpha_2, -\alpha_5, -\alpha_4, -\alpha_3, -\alpha_1,$$

see [4, Plate V]. Since the longest element is unique in  $W(E_6)$ ,  $w_0$  is the longest.  $\square$

## 8. Decomposition in $W(E_7)$

Let us denote the highest roots in the root subsystems  $D_4 \subset D_6 \subset E_7$  as follows:

$$\begin{aligned} \alpha_{max}^{d4} &:= \alpha_2 + \alpha_3 + 2\alpha_4 + \alpha_5, \\ \alpha_{max}^{d6} &:= \alpha_2 + \alpha_3 + 2\alpha_4 + 2\alpha_5 + 2\alpha_6 + \alpha_7, \end{aligned} \tag{8.1}$$

see Table 1.1 and Remark 1.6. In (8.1), the indices of simple roots differ from the indices of simple roots that appears as summands in  $\alpha_{max}^{d4}$  and  $\alpha_{max}^{d6}$  defined in (6.1), see Remark 1.7. The numbering of vertices of the Dynkin diagram  $E_7$  is shown in Fig. 14. We construct the longest element  $w_0$  as the product of two following elements in the Weyl group  $W(E_7)$ :

$$\begin{aligned} w_1 &= s_7(s_6 s_7)(s_5 s_6 s_7)(s_4 s_5 s_6 s_7)(s_3 s_4 s_5 s_6 s_7)(s_2 s_4 s_5 s_6 s_7)(s_3 s_4 s_5 s_6) \times \\ &\quad (s_2 s_4 s_5 s_3 s_4 s_2), \\ w_2 &= s_1 s_3 s_4 (s_5 s_2 s_4 s_6 (s_5 s_7 s_6 s_3 (s_4 s_5 s_2 (s_4 s_3 s_1 s_3 s_4) s_2 s_5 s_4) s_3 s_6 s_7 s_5) \times \\ &\quad s_6 s_4 s_2 s_5) s_4 s_3 s_1. \end{aligned} \tag{8.2}$$

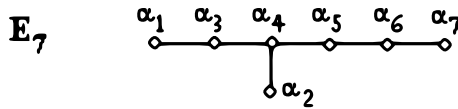

FIGURE 14. Numbering of simple roots in  $E_7$

**Proposition 8.1.** (i) *The element  $w_1$  is the product of 6 reflections associated with the following mutually orthogonal roots:*

$$\alpha_4, \alpha_7, \alpha_{max}^{d6}, \alpha_3 + \alpha_4 + \alpha_5, \alpha_2 + \alpha_4 + \alpha_5, \alpha_2 + \alpha_4 + \alpha_3, \tag{8.3}$$

(ii) *The element  $w_2$  is the reflection associated with the highest root:*

$$w_2 = s_{\alpha_{max}}.$$

*Proof.* (i) Let us denote by  $w_1^{(1)}$ ,  $w_1^{(2)}$ ,  $w_1^{(3)}$ ,  $w_1^{(4)}$  parts of the element  $w_1$ :

$$\begin{aligned} w_1^{(1)} &:= s_7(s_6s_7)(s_5s_6s_7)(s_4s_5s_6s_7)(s_3s_4s_5s_6s_7), \\ w_1^{(2)} &:= s_2s_4s_5s_6s_7, \\ w_1^{(3)} &:= s_3s_4s_5s_6, \\ w_1^{(4)} &:= s_2s_4s_5s_3s_4s_2, \end{aligned}$$

Then,

$$w_1 = w_1^{(1)}w_1^{(2)}w_1^{(3)}w_1^{(4)}.$$

Using Proposition 3.1, eq. (3.3) and Proposition 3.6, eq. (3.6), we get

$$\begin{aligned} w_1^{(1)} &= s_7(s_6s_7)(s_5s_6s_7)(s_4s_5s_6s_7)(s_3s_4s_5s_6s_7) = \\ &= s_{\alpha_5}s_{\alpha_4+\alpha_5+\alpha_6}s_{\alpha_3+\alpha_4+\alpha_5+\alpha_6+\alpha_7}. \end{aligned}$$

Then, repeatedly applying Proposition B.2, we obtain

$$\begin{aligned} w_1^{(1)}w_1^{(2)} &= s_{\alpha_5}s_{\alpha_4+\alpha_5+\alpha_6}s_{\alpha_3+\alpha_4+\alpha_5+\alpha_6+\alpha_7}(s_2s_4s_5s_6s_7) = \\ &= s_{\alpha_5}s_{\alpha_4+\alpha_5+\alpha_6}(s_2s_4s_5s_6s_7)s_{\alpha_2+\alpha_3+2\alpha_4+2\alpha_5+2\alpha_6+\alpha_7} = \\ &= s_{\alpha_5}s_{\alpha_4}s_{\alpha_5}(s_6s_5s_4s_2s_4s_5s_6)s_7s_{\alpha_2+\alpha_3+2\alpha_4+2\alpha_5+2\alpha_6+\alpha_7} = \\ &= s_{\alpha_4+\alpha_5}s_{\alpha_2+\alpha_4+\alpha_5+\alpha_6}s_{\alpha_7}s_{\alpha_2+\alpha_3+2\alpha_4+2\alpha_5+2\alpha_6+\alpha_7} = \\ &= s_{\alpha_7}s_{\alpha_4+\alpha_5}s_{\alpha_2+\alpha_4+\alpha_5+\alpha_6+\alpha_7}s_{\alpha_2+\alpha_3+2\alpha_4+2\alpha_5+2\alpha_6+\alpha_7}. \end{aligned}$$

Further, by (8.1)

$$\begin{aligned} w_1^{(1)}w_1^{(2)}w_1^{(3)} &= \\ &= s_{\alpha_7}s_{\alpha_4+\alpha_5}s_{\alpha_2+\alpha_4+\alpha_5+\alpha_6+\alpha_7}s_{\alpha_2+\alpha_3+2\alpha_4+2\alpha_5+2\alpha_6+\alpha_7}(s_3s_4s_5s_6) = \\ &= s_{\alpha_7}s_{\alpha_4+\alpha_5}s_{\alpha_2+\alpha_4+\alpha_5+\alpha_6+\alpha_7}s_{\alpha_{max}^{d6}}(s_3s_4s_5s_6). \end{aligned}$$

All simple roots of  $E_7$ , except  $\alpha_1$  and  $\alpha_6$ , are orthogonal to  $\alpha_{max}^{d6}$ . Since

$$\begin{aligned} s_{\alpha_{max}^{d6}}s_6 &= s_6s_{\alpha_{max}^{d6}-\alpha_6}, \\ s_6(s_{\alpha_{max}^{d6}-\alpha_6})s_6 &= s_{\alpha_{max}^{d6}}, \end{aligned}$$

we get,

$$\begin{aligned} w_1^{(1)}w_1^{(2)}w_1^{(3)} &= \\ &= s_{\alpha_7}s_{\alpha_4+\alpha_5}s_{\alpha_2+\alpha_4+\alpha_5+\alpha_6+\alpha_7}(s_3s_4s_5)s_{\alpha_{max}^{d6}}s_6 = \\ &= s_{\alpha_7}s_{\alpha_4+\alpha_5}s_{\alpha_2+\alpha_4+\alpha_5+\alpha_6+\alpha_7}(s_3s_4s_5s_6)s_{\alpha_{max}^{d6}-\alpha_6} = \\ &= s_{\alpha_7}s_{\alpha_4+\alpha_5}(s_3s_4s_5)s_{\alpha_2+\alpha_3+2\alpha_4+2\alpha_5+\alpha_6+\alpha_7}s_6s_{\alpha_{max}^{d6}-\alpha_6} = \\ &= s_{\alpha_7}s_{\alpha_4+\alpha_5}(s_3s_4s_5)(s_{\alpha_{max}^{d6}-\alpha_6}(s_6)s_{\alpha_{max}^{d6}-\alpha_6}) = \\ &= s_{\alpha_7}s_{\alpha_4+\alpha_5}(s_3s_4s_5)s_{\alpha_{max}^{d6}}. \end{aligned}$$

By Lemma 2.3, we get

$$w_1^{(1)}w_1^{(2)}w_1^{(3)} = s_{\alpha_7}s_{\alpha_4}s_{\alpha_3+\alpha_4+\alpha_5}s_{\alpha_{max}^{d6}} \quad (8.4)$$

It is easy to see the following decomposition:

$$\begin{aligned} w_1^{(4)} &= s_2s_4s_5s_3s_4s_2 = (s_2s_4s_5s_4s_2)(s_2s_4s_3s_4s_2) = \\ &= s_{\alpha_2+\alpha_4+\alpha_5}s_{\alpha_2+\alpha_4+\alpha_3}. \end{aligned} \quad (8.5)$$



Since  $\alpha_{max}^{d6} \perp \alpha_2, \alpha_3, \alpha_4, \alpha_5$ , the reflection  $s_{\alpha_{max}^{d6}}$  commute with  $w_1^{(4)}$ . Putting together (8.4) and (8.5), we get

$$w_1 = w_1^{(1)} w_1^{(2)} w_1^{(3)} w_1^{(4)} = s_{\alpha_7} s_{\alpha_4} s_{\alpha_3 + \alpha_4 + \alpha_5} s_{\alpha_2 + \alpha_4 + \alpha_5} s_{\alpha_2 + \alpha_4 + \alpha_3} s_{\alpha_{max}^{d6}}.$$

This decomposition corresponds to the roots (8.3). Their mutual orthogonality is easily verified.

(ii) We consequentially apply Proposition B.2 to the element  $w_2$ :

$$\begin{aligned} w_2 = & \\ & s_1 s_3 s_4 s_5 s_2 s_4 s_6 (s_5 s_7 s_6 s_3 (s_4 s_5 s_2 (s_4 s_3 s_1 s_3 s_4) s_2 s_5 s_4) s_3 s_6 s_7 s_5) s_6 s_4 s_2 s_5 s_4 s_3 s_1 = \\ & s_1 s_3 s_4 s_5 s_2 s_4 s_6 (s_5 s_7 s_6 s_3 (s_4 s_5 s_2 (s_{\alpha_1 + \alpha_3 + \alpha_4}) s_2 s_5 s_4) s_3 s_6 s_7 s_5) s_6 s_4 s_2 s_5 s_4 s_3 s_1 = \\ & s_1 s_3 s_4 s_5 s_2 s_4 s_6 (s_5 s_7 s_6 s_3 (s_{\alpha_1 + \alpha_2 + \alpha_3 + 2\alpha_4 + \alpha_5}) s_3 s_6 s_7 s_5) s_6 s_4 s_2 s_5 s_4 s_3 s_1 = \\ & s_1 s_3 s_4 s_5 s_2 s_4 s_6 (s_5 s_7 (s_{\alpha_1 + \alpha_2 + 2\alpha_3 + 2\alpha_4 + \alpha_5 + \alpha_6}) s_7 s_5) s_6 s_4 s_2 s_5 s_4 s_3 s_1 = \\ & s_1 s_3 s_4 (s_5 s_2 s_4 s_6 (s_{\alpha_1 + \alpha_2 + 2\alpha_3 + 2\alpha_4 + 2\alpha_5 + \alpha_6 + \alpha_7}) s_6 s_4 s_2 s_5) s_4 s_3 s_1 = \\ & s_1 s_3 s_4 (s_5 s_2 (s_{\alpha_1 + \alpha_2 + 2\alpha_3 + 3\alpha_4 + 2\alpha_5 + 2\alpha_6 + \alpha_7}) s_2 s_5) s_4 s_3 s_1 = \\ & s_1 s_3 s_4 (s_{\alpha_1 + 2\alpha_2 + 2\alpha_3 + 3\alpha_4 + 3\alpha_5 + 2\alpha_6 + \alpha_7}) s_4 s_3 s_1 = \\ & s_1 (s_{\alpha_1 + 2\alpha_2 + 3\alpha_3 + 4\alpha_4 + 3\alpha_5 + 2\alpha_6 + \alpha_7}) s_1 = \\ & s_{2\alpha_1 + 2\alpha_2 + 3\alpha_3 + 4\alpha_4 + 3\alpha_5 + 2\alpha_6 + \alpha_7}. \end{aligned} \tag{8.6}$$

In (8.6), the last reflection corresponds to the highest root  $\alpha_{max}$  of  $E_7$ , see Table A.4.  $\square$

**Proposition 8.2.** (i) *The element  $w_0 = w_1 w_2$  is the product of 7 reflections associated with the following mutually orthogonal positive roots:*

$$\alpha_4, \alpha_7, \alpha_{max}^{d6}, \alpha_{max}, \alpha_3 + \alpha_4 + \alpha_5, \alpha_2 + \alpha_4 + \alpha_5, \alpha_2 + \alpha_4 + \alpha_3. \tag{8.7}$$

(ii) *The element  $w_0$  is the longest element in  $W(E_7)$ .*

*Proof.* (i) The highest root  $\alpha_{max}$  is orthogonal to all simple roots except  $\alpha_1$ , i.e.,  $\alpha_{max}$  is orthogonal to all other roots of (8.7). Taking Proposition 8.1(i) into account, we obtain that all roots in (8.7) are mutually orthogonal.

(ii) We put

$$\alpha_{345} := \alpha_3 + \alpha_4 + \alpha_5, \alpha_{245} := \alpha_2 + \alpha_4 + \alpha_5, \alpha_{234} := \alpha_2 + \alpha_3 + \alpha_4.$$

Consider the determinant constructed by roots of (8.7), see (8.8a). We transform the rows of the determinant as follows:

$$\begin{aligned} \alpha_{345} &\rightarrow \alpha_{345} - \alpha_{245} + \alpha_{234} - \alpha_4 &= (0, 0, 2, 0, 0, 0, 0), \\ \alpha_{245} &\rightarrow \alpha_{245} - \alpha_{234} + \alpha_{345} - \alpha_4 &= (0, 0, 0, 0, 2, 0, 0), \\ \alpha_{234} &\rightarrow \alpha_{245} - \alpha_{345} + \alpha_{234} - \alpha_4 &= (0, 2, 0, 0, 0, 0, 0), \\ \alpha_{max}^{d6} &\rightarrow \alpha_{max}^{d6} - \alpha_{245} - \alpha_{345} - \alpha_7 &= (0, 0, 0, 0, 0, 0, 2), \\ \alpha_{max} &\rightarrow \alpha_{max} - \alpha_{max}^{d6} - \alpha_{345} - \alpha_{234} &= (2, 0, 0, 0, 0, 0, 0). \end{aligned}$$

The obtained determinant (8.8b) is non-degenerate.

$$\left\| \begin{array}{cccccc} 0 & 0 & 1 & 1 & 1 & 0 & 0 \\ 0 & 1 & 0 & 1 & 1 & 0 & 0 \\ 0 & 1 & 1 & 1 & 0 & 0 & 0 \\ 0 & 0 & 0 & 1 & 0 & 0 & 0 \\ 0 & 1 & 1 & 2 & 2 & 2 & 1 \\ 0 & 0 & 0 & 0 & 0 & 0 & 1 \\ 2 & 2 & 3 & 4 & 3 & 2 & 1 \end{array} \right\| \begin{array}{l} \alpha_{345} \\ \alpha_{245} \\ \alpha_{234} \\ \alpha_4 \\ \alpha_{max}^{d6} \\ \alpha_7 \\ \alpha_{max} \end{array} \implies \left\| \begin{array}{cccccc} 0 & 0 & 2 & 0 & 0 & 0 & 0 \\ 0 & 0 & 0 & 0 & 2 & 0 & 0 \\ 0 & 2 & 0 & 0 & 0 & 0 & 0 \\ 0 & 0 & 0 & 1 & 0 & 0 & 0 \\ 0 & 0 & 0 & 0 & 0 & 2 & 0 \\ 0 & 0 & 0 & 0 & 0 & 0 & 1 \\ 2 & 0 & 0 & 0 & 0 & 0 & 0 \end{array} \right\| \quad (8.8)$$

(a) (b)

Thus, the roots (8.7) are linearly independent and constitutes the basis of the whole space. Since the roots (8.7) are mutually orthogonal,  $w_0$  acts as  $-1$  on each of these roots. Hence  $w_0$  acts as  $-1$  on the whole space, i.e.,  $w_0$  acts in the same way as the longest element. Thus  $w_0$  is the longest in  $W(E_7)$ .  $\square$

The roots (8.7) are not satisfy to the max-orthogonality conditions, see §1.2.3, since  $\{\alpha_3 + \alpha_4 + \alpha_5, \alpha_2 + \alpha_4 + \alpha_5, \alpha_2 + \alpha_4 + \alpha_3\}$  are not linearly ordered. The following proposition provides another decomposition of  $w_0$ , which solves this issue.

**Proposition 8.3** (decomposition in  $W(E_7)$ ). *The element  $w_0$  can be decomposed as the product of the following 7 reflections associated with the mutually orthogonal roots:*

$$\alpha_2, \alpha_3, \alpha_5, \alpha_7, \alpha_{max}^{d4}, \alpha_{max}^{d6}, \alpha_{max}. \quad (8.9)$$

The highest roots in (8.9) are ordered as follows:

$$\alpha_{max}^{d4} < \alpha_{max}^{d6} < \alpha_{max}.$$

*Proof.* We apply conjugation  $s_{\alpha_3 + \alpha_4}$  to the reflections associated with roots (8.7). First, this conjugation does not change  $s_7$ ,  $s_{\alpha_{max}^{d6}}$  and  $s_{\alpha_{max}}$  since  $\{\alpha_7, \alpha_{max}^{d6}, \alpha_{max}\} \perp \{\alpha_3, \alpha_4\}$ . For the remaining roots, we have as follows:

$$\begin{aligned} s_{\alpha_3 + \alpha_4} s_{\alpha_4} s_{\alpha_3 + \alpha_4} &= s_{\alpha_3}, \\ s_{\alpha_3 + \alpha_4} s_{\alpha_3 + \alpha_4 + \alpha_5} s_{\alpha_3 + \alpha_4} &= s_{\alpha_5}, \\ s_{\alpha_3 + \alpha_4} s_{\alpha_2 + \alpha_4 + \alpha_5} s_{\alpha_3 + \alpha_4} &= s_{\alpha_2 + \alpha_3 + 2\alpha_4 + \alpha_5} = s_{\alpha_{max}^{d4}}, \\ s_{\alpha_3 + \alpha_4} s_{\alpha_2 + \alpha_4 + \alpha_3} s_{\alpha_3 + \alpha_4} &= s_{\alpha_2}. \end{aligned}$$

$\square$

## 9. Decomposition in $W(E_8)$

We denote the highest roots in the root subsystems  $D_4 \subset D_6 \subset E_7 \subset E_8$  as follows:

$$\begin{aligned} \alpha_{max}^{d4} &:= \alpha_2 + \alpha_3 + 2\alpha_4 + \alpha_5, \\ \alpha_{max}^{d6} &:= \alpha_2 + \alpha_3 + 2\alpha_4 + 2\alpha_5 + 2\alpha_6 + \alpha_7, \\ \alpha_{max}^{e7} &:= 2\alpha_1 + 2\alpha_2 + 3\alpha_3 + 4\alpha_4 + 3\alpha_5 + 2\alpha_6 + \alpha_7, \end{aligned} \quad (9.1)$$

see Table 1.1 and Remark 1.6. In (9.1), the indices of simple roots differ from the indices of simple roots that appears as summands in  $\alpha_{max}^{d4}$  and

$\alpha_{max}^{d6}$  defined in (6.1), see Remark 1.7 and note after (8.1). The numbering of vertices of the Dynkin diagram  $E_8$  is shown in Fig. 15.

**9.1. Reducing  $w_0$  from 120 factors to 14.** Let us consider the following 4 elements in the Weyl group  $W(E_8)$ :

$$\begin{aligned}
 w_1 &= s_8(s_7s_8)(s_6s_7s_8)(s_5s_6s_7s_8)(s_4s_5s_6s_7s_8)(s_3s_4s_5s_6s_7s_8), \\
 w_2 &= s_2s_4s_5s_6(s_3s_4s_5(s_7s_6s_2s_4(s_3s_5s_4s_2(s_8s_7s_6s_5(s_4s_3s_1s_3s_4) \times \\
 &\quad s_5s_6s_7s_8)s_2s_4s_5s_3)s_4s_2s_6s_7)s_5s_4s_3)s_6s_5s_4s_2, \\
 w_3 &= s_1s_3(s_4s_2s_5s_4)(s_3s_6s_5s_4)(s_7s_6s_8s_7)(s_5s_6)(s_2s_4s_5)(s_3s_4)s_2, \\
 w_4 &= s_1(s_3s_4s_5s_6(s_2s_4s_5s_3(s_4s_7s_6s_5(s_2s_4s_3s_8s_1s_3s_4s_2)s_5s_6s_7s_4) \times \\
 &\quad s_3s_5s_4s_2)s_6s_5s_4s_3)s_1.
 \end{aligned} \tag{9.2}$$

Denote by  $w_0$  the product of elements (9.2):

$$w_0 = w_1w_2w_3w_4 \tag{9.3}$$

We will prove that  $w_0$  is the longest element in  $W(E_8)$ . But first we have to transform them so that they have as few factors as possible.

**Proposition 9.1.** *Elements  $w_1, w_2, w_3, w_4$  are transformed as follows:*

$$\begin{aligned}
 w_1 &= s_{\alpha_5+\alpha_6}s_{\alpha_4+\alpha_5+\alpha_6+\alpha_7}s_{\alpha_3+\alpha_4+\alpha_5+\alpha_6+\alpha_7+\alpha_8}, \\
 w_2 &= s_{\alpha_1+3\alpha_2+3\alpha_3+5\alpha_4+4\alpha_5+3\alpha_6+2\alpha_7+\alpha_8}, \\
 w_3 &= s_1s_{\alpha_2+\alpha_4}s_{\alpha_3+\alpha_4+\alpha_5}s_{\alpha_2+\alpha_3+2\alpha_4+\alpha_5+\alpha_6} \\
 &\quad s_{\alpha_2+\alpha_3+\alpha_4+\alpha_5+\alpha_6+\alpha_7}s_{\alpha_7+\alpha_8}s_6s_{\alpha_2+\alpha_4+\alpha_5}, \\
 w_4 &= s_{\alpha_1+\alpha_3+\alpha_4+\alpha_5+\alpha_6+\alpha_7+\alpha_8}s_{2\alpha_1+2\alpha_2+3\alpha_3+4\alpha_4+3\alpha_5+2\alpha_6+\alpha_7}.
 \end{aligned} \tag{9.4}$$

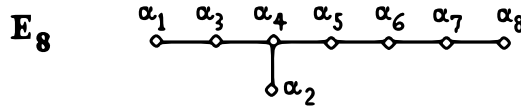

FIGURE 15. Numbering of simple roots in  $E_8$

Element  $w_1$ . We use Propositions 3.1 and 3.3 with one small change: we take  $w_0$  for  $A_6$  and increment all indices by 2. Let us denote this operation by  $(\dots)_{i \rightarrow i+2}$ .

$$\begin{aligned}
 w_1 &= s_8(s_7s_8)(s_6s_7s_8)(s_5s_6s_7s_8)(s_4s_5s_6s_7s_8)(s_3s_4s_5s_6s_7s_8) = \\
 &\quad (s_6(s_5s_6)(s_4s_5s_6)(s_3s_4s_5s_6)(s_2s_3s_4s_5s_6)(s_1s_2s_3s_4s_5s_6))_{i \rightarrow i+2} = \\
 &\quad (s_{\alpha_3+\alpha_4}s_{\alpha_2+\alpha_3+\alpha_4+\alpha_5}s_{\alpha_1+\alpha_2+\alpha_3+\alpha_4+\alpha_5+\alpha_6})_{i \rightarrow i+2} = \\
 &\quad s_{\alpha_5+\alpha_6}s_{\alpha_4+\alpha_5+\alpha_6+\alpha_7}s_{\alpha_3+\alpha_4+\alpha_5+\alpha_6+\alpha_7+\alpha_8}.
 \end{aligned}$$

The element  $w_1$  is decomposed into 3 factors.

Element  $w_2$ . As in Proposition 7.1, we repeatedly apply Proposition B.2. For the beginning, let us transform 5 factors in parentheses lying in the

center of the element  $w_2$ :

$$\begin{aligned}
& s_3 s_5 s_4 s_2 (s_8 s_7 s_6 s_5 (s_4 s_3 s_1 s_3 s_4) s_5 s_6 s_7 s_8) s_2 s_4 s_5 s_3 = \\
& s_3 s_5 s_4 s_2 (s_8 s_7 s_6 s_5 (s_{\alpha_1 + \alpha_3 + \alpha_4}) s_5 s_6 s_7 s_8) s_2 s_4 s_5 s_3 = \\
& s_3 s_5 s_4 s_2 (s_{\alpha_1 + \alpha_3 + \alpha_4 + \alpha_5 + \alpha_6 + \alpha_7 + \alpha_8}) s_2 s_4 s_5 s_3 = \\
& s_{\alpha_1 + \alpha_2 + 2\alpha_3 + 2\alpha_4 + 2\alpha_5 + \alpha_6 + \alpha_7 + \alpha_8}.
\end{aligned} \tag{9.5}$$

By (9.5) we get

$$\begin{aligned}
w_2 &= s_2 s_4 s_5 s_6 (s_3 s_4 s_5 (s_7 s_6 s_2 s_4 (s_{\alpha_1 + \alpha_2 + 2\alpha_3 + 2\alpha_4 + 2\alpha_5 + \alpha_6 + \alpha_7 + \alpha_8}) \times \\
& s_4 s_2 s_6 s_7) s_5 s_4 s_3) s_6 s_5 s_4 s_2 = \\
& s_2 s_4 s_5 s_6 (s_3 s_4 s_5 (s_{\alpha_1 + 2\alpha_2 + 2\alpha_3 + 3\alpha_4 + 2\alpha_5 + 2\alpha_6 + 2\alpha_7 + \alpha_8}) s_5 s_4 s_3) s_6 s_5 s_4 s_2 = \\
& s_2 s_4 s_5 s_6 (s_{\alpha_1 + 2\alpha_2 + 3\alpha_3 + 4\alpha_4 + 3\alpha_5 + 2\alpha_6 + 2\alpha_7 + \alpha_8}) s_6 s_5 s_4 s_2 = \\
& s_2 (s_{\alpha_1 + 2\alpha_2 + 3\alpha_3 + 5\alpha_4 + 4\alpha_5 + 3\alpha_6 + 2\alpha_7 + \alpha_8}) s_2 = \\
& s_{\alpha_1 + 3\alpha_2 + 3\alpha_3 + 5\alpha_4 + 4\alpha_5 + 3\alpha_6 + 2\alpha_7 + \alpha_8}.
\end{aligned}$$

The element  $w_2$  has only 1 factor.

Element  $w_3$ . The following identities hold:

$$\begin{aligned}
s_4 s_2 s_5 s_4 &= (s_4 s_2 s_4) (s_4 s_5 s_4) = s_{\alpha_2 + \alpha_4} s_{\alpha_5 + \alpha_4}, \\
s_7 s_6 s_8 s_7 &= (s_7 s_6 s_7) (s_7 s_8 s_7) = s_{\alpha_6 + \alpha_7} s_{\alpha_7 + \alpha_8}, \\
s_2 s_4 s_5 s_3 s_4 s_2 &= (s_2 s_4 s_5 s_4 s_2) (s_2 s_4 s_3 s_4 s_2) = s_{\alpha_2 + \alpha_4 + \alpha_5} s_{\alpha_2 + \alpha_4 + \alpha_3}
\end{aligned} \tag{9.6}$$

By (9.6) we have

$$\begin{aligned}
& (s_4 s_2 s_5 s_4) (s_3 s_6 s_5 s_4) = s_{\alpha_2 + \alpha_4} s_{\alpha_5 + \alpha_4} (s_3 s_6 s_5 s_4) = \\
& s_{\alpha_2 + \alpha_4} s_5 s_4 s_5 s_3 s_6 s_5 s_4 = s_{\alpha_2 + \alpha_4} s_5 s_4 s_3 s_5 s_6 s_5 s_4 = \\
& s_{\alpha_2 + \alpha_4} s_5 s_4 s_3 s_4 (s_4 s_5 s_6 s_5 s_4) = \\
& s_{\alpha_2 + \alpha_4} s_5 s_{\alpha_3 + \alpha_4} (s_{\alpha_4 + \alpha_5 + \alpha_6}).
\end{aligned}$$

Then,

$$\begin{aligned}
w_3 &= s_1 s_3 (s_4 s_2 s_5 s_4) (s_3 s_6 s_5 s_4) (s_7 s_6 s_8 s_7) (s_5 s_6) (s_2 s_4 s_5) (s_3 s_4) s_2 = \\
& s_1 s_3 s_{\alpha_2 + \alpha_4} s_5 s_{\alpha_3 + \alpha_4} s_{\alpha_4 + \alpha_5 + \alpha_6} s_{\alpha_6 + \alpha_7} s_{\alpha_7 + \alpha_8} s_5 s_6 s_{\alpha_2 + \alpha_4 + \alpha_5} s_{\alpha_2 + \alpha_4 + \alpha_3} = \\
& s_1 s_3 s_{\alpha_2 + \alpha_4} (s_5 s_{\alpha_3 + \alpha_4} s_{\alpha_4 + \alpha_5 + \alpha_6} s_{\alpha_6 + \alpha_7} s_5) s_{\alpha_7 + \alpha_8} s_6 s_{\alpha_2 + \alpha_4 + \alpha_5} s_{\alpha_2 + \alpha_4 + \alpha_3}.
\end{aligned}$$

Applying conjugation with  $s_5$  to the parenthesized expression in (9.6) we reduce the number of factors by 2:

$$\begin{aligned}
w_3 &= s_1 s_3 s_{\alpha_2 + \alpha_4} s_{\alpha_3 + \alpha_4 + \alpha_5} s_{\alpha_4 + \alpha_5 + \alpha_6} s_{\alpha_5 + \alpha_6 + \alpha_7} s_{\alpha_7 + \alpha_8} \times \\
& s_6 s_{\alpha_2 + \alpha_4 + \alpha_5} s_{\alpha_2 + \alpha_3 + \alpha_4}.
\end{aligned}$$

Since  $s_3 s_{\alpha_2 + \alpha_4} = s_{\alpha_2 + \alpha_4} s_{\alpha_2 + \alpha_3 + \alpha_4}$  and  $s_6$  commute with  $s_{\alpha_2 + \alpha_3 + \alpha_4}$  we get the following:

$$\begin{aligned}
w_3 &= s_1 s_{\alpha_2 + \alpha_4} s_{\alpha_2 + \alpha_3 + \alpha_4} s_{\alpha_3 + \alpha_4 + \alpha_5} s_{\alpha_4 + \alpha_5 + \alpha_6} s_{\alpha_5 + \alpha_6 + \alpha_7} s_{\alpha_7 + \alpha_8} \times \\
& s_{\alpha_2 + \alpha_3 + \alpha_4} s_6 s_{\alpha_2 + \alpha_4 + \alpha_5}.
\end{aligned}$$

Further, we can swap  $s_{\alpha_2 + \alpha_3 + \alpha_4}$  and  $s_{\alpha_3 + \alpha_4 + \alpha_5}$  since the roots  $\alpha_2 + \alpha_3 + \alpha_4$  and  $\alpha_3 + \alpha_4 + \alpha_5$  are orthogonal. For reflections  $s_{\alpha_2 + \alpha_3 + \alpha_4}$  and  $s_{\alpha_4 + \alpha_5 + \alpha_6}$ , we have

$$s_{\alpha_2 + \alpha_3 + \alpha_4} s_{\alpha_4 + \alpha_5 + \alpha_6} = s_{\alpha_2 + \alpha_3 + 2\alpha_4 + \alpha_5 + \alpha_6} s_{\alpha_2 + \alpha_3 + \alpha_4}.$$

Then,

$$w_3 = s_1 s_{\alpha_2 + \alpha_4} s_{\alpha_3 + \alpha_4 + \alpha_5} s_{\alpha_2 + \alpha_3 + 2\alpha_4 + \alpha_5 + \alpha_6} \left( s_{\alpha_2 + \alpha_3 + \alpha_4} s_{\alpha_5 + \alpha_6 + \alpha_7} s_{\alpha_2 + \alpha_3 + \alpha_4} \right) s_{\alpha_7 + \alpha_8} s_6 s_{\alpha_2 + \alpha_4 + \alpha_5}. \quad (9.7)$$

Applying conjugation with  $s_{\alpha_2 + \alpha_3 + \alpha_4}$  to the expression in brackets in (9.7) we again reduce the number of factors by 2:

$$w_3 = s_1 s_{\alpha_2 + \alpha_4} s_{\alpha_3 + \alpha_4 + \alpha_5} s_{\alpha_2 + \alpha_3 + 2\alpha_4 + \alpha_5 + \alpha_6} s_{\alpha_2 + \alpha_3 + \alpha_4 + \alpha_5 + \alpha_6 + \alpha_7} s_{\alpha_7 + \alpha_8} s_6 s_{\alpha_2 + \alpha_4 + \alpha_5}.$$

The element  $w_3$  has 8 factors.

Element  $w_4$ . Let us transform 3 factors in parentheses lying in the middle of the element  $w_4$ :

$$\begin{aligned} s_4 s_7 s_6 s_5 (s_2 s_4 s_3 s_8 s_1 s_3 s_4 s_2) s_5 s_6 s_7 s_4 &= \\ s_4 s_7 s_6 s_5 (s_8 s_{\alpha_1 + \alpha_3 + \alpha_4 + \alpha_2}) s_5 s_6 s_7 s_4 &= \\ s_{\alpha_7 + \alpha_8} s_{\alpha_1 + \alpha_3 + 2\alpha_4 + \alpha_2 + \alpha_5 + \alpha_6 + \alpha_7}. \end{aligned}$$

Let us add one more factor on each side, see  $w_4$  in (9.2):

$$\begin{aligned} s_2 s_4 s_5 s_3 (s_{\alpha_7 + \alpha_8} s_{\alpha_1 + \alpha_2 + \alpha_3 + 2\alpha_4 + \alpha_5 + \alpha_6 + \alpha_7}) s_3 s_5 s_4 s_2 &= \\ s_{\alpha_7 + \alpha_8} s_{\alpha_1 + 2\alpha_2 + 2\alpha_3 + 3\alpha_4 + 2\alpha_5 + \alpha_6 + \alpha_7}. \end{aligned}$$

And add one more factor:

$$\begin{aligned} s_3 s_4 s_5 s_6 (s_{\alpha_7 + \alpha_8} s_{\alpha_1 + 2\alpha_2 + 2\alpha_3 + 3\alpha_4 + 2\alpha_5 + \alpha_6 + \alpha_7}) s_6 s_5 s_4 s_3 &= \\ s_{\alpha_3 + \alpha_4 + \alpha_5 + \alpha_6 + \alpha_7 + \alpha_8} s_{\alpha_1 + 2\alpha_2 + 3\alpha_3 + 4\alpha_4 + 3\alpha_5 + 2\alpha_6 + \alpha_7}. \end{aligned}$$

At last,

$$\begin{aligned} w_4 = s_1 s_{\alpha_3 + \alpha_4 + \alpha_5 + \alpha_6 + \alpha_7 + \alpha_8} s_{\alpha_1 + 2\alpha_2 + 3\alpha_3 + 4\alpha_4 + 3\alpha_5 + 2\alpha_6 + \alpha_7} s_1 &= \\ s_{\alpha_1 + \alpha_3 + \alpha_4 + \alpha_5 + \alpha_6 + \alpha_7 + \alpha_8} s_{2\alpha_1 + 2\alpha_2 + 3\alpha_3 + 4\alpha_4 + 3\alpha_5 + 2\alpha_6 + \alpha_7}. \end{aligned}$$

The element  $w_4$  is decomposed into 2 factors.  $\square$

Considering all the factors together, the element  $w_0$  has 14 factors.

**9.2. Reducing  $w_0$  from 14 factors to 12.** Consider the product of 14 factors from (9.4):

$$\begin{aligned} w_0 = s_{\alpha_5 + \alpha_6} s_{\alpha_4 + \alpha_5 + \alpha_6 + \alpha_7} s_{\alpha_3 + \alpha_4 + \alpha_5 + \alpha_6 + \alpha_7 + \alpha_8} \times \\ s_{\alpha_1 + 3\alpha_2 + 3\alpha_3 + 5\alpha_4 + 4\alpha_5 + 3\alpha_6 + 2\alpha_7 + \alpha_8} s_1 s_{\alpha_2 + \alpha_4} s_{\alpha_3 + \alpha_4 + \alpha_5} \times \\ s_{\alpha_2 + \alpha_3 + 2\alpha_4 + \alpha_5 + \alpha_6} s_{\alpha_2 + \alpha_3 + \alpha_4 + \alpha_5 + \alpha_6 + \alpha_7} s_{\alpha_7 + \alpha_8} s_6 s_{\alpha_2 + \alpha_4 + \alpha_5} \times \\ s_{\alpha_1 + \alpha_3 + \alpha_4 + \alpha_5 + \alpha_6 + \alpha_7 + \alpha_8} s_{2\alpha_1 + 2\alpha_2 + 3\alpha_3 + 4\alpha_4 + 3\alpha_5 + 2\alpha_6 + \alpha_7}. \end{aligned} \quad (9.8)$$

First, it can be checked that the following roots are orthogonal

$$\alpha_3 + \alpha_4 + \alpha_5 + \alpha_6 + \alpha_7 + \alpha_8 \perp \alpha_1 + 3\alpha_2 + 3\alpha_3 + 5\alpha_4 + 4\alpha_5 + 3\alpha_6 + 2\alpha_7 + \alpha_8,$$

i.e., the corresponding reflections in (9.8) can be swapped:

$$\begin{aligned} w_0 = s_{\alpha_5 + \alpha_6} s_{\alpha_4 + \alpha_5 + \alpha_6 + \alpha_7} s_{\alpha_1 + 3\alpha_2 + 3\alpha_3 + 5\alpha_4 + 4\alpha_5 + 3\alpha_6 + 2\alpha_7 + \alpha_8} \times \\ s_{\alpha_3 + \alpha_4 + \alpha_5 + \alpha_6 + \alpha_7 + \alpha_8} s_1 s_{\alpha_2 + \alpha_4} s_{\alpha_3 + \alpha_4 + \alpha_5} \times \\ s_{\alpha_2 + \alpha_3 + 2\alpha_4 + \alpha_5 + \alpha_6} s_{\alpha_2 + \alpha_3 + \alpha_4 + \alpha_5 + \alpha_6 + \alpha_7} s_{\alpha_7 + \alpha_8} s_6 s_{\alpha_2 + \alpha_4 + \alpha_5} \times \\ s_{\alpha_1 + \alpha_3 + \alpha_4 + \alpha_5 + \alpha_6 + \alpha_7 + \alpha_8} s_{2\alpha_1 + 2\alpha_2 + 3\alpha_3 + 4\alpha_4 + 3\alpha_5 + 2\alpha_6 + \alpha_7}. \end{aligned} \quad (9.9)$$

Using conjugation with  $s_1$ , by Proposition B.2 we have:

$$s_{\alpha_3+\alpha_4+\alpha_5+\alpha_6+\alpha_7+\alpha_8} s_1 = s_1 s_{\alpha_1+\alpha_3+\alpha_4+\alpha_5+\alpha_6+\alpha_7+\alpha_8}$$

Then, from (9.9) we have

$$\begin{aligned} w_0 = & s_{\alpha_5+\alpha_6} s_{\alpha_4+\alpha_5+\alpha_6+\alpha_7} s_{\alpha_1+3\alpha_2+3\alpha_3+5\alpha_4+4\alpha_5+3\alpha_6+2\alpha_7+\alpha_8} \times \\ & s_1 s_{\alpha_1+\alpha_3+\alpha_4+\alpha_5+\alpha_6+\alpha_7+\alpha_8} s_{\alpha_2+\alpha_4} s_{\alpha_3+\alpha_4+\alpha_5} \times \\ & s_{\alpha_2+\alpha_3+2\alpha_4+\alpha_5+\alpha_6} s_{\alpha_2+\alpha_3+\alpha_4+\alpha_5+\alpha_6+\alpha_7} s_{\alpha_7+\alpha_8} s_6 s_{\alpha_2+\alpha_4+\alpha_5} \times \\ & s_{\alpha_1+\alpha_3+\alpha_4+\alpha_5+\alpha_6+\alpha_7+\alpha_8} s_{2\alpha_1+2\alpha_2+3\alpha_3+4\alpha_4+3\alpha_5+2\alpha_6+\alpha_7}. \end{aligned}$$

Since  $(\alpha_2 + \alpha_4, \alpha_3 + \alpha_4 + \alpha_5) = -1$ , using conjugation with  $s_{\alpha_3+\alpha_4+\alpha_5}$  and by Proposition B.2, we obtain

$$s_{\alpha_2+\alpha_4} s_{\alpha_3+\alpha_4+\alpha_5} = s_{\alpha_3+\alpha_4+\alpha_5} s_{\alpha_2+\alpha_3+2\alpha_4+\alpha_5}$$

and we get the following:

$$\begin{aligned} w_0 = & s_{\alpha_5+\alpha_6} s_{\alpha_4+\alpha_5+\alpha_6+\alpha_7} s_{\alpha_1+3\alpha_2+3\alpha_3+5\alpha_4+4\alpha_5+3\alpha_6+2\alpha_7+\alpha_8} \times \\ & s_1 s_{\alpha_1+\alpha_3+\alpha_4+\alpha_5+\alpha_6+\alpha_7+\alpha_8} s_{\alpha_3+\alpha_4+\alpha_5} s_{\alpha_2+\alpha_3+2\alpha_4+\alpha_5} \times \\ & s_{\alpha_2+\alpha_3+2\alpha_4+\alpha_5+\alpha_6} s_{\alpha_2+\alpha_3+\alpha_4+\alpha_5+\alpha_6+\alpha_7} s_{\alpha_7+\alpha_8} s_6 s_{\alpha_2+\alpha_4+\alpha_5} \times \\ & s_{\alpha_1+\alpha_3+\alpha_4+\alpha_5+\alpha_6+\alpha_7+\alpha_8} s_{2\alpha_1+2\alpha_2+3\alpha_3+4\alpha_4+3\alpha_5+2\alpha_6+\alpha_7}. \end{aligned} \quad (9.10)$$

Since  $(\alpha_2 + \alpha_3 + 2\alpha_4 + \alpha_5, \alpha_2 + \alpha_3 + 2\alpha_4 + \alpha_5 + \alpha_6) = 1$ , we have

$$s_{\alpha_2+\alpha_3+2\alpha_4+\alpha_5} s_{\alpha_2+\alpha_3+2\alpha_4+\alpha_5+\alpha_6} = s_{\alpha_6} s_{\alpha_2+\alpha_3+2\alpha_4+\alpha_5}$$

Then, (9.10) is transformed as follows:

$$\begin{aligned} w_0 = & s_{\alpha_5+\alpha_6} s_{\alpha_4+\alpha_5+\alpha_6+\alpha_7} s_{\alpha_1+3\alpha_2+3\alpha_3+5\alpha_4+4\alpha_5+3\alpha_6+2\alpha_7+\alpha_8} \times \\ & s_1 s_{\alpha_1+\alpha_3+\alpha_4+\alpha_5+\alpha_6+\alpha_7+\alpha_8} s_{\alpha_3+\alpha_4+\alpha_5} s_6 \left( s_{\alpha_2+\alpha_3+2\alpha_4+\alpha_5} \times \right. \\ & \left. s_{\alpha_2+\alpha_3+\alpha_4+\alpha_5+\alpha_6+\alpha_7} s_{\alpha_7+\alpha_8} \right) s_6 s_{\alpha_2+\alpha_4+\alpha_5} \times \\ & s_{\alpha_1+\alpha_3+\alpha_4+\alpha_5+\alpha_6+\alpha_7+\alpha_8} s_{2\alpha_1+2\alpha_2+3\alpha_3+4\alpha_4+3\alpha_5+2\alpha_6+\alpha_7}. \end{aligned} \quad (9.11)$$

Conjugation with  $s_{\alpha_6}$ . In (9.11), we apply conjugation with  $s_{\alpha_6}$  to the following factors:

$$s_{\alpha_2+\alpha_3+2\alpha_4+\alpha_5} s_{\alpha_2+\alpha_3+\alpha_4+\alpha_5+\alpha_6+\alpha_7} s_{\alpha_7+\alpha_8}.$$

Since  $s_{\alpha_6}$  and  $s_{\alpha_2+\alpha_3+\alpha_4+\alpha_5+\alpha_6+\alpha_7}$  commute, after conjugation we get:

$$\begin{aligned} w_0 = & s_{\alpha_5+\alpha_6} s_{\alpha_4+\alpha_5+\alpha_6+\alpha_7} s_{\alpha_1+3\alpha_2+3\alpha_3+5\alpha_4+4\alpha_5+3\alpha_6+2\alpha_7+\alpha_8} \times \\ & s_1 s_{\alpha_1+\alpha_3+\alpha_4+\alpha_5+\alpha_6+\alpha_7+\alpha_8} s_{\alpha_3+\alpha_4+\alpha_5} s_{\alpha_2+\alpha_3+2\alpha_4+\alpha_5+\alpha_6} \times \\ & s_{\alpha_2+\alpha_3+\alpha_4+\alpha_5+\alpha_6+\alpha_7} s_{\alpha_6+\alpha_7+\alpha_8} s_{\alpha_2+\alpha_4+\alpha_5} \times \\ & s_{\alpha_1+\alpha_3+\alpha_4+\alpha_5+\alpha_6+\alpha_7+\alpha_8} s_{2\alpha_1+2\alpha_2+3\alpha_3+4\alpha_4+3\alpha_5+2\alpha_6+\alpha_7}. \end{aligned} \quad (9.12)$$

As a result, there are 12 factors in (9.12).

**9.3. Reducing  $w_0$  from 12 factors to 10.** In (9.12), roots  $\alpha_3 + \alpha_4 + \alpha_5$  and  $\alpha_1 + \alpha_3 + \alpha_4 + \alpha_5 + \alpha_6 + \alpha_7 + \alpha_8$  are orthogonal, so we can swap corresponding reflections:

$$\begin{aligned} w_0 = & s_{\alpha_5 + \alpha_6} s_{\alpha_4 + \alpha_5 + \alpha_6 + \alpha_7} s_{\alpha_1 + 3\alpha_2 + 3\alpha_3 + 5\alpha_4 + 4\alpha_5 + 3\alpha_6 + 2\alpha_7 + \alpha_8} \times \\ & s_1 s_{\alpha_3 + \alpha_4 + \alpha_5} s_{\alpha_1 + \alpha_3 + \alpha_4 + \alpha_5 + \alpha_6 + \alpha_7 + \alpha_8} \left( s_{\alpha_2 + \alpha_3 + 2\alpha_4 + \alpha_5 + \alpha_6} \times \right. \\ & \left. s_{\alpha_2 + \alpha_3 + \alpha_4 + \alpha_5 + \alpha_6 + \alpha_7} s_{\alpha_6 + \alpha_7 + \alpha_8} s_{\alpha_2 + \alpha_4 + \alpha_5} \right) \times \\ & s_{\alpha_1 + \alpha_3 + \alpha_4 + \alpha_5 + \alpha_6 + \alpha_7 + \alpha_8} s_{2\alpha_1 + 2\alpha_2 + 3\alpha_3 + 4\alpha_4 + 3\alpha_5 + 2\alpha_6 + \alpha_7}. \end{aligned} \quad (9.13)$$

Conjugation with  $s_{\alpha_1 + \alpha_3 + \alpha_4 + \alpha_5 + \alpha_6 + \alpha_7 + \alpha_8}$ . In (9.13), we apply conjugation with  $s_{\alpha_1 + \alpha_3 + \alpha_4 + \alpha_5 + \alpha_6 + \alpha_7 + \alpha_8}$  to the following 4 factors:

$$s_{\alpha_2 + \alpha_3 + 2\alpha_4 + \alpha_5 + \alpha_6} s_{\alpha_2 + \alpha_3 + \alpha_4 + \alpha_5 + \alpha_6 + \alpha_7} s_{\alpha_6 + \alpha_7 + \alpha_8} s_{\alpha_2 + \alpha_4 + \alpha_5}.$$

Since

$$\begin{aligned} (\alpha_2 + \alpha_3 + 2\alpha_4 + \alpha_5 + \alpha_6, \alpha_1 + \alpha_3 + \alpha_4 + \alpha_5 + \alpha_6 + \alpha_7 + \alpha_8) &= -1, \\ (\alpha_2 + \alpha_3 + \alpha_4 + \alpha_5 + \alpha_6 + \alpha_7, \alpha_1 + \alpha_3 + \alpha_4 + \alpha_5 + \alpha_6 + \alpha_7 + \alpha_8) &= -1, \\ (\alpha_6 + \alpha_7 + \alpha_8, \alpha_1 + \alpha_3 + \alpha_4 + \alpha_5 + \alpha_6 + \alpha_7 + \alpha_8) &= 1, \\ (\alpha_2 + \alpha_4 + \alpha_5, \alpha_1 + \alpha_3 + \alpha_4 + \alpha_5 + \alpha_6 + \alpha_7 + \alpha_8) &= -1, \end{aligned}$$

then

$$\begin{aligned} s_{\alpha_2 + \alpha_3 + 2\alpha_4 + \alpha_5 + \alpha_6} s_{\alpha_1 + \alpha_3 + \alpha_4 + \alpha_5 + \alpha_6 + \alpha_7 + \alpha_8} &= \\ s_{\alpha_1 + \alpha_3 + \alpha_4 + \alpha_5 + \alpha_6 + \alpha_7 + \alpha_8} s_{\alpha_1 + \alpha_2 + 2\alpha_3 + 3\alpha_4 + 2\alpha_5 + 2\alpha_6 + \alpha_7 + \alpha_8}, \\ s_{\alpha_2 + \alpha_3 + \alpha_4 + \alpha_5 + \alpha_6 + \alpha_7} s_{\alpha_1 + \alpha_3 + \alpha_4 + \alpha_5 + \alpha_6 + \alpha_7 + \alpha_8} &= \\ s_{\alpha_1 + \alpha_3 + \alpha_4 + \alpha_5 + \alpha_6 + \alpha_7 + \alpha_8} s_{\alpha_1 + \alpha_2 + 2\alpha_3 + 2\alpha_4 + 2\alpha_5 + 2\alpha_6 + 2\alpha_7 + \alpha_8}, \\ s_{\alpha_6 + \alpha_7 + \alpha_8} s_{\alpha_1 + \alpha_3 + \alpha_4 + \alpha_5 + \alpha_6 + \alpha_7 + \alpha_8} &= \\ s_{\alpha_1 + \alpha_3 + \alpha_4 + \alpha_5 + \alpha_6 + \alpha_7 + \alpha_8} s_{\alpha_1 + \alpha_3 + \alpha_4 + \alpha_5}, \\ s_{\alpha_2 + \alpha_4 + \alpha_5} s_{\alpha_1 + \alpha_3 + \alpha_4 + \alpha_5 + \alpha_6 + \alpha_7 + \alpha_8} &= \\ s_{\alpha_1 + \alpha_3 + \alpha_4 + \alpha_5 + \alpha_6 + \alpha_7 + \alpha_8} s_{\alpha_1 + \alpha_2 + \alpha_3 + 2\alpha_4 + 2\alpha_5 + \alpha_6 + \alpha_7 + \alpha_8}. \end{aligned}$$

After conjugation with  $s_{\alpha_1 + \alpha_3 + \alpha_4 + \alpha_5 + \alpha_6 + \alpha_7 + \alpha_8}$ , we get:

$$\begin{aligned} w_0 = & s_{\alpha_5 + \alpha_6} s_{\alpha_4 + \alpha_5 + \alpha_6 + \alpha_7} s_{\alpha_1 + 3\alpha_2 + 3\alpha_3 + 5\alpha_4 + 4\alpha_5 + 3\alpha_6 + 2\alpha_7 + \alpha_8} \times \\ & s_1 s_{\alpha_3 + \alpha_4 + \alpha_5} s_{\alpha_1 + \alpha_2 + 2\alpha_3 + 3\alpha_4 + 2\alpha_5 + 2\alpha_6 + \alpha_7 + \alpha_8} \times \\ & s_{\alpha_1 + \alpha_2 + 2\alpha_3 + 2\alpha_4 + 2\alpha_5 + 2\alpha_6 + 2\alpha_7 + \alpha_8} \times \\ & s_{\alpha_1 + \alpha_3 + \alpha_4 + \alpha_5} s_{\alpha_1 + \alpha_2 + \alpha_3 + 2\alpha_4 + 2\alpha_5 + \alpha_6 + \alpha_7 + \alpha_8} \times \\ & s_{2\alpha_1 + 2\alpha_2 + 3\alpha_3 + 4\alpha_4 + 3\alpha_5 + 2\alpha_6 + \alpha_7}. \end{aligned} \quad (9.14)$$

So, we have 10 factors in (9.14).

**9.4. Reducing  $w_0$  from 10 factors to 8.** First, we have that

$$s_{\alpha_1} s_{\alpha_3 + \alpha_4 + \alpha_5} = s_{\alpha_3 + \alpha_4 + \alpha_5} s_{\alpha_1 + \alpha_3 + \alpha_4 + \alpha_5},$$

Conjugation with  $s_{\alpha_1 + \alpha_3 + \alpha_4 + \alpha_5}$ . By (9.14), we get the following representation of  $w_0$ :

$$\begin{aligned} w_0 = & s_{\alpha_5 + \alpha_6} s_{\alpha_4 + \alpha_5 + \alpha_6 + \alpha_7} s_{\alpha_1 + 3\alpha_2 + 3\alpha_3 + 5\alpha_4 + 4\alpha_5 + 3\alpha_6 + 2\alpha_7 + \alpha_8} \times \\ & s_{\alpha_3 + \alpha_4 + \alpha_5} s_{\alpha_1 + \alpha_3 + \alpha_4 + \alpha_5} \left( s_{\alpha_1 + \alpha_2 + 2\alpha_3 + 3\alpha_4 + 2\alpha_5 + 2\alpha_6 + \alpha_7 + \alpha_8} \times \right. \\ & \left. s_{\alpha_1 + \alpha_2 + 2\alpha_3 + 2\alpha_4 + 2\alpha_5 + 2\alpha_6 + 2\alpha_7 + \alpha_8} \right) s_{\alpha_1 + \alpha_3 + \alpha_4 + \alpha_5} \times \\ & s_{\alpha_1 + \alpha_2 + \alpha_3 + 2\alpha_4 + 2\alpha_5 + \alpha_6 + \alpha_7 + \alpha_8} s_{2\alpha_1 + 2\alpha_2 + 3\alpha_3 + 4\alpha_4 + 3\alpha_5 + 2\alpha_6 + \alpha_7}. \end{aligned} \quad (9.15)$$

It is easy to check that

$$\begin{aligned} \alpha_1 + \alpha_3 + \alpha_4 + \alpha_5 &\perp \alpha_1 + \alpha_2 + 2\alpha_3 + 3\alpha_4 + 2\alpha_5 + 2\alpha_6 + \alpha_7 + \alpha_8, \\ \alpha_1 + \alpha_3 + \alpha_4 + \alpha_5 &\perp \alpha_1 + \alpha_2 + 2\alpha_3 + 2\alpha_4 + 2\alpha_5 + 2\alpha_6 + 2\alpha_7 + \alpha_8. \end{aligned}$$

Then, in (9.15), the pair of elements  $s_{\alpha_1+\alpha_3+\alpha_4+\alpha_5}$  is reduced:

$$\begin{aligned} w_0 &= s_{\alpha_5+\alpha_6} s_{\alpha_4+\alpha_5+\alpha_6+\alpha_7} s_{\alpha_1+3\alpha_2+3\alpha_3+5\alpha_4+4\alpha_5+3\alpha_6+2\alpha_7+\alpha_8} \times \\ &\quad s_{\alpha_3+\alpha_4+\alpha_5} s_{\alpha_1+\alpha_2+2\alpha_3+3\alpha_4+2\alpha_5+2\alpha_6+\alpha_7+\alpha_8} \times \\ &\quad s_{\alpha_1+\alpha_2+2\alpha_3+2\alpha_4+2\alpha_5+2\alpha_6+2\alpha_7+\alpha_8} \times \\ &\quad s_{\alpha_1+\alpha_2+\alpha_3+2\alpha_4+2\alpha_5+\alpha_6+\alpha_7+\alpha_8} s_{2\alpha_1+2\alpha_2+3\alpha_3+4\alpha_4+3\alpha_5+2\alpha_6+\alpha_7}. \end{aligned} \quad (9.16)$$

We get 8 factors in (9.16).

**9.5. Getting the factor with index  $\alpha_{max}$ .** We strive to choose the reflection  $s_\tau$  for conjugation of factors in (9.16) in such a way that one of the resulting factors is the highest root  $\alpha_{max}$ . To this end, let us put

$$\tau = \alpha_1 + 2\alpha_2 + 3\alpha_3 + 4\alpha_4 + 3\alpha_5 + 3\alpha_6 + 2\alpha_7 + \alpha_8.$$

Let us find the inner products of  $\tau$  with roots of (9.16).

$$\begin{aligned} (1) \quad &\alpha_5 + \alpha_6 \perp \tau, \\ (2) \quad &\alpha_4 + \alpha_5 + \alpha_6 + \alpha_7 \perp \tau, \\ (3) \quad &(\alpha_1 + 3\alpha_2 + 3\alpha_3 + 5\alpha_4 + 4\alpha_5 + 3\alpha_6 + 2\alpha_7 + \alpha_8, \tau) = 1, \\ (4) \quad &\alpha_3 + \alpha_4 + \alpha_5 \perp \tau, \\ (5) \quad &(\alpha_1 + \alpha_2 + 2\alpha_3 + 3\alpha_4 + 2\alpha_5 + 2\alpha_6 + \alpha_7 + \alpha_8, \tau) = 1, \\ (6) \quad &(\alpha_1 + \alpha_2 + 2\alpha_3 + 2\alpha_4 + 2\alpha_5 + 2\alpha_6 + 2\alpha_7 + \alpha_8, \tau) = 1, \\ (7) \quad &(\alpha_1 + \alpha_2 + \alpha_3 + 2\alpha_4 + 2\alpha_5 + \alpha_6 + \alpha_7 + \alpha_8, \tau) = -1, \\ (8) \quad &2\alpha_1 + 2\alpha_2 + 3\alpha_3 + 4\alpha_4 + 3\alpha_5 + 2\alpha_6 + \alpha_7 \perp \tau. \end{aligned} \quad (9.17)$$

Conjugation with  $s_\tau$ . The roots (1), (2), (4), (8) in (9.17) do not change, so the corresponding factors do not change after conjugation with  $s_\tau$ . The roots (3), (5), (6) are reduced by  $\tau$  after conjugation. In case (7), after conjugation, the root increases by  $\tau$ .

$$\begin{aligned} (3) \quad &(\alpha_1 + 3\alpha_2 + 3\alpha_3 + 5\alpha_4 + 4\alpha_5 + 3\alpha_6 + 2\alpha_7 + \alpha_8) - \tau = \alpha_2 + \alpha_4 + \alpha_5, \\ (5) \quad &(\alpha_1 + \alpha_2 + 2\alpha_3 + 3\alpha_4 + 2\alpha_5 + 2\alpha_6 + \alpha_7 + \alpha_8) - \tau = \\ &\quad -(\alpha_2 + \alpha_3 + \alpha_4 + \alpha_5 + \alpha_6 + \alpha_7), \\ (6) \quad &(\alpha_1 + \alpha_2 + 2\alpha_3 + 2\alpha_4 + 2\alpha_5 + 2\alpha_6 + 2\alpha_7 + \alpha_8) - \tau = \\ &\quad -(\alpha_2 + \alpha_3 + 2\alpha_4 + \alpha_5 + \alpha_6), \\ (7) \quad &(\alpha_1 + \alpha_2 + \alpha_3 + 2\alpha_4 + 2\alpha_5 + \alpha_6 + \alpha_7 + \alpha_8) + \tau = \\ &\quad 2\alpha_1 + 3\alpha_2 + 4\alpha_3 + 6\alpha_4 + 5\alpha_5 + 4\alpha_6 + 3\alpha_7 + 2\alpha_8. \end{aligned} \quad (9.18)$$

The root (7) in (9.18) is the highest root  $\alpha_{max}$  in  $E_8$ , The root (8) in (9.17) is the highest root  $\alpha_{max}^{e_7}$  in  $E_7 \subset E_8$ , see (9.1) and Table A.4. The decomposition (9.16) is transformed as follows:

$$\begin{aligned} w_0 &= s_{\alpha_5+\alpha_6} s_{\alpha_4+\alpha_5+\alpha_6+\alpha_7} s_{\alpha_2+\alpha_4+\alpha_5} s_{\alpha_3+\alpha_4+\alpha_5} \times \\ &\quad s_{\alpha_2+\alpha_3+\alpha_4+\alpha_5+\alpha_6+\alpha_7} s_{\alpha_2+\alpha_3+2\alpha_4+\alpha_5+\alpha_6} s_{\alpha_{max}} s_{\alpha_{max}^{e_7}}. \end{aligned} \quad (9.19)$$



**9.6. Getting factors with indices  $\alpha_{max}^{d6}$ ,  $\alpha_{max}^{e7}$ ,  $\alpha_{max}$ .** Note that  $\alpha_{max}$  is orthogonal to all simple roots except for  $\alpha_8$ , in addition  $\alpha_{max}^{e7}$  is orthogonal to all simple roots except for  $\alpha_1$  and  $\alpha_8$ . Thus, the conjugation associated with any root not containing  $\alpha_1$  and  $\alpha_8$  preserves  $\alpha_{max}$  and  $\alpha_{max}^{e7}$ . We continue to apply conjugations. Let us put  $\nu = \alpha_4 + \alpha_5 + \alpha_6$ .

Since  $\nu$  is orthogonal to  $\alpha_2 + \alpha_4 + \alpha_5$ ,  $\alpha_3 + \alpha_4 + \alpha_5$ ,  $\alpha_{max}^{e7}$  and  $\alpha_{max}$ , the conjugation with  $s_\nu$  does not change these roots. Since  $(\alpha_5 + \alpha_6, \nu) = 1$ ,  $(\alpha_4 + \alpha_5 + \alpha_6 + \alpha_7, \nu) = 1$  and  $(\alpha_2 + \alpha_3 + 2\alpha_4 + \alpha_5 + \alpha_6, \nu) = 1$ , then

$$\begin{aligned} \alpha_5 + \alpha_6 &\Rightarrow (\alpha_5 + \alpha_6) - \nu = -\alpha_4, \\ \alpha_4 + \alpha_5 + \alpha_6 + \alpha_7 &\Rightarrow (\alpha_4 + \alpha_5 + \alpha_6 + \alpha_7) - \nu = \alpha_7, \\ \alpha_2 + \alpha_3 + 2\alpha_4 + \alpha_5 + \alpha_6 &\Rightarrow \\ \alpha_2 + \alpha_3 + 2\alpha_4 + \alpha_5 + \alpha_6 - \nu &= \alpha_2 + \alpha_3 + \alpha_4. \end{aligned}$$

There remains only one root in (9.19) which must be considered. It is modified by conjugation  $s_\nu$  as follows:

$$\begin{aligned} \alpha_2 + \alpha_3 + \alpha_4 + \alpha_5 + \alpha_6 + \alpha_7 &\Rightarrow \\ (\alpha_2 + \alpha_3 + \alpha_4 + \alpha_5 + \alpha_6 + \alpha_7) + \nu &= \alpha_2 + \alpha_3 + 2\alpha_4 + 2\alpha_5 + 2\alpha_6 + \alpha_7. \end{aligned}$$

The obtained root is  $s_{\alpha_{max}^{d6}}$ .

Conjugation with  $s_\nu$ . After conjugation with  $s_{\alpha_4 + \alpha_5 + \alpha_6}$  we get the following decomposition of  $w_0$ :

$$w_0 = s_{\alpha_4} s_{\alpha_7} s_{\alpha_2 + \alpha_4 + \alpha_5} s_{\alpha_3 + \alpha_4 + \alpha_5} s_{\alpha_{max}^{d6}} s_{\alpha_2 + \alpha_3 + \alpha_4} s_{\alpha_{max}} s_{\alpha_{max}^{e7}}. \quad (9.20)$$

where  $s_{\alpha_{max}^{d6}}$  (resp.  $s_{\alpha_{max}^{e7}}$ ) is the reflection corresponding to the highest root in  $D_6 \subset E_7 \subset E_8$  (resp.  $E_7 \subset E_8$ ). The roots corresponding to factors (9.20) are as follows:

$$\begin{aligned} \alpha_4, \alpha_7, \alpha_2 + \alpha_4 + \alpha_5, \alpha_2 + \alpha_3 + \alpha_4, \alpha_3 + \alpha_4 + \alpha_5, \\ \alpha_{max}^{d6} &= \alpha_2 + \alpha_3 + 2\alpha_4 + 2\alpha_5 + 2\alpha_6 + \alpha_7, \\ \alpha_{max}^{e7} &= 2\alpha_1 + 2\alpha_2 + 3\alpha_3 + 4\alpha_4 + 3\alpha_5 + 2\alpha_6 + \alpha_7, \\ \alpha_{max} &= 2\alpha_1 + 3\alpha_2 + 4\alpha_3 + 6\alpha_4 + 5\alpha_5 + 4\alpha_6 + 3\alpha_7 + 2\alpha_8, \end{aligned} \quad (9.21)$$

see Table 1.1.

### 9.7. Finally: max-orthogonal decomposition in $W(E_8)$ .

**Proposition 9.2** (decomposition in  $W(E_8)$ ). (i) *The roots corresponding to factors (9.21) are mutually orthogonal.*

(ii) *The element  $w_0$  is decomposed as the product of 8 reflections associated with the mutually orthogonal roots:*

$$\alpha_2, \alpha_3, \alpha_5, \alpha_7, \alpha_{max}^{d4}, \alpha_{max}^{d6}, \alpha_{max}^{e7}, \alpha_{max}. \quad (9.22)$$

*The highest roots in (9.22) are ordered as follows:*

$$\alpha_{max}^{d4} < \alpha_{max}^{d6} < \alpha_{max}^{e7} < \alpha_{max}.$$

(iii) *The element  $w_0$  is the longest element in  $W(E_8)$ .*

*Proof.* (i) The root  $\alpha_{max}$  orthogonal to the remaining roots in (9.21) since they does not contain the term  $\alpha_8$ . Exclude  $\alpha_{max}$ . The root  $\alpha_{max}^{e7}$  orthogonal to the remaining roots since they does not contain the term  $\alpha_1$ . Exclude  $\alpha_{max}^{e7}$ . The root  $\alpha_{max}^{d6}$  orthogonal to the remaining roots since they does not

contain the term  $\alpha_6$ . It is easy to check that all the remaining roots are mutually orthogonal.

(ii) Let us conjugate factors (9.20) with  $s_{\alpha_3+\alpha_4}$ . This conjugation acts trivially on  $s_7$ ,  $\alpha_{max}^{d6}$ ,  $\alpha_{max}^{e7}$  and  $\alpha_{max}$ , since  $\alpha_3 + \alpha_4$  is orthogonal to all of them. Further,

$$\begin{aligned} s_{\alpha_3+\alpha_4} s_{\alpha_4} s_{\alpha_3+\alpha_4} &= s_{\alpha_3}, \\ s_{\alpha_3+\alpha_4} s_{\alpha_2+\alpha_4+\alpha_5} s_{\alpha_3+\alpha_4} &= s_{\alpha_2+\alpha_3+2\alpha_4+\alpha_5} = s_{\alpha_{max}^{d4}}, \\ s_{\alpha_3+\alpha_4} s_{\alpha_2+\alpha_3+\alpha_4} s_{\alpha_3+\alpha_4} &= s_{\alpha_2} \\ s_{\alpha_3+\alpha_4} s_{\alpha_3+\alpha_4+\alpha_5} s_{\alpha_3+\alpha_4} &= s_{\alpha_5}. \end{aligned}$$

Thus, we get all factors of (9.22).

(iii) Let us construct the determinant by roots of (9.22), see (9.23a). Next, we transform its rows as follows:

$$\begin{aligned} \alpha_{max} &\rightarrow \alpha_{max} - \alpha_{max}^{e7} - \alpha_{max}^{d6} - \alpha_7 = (0, 0, 0, 0, 0, 0, 0, 2), \\ \alpha_{max}^{e7} &\rightarrow \alpha_{max}^{e7} - \alpha_{max}^{d6} - \alpha_{max}^{d4} - \alpha_3 = (2, 0, 0, 0, 0, 0, 0, 0), \\ \alpha_{max}^{d6} &\rightarrow \alpha_{max}^{d6} - \alpha_{max}^{d4} - \alpha_7 - \alpha_5 = (0, 0, 0, 0, 0, 2, 0, 0), \\ \alpha_{max}^{d4} &\rightarrow \alpha_{max}^{d4} - \alpha_2 - \alpha_3 - \alpha_5 = (0, 0, 0, 2, 0, 0, 0, 0). \end{aligned}$$

As a result, we obtain a non-degenerate determinant, see (9.23b).

$$\left\| \begin{array}{cccccccc} 0 & 1 & 0 & 0 & 0 & 0 & 0 & 0 \\ 0 & 0 & 1 & 0 & 0 & 0 & 0 & 0 \\ 0 & 0 & 0 & 0 & 1 & 0 & 0 & 0 \\ 0 & 0 & 0 & 0 & 0 & 0 & 1 & 0 \\ 0 & 1 & 1 & 2 & 1 & 0 & 0 & 0 \\ 0 & 1 & 1 & 2 & 2 & 2 & 1 & 0 \\ 2 & 2 & 3 & 4 & 3 & 2 & 1 & 0 \\ 2 & 3 & 4 & 6 & 5 & 4 & 3 & 2 \end{array} \right\| \begin{array}{l} \alpha_2 \\ \alpha_3 \\ \alpha_5 \\ \alpha_7 \\ \alpha_{max}^{d4} \\ \alpha_{max}^{d6} \\ \alpha_{max}^{e7} \\ \alpha_{max} \end{array} \Rightarrow \left\| \begin{array}{cccccccc} 0 & 1 & 0 & 0 & 0 & 0 & 0 & 0 \\ 0 & 0 & 1 & 0 & 0 & 0 & 0 & 0 \\ 0 & 0 & 0 & 0 & 1 & 0 & 0 & 0 \\ 0 & 0 & 0 & 0 & 0 & 0 & 1 & 0 \\ 0 & 0 & 0 & 2 & 0 & 0 & 0 & 0 \\ 0 & 0 & 0 & 0 & 0 & 2 & 0 & 0 \\ 2 & 0 & 0 & 0 & 0 & 0 & 0 & 0 \\ 0 & 0 & 0 & 0 & 0 & 0 & 0 & 2 \end{array} \right\| \quad (9.23)$$

(a)
(b)

Thus, the roots of (9.22) are linearly independent. Since they are mutually orthogonal,  $w_0$  acts as  $-1$  on each of these roots, and hence  $w_0$  acts as  $-1$  on the whole space. Therefore,  $w_0$  acts in the same way as the longest element. Since the longest element is unique in the Weyl group,  $w_0$  is the longest in  $W(E_8)$ .  $\square$

## 10. Decomposition in $W(F_4)$

We introduce the notation for the highest roots in the root subsystems  $C_2 \subset C_3 \subset F_4$  as follows:

$$\begin{aligned} \alpha_{max}^{c2} &:= \alpha_2 + 2\alpha_3, \\ \alpha_{max}^{c3} &:= \alpha_2 + 2\alpha_3 + 2\alpha_4, \end{aligned} \quad (10.1)$$

see Table 1.1 and Remark 1.6. The numbering of vertices of the Dynkin diagram  $F_4$  is shown in Fig. 16. Note that indices of simple roots for  $\alpha_{max}^{c3}$  (resp.  $\alpha_{max}^{c2}$ ) in (10.1) differ from the indices of simple roots that appears as summands in  $\alpha_{max}^{c3}$  (resp.  $\alpha_{max}^{c2}$ ) defined in (5.1).

As in the case of  $E_6$ , consider the following 2 elements in the Weyl group  $W(F_4)$ :

$$\begin{aligned} w_1 &= s_1 s_2 (s_3 s_2 s_4 (s_3 s_2 s_1 s_2 s_3) s_4 s_2 s_3) s_2 s_1 \\ w_2 &= s_4 s_3 s_2 s_3 s_4 s_3 s_2 s_3 s_2 \end{aligned} \quad (10.2)$$

**Proposition 10.1** (decomposition in  $W(F_4)$ ). (i) *The element  $w_1$  is the reflection corresponding to the highest root  $\alpha_{max}$ :*

$$w_1 = s_{\alpha_{max}}. \quad (10.3)$$

(ii) *The element  $w_2$  is the product of 3 reflections corresponding to mutually orthogonal positive roots  $s_{\alpha_2}$ ,  $s_{\alpha_2+2\alpha_3}$  and  $s_{\alpha_2+2\alpha_3+2\alpha_4}$ :*

$$w_2 = s_{\alpha_2} s_{\alpha_2+2\alpha_3} s_{\alpha_2+2\alpha_3+2\alpha_4}. \quad (10.4)$$

(iii) *The element  $w_0 = w_1 w_2$  is the product of the following 4 reflections:*

$$w_0 = s_{\alpha_2} s_{\alpha_{max}^{c_2}} s_{\alpha_{max}^{c_3}} s_{\alpha_{max}}. \quad (10.5)$$

The roots corresponding to decomposition (10.5) are mutually orthogonal. They are ordered as follows:

$$\alpha_2 < \alpha_{max}^{c_2} < \alpha_{max}^{c_3} < \alpha_{max}.$$

(iv) *The element  $w_0$  is the longest element in  $W(F_4)$ .*

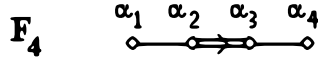

FIGURE 16. Numbering of simple roots in  $F_4$

*Proof.* (i) For conjugation by reflections corresponding to long roots  $\alpha_1$  and  $\alpha_2$  (resp. short roots  $\alpha_3$  and  $\alpha_4$ ), we use Proposition B.2 (resp. Proposition B.4):

$$\begin{aligned} s_2 s_1 s_2 &= s_{\alpha_1+\alpha_2}, \\ s_3 s_2 s_1 s_2 s_3 &= s_3 s_{\alpha_1+\alpha_2} s_3 = s_{\alpha_2+\alpha_1+2\alpha_3}, \\ s_4 s_3 s_2 s_1 s_2 s_3 s_4 &= s_4 s_{\alpha_2+\alpha_1+2\alpha_3} s_4 = s_{\alpha_1+\alpha_2+2\alpha_3+2\alpha_4}, \\ s_2 s_4 s_3 s_2 s_1 s_2 s_3 s_4 s_2 &= s_2 s_{\alpha_2+\alpha_1+2\alpha_3+2\alpha_4} s_2 = s_{\alpha_1+2\alpha_2+2\alpha_3+2\alpha_4}, \\ s_3 s_2 s_4 s_3 s_2 s_1 s_2 s_3 s_4 s_2 s_3 &= s_{\alpha_1+2\alpha_2+4\alpha_3+2\alpha_4}, \\ s_2 s_3 s_2 s_4 s_3 s_2 s_1 s_2 s_3 s_4 s_2 s_3 s_2 &= s_{\alpha_1+3\alpha_2+4\alpha_3+2\alpha_4}, \\ s_1 s_2 s_3 s_2 s_4 s_3 s_2 s_1 s_2 s_3 s_4 s_2 s_3 s_2 s_1 &= s_{2\alpha_1+3\alpha_2+4\alpha_3+2\alpha_4}. \end{aligned}$$

Since  $2\alpha_1 + 3\alpha_2 + 4\alpha_3 + 2\alpha_4$  is the highest root in  $F_4$ , we get eq. (10.3).

(ii) Transform  $w_2$  as follows:

$$\begin{aligned} (s_4 s_3 s_2 s_3 s_4) s_3 s_2 s_3 s_2 &= (s_4 s_{\alpha_2+2\alpha_3} s_4) s_3 s_2 s_3 s_2 = \\ s_{\alpha_2+2\alpha_3+2\alpha_4} (s_3 s_2 s_3) s_2 &= s_{\alpha_2+2\alpha_3+2\alpha_4} s_{\alpha_2+2\alpha_3} s_2. \end{aligned}$$

The orthogonality of the vectors  $\alpha_2$ ,  $\alpha_2 + 2\alpha_3$  and  $\alpha_2 + 2\alpha_3 + 2\alpha_4$  is verified directly.

(iii) The root  $\alpha_{max}$  is orthogonal to all simple root except  $\alpha_1$ . So,  $\alpha_{max}$  is orthogonal to  $\alpha_2$ ,  $\alpha_2 + 2\alpha_3$  and  $\alpha_2 + 2\alpha_3 + 2\alpha_4$ .

(iv) It suffices to prove that  $w_0$  acts on simple roots in the same way as the longest element. The reflection  $s_{\alpha_{max}}$  preserves all simple roots except  $\alpha_1$ . Since  $(\alpha_2, \alpha_2 + 2\alpha_3) = 0$  and  $(\alpha_2, \alpha_2 + 2\alpha_3 + 2\alpha_4) = 0$ , we get

$$w_0(\alpha_2) = s_{\alpha_2}(\alpha_2) = -\alpha_2.$$

Since  $s_{\alpha_2+2\alpha_3}$  maps  $\alpha_3$  to  $-\alpha_2 - \alpha_3$  and preserves  $\alpha_2$ , then

$$s_{\alpha_2+2\alpha_3}s_{\alpha_2}(\alpha_3) = s_{\alpha_2+2\alpha_3}(\alpha_2 + \alpha_3) = \alpha_2 - \alpha_2 - \alpha_3 = -\alpha_3.$$

Since  $(\alpha_2 + 2\alpha_3 + 2\alpha_4, \alpha_3) = -1 + 2 - 1 = 0$ , we have

$$w_0(\alpha_3) = s_{\alpha_2+2\alpha_3+2\alpha_4}(-\alpha_3) = -\alpha_3. \quad (10.6)$$

Further,  $s_{\alpha_2}(\alpha_4) = \alpha_4$ , and  $s_{\alpha_2+2\alpha_3}(\alpha_4) = \alpha_2 + 2\alpha_3 + \alpha_4$ , see Remark B.3(i). Then, since  $(\alpha_2 + 2\alpha_3 + \alpha_4, \alpha_2 + 2\alpha_3 + 2\alpha_4) = 1$ , we have

$$\begin{aligned} w_0(\alpha_4) &= s_{\alpha_2+2\alpha_3+2\alpha_4}(\alpha_2 + 2\alpha_3 + \alpha_4) = \\ &(\alpha_2 + 2\alpha_3 + \alpha_4) - (\alpha_2 + 2\alpha_3 + 2\alpha_4) = -\alpha_4, \end{aligned} \quad (10.7)$$

At last, consider  $w_0(\alpha_1)$ . First,  $\alpha_{max}(\alpha_1) = \alpha_1 - \alpha_{max}$ . Since  $s_2, s_{\alpha_2+2\alpha_3}, s_{\alpha_2+2\alpha_3+2\alpha_4}$  preserve  $\alpha_{max}$  we have

$$\begin{aligned} w_0(\alpha_1) &= s_{\alpha_2+2\alpha_3+2\alpha_4}s_{\alpha_2+2\alpha_3}s_2(\alpha_1) - \alpha_{max} = \\ &s_{\alpha_2+2\alpha_3+2\alpha_4}s_{\alpha_2+2\alpha_3}(\alpha_1 + \alpha_2) - \alpha_{max} = \\ &s_{\alpha_2+2\alpha_3+2\alpha_4}s_{\alpha_2+2\alpha_3}(\alpha_1) + \alpha_2 - \alpha_{max} = \\ &s_{\alpha_2+2\alpha_3+2\alpha_4}(\alpha_1 + \alpha_2 + 2\alpha_3) + \alpha_2 - \alpha_{max} = \\ &s_{\alpha_2+2\alpha_3+2\alpha_4}(\alpha_1) + 2\alpha_2 + 2\alpha_3 - \alpha_{max} = \\ &\alpha_1 + \alpha_2 + 2\alpha_3 + 2\alpha_4 + 2\alpha_2 + 2\alpha_3 - \alpha_{max} = \\ &\alpha_1 + 3\alpha_2 + 4\alpha_3 + 2\alpha_4 - \alpha_{max} = -\alpha_1. \end{aligned} \quad (10.8)$$

By (10), (10.6), (10.7) and (10.8) we get  $w_0 = -1$ , i.e.,  $w_0$  is the longest element in  $W(F_4)$ , see [4, Plate VIII].  $\square$

## 11. Decomposition in $W(G_2)$

There are 6 positive roots in  $G_2$ :

$$\begin{aligned} \text{short roots:} & \quad \alpha_1, \alpha_1 + \alpha_2, 2\alpha_1 + \alpha_2, \\ \text{long roots:} & \quad \alpha_2, 3\alpha_1 + \alpha_2, 3\alpha_1 + 2\alpha_2. \end{aligned}$$

**Proposition 11.1.** *Consider the following element in the Weyl group  $W(G_2)$ :*

$$w_0 = s_2s_1s_2s_1s_2s_1. \quad (11.1)$$

*The element  $w_0$  is the longest element in  $W(G_2)$ .*

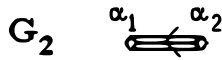

FIGURE 17. Numbering of simple roots in  $G_2$

*Proof.* By Propositions B.2 and B.4 we have

$$\begin{aligned} s_2 s_1 s_2 &= s_{\alpha_1 + \alpha_2}, & s_1 s_2 s_1 &= s_{3\alpha_1 + \alpha_2}, \\ w_0 &= s_{\alpha_1 + \alpha_2} s_{3\alpha_1 + \alpha_2} \end{aligned} \quad (11.2)$$

Consider the action of  $w_0$  on  $\alpha_1$  and  $\alpha_2$ . The following inner products hold:

$$\begin{aligned} (\alpha_1, \alpha_2) &= 1 \cdot \sqrt{3} \cos \frac{5\pi}{6} = -\frac{3}{2}, \\ (\alpha_1 + \alpha_2, \alpha_2) &= -\frac{3}{2} + 3 = \frac{3}{2} \implies s_{\alpha_1 + \alpha_2}(\alpha_2) = -(3\alpha_1 + 2\alpha_2), \\ (\alpha_1 + \alpha_2, \alpha_1) &= 1 - \frac{3}{2} = -\frac{1}{2} \implies s_{\alpha_1 + \alpha_2}(\alpha_1) = 2\alpha_1 + \alpha_2, \\ (3\alpha_1 + \alpha_2, \alpha_1) &= 3 - \frac{3}{2} = \frac{3}{2} \implies s_{3\alpha_1 + \alpha_2}(\alpha_1) = -(2\alpha_1 + \alpha_2), \\ (3\alpha_1 + \alpha_2, \alpha_2) &= -\frac{9}{2} + 3 = -\frac{3}{2} \implies s_{3\alpha_1 + \alpha_2}(\alpha_2) = 3\alpha_1 + 2\alpha_2. \end{aligned} \quad (11.3)$$

Then,

$$\begin{aligned} w_0(\alpha_1) &= -s_{\alpha_1 + \alpha_2}(2\alpha_1 + \alpha_2) = -((4\alpha_1 + 2\alpha_2) - (3\alpha_1 + 2\alpha_2)) = -\alpha_1, \\ w_0(\alpha_2) &= s_{\alpha_1 + \alpha_2}(3\alpha_1 + 2\alpha_2) = 3(2\alpha_1 + \alpha_2) - 2(3\alpha_1 + 2\alpha_2) = -\alpha_2, \end{aligned}$$

see [4, Plate IX]. The longest element is unique in  $W(G_2)$ , so  $w_0$  is the longest.  $\square$

The root  $3\alpha_1 + \alpha_2$  in the decomposition (11.2) is not the highest root in any root subsystem  $G_2$ . There is another decomposition of  $w_0$  with 2 factors, one of which corresponds to a simple root, and the second to the highest root.

**Proposition 11.2** (decomposition in  $W(G_2)$ ). *The longest element in  $W(G_2)$  is decomposed into 2 factors corresponding to the following orthogonal roots:*

$$\alpha_1, 3\alpha_1 + 2\alpha_2. \quad (11.4)$$

Here,  $3\alpha_1 + 2\alpha_2$  is the highest root and  $\alpha_1 < \alpha_{max}$ .

*Proof.* By (11.1) and (11.2) we have

$$w_0 = (s_2 s_{3\alpha_1 + \alpha_2} s_2) s_1.$$

Further, by (11.3) we have  $(3\alpha_1 + \alpha_2, \alpha_2) = -\frac{3}{2}$ , then

$$s_{\alpha_2}(3\alpha_1 + \alpha_2) = 3\alpha_1 + \alpha_2 - \frac{2(-\frac{3}{2})}{3}\alpha_2 = 3\alpha_1 + 2\alpha_2.$$

Then, by (B.1) we have

$$w_0 = s_{3\alpha_1 + 2\alpha_2} s_{\alpha_1}.$$

At last,  $(3\alpha_1 + 2\alpha_2, \alpha_1) = 3 + 2(-\frac{3}{2}) = 0$ , i.e., roots  $3\alpha_1 + 2\alpha_2$  and  $\alpha_1$  are orthogonal.  $\square$

## APPENDIX A. The highest roots

Root system	The highest root	The highest root in the root subsystems
$A_n$	$\alpha_{max} = \alpha_{max}^{an} = \alpha_1 + \cdots + \alpha_n$	$\alpha_{max}^{ai} = \alpha_1 + \cdots + \alpha_i$
$B_n$	$\alpha_{max} = \alpha_{max}^{bn} = \alpha_1 + 2\alpha_2 + \cdots + 2\alpha_n$	$\alpha_{max}^{bi} = \alpha_{n-i+1} + 2\alpha_{n-i+2} + \cdots + 2\alpha_n$
$C_n$	$\alpha_{max} = \alpha_{max}^{cn} = 2\alpha_1 + \cdots + 2\alpha_{n-1} + \alpha_n$	$\alpha_{max}^{ci} = 2\alpha_{n-i+1} + \cdots + 2\alpha_{n-1} + \alpha_n$
$D_n$	$\alpha_{max} = \alpha_{max}^{dn} = \alpha_1 + 2\alpha_2 + \cdots + 2\alpha_{n-2} + \alpha_{n-1} + \alpha_n$	$\alpha_{max}^{di} = \alpha_{n-i+1} + 2\alpha_{n-i+2} + \cdots + 2\alpha_{n-2} + \alpha_{n-1} + \alpha_n$

TABLE A.3. The highest roots in the root systems  $A, B, C, D$  and their root subsystems, see Table 1.1.

Root system	The highest root	The highest roots in the root subsystems
$E_6$	$\alpha_{max} = \alpha_{max}^{e6} = \alpha_1 + 2\alpha_2 + 2\alpha_3 + 3\alpha_4 + 2\alpha_5 + \alpha_6$	$\alpha_{max}^{a3}, \alpha_{max}^{a5}$
$E_7$	$\alpha_{max} = \alpha_{max}^{e7} = 2\alpha_1 + 2\alpha_2 + 3\alpha_3 + 4\alpha_4 + 3\alpha_5 + 2\alpha_6 + \alpha_7$	$\alpha_{max}^{d4}, \alpha_{max}^{d6}$
$E_8$	$\alpha_{max} = \alpha_{max}^{e8} = 2\alpha_1 + 3\alpha_2 + 4\alpha_3 + 6\alpha_4 + 5\alpha_5 + 4\alpha_6 + 3\alpha_7 + 2\alpha_8$	$\alpha_{max}^{d4}, \alpha_{max}^{d6}, \alpha_{max}^{e7}$
$F_4$	$\alpha_{max} = \alpha_{max}^{f4} = 2\alpha_1 + 3\alpha_2 + 4\alpha_3 + 2\alpha_4$	$\alpha_{max}^{c2}, \alpha_{max}^{c3}$
$G_2$	$\alpha_{max} = \alpha_{max}^{g2} = 3\alpha_1 + 2\alpha_2$	

TABLE A.4. The highest roots in the root systems  $E, F, G$  and their root subsystems, see Table 1.1.

## APPENDIX B. Two conjugation cases in the Weyl group

Let  $\mathcal{E}$  be the linear space spanned by simple roots of  $\Delta$ , and  $(, )$  be the symmetric bilinear form on  $\mathcal{E}$  invariant under Weyl group  $W(\Phi)$ , [4, Ch.VI, §1, Prop.7].

We distinguish two cases of reflections used in conjugation: those corresponding to long roots (Proposition B.2) and those corresponding to short roots (Proposition B.4).

**Lemma B.1.** *For any two roots  $\alpha$  and  $\beta$  we have*

$$s_\alpha s_\beta s_\alpha = s_{s_\alpha(\beta)}. \quad (\text{B.1})$$

*Proof.* Really,

$$s_\beta s_\alpha(x) = s_\alpha(x) - \frac{2(\beta, s_\alpha(x))}{(\beta, \beta)}\beta = s_\alpha(x) - \frac{2(s_\alpha(\beta), x)}{(s_\alpha(\beta), s_\alpha(\beta))}\beta, \text{ and}$$

$$s_\alpha s_\beta s_\alpha(x) = x - \frac{2(s_\alpha(\beta), x)}{(s_\alpha(\beta), s_\alpha(\beta))}s_\alpha(\beta) = s_{s_\alpha(\beta)}(x), \text{ i.e.,}$$

$$s_\alpha s_\beta s_\alpha = s_{s_\alpha(\beta)}.$$

□

For  $\alpha, \beta \in \Phi$ , put

$$n(\alpha, \beta) := \frac{2(\alpha, \beta)}{(\beta, \beta)}. \quad (\text{B.2})$$

Then,

$$s_\alpha(\beta) = \beta - n(\beta, \alpha)\alpha. \quad (\text{B.3})$$

**Proposition B.2** (case of a long root). *Let  $\alpha$  and  $\beta$  be two roots in  $\Phi$ , such that  $\|\alpha\| \geq \|\beta\|$ . If  $n(\beta, \alpha) = \pm 1$ , the conjugation of  $s_\beta$  by  $s_\alpha$  is as follows:*

$$s_\alpha s_\beta s_\alpha = \begin{cases} s_{\alpha+\beta} & \text{if } n(\beta, \alpha) = -1, \\ s_{\alpha-\beta} & \text{if } n(\beta, \alpha) = 1. \end{cases} \quad (\text{B.4})$$

*The length of the root  $\alpha + \beta$  (resp.  $\alpha - \beta$ ) coincide with  $\|\beta\|$ :*

$$\|\alpha + \beta\| = \|\beta\| \quad \text{if } n(\beta, \alpha) = -1,$$

$$\|\alpha - \beta\| = \|\beta\| \quad \text{if } n(\beta, \alpha) = 1.$$

*In other words, the length  $\|\alpha + \beta\|$  (resp.  $\|\alpha - \beta\|$ ) either coincides with lengths of  $\|\alpha\|$  and  $\|\beta\|$  (when they are the same length) or coincides with length of the shortest of them.*

*Proof.* For all cases, we substitute  $\alpha$  and  $\beta$  in (B.1). If  $n(\beta, \alpha) = \pm 1$  then

$$s_\alpha(\beta) = \begin{cases} \alpha + \beta & \text{if } n(\beta, \alpha) = -1, \\ \alpha - \beta & \text{if } n(\beta, \alpha) = 1. \end{cases} \quad 2(\beta, \alpha) = \begin{cases} \|\alpha\|^2 & \text{if } n(\beta, \alpha) = 1, \\ -\|\alpha\|^2 & \text{if } n(\beta, \alpha) = -1. \end{cases}$$

$$s_\alpha s_\beta s_\alpha = s_{s_\alpha(\beta)} = \begin{cases} s_{\alpha+\beta} & \text{if } n(\beta, \alpha) = -1, \\ s_{\alpha-\beta} & \text{if } n(\beta, \alpha) = 1. \end{cases}$$

Then,

$$\begin{aligned} \text{If } n(\alpha, \beta) = -1 & \text{ then } \|\alpha + \beta\|^2 = \|\alpha\|^2 + \|\beta\|^2 + 2(\beta, \alpha) = \|\beta\|^2, \\ \text{If } n(\alpha, \beta) = 1 & \text{ then } \|\alpha - \beta\|^2 = \|\alpha\|^2 + \|\beta\|^2 - 2(\beta, \alpha) = \|\beta\|^2. \quad \square \end{aligned}$$

**Remark B.3.** Let  $\alpha$  and  $\beta$  be roots in  $\Phi$  such that  $n(\alpha, \beta) = \pm 1$ . All such cases are presented in [4, Ch.VI, §1, n°3].

(i) If  $\|\alpha\| = \|\beta\|$  then  $(\beta, \alpha) = n(\alpha, \beta) = \pm 1$ . This holds for

- two roots in  $A_n, D_n, E_n,$
- two long roots in  $B_n, F_n,$
- two short roots in  $C_n, F_n.$

(ii) If  $\|\alpha\| = \sqrt{2}\|\beta\|$  and  $\|\beta\| = 1$  then  $(\beta, \alpha) = n(\beta, \alpha) = \pm 1$ . This holds for two roots of different lengths in  $B_n, F_n.$

(iii) If  $\|\alpha\| = \sqrt{2}\|\beta\|$  and  $\|\beta\| = \sqrt{2}$  then  $(\beta, \alpha) = 2n(\beta, \alpha) = \pm 2$ . This holds for the roots of different lengths in  $C_n.$

(iv) Let  $\|\alpha\| = \sqrt{3}\|\beta\|$  and  $\|\beta\| = 1$ . Then  $(\beta, \alpha) = \frac{3}{2}n(\beta, \alpha) = \pm \frac{3}{2}$ . This holds for the roots of different lengths in  $G_2.$

**Proposition B.4** (case of a short root). *Let  $\alpha$  and  $\beta$  be two roots in  $\Phi$ , such that  $\|\alpha\| > \|\beta\|$ .*

(i) *If  $\|\alpha\| = \sqrt{2}\|\beta\|$ ,  $n(\alpha, \beta) = \pm 2$ , the conjugation of  $s_\alpha$  by  $s_\beta$  is as follows:*

$$s_\beta s_\alpha s_\beta = \begin{cases} s_{\alpha+2\beta} & \text{if } n(\alpha, \beta) = -2, \\ s_{\alpha-2\beta} & \text{if } n(\alpha, \beta) = 2. \end{cases} \quad (\text{B.5})$$

*The root  $\alpha+2\beta$  (resp.  $\alpha-2\beta$ ) in the case  $n(\alpha, \beta) = -2$  (resp.  $n(\alpha, \beta) = 2$ ) is long. This case occurs for pairs of roots  $\|\alpha\| > \|\beta\|$  in  $B_n, C_n$  and  $F_4.$*

(ii) *If  $\|\alpha\| = \sqrt{3}\|\beta\|$ ,  $n(\alpha, \beta) = \pm 3$ , the conjugation of  $s_\alpha$  by  $s_\beta$  is as follows:*

$$s_\beta s_\alpha s_\beta = \begin{cases} s_{\alpha+3\beta} & \text{if } (\alpha, \beta) = -\frac{3}{2}, \\ s_{\alpha-3\beta} & \text{if } (\alpha, \beta) = \frac{3}{2}. \end{cases} \quad (\text{B.6})$$

This case occurs for pairs of roots  $\|\alpha\| > \|\beta\|$  in  $G_2.$

*Proof.* (i) Eq. (B.5) follows from (B.3):

$$s_\beta(\alpha) = \alpha - n(\alpha, \beta)\beta = \begin{cases} \alpha + 2\beta & \text{if } n(\alpha, \beta) = -2, \\ \alpha - 2\beta & \text{if } n(\alpha, \beta) = 2. \end{cases}$$

For cases  $B_n, C_n, F_4$ , since  $(\beta, \beta) = 1$ , we have  $(\alpha, \beta) = \frac{n(\alpha, \beta)}{2} = \pm 1$ . By (B.5)  $\alpha + 2\beta$  (similarly for  $\alpha - 2\beta$ ) is long, because

$$\begin{aligned} (\alpha + 2\beta, \alpha + 2\beta) &= (\alpha, \alpha) + 4(\alpha, \beta) + 4(\beta, \beta) = 2 - 4 + 4 = 2 \quad \text{if } (\alpha, \beta) = -1, \\ (\alpha - 2\beta, \alpha - 2\beta) &= (\alpha, \alpha) - 4(\alpha, \beta) + 4(\beta, \beta) = 2 - 4 + 4 = 2 \quad \text{if } (\alpha, \beta) = 1. \end{aligned}$$

(ii) Here,  $(\beta, \beta) = 1$  and  $(\beta, \alpha) = \frac{n(\alpha, \beta)}{2} = \pm \frac{3}{2}$ , then

$$s_\beta(\alpha) = \alpha - n(\beta, \alpha)\beta = \begin{cases} \alpha + 3\beta & \text{if } n(\alpha, \beta) = -3, \\ \alpha - 3\beta & \text{if } n(\alpha, \beta) = 3. \end{cases}$$



By (B.6) the root of  $\alpha + 3\beta$  (similarly for  $\alpha - 3\beta$ ) is long, because

$$(\alpha + 3\beta, \alpha + 3\beta) = (\alpha, \alpha) + 6(\alpha, \beta) + 9(\beta, \beta) = 3 - 6\left(\frac{3}{2}\right) + 9 = 3 \text{ if } n(\alpha, \beta) = -3,$$

$$(\alpha - 3\beta, \alpha - 3\beta) = (\alpha, \alpha) - 6(\alpha, \beta) + 9(\beta, \beta) = 3 - 6\left(\frac{3}{2}\right) + 9 = 3 \text{ if } n(\alpha, \beta) = 3. \quad \square$$

#### REFERENCES

- [1] G. Benkart, Seok-Jin Kang, Se-jin Oh, and E. Park. Construction of irreducible representations over Khovanov-Lauda-Rouquier algebras of finite classical type. *Int. Math. Res. Not. IMRN*, (5):1312–1366, 2014.
- [2] A. Björner and F. Brenti. *Combinatorics of Coxeter groups*, volume 231 of *Graduate Texts in Mathematics*. Springer, New York, 2005.
- [3] J. Blasiak. A factorization theorem for affine kazhdan-lusztig basis elements. *arXiv preprint arXiv:0908.0340*, 2009.
- [4] N. Bourbaki. *Lie groups and Lie algebras. Chapters 4–6*. Elements of Mathematics (Berlin). Springer-Verlag, Berlin, 2002. Translated from the 1968 French original by Andrew Pressley.
- [5] R. W. Carter. Conjugacy classes in the Weyl group. *Compositio Math.*, 25:1–59, 1972.
- [6] W. A. de Graaf. Constructing canonical bases of quantized enveloping algebras. *Experiment. Math.*, 11(2):161–170, 2002.
- [7] V. V. Deodhar. On the root system of a Coxeter group. *Comm. Algebra*, 10(6):611–630, 1982.
- [8] G. Dimitrov and V. Tsanov. Homogeneous hypercomplex structures i—the compact lie groups. *Transformation Groups*, 21(3):725–762, 2016.
- [9] J. E. Humphreys. *Reflection groups and Coxeter groups*, volume 29 of *Cambridge Studies in Advanced Mathematics*. Cambridge University Press, Cambridge, 1990.
- [10] A. Joseph. The minimal orbit in a simple Lie algebra and its associated maximal ideal. *Ann. Sci. École Norm. Sup. (4)*, 9(1):1–29, 1976.
- [11] A. Joseph. A preparation theorem for the prime spectrum of a semisimple lie algebra. *J. of algebra*, 48(2):241–289, 1977.
- [12] M. Kashiwara. Crystalizing the q-analogue of universal enveloping algebras. *Communications in Mathematical Physics*, 133:249–260, 1990.
- [13] A. Kirillov, Jr. *Quiver representations and quiver varieties*, volume 174 of *Graduate Studies in Mathematics*. American Mathematical Society, Providence, RI, 2016.
- [14] B. Kostant. The cascade of orthogonal roots and the coadjoint structure of the nil-radical of a borel subgroup of a semisimple lie group. *Mosc. Math. J.*, 12(3):605–620, 669, 2012.
- [15] B. Kostant. Center, cascade of orthogonal roots, and a construction of lipsman-wolf. In *Lie Groups: Structure, Actions, and Representations: In Honor of Joseph A. Wolf on the Occasion of his 75th Birthday*, pages 163–173. Springer, 2013.
- [16] Y. Li. Quiver varieties and symmetric pairs. *Representation Theory of the American Mathematical Society*, 23(1):1–56, 2019.
- [17] Y. Li and Y. Ling. Longest Weyl group elements in action. In *Interactions of quantum affine algebras with cluster algebras, current algebras and categorification—in honor of Vyjayanthi Chari on the occasion of her 60th birthday*, volume 337 of *Progr. Math.*, pages 245–276. Birkhäuser/Springer, Cham, [2021] ©2021.
- [18] R. L. Lipsman and J. A. Wolf. Canonical semi-invariants and the plancherel formula for parabolic groups. *Transactions of the American Mathematical Society*, 269(1):111–131, 1982.
- [19] P. Littelmann. Cones, crystals, and patterns. *Transform. Groups*, 3(2):145–179, 1998.
- [20] G. Lusztig. Canonical bases arising from quantized enveloping algebras. *J. Amer. Math. Soc.*, 3(2):447–498, 1990.
- [21] G. Lusztig. Canonical bases arising from quantized enveloping algebras. II. Number 102, pages 175–201 (1991). 1990. Common trends in mathematics and quantum field theories (Kyoto, 1990).
- [22] G. Lusztig. Remarks on quiver varieties. *Duke Math. J.*, 105(2):239 — 265, 2000.

- [23] G. Lusztig. Action of longest element on a hecke algebra cell module. *Pacific Journal of Mathematics*, 279(1):383–396, 2015.
- [24] H. Nakajima. Reflection functors for quiver varieties and Weyl group actions. *Math. Ann.*, 327(4):671–721, 2003.
- [25] D. I. Panyushev. Commutative polarisations and the kostant cascade. *Algebras and Representation Theory*, pages 1–19, 2022.
- [26] M. Reineke. On the coloured graph structure of lusztig’s canonical basis. *Mathematische Annalen*, 307:705–723, 1997.
- [27] T. A. Springer. Some remarks on involutions in coxeter groups. *Communications in Algebra*, 10(6):631–636, 1982.
- [28] R. P. Stanley. On the number of reduced decompositions of elements of Coxeter groups. *European J. Combin.*, 5(4):359–372, 1984.
- [29] R. Stekolshchik. Extending snow’s algorithm for computations in the finite weyl groups. *arXiv preprint arXiv:2212.03156*, 2022.
- [30] J. R. Stembridge. Some combinatorial aspects of reduced words in finite Coxeter groups. *Trans. Amer. Math. Soc.*, 349(4):1285–1332, 1997.
- [31] X. Xie. The based ring of the lowest generalized two-sided cell of an extended affine Weyl group. *J. Algebra*, 477:1–28, 2017.