

Alternating (In)Dependence-Friendly Logic

Dylan Bellier, Massimo Benerecetti, Dario Della Monica, and Fabio Mogavero

Abstract

Hintikka and Sandu originally proposed *Independence Friendly Logic* (IF) as a first-order logic of *imperfect information* to describe *game-theoretic phenomena* underlying the semantics of natural language. The logic allows for expressing independence constraints among quantified variables, in a similar vein to Henkin quantifiers, and has a nice *game-theoretic semantics* in terms of *imperfect information games*. However, the IF semantics exhibits some limitations. It treats the players asymmetrically, considering only one of the two players as having imperfect information when evaluating truth, *resp.*, falsity, of a sentence. In addition, the truth and falsity of sentences coincide with the existence of a uniform winning strategy for one of the two players in the semantic imperfect information game. As a consequence, IF does admit undetermined sentences, which are neither true nor false, thus failing the law of excluded middle. In this paper, we investigate an extension of IF, called *Alternating Dependence/Independence Friendly Logic* (ADIF), tailored to overcome these limitations. To this end, we introduce a novel *compositional semantics*, generalising the one based on trumps proposed by Hodges for IF. The new semantics (i) allows for meaningfully restricting both players at the same time, (ii) enjoys the property of game-theoretic determinacy, (iii) recovers the law of excluded middle for sentences, and (iv) grants ADIF the full descriptive power of *Second Order Logic*. We also provide an equivalent *Herbrand-Skolem semantics* and a *game-theoretic semantics* for the prenex fragment of ADIF, the latter being defined in terms of a determined infinite-duration game that precisely captures the other two semantics on finite structures.

1. Introduction

Informational independence is a phenomenon that emerges quite naturally in *game theory*, as players in a game make moves based on what they know about the state of the current play (von Neumann and Morgenstern, 1944). In games such as Chess or Go, both players have *perfect information* about the current state of the play and the moves they and their adversary have previously made. For other games, like the card-games Poker and Bridge, the players have to make decisions based only on *partial (i.e., imperfect) information* on the state of the play. In other words, in these latter games, players have to make decisions *informationally independent* of some of the choices made by the other players.

Given the tight connection between games and logics, think for instance at *game-theoretic semantics* (Lorenzen, 1961; Lorenz, 1968; Hintikka, 1973), a number of proposals have been put forward to reason with or about informational independence, most notably, *Independence-Friendly Logic* (Hintikka and Sandu, 1989), *Dependence Logic* (Väänänen, 2007), and logics derived thereof (Galliani, 2012; Grädel and Väänänen, 2013; Kuusisto, 2013; Clairambault et al., 2013; Kuusisto, 2015).

Independence-Friendly Logic (IF) was originally introduced by Hintikka and Sandu (1989), and later extensively studied, *e.g.*, in Mann et al. (2011), as an extension of *First-Order Logic* (FOL) (Hilbert and Ackermann, 1928) with informational independence as first-class notion, and with applications in semantics of *natural language* in mind. Unlike in FOL, where quantified variables always functionally depend on all the previously quantified ones, the values for quantified variables in IF can be chosen independently of the values of some specific variables quantified before in the formula. This is syntactically represented by means of the so called *slashed operator* notation, where, for instance, $(\exists x/W)\varphi$ is intended to mean that variable x must be chosen independently (*i.e.*, without knowledge) of the values of the variables contained in the set W . The logic has a nice game-theoretic semantics (Hintikka and Sandu, 1997), given in terms of games of imperfect information, where a sentence is true if the verifier player, usually called Eloise, has a *strategy* to win the semantic game. If the falsifier player, Abelard, has a *winning strategy*, then the sentence is declared false. Since games with imperfect information are considered here, neither situation may occur, as the specific game may be *undetermined*. In this case, the corresponding sentence is neither true nor false, therefore establishing a failure of the *law of excluded middle*. Hodges (1997a) later developed a compositional semantics for IF, by defining satisfaction *w.r.t.* a set of assignment, called *trump* (*a.k.a.* *teams*, in later iterations of the idea), instead of a single assignment as in classic Tarskian semantics (Tarski, 1936, 1944) of FOL. The high level intuition here is that a trump encodes the informational uncertainty about what is the actual current assignment.

Dependence Logic (Väänänen, 2007) (DL) takes a slightly different approach to the problem, by separating quantifiers from dependence specification. This is achieved by adding to FOL the so called *dependence atoms* of the form $=(\vec{x}, y)$, with the intended meaning that the value of variable y is completely determined by, hence functionally dependent on, the value of variables in the vector \vec{x} . The separation of dependence constraints and quantifiers can express very naturally dependencies on both quantified and non quantified variables, and allows for a quite flexible approach to reasoning about dependence and independence. DL has also been extended with other types of atoms like, *e.g.*, *independence atoms* (Grädel and Väänänen, 2013) and *inclusion/exclusion atoms* (Galliani, 2012). The logic is expressively equivalent to both IF and the existential fragment of *Second Order Logic* (SOL) (Hilbert and Ackermann, 1938; Church, 1956; Shapiro, 1991). As such, DL still allows for undetermined sentences and is not closed under classical negation. To recover closure under negation and, consequently, the law of excluded middle, Väänänen (2007) introduced *Team Logic*

(TL), an extension of DL with the so called *contradictory negation* \sim , an idea already investigated by Hintikka (1996) in the context of IF, where it was allowed only in front of a sentence. TL is substantially more expressive than DL, reaching the full descriptive power of SOL, covering, thus, the entire polynomial hierarchy (Stockmeyer, 1976). However, in order to recover the nice properties of FOL, such as the duality between Boolean connectives and quantifiers, TL requires two different versions of the propositional connectives, \neg and \sim for negation, \wedge and \oplus for conjunction, \vee and \otimes for disjunction, as well as an additional pseudo quantifier $!x$ called *shriek*. This approach also bears significant consequences. In particular, TL lacks any meaningful direct game-theoretic interpretation, as also pointed out by Väänänen (2007), which DL still retains, mainly thanks to its equivalence with existential SOL.

There is a well-known connection between logics to reason with or about informational independence and the extension of first-order logic with the *partially ordered* (a.k.a. *branching* or *Henkin*) *quantifiers*, originally proposed by Henkin (1961) to overcome the linear dependence intrinsic in classic quantifier prefixes (see also Krynicki and Mostowski (1995) for a comprehensive survey on the topic). For instance, the sentence $\left(\begin{smallmatrix} \forall x_1 \exists y_1 \\ \forall x_2 \exists y_2 \end{smallmatrix}\right)\varphi$ states that for all x_1 and x_2 , there exists a value for y_1 , that only depends on x_1 , and a value for y_2 , that only depends on x_2 , such that φ is true. Sentences like this can easily be expressed in IF by means of suitable variable independence schemata. For the sentence in the example, $\forall x_1 \forall x_2 \exists (y_1/\{x_2\}) \exists (y_2/\{x_1\}) \varphi$ is an equivalent IF sentence. Similarly to IF, the prenex fragment of the logic with Henkin quantifiers, where a Henkin quantifier prefix is followed by a FOL sentence (Walkoe, 1970), is known to be expressively equivalent to Σ_1^1 , the existential fragment of SOL, while the full (non-prenex) logic was proved to be able to express Δ_2^1 -properties by Enderton (1970).

As observed by Blass and Gurevich (1986), logics with Henkin quantifiers exhibit an asymmetric nature from a game-theoretical viewpoint, in that they typically consider only whether the existential player, Eloise, has a winning strategy that proves a formula true. This is, instead, solved in IF, at the cost of indeterminacy of the logic, by introducing two satisfaction relations, one for truth and one for falsity, and by defining them in terms of uniform strategies for the players (Mann et al., 2011). More specifically, a strategy for a player, either Eloise or Abelard, is said to be uniform if for every variable x , which is controlled by that player and is required to be independent of a set of variables W , the strategy always chooses the same value in all the states of the game that differ only for the values of the variables in W . To win the game and prove the sentence true, Eloise is required to have a uniform strategy that wins every play induced by her strategy. These compatible plays need not be compatible with any uniform strategy of the adversary, meaning that when evaluating truth of a sentence, no restrictions to the universal quantifiers controlled by Abelard actually apply. A similar situation happens when evaluating falsity of a sentence. In this case, Abelard, needs to have a uniform strategy that wins all the compatible plays. Here, the constraints on the existential variables are ignored. The

imperfect information nature of these games manifests itself in the uniformity requirements that leads to indeterminacy of the logic. This, in turn, implies that some sentences are neither true nor false.

The situation described above is also reflected in Hodges' separate use of trumps and co-trumps in the compositional semantics he proposed for IF. His idea of using sets of assignments allows for mimicking the uniformity constraints on the strategies in a compositional way. Essentially, a trump records all the states, represented here as assignments, the game could be in, depending on the possible choices made by Abelard and the corresponding responses by Eloise. These assignments correspond, intuitively, to the (partial) plays compatible with the strategy followed by Eloise when evaluating the formula. A trump can, then, encode the uncertainty that Eloise has about the actual current state of the play, in that assignments that only differ for the variables in W are indistinguishable to Eloise when she has to choose the value of a variable x that is independent of the variables in W . This allows Eloise to make her choice in each such state in a uniform way and adhere to the constraints on her variables when trying to prove the truth of the formula. Analogously, a co-trump encodes the states induced by the possible choices of Eloise and allows Abelard to behave uniformly when he wants to falsify the formula.

In this work we investigate a conservative extension of IF, called *Alternating Dependence/Independence Friendly Logic* (ADIF), tailored to take the restrictions of both players into account at the same time, namely both when evaluating truth and when evaluation falsity, and to overcome the indeterminacy of the logic. To this end, we generalise trumps/teams in such a way that the choices of both players are recorded in the semantic structure *w.r.t.* which formulae are evaluated, enabling both of them to make their choices in accordance with the uniformity constraints required by the independence restrictions specified in the quantifiers. This approach leads to the notion of *hyperteam*, defined as a set of teams, which provides a two-level structure, where each level is intuitively associated with one of the two players and encodes the uncertainty that the opponent has about the actual choices up to that stage of the play. From another perspective, the structure can be viewed as encoding all the possible plays in the underlying game, comprising the choices of one player as well as the possible responses of the opponent. With all this information at hand, then, we can easily obtain the plays of the dual game, namely the one in which the two players exchange their roles. The change of roles between the players, in turn, precisely corresponds to the game-theoretic interpretation of negation. This allows us to include negation to the logic in a very natural way and, at the same time, recover the law of the excluded middle, which is lost in IF, by avoiding undetermined sentences, and have a fully symmetric treatment of the independence constraints on the universal and existential quantifiers. We show that the resulting logic is at least as powerful as full SOL and TL. We also provide a novel game-theoretic semantics for the prenex fragment of the logic, by means of a determined infinite-duration first-order game with a parity-like winning condition, that we call *independence game*. For any ADIF-sentence φ and finite relational structure \mathfrak{A} , we can build an independence game $\mathfrak{D}_{\varphi}^{\mathfrak{A}}$ such

that Eloise has a winning strategy *iff* φ is true in \mathfrak{A} . As a byproduct, given that there exists a translation of TL into ADIF, independence games indirectly provide a game-theoretic interpretation for TL.

2. Alternating Dependence/Independence-Friendly Logic

Alternating Dependence/Independence-Friendly Logic (ADIF, for short) is defined as an extension of FOL. Therefore, throughout the work we shall assume, as it is customary, a countable set of variables Vr and a generic signature $\mathcal{L} \triangleq \langle \mathcal{R}, \text{ar} \rangle$ comprised of a set \mathcal{R} of relation symbols, including the interpreted relation ‘=’ for equality, and a function $\text{ar}: \mathcal{R} \rightarrow \mathbb{N}$ providing the arity of each relation in \mathcal{R} . We also fix, if not stated otherwise, an \mathcal{L} -structure $\mathfrak{A} \triangleq \langle A, \{R^{\mathfrak{A}}\}_{R \in \mathcal{R}} \rangle$, with domain of the discourse A , interpretation $R^{\mathfrak{A}} \subseteq A^{\text{ar}(R)}$ of each relation $R \in \mathcal{R}$, and size $|\mathfrak{A}| \triangleq |A|$.

2.1. Syntax

In the same vein as IF, ADIF augments FOL with *restricted quantifiers*, where restrictions specify possible *dependence/independence constraints*. Basically, these restrictions allow for formulae of the form $\exists^{+W}x.\varphi$ and $\exists^{-W}x.\varphi$, whose intuitive reading is best understood in game-theoretic terms, where the existential quantifiers are controlled by player Eloise (the *verifier*), while universal quantifiers are controlled by player Abelard (the *falsifier*). Then, the intended meaning of $\exists^{+W}x.\varphi$ (*resp.*, $\exists^{-W}x.\varphi$) is that Eloise has to choose a value for x , solely depending on (*resp.*, independently of) the values of the variables in W , that makes φ true. Similarly, $\forall^{+W}x.\varphi$ (*resp.*, $\forall^{-W}x.\varphi$) means that Abelard has to be able to choose, solely depending on (*resp.*, independently of) the variables in W , a value for x that allows him to prove the argument φ false. In other words, the decoration $\pm W$ specifies what information is available to the player associated with the logic quantifier when she or he has to make the choice. In case of $+W$, only the variables in that set are available, when $-W$ is present, instead, only the variables outside the set, *i.e.*, in the complement $\text{Vr} \setminus W$, are visible.

Definition 1 (ADIF Syntax). *The Alternating Dependence/Independence-Friendly Logic (ADIF, for short) is the set of formulae built according to the following grammar, where $R \in \mathcal{R}$, $\vec{x} \in \text{Vr}^{\text{ar}(R)}$, $x \in \text{Vr}$, and $W \subseteq \text{Vr}$ with $|W| < \omega$:*

$$\varphi := \perp \mid \top \mid R(\vec{x}) \mid \neg\varphi \mid \varphi \wedge \varphi \mid \varphi \vee \varphi \mid \exists^{\pm W}x.\varphi \mid \forall^{\pm W}x.\varphi.$$

ADF (*resp.*, AIF) denotes the fragment where only dependence ($+W$) (*resp.*, independence ($-W$)) constructs are permitted.

Predicative logics usually rely on a notion of *free placeholder* to correctly define the meaning of a formula and ADIF is no exception. In ADIF, however, we distinguish between *support* and *free variables*. Specifically, support

variables are the ones occurring in some atom $R(\vec{x})$ that need to be assigned a value in order to evaluate the truth of the formula. The free variables, instead, also include those occurring in some dependence/independence constraint. By $\text{sup}: \text{ADIF} \rightarrow 2^{\text{Vr}}$ we denote the function collecting all support variables $\text{sup}(\varphi)$ of a formula φ , defined as follows:

- $\text{sup}(\perp), \text{sup}(\top) \triangleq \emptyset$; • $\text{sup}(R(\vec{x})) \triangleq \vec{x}$; • $\text{sup}(\neg \varphi) \triangleq \text{sup}(\varphi)$;
- $\text{sup}(\varphi_1 \odot \varphi_2) \triangleq \text{sup}(\varphi_1) \cup \text{sup}(\varphi_2)$, for all connective symbols $\odot \in \{\wedge, \vee\}$;
- $\text{sup}(\mathbb{Q}^{\pm w} x. \varphi) \triangleq \text{sup}(\varphi) \setminus \{x\}$, for all quantifier symbols $\mathbb{Q} \in \{\exists, \forall\}$.

The free-variable function $\text{free}: \text{ADIF} \rightarrow 2^{\text{Vr}}$ is defined similarly, except for the quantifier case, which is reported in the following:

- $\text{free}(\mathbb{Q}^{\pm w} x. \varphi) \triangleq (\text{free}(\varphi) \setminus \{x\}) \cup \llbracket \pm W \rrbracket$, if $x \in \text{free}(\varphi)$, and $\text{free}(\mathbb{Q}^{\pm w} x. \varphi) \triangleq \text{free}(\varphi)$, otherwise, for all quantifier symbols $\mathbb{Q} \in \{\exists, \forall\}$, with $\llbracket \pm W \rrbracket$ denoting the set W , for the symbol ‘+’, and its complement $\text{Vr} \setminus W$, for the symbol ‘-’.

Obviously, it holds that $\text{sup}(\varphi) \subseteq \text{free}(\varphi)$. A *sentence* φ is a formula with $\text{free}(\varphi) = \emptyset$. If $\text{sup}(\varphi) = \emptyset$, but $\text{free}(\varphi) \neq \emptyset$, then φ is just a *pseudo sentence*. As an example, $\varphi = \forall^{+\emptyset} x. \exists^{+\emptyset} y. (x = y)$ is a sentence, while $\varphi' = \forall^{+\emptyset} x. \exists^{+z} y. (x = y)$ is a pseudo sentence, since $\text{sup}(\varphi') = \emptyset$, but $\text{free}(\varphi') = \{z\}$. We also define $\exists x. \varphi \triangleq \exists^{+w} x. \varphi$ and $\forall x. \varphi \triangleq \forall^{+w} x. \varphi$, where $W \triangleq \text{sup}(\varphi) \setminus \{x\}$. From now on, by FOL we mean the syntactic fragment of ADIF composed of formulae that only use the last two quantifiers. For such formulae, it holds that $\text{sup}(\varphi) = \text{free}(\varphi)$. As we shall show in Section 3, this fragment semantically corresponds to classic FOL as defined by Tarski (1936). Similarly, we shall later identify a richer fragment of ADIF that semantically corresponds to IF as formalised by Hodges (1997a).

Before giving the formal definition of the compositional semantics, it is worth providing just few examples of properties expressible in ADIF. In discussing these examples, then, we shall rely on the informal game-theoretic interpretation of the quantifiers given above.

Let us picture a two-turn game where Player 1, who chooses first, controls the variable x and Player 2, who chooses second, controls y . Let $\psi(x, y)$ be the goal of Player 2 and consider the following two ADF sentences:

$$\varphi_1 := \forall x. \exists^{+x} y. \psi(x, y); \quad \varphi_2 := \exists x. \forall^{+x} y. \neg \psi(x, y).$$

Sentence φ_1 , whenever true, requires Player 2, in this case Eloise, be able to respond to every choice for x made by Player 1, in this case Abelard, so that goal $\psi(x, y)$ is always satisfied. This corresponds to the existence of a winning strategy for Eloise, namely a strategy that wins every induced play in the game, for the objective $\psi(x, y)$. On the contrary, with inverted roles, the truth of φ_2 ensures that there is a choice of Eloise such that, no matter what Abelard chooses, $\psi(x, y)$ cannot be achieved. This means that Abelard cannot have a

winning strategy for $\psi(x, y)$. If φ_2 is false, instead, it is Abelard who has a winning strategy for $\psi(x, y)$, while the falsity of φ_1 ensures the existence of a choice of Abelard such that, no matter what Eloise chooses, $\psi(x, y)$ cannot be achieved. Note that both sentences belong to the FOL fragment introduced above and their semantics also corresponds to the Tarskian one. However, the ADF sentences

$$\varphi_3 := \forall x. \exists^{+\emptyset} y. \psi(x, y); \quad \varphi_4 := \exists x. \forall^{+\emptyset} y. \neg \psi(x, y)$$

add imperfect information to the picture and have no FOL analogue. Sentence φ_3 still postulates the existence of a winning strategy for Eloise, but this time also requires that, when making the choice for y , the player has no access to any information and, in particular, to the value chosen for x by the opponent. We call such a strategy \emptyset -uniform. Similarly, φ_4 , when true, witnesses the non-existence of such a \emptyset -uniform winning strategy for Abelard. The ADIF pseudo sentences

$$\varphi_5 := \forall x. \exists^{-x} y. \psi(x, y); \quad \varphi_6 := \exists x. \forall^{-x} y. \neg \psi(x, y)$$

have a very similar meaning to φ_3 and φ_4 , respectively, with the exception that y can depend on any variable different from x , since $\text{free}(\varphi_5) = \text{free}(\varphi_6) = \text{Vr} \setminus x$.

Consider now a three-turn game, extending the previous one, where, after the move of Player 2, Player 1 chooses the value for another variable under its control, let us call this z . The ADF sentence

$$\varphi_7 := \exists x. \forall^{+\emptyset} y. \exists^{+x} z. (\psi_1(x, y) \wedge \psi_2(y, z))$$

is a bit more involved. First of all, it states that Player 2, *i.e.*, Abelard, cannot see the choice made for x . In addition, while Player 1, *i.e.*, Eloise, is not aware of y , she has access to the value previously chosen for x by herself. The sentence, whenever true, ensure the existence of a choice by Eloise which ensures that Abelard cannot prevent $\psi_1(x, y)$ from happening, no matter what he chooses. Moreover, Eloise can respond to any of these latter choices for y and win objective $\psi_2(y, z)$ by only looking at the value of x . This means that Abelard is not able to prevent $\psi_1(x, y)$ and, at the same time, Eloise has a x -uniform strategy to win $\psi_2(y, z)$ at the same time.

2.2. Semantics

The semantics we define for ADIF follows an approach similar to (Hodges, 1997a), where a compositional semantics for IF was first proposed. Hodges' idea was to expand an assignment for the free variables to a set of assignments, a trump in his terminology (*a.k.a.* team (Väänänen, 2007)), with the intuition of capturing Eloise's uncertainty on the actual state of the semantic game underlying the logic (Hintikka and Sandu, 1989). This essentially corresponds to recording the possible choices made by the opponent, *i.e.*, Abelard, for its own variables. Hodges' semantics, though able to correctly capture IF, is, however, not adequate for our purposes. Indeed, by design, it is intrinsically asymmetric,

treating the two players differently. More specifically, a single set of assignments only provides complete information about the choices of one of the two players (*i.e.*, Abelard in trumps and Eloise in co-trumps) and only allows to restrict the choices of the adversary. This is also connected with the lack of classic properties of negation, specifically the law of excluded middle.

In order to overcome these limitations, incorporate negation into ADIF in a natural way and obtain a fully determined logic, we propose here a generalisation of Hodges' approach. To give semantics to an ADIF formula φ , we then proceed as follows. Similarly to Hodges, the idea is that the interpretations of the free variables correspond to the choices that the two players could make up to the current stage of the game, *i.e.*, the stage where the formula φ has to be evaluated. These possible choices are organised in a two-level structure, *i.e.*, a set of sets of assignments, each level summarising the information about the choices a player may have made in previous turns. In order to evaluate the formula φ , then, a player chooses a set of assignments, while its opponent chooses one assignment in that set where φ must hold. We shall use a flag $\alpha \in \{\exists\forall, \forall\exists\}$, called *alternation flag*, to keep track of which player is assigned to which level of choice. If $\alpha = \exists\forall$, Eloise chooses the set of assignments, while Abelard chooses one of those assignments; if $\alpha = \forall\exists$, the dual reasoning applies. In a sense, the level associated with a given player, say Eloise, encodes the uncertainty that the opponent Abelard has about her actual choices up to that stage.

Given a flag $\alpha \in \{\exists\forall, \forall\exists\}$, we denote by $\bar{\alpha}$ the dual flag, *i.e.*, $\bar{\alpha} \in \{\exists\forall, \forall\exists\}$ with $\bar{\alpha} \neq \alpha$. Let $\text{Asg} \triangleq \text{Vr} \rightarrow \mathbb{A}$ be the set of (partial) *assignments* over Vr , namely partial functions from variables to values in the structure domain \mathbb{A} . Given a set of variables $V \subseteq \text{Vr}$, we denote by $\text{Asg}(V) \triangleq \{\chi \in \text{Asg} \mid \text{dom}(\chi) = V\}$ the assignments defined on V and by $\text{Asg}_{\subseteq}(V) \triangleq \{\chi \in \text{Asg} \mid V \subseteq \text{dom}(\chi)\}$ the set of assignments defined on some superset of V . A *team (of assignments)* is a set of total assignments all defined on the same set of variables. Formally, $\text{TAsg} \triangleq \{X \subseteq \text{Asg}(V) \mid V \subseteq \text{Vr}\}$ collects all possible teams over some subset V of Vr , $\text{TAsg}(V) \triangleq \{X \in \text{TAsg} \mid X \subseteq \text{Asg}(V)\}$ contains those over V and $\text{TAsg}_{\subseteq}(V) \triangleq \{X \in \text{TAsg} \mid X \subseteq \text{Asg}_{\subseteq}(V)\}$ the teams defined on supersets of V . The idea described above is, then, captured by the notion of *hyperteam (of assignments)*, namely a set of teams defined over some arbitrary set $V \subseteq \text{Vr}$:

$$\text{HAsg} \triangleq \{\mathfrak{X} \subseteq \text{TAsg}(V) \mid V \subseteq \text{Vr}\}.$$

By $\text{HAsg}(V) \triangleq \{\mathfrak{X} \in \text{HAsg} \mid \mathfrak{X} \subseteq 2^{\text{Asg}(V)}\}$ we denote the set of hypertteams over V , while $\text{HAsg}_{\subseteq}(V) \triangleq \{\mathfrak{X} \in \text{HAsg} \mid \mathfrak{X} \subseteq 2^{\text{Asg}_{\subseteq}(V)}\}$ contains the hypertteams defined on supersets of V . All the assignments inside a team $X \in \text{TAsg}$ or hypertteam $\mathfrak{X} \in \text{HAsg}$ are defined on the same variables, whose sets are indicated by $\text{vr}(X)$ and $\text{vr}(\mathfrak{X})$, respectively. We shall call the empty set of teams \emptyset the *empty hypertteam*, every set containing the empty team, *e.g.*, $\{\emptyset\}$, a *null hypertteam*, and the set $\{\{\emptyset\}\}$ containing a single team comprised only of the empty assignment the *trivial hypertteam*. Essentially, the trivial hypertteam encodes the situation in which none of the players has made any choice yet and, hence, contains the minimal “consistent” state of a game. In this sense, then, null and empty

hyperteams do not convey any meaningful information about the possible state of a game and are included here mainly for technical reasons, as they allow for a cleaner formal definition of the semantics. For this reason, we shall refer to every hyperteam which is neither the empty hyperteam nor a null hyperteam with the term *proper hyperteam*.

For any pair of hyperteam $\mathfrak{X}_1, \mathfrak{X}_2 \in \text{HAsg}$, we write $\mathfrak{X}_1 \sqsubseteq \mathfrak{X}_2$ to state that, for all teams $X_1 \in \mathfrak{X}_1$, there exists a team $X_2 \in \mathfrak{X}_2$ such that $X_2 \subseteq X_1$. As usual, $\mathfrak{X}_1 \equiv \mathfrak{X}_2$ denotes the fact that both $\mathfrak{X}_1 \sqsubseteq \mathfrak{X}_2$ and $\mathfrak{X}_2 \sqsubseteq \mathfrak{X}_1$ hold true. Obviously, $\mathfrak{X}_1 \sqsubseteq \mathfrak{X}_2$ implies $\text{vr}(\mathfrak{X}_1) = \text{vr}(\mathfrak{X}_2)$. It is clear that the relation \sqsubseteq is both reflexive and transitive, hence it is a preorder; as an immediate consequence, \equiv is an equivalence relation. In particular, we shall show (see Corollary 1 later in this section) that \equiv captures the intuitive notion of equivalence between hyperteam, in the sense that two equivalent hyperteam *w.r.t.* \equiv do satisfy the same ADIF formulae. Figure 1 provides a graphical representation of the preorder relation \sqsubseteq .

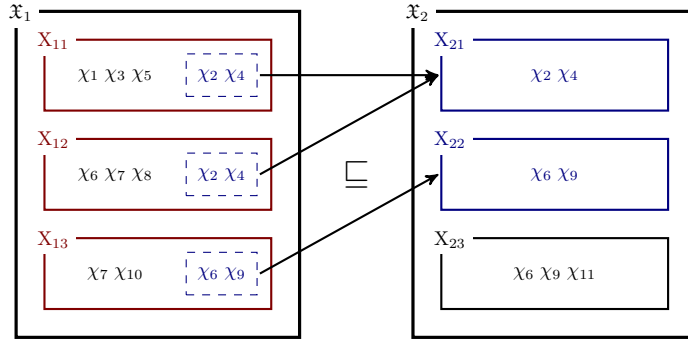

Figure 1: Two hyperteam with $\mathfrak{X}_1 \sqsubseteq \mathfrak{X}_2$, but $\mathfrak{X}_2 \not\sqsubseteq \mathfrak{X}_1$.

Example 1. In Figure 1, the hyperteam \mathfrak{X}_1 is \sqsubseteq -included in the hyperteam \mathfrak{X}_2 , since, for each team X in \mathfrak{X}_1 , there is a team in \mathfrak{X}_2 that is set-included in X . For instance, the team X_{11} of \mathfrak{X}_1 contains the assignments $\chi_1, \chi_2, \chi_3, \chi_4$ and χ_5 , so, it includes the team X_{21} of \mathfrak{X}_2 composed of χ_2 and χ_4 . Note that not all teams in \mathfrak{X}_2 are included in a team in \mathfrak{X}_1 and different teams of \mathfrak{X}_1 can choose the same team of \mathfrak{X}_2 to include.

Since we are dealing with imperfect information, we need a way to define a notion of indistinguishability relative to dependence constraints, intuitively, those specified in quantifiers. Given a hyperteam $\mathfrak{X} \in \text{HAsg}$ and a set of variables $W \subseteq \text{Vr}$, we define $\mathfrak{X}|_W \triangleq \{X|_W \mid X \in \mathfrak{X}\}$ and $X|_W \triangleq \{\chi|_W \mid \chi \in X\}$, where $\chi|_W$ is the restriction of the assignment χ to the domain $\text{dom}(\chi) \cap W$. We can, then, compare hyperteam relative to W by writing $\mathfrak{X}_1 =_W \mathfrak{X}_2$ for $\mathfrak{X}_1|_W = \mathfrak{X}_2|_W$, meaning that the two hyperteam are indistinguishable when only variables in W are considered. Similarly, $\mathfrak{X}_1 \equiv_W \mathfrak{X}_2$ stands for $\mathfrak{X}_1|_W \equiv \mathfrak{X}_2|_W$ and means that they are equivalent on W , while $\mathfrak{X}_1 \sqsubseteq_W \mathfrak{X}_2$ abbreviates $\mathfrak{X}_1|_W \sqsubseteq \mathfrak{X}_2|_W$

and relativises the ordering to a dependence constraint. Obviously, $\mathfrak{X}_1 =_W \mathfrak{X}_2$, $\mathfrak{X}_1 \equiv_W \mathfrak{X}_2$, and $\mathfrak{X}_1 \sqsubseteq_W \mathfrak{X}_2$ imply $\mathfrak{X}_1 =_{W'} \mathfrak{X}_2$, $\mathfrak{X}_1 \equiv_{W'} \mathfrak{X}_2$, and $\mathfrak{X}_1 \sqsubseteq_{W'} \mathfrak{X}_2$, respectively, for all $W' \subseteq W$.

Example 2. In Figure 1, \mathfrak{X}_2 is not \sqsubseteq -included in \mathfrak{X}_1 , as none of the teams of \mathfrak{X}_2 includes a team of \mathfrak{X}_1 . Now, assume the existence of a set of variables W that makes $\{\chi_1, \chi_3, \chi_4, \chi_5, \chi_6, \chi_7, \chi_{10}\} \upharpoonright_W$ collapse to $\{\chi_1\} \upharpoonright_W$. Then, we have:

$$\begin{array}{l} \mathfrak{X}_2 \upharpoonright_W \\ \begin{array}{l} X_{21} \upharpoonright_W = \{\chi_1 \upharpoonright_W, \chi_2 \upharpoonright_W\} \\ X_{22} \upharpoonright_W = \{\chi_1 \upharpoonright_W, \chi_9 \upharpoonright_W\} \\ X_{23} \upharpoonright_W = \{\chi_1 \upharpoonright_W, \chi_9 \upharpoonright_W, \chi_{11} \upharpoonright_W\} \end{array} \end{array} \quad \left| \quad \begin{array}{l} \mathfrak{X}_1 \upharpoonright_W \\ \begin{array}{l} X_{11} \upharpoonright_W = \{\chi_1 \upharpoonright_W, \chi_2 \upharpoonright_W\} \\ X_{12} \upharpoonright_W = \{\chi_1 \upharpoonright_W, \chi_2 \upharpoonright_W, \chi_8 \upharpoonright_W\} \\ X_{13} \upharpoonright_W = \{\chi_1 \upharpoonright_W, \chi_9 \upharpoonright_W\} \end{array} \end{array} \right.$$

Now, team $X_{11} \upharpoonright_W$ is included in $X_{21} \upharpoonright_W$ and team $X_{13} \upharpoonright_W$ is included in both $X_{22} \upharpoonright_W$ and $X_{23} \upharpoonright_W$. Therefore, $\mathfrak{X}_2 \sqsubseteq_W \mathfrak{X}_1$ and, so, $\mathfrak{X}_1 \equiv_W \mathfrak{X}_2$, since $\mathfrak{X}_1 \sqsubseteq \mathfrak{X}_2$.

The alternating semantics is given by means of a satisfaction relation between a hyperteam \mathfrak{X} and a formula φ , *w.r.t.* a given interpretation of the players in \mathfrak{X} , that is *w.r.t.* an alternation flag $\alpha \in \{\exists\forall, \forall\exists\}$. As a consequence, we shall introduce two satisfaction relations, $\models^{\exists\forall}$ and $\models^{\forall\exists}$, one for each interpretation of players in the hyperteam. The intuition is that, when the alternation flag α is $\exists\forall$, then a team is chosen existentially by Eloise and all its assignments, chosen universally by Abelard, must satisfy φ . Conversely, when α is $\forall\exists$, then all teams, chosen universally by Abelard, must contain at least one assignments, chosen existentially by Eloise, that satisfies φ .

The definition of the semantics relies on three basic operations on hyperteam: the *dualisation* swaps the role of the two players in a hyperteam, allowing for connecting the two satisfaction relations and a symmetric treatment of quantifiers later on; the *extension* directly handles quantifications; finally, the *partition* deals with disjunction and conjunction.

Let us consider the *dualisation operator* first. Given a hyperteam \mathfrak{X} , the dual hyperteam $\overline{\mathfrak{X}}$ exchanges the role of the two players *w.r.t.* \mathfrak{X} . This means that, if Eloise is the player choosing the team in \mathfrak{X} and Abelard the one choosing the assignment in the team, it will be Abelard who chooses the team in $\overline{\mathfrak{X}}$ and Eloise the one who chooses the assignment. To ensure that the semantics of the underlying game is not altered when exchanging the order of choice for the two players, we need to reshuffle the assignments in \mathfrak{X} so as to simulate the original dependencies between the choices. To this end, for a hyperteam \mathfrak{X} , we introduce the set

$$\text{Chc}(\mathfrak{X}) \triangleq \{\mathfrak{d}: \mathfrak{X} \rightarrow \text{Asg} \mid \forall X \in \mathfrak{X}. \mathfrak{d}(X) \in X\}$$

of *choice functions*, whose definition implicitly assumes the axiom of choice, whenever the structure domain A is infinite. $\text{Chc}(\mathfrak{X})$ contains all the functions \mathfrak{d} that, for every team X in \mathfrak{X} , pick a specific assignment $\mathfrak{d}(X)$ in that set. Each such function simulates a possible choice of the second player of \mathfrak{X} depending on the choice of (the team chosen by) the first player. The dual hyperteam $\overline{\mathfrak{X}}$, then, collects the images of the choice functions in $\text{Chc}(\mathfrak{X})$. We, thus, obtain a

hyperteam in which the choice order of the two players is inverted:

$$\bar{\mathfrak{X}} \triangleq \{\text{img}(\mathfrak{d}) \mid \mathfrak{d} \in \text{Chc}(\mathfrak{X})\}.$$

It is immediate to check that the only hypertteams equivalent to the empty or null ones are themselves and they are also dual of one another. Therefore, the class of proper hypertteams is closed under dualisation. In addition, the trivial hypertteam is self-dual.

Proposition 1. 1) $\mathfrak{X} \equiv \emptyset$ iff $\mathfrak{X} = \emptyset$ iff $\bar{\mathfrak{X}} = \{\emptyset\}$; 2) $\mathfrak{X} \equiv \{\emptyset\}$ iff $\emptyset \in \mathfrak{X}$ iff $\bar{\mathfrak{X}} = \emptyset$. Moreover, 3) $\overline{\{\{\emptyset\}\}} = \{\{\emptyset\}\}$. Finally, 4) \mathfrak{X} is proper iff $\bar{\mathfrak{X}}$ is proper as well.

Example 3. Consider the following two dual hypertteams

$$\mathfrak{X} = \left\{ \begin{array}{l} \mathbf{X}_1 = \{\chi_{11}, \chi_{12}\}, \\ \mathbf{X}_2 = \{\chi_{21}, \chi_{22}\}, \\ \mathbf{X}_3 = \{\chi_3\} \end{array} \right\} \quad \text{and} \quad \bar{\mathfrak{X}} = \left\{ \begin{array}{l} \text{img}(\mathfrak{d}_1) = \{\chi_{11}, \chi_{21}, \chi_3\}, \\ \text{img}(\mathfrak{d}_2) = \{\chi_{11}, \chi_{22}, \chi_3\}, \\ \text{img}(\mathfrak{d}_3) = \{\chi_{12}, \chi_{21}, \chi_3\}, \\ \text{img}(\mathfrak{d}_4) = \{\chi_{12}, \chi_{22}, \chi_3\} \end{array} \right\},$$

where the teams are $\mathbf{X}_1 = \{\chi_{11}, \chi_{12}\}$, $\mathbf{X}_2 = \{\chi_{21}, \chi_{22}\}$, and $\mathbf{X}_3 = \{\chi_3\}$. Every team in $\bar{\mathfrak{X}}$ is obtained as the image of one of the four choice functions $\mathfrak{d}_i \in \text{Chc}(\mathfrak{X})$, each choosing exactly one assignment from \mathbf{X}_1 , one from \mathbf{X}_2 , and the unique one from \mathbf{X}_3 . Intuitively, in \mathfrak{X} the strategy of the first player, say Eloise, can only choose the colour of the final assignments (either red for \mathbf{X}_1 , blue for \mathbf{X}_2 , or green for \mathbf{X}_3), while the one for Abelard decides which assignment of each colour will be picked. After dualisation, the two players exchange the order in which they choose. Therefore, Abelard, starting first in $\bar{\mathfrak{X}}$, will select one of the four choice functions, which picks an assignment for each colour. Eloise, choosing second, by using her strategy that selects the colour will give the final assignment. In other words, the original strategies of the players encoded in the hypertteam, as well as their dependencies, are preserved, regardless of the swap of their role in the dual hypertteam. The example also shows that, as we shall prove shortly (see Theorem 2 later in this section), if we dualise a hypertteam \mathfrak{X} and, at the same time, swap the original interpretation $\alpha \in \{\exists\forall, \forall\exists\}$ of the player to $\bar{\alpha}$, we obtain that the pair $(\bar{\mathfrak{X}}, \bar{\alpha})$ gives an equivalent representation of the information contained in the original pair (\mathfrak{X}, α) .

Dualisation enjoys an *involution property* similar to the classic Boolean negation: by applying the dualisation twice, we obtain a hypertteam equivalent to the original one. This confirms that the operation preserves the entire information encoded in the hypertteams.

Lemma 1 (Dualisation I). *For all hypertteams $\mathfrak{X} \in \text{HASg}$, it holds that $\mathfrak{X} \equiv_W \bar{\bar{\mathfrak{X}}}$, for all $W \subseteq \text{Vr}$. In addition, $\mathfrak{X} \subseteq \bar{\bar{\mathfrak{X}}}$, if \mathfrak{X} is proper.*

The proof of this lemma, together with those of all the non-trivial results in the main paper, can be found in appendix.

Observe the clear analogy between the structure of hypertteams with alternation flag $\exists\forall$ (*resp.*, $\forall\exists$) and the structure of DNF (*resp.*, CNF) Boolean formulae,

where the dualisation swaps between two equivalent forms. The following lemma formally states that this operation swaps the role of the two players, while still preserving the original dependencies among their choices.

Lemma 2 (Dualisation II). *The following equivalences hold true, for all hyperteam $\mathfrak{X} \in \text{HAsg}$ and property $\Psi \subseteq \text{Asg}$.*

1) *Statements 1a and 1b are equivalent:*

- a) *there exists a team $X \in \mathfrak{X}$ (resp., $X \in \overline{\mathfrak{X}}$) such that $X \subseteq \Psi$;*
- b) *for all teams $X' \in \overline{\mathfrak{X}}$ (resp., $X' \in \mathfrak{X}$), it holds that $X' \cap \Psi \neq \emptyset$.*

2) *Statements 2a and 2b are equivalent:*

- a) *there exists a team $X \in \mathfrak{X}$ such that $X \cap \Psi \neq \emptyset$;*
- b) *there exists a team $X' \in \overline{\mathfrak{X}}$ such that $X' \cap \Psi \neq \emptyset$.*

3) *Statements 3a and 3b are equivalent:*

- a) *for all teams $X \in \mathfrak{X}$, it holds that $X \subseteq \Psi$;*
- b) *for all teams $X' \in \overline{\mathfrak{X}}$, it holds that $X' \subseteq \Psi$.*

Item 1 provides the semantic meaning of the operation, stating that if there exists a team in \mathfrak{X} all of whose assignments satisfy some property Ψ , then each team in $\overline{\mathfrak{X}}$ has an assignment satisfying the property, and *vice versa*. This directly connects the two interpretations of hyperteam, $\forall\exists$ and $\exists\forall$. Item 2 establishes that no assignment is lost from the original teams in \mathfrak{X} , while Item 3 asserts that no new assignments are added to $\overline{\mathfrak{X}}$. It could be proved that any two operators that satisfies the three conditions in the lemma will produce equivalent hyperteam, in the sense of \equiv_W , when applied to the same hyperteam.

Quantifications are taken care of by the *extension operator*. Let $\text{Fnc} \triangleq \text{Asg} \rightarrow \mathbb{A}$ be the set of functions that map assignments to a value in the domain \mathbb{A} of the structure \mathfrak{A} . Essentially, these objects play the role of the Skolem functions in Skolem semantics or, equivalently, of the strategies in game-theoretical semantics. To account for possible imperfect information, we need to ensure that these functions choose values uniformly on indistinguishable assignments. This constraint is captured by restricting the functions so that they must choose the same value for assignments that are indistinguishable *w.r.t.* some given set of variables W . Formally:

$$\text{Fnc}_W \triangleq \{F \in \text{Fnc} \mid \forall \chi \in \text{Asg}. F(\chi) = F(\chi \upharpoonright_W)\}.$$

Clearly, $\text{Fnc} = \text{Fnc}_{\llbracket +\text{Vr} \rrbracket} = \text{Fnc}_{\llbracket -\emptyset \rrbracket}$. The *extension of an assignment* $\chi \in \text{Asg}$ by a function $F \in \text{Fnc}$ for a variable $x \in \text{Vr}$ is defined as $\text{ext}(\chi, F, x) \triangleq \chi[x \mapsto F(\chi)]$, which extends χ with x by assigning to it the value $F(\chi)$ prescribed by the function F . The *extension operation* can then be lifted to teams $X \in \text{TAsg}$ in the obvious way, *i.e.*, by setting $\text{ext}(X, F, x) \triangleq \{\text{ext}(\chi, F, x) \mid \chi \in X\}$. This operation embeds into X the entire player strategy encoded by F . Finally, the

extension of a hyperteam $\mathfrak{X} \in \text{HAsg}$ with x is simply the set of extensions with x of all its teams by all possible functions:

$$\text{ext}_{\text{W}}(\mathfrak{X}, x) \triangleq \{\text{ext}(\text{X}, \text{F}, x) \mid \text{X} \in \mathfrak{X}, \text{F} \in \text{Fnc}_{\text{W}}\}.$$

The extension operation essentially embeds into \mathfrak{X} all possible (W-uniform) strategies for choosing the value of x , each one encoded by a function F in Fnc_{W} .

Example 4. Let $\mathfrak{X} = \{\text{X}_1 = \{\chi_1, \chi_2\}, \text{X}_2 = \{\chi_1, \chi_3\}\}$ be a hyperteam. To extend \emptyset -uniformly \mathfrak{X} with variable x over the structure domain $\text{A} = \{0, 1\}$, one needs to extend each team in \mathfrak{X} with the two \emptyset -uniform (i.e., constant) functions $\text{F}_0(\chi) = 0$ and $\text{F}_1(\chi) = 1$:

$$\text{ext}_{\emptyset}(\mathfrak{X}, x) = \left\{ \begin{array}{l} \text{ext}(\text{X}_1, \text{F}_0, x) = \{\chi_1[x \mapsto 0], \chi_2[x \mapsto 0]\} \\ \text{ext}(\text{X}_1, \text{F}_1, x) = \{\chi_1[x \mapsto 1], \chi_2[x \mapsto 1]\} \\ \text{ext}(\text{X}_2, \text{F}_0, x) = \{\chi_1[x \mapsto 0], \chi_3[x \mapsto 0]\} \\ \text{ext}(\text{X}_2, \text{F}_1, x) = \{\chi_1[x \mapsto 1], \chi_3[x \mapsto 1]\} \end{array} \right\}.$$

Conjunctions and disjunctions are dealt with by means of the *partition operator*. We provide here the intuition for disjunction, the dual reasoning applies to conjunction. Assume that the two players of \mathfrak{X} , defined over the variables $\{x, y\}$, are interpreted according to the alternation flag $\forall\exists$: Abelard chooses the team and Eloise chooses the assignment in the team. In our setting, then, in order to satisfy, e.g., $(x = 0) \vee (x = 1)$, Eloise has to show that, for each team $\text{X} \in \mathfrak{X}$ chosen by Abelard, she has a way to select one of the disjuncts $x = i$, with $i \in \{0, 1\}$, so that the given team has an assignment satisfying the disjunct. To capture Eloise's choice on which disjunct to choose based on the team given by Abelard, we define, for a hyperteam \mathfrak{X} , the following set

$$\text{par}(\mathfrak{X}) \triangleq \{(\mathfrak{X}_1, \mathfrak{X}_2) \in 2^{\mathfrak{X}} \times 2^{\mathfrak{X}} \mid \mathfrak{X}_1 \cap \mathfrak{X}_2 = \emptyset \wedge \mathfrak{X}_1 \cup \mathfrak{X}_2 = \mathfrak{X}\},$$

which collects all the possible bipartitions of \mathfrak{X} . Intuitively, the hyperteam \mathfrak{X}_1 will be used to satisfy $x = 0$, while \mathfrak{X}_2 will be used for $x = 1$. Basically, $\text{par}(\mathfrak{X})$ contains all the possible strategies by means of which Eloise can try to satisfy the two disjuncts. Then, we say that Eloise satisfies the disjunction if there is a pair $(\mathfrak{X}'_1, \mathfrak{X}'_2)$ (hence, a hyperteam-partition strategy) in that set such that \mathfrak{X}'_1 satisfies the left disjunct and \mathfrak{X}'_2 satisfies the right one.

The compositional semantics of ADIF can be, then, defined as follows, where \vec{x}^{χ} denotes the tuple of elements of the underlying structure \mathfrak{A} obtained by applying the assignment χ to the tuple of variables \vec{x} component-wise.

Definition 2 (ADIF Semantics). The Hodges' alternating semantic relation $\mathfrak{A}, \mathfrak{X} \models^{\alpha} \varphi$ for ADIF is inductively defined as follows, for all ADIF formulae φ , hypertteams $\mathfrak{X} \in \text{HAsg}_{\subseteq}(\text{sup}(\varphi))$, and alternation flags $\alpha \in \{\exists\forall, \forall\exists\}$:

- | | |
|---|--|
| 1) a) $\mathfrak{A}, \mathfrak{X} \models^{\exists\forall} \perp$ if $\emptyset \in \mathfrak{X}$; | b) $\mathfrak{A}, \mathfrak{X} \models^{\forall\exists} \perp$ if $\mathfrak{X} = \emptyset$; |
| 2) a) $\mathfrak{A}, \mathfrak{X} \models^{\forall\exists} \top$ if $\emptyset \notin \mathfrak{X}$; | b) $\mathfrak{A}, \mathfrak{X} \models^{\exists\forall} \top$ if $\mathfrak{X} \neq \emptyset$; |

- 3) a) $\mathfrak{A}, \mathfrak{X} \models^{\exists\forall} R(\vec{x})$ if there exists a team $X \in \mathfrak{X}$ such that, for all assignments $\chi \in X$, it holds that $\vec{x}^\chi \in R^{\mathfrak{A}}$;
 b) $\mathfrak{A}, \mathfrak{X} \models^{\forall\exists} R(\vec{x})$ if, for all teams $X \in \mathfrak{X}$, there exists an assignment $\chi \in X$ such that $\vec{x}^\chi \in R^{\mathfrak{A}}$;
- 4) $\mathfrak{A}, \mathfrak{X} \models^\alpha \neg\phi$ if $\mathfrak{A}, \mathfrak{X} \not\models^{\bar{\alpha}} \phi$;
- 5) a) $\mathfrak{A}, \mathfrak{X} \models^{\exists\forall} \phi_1 \wedge \phi_2$ if, for all bipartitions $(\mathfrak{X}_1, \mathfrak{X}_2) \in \text{par}(\mathfrak{X})$, it holds that $\mathfrak{A}, \mathfrak{X}_1 \models^{\exists\forall} \phi_1$ or $\mathfrak{A}, \mathfrak{X}_2 \models^{\exists\forall} \phi_2$;
 b) $\mathfrak{A}, \mathfrak{X} \models^{\forall\exists} \phi_1 \wedge \phi_2$ if $\mathfrak{A}, \bar{\mathfrak{X}} \models^{\exists\forall} \phi_1 \wedge \phi_2$;
- 6) a) $\mathfrak{A}, \mathfrak{X} \models^{\exists\forall} \phi_1 \vee \phi_2$ if $\mathfrak{A}, \bar{\mathfrak{X}} \models^{\forall\exists} \phi_1 \vee \phi_2$;
 b) $\mathfrak{A}, \mathfrak{X} \models^{\forall\exists} \phi_1 \vee \phi_2$ if there exists a bipartition $(\mathfrak{X}_1, \mathfrak{X}_2) \in \text{par}(\mathfrak{X})$ such that $\mathfrak{A}, \mathfrak{X}_1 \models^{\forall\exists} \phi_1$ and $\mathfrak{A}, \mathfrak{X}_2 \models^{\forall\exists} \phi_2$;
- 7) a) $\mathfrak{A}, \mathfrak{X} \models^{\exists\forall} \exists^{\pm w} x. \phi$ if $\mathfrak{A}, \text{ext}_{[\pm w]}(\mathfrak{X}, x) \models^{\exists\forall} \phi$;
 b) $\mathfrak{A}, \mathfrak{X} \models^{\forall\exists} \exists^{\pm w} x. \phi$ if $\mathfrak{A}, \bar{\mathfrak{X}} \models^{\exists\forall} \exists^{\pm w} x. \phi$;
- 8) a) $\mathfrak{A}, \mathfrak{X} \models^{\exists\forall} \forall^{\pm w} x. \phi$ if $\mathfrak{A}, \bar{\mathfrak{X}} \models^{\forall\exists} \forall^{\pm w} x. \phi$;
 b) $\mathfrak{A}, \mathfrak{X} \models^{\forall\exists} \forall^{\pm w} x. \phi$ if $\mathfrak{A}, \text{ext}_{[\pm w]}(\mathfrak{X}, x) \models^{\forall\exists} \phi$.

Items 1 and 2 take care of the Boolean constants, requiring, *e.g.*, \top to be satisfied by all hyperteams, except for the empty one, under the $\exists\forall$ interpretation, and the null one, under $\forall\exists$. A dual reasoning applies to \perp . The other base case for atomic formulae, Item 3, is trivial and follows the interpretation of the alternation flag. Negation, in accordance with the classic game-theoretic interpretation, is dealt with by Item 4 by exchanging the interpretation of the players of the hyperteam. The semantics of the remaining Boolean connectives (Items 5 and 6) and quantifiers (Items 7 and 8) is a direct application of the partition and extension operators previously defined. Observe that swapping between $\models^{\exists\forall}$ and $\models^{\forall\exists}$ (Items 5b, 6a, 7b and 8a) is done according to Lemma 2 and represents the fundamental point where our approach departs from Hodges' semantics (Hodges, 1997a,b).

For every ADIF formula φ and alternation flag $\alpha \in \{\exists\forall, \forall\exists\}$, we say that φ is α -satisfiable on \mathfrak{A} , in symbols $\mathfrak{A} \models^\alpha \varphi$, if there exists a proper hyperteam $\mathfrak{X} \in \text{HAsg}(\text{sup}(\varphi))$ such that $\mathfrak{A}, \mathfrak{X} \models^\alpha \varphi$. As already mentioned before, here we are not considering the empty and null hyperteams as potential hyperteams, since these do not convey meaningful information. We simply say that φ is α -satisfiable iff it is α -satisfiable on some structure \mathfrak{A} . Also, φ α -implies (resp., is α -equivalent to) an ADIF formula ϕ on \mathfrak{A} , in symbols $\varphi \Rightarrow_{\mathfrak{A}}^\alpha \phi$ (resp., $\varphi \equiv_{\mathfrak{A}}^\alpha \phi$), whenever $\mathfrak{A}, \mathfrak{X} \models^\alpha \varphi$ implies $\mathfrak{A}, \mathfrak{X} \models^\alpha \phi$ (resp., $\mathfrak{A}, \mathfrak{X} \models^\alpha \varphi$ iff $\mathfrak{A}, \mathfrak{X} \models^\alpha \phi$), for all $\mathfrak{X} \in \text{HAsg}_{\subseteq}(\text{sup}(\varphi) \cup \text{sup}(\phi))$. If the implication (resp., equivalence) holds for all structures \mathfrak{A} , we just state that φ α -implies (resp., is α -equivalent to) ϕ , in symbols $\varphi \Rightarrow^\alpha \phi$ (resp., $\varphi \equiv^\alpha \phi$). Finally, we say that φ is *satisfiable* if it is both $\exists\forall$ - and $\forall\exists$ -satisfiable, and φ *implies* (resp., is *equivalent to*) ϕ , in

symbols $\varphi \Rightarrow \phi$ (resp., $\varphi \equiv \phi$), if both $\varphi \Rightarrow^{\exists\forall} \phi$ and $\varphi \Rightarrow^{\forall\exists} \phi$ (resp., $\varphi \equiv^{\exists\forall} \phi$ and $\varphi \equiv^{\forall\exists} \phi$) hold true.

2.3. Examples

To familiarise with the proposed compositional semantics of ADIF, we now present few examples of evaluation of formulae via a step by step unravelling of all the semantic rules involved.

Example 5. Consider the sentence $\varphi_4 = \exists x. \forall^{+0} y. \neg \psi(x, y)$ from above, where we instantiate $\psi(x, y)$ as $(x = y)$. We evaluate φ_4 in the binary structure $\mathfrak{A} = \langle \{0, 1\}, =^{\mathfrak{A}} \rangle$ against the trivial hyperteam $\{\{\emptyset\}\}$. The alternation flag is of no consequence, since $\{\{\emptyset\}\}$ is self-dual (see Proposition 1), hence, we can choose $\alpha = \exists\forall$, without loss of generality. We want to check whether $\mathfrak{A}, \{\{\emptyset\}\} \models^{\exists\forall} \varphi_4$. The semantic rule for the existential quantifier $\exists x$ requires to compute the extension $\text{ext}_\emptyset(\{\{\emptyset\}\}, x)$ of $\{\{\emptyset\}\}$. This results in

$$\mathfrak{A}, \{\{\emptyset\}\} \models^{\exists\forall} \exists x. \forall^{+0} y. \neg(x = y) \quad \text{iff} \quad \mathfrak{A}, \mathfrak{X} \models^{\exists\forall} \forall^{+0} y. \neg(x = y),$$

where $\mathfrak{X} = \{\{x:0\}, \{x:1\}\}$. The rule for the universal quantifier $\forall^{+0} y$ requires to dualise the hyperteam and switch the flag to $\forall\exists$. Since every team of \mathfrak{X} is a singleton, there is only one possible choice function, thus, the result is

$$\mathfrak{A}, \mathfrak{X} \models^{\exists\forall} \forall^{+0} y. \neg(x = y) \quad \text{iff} \quad \mathfrak{A}, \overline{\mathfrak{X}} \models^{\forall\exists} \forall^{+0} y. \neg(x = y),$$

where $\overline{\mathfrak{X}} = \{\{x:0, x:1\}\}$. Now the quantifier $\forall^{+0} y$ and the alternation flag $\forall\exists$ are coherent, and we extend the hyperteam to obtain $\text{ext}_\emptyset(\overline{\mathfrak{X}}, y)$, where only constant functions can be used for the extensions, since y cannot depend on x . The result is, then,

$$\mathfrak{A}, \overline{\mathfrak{X}} \models^{\forall\exists} \forall^{+0} y. \neg(x = y) \quad \text{iff} \quad \mathfrak{A}, \text{ext}_\emptyset(\overline{\mathfrak{X}}, y) \models^{\forall\exists} \neg(x = y),$$

where $\text{ext}_\emptyset(\overline{\mathfrak{X}}, y) = \left\{ \left\{ \begin{array}{cc} x:0 & x:1 \\ y:0 & y:0 \end{array} \right\}, \left\{ \begin{array}{cc} x:0 & x:1 \\ y:1 & y:1 \end{array} \right\} \right\}$. The rule for the negation operation \neg dualises the flag and, in addition, requires the hyperteam $\text{ext}_\emptyset(\overline{\mathfrak{X}}, y)$ not to satisfy the atom $(x = y)$ under $\exists\forall$. This means that every team in $\text{ext}_\emptyset(\overline{\mathfrak{X}}, y)$ must contain an assignment that falsifies the atom. But this is indeed the case, since every team has an assignment χ such that $\chi(x) \neq \chi(y)$. Hence, φ_4 evaluates to true in \mathfrak{A} against $\{\{\emptyset\}\}$. Observe that, on the contrary, the sentence $\varphi_3 = \forall x. \exists^{+0} y. \psi(x, y)$ from above evaluates to false in \mathfrak{A} against $\{\{\emptyset\}\}$, being equivalent to the negation of φ_4 . Indeed, in this case, following the semantic rules for the quantifiers, we would still end up with the same hyperteam $\text{ext}_\emptyset(\overline{\mathfrak{X}}, y)$ against which we need to evaluate the matrix $x = y$. However, this time the alternation flag would be $\exists\forall$ and, as we already noted above, every team in $\text{ext}_\emptyset(\overline{\mathfrak{X}}, y)$ contains one assignment falsifying $x = y$.

Example 6. Consider the pseudo sentence $\varphi_6 = \exists x. \forall^{-x} y. \neg \psi(x, y)$ from above, where again we instantiate $\psi(x, y)$ as $(x = y)$. The exact same reasoning followed in Example 5 shows that φ_6 is true in \mathfrak{A} against the trivial hyperteam

$\{\{\emptyset\}\}$. Consequently, the pseudo sentence $\varphi_5 = \forall x. \exists^{-x} y. \psi(x, y)$ is false in \mathfrak{A} against $\{\{\emptyset\}\}$, being equivalent to the negation of φ_6 . These two pseudo sentences, however, are not equivalent to the sentences φ_4 and φ_3 , respectively. To see this, let us evaluate φ_5 in \mathfrak{A} against the hyperteam $\mathfrak{X} = \{\{z:0, z:1\}\}$ w.r.t. the alternation flag $\alpha = \forall\exists$. Note that $z \in \text{free}(\varphi_5) = \llbracket -x \rrbracket = \text{Vr} \setminus \{x\}$. The semantic rule for $\forall x$ requires to compute the extension $\text{ext}_\emptyset(\mathfrak{X}, x)$ of \mathfrak{X} . This results in

$$\mathfrak{A}, \mathfrak{X} \models^{\forall\exists} \forall x. \exists^{-x} y. (x = y) \quad \text{iff} \quad \mathfrak{A}, \text{ext}_\emptyset(\mathfrak{X}, x) \models^{\forall\exists} \exists^{-x} y. (x = y),$$

where $\text{ext}_\emptyset(\mathfrak{X}, x) = \left\{ \left\{ \begin{array}{l} z:0 \quad z:1 \\ x:0 \quad x:0 \end{array} \right\}, \left\{ \begin{array}{l} z:0 \quad z:1 \\ x:1 \quad x:1 \end{array} \right\} \right\}$. The rule for $\exists^{-x} y$ requires to dualise the hyperteam and switch the flag to $\exists\forall$. Since both teams in $\text{ext}_\emptyset(\mathfrak{X}, x)$ contains two assignments, there are four choice functions in total, leading to

$$\mathfrak{A}, \text{ext}_\emptyset(\mathfrak{X}, x) \models^{\forall\exists} \exists^{-x} y. (x = y) \quad \text{iff} \quad \mathfrak{A}, \overline{\text{ext}_\emptyset(\mathfrak{X}, x)} \models^{\exists\forall} \exists^{-x} y. (x = y), \text{ where}$$

$$\overline{\text{ext}_\emptyset(\mathfrak{X}, x)} = \left\{ \begin{array}{l} X_1 = \left\{ \begin{array}{l} z:0 \quad z:0 \\ x:0 \quad x:1 \end{array} \right\}, \quad X_2 = \left\{ \begin{array}{l} z:0 \quad z:1 \\ x:0 \quad x:1 \end{array} \right\}, \\ X_3 = \left\{ \begin{array}{l} z:1 \quad z:0 \\ x:0 \quad x:1 \end{array} \right\}, \quad X_4 = \left\{ \begin{array}{l} z:1 \quad z:1 \\ x:0 \quad x:1 \end{array} \right\} \end{array} \right\}.$$

The extension $\widehat{\mathfrak{X}} \triangleq \text{ext}_{\text{Vr} \setminus x}(\overline{\text{ext}_\emptyset(\mathfrak{X}, x)}, y) = \text{ext}_{\{z\}}(\overline{\text{ext}_\emptyset(\mathfrak{X}, x)}, y)$ with the four functions that can only depend on z , happens to contains 12 teams and cannot be displayed here. However, it should be easy to check that among these teams one can find $\mathbf{X} \triangleq \text{ext}(\mathbf{X}_2, \mathbf{F}, y) = \{\chi_1, \chi_2\}$, where $\chi_1(z) = \chi_1(x) = \chi_1(y) = 0$, $\chi_2(z) = \chi_2(x) = \chi_2(y) = 1$, and $\mathbf{F}(\chi) = \chi(z)$. Now, the final step requires checking whether $\mathfrak{A}, \widehat{\mathfrak{X}} \models^{\exists\forall} (x = y)$. Since every assignment in \mathbf{X} satisfies $(x = y)$, the pseudo sentence is proved true in \mathfrak{A} against \mathfrak{X} . As an immediate consequence, φ_6 evaluates to false in \mathfrak{A} against \mathfrak{X} . Instead, it is possible to show that the evaluations of φ_3 and φ_4 remain unchanged on \mathfrak{X} , i.e., they are again false and true, respectively, due to the fact that they are sentences (this is a direct consequence of Corollary 1, proved later on).

The above example should clarify the reasoning behind the choice of the name *pseudo sentences*, for those formulae φ with $\text{sup}(\varphi) = \emptyset$, but $\text{free}(\varphi) \neq \emptyset$. As for sentences, a pseudo sentence can be verified against an arbitrary hyperteam; however, similarly to formulae, its truth may depend on the specific hyperteam.

Example 7. Consider the sentence $\varphi_7 = \exists x. \forall^{+\emptyset} y. \exists^{+x} z. (\psi_1(x, y) \wedge \psi_2(y, z))$ from above, where we instantiate $\psi_1(x, y)$ as $(x = y)$ and $\psi_2(y, z)$ as $(y = z)$. We evaluate this sentence against the same structure \mathfrak{A} of the previous examples and the trivial hyperteam $\{\{\emptyset\}\}$. Observe also that φ_7 shares most of the quantifier prefix of sentence φ_4 in Example 5. As a consequence, by applying the same steps as before, we end up with the following equivalence:

$$\mathfrak{A}, \{\{\emptyset\}\} \models^{\exists\forall} \varphi_7 \quad \text{iff} \quad \mathfrak{A}, \text{ext}_\emptyset(\overline{\mathfrak{X}}, y) \models^{\forall\exists} \exists^{+x} z. (x = y) \wedge (y = z),$$

where $\text{ext}_\emptyset(\overline{\mathfrak{X}}, y) = \left\{ \left\{ \begin{array}{l} x:0 \ x:1 \\ y:0 \ , \ y:0 \end{array} \right\}, \left\{ \begin{array}{l} x:0 \ x:1 \\ y:1 \ , \ y:1 \end{array} \right\} \right\}$. Applying the rule for $\exists^{+x}z$ requires dualisation first, leading to

$$\mathfrak{A}, \{\{\emptyset\}\} \models^{\exists\forall} \varphi_7 \text{ iff } \mathfrak{A}, \overline{\text{ext}_\emptyset(\overline{\mathfrak{X}}, y)} \models^{\exists\forall} \exists^{+x}z. (x = y) \wedge (y = z), \text{ where}$$

$$\overline{\text{ext}_\emptyset(\overline{\mathfrak{X}}, y)} = \left\{ \begin{array}{l} X_1 = \left\{ \begin{array}{l} x:0 \ x:0 \\ y:0 \ , \ y:1 \end{array} \right\}, \quad X_2 = \left\{ \begin{array}{l} x:0 \ x:1 \\ y:0 \ , \ y:1 \end{array} \right\}, \\ X_3 = \left\{ \begin{array}{l} x:1 \ x:0 \\ y:0 \ , \ y:1 \end{array} \right\}, \quad X_4 = \left\{ \begin{array}{l} x:1 \ x:1 \\ y:0 \ , \ y:1 \end{array} \right\} \end{array} \right\}.$$

The extension $\widehat{\mathfrak{X}} \triangleq \text{ext}_{\{x\}}(\overline{\text{ext}_\emptyset(\overline{\mathfrak{X}}, y)}, z)$ can only use functions that depend on x alone and there are four of them. Similarly to the previous example, the hyperteam $\widehat{\mathfrak{X}}$ ends up containing 12 teams. Among these teams one can find $X \triangleq \text{ext}(X_2, F, z) = \{\chi_1, \chi_2\}$, where $\chi_1(x) = \chi_1(y) = \chi_1(z) = 0$, $\chi_2(x) = \chi_2(y) = \chi_2(z) = 1$, and $F(\chi) = \chi(x)$. Now, the final step requires checking whether $\mathfrak{A}, \widehat{\mathfrak{X}} \models^{\exists\forall} (x = y) \wedge (y = z)$. By the rule for the conjunction connective, this is true if $\mathfrak{A}, \widehat{\mathfrak{X}}_1 \models^{\exists\forall} (x = y)$ or $\mathfrak{A}, \widehat{\mathfrak{X}}_2 \models^{\exists\forall} (y = z)$, for all bipartitions $(\widehat{\mathfrak{X}}_1, \widehat{\mathfrak{X}}_2) \in \text{par}(\widehat{\mathfrak{X}})$. Obviously, any such partition would contain X either in $\widehat{\mathfrak{X}}_1$ or in $\widehat{\mathfrak{X}}_2$. Since every assignment in X satisfies both $(x = y)$ and $(y = z)$, the sentence is proved true in \mathfrak{A} against $\{\{\emptyset\}\}$.

2.4. Fundamentals

ADIF enjoys several classic properties, such as *Boolean laws* and the canonical representation for formulae in *negation normal form* (*nnf*, for short), that are usually expected to hold for a logic closed under negation.

We start with the following very basic result, characterising the truth of formulae over the null and empty hypertteams.

Lemma 3 (Empty & Null Hypertteams). *The following hold true for every ADIF formula φ and hypertteam $\mathfrak{X} \in \text{HAsg}_{\sqsubseteq}(\text{sup}(\varphi))$:*

- 1) a) $\mathfrak{A}, \emptyset \not\models^{\exists\forall} \varphi$; b) $\mathfrak{A}, \mathfrak{X} \models^{\exists\forall} \varphi$, where $\emptyset \in \mathfrak{X}$;
- 2) a) $\mathfrak{A}, \emptyset \models^{\forall\exists} \varphi$; b) $\mathfrak{A}, \mathfrak{X} \not\models^{\forall\exists} \varphi$, where $\emptyset \in \mathfrak{X}$.

The preorder \sqsubseteq on hypertteams introduced above captures the intuitive notion of satisfaction strength *w.r.t.* ADIF formulae. Basically, if $\mathfrak{X}_1 \sqsubseteq \mathfrak{X}_2$, the hyperteam \mathfrak{X}_1 satisfies, *w.r.t.* the $\exists\forall$ (*resp.*, $\forall\exists$) semantic relation, less (*resp.*, more) formulae than the hyperteam \mathfrak{X}_2 . Actually, a stronger version of this property holds, when the \sqsubseteq -preorder is restricted to the set of free variables of the formula. This property is trivial for atomic formulae and can easily be proved by structural induction for the non-atomic ones.

Theorem 1 (Hyperteam Refinement). *Let φ be an ADIF formula and $\mathfrak{X}, \mathfrak{X}' \in \text{HAsg}_{\sqsubseteq}(\text{sup}(\varphi))$ two hypertteams with $\mathfrak{X} \sqsubseteq_{\text{freed}(\varphi)} \mathfrak{X}'$. Then:*

- 1) if $\mathfrak{A}, \mathfrak{X} \models^{\exists\forall} \varphi$ then $\mathfrak{A}, \mathfrak{X}' \models^{\exists\forall} \varphi$;

2) if $\mathfrak{A}, \mathfrak{X}' \models^{\forall\exists} \varphi$ then $\mathfrak{A}, \mathfrak{X} \models^{\forall\exists} \varphi$.

As an immediate consequence, we obtain the following result.

Corollary 1 (Hyperteam Equivalence). *Let φ be an ADIF formula and $\mathfrak{X}, \mathfrak{X}' \in \text{HAsg}_{\subseteq}(\text{sup}(\varphi))$ two hyperteams with $\mathfrak{X} \equiv_{\text{free}(\varphi)} \mathfrak{X}'$. Then:*

$$\mathfrak{A}, \mathfrak{X} \models^{\alpha} \varphi \text{ iff } \mathfrak{A}, \mathfrak{X}' \models^{\alpha} \varphi.$$

Since, by definition, an ADIF sentence φ satisfies $\text{free}(\varphi) = \emptyset$, we can test its truth by just looking at its satisfaction *w.r.t.* the trivial hyperteam $\{\{\emptyset\}\}$, as every proper hyperteam is equivalent to $\{\{\emptyset\}\}$ on the empty set of variables. Recall that this property is, instead, not necessarily enjoyed by a pseudo sentence, as already observed in Example 6.

Corollary 2 (Sentence Satisfiability). *Let φ be an ADIF sentence. Then, φ is α -satisfiable iff $\mathfrak{A}, \{\{\emptyset\}\} \models^{\alpha} \varphi$, for some \mathcal{L} -structure \mathfrak{A} .*

As mentioned in Example 3, swapping the players of a hyperteam \mathfrak{X} , *i.e.*, switching the alternation flag, and swapping the choices of the players, *i.e.*, dualising \mathfrak{X} , have the same effect as far as satisfaction is concerned. Recall in addition that, by Lemma 1, the dualisation enjoys the involution property. Consequently, dualising both the alternation flag α and the hyperteam \mathfrak{X} preserves truth of formulae. These observations are formalised by the following result.

Theorem 2 (Double Dualisation). *For every ADIF formula φ and hyperteam $\mathfrak{X} \in \text{HAsg}_{\subseteq}(\text{sup}(\varphi))$, it holds that $\mathfrak{A}, \mathfrak{X} \models^{\alpha} \varphi$ iff $\mathfrak{A}, \overline{\mathfrak{X}} \models^{\alpha} \varphi$ iff $\mathfrak{A}, \overline{\mathfrak{X}} \models^{\overline{\alpha}} \varphi$.*

The above property also grants that formulae satisfaction, implication, and equivalence do not depend on the specific interpretation α of hyperteams: a positive answer for α implies the same for $\overline{\alpha}$. This *invariance* corresponds to the intuition that Eloise and Abelard both agree on the true and false formulae, as well on the concept of logical consequence and equivalence.

Corollary 3 (Interpretation Invariance). *Let φ and ϕ be ADIF formulae. Then, φ is $\exists\forall$ -satisfiable iff φ is $\forall\exists$ -satisfiable. Also, $\varphi \Rightarrow^{\exists\forall} \phi$ iff $\varphi \Rightarrow^{\forall\exists} \phi$ and $\varphi \equiv^{\exists\forall} \phi$ iff $\varphi \equiv^{\forall\exists} \phi$.*

Given the game-theoretic nature of hyperteams and negation, ADIF does not enjoy *logical determinacy*, *i.e.*, the property stating that a model either satisfies a formula or its negation, *w.r.t.* the same semantic relation. However, it satisfies the *game-theoretic determinacy* stated below, which corresponds to the following intuition: if a player cannot prove the truth of a formula, then the other player can prove the truth of its negation.

Corollary 4 (Game-Theoretic Determinacy). *Let φ be an ADIF formula and $\mathfrak{X} \in \text{HAsg}_{\subseteq}(\text{sup}(\varphi))$ a hyperteam. Then:*

1) either $\mathfrak{A}, \mathfrak{X} \models^{\alpha} \varphi$ or $\mathfrak{A}, \mathfrak{X} \models^{\overline{\alpha}} \neg\varphi$;

2) either $\mathfrak{A}, \mathfrak{X} \models^\alpha \varphi$ or $\mathfrak{A}, \overline{\mathfrak{X}} \models^\alpha \neg\varphi$.

Since, as observed before, the truth of sentences can be tested on the trivial hyperteam $\{\{\emptyset\}\}$, regardless of the specific alternation flag α , the classic *law of excluded middle* does hold for sentences. In the following, by $\mathfrak{A} \models \varphi$ we denote the fact that φ is both $\exists\forall$ -satisfiable and $\forall\exists$ -satisfiable on \mathfrak{A} .

Corollary 5 (Law of Excluded Middle). *Let φ be an ADIF sentence. Then, either $\mathfrak{A} \models \varphi$ or $\mathfrak{A} \models \neg\varphi$.*

Thanks to the above properties, we can establish the following elementary Boolean laws, which, in turn, allow for a canonical representation of formulae in *nmf*, as stated in Corollary 6.

Theorem 3 (Boolean Laws). *Let φ_1, φ_2 and φ be ADIF formulae. Then:*

- | | | |
|--|---|---------------------------------------|
| 1) a) $\neg\perp \equiv \top$; | b) $\neg\top \equiv \perp$; | c) $\varphi \equiv \neg\neg\varphi$; |
| 2) a) $\varphi \wedge \perp \equiv \perp \wedge \varphi \equiv \perp$; | b) $\varphi \wedge \top \equiv \top \wedge \varphi \equiv \varphi$; | |
| 3) a) $\varphi \vee \top \equiv \top \vee \varphi \equiv \top$; | b) $\varphi \vee \perp \equiv \perp \vee \varphi \equiv \varphi$; | |
| 4) a) $\varphi_1 \wedge \varphi_2 \equiv \varphi_2 \wedge \varphi_1$; | b) $\varphi_1 \vee \varphi_2 \equiv \varphi_2 \vee \varphi_1$; | |
| 5) a) $\varphi_1 \wedge \varphi_2 \Rightarrow \varphi_1$; | b) $\varphi_1 \wedge (\varphi \wedge \varphi_2) \equiv (\varphi_1 \wedge \varphi) \wedge \varphi_2$; | |
| 6) a) $\varphi_1 \Rightarrow \varphi_1 \vee \varphi_2$; | b) $\varphi_1 \vee (\varphi \vee \varphi_2) \equiv (\varphi_1 \vee \varphi) \vee \varphi_2$; | |
| 7) a) $\varphi_1 \wedge \varphi_2 \equiv \neg(\neg\varphi_1 \vee \neg\varphi_2)$; | b) $\varphi_1 \vee \varphi_2 \equiv \neg(\neg\varphi_1 \wedge \neg\varphi_2)$; | |
| 8) a) $\exists^{\pm w} x. \varphi \equiv \neg(\forall^{\pm w} x. \neg\varphi)$; | b) $\forall^{\pm w} x. \varphi \equiv \neg(\exists^{\pm w} x. \neg\varphi)$. | |

Corollary 6 (Negation Normal Form). *Every ADIF formula is equivalent to an ADIF formula in *nmf*.*

Currently, we do not know whether ADIF does enjoy a *prenex normal form* (*pnf*, for short). For this reason, in Sections 4 and 5, we shall mainly consider formulae that are already in *pnf*.

Open Problem 1 (ADIF Prenex Normal Form). *Is every ADIF formula equivalent to an ADIF formula in *pnf*?*

For technical convenience, we shall now generalise the extension operator to (finite) quantifier prefixes \wp , whose set is denoted by Qn . Notice that, *w.l.o.g.*, we only consider prefixes where each variable x (i) is quantified at most once, (ii) does not occur in the dependence/independence constraint set $\llbracket \pm W \rrbracket$ of its quantifier $\mathbf{Q}^{\pm W}x$, and (iii) cannot be quantified in the scope of a quantifier $\mathbf{Q}^{\pm W}y$ whose dependence/independence constraint set $\llbracket \pm W \rrbracket$ includes x itself. By $\text{vr}(\wp)$ and $\text{dep}(\wp)$ we denote the set of variables quantified in \wp and the union of all dependence/independence constraint sets occurring in \wp , respectively. Given a hyperteam \mathfrak{X} and an alternation flag α , the operator $\text{ext}_\alpha(\mathfrak{X}, \wp)$ corresponds to

iteratively applying the extension operator to \mathfrak{X} , for all quantifiers occurring in \wp , in that specific order. To this end, we first introduce the notion of *coherence* of a quantifier symbol $Q \in \{\exists, \forall\}$ with an alternation flag $\alpha \in \{\exists\forall, \forall\exists\}$ as follows: Q is α -*coherent* if either $\alpha = \exists\forall$ and $Q = \exists$ or $\alpha = \forall\exists$ and $Q = \forall$. Now, the application of a quantifier $Q^{\pm w}x$ to \mathfrak{X} , denoted by $\text{ext}_\alpha(\mathfrak{X}, Q^{\pm w}x)$, follows the semantics of quantifiers, as defined in Items 7 and 8 of Definition 2. More precisely, it just corresponds to the extension of \mathfrak{X} with x , when Q is α -coherent. Conversely, when Q is $\bar{\alpha}$ -coherent, we need to dualise the extension with x of the dual of \mathfrak{X} . Formally:

$$\text{ext}_\alpha(\mathfrak{X}, Q^{\pm w}x) \triangleq \begin{cases} \text{ext}_{[\pm w]}(\mathfrak{X}, x), & \text{if } Q \text{ is } \alpha\text{-coherent;} \\ \overline{\text{ext}_{[\pm w]}(\overline{\mathfrak{X}}, x)}, & \text{otherwise.} \end{cases}$$

The operator naturally lifts to arbitrary quantification prefixes \wp : 1) $\text{ext}_\alpha(\mathfrak{X}, \epsilon) \triangleq \mathfrak{X}$; 2) $\text{ext}_\alpha(\mathfrak{X}, Q^{\pm w}x. \wp) \triangleq \text{ext}_\alpha(\text{ext}_\alpha(\mathfrak{X}, Q^{\pm w}x), \wp)$. We also define $\text{ext}_\alpha(\wp) \triangleq \text{ext}_\alpha(\{\{\emptyset\}\}, \wp)$. A simple structural induction on a quantifier prefix $\wp \in \text{Qn}$, shows that a hyperteam \mathfrak{X} α -satisfies a formula $\wp\phi$ iff its α -extension *w.r.t.* \wp α -satisfies its matrix ϕ .

Theorem 4 (Prefix Extension). *Let $\wp\phi$ be an ADIF formula, where $\wp \in \text{Qn}$ is a quantifier prefix and ϕ is an arbitrary ADIF formula. Then, $\mathfrak{A}, \mathfrak{X} \models^\alpha \wp\phi$ iff $\mathfrak{A}, \text{ext}_\alpha(\mathfrak{X}, \wp) \models^\alpha \phi$, for all hyperteam $\mathfrak{X} \in \text{HAsg}_{\subseteq}(\text{sup}(\wp\phi))$.*

3. Adequacy

In this section, we show that Hodges' alternating semantics based on hyperteam is *adequate*, *i.e.*, it is a *conservative extension*, precisely capturing both Tarski's satisfaction for FOL and Hodges' semantics of IF (see Definitions 3 and 4 for an equivalent syntactic variant of IF), when restricted to the corresponding fragments, as formally stated in Theorems 5 and 6 below.

3.1. First-Order Logic

We can now prove that, when focusing on the FOL fragment of ADIF, as defined in Section 2.1, the satisfaction relation of Definition 2 corresponds to the classic Tarskian satisfaction. This FOL *adequacy* property holds trivially for atomic formulae and, in order to extend it to the remaining FOL components, we make use of the following three lemmata, which take care of dualisation, quantifiers, and binary Boolean connectives, respectively.

As extensively discussed before, the dualisation swaps the role of the two players, while still preserving the original dependencies among their choices. Indeed, if a FOL property is satisfied by a hyperteam *w.r.t.* a given alternation flag, it is satisfied by its dual version *w.r.t.* the dual flag, as formally stated in the lemma below.

Lemma 4 (FOL Dualisation). *The following equivalences hold, for all FOL formulae φ and hyperteam $\mathfrak{X} \in \text{HAsg}_{\subseteq}(\text{sup}(\varphi))$.*

- 1) Statements 1a and 1b are equivalent:
- a) there exists a team $X \in \mathfrak{X}$ such that $\mathfrak{A}, \chi \models_{\text{FOL}} \varphi$, for all assignments $\chi \in X$;
 - b) for all teams $X \in \overline{\mathfrak{X}}$, there exists an assignment $\chi \in X$ such that $\mathfrak{A}, \chi \models_{\text{FOL}} \varphi$.
- 2) Statements 2a and 2b are equivalent:
- a) for all teams $X \in \mathfrak{X}$, there exists an assignment $\chi \in X$ such that $\mathfrak{A}, \chi \models_{\text{FOL}} \varphi$;
 - b) there exists a team $X \in \overline{\mathfrak{X}}$ such that $\mathfrak{A}, \chi \models_{\text{FOL}} \varphi$, for all assignments $\chi \in X$.

The following lemma states that the extension operator provides an adequate semantics for classic FOL quantifications, when applied to all support variables. Statement 1 considers Eloise's choices, when the interpretation of the hyperteam is $\exists\forall$, while Statement 2 takes care of Abelard's choices, when the interpretation is the dual $\forall\exists$.

Lemma 5 (FOL Quantifiers). *The following equivalences hold, for all FOL formulae φ , variables $x \in \text{Vr}$, and hyperteam $\mathfrak{X} \in \text{HASg}_{\subseteq}(\text{V})$ with $\text{V} \triangleq \text{sup}(\varphi) \setminus \{x\}$.*

- 1) Statements 1a and 1b are equivalent:
- a) there exists a team $X \in \mathfrak{X}$ such that $\mathfrak{A}, \chi \models_{\text{FOL}} \exists x. \varphi$, for all $\chi \in X$;
 - b) there exists a team $X \in \text{ext}_{\text{V}}(\mathfrak{X}, x)$ such that $\mathfrak{A}, \chi \models_{\text{FOL}} \varphi$, for all $\chi \in X$.
- 2) Statements 2a and 2b are equivalent:
- a) for all teams $X \in \mathfrak{X}$, there exists $\chi \in X$ such that $\mathfrak{A}, \chi \models_{\text{FOL}} \forall x. \varphi$;
 - b) for all teams $X \in \text{ext}_{\text{V}}(\mathfrak{X}, x)$, there exists $\chi \in X$ such that $\mathfrak{A}, \chi \models_{\text{FOL}} \varphi$.

Finally, the partition operator precisely mimics the semantics of the binary Boolean connectives when the corrected interpretation of the underlying hyperteam is considered.

Lemma 6 (FOL Boolean Connectives). *The following equivalences hold, for all FOL formulae φ_1 and φ_2 and hyperteam $\mathfrak{X} \in \text{HASg}_{\subseteq}(\text{V})$ with $\text{V} \triangleq \text{sup}(\varphi_1) \cup \text{sup}(\varphi_2)$.*

- 1) Statements 1a and 1b are equivalent:
- a) there exists a team $X \in \mathfrak{X}$ such that $\mathfrak{A}, \chi \models_{\text{FOL}} \varphi_1 \wedge \varphi_2$, for all $\chi \in X$;
 - b) for each bipartition $(\mathfrak{X}_1, \mathfrak{X}_2) \in \text{par}(\mathfrak{X})$, there exist an index $i \in \{1, 2\}$ and a team $X \in \mathfrak{X}_i$ such that $\mathfrak{A}, \chi \models_{\text{FOL}} \varphi_i$, for all $\chi \in X$.
- 2) Statements 2a and 2b are equivalent:

- a) for all teams $X \in \mathfrak{X}$, there exists $\chi \in X$ such that $\mathfrak{A}, \chi \models_{\text{FOL}} \varphi_1 \vee \varphi_2$;
- b) there exists a bipartition $(\mathfrak{X}_1, \mathfrak{X}_2) \in \text{par}(\mathfrak{X})$ such that, for all indexes $i \in \{1, 2\}$ and teams $X \in \mathfrak{X}_i$, it holds that $\mathfrak{A}, \chi \models_{\text{FOL}} \varphi_i$, for some $\chi \in X$.

We can now state the FOL adequacy property for ADIF.

Theorem 5 (FOL Adequacy). *For all FOL formulae φ and hyperteams $\mathfrak{X} \in \text{HAsg}_{\subseteq}(\text{sup}(\varphi))$, it holds that:*

- 1) $\mathfrak{A}, \mathfrak{X} \models^{\exists\forall} \varphi$ iff there exists a team $X \in \mathfrak{X}$ such that, for all assignments $\chi \in X$, it holds that $\mathfrak{A}, \chi \models_{\text{FOL}} \varphi$;
- 2) $\mathfrak{A}, \mathfrak{X} \models^{\forall\exists} \varphi$ iff, for all teams $X \in \mathfrak{X}$, there exists an assignment $\chi \in X$ such that $\mathfrak{A}, \chi \models_{\text{FOL}} \varphi$.

3.2. Dependence/Independence-Friendly Logic

Dependence/Independence-Friendly Logic (Väänänen, 2007; Hintikka and Sandu, 1989) can be viewed as a (syntactic variant of a) fragment of ADIF, where i) negation can only occur in front of atoms and ii) just one kind of quantifier can be restricted, depending on a flag $\beta \in \{\forall, \exists\}$.

Definition 3 (DIF Syntax). *The \exists/\forall -Dependence/Independence-Friendly Logic (\exists/\forall -DIF, for short) is the set of formulae built according to the following grammar, where $R \in \mathcal{R}$, $\vec{x} \in \text{Vr}^{\text{ar}(R)}$, $x \in \text{Vr}$, and $W \subseteq \text{Vr}$ with $|W| < \omega$:*

$$\exists\text{-DIF} \quad \varphi := R(\vec{x}) \mid \neg R(\vec{x}) \mid \varphi \wedge \varphi \mid \varphi \vee \varphi \mid \exists^{\pm w} x. \varphi \mid \forall^{-\emptyset} x. \varphi.$$

$$\forall\text{-DIF} \quad \varphi := R(\vec{x}) \mid \neg R(\vec{x}) \mid \varphi \wedge \varphi \mid \varphi \vee \varphi \mid \exists^{-\emptyset} x. \varphi \mid \forall^{\pm w} x. \varphi.$$

Hodges' semantics of DIF formulae is defined on teams. There are two types of semantics rules, one for each flag $\beta \in \{\exists, \forall\}$, which are dual of one another. The \forall -semantics is the classic one reported in Hodges (1997a), also denoted as '+'-semantics in Mann et al. (2011), while the \exists -semantics corresponds to the negation of the '-'-semantics. Before recalling the definitions of these two semantics, we need to provide two additional operators. For the Boolean connectives, we define a partition operation for teams as follows: $\text{par}(X) \triangleq \{(X_1, X_2) \in 2^X \times 2^X \mid X_1 \cap X_2 = \emptyset \wedge X_1 \cup X_2 = X\}$. The rule for quantifier uses the extension operator ext , when the quantifier is not coherent with the flag β . When the quantifier is coherent, instead, the semantics requires a *cylindrification* operator on teams. Intuitively, the cylindrification of a team X w.r.t. some variable x extends each of its assignments with every possible value for x . Formally, $\text{cyl}(X, x) \triangleq \{\chi[x \mapsto a] \mid \chi \in X, a \in A\}$.

Definition 4 (DIF Semantics). *The Hodges' semantic relation $\mathfrak{A}, X \models_{\text{DIF}}^{\beta} \varphi$ for $\overline{\beta}$ -DIF is inductively defined as follows, for all $\overline{\beta}$ -DIF formulae φ and teams $X \subseteq \text{Asg}_{\subseteq}(\text{free}(\varphi))$, with $\beta, \overline{\beta} \in \{\exists, \forall\}$ and $\beta \neq \overline{\beta}$:*

- 1) a) $\mathfrak{A}, X \models_{\text{DIF}}^{\forall} R(\vec{x})$ if, for all $\chi \in X$, it holds that $\vec{x}^{\chi} \in R^{\mathfrak{A}}$;

- b) $\mathfrak{A}, X \models_{\text{DIF}}^{\forall} \neg R(\vec{x})$ if, for all $\chi \in X$, it holds that $\vec{x}^\chi \notin R^{\mathfrak{A}}$;
- c) $\mathfrak{A}, X \models_{\text{DIF}}^{\forall} \varphi_1 \wedge \varphi_2$ if $\mathfrak{A}, X \models_{\text{DIF}}^{\forall} \varphi_1$ and $\mathfrak{A}, X \models_{\text{DIF}}^{\forall} \varphi_2$;
- d) $\mathfrak{A}, X \models_{\text{DIF}}^{\forall} \varphi_1 \vee \varphi_2$ if $\mathfrak{A}, X_1 \models_{\text{DIF}}^{\forall} \varphi_1$ and $\mathfrak{A}, X_2 \models_{\text{DIF}}^{\forall} \varphi_2$, for some bipartition $(X_1, X_2) \in \text{par}(X)$;
- e) $\mathfrak{A}, X \models_{\text{DIF}}^{\forall} \exists^{\pm w} x. \varphi$ if $\mathfrak{A}, \text{ext}(X, F, x) \models_{\text{DIF}}^{\forall} \varphi$, for some $F \in \text{Fnc}_{[\pm W]}$;
- f) $\mathfrak{A}, X \models_{\text{DIF}}^{\forall} \forall^{-\emptyset} x. \varphi$ if $\mathfrak{A}, \text{cyl}(X, x) \models_{\text{DIF}}^{\forall} \varphi$;
- 2) a) $\mathfrak{A}, X \models_{\text{DIF}}^{\exists} R(\vec{x})$ if there exists $\chi \in X$ such that $\vec{x}^\chi \in R^{\mathfrak{A}}$;
- b) $\mathfrak{A}, X \models_{\text{DIF}}^{\exists} \neg R(\vec{x})$ if there exists $\chi \in X$ such that $\vec{x}^\chi \notin R^{\mathfrak{A}}$;
- c) $\mathfrak{A}, X \models_{\text{DIF}}^{\exists} \varphi_1 \wedge \varphi_2$ if $\mathfrak{A}, X_1 \models_{\text{DIF}}^{\exists} \varphi_1$ or $\mathfrak{A}, X_2 \models_{\text{DIF}}^{\exists} \varphi_2$, for all bipartitions $(X_1, X_2) \in \text{par}(X)$;
- d) $\mathfrak{A}, X \models_{\text{DIF}}^{\exists} \varphi_1 \vee \varphi_2$ if $\mathfrak{A}, X \models_{\text{DIF}}^{\exists} \varphi_1$ or $\mathfrak{A}, X \models_{\text{DIF}}^{\exists} \varphi_2$;
- e) $\mathfrak{A}, X \models_{\text{DIF}}^{\exists} \exists^{-\emptyset} x. \varphi$ if $\mathfrak{A}, \text{cyl}(X, x) \models_{\text{DIF}}^{\exists} \varphi$;
- f) $\mathfrak{A}, X \models_{\text{DIF}}^{\exists} \forall^{\pm w} x. \varphi$ if $\mathfrak{A}, \text{ext}(X, F, x) \models_{\text{DIF}}^{\exists} \varphi$, for all $F \in \text{Fnc}_{[\pm W]}$.

In order to show that ADIF is indeed a conservative extension of DIF, we need to be able to simulate the semantics on teams with the one on hypertteams. As a first step, we lift the cylindrification operator to hypertteams in the obvious way, by defining $\text{cyl}(\mathfrak{X}, x) \triangleq \{\text{cyl}(X, x) \mid X \in \mathfrak{X}\}$. While the semantics of ADIF does not provide a primitive operator for cylindrification, this operation is easily simulated by first dualising the hypertteam, then by applying the extension for x uniformly over all the variables in the domain of \mathfrak{X} , and, finally dualising the result again. The following lemma establishes the equivalence of these two different operations.

Lemma 7 (Cylindrical Extension). *Let $\mathfrak{X} \in \text{HAsg}$ be a hypertteam. Then, $\text{cyl}(\mathfrak{X}, x) \equiv \text{ext}_W(\overline{\mathfrak{X}}, x)$, for all variables $x \in \text{Vr}$ and sets of variables W , with $\text{vr}(\mathfrak{X}) \subseteq W \subseteq \text{Vr}$.*

A similar problem arises with the team partitioning operator that is not present in the semantics of ADIF. Once again, the dualisation operator, together with the hypertteam partitioning operator, allows for simulating it. More specifically, we first apply the dualisation to the hypertteam \mathfrak{X} , then the partitioning to obtain $(\mathfrak{X}_1, \mathfrak{X}_2) \in \text{par}(\overline{\mathfrak{X}})$, and finally dualise again the two resulting hypertteam and obtain $\overline{\mathfrak{X}}_1$ and $\overline{\mathfrak{X}}_2$, each of which happens to contain teams that would result from the team partitioning operator applied to teams in \mathfrak{X} .

Lemma 8 (Team Partitioning). *Let $\mathfrak{X} \in \text{HAsg}$ be a hypertteam. Then:*

- 1) *for all hypertteam bipartitions $(\mathfrak{X}_1, \mathfrak{X}_2) \in \text{par}(\overline{\mathfrak{X}})$ and teams $Y_1 \in \overline{\mathfrak{X}}_1$ and $Y_2 \in \overline{\mathfrak{X}}_2$, there exists a team $X \in \mathfrak{X}$ such that $X \subseteq Y_1 \cup Y_2$;*

- 2) for all teams $X \in \mathfrak{X}$ and team bipartitions $(X_1, X_2) \in \text{par}(X)$, there exist a hyperteam bipartition $(\mathfrak{X}_1, \mathfrak{X}_2) \in \text{par}(\overline{\mathfrak{X}})$ and two teams $Y_1 \in \overline{\mathfrak{X}}_1$ and $Y_2 \in \overline{\mathfrak{X}}_2$ such that $Y_1 \subseteq X_1$ and $Y_2 \subseteq X_2$.

Based on these two lemmata, one can prove the following theorem, which establishes the required adequacy result.

Theorem 6 (DIF Adequacy). *For all \exists/\forall -DIF formulae $\varphi^\exists/\varphi^\forall$ and hyperteam $\mathfrak{X} \in \text{HASg}_{\subseteq}(\text{sup}(\varphi^\exists/\varphi^\forall))$, it holds that:*

- 1) $\mathfrak{A}, \mathfrak{X} \models^{\exists^\forall} \varphi^\exists$ iff there exists a team $X \in \mathfrak{X}$ such that $\mathfrak{A}, X \models_{\text{DIF}}^{\forall} \varphi^\exists$;
- 2) $\mathfrak{A}, \mathfrak{X} \models^{\forall^\exists} \varphi^\forall$ iff, for all teams $X \in \mathfrak{X}$, it holds that $\mathfrak{A}, X \models_{\text{DIF}}^{\exists} \varphi^\forall$.

Example 8. In Example 5, it has been observed that the two ADIF sentences $\varphi_3 = \forall x. \exists^{+\emptyset} y. (x = y)$ and $\varphi_4 = \exists x. \forall^{+\emptyset} y. \neg(x = y)$ evaluate to false and true, respectively, in the binary structure $\mathfrak{A} = \langle \{0, 1\}, =^{\mathfrak{A}} \rangle$ against the trivial hyperteam $\{\{\emptyset\}\}$. We also claimed that they are the semantic negation of each other, something that now can be easily proved thanks to Corollary 5 and Theorem 3. Notice now that all these properties hold true for the two \exists -DIF and \forall -DIF sentences $\varphi'_3 = \forall^{-\emptyset} x. \exists^{+\emptyset} y. (x = y)$ and $\varphi'_4 = \exists^{-\emptyset} x. \forall^{+\emptyset} y. \neg(x = y)$. At this point, we can show that the truth and falsity of φ'_3 and φ'_4 convey different meanings when evaluated in IF (equivalently, DIF). First, recall that, Hodges (1997a) (see also Mann et al. (2011)) defines an IF sentence φ to be true in \mathfrak{A} , if $\mathfrak{A}, \{\emptyset\} \models^+ \varphi$, and false on \mathfrak{A} , if $\mathfrak{A}, \{\emptyset\} \models^- \varphi$. As observed above, this means that φ is true in \mathfrak{A} , if $\mathfrak{A}, \{\emptyset\} \models_{\text{DIF}}^{\forall} \varphi_{\exists}$, and false in \mathfrak{A} , if $\mathfrak{A}, \{\emptyset\} \not\models_{\text{DIF}}^{\exists} \varphi_{\forall}$, where φ_{\exists} and φ_{\forall} are the \exists -DIF and \forall -DIF sentences obtained from φ by substituting $-\emptyset$ for the restrictions of the universal and existential quantifiers, respectively. Now, both φ'_3 and φ'_4 are IF sentences. Moreover, as stated above, φ'_3 is an \exists -DIF sentence, while φ'_4 is a \forall -DIF sentence. Thus, due to Theorem 6, we immediately obtain $\mathfrak{A}, \{\emptyset\} \not\models_{\text{DIF}}^{\forall} \varphi'_3$ and $\mathfrak{A}, \{\emptyset\} \models_{\text{DIF}}^{\exists} \varphi'_4$, since $\mathfrak{A}, \{\{\emptyset\}\} \not\models \varphi'_3$ and $\mathfrak{A}, \{\{\emptyset\}\} \models \varphi'_4$. As a consequence, when evaluated in IF, φ'_3 is not true and φ'_4 is not false. However, φ'_3 is not false and φ'_4 is not true either, which implies that the two sentences are undetermined. Indeed, $\mathfrak{A}, \{\emptyset\} \models_{\text{DIF}}^{\exists} \varphi'_{3\forall}$ and $\mathfrak{A}, \{\emptyset\} \not\models_{\text{DIF}}^{\forall} \varphi'_{4\exists}$, where $\varphi'_{3\forall} = \forall^{-\emptyset} x. \exists^{-\emptyset} y. (x = y)$ and $\varphi'_{4\exists} = \exists^{-\emptyset} x. \forall^{-\emptyset} y. \neg(x = y)$, since $\mathfrak{A}, \{\{\emptyset\}\} \models \varphi'_{3\forall}$ and $\mathfrak{A}, \{\{\emptyset\}\} \not\models \varphi'_{4\exists}$.

4. Meta Theory

We now introduce a *meta-level interpretation* of the quantifiers by means of a Herbrand-Skolem semantics extending the compositional one based on hyperteam, which results to be essential for 1) the solution of the *model-checking problem*, 2) the proof that ADIF covers the entire *polynomial hierarchy*, by means of an encoding of *Second-Order Logic* (SOL, for short) (Hilbert and Ackermann, 1938; Church, 1956; Shapiro, 1991) and *Team Logic* (TL, for short) (Väänänen, 2007), and 3) the adequacy of the *game-theoretic semantics* presented in Section 5.

4.1. Meta Extension

The game-theoretic interpretation of the quantifiers $\exists^{\pm w}x$ and $\forall^{\pm w}x$ implicitly identifies strategies for Eloise and Abelard satisfying the $\llbracket \pm W \rrbracket$ -uniformity constraint. The *meta extension* of ADIF we propose here makes these strategies explicit, by augmenting the logic with the two quantifiers, $\Sigma^{\pm w}x$ and $\Pi^{\pm w}x$, ranging over $\llbracket \pm W \rrbracket$ -uniform Herbrand/Skolem functions (Buss, 1998). Intuitively, $\Sigma^{\pm w}x. \varphi$ ensures the existence of a $\llbracket \pm W \rrbracket$ -uniform Skolem function assigning values to x that satisfies φ , while $\Pi^{\pm w}x. \varphi$ verifies φ , for all values assigned to x by some $\llbracket \pm W \rrbracket$ -uniform Herbrand function.

Definition 5 (META-ADIF Syntax). *The ADIF Meta Extension (META-ADIF, for short) is the set of formulae built according to Definition 1 extended as follows, where $x \in \text{Vr}$ and $W \subseteq \text{Vr}$ with $|W| < \omega$:*

$$\varphi := \text{ADIF} \mid \Sigma^{\pm w}x. \varphi \mid \Pi^{\pm w}x. \varphi.$$

The set of *support variables* $\text{sup}(\varphi)$ of a META-ADIF formula φ is defined as in ADIF, with the additional two simple cases $\text{sup}(\text{Q}^{\pm w}x. \varphi) \triangleq \text{sup}(\varphi) \setminus \{x\}$, for $\text{Q} \in \{\Sigma, \Pi\}$. The definition of free variables is, instead, quite more intricate and requires the introduction of the following supplemental functions of *free variables under (meta) dependency context* $\text{free}: \text{META-ADIF} \times (\text{Vr} \rightarrow 2^{\text{Vr}}) \rightarrow 2^{\text{Vr}}$ and *dependence variables under (meta) dependency context* $\text{dep}: \text{META-ADIF} \times (\text{Vr} \rightarrow 2^{\text{Vr}}) \rightarrow 2^{\text{Vr}}$, where by *dependency context* we mean any partial function $\iota \in \text{Vr} \rightarrow 2^{\text{Vr}}$. The *transitive closure* of ι is a dependency context $\iota^* \in \text{dom}(\iota) \rightarrow 2^{\text{Vr}}$ such that, for each variable $x \in \text{dom}(\iota)$ in its domain, $\iota^*(x)$ is the smallest set of variables such that (a) $\iota(x) \subseteq \iota^*(x)$ and (b) $\iota(y) \subseteq \iota^*(x)$, for all variables $y \in \iota^*(x) \cap \text{dom}(\iota)$. Finally, ι is *acyclic* if $x \notin \iota^*(x)$, for all variables $x \in \text{dom}(\iota)$. The functions free and dep can be defined in a mutual recursive fashion as follows.

- $\text{free}(\perp, \iota), \text{free}(\top, \iota) \triangleq \emptyset$;
- $\text{free}(R(\vec{x}), \iota) \triangleq \vec{x} \cup \bigcup \{\iota^*(x) \mid x \in \vec{x} \cap \text{dom}(\iota)\}$;
- $\text{free}(\neg \varphi, \iota) \triangleq \text{free}(\varphi, \iota)$;
- $\text{free}(\varphi_1 \odot \varphi_2, \iota) \triangleq \text{free}(\varphi_1, \iota) \cup \text{free}(\varphi_2, \iota)$, for $\odot \in \{\wedge, \vee\}$;
- $\text{free}(\text{Q}^{\pm w}x. \varphi, \iota) \triangleq (\text{free}(\varphi, \iota') \setminus \{x\}) \cup \llbracket \pm W \rrbracket$, if $x \in \text{free}(\varphi, \iota')$, and $\text{free}(\text{Q}^{\pm w}x. \varphi, \iota) \triangleq \text{free}(\varphi, \iota')$, otherwise, where $\iota' \triangleq \iota \setminus \{x\}$, for $\text{Q} \in \{\exists, \forall\}$;
- $\text{free}(\text{Q}^{\pm w}x. \varphi, \iota) \triangleq \text{free}(\varphi, \iota')$, if $x \in \text{dep}(\varphi, \iota')$, and $\text{free}(\text{Q}^{\pm w}x. \varphi, \iota) \triangleq \text{free}(\varphi, \iota') \setminus \{x\}$, otherwise, where $\iota' \triangleq \iota[x \mapsto \llbracket \pm W \rrbracket]$, for $\text{Q} \in \{\Sigma, \Pi\}$.

Intuitively, a variable y can be free in a META-ADIF formula φ under a dependency context ι for one (or more) of the following three reasons (always outside the scope of a quantifier for y that masks it): (i) it is explicitly used in some relational symbol; (ii) it occurs in the (transitive) dependency set $\iota^*(x)$ of some

meta quantified variable x used in a relational symbol; (iii) it appears in the dependence/independence constraint set $\llbracket \pm W \rrbracket$ of some first-order quantifier $Q^{\pm w}x$ of a free variable x . Notice that a meta quantifier of a variable x masks such a variable only if it does not appear in the set of (first-order) dependence variables of its matrix.

- $\text{dep}(\perp, \iota), \text{dep}(\top, \iota), \text{dep}(R(\vec{x}), \iota) \triangleq \emptyset$;
- $\text{dep}(\neg \varphi, \iota) \triangleq \text{dep}(\varphi, \iota)$;
- $\text{dep}(\varphi_1 \odot \varphi_2, \iota) \triangleq \text{dep}(\varphi_1, \iota) \cup \text{dep}(\varphi_2, \iota)$, for $\odot \in \{\wedge, \vee\}$;
- $\text{dep}(Q^{\pm w}x. \varphi, \iota) \triangleq (\text{dep}(\varphi, \iota') \setminus \{x\}) \cup \llbracket \pm W \rrbracket$, if $x \in \text{free}(\varphi, \iota')$, and $\text{dep}(Q^{\pm w}x. \varphi, \iota) \triangleq \text{dep}(\varphi, \iota')$, otherwise, where $\iota' \triangleq \iota \setminus \{x\}$, for $Q \in \{\exists, \forall\}$;
- $\text{dep}(Q^{\pm w}x. \varphi, \iota) \triangleq \text{dep}(\varphi, \iota')$, where $\iota' \triangleq \iota[x \mapsto \llbracket \pm W \rrbracket]$, for $Q \in \{\Sigma, \Pi\}$.

Intuitively, a variable y belongs to the set $\text{dep}(\varphi, \iota)$ if it appears in the dependence/independence constraint set $\llbracket \pm W \rrbracket$ of some first-order quantifier $Q^{\pm w}x$ of a free variable x and, at the same time, is not removed, *i.e.*, is not under the scope of another first-order quantifier for y itself. Notice that the dependencies of the variables quantified by a meta-quantifier, which are maintained by the dependency context ι , are not taken into account here, as they are only used to determine which variables are free. At this point, the set of *free variables* $\text{free}(\varphi)$ of a META-ADIF formula φ is defined as $\text{free}(\varphi, \emptyset)$.

To keep track of the Herbrand/Skolem functions already quantified, we use a *function assignment* $\mathfrak{F} \in \text{FAsg} \triangleq \text{Vr} \rightarrow \text{Fnc}$ mapping each variable $x \in \text{V} \triangleq \text{dom}(\mathfrak{F})$ to a function $\mathfrak{F}(x) \in \text{Fnc}$. To extend a hyperteam $\mathfrak{X} \in \text{HAsg}(\text{U})$ with \mathfrak{F} , we make use of the *extension operator* $\text{ext}(\mathfrak{X}, \mathfrak{F}) \triangleq \{\text{ext}(\text{X}, \mathfrak{F}) \mid \text{X} \in \mathfrak{X}\}$, where (i) $\text{ext}(\text{X}, \mathfrak{F}) \triangleq \{\chi \in \text{cyl}(\text{X}, \text{V}) \mid \forall x \in \text{V} \setminus \text{U}. \chi(x) = \mathfrak{F}(x)(\chi)\}$ is the extension of the team X over the variables in V , so that the value $\chi(x)$ given by an assignment χ to each (not yet assigned) variable $x \in \text{V} \setminus \text{U}$ is coherent with the one prescribed by $\mathfrak{F}(x)$ and (ii) $\text{cyl}(\text{X}, \text{V}) \triangleq \{\chi \in \text{Asg}(\text{U} \cup \text{V}) \mid \chi \upharpoonright_{\text{U}} \in \text{X}\}$ is the cylindrification of a team $\text{X} \in \text{TAsg}(\text{U})$ *w.r.t.* the set of variables $\text{V} \setminus \text{U}$. Finally, a function assignment $\mathfrak{F} \in \text{FAsg}$ is *acyclic* if, for all variables $x \in \text{dom}(\mathfrak{F})$, it holds that $\mathfrak{F}(x) \in \text{Fnc}_{\iota(x)}$, for some acyclic dependency context $\iota \in \text{Vr} \rightarrow 2^{\text{Vr}}$, with $\text{dom}(\mathfrak{F}) \subseteq \text{dom}(\iota)$.

Definition 6 (META-ADIF Semantics). *The Hodges' alternating semantic relation $\mathfrak{A}, \mathfrak{F}, \mathfrak{X} \models^\alpha \varphi$ for META-ADIF is inductively defined as follows, for all META-ADIF formulae φ , function assignments $\mathfrak{F} \in \text{FAsg}$, hypertteams $\mathfrak{X} \in \text{HAsg}_{\subseteq}(\text{sup}(\varphi) \setminus \text{dom}(\mathfrak{F}))$, and alternation flags $\alpha \in \{\exists\forall, \forall\exists\}$:*

- 1,2,4-8) All ADIF cases, but those ones of the atomic relations, are defined by lifting, in the obvious way, the corresponding items of Definition 2 to function assignments, *i.e.*, the latter play no role;
- 3) a) $\mathfrak{A}, \mathfrak{F}, \mathfrak{X} \models^{\exists\forall} R(\vec{x})$ if there exists a team $\text{X} \in \text{ext}(\mathfrak{X}, \mathfrak{F})$ such that, for all assignments $\chi \in \text{X}$, it holds that $\vec{x}^\chi \in R^{\mathfrak{A}}$;

- b) $\mathfrak{A}, \mathfrak{F}, \mathfrak{X} \models^{\forall\exists} R(\vec{x})$ if, for all teams $X \in \text{ext}(\mathfrak{X}, \mathfrak{F})$, there exists an assignment $\chi \in X$ such that $\vec{x}^\chi \in R^{\mathfrak{A}}$;
- 9) $\mathfrak{A}, \mathfrak{F}, \mathfrak{X} \models^{\alpha} \Sigma^{\pm w} x. \phi$ if $\mathfrak{A}, \mathfrak{F}[x \mapsto F], \mathfrak{X} \models^{\alpha} \phi$, for some function $F \in \text{Fnc}_{[\pm W]}$;
- 10) $\mathfrak{A}, \mathfrak{F}, \mathfrak{X} \models^{\alpha} \Pi^{\pm w} x. \phi$ if $\mathfrak{A}, \mathfrak{F}[x \mapsto F], \mathfrak{X} \models^{\alpha} \phi$, for all functions $F \in \text{Fnc}_{[\pm W]}$.

Essentially, to evaluate an atomic formula $R(\vec{x})$, we extend \mathfrak{X} with the functions dictated by \mathfrak{F} and then we check the assignments following the alternation given by the flag $\alpha \in \{\forall\exists, \exists\forall\}$ as in plain ADIF. Indeed, Item 3 above can be re-stated in the following equivalent form, which allows for a unified treatment of the alternation flags:

$$\mathfrak{A}, \mathfrak{F}, \mathfrak{X} \models^{\alpha} R(\vec{x}), \text{ if } \mathfrak{A}, \text{ext}(\mathfrak{X}, \mathfrak{F}) \models^{\alpha} R(\vec{x}),$$

where the second occurrence of the satisfaction relation \models^{α} refers to the Hodges' alternating semantic relation for ADIF, as per Item 3 of Definition 2. The semantics of the *meta quantifiers* $\Sigma^{\pm w} x$ and $\Pi^{\pm w} x$ is the classic second-order one, where the functions chosen at the meta level are stored in the assignment \mathfrak{F} .

The notions of satisfaction, implication, and equivalence, given at the end of Section 2.2 immediately lift to META-ADIF. In addition, all relevant results proved for ADIF in Section 2.4 clearly lift to the META-ADIF semantics of ADIF formulae. These results are, indeed, proved in this generalised form in Appendix C. In particular, satisfaction in ADIF and in META-ADIF coincide.

Proposition 2. $\mathfrak{A}, \mathfrak{X} \models^{\alpha} \varphi$ iff $\mathfrak{A}, \emptyset, \mathfrak{X} \models^{\alpha} \varphi$, for every ADIF formula φ and hyperteam $\mathfrak{X} \in \text{HAsg}_{\subseteq}(\text{sup}(\varphi))$.

At first glance, the semantic rule for the meta quantifiers might seem to mimic the corresponding quantifier rule of DIF and TL, as in both cases a choice of a Skolem/Herbrand function is involved. However, unlike in DIF and TL, the application of the functions to the hyperteam is delayed until the evaluation of an atomic formula. This makes the behaviour of quantifications in the two semantics diverge significantly. Such a difference is also mirrored in the more complex definition of free variables given above.

The following lemma characterises the connection between the compositional semantics of first-order quantifications $\exists^{\pm w} x$ and $\forall^{\pm w} x$ and the corresponding choice of a Skolem/Herbrand function.

Lemma 9 (Extension Interpretation). *The following four equivalences hold true, for all hyperteam $\mathfrak{X} \in \text{HAsg}(V)$ over $V \subseteq V_{\mathfrak{r}}$, properties $\Psi \subseteq \text{Asg}(V \cup \{x\})$ over $V \cup \{x\}$ with $x \in V_{\mathfrak{r}} \setminus V$, sets of variables $W \subseteq V_{\mathfrak{r}}$, and quantifier symbols $Q \in \{\exists, \forall\}$.*

1) Statements 1a and 1b are equivalent, whenever Q is α -coherent:

- a) there exists $X' \in \text{ext}_{\alpha}(\mathfrak{X}, Q^{\pm w} x)$ such that $X' \subseteq \Psi$;

- b) there exist $F \in \text{Fnc}_{[\pm W]}$ and $X \in \mathfrak{X}$ such that $\text{ext}(X, F, x) \subseteq \Psi$.
- 2) Statements 2a and 2b are equivalent, whenever Q is α -coherent:
- a) for all $X' \in \text{ext}_\alpha(\mathfrak{X}, Q^{\pm w}x)$, it holds that $X' \cap \Psi \neq \emptyset$;
- b) for all $F \in \text{Fnc}_{[\pm W]}$ and $X \in \mathfrak{X}$, it holds that $\text{ext}(X, F, x) \cap \Psi \neq \emptyset$.
- 3) Statements 3a and 3b are equivalent, whenever Q is $\bar{\alpha}$ -coherent:
- a) there exists $X' \in \text{ext}_\alpha(\mathfrak{X}, Q^{\pm w}x)$ such that $X' \subseteq \Psi$;
- b) for all $F \in \text{Fnc}_{[\pm W]}$, it holds that $\text{ext}(X, F, x) \subseteq \Psi$, for some $X \in \mathfrak{X}$.
- 4) Statements 4a and 4b are equivalent, whenever Q is $\bar{\alpha}$ -coherent:
- a) for all $X' \in \text{ext}_\alpha(\mathfrak{X}, Q^{\pm w}x)$, it holds that $X' \cap \Psi \neq \emptyset$;
- b) there is $F \in \text{Fnc}_{[\pm W]}$ such that $\text{ext}(X, F, x) \cap \Psi \neq \emptyset$, for all $X \in \mathfrak{X}$.

Equivalences 1 and 4, when $Q = \exists$, implicitly state that an existential quantification can always be simulated by an existential choice of a suitable Skolem function, independently of the alternation flag α for the hyperteam. Dually, Equivalences 2 and 3, when $Q = \forall$, state that a universal quantification can be simulated by a universal choice of a suitable Herbrand function, again regardless of α . These observations can be formulated in META-ADIF as follows.

Theorem 7 (Quantifier Interpretation). *The following equivalences hold true, for all FOL formulae ϕ , variables $x \in \text{Vr}$, sets of variables $W \subseteq \text{Vr}$ with $x \notin [\pm W]$, acyclic function assignments $\mathfrak{F} \in \text{FAsg}$ with $\text{dom}(\mathfrak{F}) \cap [\pm W] = \emptyset$, and hyperteams $\mathfrak{X} \in \text{HAsg}_{\subseteq}((\text{sup}(\phi) \setminus \{x\}) \setminus \text{dom}(\mathfrak{F}))$ with $x \notin \text{vr}(\mathfrak{X})$:*

- 1) $\mathfrak{A}, \mathfrak{F}, \mathfrak{X} \models^\alpha \exists^{\pm w} x. \phi$ iff $\mathfrak{A}, \mathfrak{F}, \mathfrak{X} \models^\alpha \Sigma^{\pm w} x. \phi$;
- 2) $\mathfrak{A}, \mathfrak{F}, \mathfrak{X} \models^\alpha \forall^{\pm w} x. \phi$ iff $\mathfrak{A}, \mathfrak{F}, \mathfrak{X} \models^\alpha \Pi^{\pm w} x. \phi$.

Given an ADIF formula $\wp\phi$ with quantifier prefix $\wp \in \text{Qn}$ and FOL matrix ϕ , we can convert each quantification in \wp , from inside out, into the corresponding meta quantification, by suitably iterating the result reported above. The meta quantifiers in the obtained prefix are in reverse order with respect to the order of corresponding standard quantifiers in the original prefix. To formalise this idea, we introduce the *Herbrand-Skolem prefix* function hsp as follows:

- a) $\text{hsp}(\varepsilon) \triangleq \varepsilon$;
- b) $\text{hsp}(\wp. \exists^{\pm w} x) \triangleq \Sigma^{\pm w} x. \text{hsp}(\wp)$;
- c) $\text{hsp}(\wp. \forall^{\pm w} x) \triangleq \Pi^{\pm w} x. \text{hsp}(\wp)$.

We can show that $\wp\phi \equiv \text{hsp}(\wp)\phi$, by exploiting Theorem 4. This conversion resembles a merging of the standard Skolem/Herbrand-isation procedures ([van Heijenoort](#),

1967; Buss, 1998) that convert a FOL sentence either into an equi-satisfiable/equi-valid FOL sentence without existential/universal quantifiers, or into an equivalent SOL formula. Note that the herbrandisation approach here is connected with the notion of Kreisel counterexample (Kreisel, 1951, 1952) applied to DIF (Mann et al., 2011).

Theorem 8 (Herbrand-Skolem Theorem). *Let $\wp\phi$ be an ADIF formula in pnf with quantifier prefix $\wp \in \text{Qn}$ and FOL matrix ϕ . Then, $\mathfrak{A}, \mathfrak{F}, \mathfrak{X} \models^\alpha \wp\phi$ iff $\mathfrak{A}, \mathfrak{F}, \mathfrak{X} \models^\alpha \text{hsp}(\wp)\phi$, for all acyclic function assignments $\mathfrak{F} \in \text{FAsg}$ with $\text{dom}(\mathfrak{F}) \cap \text{dep}(\wp) = \emptyset$ and hyperteams $\mathfrak{X} \in \text{HAsg}_{\subseteq}(\text{sup}(\wp\phi) \setminus \text{dom}(\mathfrak{F}))$ with $\text{vr}(\mathfrak{X}) \cap \text{vr}(\wp) = \emptyset$.*

Example 9. *Let us consider again the sentence from Example 7, i.e., $\varphi_7 = \exists x. \forall^{+\emptyset} y. \exists^{+x} z. (x = y) \wedge (y = z)$. We already saw that the sentence is true in the original binary structure \mathfrak{A} of the same example. If we convert φ_7 into META-ADIF via the function hsp , we obtain $\Sigma^{+x} z. \Pi^{+\emptyset} y. \Sigma^{+\emptyset} x. (x = y) \wedge (y = z)$. To show this sentence true in \mathfrak{A} , it suffices to assign to z the identity function that copies the value assigned to x . Then, whatever value is chosen for y , the same value can be assigned to x . By the semantics of META-ADIF, the result immediately follows.*

Thanks to this Herbrand/Skolem-isation procedure, we can transform a ADIF sentence in pnf into a META-ADIF sentence in pnf, where only the meta-quantifiers $\Sigma^{\pm w} x$ and $\forall^{\pm w} x$ occur. Since one needs only polynomial space in the size of the underlying structure to represent the quantified functions, the same approach used for FOL model checking is applicable here too.

Theorem 9 (Model-Checking Problem). *Let \mathfrak{A} be a finite structure and φ an ADIF sentence in pnf. Then, the model-checking problem $\mathfrak{A} \models \varphi$ can be decided in PSPACE w.r.t. $|\mathfrak{A}|$.*

As is the case of ADIF, we do not know whether META-ADIF enjoys a prenex normal form, even when we only take into consideration the two meta-quantifiers $\Sigma^{\pm w}$ and $\Pi^{\pm w}$.

Open Problem 2 (META-ADIF Prenex Normal Form). *Is every META-ADIF formula equivalent to a META-ADIF formula in pnf?*

4.2. Second-Order & Team Logics

We have previously shown that ADIF is a conservative extension of DIF. However, its game-theoretic determinacy gives us a considerably more expressive logic than DIF, with a full-fledged second-order flavour, even in the absence of a contradictory negation. Indeed, the meta-theory interpretation allows us to show that every SOL and TL formula can be interpreted in the ADF fragment of ADIF. *Vice versa*, every ADF formula, over a restricted class of hyperteams, can be interpreted by corresponding SOL sentences and TL formulae. This implies that, from a descriptive-complexity viewpoint, ADF sentences cover at least the entire polynomial hierarchy PH (Immerman, 1999).

Every non-null hyperteam $\mathfrak{X} \in \text{HAsg}(\vec{x})$ defined over a sequence of variables $\vec{x} \in \text{Vr}^*$, which is *at most equipotent* to the domain of the underlying structure \mathfrak{A} , i.e., $|\mathfrak{X}| \leq |\mathfrak{A}|$, can be encoded by a k -ary relation R , with $k \triangleq |\vec{x}| + 1$, whose interpretation $R^{\mathfrak{A}} \triangleq \text{Rel}(\mathfrak{X}) \subseteq A^k$ is defined (up to isomorphism) as follows: for every team $X \in \mathfrak{X}$, there is an element $a \in A$ and, *vice versa*, for every element $a \in A$, there is a team $X \in \mathfrak{X}$ such that

$$\chi \in X \text{ iff } \mathfrak{A} \uplus \{\text{Rel}(\mathfrak{X})\}, \chi[y \mapsto a] \models_{\text{FOL}} R(\vec{x}y),$$

for all assignments $\chi \in \text{Asg}(\vec{x})$. It is not clear whether there exists other relational encodings of infinite hyperteam with greater cardinality than the domain of the structure. Now, by Theorems 8, every ADIF formula in *pnf* can be translated into an equivalent META-ADIF formula, where the semantics of the meta quantifier can be easily modelled via second-order quantifications. This leads to the result below, stating that every ADF-definable hyperteam (under the above restriction) is SOL-definable too.

Theorem 10 (ADF-SOL Interpretation). *For every ADF formula φ in pnf with quantifier prefix $\wp \in \text{Qn}$ over a signature \mathcal{L} , set of variables $\text{free}(\varphi) \subseteq V \subseteq \text{Vr}$ with $V \cap \text{vr}(\wp) = \emptyset$, and relation symbol $R \notin \mathcal{L}$ with $\text{ar}(R) = |V| + 1$, there exist two SOL sentences $\Phi_{\exists\forall}$ and $\Phi_{\forall\exists}$ over signature $\mathcal{L} \uplus \{R\}$ such that, for all \mathcal{L} -structures \mathfrak{A} and non-null hyperteam $\mathfrak{X} \in \text{HAsg}(V)$ with $|\mathfrak{X}| \leq |\mathfrak{A}|$, the following equivalence hold true: $\mathfrak{A}, \mathfrak{X} \models^\alpha \varphi$ iff $\mathfrak{A} \uplus \{\text{Rel}(\mathfrak{X})\} \models_{\text{SOL}} \Phi_\alpha$.*

Using a similar approach, every non-empty non-null hyperteam $\mathfrak{X} \in \text{HAsg}(V)$ defined over a set of variables $V \subseteq \text{Vr}$, with $|\mathfrak{X}| \leq |\mathfrak{A}|$, can be encoded in a team $\text{Team}(\mathfrak{X}, y) \in \text{TAsg}(V \cup y)$, with $y \notin V$, as follows: for every team $X \in \mathfrak{X}$, there is an element $a \in A$ and, *vice versa*, for every element $a \in A$, there is a team $X \in \mathfrak{X}$ such that

$$\chi \in X \text{ iff } \chi[y \mapsto a] \in \text{Team}(\mathfrak{X}, y),$$

for all assignments $\chi \in \text{Asg}(V)$. Since every SOL-definable relation can be encoded in a TL-definable team (Kontinen and Väänänen, 2009; Kontinen and Nurmi, 2009), the next result easily follows from the previous one.

Corollary 7 (ADF-TL Interpretation). *For every ADF formula φ in pnf with quantifier prefix $\wp \in \text{Qn}$, set of variables $\text{free}(\varphi) \subseteq V \subseteq \text{Vr}$ with $V \cap \text{vr}(\wp) = \emptyset$, and variable $y \notin V$, there exist two TL formulae $\Phi_{\exists\forall}$ and $\Phi_{\forall\exists}$ with $\text{free}(\Phi_{\exists\forall}) = \text{free}(\Phi_{\forall\exists}) = V \cup y$ such that, for all structures \mathfrak{A} and non-empty non-null hyperteam $\mathfrak{X} \in \text{HAsg}(V)$ with $|\mathfrak{X}| \leq |\mathfrak{A}|$, the following equivalence hold true: $\mathfrak{A}, \mathfrak{X} \models^\alpha \varphi$ iff $\mathfrak{A}, \text{Team}(\mathfrak{X}, y) \models_{\text{TL}} \Phi_\alpha$.*

It is unknown whether the above two interpretation results still hold when the constraint $|\mathfrak{X}| \leq |\mathfrak{A}|$ on the size of the hyperteam and the domain of the structure is violated.

Open Problem 3 (ADF-SOL/TL Interpretations). *Is it possible to obtain interpretation results in a similar vein to Theorem 10 and Corollary 7, when $|\mathfrak{X}| > |\mathfrak{A}|$?*

In addition, it is not clear what the distinguishability power of ADIF is *w.r.t.* the cardinality of the hypertteams, especially in the infinite case.

Open Problem 4 (Hyperteam Cardinality). *Is there an ADIF satisfiable formula φ such that, if $\mathfrak{A}, \mathfrak{X} \models^\alpha \varphi$, then $|\mathfrak{X}| > |\mathfrak{A}| \geq \omega$, for some $\alpha \in \{\exists\forall, \forall\exists\}$?*

For the converse direction of the interpretation results, given an \mathcal{L} -structure \mathfrak{A} , a relation symbol $R \in \mathcal{L}$, and a sequence of variables $\vec{x} \in \text{Vr}^{\text{ar}(R)}$, we denote by $\text{Team}(R^{\mathfrak{A}}, \vec{x}) \in \text{TAsg}(\vec{x})$ the standard encoding in a team (up to isomorphism) of the interpretation $R^{\mathfrak{A}}$ of R defined as follows:

$$\chi \in \text{Team}(R^{\mathfrak{A}}, \vec{x}) \quad \text{iff} \quad \mathfrak{A}, \chi \models_{\text{FOL}} R(\vec{x}),$$

for all assignments $\chi \in \text{Asg}(\vec{x})$. Every SOL sentence can be put in a canonical form, where every quantification over functions can be simulated by a meta quantifier that only depends on the variables to which the function is applied. Thus, by exploiting Theorem 8, the result below can be proved.

Theorem 11 (SOL-ADF Interpretation). *For every SOL sentence Φ over a signature \mathcal{L} , relation symbol $R \in \mathcal{L}$, and sequence of variables $\vec{x} \in \text{Vr}^{\text{ar}(R)}$, there exists an ADF formula φ in pnf over signature $\mathcal{L} \setminus R$ with $\text{sup}(\varphi) = \text{free}(\varphi) = \vec{x}$ such that, for all \mathcal{L} -structures \mathfrak{A} , the following equivalence hold true: $\mathfrak{A} \models_{\text{SOL}} \Phi$ iff $\mathfrak{A} \setminus R, \{\text{Team}(R^{\mathfrak{A}}, \vec{x})\} \models^{\exists\forall} \varphi$.*

By using the translation from TL to SOL (see (Väänänen, 2007; Harel, 1979), for the sentences, and (Kontinen and Väänänen, 2009; Kontinen and Nurmi, 2009), for the formulae), we can show the following.

Corollary 8 (TL-ADF Interpretation). *For every TL formula Φ , there exists an ADF formula φ in pnf with $\text{sup}(\varphi) = \text{free}(\varphi) = \text{free}(\Phi)$ such that, for all structures \mathfrak{A} and teams $X \in \text{TAsg}_{\subseteq}(\text{free}(\Phi))$, the following equivalence holds true: $\mathfrak{A}, X \models_{\text{TL}} \Phi$ iff $\mathfrak{A}, \{X\} \models^{\exists\forall} \varphi$.*

5. Game-Theoretic Semantics

As discussed in Section 2, the alternating Hodges semantic relation $\mathfrak{A} \models \varphi$ implicitly ensures the existence of a *semantic game* $\mathfrak{D}_{\varphi}^{\mathfrak{A}}$, played by Eloise and Abelard, with the property that Eloise wins the game *iff* the ADIF sentence φ is indeed satisfied on the structure \mathfrak{A} . We conclude the work by formalising such a game, thus providing a *game-theoretic semantics* for ADIF and a proof of its adequacy *w.r.t.* both the compositional semantics of Definition 2 and the Herbrand-Skolem semantics of Theorem 8. Thanks to Corollary 8, this result also provides an indirect game-theoretic semantics for TL, a result that, as far as we know, was still missing (Väänänen, 2007). Note that, unlike for DIF (Hintikka and Sandu, 1997; Mann et al., 2011), $\mathfrak{D}_{\varphi}^{\mathfrak{A}}$ needs to be a *zero-sum perfect-information* game in order to comply with the game-theoretic determinacy of the logic (see Corollary 4), that for sentences is reflected in the law of excluded middle (see Corollary 5).

A two-player turn-based *arena* $\mathcal{A} = \langle \text{Ps}, \text{Ps}_E, \text{Ps}_A, v_I, Mv \rangle$ is a tuple where (i) Ps is the set of all *positions*, (ii) $\text{Ps}_E, \text{Ps}_A \subseteq \text{Ps}$ are the sets of positions owned by *Eloise* and *Abelard* with $\text{Ps}_E \cap \text{Ps}_A = \emptyset$, (iii) $v_I \in \text{Ps}$ is the *initial position*, and (iv) $Mv \subseteq (\text{Ps}_E \cup \text{Ps}_A) \times \text{Ps}$ is the binary left-total relation describing all possible *moves*. A *path* $\pi \in \text{Pth} \subseteq \text{Ps}^\infty$ is a finite or infinite sequence of positions compatible with the move relation, *i.e.*, $((\pi)_i, (\pi)_{i+1}) \in Mv$, for all $i \in [0, |\pi| - 1]$; it is *initial* if $|\pi| > 0$ and $\text{fst}(\pi) = v_I$. A *history* for player $\alpha \in \{E, A\}$ is a finite initial path $\rho \in \text{Hst}_\alpha \subseteq \text{Pth} \cap (\text{Ps}^* \cdot \text{Ps}_\alpha)$ terminating in an α -position. A *play* $\pi \in \text{Play} \subseteq \text{Pth}$ is a maximal (*i.e.*, non-extendable) initial path. A *strategy* for player $\alpha \in \{E, A\}$ is a function $\sigma_\alpha \in \text{Str}_\alpha \subseteq \text{Hst}_\alpha \rightarrow \text{Ps}$ mapping each α -history $\rho \in \text{Hst}_\alpha$ to a position $\sigma_\alpha(\rho) \in \text{Ps}$ compatible with the move relation, *i.e.*, $(\text{lst}(\rho), \sigma_\alpha(\rho)) \in Mv$. The *induced play* of a pair of strategies $(\sigma_E, \sigma_A) \in \text{Str}_E \times \text{Str}_A$ is the unique play $\pi \in \text{Play}$ such that $(\pi)_{i+1} = \sigma_E((\pi)_{\leq i})$, if $(\pi)_i \in \text{Ps}_E$, and $(\pi)_{i+1} = \sigma_A((\pi)_{\leq i})$, otherwise, for all $i \in [0, |\pi| - 1]$. A *game* $\mathcal{G} = \langle \mathcal{A}, \text{Wn} \rangle$ is a tuple, where \mathcal{A} is an arena and $\text{Wn} \subseteq \text{Play}$ is the set of *winning* plays for Eloise; the complement $\text{Play} \setminus \text{Wn}$ is *winning* for Abelard. Eloise (*resp.*, Abelard) *wins* the game if she (*resp.*, he) has a strategy $\sigma_E \in \text{Str}_E$ (*resp.*, $\sigma_A \in \text{Str}_A$) such that, for all opponent strategies $\sigma_A \in \text{Str}_A$ (*resp.*, $\sigma_E \in \text{Str}_E$), the corresponding induced play does (*resp.*, does not) belong to Wn . A game is *determined* if one of the two players wins.

With the notation put in place, we can now describe the semantic game, called *independence game*, where not only the players perform the choices corresponding to the operators in the formula, but also check that the choices of the opponent conform to the associated independence constraints. Although a specific move for each ADIF syntactic construct can be given, for the sake of a simpler presentation, we only define the moves for the quantifiers. Any quantifier-free FOL formula ψ , indeed, can be interpreted as a monolithic atomic relation, whose truth can be immediately evaluated once an assignment on all its free variables is given. For this reason, we assume $\varphi = \wp\psi$ to be in *pnf*, for some quantifier prefix $\wp \in \text{Qn}$, where no variable is quantified twice. Finally, as a standard assumption from a descriptive-complexity viewpoint (Immerman, 1999; Grädel et al., 2005), we restrict to finite structures only. The general case, as well as the lift of the approach to formulae, will be the focus of the future works.

The game for $\varphi = \wp\psi$ consists of two recurrent stages/phases, called *decision* and *challenge*. The decision phase is almost identical to a classic Hintikka's FOL game (Hintikka and Sandu, 1997), where the player associated with the current subformula $\phi = \mathbb{Q}^{\pm}x.\phi'$ of φ chooses a value for the bound variable x to be stored in the current assignment χ . Once all quantifiers are eliminated, however, instead of declaring the winner by simply evaluating the truth of $\mathfrak{A}, \chi \models_{\text{FOL}} \psi$, the game enters the challenge phase. Here the players, following again the order of quantification, are asked to confirm or change their choices. Making a change here is intended to allow for verifying that the independence constraints declared in \wp are satisfied; after all, if the opponent's choice is indeed independent of the player's one, such a change should not make any difference in the satisfaction of the formula. In more detail, the player associated with ϕ can either (i) confirm

her/his own choice maintaining both the assignment χ and phase unchanged or (ii) or challenge the adversary, by modifying the value assigned to the variable x in χ , deleting all values for the variables quantified in \wp after x , and reverting to the decision phase. In both cases, the control is passed on to the player of the formula ϕ' in the scope of the quantifier $Q^{\pm w}x$, so as to allow her/him to reply to the challenge. As it should be evident from the alternation of phases, unlike the semantic game for FOL, $\mathcal{D}_{\wp}^{\mathfrak{A}}$ is an *infinite-duration* game that allows for both finite and infinite plays. The finite ones necessarily terminates in a position of the challenge phase with current subformula ψ , where the winner can be determined by evaluating the truth of $\mathfrak{A}, \chi \models_{\text{FOL}} \psi$. The infinite plays, instead, are won by the player able to force the adversary to change infinitely often the values of one of her/his own variables x in a way that violates the independence constraints, without being able, at the same time, to force the challenger to do the same on a variable subsequent to x in \wp . We clarify this point later on.

The formalisation of the arena $\mathcal{A}_{\wp}^{\mathfrak{A}}$ underlying the independence game $\mathcal{D}_{\wp}^{\mathfrak{A}}$ is reported below, where $\text{psf}(\varphi)$ denotes the smallest set of subformulae of φ , called *prefix subformulae*, such that (i) $\varphi \in \text{psf}(\varphi)$ and (ii) if $\phi = Q^{\pm w}x.\phi' \in \text{psf}(\varphi)$ then $\phi' \in \text{psf}(\varphi)$. As an example, for the sentence $\varphi_4 = \exists x.\forall^{+\emptyset}y.\neg(x = y)$ reported in Example 5, we have $\text{psf}(\varphi_4) = \{\varphi_4, \forall^{+\emptyset}y.\neg(x = y), \neg(x = y)\}$.

Construction 1 (Independence Arena). *For a finite structure \mathfrak{A} and a pnf ADIF sentence $\varphi = \wp\psi$, with $\psi \in \text{FOL}$, the independence arena $\mathcal{A}_{\wp}^{\mathfrak{A}} = \langle \text{Ps}, \text{Ps}_{\text{E}}, \text{Ps}_{\text{A}}, v_I, \text{Mv} \rangle$ is defined as prescribed in the following:*

- 1) *the set of positions $\text{Ps} \subseteq \text{psf}(\varphi) \times \text{Asg} \times \{\downarrow, \circ\}$ contains those triples (ϕ, χ, \diamond) of a prefix subformula $\phi \in \text{psf}(\varphi)$ of φ , an assignment $\chi \in \text{Asg}$, and a phase flag $\diamond \in \{\downarrow, \circ\}$ such that $\chi \in \text{Asg}(\text{free}(\phi))$, if $\diamond = \downarrow$, and $\chi \in \text{Asg}(\text{free}(\psi))$, otherwise;*
- 2) *the set Ps_{E} of Eloise's (resp., Ps_{A} of Abelard's) positions contains the triples of the form $(\exists^{\pm w}x.\phi', \chi, \diamond)$ or (ψ, χ, \downarrow) (resp., $(\forall^{\pm w}x.\phi', \chi, \diamond)$);*
- 3) *the initial position $v_I \triangleq (\varphi, \emptyset, \downarrow)$ contains the original sentence φ associated with the empty assignment \emptyset and the phase flag \downarrow ;*
- 4) *the move relation $\text{Mv} \subseteq \text{Ps} \times \text{Ps}$ contains exactly those pairs of positions $(v_1, v_2) \in \text{Ps} \times \text{Ps}$ satisfying one of the conditions below:*
 - a) $v_1 = (Q^{\pm w}x.\phi', \chi, \diamond)$ and $v_2 = (\phi', \chi, \diamond)$, with $x \notin \text{free}(\phi')$;
 - b) $v_1 = (Q^{\pm w}x.\phi', \chi, \downarrow)$ and $v_2 = (\phi', \chi[x \mapsto a], \downarrow)$, for some $a \in \text{A}$;
 - c) $v_1 = (\psi, \chi, \downarrow)$ and $v_2 = (\varphi, \chi, \circ)$;
 - d) $v_1 = (Q^{\pm w}x.\phi', \chi, \circ)$ and $v_2 = (\phi', \chi, \circ)$;
 - e) $v_1 = (Q^{\pm w}x.\phi', \chi, \circ)$ and $v_2 = (\phi', \chi'[x \mapsto a], \downarrow)$, for some $a \in \text{A}$ with $a \neq \chi(x)$, where $\chi' \triangleq \chi \upharpoonright \text{free}(Q^{\pm w}x.\phi')$.

Intuitively, a position $(\phi, \chi, \blacklozenge)$ maintains the information about the formula ϕ that still has to be played against, the assignment χ containing the variables whose values have already been chosen, and a flag \blacklozenge identifying the phase, either \downarrow or \circ . Item 4a forces the trivial move for the vacuous quantifications, Item 4b defines the moves for the decision phase, Item 4c switches from the decision to the challenge phase, Item 4d defines the confirmation of the choice already made, and, finally, Item 4e describes the challenge to the adversary, where the phase is reverted to the decision one, the value for the variable involved in the challenge is changed, and all values for the subsequent variables are deleted.

The winning condition for the game is defined as follows. Since the winner of finite plays is easy to determine, as it only depends on whether the assignment in the last position satisfies ψ , we shall focus on the infinite ones. Let us consider an arbitrary prefix subformula $\phi = \mathbb{Q}^{\pm w}x. \phi' \in \mathbf{psf}(\varphi)$ with $x \in V \triangleq \mathbf{free}(\phi')$. By $\mathcal{F}_\phi: \mathbf{Asg}(V) \rightarrow 2^{\mathbf{Fnc}_{\pm w}}$ we denote the map associating each assignment $\chi \in \mathbf{Asg}(V)$ defined over the variables in V with the set $\mathcal{F}_\phi(\chi) \triangleq \{\mathbf{F} \in \mathbf{Fnc}_{\pm w} \mid \mathbf{F}(\chi) = \chi(x)\}$ of all the $\pm W$ -functions compatible with the value assigned to x in χ . In addition, by $\mathcal{B}_\phi: \mathbf{Hst} \rightarrow 2^{\mathbf{Fnc}_{\pm w}}$, with $\mathbf{Hst} \triangleq \mathbf{Hst}_E \cup \mathbf{Hst}_A$, we denote the map assigning to each history $\rho \in \mathbf{Hst}$ the set $\mathcal{B}_\phi(\rho)$ of all the $\pm W$ -functions compatible with the most recent assignments along ρ . Formally:

- $\mathcal{B}_\phi(v_I) \triangleq \mathbf{Fnc}_{\pm w}$;
- $\mathcal{B}_\phi(\rho \cdot (\phi', \chi, \downarrow)) \triangleq \begin{cases} \mathcal{F}_\phi(\chi), & \text{if } \mathcal{B}_\phi(\rho) \cap \mathcal{F}_\phi(\chi) = \emptyset; \\ \mathcal{B}_\phi(\rho) \cap \mathcal{F}_\phi(\chi), & \text{otherwise;} \end{cases}$
- $\mathcal{B}_\phi(\rho \cdot v) \triangleq \mathcal{B}_\phi(\rho)$, in all other cases, *i.e.*, $v \neq (\phi', \rightarrow, \downarrow)$.

Essentially, the bucket $\mathcal{B}_\phi(\rho)$ maintains the most updated set of Herbrand/Skolem functions for the variable x that the associated player can use to reply to all the variables which x depends upon. When a play starts, no choice has been made yet, so $\mathcal{B}_\phi(v_I)$ is full. Once a position $(\phi', \chi, \downarrow)$ is reached after a history ρ , a fresh value $\chi(x)$ for x has just been chosen to resolve the quantifier \mathbb{Q} , so the bucket is updated by removing from $\mathcal{B}_\phi(\rho)$ all the functions that are not compatible with this new value. If such resulting set becomes empty, the player is caught cheating and the bucket is replenished taking into account only the choice just made.

In general there are two reasons for a player to cheat. Either she/he is changing the value of the variable to challenge the adversary to prove that he/she is complying with the independence constraints (Item 4e), or she/he chooses a new value because is unable to both satisfy her/his goal and comply with the constraints on her/his variables (Item 4b). Obviously, the second type of cheating, called *defensive cheat*, can, in turn, induce one of the first type, called *challenge cheat*. Hence, complex chains of different types of cheating can occur. In order to identify which player is the last one who was forced to cheat, we consider an arbitrary map $\mathbf{pr}: \mathbf{psf}(\varphi) \rightarrow \mathbb{N}$ assigning to each prefix subformula $\phi = \mathbb{Q}^{\pm w}x. \phi' \in \mathbf{psf}(\varphi)$ a priority $\mathbf{pr}(\phi)$ such that i) $\mathbf{pr}(\phi)$ is even *iff*

$Q = \forall$ and ii) $\text{pr}(\phi) < \text{pr}(\phi')$. To each history $\rho \in \text{Hst}$ we can then assign the sequence of cheats $\text{cht}(\rho)$ occurring in it via the map $\text{cht}: \text{Hst} \rightarrow \mathbb{N}^*$ as follows:

- $\text{cht}(v_I) \triangleq 0$;
- $\text{cht}(\rho \cdot (\phi', \chi, \downarrow)) \triangleq \text{cht}(\rho) \cdot \text{pr}(\phi)$, whenever $\mathcal{B}_\phi(\rho) \cap \mathcal{F}_\phi(\chi) = \emptyset$;
- $\text{cht}(\rho \cdot v) \triangleq \text{cht}(\rho) \cdot 0$, in all other cases.

This construction easily lifts to infinite plays $\pi \in \text{Play}^\omega \triangleq \text{Play} \cap \text{Ps}^\omega$ through the map $\text{cht}: \text{Play}^\omega \rightarrow \mathbb{N}^\omega$ such that $(\text{cht}(\pi))_i = \text{cht}((\pi)_{\leq i})$, for all $i \in \mathbb{N}$. Finally, $\text{pr}(\pi)$ denotes the maximal priority seen infinitely often along $\text{cht}(\pi)$. Note that every infinite play necessarily contains at least infinitely many challenge cheats (Item 4e). Thus, $\text{pr}(\pi)$ uniquely identifies the right-most variable in \wp over which the corresponding player cheated, without being able, at the same time, to force the adversary to do the same. If $\text{pr}(\pi)$ is even, Abelard is cheating infinitely often, so he loses the play π , which is, therefore, won by Eloise.

Construction 2 (Independence Game). *For a finite structure \mathfrak{A} and a pnf ADIF sentence $\varphi = \wp\psi$, with $\psi \in \text{FOL}$, the independence game $\mathfrak{D}_\varphi^\mathfrak{A} = \langle \mathcal{A}, \text{Wn} \rangle$ is defined as prescribed in the following:*

- 1) \mathcal{A} is the independence arena $\mathcal{A}_\varphi^\mathfrak{A}$ defined in Construction 1;
- 2) $\text{Wn} \subseteq \text{Play}$ is the set of all the plays π satisfying the following conditions:
 - a) if π is infinite then $\text{pr}(\pi)$ is even;
 - b) if π is finite then $\text{lst}(\pi) = (\psi, \chi, \circlearrowleft)$ and $\mathfrak{A}, \chi \models_{\text{FOL}} \psi$, for some assignment $\chi \in \text{Asg}(\text{free}(\psi))$.

Example 10. *Let us consider the sentence φ_7 of Example 7 from Section 2.1, which is true in the binary structure \mathfrak{A} of that example. Therefore, Eloise, who controls the values of the variables x and z , must have a strategy to win the independence game $\mathfrak{D}_{\varphi_7}^\mathfrak{A}$. One possibility is to choose, during the decision phase, the constant function $f_x = 0$ for x and the identity function $f_z(x) = x$ for z . Clearly, she wins any finite play where Abelard chooses the constant function $f_y = 0$ for y , since the resulting assignment satisfies both $(x = y)$ and $(y = z)$. Let us assume, then, that he chooses $f_y = 1$, instead, in the decision phase. Since at the end of this phase Eloise knows she is losing, she will challenge Abelard by changing her function f_x for x to the constant 1. This raises the priority of the current play fragment to 1. Now, if Abelard sticks to function $f_y = 1$ for y , he loses, since $f_z(x) = x$ would now give z value 1 as well, leading to a finite play. So he needs to modify his choice to $f_y = 0$, this time raising the priority of the play fragment to 2 and generating a challenge for Eloise on z . Eloise, however, can stick to the identity function and make way to a new challenge phase. Now, since Eloise is losing with the current assignment, she will challenge once again, choosing $f_x = 0$ and raising priority 1. Abelard is then forced to change function and raise priority 2 and we are back to where we started. This cyclic process*

ends up forming an infinite play whose maximal priority is 2, since Eloise can force Abelard to defensively change bucket infinitely often, thus satisfying her winning condition.

It is worth noting that the game devised above bears some similarities with the *team-building game* proposed by Bradfield (2013) for DL (Väänänen, 2007). Both ours and his are complete-information games extending Hintikka’s game for FOL. In addition, Bradfield’s game also checks the uniformity of the choices made by Eloise by means of a challenge mechanism, where the sentence is played over repeatedly by the players. The similarities, however, end here as the two games differ significantly in nature. First, the repeated evaluations of a sentence φ in Bradfield’s game allow him to build teams during a play, one for each dependence atom occurring in φ . Each team is then used to check whether Eloise’s choices have been made in accordance to the dependency constraint encoded by the corresponding atom. All these teams are explicitly recorded in each state of his game, together with the partial assignment recording the choices made by the players so far in the current repetition. In this sense, then, Bradfield’s arena is intrinsically second order, as it records sets of assignments in each state and contains moves that update such sets. Second, Bradfield’s game on finite structures only admits finite plays and its winning condition, then, boils down to a simple reachability. On the contrary, our game is played in a purely first-order arena, whose states only keep track of players choices collected in the partial assignment. Moreover, it always admits infinite plays, where players can repeatedly challenge each other forever. The second-order power of our game, then, resides entirely in the winning condition, where the priority-based mechanism accounts for the alternation of the quantifiers along the, possibly infinite, repeated evaluations of the sentence.

To conclude, by exploiting Theorem 8, it is possible to prove the adequacy of the game-theoretic semantics *w.r.t.* the model-theoretic one of Definition 6 and, in turn, *w.r.t.* the compositional one of Definition 2, where the Herbrand/Skolem functions obtained by the evaluation of the existential (*resp.*, universal) meta quantifiers of the META-ADIF sentence $\text{hsp}(\varphi)\psi$ (*resp.*, $\neg \text{hsp}(\varphi)\psi$) induce a winning strategy for Eloise (*resp.*, Abelard) in $\mathcal{D}_\varphi^{\mathfrak{A}}$. This also implies the determinacy of the independence game, without the need to rely on topological determinacy theorems, as those of Martin (1975, 1985).

Theorem 12 (Game-Theoretic Semantics). *For a finite structure \mathfrak{A} and an ADIF sentence φ in prenex form, there exists an independence game $\mathcal{D}_\varphi^{\mathfrak{A}}$ such that $\mathfrak{A} \models \varphi$ (*resp.*, $\mathfrak{A} \not\models \varphi$) iff $\mathcal{D}_\varphi^{\mathfrak{A}}$ is won by Eloise (*resp.*, Abelard).*

6. Discussion

We have introduced Alternating Dependence/Independence-Friendly Logic (ADIF), a conservative extension of Independence-Friendly Logic (IF), that incorporates negation in a very natural way and avoids the indeterminacy of the logic. This is achieved by means of a generalisation of team semantics, where the

choices of both players are represented in a two-level structure, called hyperteam. This allows us to treat the two players symmetrically and force both of them to make their choices according to the (in)dependence constraints specified in the corresponding quantifiers. Interestingly enough, the new semantics grants the proposed logic the full expressive power of Second-Order Logic (SOL) and, as a consequence, also of Team Logic (TL), without the need of including additional connectives in the language. It also allows for restoring the law of excluded middle for sentences and enjoys the property of game-theoretic determinacy. For the prenex fragment, a Herbrand-Skolem semantics is also provided that directly connects ADIF with SOL, as well as a game-theoretic semantics on finite structures, given in terms of a determined turn-based infinite-duration perfect-information game played on a first-order arena.

Interesting questions that remain open concern whether a prenex normal form theorem holds for the language. Equally unsettled is the actual expressive power of ADIF. We do show that it is at least as expressive as SOL and, thus, covers the full polynomial hierarchy PH. The proof for the other direction, however, relies upon the assumption of equipotency between the hyperteam \mathfrak{X} and the domain A of the underlying structure \mathcal{A} , which allows us to encode hyperteams by means of a suitable relation $\text{Rel}(\mathfrak{X})$. There seems to be no straightforward way to do the same for “big” hyperteams. Yet again, it is not clear whether such “big” hyperteam actually matter, in the sense of there being a formula that can distinguish between “big” and “small” hyperteams. Usually, similar questions have been addressed by defining suitable Ehrenfeucht-Fraïssé games (EF) to precisely characterise the expressive power of the logic. For this reason, one may think to do the same for ADIF as well. The main difficulty we foresee here is, however, the treatment of quantifications, for which no explicit commitment to a specific valued is made in the semantics (all choices are evenly encoded in the hyperteam). In a classic EF game, instead, the moves corresponding to the choices of a value by a quantifier make explicit commitments. Currently, it is not clear to us how to circumvent this discrepancy.

Acknowledgments

Partially supported by the GNCS 2020 project “Ragionamento Strategico e Sintesi Automatica di Sistemi Multi-Agente”.

Appendix A. Proofs of Section 2

Before each proof of a theorem, we display its dependency graph: the vertices are the results used to prove the theorem (they can be lemmata, propositions, other theorems, etc). There is an edge from Result 1 to Result 2 *iff* Result 1 is explicitly used in Result 2's proof.

Let $W \subseteq Vr$ and $\mathfrak{X} \in \text{HAsg}$. For a team $X \in \mathfrak{X}|_W$, we denote by $X|_W^W$ one (arbitrarily chosen) of the teams $Y \in \mathfrak{X}$ such that $Y|_W = X$.

Lemma 1 (Dualisation I). *For all hypertteams $\mathfrak{X} \in \text{HAsg}$, it holds that $\mathfrak{X} \equiv_W \overline{\overline{\mathfrak{X}}}$, for all $W \subseteq Vr$. In addition, $\mathfrak{X} \subseteq \overline{\overline{\mathfrak{X}}}$, if \mathfrak{X} is proper.*

Proof. First, observe that, by Proposition 1, $\overline{\overline{\mathfrak{X}}} \equiv \mathfrak{X}$ holds for every non-proper hyperteam \mathfrak{X} .

Next, we show that $\mathfrak{X} \subseteq \overline{\overline{\mathfrak{X}}}$, for a proper hyperteam \mathfrak{X} . Let $X \in \mathfrak{X}$. Observe that, since X is proper, $X' \cap X \neq \emptyset$ for all $X' \in \overline{\overline{\mathfrak{X}}}$. For every $\chi \in X$, fix a choice function $\mathfrak{d}_\chi \in \text{Chc}(\mathfrak{X})$ such that $\mathfrak{d}_\chi(X) = \chi \in X$. Now, consider $\overline{\mathfrak{d}} \in \text{Chc}(\overline{\overline{\mathfrak{X}}})$ such that $\overline{\mathfrak{d}}(\text{img}(\mathfrak{d}_\chi)) = \chi$ for all $\chi \in X$, and $\overline{\mathfrak{d}}(X') \in X \cap X'$ for all the other teams $X' \in \overline{\overline{\mathfrak{X}}} \setminus \{\text{img}(\mathfrak{d}_\chi) \mid \chi \in X\}$. Clearly, $X = \text{img}(\overline{\mathfrak{d}}) \in \overline{\overline{\mathfrak{X}}}$, hence $\mathfrak{X} \subseteq \overline{\overline{\mathfrak{X}}}$.

Since $\mathfrak{X} \subseteq \overline{\overline{\mathfrak{X}}}$ implies $\mathfrak{X} \sqsubseteq \overline{\overline{\mathfrak{X}}}$, it suffices to prove that $\overline{\overline{\mathfrak{X}}} \sqsubseteq \mathfrak{X}$ holds to obtain $\mathfrak{X} \equiv \overline{\overline{\mathfrak{X}}}$. To this end, let $\overline{X'} = \text{img}(\overline{\mathfrak{d}}) \in \overline{\overline{\mathfrak{X}}}$, for some $\overline{\mathfrak{d}} \in \text{Chc}(\overline{\overline{\mathfrak{X}}})$. We show that there is $X \in \mathfrak{X}$ such that $X \subseteq \overline{X'}$. Assume, towards a contradiction, that this is not the case, *i.e.*, for all $X \in \mathfrak{X}$ there is $\chi_X \in X \setminus \overline{X'}$. Then, define $\mathfrak{d} \in \text{Chc}(\mathfrak{X})$ as: $\mathfrak{d}(X) = \chi_X$ for all $X \in \mathfrak{X}$. Clearly, $\overline{\mathfrak{d}}(\text{img}(\mathfrak{d})) \notin \overline{X'}$, thus raising a contradiction. Now, the thesis follows from the observation that $\mathfrak{X} \equiv \overline{\overline{\mathfrak{X}}}$ is equivalent to $\mathfrak{X} \equiv_{Vr} \overline{\overline{\mathfrak{X}}}$, which implies $\mathfrak{X} \equiv_W \overline{\overline{\mathfrak{X}}}$, due to $W \subseteq Vr$. \square

Lemma 2 (Dualisation II). *The following equivalences hold true, for all hypertteams $\mathfrak{X} \in \text{HAsg}$ and property $\Psi \subseteq \text{Asg}$.*

1) *Statements 1a and 1b are equivalent:*

- a) *there exists a team $X \in \mathfrak{X}$ (resp., $X \in \overline{\overline{\mathfrak{X}}}$) such that $X \subseteq \Psi$;*
- b) *for all teams $X' \in \overline{\overline{\mathfrak{X}}}$ (resp., $X' \in \mathfrak{X}$), it holds that $X' \cap \Psi \neq \emptyset$.*

2) *Statements 2a and 2b are equivalent:*

- a) *there exists a team $X \in \mathfrak{X}$ such that $X \cap \Psi \neq \emptyset$;*
- b) *there exists a team $X' \in \overline{\overline{\mathfrak{X}}}$ such that $X' \cap \Psi \neq \emptyset$.*

3) *Statements 3a and 3b are equivalent:*

- a) *for all teams $X \in \mathfrak{X}$, it holds that $X \subseteq \Psi$;*
- b) *for all teams $X' \in \overline{\overline{\mathfrak{X}}}$, it holds that $X' \subseteq \Psi$.*

Proof. We consider the three equivalences separately.

- 1) First, we show that there exists a team $X \in \mathfrak{X}$ such that $X \subseteq \Psi$ if and only if for all teams $X' \in \overline{\mathfrak{X}}$, it holds that $X' \cap \Psi \neq \emptyset$.
 - (*only-if* direction) Let X' be a generic element of $\overline{\mathfrak{X}}$. Thus, $X' = \text{img}(\mathfrak{d})$ for some $\mathfrak{d} \in \text{Chc}(\mathfrak{X})$. Thus, $\mathfrak{d}(X) \in X \cap X'$. The thesis follows from $X \subseteq \Psi$.
 - (*if* direction) By Proposition 1, if $\overline{\mathfrak{X}} = \emptyset$, then $\emptyset \in \mathfrak{X}$, and the thesis immediately follows since $\emptyset \subseteq \Psi$. If, instead $\overline{\mathfrak{X}} \neq \emptyset$, then assume, towards a contradiction, that for all $X \in \mathfrak{X}$, there is $\chi_X \in X \setminus \Psi$. Define $\mathfrak{d} \in \text{Chc}(\mathfrak{X})$ as: $\mathfrak{d}(X) = \chi_X$, for all $X \in \mathfrak{X}$. Since $\text{img}(\mathfrak{d}) \in \overline{\mathfrak{X}}$ and $\text{img}(\mathfrak{d}) \cap \Psi = \emptyset$, we get a contradiction.

The rest of the claim, *i.e.*, there exists a team $X' \in \overline{\mathfrak{X}}$ such that $X' \subseteq \Psi$ if and only if for all teams $X \in \mathfrak{X}$, it holds that $X \cap \Psi \neq \emptyset$, follows from above and the fact that $\mathfrak{X} \equiv \overline{\overline{\mathfrak{X}}}$ (Lemma 1).
- 2) (*only-if* direction) Consider $\mathfrak{d} \in \text{Chc}(\mathfrak{X})$ such that $\mathfrak{d}(X) \in X \cap \Psi$. The thesis follows from $\mathfrak{d}(X) \in \text{img}(\mathfrak{d}) \in \overline{\mathfrak{X}}$.
 - (*if* direction) Let $X' = \text{img}(\mathfrak{d}) \in \overline{\mathfrak{X}}$, for some $\mathfrak{d} \in \text{Chc}(\mathfrak{X})$, be such that $X' \cap \Psi \neq \emptyset$ and let $\overline{\chi} \in X' \cap \Psi$. Thus, there is $X \in \mathfrak{X}$ such that $\mathfrak{d}(X) = \overline{\chi} \in X$, which means that $X \cap \Psi \neq \emptyset$, hence the thesis.
- 3) The claim follows by instantiating Ψ with $\text{Asg} \setminus \Psi$ in the previous claim, and observing that 3a and 3b correspond to the negations of 2a and 2b, respectively. \square

Lemma 3 (Empty & Null Hyperteams). *The following hold true for every ADIF formula φ and hyperteam $\mathfrak{X} \in \text{HAsg}_{\subseteq}(\text{sup}(\varphi))$:*

- 1) a) $\mathfrak{A}, \emptyset \not\models^{\exists^{\forall}} \varphi$; b) $\mathfrak{A}, \mathfrak{X} \models^{\exists^{\forall}} \varphi$, where $\emptyset \in \mathfrak{X}$;
- 2) a) $\mathfrak{A}, \emptyset \models^{\forall^{\exists}} \varphi$; b) $\mathfrak{A}, \mathfrak{X} \not\models^{\forall^{\exists}} \varphi$, where $\emptyset \in \mathfrak{X}$.

Proof. The claim follows from the more general Lemma 11, reported in Appendix C, by instantiating \mathfrak{F} with the empty function \emptyset . \square

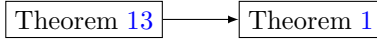

Figure A.2: Dependency graph of Theorem 1.

Theorem 1 (Hyperteam Refinement). *Let φ be an ADIF formula and $\mathfrak{X}, \mathfrak{X}' \in \text{HAsg}_{\subseteq}(\text{sup}(\varphi))$ two hyperteam with $\mathfrak{X} \sqsubseteq_{\text{fre}(\varphi)} \mathfrak{X}'$. Then:*

- 1) *if $\mathfrak{A}, \mathfrak{X} \models^{\exists^{\forall}} \varphi$ then $\mathfrak{A}, \mathfrak{X}' \models^{\exists^{\forall}} \varphi$;*
- 2) *if $\mathfrak{A}, \mathfrak{X}' \models^{\forall^{\exists}} \varphi$ then $\mathfrak{A}, \mathfrak{X} \models^{\forall^{\exists}} \varphi$.*

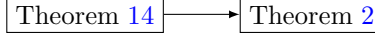

Figure A.3: Dependency graph of Theorem 2.

Proof. The claim follows from the more general Theorem 13, reported in Appendix C, by instantiating both \mathfrak{F} and ι with the empty function \emptyset . \square

Theorem 2 (Double Dualisation). *For every ADIF formula φ and hyperteam $\mathfrak{X} \in \text{HAsg}_{\subseteq}(\text{sup}(\varphi))$, it holds that $\mathfrak{A}, \mathfrak{X} \models^{\alpha} \varphi$ iff $\mathfrak{A}, \overline{\mathfrak{X}} \models^{\alpha} \varphi$ iff $\mathfrak{A}, \overline{\mathfrak{X}} \models^{\overline{\alpha}} \varphi$.*

Proof. The claim follows from the more general Theorem 14, reported in Appendix C, by instantiating \mathfrak{F} with the empty function \emptyset . \square

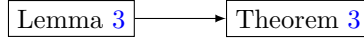

Figure A.4: Dependency graph of Theorem 3.

Theorem 3 (Boolean Laws). *Let φ_1, φ_2 and φ be ADIF formulae. Then:*

- | | | |
|--|-------------------------------|---|
| 1) a) $\neg \perp \equiv \top$; | b) $\neg \top \equiv \perp$; | c) $\varphi \equiv \neg \neg \varphi$; |
| 2) a) $\varphi \wedge \perp \equiv \perp \wedge \varphi \equiv \perp$; | | b) $\varphi \wedge \top \equiv \top \wedge \varphi \equiv \varphi$; |
| 3) a) $\varphi \vee \top \equiv \top \vee \varphi \equiv \top$; | | b) $\varphi \vee \perp \equiv \perp \vee \varphi \equiv \varphi$; |
| 4) a) $\varphi_1 \wedge \varphi_2 \equiv \varphi_2 \wedge \varphi_1$; | | b) $\varphi_1 \vee \varphi_2 \equiv \varphi_2 \vee \varphi_1$; |
| 5) a) $\varphi_1 \wedge \varphi_2 \Rightarrow \varphi_1$; | | b) $\varphi_1 \wedge (\varphi \wedge \varphi_2) \equiv (\varphi_1 \wedge \varphi) \wedge \varphi_2$; |
| 6) a) $\varphi_1 \Rightarrow \varphi_1 \vee \varphi_2$; | | b) $\varphi_1 \vee (\varphi \vee \varphi_2) \equiv (\varphi_1 \vee \varphi) \vee \varphi_2$; |
| 7) a) $\varphi_1 \wedge \varphi_2 \equiv \neg(\neg \varphi_1 \vee \neg \varphi_2)$; | | b) $\varphi_1 \vee \varphi_2 \equiv \neg(\neg \varphi_1 \wedge \neg \varphi_2)$; |
| 8) a) $\exists^{\pm w} x. \varphi \equiv \neg(\forall^{\pm w} x. \neg \varphi)$; | | b) $\forall^{\pm w} x. \varphi \equiv \neg(\exists^{\pm w} x. \neg \varphi)$. |

Proof. Proving that an equivalence (resp., implication) $\varphi_1 \equiv \varphi_2$ (resp., $\varphi_1 \Rightarrow \varphi_2$) holds true amounts to showing that both $\varphi_1 \equiv^{\exists \forall} \varphi_2$ and $\varphi_1 \equiv^{\forall \exists} \varphi_2$ (resp., $\varphi_1 \Rightarrow^{\exists \forall} \varphi_2$ and $\varphi_1 \Rightarrow^{\forall \exists} \varphi_2$) hold true. However, as a consequence of Theorem 2, we have that $\varphi_1 \equiv^{\alpha} \varphi_2$ iff $\varphi_1 \equiv^{\overline{\alpha}} \varphi_2$ (resp., $\varphi_1 \Rightarrow^{\alpha} \varphi_2$ iff $\varphi_1 \Rightarrow^{\overline{\alpha}} \varphi_2$) for all $\alpha \in \{\exists \forall, \forall \exists\}$. Therefore, for every claim in the statement of the theorem, it is enough to focus on one of the two alternation flags $\exists \forall$ and $\forall \exists$ only.¹ In the following, when proving an equivalence $\varphi_1 \equiv \varphi_2$ (resp., implication $\varphi_1 \Rightarrow \varphi_2$), we assume $\mathfrak{X} \in \text{HAsg}_{\subseteq}(\text{sup}(\varphi_1) \cup \text{sup}(\varphi_2))$.

¹Observe that a proof that does not make use of Theorem 2 is possible. Therefore, Theorem 2 does not occur in the dependency graph of Theorem 3

- 1) a) $\mathfrak{A}, \mathfrak{X} \models^{\exists^{\forall}} \neg \perp \stackrel{\text{sem.}}{\Leftrightarrow} \mathfrak{A}, \mathfrak{X} \not\models^{\forall \exists} \perp \stackrel{\text{sem.}}{\Leftrightarrow} \mathfrak{X} \neq \emptyset \stackrel{\text{sem.}}{\Leftrightarrow} \mathfrak{A}, \mathfrak{X} \models^{\exists^{\forall}} \top$.
b) $\mathfrak{A}, \mathfrak{X} \models^{\forall \exists} \neg \top \stackrel{\text{sem.}}{\Leftrightarrow} \mathfrak{A}, \mathfrak{X} \not\models^{\exists^{\forall}} \top \stackrel{\text{sem.}}{\Leftrightarrow} \mathfrak{X} = \emptyset \stackrel{\text{sem.}}{\Leftrightarrow} \mathfrak{A}, \mathfrak{X} \models^{\forall \exists} \perp$.
c) $\mathfrak{X} \models^{\alpha} \neg \neg \varphi \stackrel{\text{sem.}}{\Leftrightarrow} \mathfrak{X} \not\models^{\bar{\alpha}} \neg \varphi \stackrel{\text{sem.}}{\Leftrightarrow} \mathfrak{X} \models^{\alpha} \varphi$.
- 2) a) First, we prove that $\varphi \wedge \perp \equiv \perp$ holds. To this end, we show that if $\mathfrak{A}, \mathfrak{X} \models^{\exists^{\forall}} \varphi \wedge \perp$, then $\mathfrak{A}, \mathfrak{X} \models^{\exists^{\forall}} \perp$, and vice versa. By semantics, $\mathfrak{A}, \mathfrak{X} \models^{\exists^{\forall}} \varphi \wedge \perp$ implies that for all $(\mathfrak{X}_1, \mathfrak{X}_2) \in \text{par}(\mathfrak{X})$, it holds that $\mathfrak{A}, \mathfrak{X}_1 \models^{\exists^{\forall}} \varphi$ or $\mathfrak{A}, \mathfrak{X}_2 \models^{\exists^{\forall}} \perp$. In particular, since $(\emptyset, \mathfrak{X}) \in \text{par}(\mathfrak{X})$ and, by Item 1a of Lemma 3, $\mathfrak{A}, \emptyset \not\models^{\exists^{\forall}} \varphi$, we have that $\mathfrak{A}, \mathfrak{X} \models^{\exists^{\forall}} \perp$. Conversely, $\mathfrak{A}, \mathfrak{X} \models^{\exists^{\forall}} \perp$ means that $\emptyset \in \mathfrak{X}$. Thus, for every $(\mathfrak{X}_1, \mathfrak{X}_2) \in \text{par}(\mathfrak{X})$, it holds that $\emptyset \in \mathfrak{X}_1$ or $\emptyset \in \mathfrak{X}_2$. Thanks to Item 1b of Lemma 3, we have $\mathfrak{A}, \mathfrak{X}_1 \models^{\exists^{\forall}} \varphi$ or $\mathfrak{A}, \mathfrak{X}_2 \models^{\exists^{\forall}} \perp$, which, by semantics of \wedge , implies $\mathfrak{A}, \mathfrak{X} \models^{\exists^{\forall}} \varphi \wedge \perp$. To conclude, observe that $\varphi \wedge \perp \equiv \perp \wedge \varphi$ holds, due to commutativity of \wedge , formally proved below (Item 4a).
- b) First, we prove that $\varphi \wedge \top \equiv \varphi$ holds. To this end, we show that if $\mathfrak{A}, \mathfrak{X} \models^{\exists^{\forall}} \varphi \wedge \top$, then $\mathfrak{A}, \mathfrak{X} \models^{\exists^{\forall}} \varphi$, and vice versa. By semantics, $\mathfrak{A}, \mathfrak{X} \models^{\exists^{\forall}} \varphi \wedge \top$ implies that for all $(\mathfrak{X}_1, \mathfrak{X}_2) \in \text{par}(\mathfrak{X})$, it holds that $\mathfrak{A}, \mathfrak{X}_1 \models^{\exists^{\forall}} \varphi$ or $\mathfrak{A}, \mathfrak{X}_2 \models^{\exists^{\forall}} \top$. In particular, since $(\mathfrak{X}, \emptyset) \in \text{par}(\mathfrak{X})$ and, by Item 1a of Lemma 3, $\mathfrak{A}, \emptyset \not\models^{\exists^{\forall}} \top$, we have that $\mathfrak{A}, \mathfrak{X} \models^{\exists^{\forall}} \varphi$. Conversely, assume $\mathfrak{A}, \mathfrak{X} \models^{\exists^{\forall}} \varphi$ and let $(\mathfrak{X}_1, \mathfrak{X}_2) \in \text{par}(\mathfrak{X})$. If $\mathfrak{X}_1 = \mathfrak{X}$, then $\mathfrak{A}, \mathfrak{X}_1 \models^{\exists^{\forall}} \varphi$; if $\mathfrak{X}_1 \neq \mathfrak{X}$, then $\mathfrak{X}_2 \neq \emptyset$, and thus, by semantics of \top , it holds that $\mathfrak{A}, \mathfrak{X}_2 \models^{\exists^{\forall}} \top$. Therefore, for every $(\mathfrak{X}_1, \mathfrak{X}_2) \in \text{par}(\mathfrak{X})$, it holds that $\mathfrak{A}, \mathfrak{X}_1 \models^{\exists^{\forall}} \varphi$ or $\mathfrak{A}, \mathfrak{X}_2 \models^{\exists^{\forall}} \top$, which, by semantics of \wedge , implies $\mathfrak{A}, \mathfrak{X} \models^{\exists^{\forall}} \varphi \wedge \top$. To conclude, observe that $\varphi \wedge \top \equiv \top \wedge \varphi$ holds, due to commutativity of \wedge , formally proved below (Item 4a).
- 3) a) First, we prove that $\varphi \vee \top \equiv \top$ holds. To this end, we show that if $\mathfrak{A}, \mathfrak{X} \models^{\forall \exists} \varphi \vee \perp$, then $\mathfrak{A}, \mathfrak{X} \models^{\forall \exists} \top$, and vice versa. By semantics, $\mathfrak{A}, \mathfrak{X} \models^{\forall \exists} \varphi \vee \perp$ implies that there is $(\mathfrak{X}_1, \mathfrak{X}_2) \in \text{par}(\mathfrak{X})$ such that $\mathfrak{A}, \mathfrak{X}_1 \models^{\forall \exists} \varphi$ and $\mathfrak{A}, \mathfrak{X}_2 \models^{\forall \exists} \perp$. By Item 2b of Lemma 3, it must be $\emptyset \notin \mathfrak{X}_i$, for each $i \in \{1, 2\}$, and thus $\emptyset \notin \mathfrak{X}$, which, by semantics of \top , implies $\mathfrak{A}, \mathfrak{X} \models^{\forall \exists} \top$. Conversely, assume $\mathfrak{A}, \mathfrak{X} \models^{\forall \exists} \top$. The claim follows from the fact that $(\emptyset, \mathfrak{X}) \in \text{par}(\mathfrak{X})$ is such that $\mathfrak{A}, \emptyset \models^{\forall \exists} \varphi$ (by Item 2a of Lemma 3) and $\mathfrak{A}, \mathfrak{X} \models^{\forall \exists} \top$, which implies that $\mathfrak{A}, \mathfrak{X} \models^{\forall \exists} \varphi \vee \top$. To conclude, observe that $\varphi \vee \top \equiv \top \vee \varphi$ holds, due to commutativity of \vee , formally proved below (Item 4b).
- b) First, we prove that $\varphi \vee \perp \equiv \varphi$ holds. To this end, we show that if $\mathfrak{A}, \mathfrak{X} \models^{\forall \exists} \varphi \vee \perp$, then $\mathfrak{A}, \mathfrak{X} \models^{\forall \exists} \varphi$, and vice versa. By semantics, $\mathfrak{A}, \mathfrak{X} \models^{\forall \exists} \varphi \vee \perp$ implies that there is $(\mathfrak{X}_1, \mathfrak{X}_2) \in \text{par}(\mathfrak{X})$ such that $\mathfrak{A}, \mathfrak{X}_1 \models^{\forall \exists} \varphi$ and $\mathfrak{A}, \mathfrak{X}_2 \models^{\forall \exists} \perp$. From the latter, it follows $\mathfrak{X}_2 = \emptyset$, meaning that $\mathfrak{X}_1 = \mathfrak{X}$. Therefore, we have $\mathfrak{A}, \mathfrak{X} \models^{\forall \exists} \varphi$. Conversely, assume $\mathfrak{A}, \mathfrak{X} \models^{\forall \exists} \varphi$. The claim follows from the fact that $(\mathfrak{X}, \emptyset) \in \text{par}(\mathfrak{X})$ is such that $\mathfrak{A}, \mathfrak{X} \models^{\forall \exists} \varphi$ and $\mathfrak{A}, \emptyset \models^{\forall \exists} \perp$ (by semantics of \perp), which implies that $\mathfrak{A}, \mathfrak{X} \models^{\forall \exists} \varphi \vee \perp$. To

conclude, observe that $\varphi \vee \perp \equiv \perp \vee \varphi$ holds, due to commutativity of \vee , formally proved below (Item 4b).

- 4) Both Items 4a and 4b follow from the observation that $(\mathfrak{X}_1, \mathfrak{X}_2) \in \text{par}(\mathfrak{X})$ iff $(\mathfrak{X}_2, \mathfrak{X}_1) \in \text{par}(\mathfrak{X})$.
- 5) a) If $\mathfrak{A}, \mathfrak{X} \models^{\exists\forall} \varphi_1 \wedge \varphi_2$, then for all $(\mathfrak{X}_1, \mathfrak{X}_2) \in \text{par}(\mathfrak{X})$, it holds that $\mathfrak{A}, \mathfrak{X}_1 \models^{\exists\forall} \varphi_1$ or $\mathfrak{A}, \mathfrak{X}_2 \models^{\exists\forall} \varphi_2$. In particular, since $(\mathfrak{X}, \emptyset) \in \text{par}(\mathfrak{X})$, we have that $\mathfrak{A}, \mathfrak{X} \models^{\exists\forall} \varphi_1$.
b) The claim follows from the observation that partitioning is associative.
- 6) a) Assume $\mathfrak{A}, \mathfrak{X} \models^{\forall\exists} \varphi_1$. The claim follows from the fact that $(\mathfrak{X}, \emptyset) \in \text{par}(\mathfrak{X})$ is such that $\mathfrak{A}, \mathfrak{X} \models^{\forall\exists} \varphi_1$ and $\mathfrak{A}, \emptyset \models^{\forall\exists} \varphi_2$ (by Item 2a of Lemma 3), which implies that $\mathfrak{A}, \mathfrak{X} \models^{\forall\exists} \varphi_1 \vee \varphi_2$.
b) The claim follows from the observation that partitioning is associative.
- 7) a) $\mathfrak{A}, \mathfrak{X} \models^{\exists\forall} \neg(\neg\varphi_1 \vee \neg\varphi_2) \stackrel{\text{sem.}}{\Leftrightarrow} \mathfrak{A}, \mathfrak{X} \not\models^{\forall\exists} \neg\varphi_1 \vee \neg\varphi_2 \Leftrightarrow$ it does not hold that $\mathfrak{A}, \mathfrak{X} \models^{\forall\exists} \neg\varphi_1 \vee \neg\varphi_2 \stackrel{\text{sem.}}{\Leftrightarrow}$ there is no $(\mathfrak{X}_1, \mathfrak{X}_2) \in \text{par}(\mathfrak{X})$ such that $\mathfrak{A}, \mathfrak{X}_1 \models^{\forall\exists} \neg\varphi_1$ and $\mathfrak{A}, \mathfrak{X}_2 \models^{\forall\exists} \neg\varphi_2 \Leftrightarrow$ for all $(\mathfrak{X}_1, \mathfrak{X}_2) \in \text{par}(\mathfrak{X})$ it holds that $\mathfrak{A}, \mathfrak{X}_1 \not\models^{\forall\exists} \neg\varphi_1$ or $\mathfrak{A}, \mathfrak{X}_2 \not\models^{\forall\exists} \neg\varphi_2 \stackrel{\text{sem.}}{\Leftrightarrow}$ for all $(\mathfrak{X}_1, \mathfrak{X}_2) \in \text{par}(\mathfrak{X})$ it holds that $\mathfrak{A}, \mathfrak{X}_1 \models^{\exists\forall} \varphi_1$ or $\mathfrak{A}, \mathfrak{X}_2 \models^{\exists\forall} \varphi_2 \stackrel{\text{sem.}}{\Leftrightarrow} \mathfrak{A}, \mathfrak{X} \models^{\exists\forall} \varphi_1 \wedge \varphi_2$.
b) $\mathfrak{A}, \mathfrak{X} \models^{\forall\exists} \neg(\neg\varphi_1 \wedge \neg\varphi_2) \stackrel{\text{sem.}}{\Leftrightarrow} \mathfrak{A}, \mathfrak{X} \not\models^{\exists\forall} \neg\varphi_1 \wedge \neg\varphi_2 \Leftrightarrow$ it does not hold that $\mathfrak{A}, \mathfrak{X} \models^{\exists\forall} \neg\varphi_1 \wedge \neg\varphi_2 \stackrel{\text{sem.}}{\Leftrightarrow}$ there is $(\mathfrak{X}_1, \mathfrak{X}_2) \in \text{par}(\mathfrak{X})$ such that $\mathfrak{A}, \mathfrak{X}_1 \not\models^{\exists\forall} \neg\varphi_1$ and $\mathfrak{A}, \mathfrak{X}_2 \not\models^{\exists\forall} \neg\varphi_2 \stackrel{\text{sem.}}{\Leftrightarrow}$ there is $(\mathfrak{X}_1, \mathfrak{X}_2) \in \text{par}(\mathfrak{X})$ such that $\mathfrak{A}, \mathfrak{X}_1 \models^{\forall\exists} \varphi_1$ and $\mathfrak{A}, \mathfrak{X}_2 \models^{\forall\exists} \varphi_2 \stackrel{\text{sem.}}{\Leftrightarrow} \mathfrak{A}, \mathfrak{X} \models^{\forall\exists} \varphi_1 \vee \varphi_2$.
- 8) a) $\mathfrak{A}, \mathfrak{X} \models^{\exists\forall} \neg(\forall^{\pm w} x. \neg\varphi) \stackrel{\text{sem.}}{\Leftrightarrow} \mathfrak{A}, \mathfrak{X} \not\models^{\forall\exists} \forall^{\pm w} x. \neg\varphi \stackrel{\text{sem.}}{\Leftrightarrow} \mathfrak{A}, \text{ext}_{[\pm w]}(\mathfrak{X}, x) \not\models^{\forall\exists} \neg\varphi \stackrel{\text{sem.}}{\Leftrightarrow} \mathfrak{A}, \text{ext}_{[\pm w]}(\mathfrak{X}, x) \models^{\exists\forall} \varphi \stackrel{\text{sem.}}{\Leftrightarrow} \mathfrak{A}, \mathfrak{X} \models^{\exists\forall} \exists^{\pm w} x. \varphi$.
b) $\mathfrak{A}, \mathfrak{X} \models^{\forall\exists} \neg(\exists^{\pm w} x. \neg\varphi) \stackrel{\text{sem.}}{\Leftrightarrow} \mathfrak{A}, \mathfrak{X} \not\models^{\exists\forall} \exists^{\pm w} x. \neg\varphi \stackrel{\text{sem.}}{\Leftrightarrow} \mathfrak{A}, \text{ext}_{[\pm w]}(\mathfrak{X}, x) \not\models^{\exists\forall} \neg\varphi \stackrel{\text{sem.}}{\Leftrightarrow} \mathfrak{A}, \text{ext}_{[\pm w]}(\mathfrak{X}, x) \models^{\forall\exists} \varphi \stackrel{\text{sem.}}{\Leftrightarrow} \mathfrak{A}, \mathfrak{X} \models^{\forall\exists} \forall^{\pm w} x. \varphi$. \square



Figure A.5: Dependency graph of Theorem 4.

Theorem 4 (Prefix Extension). *Let $\wp\phi$ be an ADIF formula, where $\wp \in \text{Qn}$ is a quantifier prefix and ϕ is an arbitrary ADIF formula. Then, $\mathfrak{A}, \mathfrak{X} \models^\alpha \wp\phi$ iff $\mathfrak{A}, \text{ext}_\alpha(\mathfrak{X}, \wp) \models^\alpha \phi$, for all hypertteams $\mathfrak{X} \in \text{HAsg}_\subseteq(\text{sup}(\wp\phi))$.*

Proof. The claim follows from the more general Theorem 15, reported in Appendix C, by instantiating \mathfrak{F} with the empty function \emptyset . \square

The following result states *monotonicity* of the dualization, extension and partition operators *w.r.t.* the preorder \sqsubseteq .

Lemma 10 (Monotonicity I). *Let $\mathfrak{X}, \mathfrak{X}' \in \text{HASg}$ be two hypertteams with $\mathfrak{X} \sqsubseteq_W \mathfrak{X}'$, for some $W \subseteq \text{Vr}$. Then, the following hold true:*

- 1) $\overline{\mathfrak{X}'} \sqsubseteq_W \overline{\mathfrak{X}}$;
- 2) a) $\mathfrak{X} =_W \text{ext}_U(\mathfrak{X}, x)$, if $x \notin W$, with $U \subseteq \text{Vr}$;
b) $\text{ext}_U(\mathfrak{X}, x) \sqsubseteq_{W \cup \{x\}} \text{ext}_{U'}(\mathfrak{X}', x)$, with $x \in \text{Vr}$, $U \subseteq U' \subseteq \text{Vr}$, and $U \subseteq W$;
- 3) for every $(\mathfrak{X}'_1, \mathfrak{X}'_2) \in \text{par}(\mathfrak{X}')$, there is $(\mathfrak{X}_1, \mathfrak{X}_2) \in \text{par}(\mathfrak{X})$ such that $\mathfrak{X}_1 \sqsubseteq_W \mathfrak{X}'_1$ and $\mathfrak{X}_2 \sqsubseteq_W \mathfrak{X}'_2$.

Proof. 1) By $\mathfrak{X} \sqsubseteq_W \mathfrak{X}'$, there is a function $f : \mathfrak{X}|_W \rightarrow \mathfrak{X}'|_W$ such that $f(X|_W) \subseteq X|_W$ for all $X \in \mathfrak{X}$. Moreover, for all $X \in \mathfrak{X}$, since $f(X|_W) \subseteq X|_W$, there is a function $g_X : \bigcup\{X' \in \mathfrak{X}' \mid X'|_W = f(X|_W)\} \rightarrow X$ such that $\chi|_W = (g_X(\chi))|_W$ for all χ in $\bigcup\{X' \in \mathfrak{X}' \mid X'|_W = f(X|_W)\}$. In order to prove the claim, consider a generic team $X' \in \overline{\mathfrak{X}'}|_W$. We have to show that there is $X \in \overline{\mathfrak{X}}$ such that $X|_W \subseteq X'$. By the definition of $\overline{\mathfrak{X}'}|_W$, we have that $X' = (\text{img}(\mathfrak{b}'))|_W$, for some $\mathfrak{b}' \in \text{Chc}(\mathfrak{X}')$. We define $\mathfrak{b} \in \text{Chc}(\mathfrak{X})$ as: $\mathfrak{b}(X) = g_X(\mathfrak{b}'((f(X|_W))|_W^W))$ for all $X \in \mathfrak{X}$. Clearly, $(\text{img}(\mathfrak{b}))|_W \subseteq (\text{img}(\mathfrak{b}'))|_W = X'$. Since $(\text{img}(\mathfrak{b})) \in \overline{\mathfrak{X}}$, the thesis holds.

2a) The claim follows from the fact that for every $F \in \text{Fnc}$, $\chi \in \text{Asg}$, and $x \notin W$, it holds that $\text{ext}(\chi, F, x)|_W = \chi|_W$, which implies $\text{ext}(X, F, x)|_W = X|_W$ for every $X \in \mathfrak{X}$ and $F \in \text{Fnc}_U$, and the claim follows.

2b) By $\mathfrak{X} \sqsubseteq_W \mathfrak{X}'$, there is a function $f : \mathfrak{X}|_W \rightarrow \mathfrak{X}'|_W$ such that $f(X|_W) \subseteq X|_W$ for all $X \in \mathfrak{X}$. In order to prove the claim, take a generic team $\hat{X} \in \text{ext}_U(\mathfrak{X}, x)$. Thus, $\hat{X} = \text{ext}(X, F, x) = \{\text{ext}(\chi, F, x) \mid \chi \in X\}$, for some $X \in \mathfrak{X}$ and $F \in \text{Fnc}_U$. Let $X' = (f(X|_W))|_W^W \in \mathfrak{X}'$. Clearly, $X'|_W = f(X|_W) \subseteq X|_W$. Moreover, $\text{ext}(X', F, x) \in \text{ext}_{U'}(\mathfrak{X}', x)$, since $F \in \text{Fnc}_U \subseteq \text{Fnc}_{U'}$ (as $U \subseteq U'$). To complete the proof, it is enough to show that $\text{ext}(X', F, x)|_{W \cup \{x\}} \subseteq \hat{X}|_{W \cup \{x\}}$. To this purpose, take $\text{ext}(\chi', F, x)|_{W \cup \{x\}}$ for some $\chi' \in X'$. Observe that $\chi'|_W \in X'|_W = f(X|_W) \subseteq X|_W$, which means that there is $\chi \in X$ such that $\chi'|_W = \chi|_W$. Since $U \subseteq W$, it holds that $\chi|_U = \chi'|_U$, which implies $F(\chi) = F(\chi')$, as $F \in \text{Fnc}_U$. Therefore, $\text{ext}(\chi', F, x)|_{W \cup \{x\}} = \text{ext}(\chi, F, x)|_{W \cup \{x\}} \in \hat{X}|_{W \cup \{x\}}$.

3) By $\mathfrak{X} \sqsubseteq_W \mathfrak{X}'$, there is a function $f : \mathfrak{X}|_W \rightarrow \mathfrak{X}'|_W$ such that $f(X|_W) \subseteq X|_W$ for all $X \in \mathfrak{X}$. Let $(\mathfrak{X}'_1, \mathfrak{X}'_2) \in \text{par}(\mathfrak{X}')$ and define $\mathfrak{X}_i = \{X \in \mathfrak{X} \mid (f(X|_W))|_W^W \in \mathfrak{X}'_i\}$ for $i \in \{1, 2\}$. We have to show that $\mathfrak{X}_i \sqsubseteq_W \mathfrak{X}'_i$ ($i \in \{1, 2\}$). To this end, let $X \in \mathfrak{X}_i$ and consider team $(f(X|_W))|_W^W \in \mathfrak{X}'_i$. Clearly, $((f(X|_W))|_W^W)|_W = f(X|_W) \subseteq X|_W$. The thesis follows as $((f(X|_W))|_W^W)|_W \in \mathfrak{X}'_i|_W$. \square

Appendix B. Proofs of Section 3

Lemma 4 (FOL Dualisation). *The following equivalences hold, for all FOL formulae φ and hypertteams $\mathfrak{X} \in \text{HASg}_{\subseteq}(\text{sup}(\varphi))$.*

1) Statements 1a and 1b are equivalent:

- a) there exists a team $X \in \mathfrak{X}$ such that $\mathfrak{A}, \chi \models_{\text{FOL}} \varphi$, for all assignments $\chi \in X$;
- b) for all teams $X \in \overline{\mathfrak{X}}$, there exists an assignment $\chi \in X$ such that $\mathfrak{A}, \chi \models_{\text{FOL}} \varphi$.

2) Statements 2a and 2b are equivalent:

- a) for all teams $X \in \mathfrak{X}$, there exists an assignment $\chi \in X$ such that $\mathfrak{A}, \chi \models_{\text{FOL}} \varphi$;
- b) there exists a team $X \in \overline{\mathfrak{X}}$ such that $\mathfrak{A}, \chi \models_{\text{FOL}} \varphi$, for all assignments $\chi \in X$.

Proof. The first equivalence follows from Lemma 2, Item 1, by letting $\Psi = \{\chi \in \text{Asg}_{\subseteq}(\text{sup}(\varphi)) \mid \mathfrak{A}, \chi \models_{\text{FOL}} \varphi\}$. The second equivalence follows from the first one and from $\mathfrak{X} \equiv \overline{\mathfrak{X}}$ (Lemma 1). \square

Lemma 5 (FOL Quantifiers). *The following equivalences hold, for all FOL formulae φ , variables $x \in \text{Vr}$, and hyperteam $\mathfrak{X} \in \text{HAsg}_{\subseteq}(\text{V})$ with $\text{V} \triangleq \text{sup}(\varphi) \setminus \{x\}$.*

1) Statements 1a and 1b are equivalent:

- a) there exists a team $X \in \mathfrak{X}$ such that $\mathfrak{A}, \chi \models_{\text{FOL}} \exists x. \varphi$, for all $\chi \in X$;
- b) there exists a team $X \in \text{ext}_{\text{V}}(\mathfrak{X}, x)$ such that $\mathfrak{A}, \chi \models_{\text{FOL}} \varphi$, for all $\chi \in X$.

2) Statements 2a and 2b are equivalent:

- a) for all teams $X \in \mathfrak{X}$, there exists $\chi \in X$ such that $\mathfrak{A}, \chi \models_{\text{FOL}} \forall x. \varphi$;
- b) for all teams $X \in \text{ext}_{\text{V}}(\mathfrak{X}, x)$, there exists $\chi \in X$ such that $\mathfrak{A}, \chi \models_{\text{FOL}} \varphi$.

Proof. (1a \Rightarrow 1b) Let $X \in \mathfrak{X}$ be such that $\mathfrak{A}, \chi \models_{\text{FOL}} \exists x. \varphi$ holds for every $\chi \in X$. By the standard FOL semantics, for every $\chi \in X$, there is an element $a_{\chi} \in A$ such that $\mathfrak{A}, \chi[x \mapsto a_{\chi}] \models_{\text{FOL}} \varphi$. We safely assume that $a_{\chi_1} = a_{\chi_2}$ whenever $\chi_1 \upharpoonright_{\text{V}} = \chi_2 \upharpoonright_{\text{V}}$, for all $\chi_1, \chi_2 \in X$. Let $F \in \text{Fnc}_{\text{V}}$ be such that $F(\chi) = a_{\chi}$ for every $\chi \in X$ and let $X_F = \{\chi[x \mapsto F(\chi)] : \chi \in X\}$. Since $X_F \in \text{ext}_{\text{V}}(\mathfrak{X}, x)$ and $\mathfrak{A}, \chi \models_{\text{FOL}} \varphi$ holds for every $\chi \in X_F$, the thesis holds.

(1b \Rightarrow 1a) Let $X_F = \{\chi[x \mapsto F(\chi)] : \chi \in X\} \in \text{ext}_{\text{V}}(\mathfrak{X}, x)$, for some $X \in \mathfrak{X}$ and $F \in \text{Fnc}_{\text{V}}$, be such that $\mathfrak{A}, \chi \models_{\text{FOL}} \varphi$ holds for every $\chi \in X_F$. Clearly, by the standard FOL semantics, this implies that $\mathfrak{A}, \chi \models_{\text{FOL}} \exists x. \varphi$ holds for every $\chi \in X$, hence the thesis.

(2a \Leftrightarrow 2b) By statement 1 of this lemma, we have that 1a is false if and only if 1b is false (not 1a \Leftrightarrow not 1b, for short). By instantiating, in this last equivalence, φ with $\neg\varphi$, we have 1a' \Leftrightarrow 1b', where 1a' and 1b' are abbreviations for, respectively:

- for all teams $X \in \mathfrak{X}$, there exists an assignment $\chi \in X$ such that $\mathfrak{A}, \chi \not\models_{\text{FOL}} \exists x. \neg\varphi$;
- for all teams $X \in \text{ext}_V(\mathfrak{X}, x)$, there exists an assignment $\chi \in X$ such that $\mathfrak{A}, \chi \not\models_{\text{FOL}} \neg\varphi$.

By applying standard FOL semantics for negation and the duality of \exists and \forall in standard FOL, it is straightforward to see that **1a'** and **1b'** correspond to **2a** and **2b**, respectively, hence the thesis. \square

Lemma 6 (FOL Boolean Connectives). *The following equivalences hold, for all FOL formulae φ_1 and φ_2 and hyperteams $\mathfrak{X} \in \text{HAsg}_{\subseteq}(\mathbb{V})$ with $\mathbb{V} \triangleq \text{sup}(\varphi_1) \cup \text{sup}(\varphi_2)$.*

1) *Statements **1a** and **1b** are equivalent:*

- a) *there exists a team $X \in \mathfrak{X}$ such that $\mathfrak{A}, \chi \models_{\text{FOL}} \varphi_1 \wedge \varphi_2$, for all $\chi \in X$;*
- b) *for each bipartition $(\mathfrak{X}_1, \mathfrak{X}_2) \in \text{par}(\mathfrak{X})$, there exist an index $i \in \{1, 2\}$ and a team $X \in \mathfrak{X}_i$ such that $\mathfrak{A}, \chi \models_{\text{FOL}} \varphi_i$, for all $\chi \in X$.*

2) *Statements **2a** and **2b** are equivalent:*

- a) *for all teams $X \in \mathfrak{X}$, there exists $\chi \in X$ such that $\mathfrak{A}, \chi \models_{\text{FOL}} \varphi_1 \vee \varphi_2$;*
- b) *there exists a bipartition $(\mathfrak{X}_1, \mathfrak{X}_2) \in \text{par}(\mathfrak{X})$ such that, for all indexes $i \in \{1, 2\}$ and teams $X \in \mathfrak{X}_i$, it holds that $\mathfrak{A}, \chi \models_{\text{FOL}} \varphi_i$, for some $\chi \in X$.*

Proof. (**1a** \Rightarrow **1b**) Let $X \in \mathfrak{X}$ be such that $\mathfrak{A}, \chi \models_{\text{FOL}} \varphi_1 \wedge \varphi_2$ holds for every $\chi \in X$ and consider an arbitrary pair $(\mathfrak{X}_1, \mathfrak{X}_2) \in \text{par}(\mathfrak{X})$. Since $(\mathfrak{X}_1, \mathfrak{X}_2)$ is a partition of \mathfrak{X} , either $X \in \mathfrak{X}_1$ or $X \in \mathfrak{X}_2$: in the former case, let $i = 1$; in the latter, let $i = 2$. Since $X \in \mathfrak{X}_i$ and $\mathfrak{A}, \chi \models_{\text{FOL}} \varphi_i$ holds for every $\chi \in X$, the thesis holds.

(**1b** \Rightarrow **1a**) Consider the hyperteam $\mathfrak{X}'_1 = \{X \in \mathfrak{X} : \forall \chi \in X. \mathfrak{A}, \chi \models_{\text{FOL}} \varphi_1\}$ and the pair $(\mathfrak{X}_1 \triangleq \mathfrak{X} \setminus \mathfrak{X}'_1, \mathfrak{X}_2 \triangleq \mathfrak{X}'_1) \in \text{par}(\mathfrak{X})$. Observe that, by definition of \mathfrak{X}_1 , there is no $X \in \mathfrak{X}_1$ such that $\mathfrak{A}, \chi \models_{\text{FOL}} \varphi_1$ holds for every $\chi \in X$. Thus, by **1b**, there must exist $X \in \mathfrak{X}_2$ such that $\mathfrak{A}, \chi \models_{\text{FOL}} \varphi_2$ holds for every $\chi \in X$. By definition of \mathfrak{X}_2 , it also holds that $\mathfrak{A}, \chi \models_{\text{FOL}} \varphi_1$ for every $\chi \in X$, hence the thesis.

(**2a** \Leftrightarrow **2a**) By statement **1** of this lemma, we have that **1a** is false if and only if **1b** is false (*not 1a* \Leftrightarrow *not 1b*, for short). By instantiating, in this last equivalence, φ_1 with $\neg\varphi_1$ and φ_2 with $\neg\varphi_2$, we have **1a'** \Leftrightarrow **1b'**, where **1a'** and **1b'** are abbreviations for, respectively:

- for all teams $X \in \mathfrak{X}$, there exists an assignment $\chi \in X$ such that $\mathfrak{A}, \chi \not\models_{\text{FOL}} \neg\varphi_1 \wedge \neg\varphi_2$;
- there exists a pair of hyperteams $(\mathfrak{X}_1, \mathfrak{X}_2) \in \text{par}(\mathfrak{X})$ such that, for all indexes $i \in \{1, 2\}$ and teams $X \in \mathfrak{X}_i$, there exists an assignment $\chi \in X$ for which it holds that $\mathfrak{A}, \chi \not\models_{\text{FOL}} \neg\varphi_i$.

By applying semantics of negation and De Morgan's laws, it is straightforward to see that $1a'$ and $1b'$ correspond to $2a$ and $2a$, respectively, hence the thesis. \square

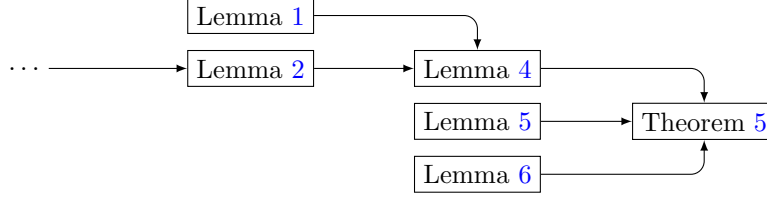

Figure B.6: Dependency graph of Theorem 5.

Theorem 5 (FOL Adequacy). *For all FOL formulae φ and hypertteams $\mathfrak{X} \in \text{HASg}_{\subseteq}(\text{sup}(\varphi))$, it holds that:*

- 1) $\mathfrak{A}, \mathfrak{X} \models^{\exists\forall} \varphi$ iff there exists a team $X \in \mathfrak{X}$ such that, for all assignments $\chi \in X$, it holds that $\mathfrak{A}, \chi \models_{\text{FOL}} \varphi$;
- 2) $\mathfrak{A}, \mathfrak{X} \models^{\forall\exists} \varphi$ iff, for all teams $X \in \mathfrak{X}$, there exists an assignment $\chi \in X$ such that $\mathfrak{A}, \chi \models_{\text{FOL}} \varphi$.

Proof. Both Items 1 and 2 are proved together, by induction on the structure of the formula.

- If φ is an atomic formula, *i.e.*, it is \perp or \top , or it has the form $R(\vec{x})$, then the claims immediately follow from the semantics (Definition 2, Items 1–3).
- If $\varphi = \neg\phi$, then we have, by semantics, $\mathfrak{A}, \mathfrak{X} \models^{\alpha} \varphi$ if and only if $\mathfrak{A}, \mathfrak{X} \not\models^{\bar{\alpha}} \phi$. If $\alpha = \exists\forall$, then, by inductive hypothesis, it is not the case that for every $X \in \mathfrak{X}$ there is $\chi \in X$ such that $\mathfrak{A}, \chi \models_{\text{FOL}} \phi$, which amounts to say that there is $X \in \mathfrak{X}$ such that for every $\chi \in X$ it holds $\mathfrak{A}, \chi \not\models_{\text{FOL}} \phi$, from which the thesis follows. If, instead, $\alpha = \forall\exists$, then, by inductive hypothesis, there is no $X \in \mathfrak{X}$ such that for every $\chi \in X$ it holds $\mathfrak{A}, \chi \models_{\text{FOL}} \phi$, which amounts to say that for every $X \in \mathfrak{X}$ there is $\chi \in X$ such that $\mathfrak{A}, \chi \not\models_{\text{FOL}} \phi$, from which the thesis follows.
- If $\varphi = \varphi_1 \wedge \varphi_2$ and $\alpha = \exists\forall$, then we have, by semantics, $\mathfrak{A}, \mathfrak{X} \models^{\alpha} \varphi$ if and only if for every $(\mathfrak{X}_1, \mathfrak{X}_2) \in \text{par}(\mathfrak{X})$ it holds that $\mathfrak{A}, \mathfrak{X}_1 \models^{\alpha} \varphi_1$ or $\mathfrak{A}, \mathfrak{X}_2 \models^{\alpha} \varphi_2$. By inductive hypothesis, this amounts to say that for every $(\mathfrak{X}_1, \mathfrak{X}_2) \in \text{par}(\mathfrak{X})$ there is $i \in \{1, 2\}$ and $X \in \mathfrak{X}_i$ such that for every $\chi \in X$ it holds $\mathfrak{A}, \chi \models_{\text{FOL}} \varphi_i$. The thesis follows from Lemma 6, Item 1.

If $\varphi = \varphi_1 \wedge \varphi_2$ and $\alpha = \forall\exists$, then we have, by semantics, $\mathfrak{A}, \mathfrak{X} \models^{\alpha} \varphi$ if and only if $\mathfrak{A}, \bar{\mathfrak{X}} \models^{\bar{\alpha}} \varphi$. By proceeding as before, *i.e.*, by applying semantics,

inductive hypothesis, and Lemma 6, Item 1, we have that there is $X' \in \overline{\mathfrak{X}}$ such that for every $\chi' \in X'$ it holds $\mathfrak{A}, \chi' \models_{\text{FOL}} \varphi$. The thesis follows from Lemma 4, Item 2.

- If $\varphi = \varphi_1 \vee \varphi_2$ and $\alpha = \forall\exists$, then we have, by semantics, $\mathfrak{A}, \mathfrak{X} \models^\alpha \varphi$ if and only if there is $(\mathfrak{X}_1, \mathfrak{X}_2) \in \text{par}(\mathfrak{X})$ such that $\mathfrak{A}, \mathfrak{X}_1 \models^\alpha \varphi_1$ and $\mathfrak{A}, \mathfrak{X}_2 \models^\alpha \varphi_2$. By inductive hypothesis, this amounts to say that there is $(\mathfrak{X}_1, \mathfrak{X}_2) \in \text{par}(\mathfrak{X})$ such that for every $i \in \{1, 2\}$ and $X \in \mathfrak{X}_i$ there is $\chi \in X$ for which it holds $\mathfrak{A}, \chi \models_{\text{FOL}} \varphi_i$. The thesis follows from Lemma 6, Item 2.

If $\varphi = \varphi_1 \vee \varphi_2$ and $\alpha = \exists\forall$, then we have, by semantics, $\mathfrak{A}, \mathfrak{X} \models^\alpha \varphi$ if and only if $\mathfrak{A}, \overline{\mathfrak{X}} \models^{\overline{\alpha}} \varphi$. By proceeding as before, i.e., by applying semantics, inductive hypothesis, and Lemma 6, Item 2, we have that for every $X' \in \overline{\mathfrak{X}}$ there is $\chi' \in X'$ such that $\mathfrak{A}, \chi' \models_{\text{FOL}} \varphi$. The thesis follows from Lemma 4, Item 1.

- If $\varphi = \exists x.\phi$ and $\alpha = \exists\forall$, then we have, by semantics, $\mathfrak{A}, \mathfrak{X} \models^\alpha \varphi$ if and only if $\mathfrak{A}, \text{ext}_{\text{sup}(\phi)\setminus\{x\}}(\mathfrak{X}, x) \models^\alpha \phi$. By inductive hypothesis, this amounts to say that there is $X \in \text{ext}_{\text{sup}(\phi)\setminus\{x\}}(\mathfrak{X}, x)$ such that for every $\chi \in X$ it holds $\mathfrak{A}, \chi \models_{\text{FOL}} \phi$. The thesis follows from Lemma 5, Item 1.

If $\varphi = \exists x.\phi$ and $\alpha = \forall\exists$, then we have, by semantics, $\mathfrak{A}, \mathfrak{X} \models^\alpha \varphi$ if and only if $\mathfrak{A}, \overline{\mathfrak{X}} \models^{\overline{\alpha}} \varphi$. By proceeding as before, i.e., by applying semantics, inductive hypothesis, and Lemma 5, Item 1, we have that there is $X' \in \overline{\mathfrak{X}}$ such that for every $\chi' \in X'$ it holds $\mathfrak{A}, \chi' \models_{\text{FOL}} \varphi$. The thesis follows from Lemma 4, Item 2.

- If $\varphi = \forall x.\phi$ and $\alpha = \forall\exists$, then we have, by semantics, $\mathfrak{A}, \mathfrak{X} \models^\alpha \varphi$ if and only if $\mathfrak{A}, \text{ext}_{\text{sup}(\phi)\setminus\{x\}}(\mathfrak{X}, x) \models^\alpha \phi$. By inductive hypothesis, this amounts to say that for every $X \in \text{ext}_{\text{sup}(\phi)\setminus\{x\}}(\mathfrak{X}, x)$ there is $\chi \in X$ such that $\mathfrak{A}, \chi \models_{\text{FOL}} \phi$. The thesis follows from Lemma 5, Item 2.

If $\varphi = \forall x.\phi$ and $\alpha = \exists\forall$, then we have, by semantics, $\mathfrak{A}, \mathfrak{X} \models^\alpha \varphi$ if and only if $\mathfrak{A}, \overline{\mathfrak{X}} \models^{\overline{\alpha}} \varphi$. By proceeding as before, i.e., by applying semantics, inductive hypothesis, and Lemma 5, Item 2, we have that for every $X' \in \overline{\mathfrak{X}}$ there is $\chi' \in X'$ such that $\mathfrak{A}, \chi' \models_{\text{FOL}} \varphi$. The thesis follows from Lemma 4, Item 1. \square

Lemma 7 (Cylindrical Extension). *Let $\mathfrak{X} \in \text{HAsg}$ be a hyperteam. Then, $\text{cyl}(\mathfrak{X}, x) \equiv \text{ext}_W(\overline{\mathfrak{X}}, x)$, for all variables $x \in \text{Vr}$ and sets of variables W , with $\text{vr}(\mathfrak{X}) \subseteq W \subseteq \text{Vr}$.*

Proof. The proof is done by showing the two directions of the equivalence.

First, we prove the following:

$$\text{cyl}(\mathfrak{X}, x) \subseteq \overline{\text{ext}_W(\mathfrak{X}, x)}.$$

Let $X_u \in \text{cyl}(\mathfrak{X}, x)$. There is $X \in \mathfrak{X}$ such that $X_u = \text{cyl}(X, x)$. Remark that for every $X' \in \overline{\mathfrak{X}}$ there is $\chi_{X'} \in X' \cap X$. Then, for every $F \in \text{Fnc}_W$, it holds

that $\chi_{X'}[x \mapsto F(\chi_{X'})] \in X_u$. Now, observe that for every $\hat{X} \in \text{ext}_W(\overline{\mathfrak{X}}, x)$, there is $X' \in \overline{\mathfrak{X}}$ and $F \in \text{Fnc}_W$ such that $\hat{X} = \text{ext}(X', F, x)$. Consider $\mathfrak{d} \in \text{Chc}(\text{ext}_W(\overline{\mathfrak{X}}, x))$ defined as follows. For every $\hat{X} \in \text{ext}_W(\overline{\mathfrak{X}}, x)$, we define $\mathfrak{d}(\hat{X}) = \chi_{X'}[x \mapsto F(\chi_{X'})]$. We can deduce immediately that $\text{img}(\mathfrak{d}) \subseteq X_u$.

We turn now to showing that

$$\overline{\text{ext}_W(\overline{\mathfrak{X}}, x)} \sqsubseteq \text{cyl}(\mathfrak{X}, x).$$

Let $\mathring{X} \in \overline{\text{ext}_W(\overline{\mathfrak{X}}, x)}$. We have $\mathring{X} = \text{img}(\mathring{\mathfrak{d}})$ for some choice function $\mathring{\mathfrak{d}} \in \text{Chc}(\text{ext}_W(\overline{\mathfrak{X}}, x))$. Then,

$$\forall F \in \text{Fnc}_W, \forall X' \in \overline{\mathfrak{X}}, \exists \chi' \in X' \text{ s.t. } \chi'[x \mapsto F(\chi')] \in \mathring{X}. \quad (\text{B.1})$$

Toward contradiction, assume that $\text{cyl}(X, x) \not\subseteq \mathring{X}$ for all $X \in \mathfrak{X}$. Then for all $X \in \mathfrak{X}$, there is $\chi_X \in X$ and $a_X \in A$ such that $\chi_X[x \mapsto a_X] \notin \mathring{X}$. We assume that $a_{X_1} = a_{X_2}$ if $\chi_{X_1} = \chi_{X_2}$ so that each χ is associated with only one $a \in A$. Consider $\mathfrak{d} \in \text{Chc}(\mathfrak{X})$ such that $\mathfrak{d}(X) = \chi_X$ for all $X \in \mathfrak{X}$, and $F \in \text{Fnc}_W$ such that $F(\chi_X) = a_X$ for all $X \in \mathfrak{X}$. By construction, for all $\chi' \in \text{img}(\mathfrak{d})$, it holds that $\chi'[x \mapsto F(\chi')] \notin \mathring{X}$ and, since $\text{img}(\mathfrak{d}) \in \overline{\mathfrak{X}}$, we have a contradiction with (B.1). \square

Lemma 8 (Team Partitioning). *Let $\mathfrak{X} \in \text{HAsg}$ be a hyperteam. Then:*

- 1) *for all hyperteam bipartitions $(\mathfrak{X}_1, \mathfrak{X}_2) \in \text{par}(\overline{\mathfrak{X}})$ and teams $Y_1 \in \overline{\mathfrak{X}_1}$ and $Y_2 \in \overline{\mathfrak{X}_2}$, there exists a team $X \in \mathfrak{X}$ such that $X \subseteq Y_1 \cup Y_2$;*
- 2) *for all teams $X \in \mathfrak{X}$ and team bipartitions $(X_1, X_2) \in \text{par}(X)$, there exist a hyperteam bipartition $(\mathfrak{X}_1, \mathfrak{X}_2) \in \text{par}(\overline{\mathfrak{X}})$ and two teams $Y_1 \in \overline{\mathfrak{X}_1}$ and $Y_2 \in \overline{\mathfrak{X}_2}$ such that $Y_1 \subseteq X_1$ and $Y_2 \subseteq X_2$.*

Proof. In the following, we assume index i to range over $\{1, 2\}$.

- 1) Let $(\mathfrak{X}_1, \mathfrak{X}_2) \in \text{par}(\overline{\mathfrak{X}})$ and $Y_i \in \overline{\mathfrak{X}_i}$. Then, there are $\mathfrak{d}_i \in \text{Chc}(\mathfrak{X}_i)$ such that $Y_i = \text{img}(\mathfrak{d}_i)$. Let $\mathfrak{d} \in \text{Chc}(\overline{\mathfrak{X}})$ be defined as: $\mathfrak{d}(X) = \mathfrak{d}_i(X)$ if $X \in \mathfrak{X}_i$, for all $X \in \overline{\mathfrak{X}}$. It clearly holds that $\text{img}(\mathfrak{d}) = \text{img}(\mathfrak{d}_1) \cup \text{img}(\mathfrak{d}_2)$ and $\text{img}(\mathfrak{d}) \in \overline{\mathfrak{X}}$. Finally, thanks to Lemma 1, there is $X^* \in \mathfrak{X}$ such that $X^* \subseteq \text{img}(\mathfrak{d}) = Y_1 \cup Y_2$.
- 2) Let $X \in \mathfrak{X}$ and $(X_1, X_2) \in \text{par}(X)$. Consider \mathfrak{X}_1 and \mathfrak{X}_2 defined as follows: $\mathfrak{X}_1 = \{\text{img}(\mathfrak{d}) \mid \mathfrak{d} \in \text{Chc}(\mathfrak{X}) \text{ and } \mathfrak{d}(X) \in X_1\}$ and $\mathfrak{X}_2 = \mathfrak{X} \setminus \mathfrak{X}_1$. Clearly, it holds that $(\mathfrak{X}_1, \mathfrak{X}_2) \in \text{par}(\overline{\mathfrak{X}})$. Moreover, for every $X'_i \in \mathfrak{X}_i$, it holds that $X'_i \cap X_i \neq \emptyset$. Let $\mathfrak{d}_i \in \text{Chc}(\mathfrak{X}_i)$ be such that $\mathfrak{d}_i(X'_i) \in Y_i \cap X_i$, for every $X'_i \in \mathfrak{X}_i$. Then, $\text{img}(\mathfrak{d}_i) \in \overline{\mathfrak{X}_i}$ is such that $\text{img}(\mathfrak{d}_i) \subseteq X_i$. \square

Theorem 6 (DIF Adequacy). *For all \exists/\forall -DIF formulae $\varphi^\exists/\varphi^\forall$ and hyperteam $\mathfrak{X} \in \text{HAsg}_{\subseteq}(\text{sup}(\varphi^\exists/\varphi^\forall))$, it holds that:*

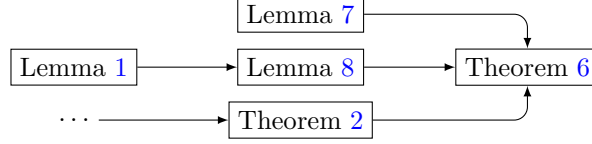

Figure B.7: Dependency graph of Theorem 6.

- 1) $\mathfrak{A}, \mathfrak{X} \models^{\exists^{\forall}} \varphi^{\exists}$ iff there exists a team $X \in \mathfrak{X}$ such that $\mathfrak{A}, X \models_{\text{DIF}}^{\forall} \varphi^{\exists}$;
- 2) $\mathfrak{A}, \mathfrak{X} \models^{\forall^{\exists}} \varphi^{\forall}$ iff, for all teams $X \in \mathfrak{X}$, it holds that $\mathfrak{A}, X \models_{\text{DIF}}^{\exists} \varphi^{\forall}$.

Proof. In the following, we assume index i to range over $\{1, 2\}$.

To begin with, we prove Item 1. The proof is done by structural induction on the formula φ^{\exists} .

(base case) If $\varphi^{\exists} = R(\vec{x})$ or $\varphi^{\exists} = \neg R(\vec{x})$, then the property holds by the semantics rules.

(inductive cases) Suppose that the property holds for the subformulae of φ^{\exists} .

($\varphi^{\exists} = \varphi_1 \wedge \varphi_2$) $\mathfrak{A}, \mathfrak{X} \models^{\exists^{\forall}} \varphi_1 \wedge \varphi_2 \stackrel{\text{sem.}}{\Leftrightarrow}$ for all $(\mathfrak{X}_1, \mathfrak{X}_2) \in \text{par}(\mathfrak{X})$ it holds that $\mathfrak{A}, \mathfrak{X}_1 \models^{\exists^{\forall}} \varphi_1$ or $\mathfrak{A}, \mathfrak{X}_2 \models^{\exists^{\forall}} \varphi_2 \stackrel{\text{ind.hyp.}}{\Leftrightarrow}$ for all $(\mathfrak{X}_1, \mathfrak{X}_2) \in \text{par}(\mathfrak{X})$ it holds that there is $X_1 \in \mathfrak{X}_1$ for which it holds $\mathfrak{A}, X_1 \models_{\text{DIF}}^{\forall} \varphi_1$ or there is $X_2 \in \mathfrak{X}_2$ for which it holds $\mathfrak{A}, X_2 \models_{\text{DIF}}^{\forall} \varphi_2 \Leftrightarrow$ there is $X \in \mathfrak{X}$ such that $\mathfrak{A}, X \models_{\text{DIF}}^{\forall} \varphi_1$ and $\mathfrak{A}, X \models_{\text{DIF}}^{\forall} \varphi_2 \stackrel{\text{DIF}^{\text{sem.}}}{\Leftrightarrow}$ there is $X \in \mathfrak{X}$ such that $\mathfrak{A}, X \models_{\text{DIF}}^{\forall} \varphi_1 \wedge \varphi_2$.

($\varphi^{\exists} = \varphi_1 \vee \varphi_2$) If $\mathfrak{A}, \mathfrak{X} \models^{\exists^{\forall}} \varphi_1 \vee \varphi_2$, then $\mathfrak{A}, \overline{\mathfrak{X}} \models^{\forall^{\exists}} \varphi_1 \vee \varphi_2$. By semantics, there is $(\mathfrak{X}_1, \mathfrak{X}_2) \in \text{par}(\overline{\mathfrak{X}})$ such that $\mathfrak{A}, \mathfrak{X}_1 \models^{\forall^{\exists}} \varphi_1$ and $\mathfrak{A}, \mathfrak{X}_2 \models^{\forall^{\exists}} \varphi_2$, which amounts to say that there is $(\mathfrak{X}_1, \mathfrak{X}_2) \in \text{par}(\overline{\mathfrak{X}})$ such that $\mathfrak{A}, \overline{\mathfrak{X}_1} \models^{\exists^{\forall}} \varphi_1$ and $\mathfrak{A}, \overline{\mathfrak{X}_2} \models^{\exists^{\forall}} \varphi_2$. By inductive hypothesis, there are $X_1 \in \overline{\mathfrak{X}_1}$ and $X_2 \in \overline{\mathfrak{X}_2}$ such that $\mathfrak{A}, X_1 \models_{\text{DIF}}^{\forall} \varphi_1$ and $\mathfrak{A}, X_2 \models_{\text{DIF}}^{\forall} \varphi_2$. By Item 1 of Lemma 8, there is $X \in \mathfrak{X}$ such that $X \subseteq X_1 \cup X_2$. Then, $\mathfrak{A}, X \models_{\text{DIF}}^{\forall} \varphi_1 \vee \varphi_2$.

Conversely, if there is $X \in \mathfrak{X}$ such that $\mathfrak{A}, X \models_{\text{DIF}}^{\forall} \varphi_1 \vee \varphi_2$, then there is $(X_1, X_2) \in \text{par}(X)$ such that $\mathfrak{A}, X_i \models_{\text{DIF}}^{\forall} \varphi_i$. By Item 2 of Lemma 8, there are $(\mathfrak{X}_1, \mathfrak{X}_2) \in \text{par}(\overline{\mathfrak{X}})$ and $Y_i \in \overline{\mathfrak{X}_i}$ such that $Y_i \subseteq X_i$. Then, it holds that $\mathfrak{A}, Y_i \models_{\text{DIF}}^{\forall} \varphi_i$. By inductive hypothesis, we have $\mathfrak{A}, \overline{\mathfrak{X}_i} \models^{\exists^{\forall}} \varphi_i$, or, equivalently, $\mathfrak{A}, \mathfrak{X}_i \models^{\forall^{\exists}} \varphi_i$. Therefore, there is $(\mathfrak{X}_1, \mathfrak{X}_2) \in \text{par}(\overline{\mathfrak{X}})$ such that $\mathfrak{A}, \mathfrak{X}_i \models^{\forall^{\exists}} \varphi_i$, which implies $\mathfrak{A}, \overline{\mathfrak{X}} \models^{\exists^{\forall}} \varphi_1 \vee \varphi_2$, and we can conclude $\mathfrak{A}, \mathfrak{X} \models^{\exists^{\forall}} \varphi_1 \vee \varphi_2$.

($\varphi^{\exists} = \exists^{\pm W} x. \varphi$) $\mathfrak{A}, \mathfrak{X} \models^{\exists^{\forall}} \exists^{\pm W} x. \varphi \stackrel{\text{sem.}}{\Leftrightarrow} \mathfrak{A}, \text{ext}_{[\pm W]}(\mathfrak{X}, x) \models^{\exists^{\forall}} \varphi \stackrel{\text{ind.hyp.}}{\Leftrightarrow}$ there is $X \in \text{ext}_{[\pm W]}(\mathfrak{X}, x)$ such that $\mathfrak{A}, X \models_{\text{DIF}}^{\forall} \varphi \stackrel{\text{def.}}{\Leftrightarrow}$ there are $X \in \mathfrak{X}$ and

$F \in \text{Fnc}_{[\pm W]}$ such that $\mathfrak{A}, \text{ext}(X, F, x) \models_{\text{DIF}}^{\forall} \varphi \stackrel{\text{DIF-sem.}}{\Leftrightarrow}$ there is $X \in \mathfrak{X}$ such that $\mathfrak{A}, X \models_{\text{DIF}}^{\forall} \exists^{\pm W} x. \varphi$.
 $(\varphi^{\exists} = \forall^{-\emptyset} x. \varphi)$ $\mathfrak{A}, \mathfrak{X} \models^{\exists \forall} \forall^{-\emptyset} x. \varphi \stackrel{\text{sem.}}{\Leftrightarrow} \mathfrak{A}, \overline{\mathfrak{X}} \models^{\forall \exists} \forall^{-\emptyset} x. \varphi \stackrel{\text{sem.}}{\Leftrightarrow} \mathfrak{A}, \text{ext}_{\text{Vr}}(\overline{\mathfrak{X}}, x) \models^{\forall \exists} \varphi$
 $\stackrel{\text{Thm. 2}}{\Leftrightarrow} \mathfrak{A}, \overline{\text{ext}_{\text{Vr}}(\overline{\mathfrak{X}}, x)} \models^{\exists \forall} \varphi \stackrel{\text{Lemma 7}}{\Leftrightarrow} \mathfrak{A}, \text{cyl}(\overline{\mathfrak{X}}, x) \models^{\exists \forall} \varphi \stackrel{\text{ind.hp.}}{\Leftrightarrow}$ there is $X \in \text{cyl}(\overline{\mathfrak{X}}, x)$ such that $\mathfrak{A}, X \models_{\text{DIF}}^{\forall} \varphi \stackrel{\text{def.}}{\Leftrightarrow}$ there is $X \in \mathfrak{X}$ such that $\mathfrak{A}, \text{cyl}(X, x) \models_{\text{DIF}}^{\forall} \varphi \stackrel{\text{DIF-sem.}}{\Leftrightarrow}$ there is $X \in \mathfrak{X}$ such that $\mathfrak{A}, X \models_{\text{DIF}}^{\forall} \forall^{-\emptyset} x. \varphi$.

We turn now to proving Item 2. We proceed by structural induction on the formula φ^{\forall} .

(base case) If $\varphi^{\forall} = R(\vec{x})$ or $\varphi^{\forall} = \neg R(\vec{x})$, then the property holds by the semantics rules.

(inductive cases) Suppose that the property holds for the subformulae of φ^{\forall} .

$(\varphi^{\forall} = \varphi_1 \wedge \varphi_2)$ We assume that $\mathfrak{A}, \mathfrak{X} \models^{\forall \exists} \varphi_1 \wedge \varphi_2$ and we show that for all teams $X \in \mathfrak{X}$, it holds that $\mathfrak{A}, X \models_{\text{DIF}}^{\exists} \varphi_1 \wedge \varphi_2$, which amount to showing that for all teams $X \in \mathfrak{X}$ and $(X_1, X_2) \in \text{par}(X)$, it holds that $\mathfrak{A}, X_1 \models_{\text{DIF}}^{\exists} \varphi_1$ or $\mathfrak{A}, X_2 \models_{\text{DIF}}^{\exists} \varphi_2$. To this end, we let $X \in \mathfrak{X}$ and $(X_1, X_2) \in \text{par}(X)$. By Item 2 of Lemma 8, there are $(\mathfrak{X}_1, \mathfrak{X}_2) \in \text{par}(\overline{\mathfrak{X}})$, $Y_1 \in \overline{\mathfrak{X}}_1$, and $Y_2 \in \overline{\mathfrak{X}}_2$, such that $Y_1 \subseteq X_1$ and $Y_2 \subseteq X_2$. From $\mathfrak{A}, \mathfrak{X} \models^{\forall \exists} \varphi_1 \wedge \varphi_2$, it follows that $\mathfrak{A}, \overline{\mathfrak{X}} \models^{\exists \forall} \varphi_1 \wedge \varphi_2$. By semantics, for all $(\mathfrak{X}_1, \mathfrak{X}_2) \in \text{par}(\overline{\mathfrak{X}})$ it holds that $\mathfrak{A}, \mathfrak{X}_1 \models^{\exists \forall} \varphi_1$ or $\mathfrak{A}, \mathfrak{X}_2 \models^{\exists \forall} \varphi_2$, which, by Theorem 2, amounts to saying that for all $(\mathfrak{X}_1, \mathfrak{X}_2) \in \text{par}(\overline{\mathfrak{X}})$ it holds that $\mathfrak{A}, \overline{\mathfrak{X}}_1 \models^{\forall \exists} \varphi_1$ or $\mathfrak{A}, \overline{\mathfrak{X}}_2 \models^{\forall \exists} \varphi_2$. By inductive hypothesis, for all $(\mathfrak{X}_1, \mathfrak{X}_2) \in \text{par}(\overline{\mathfrak{X}})$ it holds that $\mathfrak{A}, X_1 \models_{\text{DIF}}^{\exists} \varphi_1$ for all $X_1 \in \overline{\mathfrak{X}}_1$ or it holds that $\mathfrak{A}, X_2 \models_{\text{DIF}}^{\exists} \varphi_2$ for all $X_2 \in \overline{\mathfrak{X}}_2$. Equivalently, for all $(\mathfrak{X}_1, \mathfrak{X}_2) \in \text{par}(\overline{\mathfrak{X}})$, $X_1 \in \overline{\mathfrak{X}}_1$, and $X_2 \in \overline{\mathfrak{X}}_2$, it holds that $\mathfrak{A}, X_1 \models_{\text{DIF}}^{\exists} \varphi_1$ or $\mathfrak{A}, X_2 \models_{\text{DIF}}^{\exists} \varphi_2$. Therefore, we have that $\mathfrak{A}, Y_1 \models_{\text{DIF}}^{\exists} \varphi_1$ or $\mathfrak{A}, Y_2 \models_{\text{DIF}}^{\exists} \varphi_2$, and, due to $Y_1 \subseteq X_1$ and $Y_2 \subseteq X_2$, we conclude $\mathfrak{A}, X_1 \models_{\text{DIF}}^{\exists} \varphi_1$ or $\mathfrak{A}, X_2 \models_{\text{DIF}}^{\exists} \varphi_2$.

Conversely, assume that for all teams $X \in \mathfrak{X}$, it holds that $\mathfrak{A}, X \models_{\text{DIF}}^{\exists} \varphi_1 \wedge \varphi_2$, which amounts to saying that for all $X \in \mathfrak{X}$ and $(X_1, X_2) \in \text{par}(X)$, it holds that $\mathfrak{A}, X_1 \models_{\text{DIF}}^{\exists} \varphi_1$ or $\mathfrak{A}, X_2 \models_{\text{DIF}}^{\exists} \varphi_2$. First, we show that for all $(\mathfrak{X}_1, \mathfrak{X}_2) \in \text{par}(\overline{\mathfrak{X}})$, $X_1 \in \overline{\mathfrak{X}}_1$, and $X_2 \in \overline{\mathfrak{X}}_2$, it holds that $\mathfrak{A}, X_1 \models_{\text{DIF}}^{\exists} \varphi_1$ or $\mathfrak{A}, X_2 \models_{\text{DIF}}^{\exists} \varphi_2$. To this end, let $(\mathfrak{X}_1, \mathfrak{X}_2) \in \text{par}(\overline{\mathfrak{X}})$, $X_1 \in \overline{\mathfrak{X}}_1$, and $X_2 \in \overline{\mathfrak{X}}_2$. By Item 1 of Lemma 8, there exists a team $X \in \mathfrak{X}$ such that $X \subseteq X_1 \cup X_2$. Let $X'_1 = X_1 \cap X$ and $X'_2 = X \setminus X'_1$. Clearly, $(X'_1, X'_2) \in \text{par}(X)$, $X'_1 \subseteq X_1$, and $X'_2 \subseteq X_2$. By assumption, it holds that $\mathfrak{A}, X'_1 \models_{\text{DIF}}^{\exists} \varphi_1$ or $\mathfrak{A}, X'_2 \models_{\text{DIF}}^{\exists} \varphi_2$. From $X'_1 \subseteq X_1$, and $X'_2 \subseteq X_2$, it follows $\mathfrak{A}, X_1 \models_{\text{DIF}}^{\exists} \varphi_1$ or $\mathfrak{A}, X_2 \models_{\text{DIF}}^{\exists} \varphi_2$. Therefore, we have showed that for all $(\mathfrak{X}_1, \mathfrak{X}_2) \in \text{par}(\overline{\mathfrak{X}})$, $X_1 \in \overline{\mathfrak{X}}_1$, and $X_2 \in \overline{\mathfrak{X}}_2$

$\overline{\mathfrak{X}}_2$, it holds that $\mathfrak{A}, X_1 \models_{\text{DIF}}^{\exists} \varphi_1$ or $\mathfrak{A}, X_2 \models_{\text{DIF}}^{\exists} \varphi_2$. This amounts to saying that for all $(\mathfrak{X}_1, \mathfrak{X}_2) \in \text{par}(\overline{\mathfrak{X}})$, it holds that $\mathfrak{A}, X_1 \models_{\text{DIF}}^{\exists} \varphi_1$ for all $X_1 \in \overline{\mathfrak{X}}_1$ or it holds that $\mathfrak{A}, X_2 \models_{\text{DIF}}^{\exists} \varphi_2$ for all $X_2 \in \overline{\mathfrak{X}}_2$. By inductive hypothesis, we have that for all $(\mathfrak{X}_1, \mathfrak{X}_2) \in \text{par}(\overline{\mathfrak{X}})$, it holds that $\mathfrak{A}, \overline{\mathfrak{X}}_1 \models^{\exists\forall} \varphi_1$ or $\mathfrak{A}, \overline{\mathfrak{X}}_2 \models^{\exists\forall} \varphi_2$, which eventually amounts to saying $\mathfrak{A}, \overline{\mathfrak{X}} \models^{\forall\exists} \varphi_1 \wedge \varphi_2$.

$(\varphi^\vee = \varphi_1 \vee \varphi_2)$ $\mathfrak{A}, \mathfrak{X} \models^{\forall\exists} \varphi_1 \vee \varphi_2 \stackrel{\text{sem.}}{\Leftrightarrow}$ there is $(\mathfrak{X}_1, \mathfrak{X}_2) \in \text{par}(\mathfrak{X})$ such that $\mathfrak{A}, \mathfrak{X}_1 \models^{\forall\exists} \varphi_1$ and $\mathfrak{A}, \mathfrak{X}_2 \models^{\forall\exists} \varphi_2 \stackrel{\text{ind.hyp.}}{\Leftrightarrow}$ there is $(\mathfrak{X}_1, \mathfrak{X}_2) \in \text{par}(\mathfrak{X})$ such that for all $X_1 \in \mathfrak{X}_1$ it holds $\mathfrak{A}, X_1 \models_{\text{DIF}}^{\exists} \varphi_1$ and for all $X_2 \in \mathfrak{X}_2$ it holds $\mathfrak{A}, X_2 \models_{\text{DIF}}^{\exists} \varphi_2 \Leftrightarrow$ for all $X \in \mathfrak{X}$ it holds that $\mathfrak{A}, X \models_{\text{DIF}}^{\exists} \varphi_1$ or $\mathfrak{A}, X \models_{\text{DIF}}^{\exists} \varphi_2 \stackrel{\text{DIF;sem.}}{\Leftrightarrow}$ for all $X \in \mathfrak{X}$ it holds that $\mathfrak{A}, X \models_{\text{DIF}}^{\exists} \varphi_1 \vee \varphi_2$.

$(\varphi^\vee = \exists^{-\emptyset} x. \varphi)$ $\mathfrak{A}, \mathfrak{X} \models^{\forall\exists} \exists^{-\emptyset} x. \varphi \stackrel{\text{sem.}}{\Leftrightarrow} \mathfrak{A}, \overline{\mathfrak{X}} \models^{\exists\forall} \exists^{-\emptyset} x. \varphi \stackrel{\text{sem.}}{\Leftrightarrow} \mathfrak{A}, \text{ext}_{\text{Vr}}(\overline{\mathfrak{X}}, x) \models^{\exists\forall} \varphi \stackrel{\text{Thm. 2}}{\Leftrightarrow} \mathfrak{A}, \overline{\text{ext}_{\text{Vr}}(\overline{\mathfrak{X}}, x)} \models^{\forall\exists} \varphi \stackrel{\text{Lemma 7}}{\Leftrightarrow} \mathfrak{A}, \text{cyl}(\overline{\mathfrak{X}}, x) \models^{\forall\exists} \varphi \stackrel{\text{ind.hyp.}}{\Leftrightarrow}$ for all $X \in \text{cyl}(\overline{\mathfrak{X}}, x)$ it holds that $\mathfrak{A}, X \models_{\text{DIF}}^{\exists} \varphi \stackrel{\text{def.}}{\Leftrightarrow}$ for all $X \in \mathfrak{X}$ it holds that $\mathfrak{A}, \text{cyl}(X, x) \models_{\text{DIF}}^{\exists} \varphi \stackrel{\text{DIF;sem.}}{\Leftrightarrow}$ for all $X \in \mathfrak{X}$ it holds that $\mathfrak{A}, X \models_{\text{DIF}}^{\exists} \exists^{-\emptyset} x. \varphi$.

$(\varphi^\vee = \forall^{\pm W} x. \varphi)$ $\mathfrak{A}, \mathfrak{X} \models^{\forall\exists} \forall^{\pm W} x. \varphi \stackrel{\text{sem.}}{\Leftrightarrow} \mathfrak{A}, \text{ext}_{[\pm W]}(\mathfrak{X}, x) \models^{\forall\exists} \varphi \stackrel{\text{ind.hyp.}}{\Leftrightarrow}$ for all $X \in \text{ext}_{[\pm W]}(\mathfrak{X}, x)$ it holds that $\mathfrak{A}, X \models_{\text{DIF}}^{\exists} \varphi \stackrel{\text{def.}}{\Leftrightarrow}$ for all $X \in \mathfrak{X}$ and $F \in \text{Fnc}_{[\pm W]}$ it holds that $\mathfrak{A}, \text{ext}(X, F, x) \models_{\text{DIF}}^{\exists} \varphi \stackrel{\text{DIF;sem.}}{\Leftrightarrow}$ for all $X \in \mathfrak{X}$ it holds that $\mathfrak{A}, X \models_{\text{DIF}}^{\exists} \forall^{\pm W} x. \varphi$. \square

Appendix C. Proofs of Section 4

Lemma 11 (Generalised Empty & Null Hyperteams). *The following hold true for every META-ADIF formula φ , function assignment $\mathfrak{F} \in \text{FAsg}$, and hyperteam $\mathfrak{X} \in \text{HAsg}_{\subseteq}(\text{sup}(\varphi) \setminus \text{dom}(\mathfrak{F}))$.*

- 1) a) $\mathfrak{A}, \mathfrak{F}, \emptyset \not\models^{\exists\forall} \varphi$; b) $\mathfrak{A}, \mathfrak{F}, \mathfrak{X} \models^{\exists\forall} \varphi$, where $\emptyset \in \mathfrak{X}$;
- 2) a) $\mathfrak{A}, \mathfrak{F}, \emptyset \models^{\forall\exists} \varphi$; b) $\mathfrak{A}, \mathfrak{F}, \mathfrak{X} \not\models^{\forall\exists} \varphi$, where $\emptyset \in \mathfrak{X}$.

Proof. We proceed by structural induction on the size of φ . For the four inductive cases concerning the two binary Boolean connectives and the two standard quantifiers, it is useful to recall that, thanks to Proposition 1, $\overline{\emptyset} = \{\emptyset\}$ and $\overline{\mathfrak{X}} = \emptyset$ iff $\emptyset \in \mathfrak{X}$.

- **[Base case $\varphi = \perp$]** Both subitems of Item 1 directly follow from the meta-variant $\mathfrak{A}, \mathfrak{F}, \mathfrak{X} \models^{\exists\forall} \perp$ iff $\emptyset \in \mathfrak{X}$ – of Item 1a of Definition 2. Similarly, Item 2 follows from the variant $\mathfrak{A}, \mathfrak{F}, \mathfrak{X} \models^{\forall\exists} \perp$ iff $\mathfrak{X} = \emptyset$ – of Item 1b of the same definition.

- **[Base case $\varphi = \top$]** Both subitems of Item 2 directly follow from the meta-variant $\mathfrak{A}, \mathfrak{F}, \mathfrak{X} \models^{\forall\exists} \top$ iff $\emptyset \notin \mathfrak{X}$ – of Item 2a of Definition 2. Similarly, Item 1 follows from the variant $\mathfrak{A}, \mathfrak{F}, \mathfrak{X} \models^{\exists\forall} \top$ iff $\mathfrak{X} \neq \emptyset$ – of Item 2b of the same definition.
- **[Base case $\varphi = R(\vec{x})$]** By observing that $\text{ext}(\emptyset, \mathfrak{F}) = \emptyset$ and $\emptyset \in \mathfrak{X}$ iff $\emptyset \in \text{ext}(\mathfrak{X}, \mathfrak{F})$, it is easy to see that Items 1 and 2 immediately follows from Items 3a and 3b of Definition 6, respectively.
- **[Inductive case $\varphi = \neg\phi$]** Item 1a (resp., Item 1b, Item 2a, and Item 2b) follows from the meta-variant $\mathfrak{A}, \mathfrak{F}, \mathfrak{X} \models^{\alpha} \neg\phi$ iff $\mathfrak{A}, \mathfrak{F}, \mathfrak{X} \not\models^{\bar{\alpha}} \phi$ – of Item 4 of Definition 2 and Item 2a (resp., Item 2b, Item 1a, and Item 1b) of the inductive hypothesis applied to ϕ .
- **[Inductive case $\varphi = \phi_1 \wedge \phi_2$]** Items 2a and 2b directly follow from Items 1b and 1a, respectively, via the meta-variant $\mathfrak{A}, \mathfrak{F}, \mathfrak{X} \models^{\forall\exists} \phi_1 \wedge \phi_2$ iff $\mathfrak{A}, \mathfrak{F}, \bar{\mathfrak{X}} \models^{\exists\forall} \phi_1 \wedge \phi_2$ – of Item 5b of Definition 2. We can therefore focus on the latter two.
 - **[Item 1a]** By the meta-variant of Item 5a of Definition 2, it holds that $\mathfrak{A}, \mathfrak{F}, \emptyset \not\models^{\exists\forall} \varphi$ iff there exists a partitioning $(\mathfrak{X}_1, \mathfrak{X}_2) \in \text{par}(\emptyset)$ such that $\mathfrak{A}, \mathfrak{F}, \mathfrak{X}_1 \not\models^{\exists\forall} \phi_1$ and $\mathfrak{A}, \mathfrak{F}, \mathfrak{X}_2 \not\models^{\exists\forall} \phi_2$. Now, from the inductive hypothesis applied to ϕ_1 and ϕ_2 , it follows that $\mathfrak{A}, \mathfrak{F}, \emptyset \not\models^{\exists\forall} \phi_1$ and $\mathfrak{A}, \mathfrak{F}, \emptyset \not\models^{\exists\forall} \phi_2$. Moreover, $(\emptyset, \emptyset) \in \text{par}(\emptyset)$. Thus, the thesis clearly holds.
 - **[Item 1b]** By the meta-variant of Item 5a of Definition 2, it holds that $\mathfrak{A}, \mathfrak{F}, \mathfrak{X} \models^{\exists\forall} \varphi$ iff, for all partitioning $(\mathfrak{X}_1, \mathfrak{X}_2) \in \text{par}(\mathfrak{X})$, it holds that $\mathfrak{A}, \mathfrak{F}, \mathfrak{X}_1 \models^{\exists\forall} \phi_1$ or $\mathfrak{A}, \mathfrak{F}, \mathfrak{X}_2 \models^{\exists\forall} \phi_2$, where $\emptyset \in \mathfrak{X}$. Now, from the inductive hypothesis applied to ϕ_1 and ϕ_2 , it follows that $\mathfrak{A}, \mathfrak{F}, \mathfrak{X}' \models^{\exists\forall} \phi_1$ and $\mathfrak{A}, \mathfrak{F}, \mathfrak{X}' \models^{\exists\forall} \phi_2$, for every hyperteam \mathfrak{X}' such that $\emptyset \in \mathfrak{X}'$. Moreover, for every partitioning $(\mathfrak{X}_1, \mathfrak{X}_2) \in \text{par}(\mathfrak{X})$, one can observe that $\emptyset \in \mathfrak{X}_1$ or $\emptyset \in \mathfrak{X}_2$. Thus, the thesis clearly holds.
- **[Inductive case $\varphi = \phi_1 \vee \phi_2$]** Items 1a and 1b directly follow from Items 2b and 2a, respectively, via the meta-variant $\mathfrak{A}, \mathfrak{F}, \mathfrak{X} \models^{\exists\forall} \phi_1 \vee \phi_2$ iff $\mathfrak{A}, \mathfrak{F}, \bar{\mathfrak{X}} \models^{\forall\exists} \phi_1 \vee \phi_2$ – of Item 6a of Definition 2. We can therefore focus on the latter two.
 - **[Item 2a]** By the meta-variant of Item 6b of Definition 2, it holds that $\mathfrak{A}, \mathfrak{F}, \emptyset \models^{\forall\exists} \varphi$ iff there exists a partitioning $(\mathfrak{X}_1, \mathfrak{X}_2) \in \text{par}(\emptyset)$ such that $\mathfrak{A}, \mathfrak{F}, \mathfrak{X}_1 \models^{\forall\exists} \phi_1$ and $\mathfrak{A}, \mathfrak{F}, \mathfrak{X}_2 \models^{\forall\exists} \phi_2$. Now, by the inductive hypothesis applied to ϕ_1 and ϕ_2 , it follows that $\mathfrak{A}, \mathfrak{F}, \emptyset \models^{\forall\exists} \phi_1$ and $\mathfrak{A}, \mathfrak{F}, \emptyset \models^{\forall\exists} \phi_2$. Moreover, $(\emptyset, \emptyset) \in \text{par}(\emptyset)$. Thus, the thesis clearly holds.
 - **[Item 2b]** By the meta-variant of Item 6b of Definition 2, it holds that $\mathfrak{A}, \mathfrak{F}, \mathfrak{X} \not\models^{\forall\exists} \varphi$ iff, for all partitioning $(\mathfrak{X}_1, \mathfrak{X}_2) \in \text{par}(\mathfrak{X})$, it holds that $\mathfrak{A}, \mathfrak{F}, \mathfrak{X}_1 \not\models^{\forall\exists} \phi_1$ or $\mathfrak{A}, \mathfrak{F}, \mathfrak{X}_2 \not\models^{\forall\exists} \phi_2$, where $\emptyset \in \mathfrak{X}$. Now, by the inductive hypothesis applied to ϕ_1 and ϕ_2 , it follows that $\mathfrak{A}, \mathfrak{F}, \mathfrak{X}' \not\models^{\forall\exists} \phi_1$ and $\mathfrak{A}, \mathfrak{F}, \mathfrak{X}' \not\models^{\forall\exists} \phi_2$, for every hyperteam \mathfrak{X}' such that $\emptyset \in \mathfrak{X}'$. Moreover,

for every partitioning $(\mathfrak{X}_1, \mathfrak{X}_2) \in \text{par}(\mathfrak{X})$, one can observe that $\emptyset \in \mathfrak{X}_1$ or $\emptyset \in \mathfrak{X}_2$. Thus, the thesis clearly holds.

- **[Inductive case $\varphi = \exists^{\pm w} x. \phi$]** Items 2a and 2b directly follow from Items 1b and 1a, respectively, via the meta-variant $-\mathfrak{A}, \mathfrak{F}, \mathfrak{X} \models^{\forall\exists} \exists^{\pm w} x. \phi$ iff $\mathfrak{A}, \mathfrak{F}, \bar{\mathfrak{X}} \models^{\exists\forall} \exists^{\pm w} x. \phi$ – of Item 7b of Definition 2. We can therefore focus on the latter two.
 - **[Item 1a]** By the meta-variant of Item 7a of Definition 2, it holds that $\mathfrak{A}, \mathfrak{F}, \emptyset \not\models^{\exists\forall} \varphi$ iff $\mathfrak{A}, \mathfrak{F}, \text{ext}_{[\pm w]}(\emptyset, x) \not\models^{\forall\exists} \phi$. Now, by the inductive hypothesis on ϕ , it follows that $\mathfrak{A}, \mathfrak{F}, \emptyset \not\models^{\forall\exists} \phi$. Moreover, $\text{ext}_{[\pm w]}(\emptyset, x) = \emptyset$. Thus, the thesis clearly holds.
 - **[Item 1b]** By the meta-variant of Item 7a of Definition 2, it holds that $\mathfrak{A}, \mathfrak{F}, \mathfrak{X} \models^{\exists\forall} \varphi$ iff $\mathfrak{A}, \mathfrak{F}, \text{ext}_{[\pm w]}(\mathfrak{X}, x) \models^{\forall\exists} \phi$, where $\emptyset \in \mathfrak{X}$. Now, by the inductive hypothesis on ϕ , it follows that $\mathfrak{A}, \mathfrak{F}, \mathfrak{X}' \models^{\forall\exists} \phi$, for each hyperteam \mathfrak{X}' with $\emptyset \in \mathfrak{X}'$. Moreover, $\emptyset \in \text{ext}_{[\pm w]}(\mathfrak{X}, x)$. Thus, the thesis clearly holds.
- **[Inductive case $\varphi = \forall^{\pm w} x. \phi$]** Items 1a and 1b directly follow from Items 2b and 2a, respectively, via the meta-variant $-\mathfrak{A}, \mathfrak{F}, \mathfrak{X} \models^{\exists\forall} \forall^{\pm w} x. \phi$ iff $\mathfrak{A}, \mathfrak{F}, \bar{\mathfrak{X}} \models^{\forall\exists} \forall^{\pm w} x. \phi$ – of Item 8a of Definition 2. We can therefore focus on the latter two.
 - **[Item 2a]** By the meta-variant of Item 8b of Definition 2, it holds that $\mathfrak{A}, \mathfrak{F}, \emptyset \models^{\forall\exists} \varphi$ iff $\mathfrak{A}, \mathfrak{F}, \text{ext}_{[\pm w]}(\emptyset, x) \models^{\exists\forall} \phi$. Now, by the inductive hypothesis on ϕ , it follows that $\mathfrak{A}, \mathfrak{F}, \emptyset \models^{\exists\forall} \phi$. Moreover, $\text{ext}_{[\pm w]}(\emptyset, x) = \emptyset$. Thus, the thesis clearly holds.
 - **[Item 2b]** By the meta-variant of Item 8b of Definition 2, it holds that $\mathfrak{A}, \mathfrak{F}, \mathfrak{X} \not\models^{\forall\exists} \varphi$ iff $\mathfrak{A}, \mathfrak{F}, \text{ext}_{[\pm w]}(\mathfrak{X}, x) \not\models^{\exists\forall} \phi$, where $\emptyset \in \mathfrak{X}$. Now, by the inductive hypothesis on ϕ , it follows that $\mathfrak{A}, \mathfrak{F}, \mathfrak{X}' \not\models^{\exists\forall} \phi$, for each hyperteam \mathfrak{X}' with $\emptyset \in \mathfrak{X}'$. Moreover, $\emptyset \in \text{ext}_{[\pm w]}(\mathfrak{X}, x)$. Thus, the thesis clearly holds.
- **[Inductive case $\varphi = \Sigma^{\pm w} x. \phi$]** Since the semantics of the existential meta quantifier does not depend on the alternation flag α , we consider the two satisfaction (*resp.*, non-satisfaction) cases altogether.
 - **[Items 1a and 2b]** By Item 9 of Definition 6, it holds that $\mathfrak{A}, \mathfrak{F}, \mathfrak{X} \not\models^{\alpha} \Sigma^{\pm w} x. \phi$ iff, for all functions $F \in \text{Fnc}_{[\pm w]}$, it holds that $\mathfrak{A}, \mathfrak{F}[x \mapsto F], \mathfrak{X} \not\models^{\alpha} \phi$. Now, by the inductive hypothesis on ϕ , it follows that $\mathfrak{A}, \mathfrak{F}', \mathfrak{X} \not\models^{\alpha} \phi$, for every function assignment \mathfrak{F}' , where either $\alpha = \exists\forall$ and $\mathfrak{X} = \emptyset$ or $\alpha = \forall\exists$ and $\emptyset \in \mathfrak{X}$. Thus, the thesis clearly holds.
 - **[Items 1b and 2a]** By Item 9 of Definition 6, it holds that $\mathfrak{A}, \mathfrak{F}, \mathfrak{X} \models^{\alpha} \Sigma^{\pm w} x. \phi$ iff there exists a function $F \in \text{Fnc}_{[\pm w]}$ such that $\mathfrak{A}, \mathfrak{F}[x \mapsto F], \mathfrak{X} \models^{\alpha} \phi$. Now, by the inductive hypothesis on ϕ , it follows that

$\mathfrak{A}, \mathfrak{F}', \mathfrak{X} \models^\alpha \phi$, for every function assignment \mathfrak{F}' , where either $\alpha = \forall\exists$ and $\mathfrak{X} = \emptyset$ or $\alpha = \exists\forall$ and $\emptyset \in \mathfrak{X}$. Thus, the thesis clearly holds.

- **[Inductive case $\varphi = \Pi^{\pm w} x. \phi$]** Since the semantics of the universal meta quantifier does not depend on the alternation flag α , we consider the two satisfaction (*resp.*, non-satisfaction) cases altogether.
 - **[Items 1a and 2b]** By Item 10 of Definition 6, it holds that $\mathfrak{A}, \mathfrak{F}, \mathfrak{X} \not\models^\alpha \Pi^{\pm w} x. \phi$ iff there exists a function $F \in \text{Fnc}_{[\pm W]}$ such that $\mathfrak{A}, \mathfrak{F}[x \mapsto F], \mathfrak{X} \not\models^\alpha \phi$. Now, by the inductive hypothesis on ϕ , it follows that $\mathfrak{A}, \mathfrak{F}', \mathfrak{X} \not\models^\alpha \phi$, for every function assignment \mathfrak{F}' , where either $\alpha = \exists\forall$ and $\mathfrak{X} = \emptyset$ or $\alpha = \forall\exists$ and $\emptyset \in \mathfrak{X}$. Thus, the thesis clearly holds.
 - **[Items 1b and 2a]** By Item 10 of Definition 6, it holds that $\mathfrak{A}, \mathfrak{F}, \mathfrak{X} \models^\alpha \Pi^{\pm w} x. \phi$ iff, for all functions $F \in \text{Fnc}_{[\pm W]}$, it holds that $\mathfrak{A}, \mathfrak{F}[x \mapsto F], \mathfrak{X} \models^\alpha \phi$. Now, by the inductive hypothesis on ϕ , it follows that $\mathfrak{A}, \mathfrak{F}', \mathfrak{X} \models^\alpha \phi$, for every function assignment \mathfrak{F}' , where either $\alpha = \forall\exists$ and $\mathfrak{X} = \emptyset$ or $\alpha = \exists\forall$ and $\emptyset \in \mathfrak{X}$. Thus, the thesis clearly holds. \square

Lemma 12 (Extension Monotonicity). *For all sets of variables $W \subseteq \text{Vr}$, function assignments $\mathfrak{F} \in \text{FAsg}$, and hypertteams $\mathfrak{X}_1, \mathfrak{X}_2 \in \text{HAsg}$, where $\mathfrak{X}_1 \sqsubseteq_W \mathfrak{X}_2$ and $\mathfrak{F}(x) \in \text{Fnc}_W$, for all $x \in \text{dom}(\mathfrak{F}) \cap W$, it holds that $\text{ext}(\mathfrak{X}_1, \mathfrak{F}) \sqsubseteq_W \text{ext}(\mathfrak{X}_2, \mathfrak{F})$.*

Proof. Let $X_1 \in \text{ext}(\mathfrak{X}_1, \mathfrak{F})|_W$. We show that there is $X_2 \in \text{ext}(\mathfrak{X}_2, \mathfrak{F})|_W$ such that $X_2 \subseteq X_1$. By $X_1 \in \text{ext}(\mathfrak{X}_1, \mathfrak{F})|_W$, it holds that $X_1 = \text{ext}(X'_1, \mathfrak{F})|_W$ for some $X'_1 \in \mathfrak{X}_1$. By $\mathfrak{X}_1 \sqsubseteq_W \mathfrak{X}_2$, there is $X'_2 \in \mathfrak{X}_2$ such that $X'_2|_W \subseteq X'_1|_W$. Thus, $\text{ext}(X'_2, \mathfrak{F})|_W \in \text{ext}(\mathfrak{X}_2, \mathfrak{F})|_W$. From $X'_2|_W \subseteq X'_1|_W$ and the fact that $\mathfrak{F}(x) \in \text{Fnc}_W$ holds for all $x \in \text{dom}(\mathfrak{F}) \cap W$, it follows that $\text{ext}(X'_2, \mathfrak{F})|_W \subseteq \text{ext}(X'_1, \mathfrak{F})|_W = X_1$. Hence the thesis. \square

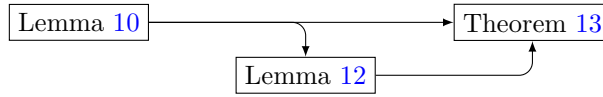

Figure C.8: Dependency graph of Theorem 13.

Theorem 13 (Generalised Hyperteam Refinement). *The following hold true for every META-ADIF formula φ , function assignment $\mathfrak{F} \in \text{FAsg}$, function $\iota : \text{dom}(\iota) \rightarrow 2^{\text{Vr}}$, with $\text{dom}(\mathfrak{F}) \subseteq \text{dom}(\iota)$, and hypertteams $\mathfrak{X}, \mathfrak{X}' \in \text{HAsg}_{\subseteq}(\text{sup}(\varphi) \setminus \text{dom}(\mathfrak{F}))$, with $\mathfrak{F}(x) \in \text{Fnc}_{\iota(x)}$, for all $x \in \text{dom}(\mathfrak{F})$, and $\mathfrak{X} \sqsubseteq_{\text{free}(\varphi, \iota)} \mathfrak{X}'$:*

- 1) if $\mathfrak{A}, \mathfrak{F}, \mathfrak{X} \models^{\exists\forall} \varphi$ then $\mathfrak{A}, \mathfrak{F}, \mathfrak{X}' \models^{\exists\forall} \varphi$;
- 2) if $\mathfrak{A}, \mathfrak{F}, \mathfrak{X}' \models^{\forall\exists} \varphi$ then $\mathfrak{A}, \mathfrak{F}, \mathfrak{X} \models^{\forall\exists} \varphi$.

Proof. Due to $\mathfrak{X} \sqsubseteq_{\text{free}(\varphi, \iota)} \mathfrak{X}'$, there is a function $f : \mathfrak{X}|_{\text{free}(\varphi, \iota)} \rightarrow \mathfrak{X}'|_{\text{free}(\varphi, \iota)}$, such that $f(X) \subseteq X$ for every $X \in \mathfrak{X}|_{\text{free}(\varphi, \iota)}$. The claim is proved by induction on the structure of the formula and the alternation flag α .

- If $\varphi = \perp$, then $\mathfrak{A}, \mathfrak{F}, \mathfrak{X} \models^{\exists\forall} \varphi$ implies $\emptyset \in \mathfrak{X}$, which means that $\emptyset \in \mathfrak{X}|_{\text{free}(\varphi, \iota)}$. By $\mathfrak{X} \sqsubseteq_{\text{free}(\varphi, \iota)} \mathfrak{X}'$, we have $\emptyset \in \mathfrak{X}'|_{\text{free}(\varphi, \iota)}$. Thus, $\emptyset \in \mathfrak{X}'$, which amounts to $\mathfrak{A}, \mathfrak{F}, \mathfrak{X}' \models^{\exists\forall} \varphi$.

On the other hand, we also have that $\mathfrak{A}, \mathfrak{F}, \mathfrak{X}' \models^{\forall\exists} \varphi$ implies $\mathfrak{X}' = \emptyset$, which means that $\mathfrak{X}'|_{\text{free}(\varphi, \iota)} = \emptyset$. By $\mathfrak{X} \sqsubseteq_{\text{free}(\varphi, \iota)} \mathfrak{X}'$, we have $\mathfrak{X}|_{\text{free}(\varphi, \iota)} = \emptyset$. Thus, $\mathfrak{X} = \emptyset$, which amounts to $\mathfrak{A}, \mathfrak{F}, \mathfrak{X} \models^{\forall\exists} \varphi$.

- If $\varphi = \top$, then $\mathfrak{A}, \mathfrak{F}, \mathfrak{X} \models^{\exists\forall} \varphi$ implies $\mathfrak{X} \neq \emptyset$, which means that $\mathfrak{X}|_{\text{free}(\varphi, \iota)} \neq \emptyset$. By $\mathfrak{X} \sqsubseteq_{\text{free}(\varphi, \iota)} \mathfrak{X}'$, we have $\mathfrak{X}'|_{\text{free}(\varphi, \iota)} \neq \emptyset$. Thus, $\mathfrak{X}' \neq \emptyset$, which amounts to $\mathfrak{A}, \mathfrak{F}, \mathfrak{X}' \models^{\exists\forall} \varphi$.

On the other hand, we also have that $\mathfrak{A}, \mathfrak{F}, \mathfrak{X}' \models^{\forall\exists} \varphi$ implies $\emptyset \notin \mathfrak{X}'$, which means that $\emptyset \notin \mathfrak{X}'|_{\text{free}(\varphi, \iota)}$. By $\mathfrak{X} \sqsubseteq_{\text{free}(\varphi, \iota)} \mathfrak{X}'$, we have $\emptyset \notin \mathfrak{X}|_{\text{free}(\varphi, \iota)}$. Thus, $\emptyset \notin \mathfrak{X}$, which amounts to $\mathfrak{A}, \mathfrak{F}, \mathfrak{X} \models^{\forall\exists} \varphi$.

- If $\varphi = R(\vec{x})$, then $\mathfrak{A}, \mathfrak{F}, \mathfrak{X} \models^{\exists\forall} \varphi$ implies the existence of a team $X \in \text{ext}(\mathfrak{X}, \mathfrak{F})$ such that, for all assignments $\chi \in X$, it holds that $\vec{x}^\chi \in R^{\mathfrak{A}}$. By $\mathfrak{X} \sqsubseteq_{\text{free}(\varphi, \iota)} \mathfrak{X}'$ and Lemma 12 (notice that $\iota(x) \subseteq \text{free}(\varphi, \iota)$, for all $x \in \text{dom}(\mathfrak{F}) \cap \text{free}(\varphi, \iota)$), we have that $\text{ext}(\mathfrak{X}, \mathfrak{F}) \sqsubseteq_{\text{free}(\varphi, \iota)} \text{ext}(\mathfrak{X}', \mathfrak{F})$, and thus there is a team $X' \in \text{ext}(\mathfrak{X}', \mathfrak{F})$ such that $X'|_{\text{free}(\varphi, \iota)} \subseteq X|_{\text{free}(\varphi, \iota)}$, which implies $X'|_{\vec{x}} \subseteq X|_{\vec{x}}$, since $\vec{x} \subseteq \text{free}(\varphi, \iota)$. The thesis follows from the fact that $\vec{x}^\chi \in R^{\mathfrak{A}}$ if and only if $\vec{x}^{\chi|_{\vec{x}}} \in R^{\mathfrak{A}}$ holds, for every $\chi \in \text{Asg}$.

On the other hand, we also have that $\mathfrak{A}, \mathfrak{F}, \mathfrak{X}' \models^{\forall\exists} \varphi$ implies that for all teams $X' \in \text{ext}(\mathfrak{X}', \mathfrak{F})$, there exists an assignment $\chi' \in X'$ such that $\vec{x}^{\chi'} \in R^{\mathfrak{A}}$. By $\mathfrak{X} \sqsubseteq_{\text{free}(\varphi, \iota)} \mathfrak{X}'$ and Lemma 12, we have that $\text{ext}(\mathfrak{X}, \mathfrak{F}) \sqsubseteq_{\text{free}(\varphi, \iota)} \text{ext}(\mathfrak{X}', \mathfrak{F})$, and thus for every team $X \in \text{ext}(\mathfrak{X}, \mathfrak{F})$ there is a team $X' \in \text{ext}(\mathfrak{X}', \mathfrak{F})$ such that $X'|_{\text{free}(\varphi, \iota)} \subseteq X|_{\text{free}(\varphi, \iota)}$. The thesis follows from the same argument used above.

- If $\varphi = \neg\phi$, then $\mathfrak{A}, \mathfrak{F}, \mathfrak{X} \models^{\exists\forall} \varphi$ implies $\mathfrak{A}, \mathfrak{F}, \mathfrak{X} \not\models^{\forall\exists} \phi$. By inductive hypothesis, this implies $\mathfrak{A}, \mathfrak{F}, \mathfrak{X}' \not\models^{\forall\exists} \phi$, which amounts to $\mathfrak{A}, \mathfrak{F}, \mathfrak{X}' \models^{\exists\forall} \varphi$.

On the other hand, we also have that $\mathfrak{A}, \mathfrak{F}, \mathfrak{X}' \models^{\forall\exists} \varphi$ implies $\mathfrak{A}, \mathfrak{F}, \mathfrak{X}' \not\models^{\exists\forall} \phi$. By inductive hypothesis, this implies $\mathfrak{A}, \mathfrak{F}, \mathfrak{X} \not\models^{\exists\forall} \phi$, which amounts to $\mathfrak{A}, \mathfrak{F}, \mathfrak{X} \models^{\forall\exists} \varphi$.

- Let $\varphi = \phi_1 \wedge \phi_2$. We assume $\mathfrak{A}, \mathfrak{F}, \mathfrak{X} \models^{\exists\forall} \varphi$ and we show that $\mathfrak{A}, \mathfrak{F}, \mathfrak{X}'_1 \models^{\exists\forall} \phi_1$ or $\mathfrak{A}, \mathfrak{F}, \mathfrak{X}'_2 \models^{\exists\forall} \phi_2$ holds for all $(\mathfrak{X}'_1, \mathfrak{X}'_2) \in \text{par}(\mathfrak{X}')$. To this end, let $(\mathfrak{X}'_1, \mathfrak{X}'_2) \in \text{par}(\mathfrak{X}')$. By Lemma 10, item 3, there is $(\mathfrak{X}_1, \mathfrak{X}_2) \in \text{par}(\mathfrak{X})$ such that $\mathfrak{X}_1 \sqsubseteq_{\text{free}(\varphi, \iota)} \mathfrak{X}'_1$ and $\mathfrak{X}_2 \sqsubseteq_{\text{free}(\varphi, \iota)} \mathfrak{X}'_2$, and, by the semantics of \wedge , we have that $(\mathfrak{X}_1, \mathfrak{X}_2) \in \text{par}(\mathfrak{X})$ implies that $\mathfrak{A}, \mathfrak{F}, \mathfrak{X}_1 \models^{\exists\forall} \phi_1$ or $\mathfrak{A}, \mathfrak{F}, \mathfrak{X}_2 \models^{\exists\forall} \phi_2$.

ϕ_2 . Moreover, since $\text{free}(\phi_1, \iota) \subseteq \text{free}(\varphi, \iota)$ and $\text{free}(\phi_2, \iota) \subseteq \text{free}(\varphi, \iota)$, we have that $\mathfrak{X}_1 \sqsubseteq_{\text{free}(\phi_1, \iota)} \mathfrak{X}'_1$ and $\mathfrak{X}_2 \sqsubseteq_{\text{free}(\phi_2, \iota)} \mathfrak{X}'_2$. Finally, by inductive hypothesis it holds that $\mathfrak{A}, \mathfrak{F}, \mathfrak{X}'_1 \models^{\exists^\forall} \phi_1$ or $\mathfrak{A}, \mathfrak{F}, \mathfrak{X}'_2 \models^{\exists^\forall} \phi_2$.

On the other hand, we also have that $\mathfrak{A}, \mathfrak{F}, \mathfrak{X}' \models^{\forall\exists} \varphi$ if and only if $\mathfrak{A}, \mathfrak{F}, \overline{\mathfrak{X}'} \models^{\exists^\forall} \varphi$. By inductive hypothesis and Lemma 10, Item 1, this implies $\mathfrak{A}, \mathfrak{F}, \overline{\mathfrak{X}} \models^{\exists^\forall} \varphi$, which amounts to $\mathfrak{A}, \mathfrak{F}, \mathfrak{X} \models^{\forall\exists} \varphi$.

- Let $\varphi = \phi_1 \vee \phi_2$. In this case, we first prove the second item of the claim. We assume $\mathfrak{A}, \mathfrak{F}, \mathfrak{X}' \models^{\forall\exists} \varphi$ and we show that there is $(\mathfrak{X}_1, \mathfrak{X}_2) \in \text{par}(\mathfrak{X})$ such that $\mathfrak{A}, \mathfrak{F}, \mathfrak{X}_1 \models^{\forall\exists} \phi_1$ and $\mathfrak{A}, \mathfrak{F}, \mathfrak{X}_2 \models^{\forall\exists} \phi_2$. By the semantics of \vee , we have that there is $(\mathfrak{X}'_1, \mathfrak{X}'_2) \in \text{par}(\mathfrak{X}')$ such that $\mathfrak{A}, \mathfrak{F}, \mathfrak{X}'_1 \models^{\forall\exists} \phi_1$ and $\mathfrak{A}, \mathfrak{F}, \mathfrak{X}'_2 \models^{\forall\exists} \phi_2$. By Lemma 10, item 3, there is $(\mathfrak{X}_1, \mathfrak{X}_2) \in \text{par}(\mathfrak{X})$ such that $\mathfrak{X}_1 \sqsubseteq_{\text{free}(\varphi, \iota)} \mathfrak{X}'_1$ and $\mathfrak{X}_2 \sqsubseteq_{\text{free}(\varphi, \iota)} \mathfrak{X}'_2$. Moreover, since $\text{free}(\phi_1, \iota) \subseteq \text{free}(\varphi, \iota)$ and $\text{free}(\phi_2, \iota) \subseteq \text{free}(\varphi, \iota)$, we have that $\mathfrak{X}_1 \sqsubseteq_{\text{free}(\phi_1, \iota)} \mathfrak{X}'_1$ and $\mathfrak{X}_2 \sqsubseteq_{\text{free}(\phi_2, \iota)} \mathfrak{X}'_2$. Finally, by inductive hypothesis it holds that $\mathfrak{A}, \mathfrak{F}, \mathfrak{X}_1 \models^{\forall\exists} \phi_1$ and $\mathfrak{A}, \mathfrak{F}, \mathfrak{X}_2 \models^{\forall\exists} \phi_2$.

On the other hand, we also have that $\mathfrak{A}, \mathfrak{F}, \mathfrak{X} \models^{\exists^\forall} \varphi$ if and only if $\mathfrak{A}, \mathfrak{F}, \overline{\mathfrak{X}} \models^{\forall\exists} \varphi$. By inductive hypothesis and Lemma 10, Item 1, this implies $\mathfrak{A}, \mathfrak{F}, \overline{\mathfrak{X}'} \models^{\forall\exists} \varphi$, which amounts to $\mathfrak{A}, \mathfrak{F}, \mathfrak{X}' \models^{\exists^\forall} \varphi$.

- If $\varphi = \exists^{\pm w} x. \phi$, then $\mathfrak{A}, \mathfrak{F}, \mathfrak{X} \models^{\exists^\forall} \varphi$ implies $\mathfrak{A}, \mathfrak{F}, \text{ext}_{[\pm W]}(\mathfrak{X}, x) \models^{\exists^\forall} \phi$. If $x \in \text{free}(\phi, \iota[x \mapsto \emptyset])$, then $[\pm W] \subseteq \text{free}(\varphi, \iota)$, and thus, by Lemma 10, item 2b, we have $\text{ext}_{[\pm W]}(\mathfrak{X}, x) \sqsubseteq_{\text{free}(\varphi, \iota) \cup \{x\}} \text{ext}_{[\pm W]}(\mathfrak{X}', x)$. Since $\text{free}(\phi, \iota[x \mapsto \emptyset]) \subseteq \text{free}(\varphi, \iota) \cup \{x\}$, we have $\text{ext}_{[\pm W]}(\mathfrak{X}, x) \sqsubseteq_{\text{free}(\phi, \iota[x \mapsto \emptyset])} \text{ext}_{[\pm W]}(\mathfrak{X}', x)$. From the inductive hypothesis, it follows $\mathfrak{A}, \mathfrak{F}, \text{ext}_{[\pm W]}(\mathfrak{X}', x) \models^{\exists^\forall} \phi$, which amounts to $\mathfrak{A}, \mathfrak{F}, \mathfrak{X}' \models^{\exists^\forall} \varphi$. If, instead, $x \notin \text{free}(\phi, \iota[x \mapsto \emptyset])$, then $\text{free}(\varphi, \iota) = \text{free}(\phi, \iota[x \mapsto \emptyset])$, which means that $x \notin \text{free}(\varphi, \iota)$. By Lemma 10, Item 2a, we have that $\mathfrak{X} \sqsubseteq_{\text{free}(\varphi, \iota)} \text{ext}_{[\pm W]}(\mathfrak{X}, x)$ and $\mathfrak{X}' \sqsubseteq_{\text{free}(\varphi, \iota)} \text{ext}_{[\pm W]}(\mathfrak{X}', x)$, which means that $\text{ext}_{[\pm W]}(\mathfrak{X}, x) \sqsubseteq_{\text{free}(\phi, \iota[x \mapsto \emptyset])} \text{ext}_{[\pm W]}(\mathfrak{X}', x)$, as $\text{free}(\varphi, \iota) = \text{free}(\phi, \iota[x \mapsto \emptyset])$. By inductive hypothesis, it holds that $\mathfrak{A}, \mathfrak{F}, \text{ext}_{[\pm W]}(\mathfrak{X}', x) \models^{\exists^\forall} \phi$, which amounts to $\mathfrak{A}, \mathfrak{F}, \mathfrak{X}' \models^{\exists^\forall} \varphi$.

On the other hand, we also have, by semantics, $\mathfrak{A}, \mathfrak{F}, \mathfrak{X}' \models^{\forall\exists} \varphi$ if and only if $\mathfrak{A}, \mathfrak{F}, \overline{\mathfrak{X}'} \models^{\exists^\forall} \varphi$. By inductive hypothesis and Lemma 10, Item 1, this implies $\mathfrak{A}, \mathfrak{F}, \overline{\mathfrak{X}} \models^{\exists^\forall} \varphi$, which amounts to $\mathfrak{A}, \mathfrak{F}, \mathfrak{X} \models^{\forall\exists} \varphi$.

- If $\varphi = \forall^{\pm w} x. \phi$, then $\mathfrak{A}, \mathfrak{F}, \mathfrak{X}' \models^{\forall\exists} \varphi$ implies $\mathfrak{A}, \mathfrak{F}, \text{ext}_{[\pm W]}(\mathfrak{X}', x) \models^{\forall\exists} \phi$. If $x \in \text{free}(\phi, \iota[x \mapsto \emptyset])$, then $[\pm W] \subseteq \text{free}(\varphi, \iota)$, and thus, by Lemma 10, item 2b, we have $\text{ext}_{[\pm W]}(\mathfrak{X}, x) \sqsubseteq_{\text{free}(\varphi, \iota) \cup \{x\}} \text{ext}_{[\pm W]}(\mathfrak{X}', x)$. Since $\text{free}(\phi, \iota[x \mapsto \emptyset]) \subseteq \text{free}(\varphi, \iota) \cup \{x\}$, we have $\text{ext}_{[\pm W]}(\mathfrak{X}, x) \sqsubseteq_{\text{free}(\phi, \iota[x \mapsto \emptyset])} \text{ext}_{[\pm W]}(\mathfrak{X}', x)$. From the inductive hypothesis, it follows $\mathfrak{A}, \mathfrak{F}, \text{ext}_{[\pm W]}(\mathfrak{X}', x) \models^{\forall\exists} \phi$, which amounts to $\mathfrak{A}, \mathfrak{F}, \mathfrak{X} \models^{\forall\exists} \varphi$. If, instead, $x \notin \text{free}(\phi, \iota[x \mapsto \emptyset])$, then $\text{free}(\varphi, \iota) = \text{free}(\phi, \iota[x \mapsto \emptyset])$, which means that $x \notin \text{free}(\varphi, \iota)$. By Lemma 10, Item 2a,

we have that $\mathfrak{X} =_{\text{free}(\varphi, \iota)} \text{ext}_{\llbracket \pm W \rrbracket}(\mathfrak{X}, x)$ and $\mathfrak{X}' =_{\text{free}(\varphi, \iota)} \text{ext}_{\llbracket \pm W \rrbracket}(\mathfrak{X}', x)$, which means that $\text{ext}_{\llbracket \pm W \rrbracket}(\mathfrak{X}, x) \sqsubseteq_{\text{free}(\phi, \iota[x \mapsto \emptyset])} \text{ext}_{\llbracket \pm W \rrbracket}(\mathfrak{X}', x)$, as $\text{free}(\varphi, \iota) = \text{free}(\phi, \iota[x \mapsto \emptyset])$. By inductive hypothesis, it holds that $\mathfrak{A}, \mathfrak{F}, \text{ext}_{\llbracket \pm W \rrbracket}(\mathfrak{X}, x) \models^{\forall\exists} \phi$, which amounts to $\mathfrak{A}, \mathfrak{F}, \mathfrak{X} \models^{\forall\exists} \phi$.

On the other hand, we also have, by semantics, $\mathfrak{A}, \mathfrak{F}, \mathfrak{X} \models^{\exists\forall} \phi$ if and only if $\mathfrak{A}, \mathfrak{F}, \overline{\mathfrak{X}} \models^{\forall\exists} \phi$. By inductive hypothesis and Lemma 10, Item 1, this implies $\mathfrak{A}, \mathfrak{F}, \overline{\mathfrak{X}'} \models^{\forall\exists} \phi$, which amounts to $\mathfrak{A}, \mathfrak{F}, \mathfrak{X}' \models^{\exists\forall} \phi$.

- If $\varphi = \Sigma^{\pm w} x. \phi$, then $\mathfrak{A}, \mathfrak{F}, \mathfrak{X} \models^{\exists\forall} \varphi$ implies $\mathfrak{A}, \mathfrak{F}[x \mapsto F], \mathfrak{X} \models^{\exists\forall} \phi$, for some function $F \in \text{Fnc}_{\llbracket \pm W \rrbracket}$. By inductive hypothesis, we have $\mathfrak{A}, \mathfrak{F}[x \mapsto F], \mathfrak{X}' \models^{\exists\forall} \phi$, from which $\mathfrak{A}, \mathfrak{F}, \mathfrak{X}' \models^{\exists\forall} \varphi$ follows.

On the other hand, we also have that $\mathfrak{A}, \mathfrak{F}, \mathfrak{X}' \models^{\forall\exists} \varphi$ implies $\mathfrak{A}, \mathfrak{F}[x \mapsto F], \mathfrak{X}' \models^{\forall\exists} \phi$, for some function $F \in \text{Fnc}_{\llbracket \pm W \rrbracket}$. By inductive hypothesis, we have $\mathfrak{A}, \mathfrak{F}[x \mapsto F], \mathfrak{X} \models^{\forall\exists} \phi$, from which $\mathfrak{A}, \mathfrak{F}, \mathfrak{X} \models^{\forall\exists} \varphi$ follows.

- Finally, let $\varphi = \Pi^{\pm w} x. \phi$. Then, $\mathfrak{A}, \mathfrak{F}, \mathfrak{X} \models^{\exists\forall} \varphi$ implies $\mathfrak{A}, \mathfrak{F}[x \mapsto F], \mathfrak{X} \models^{\exists\forall} \phi$, for all functions $F \in \text{Fnc}_{\llbracket \pm W \rrbracket}$. By inductive hypothesis, we have that $\mathfrak{A}, \mathfrak{F}[x \mapsto F], \mathfrak{X}' \models^{\exists\forall} \phi$ holds for all functions $F \in \text{Fnc}_{\llbracket \pm W \rrbracket}$, which amounts to $\mathfrak{A}, \mathfrak{F}, \mathfrak{X}' \models^{\exists\forall} \varphi$.

On the other hand, we also have that $\mathfrak{A}, \mathfrak{F}, \mathfrak{X}' \models^{\forall\exists} \varphi$ implies $\mathfrak{A}, \mathfrak{F}[x \mapsto F], \mathfrak{X}' \models^{\forall\exists} \phi$, for all functions $F \in \text{Fnc}_{\llbracket \pm W \rrbracket}$. By inductive hypothesis, we have that $\mathfrak{A}, \mathfrak{F}[x \mapsto F], \mathfrak{X} \models^{\forall\exists} \phi$ holds for all functions $F \in \text{Fnc}_{\llbracket \pm W \rrbracket}$, which amounts to $\mathfrak{A}, \mathfrak{F}, \mathfrak{X} \models^{\forall\exists} \varphi$. \square

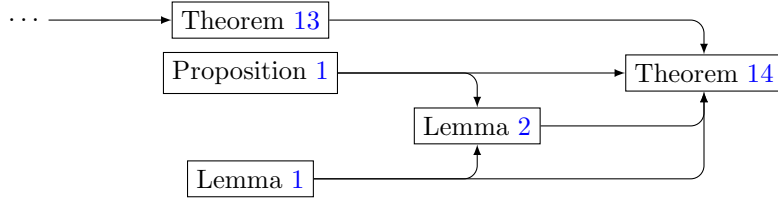

Figure C.9: Dependency graph of Theorem 14.

Theorem 14 (Generalized Double Dualisation). *For every ADIF formula φ , function assignment $\mathfrak{F} \in \text{FAsg}$, and hyperteam $\mathfrak{X} \in \text{HAsg}_{\subseteq}(\text{sup}(\varphi) \setminus \text{dom}(\mathfrak{F}))$, it holds that $\mathfrak{A}, \mathfrak{F}, \mathfrak{X} \models^{\alpha} \varphi$ iff $\mathfrak{A}, \mathfrak{F}, \overline{\mathfrak{X}} \models^{\alpha} \varphi$. Moreover, if \mathfrak{F} is acyclic, then it also holds that $\mathfrak{A}, \mathfrak{F}, \mathfrak{X} \models^{\alpha} \varphi$ iff $\mathfrak{A}, \mathfrak{F}, \overline{\mathfrak{X}} \models^{\overline{\alpha}} \varphi$.*

Proof. The fact that $\mathfrak{A}, \mathfrak{F}, \mathfrak{X} \models^{\alpha} \varphi$ iff $\mathfrak{A}, \mathfrak{F}, \overline{\mathfrak{X}} \models^{\alpha} \varphi$ immediately follows from $\mathfrak{X} \equiv_{\text{free}(\varphi, \iota)} \overline{\mathfrak{X}}$, for every function $\iota \in \text{Vr} \rightarrow 2^{\text{Vr}}$ (Lemma 1), and Theorem 13.

We turn now to proving that $\mathfrak{A}, \mathfrak{F}, \mathfrak{X} \models^\alpha \varphi$ iff $\mathfrak{A}, \mathfrak{F}, \overline{\mathfrak{X}} \models^{\overline{\alpha}} \varphi$. As a preliminary result, notice that if \mathfrak{F} is acyclic, then for every $X \in \text{Asg}(U)$, for some $U \subseteq \text{Vr}$, there is a bijection τ from X and $\overline{\text{ext}(X, \mathfrak{F})}$, with $\tau(\chi)|_U = \chi$. Consequently, it holds that $\overline{\text{ext}(\overline{\mathfrak{X}}, \mathfrak{F})} = \overline{\text{ext}(\mathfrak{X}, \mathfrak{F})}$. The proof is done by case analysis of the syntax of the formula.

- If $\varphi = \perp$, then we have:

$$\begin{aligned} & - \mathfrak{A}, \mathfrak{F}, \mathfrak{X} \models^{\exists\forall} \varphi \stackrel{\text{sem.}}{\Leftrightarrow} \emptyset \in \mathfrak{X} \stackrel{\text{Prop. 1}}{\Leftrightarrow} \overline{\mathfrak{X}} = \emptyset \stackrel{\text{sem.}}{\Leftrightarrow} \mathfrak{A}, \mathfrak{F}, \overline{\mathfrak{X}} \models^{\forall\exists} \varphi, \text{ and} \\ & - \mathfrak{A}, \mathfrak{F}, \mathfrak{X} \models^{\forall\exists} \varphi \stackrel{\text{sem.}}{\Leftrightarrow} \mathfrak{X} = \emptyset \stackrel{\text{Prop. 1}}{\Leftrightarrow} \mathfrak{X} = \emptyset \stackrel{\text{Lemma 1}}{\Leftrightarrow} \overline{\mathfrak{X}} = \emptyset \stackrel{\text{Prop. 1}}{\Leftrightarrow} \overline{\mathfrak{X}} = \emptyset \stackrel{\text{Prop. 1}}{\Leftrightarrow} \\ & \quad \emptyset \in \overline{\mathfrak{X}} \stackrel{\text{sem.}}{\Leftrightarrow} \mathfrak{A}, \mathfrak{F}, \overline{\mathfrak{X}} \models^{\exists\forall} \varphi. \end{aligned}$$

- If $\varphi = \top$, then we have:

$$\begin{aligned} & - \mathfrak{A}, \mathfrak{F}, \mathfrak{X} \models^{\exists\forall} \varphi \stackrel{\text{sem.}}{\Leftrightarrow} \mathfrak{X} \neq \emptyset \stackrel{\text{Prop. 1}}{\Leftrightarrow} \mathfrak{X} \neq \emptyset \stackrel{\text{Lemma 1}}{\Leftrightarrow} \overline{\mathfrak{X}} \neq \emptyset \stackrel{\text{Prop. 1}}{\Leftrightarrow} \overline{\mathfrak{X}} \neq \emptyset \stackrel{\text{Prop. 1}}{\Leftrightarrow} \\ & \quad \emptyset \notin \overline{\mathfrak{X}} \stackrel{\text{sem.}}{\Leftrightarrow} \mathfrak{A}, \mathfrak{F}, \overline{\mathfrak{X}} \models^{\forall\exists} \varphi, \text{ and} \\ & - \mathfrak{A}, \mathfrak{F}, \mathfrak{X} \models^{\forall\exists} \varphi \stackrel{\text{sem.}}{\Leftrightarrow} \emptyset \notin \mathfrak{X} \stackrel{\text{Prop. 1}}{\Leftrightarrow} \overline{\mathfrak{X}} \neq \emptyset \stackrel{\text{sem.}}{\Leftrightarrow} \mathfrak{A}, \mathfrak{F}, \overline{\mathfrak{X}} \models^{\exists\forall} \varphi. \end{aligned}$$

- If $\varphi = R(\vec{x})$, then the claim follows from the semantics, Lemma 2, Item 1, and the fact that $\overline{\text{ext}(\overline{\mathfrak{X}}, \mathfrak{F})} = \overline{\text{ext}(\mathfrak{X}, \mathfrak{F})}$.

- If $\varphi = \neg\psi$, then we have: $\mathfrak{A}, \mathfrak{F}, \mathfrak{X} \models^\alpha \varphi \stackrel{\text{sem.}}{\Leftrightarrow} \mathfrak{A}, \mathfrak{F}, \mathfrak{X} \not\models^{\overline{\alpha}} \psi \stackrel{\text{ind.hp.}}{\Leftrightarrow} \mathfrak{A}, \mathfrak{F}, \overline{\mathfrak{X}} \not\models^{\overline{\alpha}} \psi \stackrel{\text{sem.}}{\Leftrightarrow} \mathfrak{A}, \mathfrak{F}, \overline{\mathfrak{X}} \models^{\overline{\alpha}} \varphi$.

- If $\varphi = \varphi_1 \wedge \varphi_2$, then we have:

$$\begin{aligned} & - \mathfrak{A}, \mathfrak{F}, \overline{\mathfrak{X}} \models^{\forall\exists} \varphi \stackrel{\text{sem.}}{\Leftrightarrow} \mathfrak{A}, \mathfrak{F}, \overline{\mathfrak{X}} \models^{\exists\forall} \varphi \stackrel{\text{Thm. 14 (part 1)}}{\Leftrightarrow} \mathfrak{A}, \mathfrak{F}, \mathfrak{X} \models^{\exists\forall} \varphi, \text{ and} \\ & - \mathfrak{A}, \mathfrak{F}, \mathfrak{X} \models^{\forall\exists} \varphi \stackrel{\text{sem.}}{\Leftrightarrow} \mathfrak{A}, \mathfrak{F}, \overline{\mathfrak{X}} \models^{\exists\forall} \varphi. \end{aligned}$$

- If $\varphi = \varphi_1 \vee \varphi_2$, then we have:

$$\begin{aligned} & - \mathfrak{A}, \mathfrak{F}, \mathfrak{X} \models^{\exists\forall} \varphi \stackrel{\text{sem.}}{\Leftrightarrow} \mathfrak{A}, \mathfrak{F}, \overline{\mathfrak{X}} \models^{\forall\exists} \varphi, \text{ and} \\ & - \mathfrak{A}, \mathfrak{F}, \overline{\mathfrak{X}} \models^{\exists\forall} \varphi \stackrel{\text{sem.}}{\Leftrightarrow} \mathfrak{A}, \mathfrak{F}, \overline{\mathfrak{X}} \models^{\forall\exists} \varphi \stackrel{\text{Thm. 14 (part 1)}}{\Leftrightarrow} \mathfrak{A}, \mathfrak{F}, \mathfrak{X} \models^{\forall\exists} \varphi. \end{aligned}$$

- If $\varphi = \exists^{\pm w} x. \phi$, then we have:

$$\begin{aligned} & - \mathfrak{A}, \mathfrak{F}, \overline{\mathfrak{X}} \models^{\forall\exists} \varphi \stackrel{\text{sem.}}{\Leftrightarrow} \mathfrak{A}, \mathfrak{F}, \overline{\mathfrak{X}} \models^{\exists\forall} \varphi \stackrel{\text{Thm. 14 (part 1)}}{\Leftrightarrow} \mathfrak{A}, \mathfrak{F}, \mathfrak{X} \models^{\exists\forall} \varphi, \text{ and} \\ & - \mathfrak{A}, \mathfrak{F}, \mathfrak{X} \models^{\forall\exists} \varphi \stackrel{\text{sem.}}{\Leftrightarrow} \mathfrak{A}, \mathfrak{F}, \overline{\mathfrak{X}} \models^{\exists\forall} \varphi. \end{aligned}$$

- If $\varphi = \forall^{\pm w} x. \phi$, then we have:

$$\begin{aligned} & - \mathfrak{A}, \mathfrak{F}, \mathfrak{X} \models^{\exists\forall} \varphi \stackrel{\text{sem.}}{\Leftrightarrow} \mathfrak{A}, \mathfrak{F}, \overline{\mathfrak{X}} \models^{\forall\exists} \varphi; \\ & - \mathfrak{A}, \mathfrak{F}, \overline{\mathfrak{X}} \models^{\exists\forall} \varphi \stackrel{\text{sem.}}{\Leftrightarrow} \mathfrak{A}, \mathfrak{F}, \overline{\mathfrak{X}} \models^{\forall\exists} \varphi \stackrel{\text{Thm. 14 (part 1)}}{\Leftrightarrow} \mathfrak{A}, \mathfrak{F}, \mathfrak{X} \models^{\forall\exists} \varphi. \quad \square \end{aligned}$$

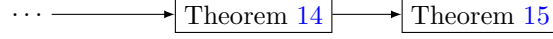

Figure C.10: Dependency graph of Theorem 15.

Theorem 15 (Generalized Prefix Extension). *Let $\wp\phi$ be a ADIF formula, where $\wp \in \text{Qn}$ is a quantifier prefix and ϕ is an arbitrary ADIF formula. Then, $\mathfrak{A}, \mathfrak{F}, \mathfrak{X} \models^\alpha \wp\phi$ iff $\mathfrak{A}, \mathfrak{F}, \text{ext}_\alpha(\mathfrak{X}, \wp) \models^\alpha \phi$, for all acyclic function assignments $\mathfrak{F} \in \text{FAsg}$ and hypertteams $\mathfrak{X} \in \text{HAsg}_{\subseteq}(\text{sup}(\wp\phi) \setminus \text{dom}(\mathfrak{F}))$.*

Proof. We proceed by induction on the structure of the quantification prefix $\wp \in \text{Qn}$.

- **[Base case $\wp = \varepsilon$]** Since $\text{ext}_\alpha(\mathfrak{X}, \wp) = \mathfrak{X}$, there is really nothing to prove as the statement is trivially true.
- **[Inductive case $\wp = \text{Q}^{\pm w}x. \wp'$]** We proceed by a case analysis on the coherence of the quantifier Q with the alternation flag α .
 - **[Q is α -coherent]** By the meta-variants of Items 7a and 8b of Definition 2, it holds that $\mathfrak{A}, \mathfrak{F}, \mathfrak{X} \models^\alpha \wp\phi$ iff $\mathfrak{A}, \mathfrak{F}, \text{ext}_{[\pm W]}(\mathfrak{X}, x) \models^{\alpha'} \wp'\phi$ iff $\mathfrak{A}, \mathfrak{F}, \text{ext}_\alpha(\mathfrak{X}, \text{Q}^{\pm w}x) \models^\alpha \wp'\phi$. Now, by the inductive hypothesis, it follows that $\mathfrak{A}, \mathfrak{F}, \text{ext}_\alpha(\mathfrak{X}, \text{Q}^{\pm w}x) \models^\alpha \wp'\phi$ iff $\mathfrak{A}, \mathfrak{F}, \text{ext}_\alpha(\text{ext}_\alpha(\mathfrak{X}, \text{Q}^{\pm w}x), \wp') \models^\alpha \phi$ iff $\mathfrak{A}, \mathfrak{F}, \text{ext}_\alpha(\mathfrak{X}, \wp) \models^\alpha \phi$, which concludes the proof of this case.
 - **[Q is $\bar{\alpha}$ -coherent]** By the meta-variants of Items 7b and 8a of Definition 2, it holds that $\mathfrak{A}, \mathfrak{F}, \mathfrak{X} \models^\alpha \wp\phi$ iff $\mathfrak{A}, \mathfrak{F}, \bar{\mathfrak{X}} \models^{\bar{\alpha}} \wp\phi$. Now, by the meta-variants of Items 7a and 8b of the same definition, $\mathfrak{A}, \mathfrak{F}, \bar{\mathfrak{X}} \models^{\bar{\alpha}} \wp\phi$ iff $\mathfrak{A}, \mathfrak{F}, \text{ext}_{[\pm W]}(\bar{\mathfrak{X}}, x) \models^{\bar{\alpha}'} \wp'\phi$. Thanks to Theorem 14, $\mathfrak{A}, \mathfrak{F}, \text{ext}_{[\pm W]}(\bar{\mathfrak{X}}, x) \models^{\bar{\alpha}'} \wp'\phi$ iff $\mathfrak{A}, \mathfrak{F}, \text{ext}_{[\pm W]}(\bar{\mathfrak{X}}, x) \models^\alpha \wp'\phi$ iff $\mathfrak{A}, \mathfrak{F}, \text{ext}_\alpha(\mathfrak{X}, \text{Q}^{\pm w}x) \models^\alpha \wp'\phi$. Summing up, $\mathfrak{A}, \mathfrak{F}, \mathfrak{X} \models^\alpha \wp\phi$ iff $\mathfrak{A}, \mathfrak{F}, \text{ext}_\alpha(\mathfrak{X}, \text{Q}^{\pm w}x) \models^\alpha \wp'\phi$. At this point, by the inductive hypothesis, it follows that $\mathfrak{A}, \mathfrak{F}, \text{ext}_\alpha(\mathfrak{X}, \text{Q}^{\pm w}x) \models^\alpha \wp'\phi$ iff $\mathfrak{A}, \mathfrak{F}, \text{ext}_\alpha(\text{ext}_\alpha(\mathfrak{X}, \text{Q}^{\pm w}x), \wp') \models^\alpha \phi$ iff $\mathfrak{A}, \mathfrak{F}, \text{ext}_\alpha(\mathfrak{X}, \wp) \models^\alpha \phi$, which concludes the proof of this case as well. \square

Lemma 9 (Extension Interpretation). *The following four equivalences hold true, for all hypertteams $\mathfrak{X} \in \text{HAsg}(V)$ over $V \subseteq \text{Vr}$, properties $\Psi \subseteq \text{Asg}(V \cup \{x\})$ over $V \cup \{x\}$ with $x \in \text{Vr} \setminus V$, sets of variables $W \subseteq \text{Vr}$, and quantifier symbols $\text{Q} \in \{\exists, \forall\}$.*

- 1) Statements 1a and 1b are equivalent, whenever Q is α -coherent:
 - a) there exists $X' \in \text{ext}_\alpha(\mathfrak{X}, \text{Q}^{\pm w}x)$ such that $X' \subseteq \Psi$;
 - b) there exist $F \in \text{Fnc}_{[\pm W]}$ and $X \in \mathfrak{X}$ such that $\text{ext}(X, F, x) \subseteq \Psi$.
- 2) Statements 2a and 2b are equivalent, whenever Q is α -coherent:
 - a) for all $X' \in \text{ext}_\alpha(\mathfrak{X}, \text{Q}^{\pm w}x)$, it holds that $X' \cap \Psi \neq \emptyset$;

- b) for all $F \in \text{Fnc}_{[\pm W]}$ and $X \in \mathfrak{X}$, it holds that $\text{ext}(X, F, x) \cap \Psi \neq \emptyset$.
- 3) Statements 3a and 3b are equivalent, whenever Q is $\bar{\alpha}$ -coherent:
- a) there exists $X' \in \text{ext}_\alpha(\mathfrak{X}, Q^{\pm w}x)$ such that $X' \subseteq \Psi$;
- b) for all $F \in \text{Fnc}_{[\pm W]}$, it holds that $\text{ext}(X, F, x) \subseteq \Psi$, for some $X \in \mathfrak{X}$.
- 4) Statements 4a and 4b are equivalent, whenever Q is $\bar{\alpha}$ -coherent:
- a) for all $X' \in \text{ext}_\alpha(\mathfrak{X}, Q^{\pm w}x)$, it holds that $X' \cap \Psi \neq \emptyset$;
- b) there is $F \in \text{Fnc}_{[\pm W]}$ such that $\text{ext}(X, F, x) \cap \Psi \neq \emptyset$, for all $X \in \mathfrak{X}$.

Proof. We first prove Items 1 and 2 altogether, where Q is α -coherent, and then we proceed with the remaining ones separately. In particular, for these last two, we make use, given an arbitrary function $F \in \text{Fnc}_{\pm W}$, of the auxiliary notation $\text{prj}(\Psi, F, x) \triangleq \{\chi \in \text{Asg}(V) \mid \text{ext}(\chi, F, x) \in \Psi\}$ satisfying the following two properties, for every team $X \in \text{TAsg}(V)$: (i) $\text{ext}(X, F, x) \subseteq \Psi$ iff $X \subseteq \text{prj}(\Psi, F, x)$; (ii) $\text{ext}(X, F, x) \cap \Psi \neq \emptyset$ iff $X \cap \text{prj}(\Psi, F, x) \neq \emptyset$.

- **[Items 1 and 2]** By definition of the extension function, when Q is α -coherent, we have that

$$\text{ext}_\alpha(\mathfrak{X}, Q^{\pm w}x) = \text{ext}_{[\pm W]}(\mathfrak{X}, x) = \{\text{ext}(X, F, x) \mid X \in \mathfrak{X}, F \in \text{Fnc}_{[\pm W]}\}.$$

Thus, for every possible team $X' \in \text{TAsg}(V \cup \{x\})$, it holds that $X' \in \text{ext}_\alpha(\mathfrak{X}, Q^{\pm w}x)$ iff there exists a function $F \in \text{Fnc}_{[\pm W]}$ and a team $X \in \mathfrak{X}$ such that $X' = \text{ext}(X, F, x)$. Hence, both equivalences immediately follows.

- **[Item 3]** Since Q is $\bar{\alpha}$ -coherent, $\text{ext}_\alpha(\mathfrak{X}, Q^{\pm w}x) = \overline{\text{ext}_{[\pm W]}(\bar{\mathfrak{X}}, x)}$, and thus Condition 3a holds iff there is a team $X' \in \text{ext}_{[\pm W]}(\bar{\mathfrak{X}}, x)$ such that $X' \subseteq \Psi$. By Item 1 of Lemma 2, this holds iff for all teams $X' \in \text{ext}_{[\pm W]}(\bar{\mathfrak{X}}, x) = \text{ext}_\alpha(\bar{\mathfrak{X}}, \bar{Q}^{\pm w}x)$, it holds that $X' \cap \Psi \neq \emptyset$. Thanks to Item 2, the latter is true iff for all functions $F \in \text{Fnc}_{[\pm W]}$ and teams $X \in \bar{\mathfrak{X}}$, it holds that $\text{ext}(X, F, x) \cap \Psi \neq \emptyset$, and thus $X \cap \text{prj}(\Psi, F, x) \neq \emptyset$. At this point, again by Item 1 of Lemma 2, for all $X \in \bar{\mathfrak{X}}$, it holds that $X \cap \text{prj}(\Psi, F, x) \neq \emptyset$ iff there exists a team $X \in \mathfrak{X}$ such that $X \subseteq \text{prj}(\Psi, F, x)$, and thus $\text{ext}(X, F, x) \subseteq \Psi$. Therefore, the following equivalence concludes the proof: for all functions $F \in \text{Fnc}_{[\pm W]}$ and teams $X \in \bar{\mathfrak{X}}$, it holds that $X \cap \text{prj}(\Psi, F, x) \neq \emptyset$ iff for all functions $F \in \text{Fnc}_{[\pm W]}$ there exists a team $X \in \mathfrak{X}$ such that $\text{ext}(X, F, x) \subseteq \Psi$, which coincides with Condition 3b.
- **[Item 4]** Since Q is $\bar{\alpha}$ -coherent, $\text{ext}_\alpha(\mathfrak{X}, Q^{\pm w}x) = \overline{\text{ext}_{[\pm W]}(\bar{\mathfrak{X}}, x)}$, and thus Condition 4a holds iff for all teams $X' \in \text{ext}_{[\pm W]}(\bar{\mathfrak{X}}, x)$, it holds that $X' \cap \Psi \neq \emptyset$. By Item 1 of Lemma 2, this holds iff there exists a team $X \in \text{ext}_{[\pm W]}(\bar{\mathfrak{X}}, x) = \text{ext}_\alpha(\bar{\mathfrak{X}}, \bar{Q}^{\pm w}x)$ such that $X \subseteq \Psi$. Thanks to Item 1, the latter is true iff there exist a function $F \in \text{Fnc}_{[\pm W]}$ and a team $X \in \bar{\mathfrak{X}}$ such that $\text{ext}(X, F, x) \subseteq \Psi$, and thus $X \subseteq \text{prj}(\Psi, F, x)$. At this point, again by Item 1

of Lemma 2, there exists a team $X \in \overline{\mathfrak{X}}$ such that $X \subseteq \text{prj}(\Psi, F, x)$ iff for all teams $X' \in \mathfrak{X}$, it holds that $X' \cap \text{prj}(\Psi, F, x) \neq \emptyset$, and thus $\text{ext}(X', F, x) \cap \Psi \neq \emptyset$. Therefore, the following equivalence concludes the proof: there exist a function $F \in \text{Fnc}_{\llbracket \pm W \rrbracket}$ and a team $X \in \overline{\mathfrak{X}}$ such that $X \subseteq \text{prj}(\Psi, F, x)$ iff there exists a function $F \in \text{Fnc}_{\llbracket \pm W \rrbracket}$ such that for all teams $X' \in \mathfrak{X}$, it holds that $\text{ext}(X', F, x) \cap \Psi \neq \emptyset$, which coincides with Condition 4b. \square

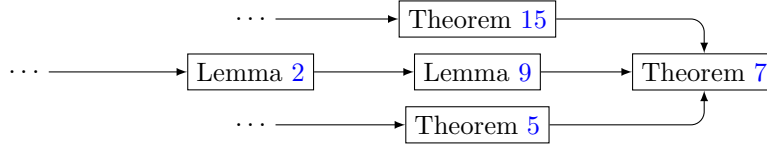

Figure C.11: Dependency graph of Theorem 7.

Theorem 7 (Quantifier Interpretation). *The following equivalences hold true, for all FOL formulae ϕ , variables $x \in \text{Vr}$, sets of variables $W \subseteq \text{Vr}$ with $x \notin \llbracket \pm W \rrbracket$, acyclic function assignments $\mathfrak{F} \in \text{FAsg}$ with $\text{dom}(\mathfrak{F}) \cap \llbracket \pm W \rrbracket = \emptyset$, and hyperteams $\mathfrak{X} \in \text{HAsg}_{\subseteq}((\text{sup}(\phi) \setminus \{x\}) \setminus \text{dom}(\mathfrak{F}))$ with $x \notin \text{vr}(\mathfrak{X})$:*

- 1) $\mathfrak{A}, \mathfrak{F}, \mathfrak{X} \models^{\alpha} \exists^{\pm W} x. \phi$ iff $\mathfrak{A}, \mathfrak{F}, \mathfrak{X} \models^{\alpha} \Sigma^{\pm W} x. \phi$;
- 2) $\mathfrak{A}, \mathfrak{F}, \mathfrak{X} \models^{\alpha} \forall^{\pm W} x. \phi$ iff $\mathfrak{A}, \mathfrak{F}, \mathfrak{X} \models^{\alpha} \Pi^{\pm W} x. \phi$.

Proof. First, observe that, by a generalisation of Theorem 5 to META-ADIF, the following two equivalences hold true, where we define $\llbracket \phi \rrbracket \triangleq \{\chi \in \text{Asg}_{\subseteq}(\text{sup}(\phi)) \mid \mathfrak{A}, \chi \models_{\text{FOL}} \phi\}$ for every FOL formula ϕ and acyclic function assignments $\mathfrak{F} \in \text{FAsg}$:

- a) $\mathfrak{A}, \mathfrak{F}, \mathfrak{X} \models^{\exists^{\forall}} \phi$ iff $X \subseteq \llbracket \phi \rrbracket$, for some team $X \in \text{ext}(\mathfrak{X}, \mathfrak{F})$;
- b) $\mathfrak{A}, \mathfrak{F}, \mathfrak{X} \models^{\forall^{\exists}} \phi$ iff $X \cap \llbracket \phi \rrbracket \neq \emptyset$, for all teams $X \in \text{ext}(\mathfrak{X}, \mathfrak{F})$.

which are equivalent to the following, respectively:

- $\mathfrak{A}, \mathfrak{F}, \mathfrak{X} \models^{\exists^{\forall}} \phi$ iff $\text{ext}(X, \mathfrak{F}) \subseteq \llbracket \phi \rrbracket$, for some team $X \in \mathfrak{X}$;
- $\mathfrak{A}, \mathfrak{F}, \mathfrak{X} \models^{\forall^{\exists}} \phi$ iff $\text{ext}(X, \mathfrak{F}) \cap \llbracket \phi \rrbracket \neq \emptyset$, for all teams $X \in \mathfrak{X}$.

For technical convenience, given $\Psi \subseteq \text{Asg}$ and $U \subseteq \text{Vr}$, let us introduce the notation $\text{prj}(\Psi, U, \mathfrak{F}) \triangleq \{\chi \in \Psi \mid \forall x \in \text{dom}(\mathfrak{F}) \setminus U. \chi(x) = \mathfrak{F}(x)(\chi)\} \upharpoonright_U$ satisfying the following two properties, for every team $X \in \text{TAsg}(U)$: (i) $\text{ext}(X, \mathfrak{F}) \subseteq \Psi$ iff $X \subseteq \text{prj}(\Psi, U, \mathfrak{F})$; (ii) $\text{ext}(X, \mathfrak{F}) \cap \Psi \neq \emptyset$ iff $X \cap \text{prj}(\Psi, U, \mathfrak{F}) \neq \emptyset$. In the light of this notation, we can rewrite the last two equivalences above as follows:

- $\mathfrak{A}, \mathfrak{F}, \mathfrak{X} \models^{\exists^{\forall}} \phi$ iff $X \subseteq \text{prj}(\llbracket \phi \rrbracket, \text{vr}(X), \mathfrak{F})$, for some team $X \in \mathfrak{X}$;
- $\mathfrak{A}, \mathfrak{F}, \mathfrak{X} \models^{\forall^{\exists}} \phi$ iff $X \cap \text{prj}(\llbracket \phi \rrbracket, \text{vr}(X), \mathfrak{F}) \neq \emptyset$, for all teams $X \in \mathfrak{X}$.

By applying to a formula $Q^{\pm w}x. \phi$, where $Q \in \{\exists, \forall\}$, a combination of Theorem 15 with what we have just derived, we obtain the two equivalences below:

- i) $\mathfrak{A}, \mathfrak{F}, \mathfrak{X} \models^{\exists\forall} Q^{\pm w}x. \phi$ iff there exists a team $X \in \text{ext}_{\exists\forall}(\mathfrak{X}, Q^{\pm w}x)$ such that $X \subseteq \text{prj}(\llbracket \phi \rrbracket, \text{vr}(X), \mathfrak{F})$;
- ii) $\mathfrak{A}, \mathfrak{F}, \mathfrak{X} \models^{\forall\exists} Q^{\pm w}x. \phi$ iff, for all teams $X \in \text{ext}_{\forall\exists}(\mathfrak{X}, Q^{\pm w}x)$, it holds that $X \cap \text{prj}(\llbracket \phi \rrbracket, \text{vr}(X), \mathfrak{F}) \neq \emptyset$.

At this point, we proceed by a case analysis on the type of quantifier Q and the alternation flag α , where we exploit the fact that, given $X \in \text{TAsg}$, if $x \notin \text{vr}(X)$, then for every function $F \in \text{Fnc}_{\llbracket \pm W \rrbracket}$, there exists a function $F^* \in \text{Fnc}_{\llbracket \pm W \rrbracket}$ and, *vice versa*, for every function $F^* \in \text{Fnc}_{\llbracket \pm W \rrbracket}$, there exists a function $F \in \text{Fnc}_{\llbracket \pm W \rrbracket}$ such that

$$\text{ext}(\text{ext}(X, F, x), \mathfrak{F}) = \text{ext}(X, \mathfrak{F}[x \mapsto F^*]).$$

Notice that, since \mathfrak{F} is acyclic, $x \notin \llbracket \pm W \rrbracket$, and $\text{dom}(\mathfrak{F}) \cap \llbracket \pm W \rrbracket = \emptyset$, it holds that $\mathfrak{F}[x \mapsto F^*]$ is acyclic as well.

- $[Q = \exists \ \& \ \alpha = \exists\forall]$ By Equivalence i) and Item 1 of Lemma 9, $\mathfrak{A}, \mathfrak{F}, \mathfrak{X} \models^{\exists\forall} \exists^{\pm w}x. \phi$ iff there exist a function $F \in \text{Fnc}_{\llbracket \pm W \rrbracket}$ and a team $X \in \mathfrak{X}$ such that $\text{ext}(X, F, x) \subseteq \text{prj}(\llbracket \phi \rrbracket, \text{vr}(X) \cup \{x\}, \mathfrak{F})$, and thus $\text{ext}(\text{ext}(X, F, x), \mathfrak{F}) \subseteq \llbracket \phi \rrbracket$. This means that $\mathfrak{A}, \mathfrak{F}, \mathfrak{X} \models^{\exists\forall} \exists^{\pm w}x. \phi$ iff there exist a function $F^* \in \text{Fnc}_{\llbracket \pm W \rrbracket}$ and a team $X \in \mathfrak{X}$ such that $\text{ext}(X, \mathfrak{F}[x \mapsto F^*]) \subseteq \llbracket \phi \rrbracket$ iff there exists a function $F^* \in \text{Fnc}_{\llbracket \pm W \rrbracket}$ such that $X \subseteq \llbracket \phi \rrbracket$, for some team $X \in \text{ext}(\mathfrak{X}, \mathfrak{F}[x \mapsto F^*])$. By Equivalence a), the latter statement can be rewritten as: there exists a function $F^* \in \text{Fnc}_{\llbracket \pm W \rrbracket}$ such that $\mathfrak{A}, \mathfrak{F}[x \mapsto F^*], \mathfrak{X} \models^{\exists\forall} \phi$; this in turn is equivalent to $\mathfrak{A}, \mathfrak{F}, \mathfrak{X} \models^{\exists\forall} \Sigma^{\pm w}x. \phi$, due to Item 9 of Definition 6. This concludes the proof of Item 1 for $\alpha = \exists\forall$.
- $[Q = \exists \ \& \ \alpha = \forall\exists]$ By Equivalence ii) and Item 4 of Lemma 9, $\mathfrak{A}, \mathfrak{F}, \mathfrak{X} \models^{\forall\exists} \exists^{\pm w}x. \phi$ iff there exists a function $F \in \text{Fnc}_{\llbracket \pm W \rrbracket}$ such that, for all teams $X \in \mathfrak{X}$, it holds true that $\text{ext}(X, F, x) \cap \text{prj}(\llbracket \phi \rrbracket, \text{vr}(X) \cup \{x\}, \mathfrak{F}) \neq \emptyset$, and thus $\text{ext}(\text{ext}(X, F, x), \mathfrak{F}) \cap \llbracket \phi \rrbracket \neq \emptyset$. This means that $\mathfrak{A}, \mathfrak{F}, \mathfrak{X} \models^{\forall\exists} \exists^{\pm w}x. \phi$ iff there exists a function $F^* \in \text{Fnc}_{\llbracket \pm W \rrbracket}$ such that, for all teams $X \in \mathfrak{X}$, it holds that $\text{ext}(X, \mathfrak{F}[x \mapsto F^*]) \cap \llbracket \phi \rrbracket \neq \emptyset$ iff there exists a function $F^* \in \text{Fnc}_{\llbracket \pm W \rrbracket}$ such that $X \cap \llbracket \phi \rrbracket \neq \emptyset$, for all teams $X \in \text{ext}(\mathfrak{X}, \mathfrak{F}[x \mapsto F^*])$. By Equivalence b), the latter statement can be rewritten as: there exists a function $F^* \in \text{Fnc}_{\llbracket \pm W \rrbracket}$ such that $\mathfrak{A}, \mathfrak{F}[x \mapsto F^*], \mathfrak{X} \models^{\forall\exists} \phi$; this in turn is equivalent to $\mathfrak{A}, \mathfrak{F}, \mathfrak{X} \models^{\forall\exists} \Sigma^{\pm w}x. \phi$, due to Item 9 of Definition 6. This concludes the proof of Item 1 for $\alpha = \forall\exists$.
- $[Q = \forall \ \& \ \alpha = \exists\forall]$ By Equivalence i) and Item 3 of Lemma 9, $\mathfrak{A}, \mathfrak{F}, \mathfrak{X} \models^{\exists\forall} \forall^{\pm w}x. \phi$ iff, for all functions $F \in \text{Fnc}_{\llbracket \pm W \rrbracket}$, there exists a team $X \in \mathfrak{X}$ such that $\text{ext}(X, F, x) \subseteq \text{prj}(\llbracket \phi \rrbracket, \text{vr}(X) \cup \{x\}, \mathfrak{F})$, and thus $\text{ext}(\text{ext}(X, F, x), \mathfrak{F}) \subseteq \llbracket \phi \rrbracket$. This means that $\mathfrak{A}, \mathfrak{F}, \mathfrak{X} \models^{\exists\forall} \forall^{\pm w}x. \phi$ iff, for all functions $F^* \in \text{Fnc}_{\llbracket \pm W \rrbracket}$, there exists a team $X \in \mathfrak{X}$ such that $\text{ext}(X, \mathfrak{F}[x \mapsto F^*]) \subseteq \llbracket \phi \rrbracket$ iff, for all functions $F^* \in \text{Fnc}_{\llbracket \pm W \rrbracket}$, it holds that $X \subseteq \llbracket \phi \rrbracket$, for some team $X \in \text{ext}(\mathfrak{X}, \mathfrak{F}[x \mapsto F^*])$.

By Equivalence a), the latter statement can be rewritten as: for all functions $F^* \in \text{Fnc}_{[\pm W]}$, it holds that $\mathfrak{A}, \mathfrak{F}[x \mapsto F^*], \mathfrak{X} \models^{\exists^V} \phi$; this in turn is equivalent to $\mathfrak{A}, \mathfrak{F}, \mathfrak{X} \models^{\exists^V} \Pi^{\pm W} x. \phi$, due to Item 10 of Definition 6. This concludes the proof of Item 2 for $\alpha = \exists^V$.

- [Q = \forall & $\alpha = \forall^{\exists}$] By Equivalence ii) and Item 2 of Lemma 9, $\mathfrak{A}, \mathfrak{F}, \mathfrak{X} \models^{\forall^{\exists}} \forall^{\pm W} x. \phi$ iff, for all functions $F \in \text{Fnc}_{[\pm W]}$ and teams $X \in \mathfrak{X}$, it holds that $\text{ext}(X, F, x) \cap \text{prj}(\llbracket \phi \rrbracket, \text{vr}(\mathfrak{X}) \cup \{x\}, \mathfrak{F}) \neq \emptyset$, and thus $\text{ext}(\text{ext}(X, F, x), \mathfrak{F}) \cap \llbracket \phi \rrbracket \neq \emptyset$. This means that $\mathfrak{A}, \mathfrak{F}, \mathfrak{X} \models^{\forall^{\exists}} \forall^{\pm W} x. \phi$ iff, for all functions $F^* \in \text{Fnc}_{[\pm W]}$ and teams $X \in \mathfrak{X}$, it holds that $\text{ext}(X, \mathfrak{F}[x \mapsto F^*]) \cap \llbracket \phi \rrbracket \neq \emptyset$ iff, for all functions $F^* \in \text{Fnc}_{[\pm W]}$, it holds that $X \cap \llbracket \phi \rrbracket \neq \emptyset$, for all teams $X \in \text{ext}(\mathfrak{X}, \mathfrak{F}[x \mapsto F^*])$. By Equivalence b), the latter statement can be rewritten as: for all functions $F^* \in \text{Fnc}_{[\pm W]}$, it holds that $\mathfrak{A}, \mathfrak{F}[x \mapsto F^*], \mathfrak{X} \models^{\forall^{\exists}} \phi$; this in turn is equivalent to $\mathfrak{A}, \mathfrak{F}, \mathfrak{X} \models^{\forall^{\exists}} \Pi^{\pm W} x. \phi$, due to Item 10 of Definition 6. This concludes the proof of Item 2 for $\alpha = \forall^{\exists}$. \square

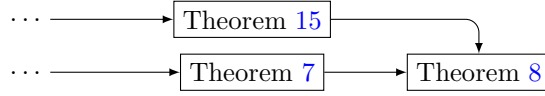

Figure C.12: Dependency graph of Theorem 8.

Theorem 8 (Herbrand-Skolem Theorem). *Let $\wp\phi$ be an ADIF formula in pnf with quantifier prefix $\wp \in \text{Qn}$ and FOL matrix ϕ . Then, $\mathfrak{A}, \mathfrak{F}, \mathfrak{X} \models^\alpha \wp\phi$ iff $\mathfrak{A}, \mathfrak{F}, \mathfrak{X} \models^\alpha \text{hsp}(\wp)\phi$, for all acyclic function assignments $\mathfrak{F} \in \text{FAsg}$ with $\text{dom}(\mathfrak{F}) \cap \text{dep}(\wp) = \emptyset$ and hyperteams $\mathfrak{X} \in \text{HAsg}_{\subseteq}(\text{sup}(\wp\phi) \setminus \text{dom}(\mathfrak{F}))$ with $\text{vr}(\mathfrak{X}) \cap \text{vr}(\wp) = \emptyset$.*

Proof. The proof proceeds by structural induction on the quantifier prefix $\wp \in \text{Qn}$.

- [Base case $\wp = \varepsilon$] Since $\text{hsp}(\wp) = \varepsilon$, there is really nothing to prove as the statement is trivially true.
- [Inductive case $\wp = \wp'. \text{Q}^{\pm W} x$] By Theorem 15, it holds that $\mathfrak{A}, \mathfrak{F}, \mathfrak{X} \models^\alpha \wp\phi$ iff $\mathfrak{A}, \mathfrak{F}, \text{ext}_\alpha(\mathfrak{X}, \wp') \models^\alpha \text{Q}^{\pm W} x. \phi$. A case analysis on the type of quantifier is now required.
- [Q = \exists] By Item 1 of Theorem 7, $\mathfrak{A}, \mathfrak{F}, \text{ext}_\alpha(\mathfrak{X}, \wp') \models^\alpha \exists^{\pm W} x. \phi$ iff $\mathfrak{A}, \mathfrak{F}, \text{ext}_\alpha(\mathfrak{X}, \wp') \models^\alpha \Sigma^{\pm W} x. \phi$, since ϕ is a FOL formula, being $\wp\phi$ in pnf. Thus, by Item 9 of Definition 6, we have that $\mathfrak{A}, \mathfrak{F}, \mathfrak{X} \models^\alpha \wp\phi$ iff there exists a function $F \in \text{Fnc}_{[\pm W]}$ such that $\mathfrak{A}, \mathfrak{F}[x \mapsto F], \text{ext}_\alpha(\mathfrak{X}, \wp') \models^\alpha \phi$. Observe that $\mathfrak{F}[x \mapsto F]$ is still acyclic, due to assumptions made at page 19 on Qn and the fact that $\text{dom}(\mathfrak{F}) \cap \text{dep}(\wp) = \emptyset$. Again by Theorem 15, $\mathfrak{A}, \mathfrak{F}[x \mapsto F], \text{ext}_\alpha(\mathfrak{X}, \wp') \models^\alpha \phi$ is equivalent to $\mathfrak{A}, \mathfrak{F}[x \mapsto F], \mathfrak{X} \models^\alpha \wp'\phi$,

which in turn, by the inductive hypothesis applied to $\wp'\phi$, is equivalent to $\mathfrak{A}, \mathfrak{F}[x \mapsto F], \mathfrak{X} \models^\alpha \text{hsp}(\wp')\phi$. Summing up, we have $\mathfrak{A}, \mathfrak{F}, \mathfrak{X} \models^\alpha \wp\phi$ iff there exists a function $F \in \text{Fnc}_{[\pm W]}$ such that $\mathfrak{A}, \mathfrak{F}[x \mapsto F], \mathfrak{X} \models^\alpha \text{hsp}(\wp')\phi$. At this point, again by Item 9 of Definition 6, we obtain $\mathfrak{A}, \mathfrak{F}, \mathfrak{X} \models^\alpha \wp\phi$ iff $\mathfrak{A}, \mathfrak{F}, \mathfrak{X} \models^\alpha \Sigma^{\pm w} x. \text{hsp}(\wp')\phi$ iff $\mathfrak{A}, \mathfrak{F}, \mathfrak{X} \models^\alpha \text{hsp}(\wp)\phi$, where the latter equivalence is due to the definition of the hsp function satisfying the equality $\text{hsp}(\wp) = \text{hsp}(\wp'. \exists^{\pm w} x) = \Sigma^{\pm w} x. \text{hsp}(\wp')$. This concludes the proof of the existential case.

- $[Q = \forall]$ By Item 2 of Theorem 7, $\mathfrak{A}, \mathfrak{F}, \text{ext}_\alpha(\mathfrak{X}, \wp') \models^\alpha \forall^{\pm w} x. \phi$ iff $\mathfrak{A}, \mathfrak{F}, \text{ext}_\alpha(\mathfrak{X}, \wp') \models^\alpha \Pi^{\pm w} x. \phi$, since ϕ is a FOL formula, being $\wp\phi$ in *pnf*. Thus, by Item 10 of Definition 6, we have that $\mathfrak{A}, \mathfrak{F}, \mathfrak{X} \models^\alpha \wp\phi$ iff, for all functions $F \in \text{Fnc}_{[\pm W]}$, it holds that $\mathfrak{A}, \mathfrak{F}[x \mapsto F], \text{ext}_\alpha(\mathfrak{X}, \wp') \models^\alpha \phi$. Observe again that $\mathfrak{F}[x \mapsto F]$ is acyclic. By Theorem 15, $\mathfrak{A}, \mathfrak{F}[x \mapsto F], \text{ext}_\alpha(\mathfrak{X}, \wp') \models^\alpha \phi$ is equivalent to $\mathfrak{A}, \mathfrak{F}[x \mapsto F], \mathfrak{X} \models^\alpha \wp'\phi$, which in turn, by the inductive hypothesis applied to $\wp'\phi$, is equivalent to $\mathfrak{A}, \mathfrak{F}[x \mapsto F], \mathfrak{X} \models^\alpha \text{hsp}(\wp')\phi$. Summing up, we have $\mathfrak{A}, \mathfrak{F}, \mathfrak{X} \models^\alpha \wp\phi$ iff, for all functions $F \in \text{Fnc}_{[\pm W]}$, it holds that $\mathfrak{A}, \mathfrak{F}[x \mapsto F], \mathfrak{X} \models^\alpha \text{hsp}(\wp')\phi$. At this point, again by Item 10 of Definition 6, we obtain $\mathfrak{A}, \mathfrak{F}, \mathfrak{X} \models^\alpha \wp\phi$ iff $\mathfrak{A}, \mathfrak{F}, \mathfrak{X} \models^\alpha \Pi^{\pm w} x. \text{hsp}(\wp')\phi$ iff $\mathfrak{A}, \mathfrak{F}, \mathfrak{X} \models^\alpha \text{hsp}(\wp)\phi$, where the latter equivalence is due to the definition of the hsp function satisfying the equality $\text{hsp}(\wp) = \text{hsp}(\wp'. \forall^{\pm w} x) = \Pi^{\pm w} x. \text{hsp}(\wp')$. This concludes the proof of the universal case too. \square

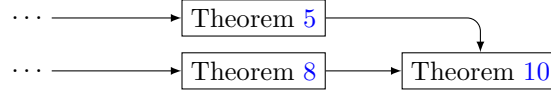

Figure C.13: Dependency graph of Theorem 10.

Theorem 10 (ADF-SOL Interpretation). *For every ADF formula φ in pnf with quantifier prefix $\wp \in \text{Qn}$ over a signature \mathcal{L} , set of variables $\text{free}(\varphi) \subseteq V \subseteq \text{Vr}$ with $V \cap \text{vr}(\wp) = \emptyset$, and relation symbol $R \notin \mathcal{L}$ with $\text{ar}(R) = |V| + 1$, there exist two SOL sentences $\Phi_{\exists\forall}$ and $\Phi_{\forall\exists}$ over signature $\mathcal{L} \uplus \{R\}$ such that, for all \mathcal{L} -structures \mathfrak{A} and non-null hyperteam $\mathfrak{X} \in \text{HAsg}(V)$ with $|\mathfrak{X}| \leq |\mathfrak{A}|$, the following equivalence hold true: $\mathfrak{A}, \mathfrak{X} \models^\alpha \varphi$ iff $\mathfrak{A} \uplus \{\text{Rel}(\mathfrak{X})\} \models_{\text{SOL}} \Phi_\alpha$.*

Proof. For simplicity, we just consider the case of ADF formulae; given the set of variables V , a conversion from AIF formulae to ADF formulae is immediate. As first step, consider a formula $\varphi = \wp\phi$ in prenex form, where \wp is a quantifier prefix and ϕ a quantifier-free matrix. Then, by Theorem 8, we further transform the latter into the equivalent Meta-ADF formula $\text{hsp}(\wp)\phi$. Obviously, $\text{hsp}(\wp) = (\mathbf{Q}_i^{+W_i} x_i)_{i=1}^k$, for some $k \in \mathbb{N}$, where $W_i \subseteq \text{Vr}$ and $\mathbf{Q}_i \in \{\Sigma, \Pi\}$. Now, let $\widehat{\wp} \triangleq (\widehat{\mathbf{Q}}_i f_i)_{i=1}^k$ be the second-order function-quantifier prefix, where (i) the arity of each function symbol f_i equals the number of variables x_i depend on, i.e., $\text{ar}(f_i) = |W_i|$, and (ii) each second-order quantifier symbol $\widehat{\mathbf{Q}}_i \in \{\exists, \forall\}$

is existential *iff* the first-order quantifier symbol Q_i is existential too. At this point, the SOL sentences $\Phi_{\exists\forall}$ and $\Phi_{\forall\exists}$ can be defined as follows, where $\widehat{\phi}$ is obtained from the matrix ϕ by replacing each occurrence of a variable x_i with the corresponding term $f_i(\vec{w}_i)$, where \vec{w}_i is a vector of all the variables in W_i :

- 1) $\Phi_{\exists\forall} \triangleq \widehat{\phi}. \exists y. \forall \vec{x}. \neg R(\vec{x}y) \vee \widehat{\phi}$;
- 2) $\Phi_{\forall\exists} \triangleq \widehat{\phi}. \forall y. \exists \vec{x}. R(\vec{x}y) \wedge \widehat{\phi}$.

To conclude, the correctness of the translation can be proved by a simple induction on the length of the quantifier prefix \wp , where, as base case, we exploit the extension of Theorem 5 to Meta-ADIF. \square



Figure C.14: Dependency graph of Theorem 11.

Theorem 11 (SOL-ADF Interpretation). *For every SOL sentence Φ over a signature \mathcal{L} , relation symbol $R \in \mathcal{L}$, and sequence of variables $\vec{x} \in \text{Vr}^{\text{ar}(R)}$, there exists an ADF formula φ in pnf over signature $\mathcal{L} \setminus R$ with $\text{sup}(\varphi) = \text{free}(\varphi) = \vec{x}$ such that, for all \mathcal{L} -structures \mathfrak{A} , the following equivalence hold true: $\mathfrak{A} \models_{\text{SOL}} \Phi$ iff $\mathfrak{A} \setminus R, \{\text{Team}(R^{\mathfrak{A}}, \vec{x})\} \models^{\exists\forall} \varphi$.*

Proof. To begin with, let us assume *w.l.o.g.* (see Kontinen and Nurmi (2009) for a proof) that the SOL sentence Φ is of the form

$$(Q_i f_i)_{i=1}^k. \forall \vec{x}. (R(\vec{y}) \leftrightarrow t_1 = t_2) \wedge \psi,$$

which in addition complies with the following constraints:

- a) $\text{vr}(\Phi) \cap V = \emptyset$, *i.e.*, no variable in V occurs in Φ ;
- b) $\vec{y} \subseteq \vec{x}$, *i.e.*, the vector of variables \vec{y} used in the atom $R(\vec{y})$ is included in the vector of universally-quantified variables \vec{x} ;
- c) every function f_i only appears in a single term $t_{f_i} = f_i(\vec{w}_i)$;
- d) every term t (including t_1 and t_2) is of the form $f_i(\vec{w})$, for some index $i \in [1, k]$ and vector of variables $\vec{w} \subseteq \vec{x}$;
- e) the relation R does not occur in the FOL formula ψ .

Now, let $\wp \triangleq (\widehat{Q}_i^{+w_i} z_i)_{i=k}^1$ be the first-order quantifier prefix, where (i) the set of dependence variables W_i coincides with the vector of variables \vec{w}_i used in the term t_{f_i} corresponding to the function f_i , and (ii) each first-order quantifier symbol $\widehat{Q}_i \in \{\exists, \forall\}$ is existential *iff* the second-order quantifier symbol Q_i is existential too. Notice that the order of quantification is reversed *w.r.t.* the

one in $(Q_i f_i)_{i=1}^k$. At this point, the ADF formula φ can be defined as follows, where (1) $(\vec{y} = V)$ denotes a shortcut for a conjunction of equalities between every variable in \vec{y} and the associated variable in V (the association is the one used in the team encoding $\text{Team}(R^{\mathfrak{A}}, V)$), (2) z'_1 and z'_2 are the variables corresponding to the functions used in the terms t_1 and t_2 , and (3) ψ' is the FOL formula obtained from ψ by replacing each occurrence of a term t_{f_i} with the corresponding variable z_i :

$$\varphi \triangleq \forall \vec{x}. \varphi. ((\vec{y} = V) \leftrightarrow z'_1 = z'_2) \wedge \psi'.$$

To conclude, the correctness of the translation can be shown by first applying Theorem 8 to φ , obtaining the Meta-ADF formula

$$\text{hsp}(\varphi). \forall \vec{x}. ((\vec{y} = V) \leftrightarrow z'_1 = z'_2) \wedge \psi',$$

and then proceeding with a standard induction on the length of the quantifier prefix $(Q_i f_i)_{i=1}^k$. \square

Appendix D. Proofs of Section 5

In order to prove Theorem 12, we shall first prove two additional lemmata. The first one states a Skolemisation property for META-ADIF. A sentence of META-ADIF in prenex form that only has meta quantifiers Σ or Π can be viewed as an SOL formula. Therefore, we can use classic Skolem results to define a function Sk_x for the first existentially quantified variable x such that if \mathfrak{F} is a function assignment of variables (universally) quantified before x , then $\mathfrak{F}[x \mapsto \text{Sk}_x(\mathfrak{F})]$ satisfies the subformula that follows the quantification of x . We need some notation first. For a quantifier prefix $\varphi = Q_0^{W_0} x_0 \dots Q_n^{W_n} x_n$ and a quantifier symbol $Q \in \{\Sigma, \Pi\}$, the set $\text{vr}_Q(\varphi) = \{x_i \mid Q_i = Q\}$ collects all the variables quantified in φ using the specific symbol Q . A *Skolemisation* for φ is a sequence $(\text{Sk}_{x_i} : (\prod_{j < i} \text{Fnc}_{W_j}) \rightarrow \text{Fnc}_{W_i})_{x_i \in \text{vr}_\Sigma(\varphi)}$ of functions, one for each existentially quantifier variable x_i of φ and each one intuitively mapping the interpretations of the variables preceding x_i in φ to some interpretation for x_i . A *Skolem extension* of \mathfrak{F} w.r.t. a Skolemisation $(\text{Sk}_{x_i})_{x_i \in \text{vr}_\Sigma(\varphi)}$ for φ is a function assignment \mathfrak{F}' such that: (i) $\text{dom}(\mathfrak{F}') = \text{dom}(\mathfrak{F}) \cup \text{vr}(\varphi)$; (ii) $\mathfrak{F}'(x) = \mathfrak{F}(x)$, for $x \in \text{dom}(\mathfrak{F}) \setminus \text{vr}(\varphi)$; and (iii) $\mathfrak{F}'(x_i) = \text{Sk}_{x_i}((\mathfrak{F}'(x_j))_{j < i})$, if $x_i \in \text{vr}_\Sigma(\varphi)$. Observe that \mathfrak{F} assigns a function to each variable in φ , using the Skolemisation for the existentially quantified variables and arbitrary functions for the universally quantified ones. We can now state the following lemma.

Lemma 13 (META-ADIF Skolemisation). *Let \mathfrak{X} be a hyperteam, \mathfrak{F} a function assignment and $\varphi = \varphi\psi$ a META-ADIF formula in prenex form, where $\varphi = Q_0^{W_0} x_0 \dots Q_n^{W_n} x_n$ with $Q_i \in \{\Sigma, \Pi\}$ for $i \leq n$. The following holds: $\mathfrak{A}, \mathfrak{F}, \mathfrak{X} \models^\alpha \varphi$ iff there exists a Skolemisation $(\text{Sk}_{x_i})_{x_i \in \text{vr}_\Sigma(\varphi)}$ for φ such that $\mathfrak{A}, \mathfrak{F}', \mathfrak{X} \models^\alpha \psi$, for all Skolem extensions \mathfrak{F}' of \mathfrak{F} w.r.t. $(\text{Sk}_{x_i})_{x_i \in \text{vr}_\Sigma(\varphi)}$.*

Proof. We prove the result by induction on the size of $\text{vr}_\Sigma(\varphi)$.

Base case $\text{vr}_\Sigma(\varphi) = \emptyset$. The only Skolemisation for φ is the empty sequence of functions. A simple application of the semantic rules for the universal quantifiers, applied to $\prod x_i$ for each $i \leq n$, gives the result.

Inductive case. Suppose the property holds for all formulae with $|\text{vr}_\Sigma(\varphi)| < n$. We construct Sk_x for each $x \in \text{vr}_\Sigma(\varphi)$ with the desired properties. Let i_0 be the smallest integer such that $x_{i_0} \in \text{vr}_\Sigma(\varphi)$, so that we can set $\varphi = \prod^{W_0} x_0 \dots \prod^{W_{i_0-1}} x_{i_0-1} \Sigma^{W_{i_0}} x_{i_0} \varphi'$ and $\varphi' = \mathbf{Q}_{i_0+1}^{W_{i_0+1}} x_{i_0+1} \dots \mathbf{Q}_n^{W_n} x_n \psi = \wp' \psi$. By application of the semantic rules for the $i_0 - 1$ universal quantifiers and the last existential one, we obtain that $\mathfrak{A}, \mathfrak{F}, \mathfrak{X} \models^\alpha \varphi$ iff for every sequence of functions $(F_{x_j})_{j < i_0}$, with $F_{x_j} \in \text{Fnc}_{W_j}$, there is function $F_{x_{i_0}} \in \text{Fnc}_{W_{i_0}}$ such that $\mathfrak{A}, \mathfrak{F}', \mathfrak{X} \models^\alpha \varphi'$, with $\mathfrak{F}' = \mathfrak{F}[x_0 \mapsto F_{x_0}, \dots, x_{i_0} \mapsto F_{x_{i_0}}]$. Now, since $\text{vr}_\Sigma(\varphi') < n$, by inductive hypothesis $\mathfrak{A}, \mathfrak{F}', \mathfrak{X} \models^\alpha \varphi'$ iff there is Skolemisation $(\text{Sk}'_{x_i})_{x_i \in \text{vr}_\Sigma(\varphi')}$ for φ' such that $\mathfrak{A}, \mathfrak{F}'', \mathfrak{X} \models^\alpha \psi$, for every Skolem extension \mathfrak{F}'' of \mathfrak{F}' . We then have that $\mathfrak{A}, \mathfrak{F}, \mathfrak{X} \models^\alpha \varphi$ iff for all sequences of functions $(F_{x_j})_{j < i_0}$, there exist a function $F_{x_{i_0}}$ and a Skolemisation $(\text{Sk}'_{x_i})_{x_i \in \text{vr}_\Sigma(\varphi')}$ for φ' such that $\mathfrak{A}, \mathfrak{F}'', \mathfrak{X} \models^\alpha \psi$, for every Skolem extension \mathfrak{F}'' of $\mathfrak{F}[x_0 \mapsto F_{x_0}, \dots, x_{i_0} \mapsto F_{x_{i_0}}]$ w.r.t. $(\text{Sk}'_{x_i})_{x_i \in \text{vr}_\Sigma(\varphi')}$. Since the choices of $F_{x_{i_0}}$ and of the Skolemisation $(\text{Sk}'_{x_i})_{x_i \in \text{vr}_\Sigma(\varphi')}$ depend on the sequence $(F_{x_j})_{j < i_0}$, obviously there exists a Skolemisation $(\text{Sk}_{x_i})_{x_i \in \text{vr}_\Sigma(\varphi)}$ for φ such that $\mathfrak{A}, \mathfrak{F}'', \mathfrak{X} \models^\alpha \psi$, for all Skolem extension \mathfrak{F}'' of \mathfrak{F} w.r.t. $(\text{Sk}_{x_i})_{x_i \in \text{vr}_\Sigma(\varphi)}$. Indeed, for all sequences $(F_{x_j})_{j < i_0}$, the function $F_{x_{i_0}}$ and the Skolemisation $(\text{Sk}'_{x_i})_{x_i \in \text{vr}_\Sigma(\varphi')}$ defined as follow satisfy the properties shown above:

- $F_{x_{i_0}} = \text{Sk}_{x_{i_0}}((F_{x_j})_{j < i_0})$;
 - $\text{Sk}'_{x_{i_k}}((F_{x_j})_{i_0 < j < i_k}) = \text{Sk}_{x_{i_k}}((F_{x_j})_{j < i_k})$, for all $x_{i_k} \in \text{vr}_\Sigma(\varphi')$ and sequence of functions $(F_{x_j})_{i_0 < j < i_k}$.
-

The second lemma proves a property of the independence game $\mathcal{D}_\varphi^{\mathfrak{A}}$ defined in Construction 2 for an ADIF sentence φ and a structure \mathfrak{A} . It states that, after a history ρ , no matter how the functions in each bucket are chosen, the only assignment that is coherent with the functions in the bucket is the one associated with the last position of ρ . In the following, we consider an ADIF sentence $\varphi = \wp \psi$ in prenex form, with $\varphi = \mathbf{Q}_0^{W_0} x_0 \dots \mathbf{Q}_n^{W_n} x_n$ for $\mathbf{Q}_i \in \{\forall \exists\}$, and ψ quantifier free. For every subformula $\phi = \mathbf{Q}_i^{W_i} x_i \phi'$, we rename the buckets $\mathcal{B}_\phi(\pi)$ by $\mathcal{B}_{x_i}(\pi)$ and associate priorities with variables by setting $\text{pr}(x_i) = \text{pr}(\phi)$. Let $\mathcal{B} \triangleq \mathcal{B}^{\text{Fnc}}$ denote the set of all buckets. For convenience, we set $X = \{x_0, \dots, x_n\}$ and $X_i = \{x_0, \dots, x_i\}$, $X_\exists = \{x_i \in X \mid \mathbf{Q}_i = \exists\}$ and $X_\forall = X \setminus X_\exists$. We also introduce choice functions over buckets. Basically, a choice function over buckets chooses, for each variable x , a function F in the bucket of x . It takes both $\mathcal{B}_x(\pi)$ and x in input because there might be multiple variables with the same bucket (for instance, when they all depend exactly on the same variables and the same value have been played for all of them during the play).

$$\text{ChcB} = \{\mu: (\mathcal{B} \times X) \rightarrow \text{Fnc} \mid \forall B \in \mathcal{B}, \forall x \in X, \mu(B, x) \in B\}$$

Given a function $F_j \in \text{Fnc}_{+W_j}$ for each variable $x_j \in X_i$ with $i \leq n$, we define $\chi((F_j)_{j \leq i}) \in \text{Asg}(X_i)$ as the unique assignment χ such that $\chi(x_j) = F_j(\chi \upharpoonright \text{free}(\mathbb{Q}_j^{W_j} x_j. \phi'))$ for every $j \leq i$. We say that χ is *coherent* with $(F_j)_{j \leq i}$.

Lemma 14 (Buckets soundness). *For every choice function $\mu \in \text{ChcB}$ over buckets and every play $\pi = \rho v$ with $v = (\phi, \chi, \clubsuit)$ where $\clubsuit \in \{\downarrow, \circ\}$, the following holds:*

- if $\phi = \mathbb{Q}_i^W x_i. \phi'$ and $\clubsuit = \downarrow$, it holds $\chi = \chi((\mu(\mathcal{B}_{x_j}(\pi), x_j))_{j \leq i})$.
- if $\phi = \psi$ or $\clubsuit = \circ$ it holds $\chi = \chi((\mu(\mathcal{B}_{x_j}(\pi), x_j))_{j \leq n})$.

Proof. We prove this lemma by induction on the history ρ .

For the base case history, the property is trivial.

For the induction case, suppose the lemma holds for a history $\rho = \rho' v'$ with $v' = (\phi', \chi', \clubsuit)$. Consider a history of the form ρv . There are two cases to consider: either $\clubsuit = \downarrow$, or $\clubsuit = \circ$.

($\clubsuit = \downarrow$) There are again two cases to look at:

1. if $\phi' = \psi$ then the only possible successor position v in the game is (ϕ, χ', \circ) . So, by definition of the bucket and direct application of the inductive hypothesis, the property holds for ρv .
2. if $\phi' = \mathbb{Q}_i^W x_i. \phi$, then v is of the form (ϕ, χ, \downarrow) . The only bucket that might change is \mathcal{B}_{x_i} . By definition, any function $F \in \mathcal{B}_{x_i}(\rho v)$ satisfies $F(\chi') = \chi'(x_i)$ and the property holds for ρv . Indeed, by inductive hypothesis, $\chi(x_j) = \chi'(x_j)$, for every x_j with $j < i$.

($\clubsuit = \circ$) If $\phi' = \psi$, there is no reachable position. So, the only possibility is $\phi' = \mathbb{Q}_i^W x_i. \phi$. There are again two possibilities:

1. v is of the form (ϕ, χ', \circ) . In this case, by the definition of bucket and a direct application of the inductive hypothesis, the property immediately follows for ρv .
2. v is of the form $(\phi, \overset{\circ}{\chi}[x_i \mapsto a], \downarrow)$, for some $a \in A$ with $a \neq \chi'(x_i)$, with $\overset{\circ}{\chi} \triangleq \chi' \upharpoonright \text{free}(\mathbb{Q}_i^W x_i. \phi')$. By inductive hypothesis, for every $F \in \mathcal{B}_{x_i}(\rho)$, we have $F(\overset{\circ}{\chi}) = \chi'(x_i)$. Then, $\mathcal{F}_\phi(\overset{\circ}{\chi}) \cap \mathcal{B}_{x_i}(\rho) = \emptyset$. Thus, $\mathcal{B}_{x_i}(\rho v) = \mathcal{F}_\phi(\overset{\circ}{\chi})$ and, by definition, we have $F(\overset{\circ}{\chi} \upharpoonright W_i) = \overset{\circ}{\chi}(x_i)$, for every $F \in \mathcal{B}_{x_i}(\rho v)$. Since the other buckets have not changed, the property holds for ρv . □

Theorem 12 (Game-Theoretic Semantics). *For a finite structure \mathfrak{A} and an ADIF sentence φ in prenex form, there exists an independence game $\mathfrak{D}_\varphi^{\mathfrak{A}}$ such that $\mathfrak{A} \models \varphi$ (resp., $\mathfrak{A} \not\models \varphi$) iff $\mathfrak{D}_\varphi^{\mathfrak{A}}$ is won by Eloise (resp., Abelard).*

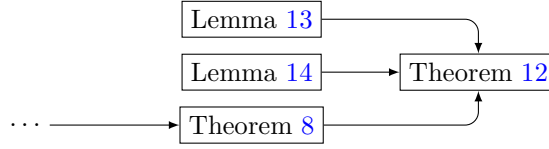

Figure D.15: Dependency graph of Theorem 12.

Proof. We prove that if the sentence is true in \mathfrak{A} , then Eloise wins the game and if the sentence is false, then Abelard wins the game.

First, suppose that the sentence φ is true in \mathfrak{A} . By Theorem 8, φ is equivalent to the META-ADIF sentence $\text{hsp}(\wp)\psi$. So, by Lemma 13 and recalling that in $\text{hsp}(\wp)$ the order of the quantifiers is reversed, we can conclude that there is a Skolemisation $(\text{Sk}_{x_i} : \prod_{j>i} \text{Fnc}_{W_j} \rightarrow \text{Fnc}_{W_i})_{x_i \in X_{\exists}}$ such that $\mathfrak{A}, \wp, \{\{\emptyset\}\} \models \varphi$, for every Skolem extension \wp of the empty assignment *w.r.t.* $(\text{Sk}_{x_i})_{x_i \in X_{\exists}}$. We now define a strategy for Eloise and then prove that it is winning. Intuitively, the strategy consists in looking, by means of the buckets, at one possible function assignment of the variables controlled by Abelard and, then, applying what is prescribed by the Skolemisation $(\text{Sk}_{x_i})_{x_i \in X_{\exists}}$ to select the values for the variables controlled by Eloise. Formally, let us fix a choice function $\mu \in \text{ChcB}$ on the buckets. Given a history ρ , we define F_i^ρ for $i \in \{0, \dots, n\}$ as follows. If $x_i \in X_{\forall}$ then $F_i^\rho = \mu(\mathcal{B}_{x_i}(\rho), x_i)$, otherwise, $F_i^\rho = \text{Sk}_{x_i}((F_j^\rho)_{j>i})$. When Eloise must make a move for the variable x_i at the history $\rho = \rho'v'$, with $v' = (\phi, \chi, -)$, she moves to the position $v = (\phi', \chi', -)$ with $\chi'(x_i) = F_i^\rho(\chi)$. Observe that this strategy does not depend on the current phase of the game.

Consider now a finite play $\pi = \rho v$, with $v = (\psi, \chi, \cup)$, compatible with the strategy. We define a choice function $\hat{\mu}$ as follows: for all $x_i \in X$

$$\hat{\mu}(\mathcal{B}_{x_i}(\pi), x_i) = F_i^\pi$$

The function $\hat{\mu}$ is a choice function since, if $x_i \in X_{\forall}$, by definition, $F_i^\pi \in \mathcal{B}_{x_i}(\pi)$ and if $x_i \in X_{\exists}$, then because Eloise played according to F_i^π , this function is in the bucket of x_i . The Lemma 14 ensures that the assignment χ is coherent with $(\hat{\mu}(\mathcal{B}_x(\pi), x))_{x \in X}$. By definition of $(\text{Sk}_{x_i})_{x_i \in X_{\exists}}$, it holds that $\chi \models \psi$. Therefore, the play is won by Eloise.

Let us now consider an infinite play $\pi \in \text{Play}^\omega$ compatible with the strategy. Toward a contradiction, suppose that the priority $\text{pr}(\pi)$ of the play is odd. Then, there must be a variable $x_i \in X_{\exists}$ such that (i) $\text{pr}(x_i)$ appears infinitely often in $\text{cht}(\pi)$ and (ii) for all $j > i$ the priority $\text{pr}(x_j)$ appears only a finite number of time. Recall that if a variable x is not “caught cheating” after a finite prefix $\pi' = \rho v$ of π , then $\mathcal{B}_x(\pi') \subseteq \mathcal{B}_x(\rho)$. But then, since we assumed the domain to be finite, starting from some index N along the play π , the buckets for each x_j , with $j > i$, remain constant forever. Let us denote the constant bucket of x_j by \mathcal{B}'_{x_j} . Then, the strategy for x_i is for Eloise to chose the values of x_i by means of the function $F_i = \text{Sk}_{x_i}((\mu(\mathcal{B}'_{x_j}(\pi), x_j))_{j>i})$, which is constant since the buckets of variables x_j do not change. By definition, for every prefix of π of size greater

than N , the bucket of x_i contains F_i . Then the bucket of x_i is never emptied and x_i would never get “caught cheating”. This is a contradiction. We proved that if the sentence is true, then Eloise has a winning strategy in $\mathcal{D}_\varphi^{\mathfrak{A}}$.

The second part of the proof proceeds similarly, in that we can apply the same exact reasoning, with only the roles of Eloise and Abelard exchanged, to obtain a winning strategy for Abelard.

□

References

- Blass, A., Gurevich, Y., 1986. Henkin Quantifiers and Complete Problems. *Annals of Pure and Applied Logic* 32, 1–16.
- Bradfield, J., 2013. Team Building in Dependence., in: *Computer Science Logic'13*, Leibniz-Zentrum fuer Informatik. pp. 116–128.
- Buss, S., 1998. An Introduction to Proof Theory., in: *Handbook of Proof Theory.* Elsevier, pp. 1–78.
- Church, A., 1956. *Introduction to Mathematical Logic*. Princeton Mathematical Series 17., Princeton University Press.
- Clairambault, P., Gutierrez, J., Winskel, G., 2013. Imperfect Information in Logic and Concurrent Games., in: *Computation, Logic, Games, and Quantum Foundations. The Many Facets of Samson Abramsky: Essays Dedicated to Samson Abramsky on the Occasion of His 60th Birthday.* Springer, pp. 7–20.
- Enderston, H., 1970. Finite Partially-Ordered Quantifiers. *Mathematical Logic Quarterly* 16, 393–397.
- Galliani, P., 2012. Inclusion and Exclusion Dependencies in Team Semantics - On Some Logics of Imperfect Information. *Annals of Pure and Applied Logic* 163, 68–84.
- Grädel, E., Kolaitis, P., Libkin, L., Marx, M., Spencer, J., Vardi, M., Venema, Y., Weinstein, S., 2005. *Finite Model Theory and Its Applications*. Texts in Theoretical Computer Science., Springer.
- Grädel, E., Väänänen, J., 2013. Dependence and Independence. *Studia Logica* 101, 399–410.
- Harel, D., 1979. Characterizing Second Order Logic with First Order Quantifiers. *Mathematical Logic Quarterly* 25, 419–422.
- van Heijenoort, J., 1967. *From Frege to Gödel: A Source Book in Mathematical Logic, 1879–1931*. Harvard University Press.
- Henkin, L., 1961. Some Remarks on Infinitely Long Formulas, in: *Infinitistic Methods'61*, Pergamon Press. pp. 167–183.
- Hilbert, D., Ackermann, W., 1928. *Grundzüge der Theoretischen Logik*. Die Grundlehren der Mathematischen Wissenschaften., Springer.
- Hilbert, D., Ackermann, W., 1938. *Grundzüge der Theoretischen Logik (zweiten auflage)*. Die Grundlehren der Mathematischen Wissenschaften., Springer.
- Hintikka, J., 1973. *Logic, Language-Games and Information: Kantian Themes in the Philosophy of Logic*. Oxford University Press.
- Hintikka, J., 1996. *The Principles of Mathematics Revisited*. Cambridge University Press.
- Hintikka, J., Sandu, G., 1989. Informational Independence as a Semantical Phenomenon., in: *International Congress on Logic, Methodology, and Philosophy of Science'89*, Elsevier. pp. 571–589.
- Hintikka, J., Sandu, G., 1997. Game-Theoretical Semantics., in: *Handbook of Logic and Language.* North-Holland & Elsevier, pp. 361–410.
- Hodges, W., 1997a. Compositional Semantics for a Language of Imperfect Information. *Logic Journal of the IGPL* 5, 539–563.

- Hodges, W., 1997b. Some Strange Quantifiers., in: Structures in Logic and Computer Science: A Selection of Essays in Honor of A. Ehrenfeucht.. Springer, pp. 51–65.
- Immerman, N., 1999. Descriptive Complexity. Graduate Texts in Computer Science., Springer.
- Kontinen, J., Nurmi, V., 2009. Team Logic and Second-Order Logic., in: Workshop on Logic, Language, Information and Computation'09, Springer. pp. 230–241.
- Kontinen, J., Väänänen, J., 2009. On Definability in Dependence Logic. Journal of Logic, Language, and Information 18, 317–332.
- Kreisel, G., 1951. On the Interpretation of Non-Finitist Proofs - Part I. Journal of Symbolic Logic 16, 241–267.
- Kreisel, G., 1952. On the Interpretation of Non-Finitist Proofs: Part II. Interpretation of Number Theory. Applications. Journal of Symbolic Logic 17, 43–58.
- Krynicky, M., Mostowski, M., 1995. Henkin Quantifiers, in: Quantifiers: Logics, Models and Computation, Volume I. Springer, pp. 193–262.
- Kuusisto, A., 2013. Expressivity of Imperfect Information Logics without Identity. Studia Logica 101, 237–265.
- Kuusisto, A., 2015. A Double Team Semantics for Generalized Quantifiers. Journal of Logic, Language, and Information 24, 149–191.
- Lorenz, K., 1968. Dialogspiele als Semantische Grundlage von Logikkalkülen. Archiv für Mathematische Logik und Grundlagenforschung 11, 32–55.
- Lorenzen, P., 1961. Ein Dialogisches Konstruktivitätskriterium., in: Symposium on Foundations of Mathematics'59, Polish Scientific Publishers. pp. 193–200.
- Mann, A., Sandu, G., Sevenster, M., 2011. Independence-Friendly Logic - A Game-Theoretic Approach. Cambridge University Press.
- Martin, A., 1975. Borel Determinacy. Annals of Mathematics 102, 363–371.
- Martin, A., 1985. A Purely Inductive Proof of Borel Determinacy., in: Recursion Theory'82, American Mathematical Society and Association for Symbolic Logic. pp. 303–308.
- von Neumann, J., Morgenstern, O., 1944. Theory of Games and Economic Behavior. Princeton University Press.
- Shapiro, S., 1991. Foundations Without Foundationalism: A Case for Second-Order Logic. Oxford University Press.
- Stockmeyer, L., 1976. The Polynomial-Time Hierarchy. Theoretical Computer Science 3, 1–22.
- Tarski, A., 1936. The Concept of Truth in Formalized Languages., in: Logic, Semantics, Metamathematics.. Oxford University Press, pp. 152–278.
- Tarski, A., 1944. The Semantic Conception of Truth: and the Foundations of Semantics. Philosophy and Phenomenological Research 4, 341–376.
- Väänänen, J., 2007. Dependence Logic: A New Approach to Independence Friendly Logic. volume 70 of *London Mathematical Society Student Texts*. Cambridge University Press.
- Walkoe, W., 1970. Finite Partially-Ordered Quantification. Journal of Symbolic Logic 35, 535–555.