

STOCHASTIC SIX-VERTEX MODELS, HALL-LITTLEWOOD POSITIVITY AND t -DEFORMED SCHENSTED INSERTIONS

KONSTANTIN MATVEEV

ABSTRACT. We prove a positivity theorem for a certain family of operators defined in terms of the stochastic six-vertex model. We explore connections of this result with other vertex models and t -deformed Schensted insertions.

1. INTRODUCTION

1.1. Positivity phenomena. The main result of this paper is theorem 1.6. It belongs to the following class of theorems. Suppose $P(h_1, h_2, \dots, h_m)$ is some polynomial with many positive and negative coefficients. Suppose each h_i is itself a polynomial in a_1, a_2, \dots, a_n . Then a priori there is no reason to expect that P as a polynomial in a_1, a_2, \dots, a_n will have positive coefficients. If it happens to be the case, it might be an indication that there is some structure underlying this phenomenon. Here is a relevant example. Denote by Λ_n the commutative algebra of symmetric polynomials in a_1, a_2, \dots, a_n over \mathbb{R} . Define the r -th *complete symmetric polynomial*

$$(1.1) \quad h_r := \sum_{1 \leq i_1 \leq i_2 \leq \dots \leq i_r \leq n} a_{i_1} a_{i_2} \dots a_{i_r} \in \Lambda_n, \quad h_0 = 1, \quad h_r = 0 \quad \text{for } r < 0.$$

Proposition 1.1. *For a partition $\lambda = \{\lambda_1 \geq \lambda_2 \geq \dots \geq \lambda_\ell\}$, $\lambda_i \in \mathbb{N}$, take polynomial P to be $\det [h_{\lambda_i - i + j}]_{i,j=1}^\ell$. Then P as a polynomial in a_1, a_2, \dots, a_n has positive coefficients.*

In this case P turns out to be the Schur polynomial $S_\lambda(a_1, a_2, \dots, a_n)$ due to the Jacobi-Trudi formula. It has representation as a summation over semistandard tableaux λ :

$$(1.2) \quad S_\lambda = \sum_{\lambda \text{ of shape } \lambda} a^\lambda = \sum_{\lambda \text{ of shape } \lambda} \prod_{i=1}^{\infty} a_i^{\lambda(i)},$$

where $\lambda(i)$ is the number of entries in λ equal to i . See [F97] for more details. So coefficients of P in this case are positive integers. Theorem 1.6 is a generalization of proposition 1.1. It comes from the following "commutative diagram" of generalizations.

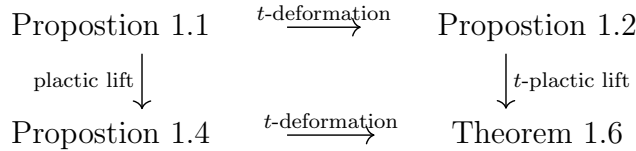

Below we explain all the constituent elements of this diagram in more detail. The genesis of the paper is the following:

- (1) Realizing that well known propositions 1.1, 1.2 and less well known proposition 1.4 are true and a guess that theorem 1.6 might be true as well.
- (2) Checking correctness of theorem 1.6 for many specific partitions λ with the assistance of *Wolfram Mathematica*.

- (3) Using the angle of t -deformed plactic algebra actions to find the right generalization of the summation formula (1.2) from which theorem 1.6 follows.
- (4) Realizing that extended vertex models provide the right framework for expressing and proving such generalization.

1.2. Hall-Littlewood symmetric polynomials. Hall-Littlewood symmetric polynomial P_λ is a t -deformation of the Schur polynomial S_λ . It becomes S_λ for $t = 0$. See [Mac99] for more details and [H59], [L61] for the origin of the concept. One possible definition of $P_\lambda(a_1, a_2, \dots, a_n)$ is the following. Denote by $m_k(\lambda)$ the number of parts λ_i , which are equal to k . Then

$$P_\lambda := \frac{1}{v_\lambda(t)} \sum_{w \in S_n} w \left(a_1^{\lambda_1} a_2^{\lambda_2} \dots a_n^{\lambda_n} \prod_{1 \leq i < j \leq n} \frac{a_i - ta_j}{a_i - a_j} \right), \quad \text{where } v_\lambda(t) := \prod_{k \geq 0} \prod_{i=1}^{m_k(\lambda)} \frac{1-t^i}{1-t}.$$

Proposition 1.2. *For $0 \leq t < 1$ all the coefficients of P_λ are non-negative.*

This result follows from the following summation formula

$$(1.3) \quad P_\lambda = \sum_{\lambda \text{ of shape } \lambda} \psi_\lambda(t) a^\lambda$$

Here tableau weight $\psi_\lambda(t)$ can be defined as the product $\prod_{s \in \text{Boxes of } \lambda} (1 - e(s))$, where for a box s with entry p in the i -th row and the j -th column of λ we define

$$e(s) := \begin{cases} 0, & \text{if } j = 1 \text{ or the } (j-1)\text{-st column} \\ & \text{of } T \text{ also contains } p, \\ t^{|\{\text{entries } < p \text{ in the } (j-1)\text{-st column of } T\}| - i + 1}, & \text{otherwise.} \end{cases}$$

All product terms are clearly non-negative for $0 \leq t < 1$. Proposition 1.1 follows from proposition 1.2 by substituting $t = 0$.

1	3	5	1	2	4
2	5		2	4	
4			5		

FIGURE 1. $\lambda = (3, 2, 1)$, $n = 5$. *Left:* A tableau with weight $\psi(t) = (1-t^2)^2$.
Right: A tableau with weight $\psi(t) = 1-t$.

Let $g_k = (1-t)P_{(k)}$. For $t = 0$ polynomial g_k becomes h_k . Then it is easy to show that $\Lambda_n = \mathbb{R}[g_1, g_2, \dots, g_n]$ and factorization of the generating function for g'_k s

$$(1.4) \quad 1 + \sum_{k=1}^{\infty} g_k \alpha^k = \prod_{i=1}^n \frac{1 - t\alpha a_i}{1 - \alpha a_i}$$

1.3. Plactic algebra action. *Plactic monoid* Pl_n of rank n is a monoid generated by letters $1, 2, \dots, n$ modulo the *Knuth relations*:

$$xzy \equiv zxy \quad (x \leq y < z), \quad yxz \equiv yzx \quad (x < y \leq z).$$

See [Lot02] for more details.

Definition 1.3. Pl_n acts on the set of subsets of $\{1, 2, \dots, n\}$ via the following formula. For $S \subseteq \{1, 2, \dots, n\}$ define

$$(1.5) \quad i \cdot S = \begin{cases} S, & \text{if } i \in S, \\ S \cup \{i\}, & \text{if } i \notin S \text{ and } S \cap \{i+1, \dots, n\} = \emptyset, \\ S \cup \{i\} - \{\text{First element of } S \cap \{i+1, \dots, n\}\}, & \text{if } i \notin S \text{ and } S \cap \{i+1, \dots, n\} \neq \emptyset. \end{cases}$$

Consider the plactic algebra $\mathbb{R}[a_1, a_2, \dots, a_n][Pl_n]$ spanned by the monoid Pl_n . By linearly extending the previous action we get that $\mathbb{R}[a_1, a_2, \dots, a_n][Pl_n]$ acts on the space of formal linear combinations of subsets of $\{1, 2, \dots, n\}$.

Consider the following commuting elements of $\mathbb{R}[a_1, a_2, \dots, a_n][Pl_n]$.

$$(1.6) \quad H_r := \sum_{1 \leq i_1 \leq i_2 \leq \dots \leq i_r \leq n} (a_{i_1} a_{i_2} \dots a_{i_r}) i_1 \cdot i_2 \dots i_r \in \mathbb{R}[a_1, a_2, \dots, a_n][Pl_n],$$

$$H_0 = Id, \quad H_r = 0 \quad \text{for } r < 0.$$

Proposition 1.4. For any partition λ element $\det [H_{\lambda_i - i + j}]_{i,j=1}^{\ell} \in \mathbb{R}[a_1, a_2, \dots, a_n][Pl_n]$ sends any subset $S \subseteq \{1, 2, \dots, n\}$ to a linear combination of subsets of $\{1, 2, \dots, n\}$ with each coefficient being a polynomial in a_1, a_2, \dots, a_n with positive coefficients.

Note that $i \cdot \{1, 2, \dots, n\} = \{1, 2, \dots, n\}$ for any $1 \leq i \leq n$. Hence $\det [H_{\lambda_i - i + j}]_{i,j=1}^{\ell} \cdot \{1, 2, \dots, n\} = S_{\lambda}(a_1, a_2, \dots, a_n) \cdot \{1, 2, \dots, n\}$. So proposition 1.1 is a special case of proposition 1.4 for $S = \{1, 2, \dots, n\}$. The reason behind proposition 1.4 is combinatorics of the Schensted insertion algorithm. This connection is explained in more detail in section 3.

1.4. Stochastic six-vertex model. We will work with inhomogeneous transfer matrices of a stochastic six-vertex model. Let V be a two-dimensional real vector space spanned by elements 1 and 2. Given two parameters a, t one can define an operator $R = R(a, t) : V^{\otimes 2} \rightarrow V^{\otimes 2}$ by

$$(1.7) \quad R(2 \otimes 2) = 2 \otimes 2, \quad R(2 \otimes 1) = \frac{1-a}{1-ta} \cdot 2 \otimes 1 + \frac{(1-t)a}{1-ta} \cdot 1 \otimes 2,$$

$$R(1 \otimes 2) = \frac{1-t}{1-ta} \cdot 2 \otimes 1 + \frac{t(1-a)}{1-ta} \cdot 1 \otimes 2, \quad R(1 \otimes 1) = 1 \otimes 1.$$

For $0 \leq a \leq 1$ and $0 \leq t < 1$ the matrix of R with respect to basis $\{2 \otimes 2, 2 \otimes 1, 1 \otimes 2, 1 \otimes 1\}$ of $V^{\otimes 2}$ is stochastic. This R -matrix gives rise to a stochastic six-vertex model with weights as depicted on Fig. 2.

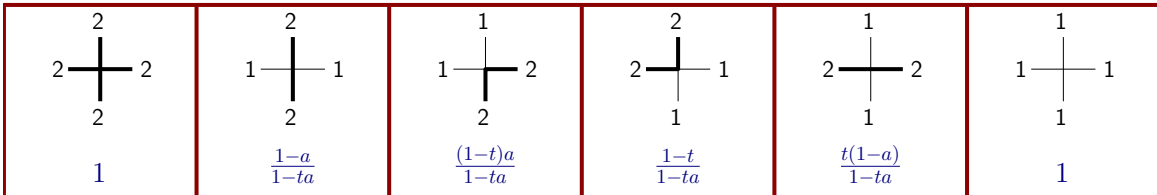

FIGURE 2. Stochastic six-vertex model with weights coming from $R(a, t)$. Fat lines correspond to 2's, normal lines correspond to 1's.

For parameters $\alpha, t, a_1, a_2, \dots, a_n$ we use R to define a transfer operator of a six-vertex model

$$T(\alpha) = T(\alpha, t; a_1, a_2, \dots, a_n) : V^{\otimes n} \rightarrow V^{\otimes n}$$

as specified on Fig. 3. Note that there is fixed input 1 on the left, while boundary condition on the right is free (it can be either 1 or 2). For $0 \leq \alpha a_1, \alpha a_2, \dots, \alpha a_n \leq 1$ and $0 \leq t < 1$ the

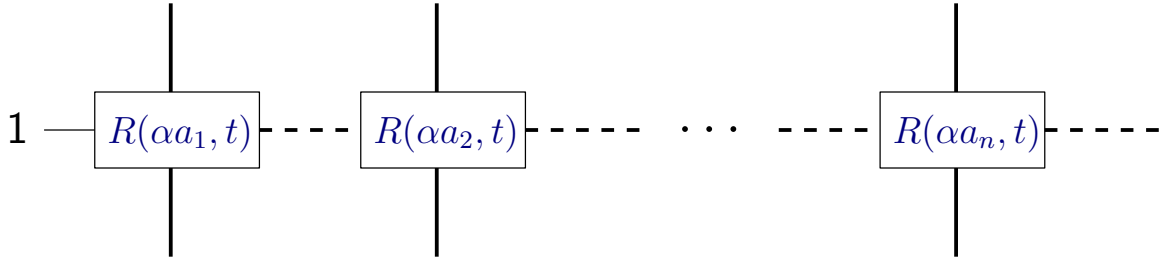

FIGURE 3. $T(\alpha)$ is a transfer operator for the inhomogeneous six-vertex model defined via R . Boundary condition is fixed to be 1 on the left and is free on the right.

matrix of $T(\alpha)$ with respect to basis $\{1, 2\}^{\otimes n}$ of $V^{\otimes n}$ is stochastic. $V^{\otimes n} = \bigoplus_{k=0}^n V_{n,k}$, where each subspace $V_{n,k}$ is defined as the span of vectors $e_1 \otimes e_2 \otimes \dots \otimes e_n$ with exactly k 1's and $n - k$ 2's among the e_i 's. Then clearly $T(\alpha)(V_{n,k}) \subset V_{n,k} \oplus V_{n,k+1}$ for $0 \leq k < n$. Operators $T(\alpha)$ and $T(\beta)$ commute via a standard argument of pulling an extra vertex through due to the Yang-Baxter equation for R specified on Fig. 4. Let

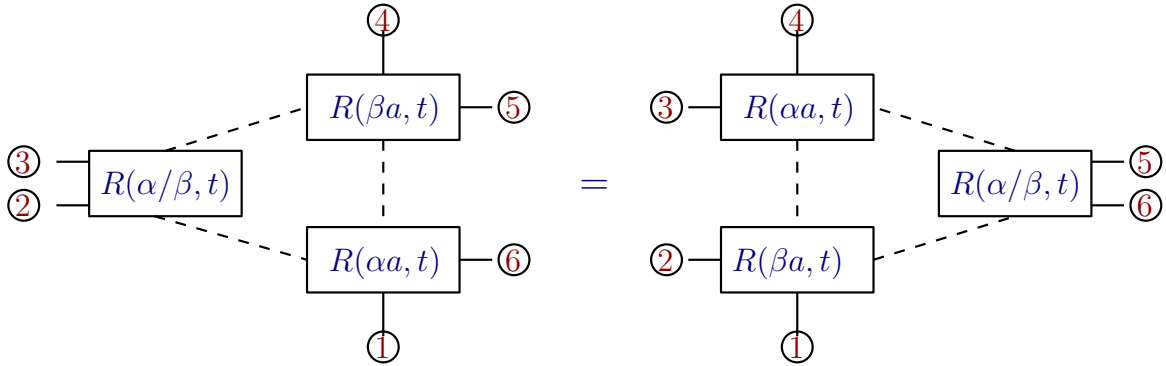

FIGURE 4. Yang-Baxter equation for matrix R .

$$(1.8) \quad \tilde{T}(\alpha) := \left(\prod_{i=1}^n \frac{1 - t\alpha a_i}{1 - \alpha a_i} \right) T(\alpha).$$

Then $\tilde{T}(\alpha)$ is the transfer operator for the inhomogeneous six-vertex model with weights specified on Fig. 5. Consider the power expansion $\tilde{T}(\alpha) = Id + \sum_{k=1}^{\infty} T_k \alpha^k$. Operators $\tilde{T}(\alpha)$ and $\tilde{T}(\beta)$

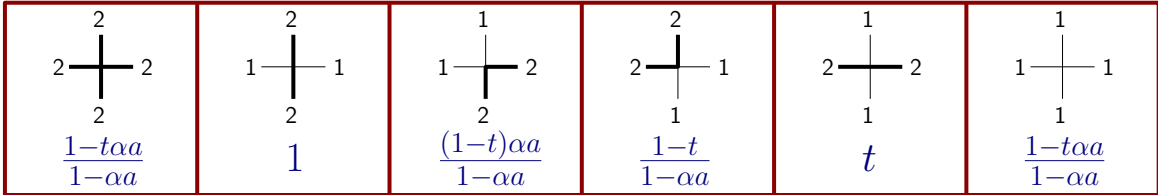

FIGURE 5. Six-vertex model weights for $\tilde{T}(\alpha)$.

commute with each other, hence operators T_k and T_ℓ commute for all positive integers k, ℓ .

Definition 1.5. Define representation $\Theta : \Lambda_n \rightarrow \text{End}(V^{\otimes n})$ by $\Theta(g_k) = T_k$ for $1 \leq k \leq n$. We will later check that this equality also holds for $k > n$.

1.5. Statement of the main result. Our main result is the following

Theorem 1.6. For $0 \leq t < 1$ and any partition λ all matrix elements of $\Theta(P_\lambda)$ with respect to basis $\{1, 2\}^{\otimes n}$ are polynomials in a_1, a_2, \dots, a_n with non-negative coefficients.

Corollary 1.7. For $a_1, a_2, \dots, a_n > 0$ and any partition λ with $\lambda'_1 \leq n$ the matrix of $\frac{\Theta(P_\lambda)}{P_\lambda(a_1, a_2, \dots, a_n)}$ with respect to basis $\{1, 2\}^{\otimes n}$ is stochastic.

Proof of the corollary 1.6. Take $v \in \{1, 2\}^{\otimes n}$. Then sum of basis coefficients of $T(\alpha)(v)$ is 1, since weights of $T(\alpha)$ are stochastic. So sum of basis coefficients of $\tilde{T}(\alpha)(v)$ is $\prod_{i=1}^n \frac{1-t\alpha a_i}{1-\alpha a_i} = 1 + \sum_{k=1}^{\infty} g_k(a_1, a_2, \dots, a_n) \alpha^k$ due to (1.4). So sum of basis coefficients of $T_k(v)$ is $g_k(a_1, a_2, \dots, a_n)$. Hence sum of basis coefficients of $T_k(v)$ is $P_\lambda(a_1, a_2, \dots, a_n)$. Conditions $\lambda'_1 \leq n$ and $0 \leq t < 1$ guarantee that $P_\lambda(a_1, a_2, \dots, a_n) > 0$ due to formula (1.3), so we can divide by it. \square

To relate theorem 1.6 to proposition 1.4 associate $v_1 \otimes v_2 \otimes \dots \otimes v_n$ to $S \subseteq \{1, 2, \dots, n\}$ by including $1 \leq i \leq n$ in S if and only if $v_i = 1$. Then one can check that for $t = 0$ operator $\tilde{T}(\alpha)$ turns into action by $Id + \sum_{k=0} \alpha^k H_k$. Hence $T_k^{t=0} = H_k$ and proposition 1.4 becomes a special case of theorem 1.6. See also [BBW16].

1.6. Paper outline. In section 2 we explore connection with a problem of Kerov on classifying homomorphisms from the algebra of symmetric functions to \mathbb{R} with non-negative values on Macdonald functions. In section 3 we recall the background on plactic algebra, Schensted's insertions and prove proposition 1.4. In section 4 we explore t -deformations of Schensted insertions and introduce extended vertex models into the picture. In section 5 we prove theorem 1.6.

2. POSITIVE HOMOMORPHISMS

Denote by Λ the algebra of symmetric power series of bounded degree (called *symmetric functions*) in countably many variables x_1, x_2, x_3, \dots over \mathbb{R} . For fixed parameters $-1 < q, t < 1$ algebra Λ admits two special linear bases of *Macdonald functions*: $\{P_\lambda(x_1, x_2, x_3, \dots; q, t)\}_{\lambda \in \mathcal{P}}$ and $\{Q_\lambda(x_1, x_2, x_3, \dots; q, t)\}_{\lambda \in \mathcal{P}}$. Here \mathcal{P} denotes the set of *partitions*, and $Q_\lambda(q, t) = b_\lambda(q, t)P_\lambda(q, t)$ for some constant $b_\lambda(q, t) > 0$. See [Mac99] for more background on Macdonald functions. In particular, the one-row Macdonald functions are

$$(2.1) \quad g_r := Q_{(r)} = \sum_{r_1, r_2, r_3, \dots \geq 0: r_1 + r_2 + r_3 + \dots = r} \prod_{i \geq 1} \frac{(t; q)_{r_i}}{(q; q)_{r_i}} x_i^{r_i}, \quad \text{where} \quad (a; q)_k := \prod_{m=1}^k (1 - aq^{m-1})$$

is the q -Pochhammer symbol. Also $e_r = \sum_{1 < i_1 < i_2 < \dots < i_r} x_{i_1} x_{i_2} \dots x_{i_r}$, the r -th *elementary symmetric function* is the same as P_{1^r} , the one-column Macdonald function. Note that for $q = 0$ Macdonald functions P_λ become the Hall-Littlewood functions, which turn into Hall-Littlewood polynomials P_λ of subsection 1.2 after setting $x_i \rightarrow a_i$ for $1 \leq i \leq n$ and $x_i \rightarrow 0$ for $i > n$. Then g_r of equality (2.1) becomes g_r of equality (1.4). Any element of Λ can be uniquely represented as a polynomial in g_r 's. The following result was conjectured by S.V. Kerov in [Ker92, Sec. 7.3] (see also [Ker03, p. 106]) and proved by the author in [M19].

Theorem 2.1 ([M19]). For fixed $-1 < q, t < 1$ a homomorphism $\theta : \Lambda \rightarrow \mathbb{R}$ has the property that $\theta(P_\lambda) \geq 0$ for any partition $\lambda \in \mathcal{P}$ (is Macdonald-positive) if and only if it is defined by the

generating function

$$(2.2) \quad 1 + \sum_{r=1}^{\infty} \theta(g_r) z^r = e^{\gamma z} \cdot \prod_{i=1}^{\infty} \frac{(t\alpha_i z; q)_{\infty}}{(\alpha_i z; q)_{\infty}} \cdot \prod_{j=1}^{\infty} (1 + \beta_j z)$$

for some $\alpha_i, \beta_j, \gamma \geq 0$, such that $\sum_{i=1}^{\infty} \alpha_i + \sum_{j=1}^{\infty} \beta_j < \infty$.

For $q = t$ both functions P_{λ} and Q_{λ} become the Schur function S_{λ} . The corresponding special case of Theorem 2.1 is known as the *Edrei-Thoma theorem*. It was first conjectured in [Sch48] and then proved in a series of papers [ASW52], [Edr52], [Whit52] in the language of classifying infinite totally non-negative upper triangular Toeplitz matrices. It was independently discovered and proved in [Th64] in the context of classifying characters of the *infinite symmetric group* S_{∞} . See [BO17] for more details on the representation theory of the infinite symmetric group.

Corollary 2.2. *Suppose $0 \leq t < 1$. Homomorphism $\theta : \Lambda_n \rightarrow \mathbb{R}$ has non-negative values on all Hall-Littlewood symmetric polynomials if and only if it is given by setting $\theta(a_i) := \alpha_i \geq 0$ and restricting to Λ_n .*

Proof of corollary 2.2. θ defined by by setting $\theta(a_i) := \alpha_i \geq 0$ is non-negative on all Hall-Littlewood polynomials due to equality (1.3). For the reverse direction first define $\pi : \Lambda \rightarrow \Lambda_n$ by setting $\pi(x_i) = a_i$ for $1 \leq i \leq n$, $\pi(x_i) = 0$ for $i > n$ and restricting to symmetric functions. $\pi(e_r) = e_r(a_1, a_2, \dots, a_n)$ for $1 \leq r \leq n$, $\pi(e_r) = 0$ for $r > n$. There is a homomorphism $w_{t,0} : \Lambda \rightarrow \Lambda$ sending the t -Whittaker function $P_{\lambda}(t, 0)$ to the Hall-Littlewood function $Q_{\lambda'}(0, t) = b_{\lambda'}(0, t)P_{\lambda'}(0, t)$ for a conjugate partition λ' , as well as sending $Q_{\lambda}(t, 0)$ to $P_{\lambda}(t, 0)$, see [Mac99] for details. Suppose a homomorphism $\theta : \Lambda_n \rightarrow \mathbb{R}$ has non-negative values on all Hall-Littlewood symmetric polynomials. Define $\tilde{\theta} : \Lambda \rightarrow \mathbb{R}$ by $\tilde{\theta} = \theta \circ \pi \circ w_{t,0}$. Then $\tilde{\theta}$ takes non-negative values on all $P_{\lambda}(t, 0)$, so by theorem 2.1 it can be defined by the generating function

$$1 + \sum_{r=1}^{\infty} \tilde{\theta}(g_r(t, 0)) z^r = e^{\gamma z} \cdot \prod_{i=1}^{\infty} \frac{1}{(\alpha_i z; t)_{\infty}} \cdot \prod_{j=1}^{\infty} (1 + \beta_j z)$$

The left hand side of this equality is $1 + \sum_{r=1}^{\infty} \tilde{\theta}(g_r(t, 0)) z^r = 1 + \sum_{r=1}^n \theta(e_r(a_1, a_2, \dots, a_n)) z^r$. In particular, the coefficient of z^m in it is 0 for $m > n$. Note that we have

$$\frac{1}{(\alpha_i z; t)_{\infty}} = \sum_{k=0}^{\infty} \frac{\alpha_i^k z^k}{(t; t)_k}$$

by the t -Gauss summation formula. So if either $\gamma > 0$, or at least one $\alpha_i > 0$, or there were more than n non-zero β_j 's, then $1 + \sum_{r=1}^{\infty} \tilde{\theta}(g_r(t, 0)) z^r$ would contain powers of z higher than n with strictly positive coefficients. That would be a contradiction. Hence

$$1 + \sum_{r=1}^n \theta(e_r(a_1, a_2, \dots, a_n)) z^r = \prod_{j=1}^n (1 + \beta_j z).$$

Relabel β_j as α_j . Then $\theta(e_r(a_1, a_2, \dots, a_n)) = e_r(\alpha_1, \alpha_2, \dots, \alpha_n)$. So θ is defined by setting $\theta(a_i) := \alpha_i \geq 0$ and restricting to Λ_n . □

So theorem 1.6 can be viewed as a multidimensional generalization of the easier direction of corollary 2.2. This raises a question: what would be the right multidimensional generalization of the harder direction?

3. PLACTIC ALGEBRA AND SCHENSTED'S INSERTIONS

3.1. Signatures, tableaux and particle arrays. A *signature*¹ of length $n \geq 1$ is a non-increasing collection of integers $\lambda = (\lambda_1 \geq \dots \geq \lambda_n) \in \mathbb{Z}^n$. We will work with signatures which have only nonnegative parts, i.e., $\lambda_n \geq 0$ (in which case they are also called *partitions*). Denote the set of all such objects by \mathbb{GT}_n^+ . Let also $\mathbb{GT}^+ := \bigcup_{n=1}^{\infty} \mathbb{GT}_n^+$, with the understanding that we identify $\lambda \cup 0 = (\lambda_1, \dots, \lambda_n, 0, 0, \dots, 0) \in \mathbb{GT}_{n+m}^+$ (m zeros) with $\lambda \in \mathbb{GT}_n^+$ for any $m \geq 1$.

We will use two ways to depict signatures (see Fig. 6):

- (1) Any signature $\lambda \in \mathbb{GT}_n^+$ can be identified with a *Young diagram* (having at most n rows) as in [Mac99, I.1].
- (2) A signature $\lambda \in \mathbb{GT}_n^+$ can also be represented as a configuration of n particles on $\mathbb{Z}_{\geq 0}$ (with the understanding that there can be more than one particle at a given location).

We denote by $|\lambda| := \sum_{i=1}^n \lambda_i$ the number of boxes in the corresponding Young diagram, and by $\ell(\lambda)$ the number of nonzero parts in λ (which is finite for all $\lambda \in \mathbb{GT}^+$). For $\mu, \lambda \in \mathbb{GT}^+$ we will write $\mu \subseteq \lambda$ if $\mu_i \leq \lambda_i$ for all $i \in \mathbb{Z}_{>0}$. In this case, the set difference of Young diagrams λ and μ is denoted by λ/μ and is called a *skew Young diagram*.

Two signatures $\mu, \lambda \in \mathbb{GT}^+$ are said to *interlace* if one can append them by zeros such that $\mu \in \mathbb{GT}_{n-1}^+$ and $\lambda \in \mathbb{GT}_n^+$ for some N , and

$$(3.1) \quad \lambda_1 \geq \mu_1 \geq \lambda_2 \geq \mu_2 \geq \dots \geq \lambda_{n-1} \geq \mu_{n-1} \geq \lambda_n.$$

In terms of Young diagrams, this means that λ is obtained from μ by adding a *horizontal strip* (or, equivalently, that *the skew diagram λ/μ is a horizontal strip* which is, by definition, a skew Young diagram having at most one box in each vertical column), and we denote this by $\mu <_h \lambda$.

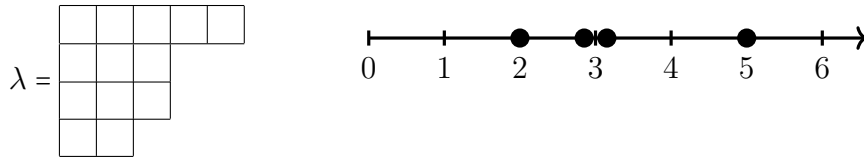

FIGURE 6. Young diagram $\lambda = (5, 3, 3, 2) \in \mathbb{GT}_4^+$, and the corresponding particle configuration. Note that there are two particles at location 3.

Let λ' denote the transposition of the Young diagram λ . For the diagram on Fig. 6, we have $\lambda' = (4, 4, 3, 1, 1)$. If λ/μ is a horizontal strip, then λ'/μ' is called a *vertical strip*. We will denote the corresponding relation by $\mu' <_v \lambda'$.

Definition 3.1. A Gelfand–Tsetlin array (sometimes also referred to as *scheme*, or *pattern*) of depth n is a sequence of interlacing signatures $\boldsymbol{\lambda} = (\lambda^{(1)} <_h \lambda^{(2)} <_h \dots <_h \lambda^{(n)})$, where $\lambda^{(j)} \in \mathbb{GT}_j^+$.

Such sequences first appeared in connection with representation theory of unitary groups [GC50].² We will depict sequences $\boldsymbol{\lambda}$ as interlacing integer arrays, and also associate to them configurations of particles $\{(\lambda_j^{(k)}, k) : k = 1, \dots, n, j = 1, \dots, k\}$ on n horizontal copies of $\mathbb{Z}_{\geq 0}$. See Fig. 7.

Let us denote the set of all interlacing arrays $\boldsymbol{\lambda}$ of depth n with top level λ by $\mathbb{GT}^{(n)}(\lambda)$. Let $\mathbb{GT}^{(n)} := \bigcup_{\lambda \in \mathbb{GT}_n^+} \mathbb{GT}^{(n)}(\lambda)$.

¹These objects are also sometimes called *highest weights* as they are the highest weights of irreducible representations of the unitary group $U(n)$.

²This justifies the notation “ \mathbb{GT} ” we are using. Tsetlin and Cetlin are different English spellings of the same last name.

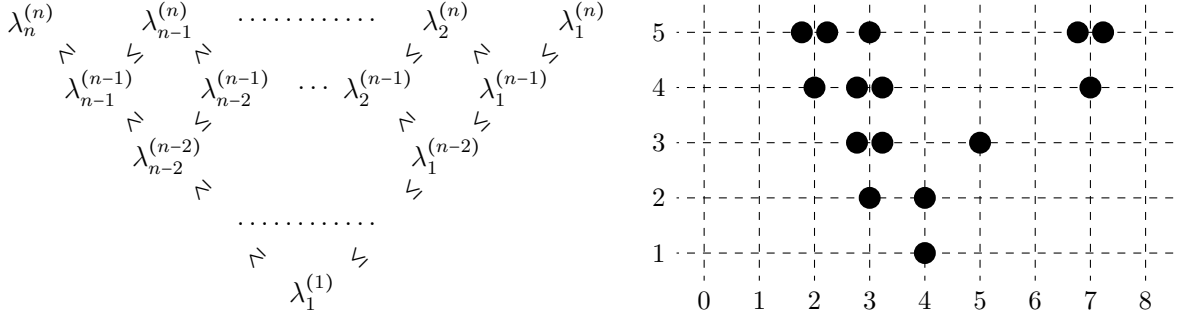

FIGURE 7. Left: An interlacing array λ ; we require that $\lambda_i^{(j)} \in \mathbb{Z}_{\geq 0}$. Right: A configuration of particles corresponding to an interlacing array of depth $n = 5$ (right).

Definition 3.2. A semistandard Young tableau of shape λ is a filling in the boxes of the Young diagram λ with positive integers, which increase weakly along rows, and strictly down columns.

There is a natural correspondence between the Gelfand-Tsetlin arrays of depth n and the semistandard Young tableaux filled with numbers from 1 to n . Indeed, given $\lambda \in \mathbb{GT}^{(n)}$ we can produce a semistandard Young tableau of shape $\lambda^{(n)}$ by filling $\lambda^{(j)}/\lambda^{(j-1)}$ with numbers equal to j , see Fig. 8. Thus, by a slight abuse of notation we will also use $\mathbb{GT}^{(n)}(\lambda)$ to denote the set of semistandard Young tableaux of shape λ filled with numbers from 1 to n .

1	1	1	1	3	4	4
2	2	2	5	5	5	5
3	3	3				
4	4					
5	5					

FIGURE 8. A semistandard Young tableau corresponding to the array on Fig. 7, right.

3.2. Schensted's insertions and interacting particle systems. Schensted's row and column insertions ([Sch61]) are combinatorial constructions serving as the building blocks of the RSK algorithms, see [K70], [F97]. Each insertion can be described in the language of semistandard Young tableaux as a sequence of row and column bumpings. In the language of interlacing arrays these bumpings correspond to elementary operations of deterministic long-range pulling and pushing, which involve only two consecutive levels of an array.

Definition 3.3. (Deterministic long-range pulling, Fig. 9)

Let $j = 2, \dots, n$, and signatures $\bar{\lambda}, \bar{\nu} \in \mathbb{GT}_{j-1}^+$, $\lambda \in \mathbb{GT}_j^+$ satisfy $\bar{\lambda} <_h \lambda$, $\bar{\nu} = \bar{\lambda} + \bar{e}_i$, where $\bar{e}_i = (0, 0, \dots, 0, 1, 0, \dots, 0)$ (for some $i = 1, \dots, j-1$) is the i th basis vector of length $j-1$. Define $\nu \in \mathbb{GT}_j^+$ to be

$$\nu = \text{pull}(\lambda \mid \bar{\lambda} \rightarrow \bar{\nu}) := \begin{cases} \lambda + e_i, & \text{if } \bar{\lambda}_i = \lambda_i; \\ \lambda + e_{i+1}, & \text{otherwise.} \end{cases}$$

Here e_i and e_{i+1} are basis vectors of length j .

In words, the particle $\bar{\lambda}_i$ at level $j-1$ which moved to the right by one generically pulls its upper left neighbor λ_{i+1} , or pushes it upper right neighbor λ_i if the latter operation is needed to

preserve the interlacing. Note that the long-range pulling mechanism does not encounter any blocking issues.

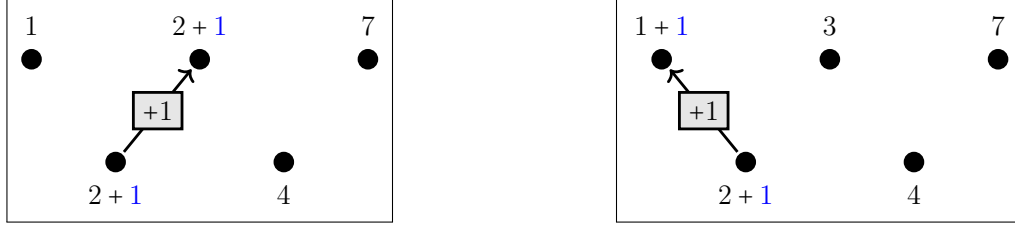

FIGURE 9. An example of pulling mechanism for $i = 2$ at levels 2 and 3 (i.e., $j = 3$). Left: $\bar{\lambda}_2 = \lambda_2$, which forces the pushing of the upper right neighbor. Right: in the generic situation $\bar{\lambda}_2 < \lambda_2$ the upper left neighbor is pulled.

Definition 3.4. (*Deterministic long-range pushing, Fig. 10*) As in the previous definition, let $j = 2, \dots, n$, $\bar{\lambda}, \bar{\nu} \in \mathbb{GT}_{j-1}^+$, $\lambda \in \mathbb{GT}_j^+$ be such that $\bar{\lambda} \prec_h \lambda$ and $\bar{\nu} = \bar{\lambda} + \bar{e}_i$. Define $\nu \in \mathbb{GT}_j^+$ to be

$$\nu = \text{push}(\lambda \mid \bar{\lambda} \rightarrow \bar{\nu}) := \lambda + e_m, \quad \text{where } m = \max\{p : 1 \leq p \leq i \text{ and } \lambda_p < \bar{\lambda}_{p-1}\}.$$

In words, the particle $\bar{\lambda}_i$ at level $j - 1$ which moved to the right by one, pushes its first upper right neighbor λ_m which is not blocked (and therefore is free to move without violating the interlacing). Generically (when all particles are sufficiently far apart) $\lambda_m = \lambda_i$, so the immediate upper right neighbor is pushed.

Remark 3.5 (Move donation). It is useful to equivalently interpret the mechanism of Definition 3.4 in a slightly different way. Namely, let us say that when the particle $\bar{\lambda}_i$ at level $j - 1$ moves, it gives the particle λ_i at level j a *moving impulse*. If λ_i is blocked (i.e., if $\lambda_i = \bar{\lambda}_{i-1}$), this moving impulse is *donated* to the next particle λ_{i-1} to the right of λ_i . If λ_{i-1} is blocked, too, then the impulse is donated further, and so on. Note that the particle λ_1 cannot be blocked, so this moving impulse will always result in an actual move.

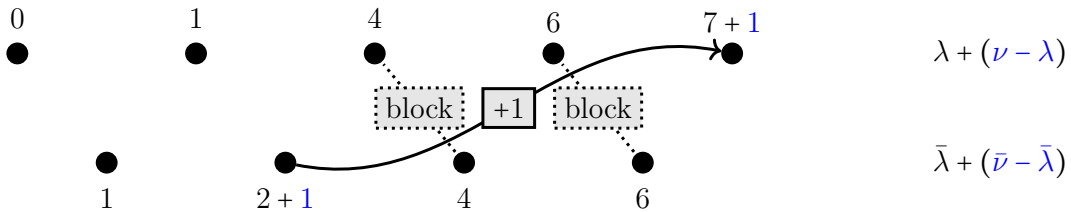

FIGURE 10. An example of pushing mechanism for $i = 3$ at levels 4 and 5 (i.e., $j = 5$). Since the particles $\lambda_3 = \bar{\lambda}_2$ and $\lambda_2 = \bar{\lambda}_1$ are blocked, the first particle which can be pushed is λ_1 .

Definition 3.6. *The Schensted's row insertion is an algorithm that takes a semistandard tableau $\lambda \in \mathbb{GT}^{(n)}$, and an integer $1 \leq x \leq n$, and constructs a new tableau $\lambda \leftarrow x$ according to the following procedure:*

- If x is at least as large as all the entries in the first row of λ , add x in a new box to the end of the first row. In this case the algorithm terminates.
- Otherwise find the leftmost entry y in the first row that is strictly larger than x and replace it by x .

- Repeat the same steps with y and the second row, then with the replaced entry z and the third row, ..., and so on until the replaced entry can be put in the end of the next row, possibly by forming a new row of one entry. Then the algorithm terminates.

In terms of arrays and long-range pulling we can describe this insertion in the following way:

- Levels $\lambda^{(1)}, \dots, \lambda^{(x-1)}$ remain unchanged.
- Rightmost particle on the level x moves by 1 to the right, i.e $\lambda^{(x)} \rightarrow \lambda^{(x)} + \bar{e}_1$.
- Then pull operations are consecutively performed for $j = x + 1, \dots, n$.

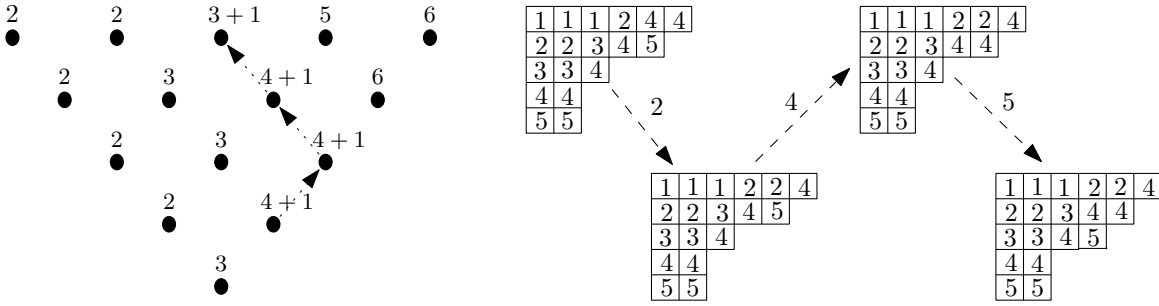

FIGURE 11. An example of Schensted's row insertion in terms of semistandard tableaux and particle arrays for $n = 5$.

In words, this push-pull chain of movements starts on the right edge of the array and progresses upwards until it reaches the top level. This is the same as saying that shape of a tableau is augmented by one cell after row insertion of a single entry. One can also row-insert a word $X = x_1x_2 \dots x_\ell$ in a tableau λ by consecutively inserting its entries one by one:

$$\lambda \leftarrow X := \lambda \leftarrow x_1 \leftarrow x_2 \leftarrow \dots \leftarrow x_\ell$$

Definition 3.7. The Schensted's column insertion is an algorithm that takes a semistandard tableau $\lambda \in \mathbb{GT}^{(n)}$, and an integer $1 \leq x \leq n$, and constructs a new tableau $x \rightarrow \lambda$ according to the following procedure:

- If x is strictly larger than all the entries in the first column of λ , add x in a new box at the bottom of the first column. In this case the algorithm terminates.
- Otherwise find the topmost entry y in the first column that is at least large as x and replace it by x .
- Repeat the same steps with y and the second column, then with the replaced entry z and the third column, ..., and so on until the replaced entry can be put at the bottom of the next column, possibly by forming a column of one entry. Then the algorithm terminates.

In terms of arrays and long-range pushing we can describe this insertion in the following way:

- Levels $\lambda^{(1)}, \dots, \lambda^{(x-1)}$ remain unchanged.
- Leftmost particle on the level x moves by 1 to the right, i.e $\lambda^{(x)} \rightarrow \lambda^{(x)} + \bar{e}_x$.
- Then push operations are consecutively performed for $j = x + 1, \dots, n$.

As in the case of the row insertion, on each of the levels from x -th to N -th precisely one particle moves to the right by 1. The sequence of moves progresses upwards and to the right until it reaches the top level. One can also column-insert a word $X = x_1x_2 \dots x_\ell$ in a tableau λ by consecutively inserting its entries one by one in reverse order:

$$X \rightarrow \lambda := x_1 \rightarrow x_2 \rightarrow \dots \rightarrow x_\ell \rightarrow \lambda$$

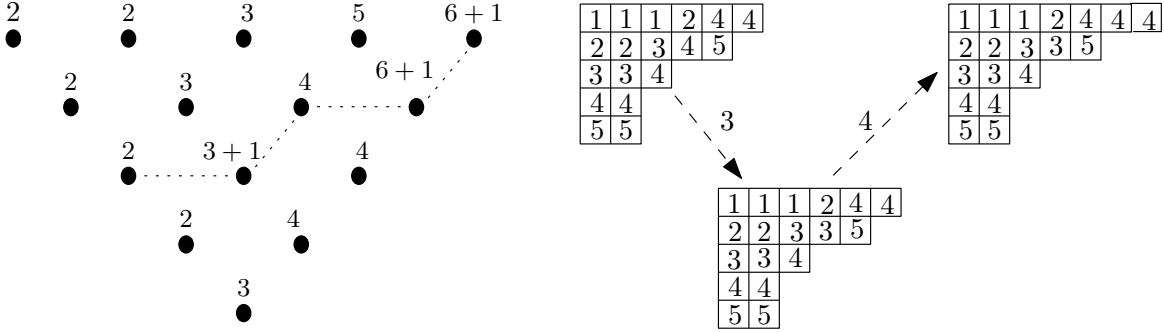

FIGURE 12. An example of Schensted’s column insertion in terms of semistandard tableaux and particle arrays for $n = 5$. Only steps that change the tableau are shown.

3.3. Plactic Algebra. To a semistandard tableau $\lambda \in \mathbb{GT}^{(n)}$ one can associate an element $w(\lambda) \in Pl_n$ represented by a word obtained by reading entry letters of λ first in the bottom row from left to right, then in the second row from the bottom from left to right, and so on. For instance, for a tableau on Fig. 8 the corresponding word will be 55443332255551111344. The following proposition explains basic connections between the plactic monoid and Schensted insertions.

Proposition 3.8. (see [Lot02]).

- (1) For every $a \in Pl_n$ there exists a unique tableau λ , such that $a = w(\lambda)$.
- (2) $w(\lambda \leftarrow x) = w(\lambda)x$.
- (3) $w(x \rightarrow \lambda) = xw(\lambda)$.

Hence consecutively inserting x_1, x_2, \dots, x_r via the Schensted’s row insertion into a tableau λ leads to the the same result as multiplication of $w(\lambda)$ by $X = x_1x_2 \cdots x_r$ on the right, while multiplication of $w(\lambda)$ by X on the left amounts to the same result as consecutively inserting x_r, \dots, x_2, x_1 in λ via the Schensted’s column insertion.

The plactic algebra is noncommutative for $n \geq 2$, but it contains nice families of commuting elements. More precisely, for $\lambda \in \mathbb{GT}_n^+$ and variables a_1, a_2, \dots, a_n define the *plactic Schur polynomial*

$$(3.2) \quad S_\lambda^{Pl}(a_1\mathbf{1}, a_2\mathbf{2}, \dots, a_n\mathbf{n}) := \sum_{\lambda \in \mathbb{GT}^{(n)}(\lambda)} w(\lambda) \cdot a_1^{|\lambda^{(1)}|} a_2^{|\lambda^{(2)}| - |\lambda^{(1)}|} \dots a_n^{|\lambda^{(n)}| - |\lambda^{(n-1)}|}.$$

Proposition 3.9. (see [Lot02]). $S_\lambda(a_1\mathbf{1}, \dots, a_n\mathbf{n})$ and $S_\mu(a_1\mathbf{1}, \dots, a_n\mathbf{n})$ commute for arbitrary λ and μ , and their product can be expressed as

$$(3.3) \quad S_\lambda^{Pl}(a_1\mathbf{1}, \dots, a_n\mathbf{n}) S_\mu^{Pl}(a_1\mathbf{1}, \dots, a_n\mathbf{n}) = \sum_\nu c_{\lambda, \mu}^\nu S_\nu^{Pl}(a_1\mathbf{1}, \dots, a_n\mathbf{n}),$$

where $c_{\lambda, \mu}^\nu$ is the Littlewood-Richardson coefficient, i.e the coefficient of S_ν in the expansion of $S_\lambda S_\mu$ in the basis of Schur functions.

Remark 3.10. A homomorphism from the plactic algebra to Λ_n defined by sending every generator k to 1 sends (3.3) to

$$S_\lambda(a_1, \dots, a_N) S_\mu(a_1, \dots, a_N) = \sum_\nu c_{\lambda, \mu}^\nu S_\nu(a_1, \dots, a_N),$$

which is the defining relation for the Littlewood-Richardson coefficients (for $\ell(\lambda), \ell(\mu), \ell(\nu) \leq n$).

We will now simplify notation by identifying λ with $w(\lambda)$.

3.4. Plactic algebra action continued. We are now ready to continue subsection 1.3 and prove proposition 1.4.

Proof of proposition 1.4. For a tableau λ denote by $\mathcal{S}(\lambda)$ the set of entries of the first column of λ . Extend this function linearly to the whole plactic algebra. It follows from the description of Schensted's insertion that $\mathcal{S}(\tilde{\lambda}\lambda)$ depends on $\tilde{\lambda}$ and $\mathcal{S}(\lambda)$, but not on the whole λ . Identify $S \subseteq \{1, 2, \dots, n\}$ with a one-column tableau with S as the set of entries. Then it follows from the description of Schensted's insertion that $H_r \cdot S = \mathcal{S}(S_{(r)}^{Pl} \cdot S)$. Here $S_{(r)}^{Pl}$ is the corresponding one-row plactic Schur polynomial. Since $S_{(r)}^{Pl}$'s commute with each other, we can apply the Jacobi-Trudi formula to get

$$(3.4) \quad \det [H_{\lambda_i - i + j}]_{i,j=1}^{\ell} \cdot S = S_{\lambda}^{Pl} \cdot S = \sum_{\lambda} a_1^{|\lambda^{(1)}|} a_2^{|\lambda^{(2)}| - |\lambda^{(1)}|} \dots a_n^{|\lambda^{(n)}| - |\lambda^{(n-1)}|} \mathcal{S}(\lambda S)$$

Note that here \cdot denotes plactic algebra action as defined in subsection 1.3, while multiplication in the plactic algebra itself is written without a dot. Equality (3.4) implies positivity in proposition 1.4. \square

Note that for the special case $S = \{1, 2, \dots, n\}$ equality (3.4) becomes equality (1.2).

4. SEARCHING FOR A t -DEFORMATION OF PLACTIC ACTION

4.1. Towards proving theorem 1.6. Proof of proposition 1.4 together with equality (1.3) suggest the following plan to prove theorem 1.6. For a semistandard tableau $\lambda \in \mathbb{GT}^{(n)}$ find a linear operator $T_{\lambda} : V^{\otimes n} \rightarrow V^{\otimes n}$ such that

- (1) $T_{\lambda}^{t=0}(S) = \mathcal{S}(\lambda S)$
- (2) Matrix elements of T_{λ} with respect to basis $\{1, 2\}^{\otimes n}$ are positive for $0 \leq t < 1$.
- (3)

$$(4.1) \quad \Theta(P_{\lambda}) = \sum_{\lambda \text{ of shape } \lambda} \psi_{\lambda}(t) a^{\lambda} T_{\lambda}$$

If we were to find such operators, the positivity in theorem 1.6 would follow, just as proposition 1.2 follows from equality (1.3). For a one-row λ with entries $i_1 \leq i_2 \leq \dots \leq i_r$ we must take the coefficient of $a_{i_1} a_{i_2} \dots a_{i_r}$ in $\frac{1}{1-t} T_r$ in order to satisfy condition (4.1). Similarly, for a one-column λ with entries $i_1 < i_2 < \dots < i_r$ we must take the coefficient of $a_{i_1} a_{i_2} \dots a_{i_r}$ in $\Theta(e_r)$. However, for λ with more rows and columns the choice and existence of T_{λ} are not clear. The idea is think in line with some of the previous works on deformations of RSK algorithms, i.e. [OP13], [MP17], [BM18]. A feature of this algorithms is that at intermediate stages we need to store additional information. This and experimentation suggests that T_{λ} should act by t -inserting columns of λ in the reverse order and preserving information about previous insertions. This idea together with guess and check leads to the following

4.2. Extended vertex models enter the picture. To prove theorem 1.6 we will derive representation of $\Theta(P_{\lambda})$ from which the desired positivity is evident. This is accomplished by introducing the following ("extended") 3-colored vertex model. Let W be a three-dimensional real vector space spanned by elements $0, 1, 2$. Let $i : V \hookrightarrow W$ be the natural inclusion and $\pi : W \rightarrow V$ be a projection defined via $\pi(0) = 1$. These maps, respectively, induce inclusion $i^{\otimes n} : V^{\otimes n} \hookrightarrow W^{\otimes n}$ and projection $\pi^{\otimes n} : W^{\otimes n} \rightarrow V^{\otimes n}$. $W^{\otimes n} = \bigoplus_{k=0}^n W_{n,k}$, where each subspace $W_{n,k}$ is defined as a span of vectors $e_1 \otimes e_2 \otimes \dots \otimes e_n$ with each $e_i \in \{0, 1, 2\}$ and exactly k 0's

among the e_i 's. Let U_2 be an (infinite-dimensional) real vector space of finite formal linear combinations of pairs $\{\{x, y\} \in \mathbb{Z}_{\geq 0}^2\}$. Given two parameters a, t we define an operator $R_{ext} = R_{ext}(a, t) : W \otimes U_2 \rightarrow W \otimes U_2$ by

$$(4.2) \quad \begin{aligned} R_{ext}(0 \otimes \{x, y\}) &= a \cdot 0 \otimes \{x, y\} + (t^y - t^{x+y}) \cdot 1 \otimes \{x-1, y\} + (1 - t^y) \cdot 2 \otimes \{x, y-1\}, \\ R_{ext}(1 \otimes \{x, y\}) &= a \cdot 0 \otimes \{x+1, y\} + t^y \cdot 1 \otimes \{x, y\} + (1 - t^y) \cdot 2 \otimes \{x+1, y-1\}, \\ R_{ext}(2 \otimes \{x, y\}) &= a \cdot 0 \otimes \{x, y+1\} + 2 \otimes \{x, y\}. \end{aligned}$$

R_{ext} gives rise to a vertex model with weights as specified on Fig. 13.

$\begin{array}{c} 0 \\ \\ \{x, y\} \text{---} \{x, y\} \\ \\ 0 \\ a \end{array}$	$\begin{array}{c} 0 \\ \\ \{x, y\} \text{---} \{x+1, y\} \\ \\ 1 \\ a \end{array}$	$\begin{array}{c} 0 \\ \\ \{x, y\} \text{---} \{x, y+1\} \\ \\ 2 \\ a \end{array}$	$\begin{array}{c} 2 \\ \\ \{x, y\} \text{---} \{x, y\} \\ \\ 2 \\ 1 \end{array}$
$\begin{array}{c} 1 \\ \\ \{x, y\} \text{---} \{x, y\} \\ \\ 1 \\ t^y \end{array}$	$\begin{array}{c} 2 \\ \\ \{x, y\} \text{---} \{x+1, y-1\} \\ \\ 1 \\ 1 - t^y \end{array}$	$\begin{array}{c} 2 \\ \\ \{x, y\} \text{---} \{x, y-1\} \\ \\ 0 \\ 1 - t^y \end{array}$	$\begin{array}{c} 1 \\ \\ \{x, y\} \text{---} \{x-1, y\} \\ \\ 0 \\ t^y - t^{x+y} \end{array}$

FIGURE 13. Weights of the vertex model defined via $R_{ext}(a, t)$. All configurations not appearing on this picture are assumed to have weight 0.

Define an operator $H : W^{\otimes n} \rightarrow W^{\otimes n}$ as the inhomogeneous transfer operator of R_{ext} as specified on Fig. 14. Note that there is fixed input $\{0, 0\}$ on the left, while boundary condition on the right is free. H depends on parameters t, a_1, a_2, \dots, a_n . If a pair $\{x, y\} \in \mathbb{Z}_{\geq 0}^2$ appears on the right boundary of the non-zero weight configuration with bottom row $e_1 \otimes e_2 \otimes \dots \otimes e_n$ and top row $e'_1 \otimes e'_2 \otimes \dots \otimes e'_n$, then it is clear from the model that

$$\begin{aligned} x &= \text{number of 1's among the } e_i\text{'s} - \text{number of 1's among the } e'_i\text{'s}; \\ y &= \text{number of 2's among the } e_i\text{'s} - \text{number of 2's among the } e'_i\text{'s}. \end{aligned}$$

As a corollary,

$$\text{number of 0's among the } e'_i\text{'s} - \text{number of 0's among the } e_i\text{'s} = x + y \geq 0.$$

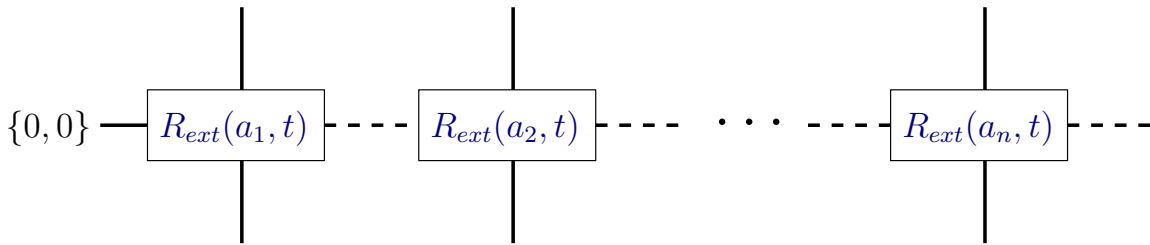

FIGURE 14. H is a transfer operator for the inhomogeneous vertex model defined via R_{ext} . Boundary condition is fixed to be $\{0, 0\}$ on the left and is free on the right.

For $0 \leq k_1, k_2 \leq n$ define an operator $H_{k_1, k_2} : W_{n, k_1} \rightarrow W_{n, k_2}$ via restriction of H . Then $H_{k_1, k_2} = 0$ unless $k_1 \leq k_2$. Then theorem 1.6 would follow from the following

Theorem 4.1. *Let λ be a partition with $\lambda_1 = m$. Then*

$$(4.3) \quad \Theta(P_\lambda) = \pi^{\otimes n} \circ H_{\lambda'_2, \lambda'_1} \circ H_{\lambda'_3, \lambda'_2} \circ \cdots \circ H_{\lambda'_m, \lambda'_{m-1}} \circ H_{0, \lambda'_m} \circ i^{\otimes n}$$

Remark 4.2. Note that although $\Theta(P_\lambda)$ is itself an operator $V^{\otimes n} \rightarrow V^{\otimes n}$, the right hand side of representation (4.3) utilizes a bigger space $W^{\otimes n}$ in its intermediate steps.

5. PROOF OF THE MAIN RESULT

Proof. Hall-Littlewood polynomials (as well as more general Macdonald polynomials) satisfy the Pieri formulas (see [Mac99], pp.340-341):

$$(5.1) \quad P_\lambda g_r = \sum_{\lambda <_h \mu, |\mu| - |\lambda| = r} \phi_{\mu/\lambda}(0, t) P_\mu, \quad P_\lambda e_r = \sum_{\lambda <_v \mu, |\mu| - |\lambda| = r} \psi'_{\mu/\lambda}(0, t) P_\mu.$$

We will adopt the conventions that $\lambda'_m = 0$ for $m > \lambda_1$, $\mu'_m = 0$ for $m > \mu_1$, and $\lambda'_0 = \mu'_0$. The multiplicities $\phi_{\mu/\lambda} = \phi_{\mu/\lambda}(0, t)$ and $\psi'_{\mu/\lambda} = \psi'_{\mu/\lambda}(0, t)$ in (5.1) can be expressed as

$$(5.2) \quad \begin{aligned} \phi_{\mu/\lambda} &= \prod_{i=1}^{\mu_1} \mathbf{1}_{\mu'_i = \lambda'_i + 1, \mu'_{i+1} = \lambda'_{i+1}} \cdot (1 - t^{\mu'_i - \lambda'_{i+1}}) = \\ &= \prod_{i=1}^{\mu_1} \mathbf{1}_{\mu'_i = \lambda'_i + 1} \cdot \left(\mathbf{1}_{\mu'_{i-1} = \lambda'_{i-1}} \cdot (1 - t^{\mu'_i - \lambda'_{i+1}}) + \mathbf{1}_{\mu'_{i-1} = \lambda'_{i-1} + 1} \cdot \left(\frac{1 - t^{\mu'_i - \lambda'_{i+1}}}{1 - t^{\mu'_{i-1} - \lambda'_i}} \right) \right) = \\ &= (1 - t \cdot \mathbf{1}_{\mu_1 > \lambda_1}) \cdot \prod_{i=1}^{\lambda_1} \mathbf{1}_{\mu'_i = \lambda'_i + 1} \cdot \left(\mathbf{1}_{\mu'_{i-1} = \lambda'_{i-1}} \cdot (1 - t^{\mu'_i - \lambda'_{i+1}}) + \mathbf{1}_{\mu'_{i-1} = \lambda'_{i-1} + 1} \cdot \left(\frac{1 - t^{\mu'_i - \lambda'_{i+1}}}{1 - t^{\mu'_{i-1} - \lambda'_i}} \right) \right) \end{aligned}$$

$$(5.3) \quad \psi'_{\mu/\lambda} = \prod_{i=1}^{\lambda_1} \frac{(t; t)_{\mu'_i - \mu'_{i+1}}}{(t; t)_{\mu'_i - \lambda'_i} (t; t)_{\lambda'_i - \mu'_{i+1}}} = \prod_{i=1}^{\lambda_1} \left(\frac{(t; t)_{\mu'_i - \lambda'_{i+1}}}{(t; t)_{\mu'_i - \lambda'_i} (t; t)_{\lambda'_i - \lambda'_{i+1}}} \cdot \frac{(t; t)_{\mu'_{i-1} - \mu'_i} (t; t)_{\lambda'_{i-1} - \lambda'_i}}{(t; t)_{\mu'_{i-1} - \lambda'_i} (t; t)_{\lambda'_{i-1} - \mu'_i}} \right)$$

Denote by Π_λ the right hand side of (4.3). To prove theorem 4.1 we need to show that $\Pi(P_\lambda) = \Pi_\lambda$ for any partition λ . It is enough to prove that for any partition λ we have

$$(5.4) \quad T(\alpha) \Pi_\lambda = \left(\prod_{i=1}^n \frac{1 - \alpha a_i}{1 - t \alpha a_i} \right) \sum_{\lambda <_h \mu} \alpha^{|\mu| - |\lambda|} \phi_{\mu/\lambda} \Pi_\mu.$$

Indeed, suppose we know that relation 5.4 holds. Multiply both sides of this relation by $\prod_{i=1}^n \frac{1 - t \alpha a_i}{1 - \alpha a_i}$, then take coefficient of α^r to get

$$(5.5) \quad T_r \Pi_\lambda = \sum_{\lambda <_h \mu, |\mu| - |\lambda| = r} \phi_{\mu/\lambda} \Pi_\mu \quad \text{for any } r \in \mathbb{Z}_{\geq 0}.$$

On the other hand, it follows from the definition of $\Theta(P_\lambda)$ that

$$(5.6) \quad T_r \Theta(P_\lambda) = \sum_{\lambda <_h \mu, |\mu| - |\lambda| = r} \phi_{\mu/\lambda} \Theta(P_\mu) \quad \text{for any } r \in \mathbb{Z}_{\geq 0}.$$

We can now show that $\Theta(P_\lambda) = \Pi_\lambda$ by induction on $(\lambda'_1, \lambda_{-1})$. Base for $(0, 0)$ is clear: $H_{k, k}(v) = v$ for any $v \in \langle 1, 2 \rangle^{\otimes n}$, hence $\Pi_\emptyset = Id = \Theta(P_\emptyset)$. Suppose the equality $\Theta(P_\lambda) = \Pi_\lambda$ has been established for all λ with either $\lambda'_1 < \nu'_1$ or both $\lambda'_1 = \nu'_1$ and $\lambda_{-1} < \nu_{-1}$. We would like to also establish it for ν . Let χ be the partition obtained from ν by deleting its last nonzero row. Then by (5.5) and the inductive assumption we get

$$\begin{aligned} \Theta(P_\nu) &= \frac{1}{\phi_{\nu/\chi}} \left(T_{\nu-1} \Theta(P_\chi) - \sum_{\chi < \mathfrak{h}\lambda, |\lambda| - |\chi| = \nu-1, \lambda \neq \nu} \phi_{\lambda/\chi} \Theta(P_\lambda) \right) = \\ &= \frac{1}{\phi_{\nu/\chi}} \left(T_{\nu-1} \Pi_\chi - \sum_{\chi < \mathfrak{h}\lambda, |\lambda| - |\chi| = \nu-1, \lambda \neq \nu} \phi_{\lambda/\chi} \Pi_\lambda \right) = \Pi_\nu. \end{aligned}$$

So it remains to establish (5.4). Consider a stochastic vertex model $R_3(a, t)$ with weights as depicted on Fig. 15.

$\begin{array}{c} 2 \\ \text{---} \text{---} \\ \\ \text{---} \\ 2 \end{array}$	$\begin{array}{c} 2 \\ \text{---} \text{---} \\ \\ \text{---} \\ 2 \end{array}$	$\begin{array}{c} 1 \\ \text{---} \text{---} \\ \\ \text{---} \\ 2 \end{array}$	$\begin{array}{c} 2 \\ \text{---} \text{---} \\ \\ \text{---} \\ 1 \end{array}$	$\begin{array}{c} 1 \\ \text{---} \text{---} \\ \\ \text{---} \\ 2 \end{array}$
1	$\frac{1-\alpha}{1-t\alpha}$	$\frac{(1-t)\alpha}{1-t\alpha}$	$\frac{1-t}{1-t\alpha}$	$\frac{t(1-\alpha)}{1-t\alpha}$
$\begin{array}{c} 1 \\ \text{---} \text{---} \\ \\ \text{---} \\ 1 \end{array}$	$\begin{array}{c} 2 \\ \text{---} \text{---} \\ \\ \text{---} \\ 2 \end{array}$	$\begin{array}{c} 0 \\ \vdots \\ \text{---} \text{---} \\ \\ \text{---} \\ 2 \end{array}$	$\begin{array}{c} 2 \\ \text{---} \text{---} \\ \\ \text{---} \\ 0 \end{array}$	$\begin{array}{c} 0 \\ \vdots \\ \text{---} \text{---} \\ \\ \text{---} \\ 2 \end{array}$
1	$\frac{1-\alpha}{1-t\alpha}$	$\frac{(1-t)\alpha}{1-t\alpha}$	$\frac{1-t}{1-t\alpha}$	$\frac{t(1-\alpha)}{1-t\alpha}$
$\begin{array}{c} 0 \\ \vdots \\ \text{---} \text{---} \\ \\ \text{---} \\ 0 \end{array}$	$\begin{array}{c} 1 \\ \text{---} \text{---} \\ \\ \text{---} \\ 0 \end{array}$	$\begin{array}{c} 0 \\ \vdots \\ \text{---} \text{---} \\ \\ \text{---} \\ 1 \end{array}$	$\begin{array}{c} 1 \\ \text{---} \text{---} \\ \\ \text{---} \\ 0 \end{array}$	$\begin{array}{c} 0 \\ \vdots \\ \text{---} \text{---} \\ \\ \text{---} \\ 1 \end{array}$
1	$\frac{1-\alpha}{1-t\alpha}$	$\frac{(1-t)\alpha}{1-t\alpha}$	$\frac{1-t}{1-t\alpha}$	$\frac{t(1-\alpha)}{1-t\alpha}$

FIGURE 15. Stochastic vertex model with weights given by $R_3(a, t)$. Fat lines correspond to 2's, normal lines correspond to 1's, dotted lines correspond to 0's.

Denote by \mathcal{A}_k the inhomogeneous transfer operator $W_{n,k} \rightarrow W_{n,k}$ of R_3 with both left and right boundary conditions fixed to be 0 (as specified on top of Fig. 16). Denote by \mathcal{B}_k the inhomogeneous transfer operator $W_{n,k} \rightarrow W_{n,k+1}$ of R_3 with the left boundary condition fixed to be 0 and the right boundary condition being 1 or 2 (as specified on bottom Fig. 16).

Lemma 5.1. *For $0 \leq k_1 \leq k_2 \leq n$ we have*

$$(5.7) \quad \mathcal{A}_{k_2} H_{k_1, k_2} = H_{k_1, k_2} \mathcal{A}_{k_1} + H_{k_1+1, k_2} \mathcal{B}_{k_1};$$

$$(5.8) \quad \mathcal{B}_{k_2} H_{k_1, k_2} = \alpha (1 - t^{k_2 - k_1 + 1}) H_{k_1, k_2+1} \mathcal{A}_{k_1} + \alpha H_{k_1+1, k_2+1} \mathcal{B}_{k_1}.$$

Proof of lemma 5.1. To prove relations (5.7) and (5.8) we will utilize a Yang-Baxter type equation relating R_3 , R_{ext} and another (auxiliary) vertex model $R_{aux}(t) : U_2 \otimes \langle 0, 1, 2 \rangle \rightarrow U_2 \otimes \langle 0, 1, 2 \rangle$ with weights as specified on Fig. 17. The Yang-Baxter type equation we need is an equality of operators $\langle 0, 1, 2 \rangle \otimes U_2 \otimes \langle 0, 1, 2 \rangle \rightarrow \langle 0, 1, 2 \rangle \otimes U_2 \otimes \langle 0, 1, 2 \rangle$ as specified on Fig. 18.

Note that $R_{aux}((0, 0) \otimes 0) = (0, 0) \otimes 0$ and for any $(x, y) \in \mathbb{Z}_{\geq 0}^2$ we have

$$(5.9) \quad \begin{aligned} &R_{aux}((x, y), 0, (x, y), 0) + R_{aux}((x, y), 0, (x-1, y), 1) + R_{aux}((x, y), 0, (x, y-1), 2) = 1, \\ &R_{aux}((x-1, y), 1, (x, y), 0) + R_{aux}((x-1, y), 1, (x-1, y), 1) + R_{aux}((x-1, y), 1, (x, y-1), 2) = 0, \\ &R_{aux}((x, y-1), 2, (x, y), 0) + R_{aux}((x, y-1), 2, (x-1, y), 1) + R_{aux}((x, y-1), 2, (x, y-1), 2) = 0. \end{aligned}$$

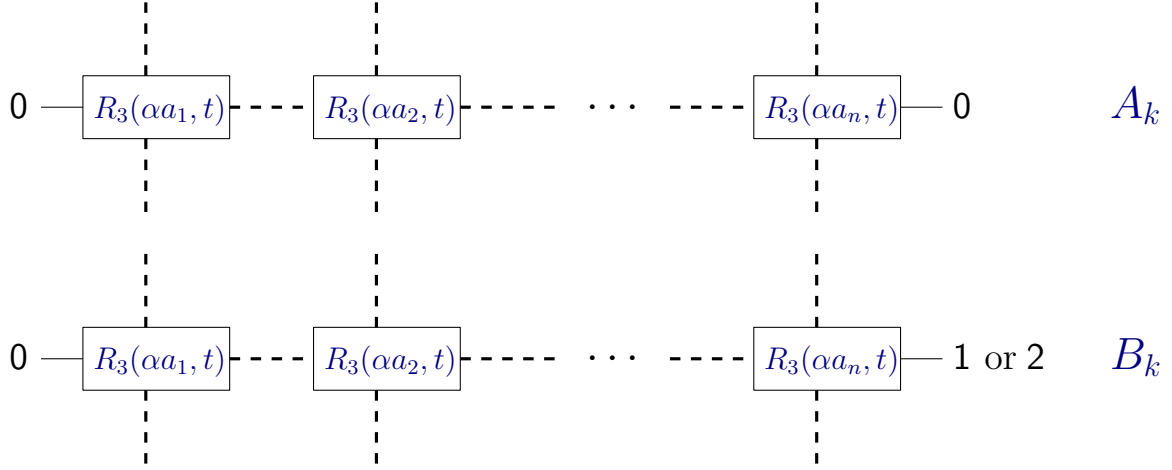

FIGURE 16. Top: Transfer operator \mathcal{A}_k . Bottom: Transfer operator \mathcal{B}_k .

$\begin{array}{c} \{x, y\} \\ 0 \text{ --- } \text{ --- } 0 \\ \{x, y\} \\ t^{-x-y} \end{array}$	$\begin{array}{c} \{x-1, y\} \\ 0 \text{ --- } \text{ --- } 1 \\ \{x, y\} \\ t^{-y} - t^{-x-y} \end{array}$	$\begin{array}{c} \{x, y-1\} \\ 0 \text{ --- } \text{ --- } 2 \\ \{x, y\} \\ 1 - t^{-y} \end{array}$
$\begin{array}{c} \{x+1, y\} \\ 1 \text{ --- } \text{ --- } 0 \\ \{x, y\} \\ -t^{-x-y-1} \end{array}$	$\begin{array}{c} \{x, y\} \\ 1 \text{ --- } \text{ --- } 1 \\ \{x, y\} \\ t^{-x-y-1} \end{array}$	$\begin{array}{c} \{x+1, y-1\} \\ 1 \text{ --- } \text{ --- } 2 \\ \{x, y\} \\ 0 \end{array}$
$\begin{array}{c} \{x, y+1\} \\ 2 \text{ --- } \text{ --- } 0 \\ \{x, y\} \\ -t^{-x-y-1} \end{array}$	$\begin{array}{c} \{x-1, y+1\} \\ 2 \text{ --- } \text{ --- } 1 \\ \{x, y\} \\ t^{-x-y-1} - t^{-y-1} \end{array}$	$\begin{array}{c} \{x, y\} \\ 2 \text{ --- } \text{ --- } 2 \\ \{x, y\} \\ t^{-y-1} \end{array}$

FIGURE 17. Weights of the vertex model defined via $R_{aux}(t)$. All configurations not appearing on this picture are assumed to have weight 0.

Multiply both sides of (5.7) by α^{k_2} . Then this equality becomes a corollary of a repeated application of the Yang-Baxter type equation from Fig. 18 together with (5.9). More precisely, see the chain of equalities (5.10)

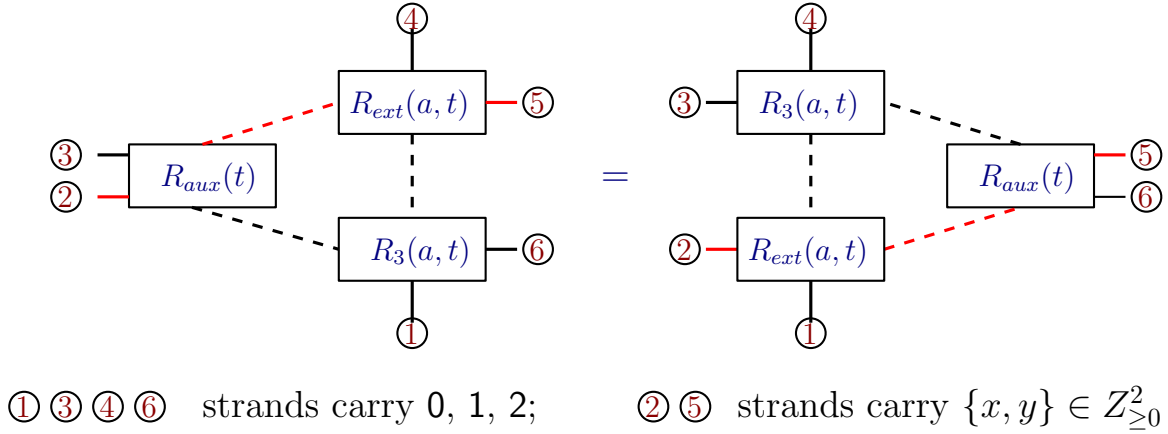

FIGURE 18. Yang-Baxter type equation for operators R_3, R_{ext}, R_{aux} .

(5.10)

$\{0, 0\}$ — $R_{ext}(\alpha a_1, t)$ — \dots — $R_{ext}(\alpha a_n, t)$ — $\{x, y\}/\{x-1, y\}/\{x, y-1\}$
 0 — $R_3(\alpha a_1, t)$ — \dots — $R_3(\alpha a_n, t)$ — $0/1/2$

0 — $R_{aux}(t)$ — \dots — $R_{ext}(\alpha a_1, t)$ — \dots — $R_{ext}(\alpha a_n, t)$ — $\{x, y\}/\{x-1, y\}/\{x, y-1\}$
 $\{0, 0\}$ — $R_3(\alpha a_1, t)$ — \dots — $R_3(\alpha a_n, t)$ — $0/1/2$

0 — $R_3(\alpha a_1, t)$ — \dots — $R_3(\alpha a_n, t)$ — $\{x, y\}/\{x-1, y\}/\{x, y-1\}$
 $\{0, 0\}$ — $R_{ext}(\alpha a_1, t)$ — \dots — $R_{ext}(\alpha a_n, t)$ — $0/1/2$

0 — $R_3(\alpha a_1, t)$ — \dots — $R_3(\alpha a_n, t)$ — 0
 $\{0, 0\}$ — $R_{ext}(\alpha a_1, t)$ — \dots — $R_{ext}(\alpha a_n, t)$ — $\{x, y\}$

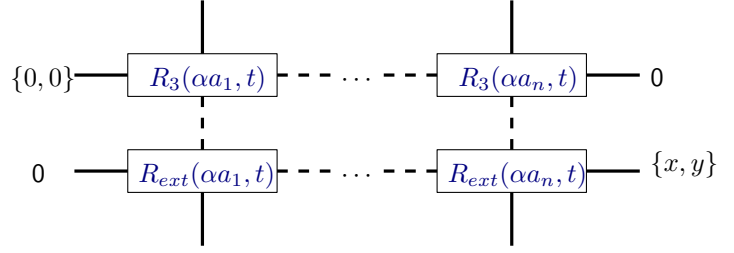

Note that for any $(x, y) \in \mathbb{Z}_{\geq 0}^2$ we have

$$\begin{aligned}
 (5.11) \quad & R_{aux}((x, y), 0, (x, y), 0) \cdot (1 - t^{x+y}) + R_{aux}((x, y), 0, (x-1, y), 1) + R_{aux}((x, y), 0, (x, y-1), 2) = 0, \\
 & R_{aux}((x-1, y), 1, (x, y), 0) \cdot (1 - t^{x+y}) + R_{aux}((x-1, y), 1, (x-1, y), 1) + \\
 & \quad + R_{aux}((x-1, y), 1, (x, y-1), 2) = 1, \\
 & R_{aux}((x, y-1), 2, (x, y), 0) \cdot (1 - t^{x+y}) + R_{aux}((x, y-1), 2, (x-1, y), 1) + \\
 & \quad + R_{aux}((x, y-1), 2, (x, y-1), 2) = 1.
 \end{aligned}$$

Multiply both sides of (5.8) by α^{k_2} . Then this equality becomes a corollary of a repeated application of the Yang-Baxter type equation from Fig. 18 together with (5.11). More precisely, see the chain of equalities (5.12)

$$\begin{aligned}
 (5.12) \quad & \begin{array}{c} \{0,0\} \text{---} R_{ext}(\alpha a_1, t) \text{---} \dots \text{---} R_{ext}(\alpha a_n, t) \text{---} \{x, y\} \\ \vdots \\ 0 \text{---} R_3(\alpha a_1, t) \text{---} \dots \text{---} R_3(\alpha a_n, t) \text{---} 0 \end{array} + \\
 & \begin{array}{c} \{0,0\} \text{---} R_{ext}(\alpha a_1, t) \text{---} \dots \text{---} R_{ext}(\alpha a_n, t) \text{---} \{x-1, y\} / \{x, y-1\} \\ \vdots \\ 0 \text{---} R_3(\alpha a_1, t) \text{---} \dots \text{---} R_3(\alpha a_n, t) \text{---} 1/2 \end{array} = \\
 & \begin{array}{c} 0 \text{---} R_{aux}(t) \text{---} \{0,0\} \\ \vdots \\ \{0,0\} \text{---} R_{aux}(t) \text{---} 0 \end{array} \begin{array}{c} R_{ext}(\alpha a_1, t) \text{---} \dots \text{---} R_{ext}(\alpha a_n, t) \text{---} \{x, y\} \\ \vdots \\ R_3(\alpha a_1, t) \text{---} \dots \text{---} R_3(\alpha a_n, t) \text{---} 0 \end{array} +
 \end{aligned}$$

=

+

=

□

It remains to show that (5.4) can be proved for any given λ using Lemma 5.1. Consider the operator $(\mathcal{A}_{\lambda'_1} + \mathcal{B}_{\lambda'_1}) \circ H_{\lambda'_2, \lambda'_1} \circ \cdots \circ H_{\lambda'_{-1}, \lambda'_{-2}} \circ H_{0, \lambda'_{-1}}$ and repeatedly use the commutation relations (5.7) and (5.8) to move \mathcal{A} 's and \mathcal{B} 's through all the H 's. Note that (5.7) for $k_1 = k_2 = k$ becomes $\mathcal{A}_k H_{k,k} = H_{k,k} \mathcal{A}_k$. Then the resulting sum is

$$(5.13) \quad \sum_{\mu: \lambda \prec_h \mu, \mu_1 = \lambda_1} \left(\left[\alpha^{|\mu| - |\lambda|} \prod_{1 \leq i \leq \lambda_1: \mu'_i = \lambda'_i + 1, \mu'_{i+1} = \lambda'_{i+1}} (1 - t^{\mu'_i - \lambda'_{i+1}}) \right] H_{\mu'_2, \mu'_1} \circ \cdots \circ H_{\mu'_{-1}, \mu'_{-2}} \circ H_{0, \mu'_{-1}} \circ \mathcal{A}_0 \right. \\ \left. + \left[\alpha^{|\mu| - |\lambda|} \prod_{1 \leq i \leq \lambda_1 - 1: \mu'_i = \lambda'_i + 1, \mu'_{i+1} = \lambda'_{i+1}} (1 - t^{\mu'_i - \lambda'_{i+1}}) \right] H_{\mu'_2, \mu'_1} \circ \cdots \circ H_{\mu'_{-1}, \mu'_{-2}} \circ H_{1, \mu'_{-1}} \circ \mathcal{B}_0 \right).$$

Note that $\mathcal{A}_0 = \left(\prod_{i=1}^n \frac{1 - \alpha a_i}{1 - t \alpha a_i} \right) Id$. Substitute $k_1 = k_2 = 0$ in (5.8) to get

$$\mathcal{B}_0 H_{0,0} = \alpha(1-t) H_{0,1} \mathcal{A}_0 + \alpha H_{1,1} \mathcal{B}_0.$$

$H_{0,0} = Id$, so

$$\mathcal{B}_0 = \alpha(1-t) \left(\prod_{i=1}^n \frac{1-\alpha a_i}{1-t\alpha a_i} \right) (Id - \alpha H_{1,1})^{-1} H_{0,1} = (1-t) \left(\prod_{i=1}^n \frac{1-\alpha a_i}{1-t\alpha a_i} \right) \sum_{k=1}^{\infty} \alpha^k H_{1,1}^{k-1} H_{0,1}.$$

Substituting this equality in (5.13) gives us

$$(5.14) \quad (\mathcal{A}_{\lambda'_1} + \mathcal{B}_{\lambda'_1}) H_{\lambda'_1, \lambda'_2} \circ \cdots \circ H_{\lambda'_{-2}, \lambda'_{-1}} \circ H_{\lambda'_{-1}, 0} \\ = \left(\prod_{i=1}^n \frac{1-\alpha a_i}{1-t\alpha a_i} \right) \sum_{\lambda \prec_{\text{h}\mu}} \alpha^{|\mu| - |\lambda|} \phi_{\mu/\lambda} H_{\mu'_2, \mu'_1} \circ \cdots \circ H_{\mu'_{-1}, \mu'_{-2}} \circ H_{0, \mu'_{-1}}.$$

Finally, note that $T(\alpha)\pi^{\otimes n} = \pi^{\otimes n}(\mathcal{A}_{\lambda'_1} + \mathcal{B}_{\lambda'_1})$ as operators $W_{n, \lambda'_1} \rightarrow W_{n, 0}$. Together with (5.14) this implies (5.4). □

REFERENCES

- [ASW52] M. Aissen, I.J. Schoenberg, A.M. Whitney, *On the generating functions of totally positive sequences I*, J. Anal. Math. (1952) 2: 88, 93-103.
- [BC14] A. Borodin, I. Corwin, *Macdonald Processes*, Probability Theory and Related Fields, 158, no. 1-2 (2014), 225-400.
- [BBW16] A. Borodin, A. Bufetov, M. Wheeler, *Between the stochastic six vertex model and Hall-Littlewood processes*, arXiv:1611.09486 [math.PR]
- [BM18] A. Bufetov, K. Matveev, *Hall-Littlewood RSK field*, Selecta Math. (N.S.) 24 (2018), no. 5, 4839-4884.
- [BO17] A. Borodin, G. Olshanski, *Representations of the infinite symmetric group*, Cambridge Studies in Advanced Mathematics, 160. Cambridge University Press, Cambridge, 2017.
- [Edr52] A. Edrei, *On the generating functions of totally positive sequences II*, J. Anal. Math. (1952) 2: 88, 104-109.
- [F97] W. Fulton, *Young Tableaux*, London Mathematical Society Student Texts, vol. 35, Cambridge University Press, 1997.
- [GC50] I. Gelfand, M. Cetlin *Finite-dimensional representations of the group of unimodular matrices*, Doklady Akad. Nauk SSSR (N.S.) 71, (1950). 825-828.
- [H59] P. Hall, *The algebra of partitions*, Proc. 4th Canadian Math. Congress (1959), 147-159.
- [Ker92] S.V. Kerov, *Generalized Hall-Littlewood symmetric functions and orthogonal polynomials*, in *Representation theory and dynamical systems*, 67-94, Adv. Soviet Math., 9, Amer. Math. Soc., Providence, RI, 1992.
- [Ker03] S.V. Kerov, *Asymptotic representation theory of the symmetric group and its applications in analysis*, vol. 219, AMS, Translations of Mathematical Monographs, 2003.
- [K70] Donald Knuth, *Permutations, matrices, and generalized young tableaux*, Pacific J. Math. **34** (1970), no. 3, 709-727.
- [Las06] M. Lassalle, *A short proof of generalized Jacobi-Trudi expansions for Macdonald polynomials*, Jack, Hall-Littlewood and Macdonald polynomials (2006), Contemp. Math., 417, Amer. Math. Soc., Providence, RI, 271-280.
- [L61] D. E. Littlewood, *On certain symmetric functions*, Proc. London Math. Soc. (3) 11 (1961), 485-498.
- [Lot02] M. Lothaire, *The Plactic Monoid, in Algebraic Combinatorics on Words*, Cambridge University Press, 2002.
- [Mac99] I. G. Macdonald, *Symmetric functions and Hall polynomials*, Second Edition. Oxford University Press, 1999.
- [M19] K. Matveev, *Macdonald-positive specializations of the algebra of symmetric functions: proof of the Kerov conjecture*, Ann. of Math. (2) 189 (2019), no. 1, 277-316.
- [MP17] K. Matveev, L. Petrov, *q-randomized Robinson-Schensted-Knuth correspondences and random polymers*, Ann. Inst. Henri Poincaré D 4 (2017), no. 1, 1-123.
- [OP13] N. O'Connell, Y. Pei, *A q-weighted version of the Robinson-Schensted algorithm*, Electron. J. Probab. 18 (2013), no. 95, 25 pp.
- [Sch61] C. Schensted, *Longest increasing and decreasing subsequences*, Canad. J. Math. **13** (1961), 179-191.

- [Sch48] I.J. Schoenberg, *Some analytical aspects of the problem of smoothing*, Courant Anniversary Volume, New York, 1948.
- [Th64] E. Thoma, *Die unzerlegbaren, positiv-definiten Klassenfunktionen der abzählbar unendlichen, symmetrischen Gruppe*, Math. Z. 85 (1964), 40-61.
- [Whit52] A.M. Whitney, *A reduction theorem for totally positive matrices*, J. Anal. Math. (1952) 2: 88, 88-92.
- [ZJ20] P. Zinn-Justin, *Honeycombs for Hall polynomials*, Electron. J. Combin. 27 (2020), no. 2, Paper No. 2.23, 31 pp.

(Konstantin Matveev) DEPARTMENT OF MATHEMATICS, RUTGERS UNIVERSITY, NEW BRUNSWICK, NJ, USA. E-MAIL: KOSMATVEEV@GMAIL.COM