

Deconstructing the Calculus of Relations with Tape Diagrams

FILIPPO BONCHI, University of Pisa, Italy

ALESSANDRO DI GIORGIO, University of Pisa, Italy

ALESSIO SANTAMARIA, University of Pisa, Italy and University of Sussex, United Kingdom

Rig categories with finite biproducts are categories with two monoidal products, where one is a biproduct and the other distributes over it. In this work we present tape diagrams, a sound and complete diagrammatic language for these categories, that can be intuitively thought as string diagrams of string diagrams. We test the effectiveness of our approach against the positive fragment of Tarski's calculus of relations.

CCS Concepts: • **Theory of computation** → **Logic; Categorical semantics**.

Additional Key Words and Phrases: calculus of relations, rig categories, string diagrams

1 INTRODUCTION

Diagrammatic notations have been used in computer science since its early stages. A famous example is the proof of the structured program theorem [8] by Böhm and Jacopini: they rely on a syntax of flow diagrams and, by means of several transformations preserving the semantics, prove the existence of a normal form. In physics, diagrams by Feynman [40] and Penrose [50] became essential linguistic tools: on the one hand they provide intuitive visualisations for otherwise arcane formulas; on the other, they allow a critical simplification of calculations, pretty much like adding two Hindu-Arabic numerals is far easier than two Roman ones [26].

In general, well-behaved diagrammatic languages share some desirable features: (a) diagrams can be composed, like one composes formulas in mathematics, programs in a programming language or sentences in English; (b) they are equipped with a compositional semantics: the meaning of a compound diagram is given by the meaning of its components; (c) some basic laws allow us to transform diagrams into semantically equivalent ones, like the laws of arithmetic allow safe manipulation of expressions.

Motivated by the interest in dealing with diagrammatic languages that enjoy such features, a growing number of works [4, 11, 12, 15, 21, 27, 28, 31, 49, 51] exploits *string diagrams* [39, 56], a graphical notation that emerged in the field of category theory. Formally, string diagrams are arrows of a strict symmetric monoidal category freely generated by a *monoidal signature*. A symbol s in the signature is represented as a box \boxed{s} , and arbitrary string diagrams are depicted by composing horizontally ($:$) and vertically (\otimes) such symbols (plus some wiring technology that we are going to ignore in this introduction). The following is our first example of a string diagram:

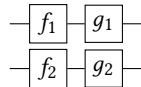

Observe that it can be regarded as both $(f_1; g_1) \otimes (f_2; g_2)$ and $(f_1 \otimes f_2); (g_1 \otimes g_2)$. This ambiguity is not an issue, since in any monoidal category the law $(f_1; g_1) \otimes (f_2; g_2) = (f_1 \otimes f_2); (g_1 \otimes g_2)$ holds for all arrows f_1, f_2, g_1, g_2 . More generally, the main result in [39] states that the diagrammatic representation identifies exactly *all and only* the laws of strict monoidal categories. This is the key feature of string diagrams. Indeed, by virtue of this fact, one can safely exploit diagrams to make proofs, which in this way often amount to suggestive manipulations of diagrams.

By carefully crafting the monoidal signature, hereafter denoted as Σ , one obtains the syntaxes of several languages specifying a large variety of systems: quantum processes [22], linear dynamical systems [15], Petri nets [12], concurrent connectors [17], digital circuits [31], automata [51], or conjunctive queries [14]. In these approaches, the semantics are defined by monoidal functors

$$C_\Sigma \xrightarrow{\llbracket \cdot \rrbracket} \mathbf{D} \quad (1)$$

going from the category of string diagrams C_Σ to some monoidal category \mathbf{D} representing the semantic domain. Since $\llbracket \cdot \rrbracket$ is a monoidal functor, it preserves $;$ and \otimes , and thus the semantics is guaranteed to be *compositional*. Typically, the languages come with a set of axioms, namely equalities or inequalities between string diagrams, that are sound with respect to the semantics interpretation. Interestingly, the *same* algebraic structures seem to appear in many different contexts, e.g. commutative monoids and comonoids, Frobenius algebras, bialgebras, etc.

However, in several occasions the string diagrammatic syntax seems to be too restrictive. For instance, in the context of the ZX-calculus [20, 22], a well known quantum diagrammatic language, several works [59, 61, 63] make use of a mixture of diagrammatic and algebraic syntax to represent, for example, addition of diagrams. Similarly, in [9] \sqcup -props have been introduced in order to enrich string diagrams with a join operation. Sometimes, the structure of monoidal category is not enough and one needs to depict arrows of *rig categories* [38, 44], roughly categories equipped with two monoidal products: \otimes and \oplus . In these cases, the authors often introduce novel kinds of diagrams [25, 37, 58] to convey the intuition to the reader, but without a soundness and completeness theorem like in the aforementioned [39] for string diagrams. The main challenge in depicting arrows of a rig category is given by the possibility of composing them not only with $;$ (horizontally) and \otimes (vertically), but also with the novel monoidal product \oplus . The natural solution consists in exploiting 3 dimensions. This is the approach taken by *sheet diagrams* [24], certain topological manifolds that, modulo a notion of isotopy, capture exactly the laws of rig categories.

In this paper, we introduce *tape diagrams* as a way to depict arrows not of arbitrary rig categories but only of those where \oplus is a *biproduct* [23, 46]. The payoff of this restriction in expressiveness is a better usability: tape diagrams are two dimensional pictures and for this reason they are, in our opinion, more intuitive and more easily drawable than three dimensional diagrams. A second important novelty is that we do not need to define ad-hoc topological structures and transformations, since tape diagrams are, literally, *string diagrams of string diagrams*.

Our main result, Theorem 5.11, is analogous to the one of [39]: it states that the category of tape diagrams, hereafter referred to as T_Σ , is the rig category with finite biproducts freely generated by a *monoidal signature*. Another result, Theorem 4.9, states that for finite biproduct rig categories considering only monoidal signatures, rather than the more general *rig signatures*, does not affect the expressivity, in the sense that for every rig signature Σ one can find a monoidal signature Σ_M such that the finite biproduct rig category generated by Σ is isomorphic to the one generated by Σ_M . So, Theorems 5.11 and 4.9 together allow us to state that tape diagrams form a universal diagrammatic language for rig categories with finite biproducts (see Remark 5.16).

A useful consequence of Theorem 5.11 is Corollary 5.12, which states that whenever the semantic domain \mathbf{D} of a string diagrammatic language as in (1) carries the structure of a finite biproduct rig category, the semantics map $\llbracket \cdot \rrbracket$ can be extended to tape diagrams as follows.

$$\begin{array}{ccc} C_\Sigma & \xrightarrow{\llbracket \cdot \rrbracket} & \mathbf{D} \\ \downarrow & \nearrow & \\ T_\Sigma & & \llbracket \cdot \rrbracket^\# \end{array}$$

In Example 5.13, we quickly show that applying the above construction to the ZX-calculus [20], one can easily express through a tape diagram a quantum Controlled Unitary gate. In Example 6.13, we show that, with the help of four “adjointness” axioms (in Figure 2), \sqcup -props from [9] can be comfortably translated into tape diagrams so to obtain a purely graphical calculus that avoids the use of algebraic operators. Finally, by taping the calculus of graphical conjunctive queries from [14], one obtains a complete axiomatisation for the calculus of relations by Tarski [60]. This is our main application, which we will illustrate in the next section.

Structure of the paper. In Section 3 we recall string diagrams and monoidal categories. In particular, we show that \mathbf{Rel} , the category of sets and relations, carries two monoidal structures satisfying distinct algebraic properties: $(\mathbf{Rel}, \oplus, 0)$ is a finite biproduct (fb) category, while $(\mathbf{Rel}, \otimes, 1)$ is a cartesian bicategory (cb). In Section 4 we recall rig categories and we introduce a novel (to the best of our knowledge) notion of strictness that is useful to simplify the presentation. We also illustrate rig signatures, finite biproduct rig categories and Theorem 4.9.

In Section 5 we introduce tape diagrams and we prove Theorem 5.11. The key step of its proof consists in showing that tapes form a rig category (Theorem 5.10): this is carefully done by inductively defining left and right whiskerings (Definition 5.7) that enjoy beautiful algebraic properties (Table 5). Differently from \oplus , the representation of the product \otimes of two tapes involves some computations. However, a further result, Theorem 5.15, allows us to avoid this issue: in diagrammatic proofs one can safely forget about \otimes of tapes.

In Section 6 we investigate the matrix calculus for T_Σ that is provided by its finite biproduct structure. Corollary 6.6 characterises tape diagrams as matrices of multisets of string diagrams. Interestingly enough \oplus of tapes corresponds to direct sum of matrices, while \otimes to their Kronecker product. Such correspondence is then extended to a poset enriched setting: the category of tapes resulting from the four aforementioned adjointness axioms is isomorphic to matrices of downsets of string diagrams (Theorem 6.9). From this follows a characterisation of the induced poset (Corollary 6.10) that is fundamental for the completeness result in Section 7: Theorem 7.5.

This result is analogous to Theorem 2.2 in [57] stating that finite dimensional Hilbert spaces are complete for dagger compact closed categories. Theorem 7.5 shows that \mathbf{Rel} is complete for *fb-cb rig categories* (Definition 7.1), namely rig categories where \otimes forms a cartesian bicategory and \oplus a finite biproduct category enjoying the aforementioned adjointness axioms. From the completeness theorem, one can easily show (Corollary 7.8) that the laws of fb-cb categories provide a sound and complete axiomatisation for the positive fragment of Tarski’s calculus of relations.

This article comes with a series of appendixes. All the coherence conditions are in Appendix A. Appendix B contains some optional figures which may interest the curious reader. Indeed, apart from Figures 1, 2 and 3 which display all the tape axioms relevant to this paper, all the remaining figures are in Appendixes A or B. Finally, every technical section comes with its own appendix providing additional results and detailed proofs (those in the main text are just sketches).

2 LEADING EXAMPLE: THE CALCULUS OF RELATIONS

In order to provide a preliminary intuition about tape diagrams and, meanwhile, explain their main application investigated in this paper, we recall now the positive fragment of the calculus of binary relations by Tarski [60]. Its syntax is specified by the following context free grammar

$$E ::= R \mid 1 \mid E;E \mid \perp \mid E \cup E \mid \top \mid E \cap E \mid E^\dagger \quad (\text{CR}_\Sigma)$$

where R is taken from a given set Σ of generating symbols. The expression 1 denotes the identity relation, $;$ relational composition, † the opposite relation and the remaining expressions are the usual set-theoretic union \cup and intersection \cap , together with their units \perp and \top being, respectively,

the empty relation and the total relation. Formally, the semantics of CR_Σ is defined w.r.t. a *relational interpretation* \mathcal{I} , that is, a set X together with a binary relation $\rho(R) \subseteq X \times X$ for each $R \in \Sigma$.

$$\begin{aligned}
 \langle\langle R \rangle\rangle_{\mathcal{I}} &= \rho(R) & \langle\langle E^\dagger \rangle\rangle_{\mathcal{I}} &= \{(y, x) \mid (x, y) \in \langle\langle E \rangle\rangle_{\mathcal{I}}\} \\
 \langle\langle \perp \rangle\rangle_{\mathcal{I}} &= \{ \} & \langle\langle E_1 \cup E_2 \rangle\rangle_{\mathcal{I}} &= \langle\langle E_1 \rangle\rangle_{\mathcal{I}} \cup \langle\langle E_2 \rangle\rangle_{\mathcal{I}} \\
 \langle\langle \top \rangle\rangle_{\mathcal{I}} &= \{(x, y) \mid x, y \in X\} & \langle\langle E_1 \cap E_2 \rangle\rangle_{\mathcal{I}} &= \langle\langle E_1 \rangle\rangle_{\mathcal{I}} \cap \langle\langle E_2 \rangle\rangle_{\mathcal{I}} \\
 \langle\langle 1 \rangle\rangle_{\mathcal{I}} &= \text{id}_X = \{(x, x) \mid x \in X\} & \langle\langle E_1; E_2 \rangle\rangle_{\mathcal{I}} &= \{(x, z) \mid \exists y. (x, y) \in \langle\langle E_1 \rangle\rangle_{\mathcal{I}} \wedge (y, z) \in \langle\langle E_2 \rangle\rangle_{\mathcal{I}}\}
 \end{aligned} \tag{2}$$

Two expressions E_1, E_2 are said to be *equivalent*, written $E_1 \equiv_{\text{CR}} E_2$, if and only if $\langle\langle E_1 \rangle\rangle_{\mathcal{I}} = \langle\langle E_2 \rangle\rangle_{\mathcal{I}}$, for all interpretations \mathcal{I} . Inclusion, denoted by \leq_{CR} , is defined analogously by replacing $=$ with \subseteq . For instance, the following two laws assert that $;$ distributes over \cup but only laxly over \cap .

$$R; (S \cup T) \equiv_{\text{CR}} (R; S) \cup (R; T) \quad R; (S \cap T) \leq_{\text{CR}} (R; S) \cap (R; T) \tag{3}$$

The question left open by Tarski is whether or not \equiv_{CR} can be axiomatised: is there a basic set of laws from which one can prove all the valid equivalences? Unfortunately, many negative results show that there are no finite complete axiomatisations for the whole calculus [48], for the positive fragment [36] and several other fragments, e.g. [10, 29, 53]. See [52] for a recent overview.

In this paper we propose a solution to the same problem, but from a radically different perspective: we encode the calculus of relations into a novel calculus that is based on, in our opinion, more primitive linguistic constructions. Our language, named $\text{T}_{\text{CB}_\Sigma}$, is strictly more expressive than CR_Σ but allows to obtain a complete axiomatisation of equivalence and inclusion.

The syntax of $\text{T}_{\text{CB}_\Sigma}$ is based on *circuits* and *tapes*. Circuits are obtained by composing horizontally and vertically the following set of basic gates, where R is a symbol in Σ .

$$\leftarrow \text{C} \quad \bullet \quad \boxed{R} \quad \bullet \quad \rightarrow$$

To abbreviate, we will denote $\leftarrow \text{C}$, \bullet , \boxed{R} and \rightarrow respectively as \blacktriangleleft , $!$, \boxed{R} and \blacktriangleright . Intuitively, \blacktriangleleft acts as a *copier*: it receives a signal (i.e. a value from some set X) on its left wire and sends it to *both* its wires on the right. Instead, $!$ is a *discharger*: it throws away the signal coming from its only wire on the left. Formally, \blacktriangleleft is the pairing function $\langle \text{id}_X, \text{id}_X \rangle$ going from X to $X \times X$, namely the cartesian product of X with itself, while $!$ is the only function going from a set X to a singleton set 1 . The gates \blacktriangleright and \boxed{R} are interpreted as the opposite relations of \blacktriangleleft and $!$, respectively. Finally \boxed{R} simply denotes an arbitrary binary relation R on X .

It is worth emphasising here that signal flows through circuits as a *wave*, i.e. it passes through *all* the vertical components at the same time. For instance, the circuit $\blacktriangleleft \begin{array}{c} \boxed{R} \\ \boxed{S} \end{array} \blacktriangleright$ denotes the relation $R \cap S$, i.e. the set of all pairs of signals (x, y) such that, at the same time, $x R y$ and $x S y$.

Tapes are obtained by composing horizontally and vertically the following generators

$$\begin{array}{c} \text{C} \\ \text{C} \end{array} \quad = \quad \begin{array}{c} \text{C} \\ \text{C} \end{array} \quad = \quad \begin{array}{c} \text{C} \\ \text{C} \end{array}$$

where the middle one represents a circuit c wrapped inside a tape. To abbreviate, we will denote the first two generators on the left as \blacktriangleleft and \uparrow and the last two on the right as \downarrow and \blacktriangleright . Intuitively, \blacktriangleright lets pass to the right the signal coming from either the top *or* the bottom branch on the left, while \downarrow simply closes a branch. Formally, \blacktriangleright is the coparing function $[\text{id}_X, \text{id}_X]$ going from $X + X$, i.e. the disjoint union of X with itself, to X , while \downarrow is the only function going from the empty set 0 to X . The generators \blacktriangleleft and \uparrow are interpreted as the opposite relations of \blacktriangleright and \downarrow , respectively.

Differently from circuits, a signal flows through a tape as a *particle*, i.e. it passes through *only one* of the vertical components at a time. For instance, the tape in (4) denotes the relation $R \cup S$, i.e. the set of all pairs (x, y) such that either $x R y$ or $x S y$.

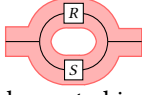

(4)

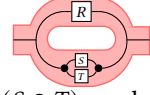

(5)

Since circuits can be nested inside tapes, an expression such as $R \cup (S \cap T)$ can be represented as the tape in (5). A formal semantics of $\mathbf{T}_{\mathbf{CB}_\Sigma}$, as well as an encoding of \mathbf{CR}_Σ into $\mathbf{T}_{\mathbf{CB}_\Sigma}$, will be given in Section 7. Moreover, Theorem 7.5 will state that the axioms in Figures 1, 2 and 3 are complete. Figure 1 features the axioms for “plain” tape diagrams and Figure 2 for their partial order enrichment (discussed in Sections 6.2 and 7); Figure 3 lists axioms to be used specifically for $\mathbf{T}_{\mathbf{CB}_\Sigma}$.

Our axiomatisation is far from those proposed in more traditional approaches to CR, but it elegantly features some well-known algebraic structures that occur frequently in various fields [4, 11–13, 15, 17, 21, 30, 43]. The second group of axioms in Figures 1 and 3 state that $(\triangleleft, \overset{\circ}{!})$ and $(\blacktriangleleft, !)$ are cocommutative comonoids while $(\triangleright, \overset{\circ}{!})$ and $(\blacktriangleright, !)$ are commutative monoids. The third group expresses the facts that $(\triangleleft, \overset{\circ}{!}, \triangleright, \overset{\circ}{!})$ form a bialgebra and $(\blacktriangleleft, !, \blacktriangleright, !)$ a special Frobenius bimonoid. The axioms in Figure 2 assert that the monoid $(\triangleright, \overset{\circ}{!})$ is *left* adjoint to the comonoid $(\triangleleft, \overset{\circ}{!})$, while those in the last group in Figure 3 state the the monoid $(\blacktriangleright, !)$ is *right* adjoint to the monoid $(\blacktriangleleft, !)$.

The formal justification to these axioms will be clarified through the paper but it is worth establishing now a preliminary intuition: consider the axioms $(\triangleright \triangleleft)$ and $(\blacktriangleright \blacktriangleleft)$. In the leftmost tape of $(\triangleright \triangleleft)$, the signal flows either in the top branch or in the bottom one, while in the rightmost tape, the signal coming from any of the two branches on the left may go through any of the branches on the right. In the two tapes of $(\blacktriangleright \blacktriangleleft)$ the signal flows, at the same time, through the top and bottom wires: in the leftmost such signals must be equal, in the rightmost they may be different.

The remaining axioms are those in the first and fourth groups in Figures 1 and 3. The laws in the first group assert that crossings of tapes and wires behave like symmetries. The axioms in the fourth group force naturality for $\triangleleft, \overset{\circ}{!}, \triangleright$ and $\overset{\circ}{!}$, while for \blacktriangleleft and $!$ naturality only holds laxly (and from these one can easily derive that \blacktriangleright and $!$ are colax natural). With these naturality axioms one can immediately derive the laws in (3) as follows:

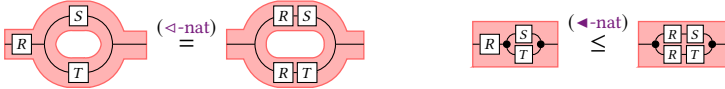

By means of simple graphical manipulations prescribed by the laws in Figures 1, 2 and 3, one can prove all the valid equivalences in CR. The curious reader may have a look to Figure 9 illustrating a graphical derivation for $R \cup (R \cap S) \equiv_{\mathbf{CR}} R$. We conclude this preliminary section by remarking that the discussed axiomatisation has some redundancies, e.g. $(\overset{\circ}{!}, \overset{\circ}{!})$ evidently follows from (bo). We have however chosen this presentation to emphasise the various elegant dualities.

3 STRING DIAGRAMS AND MONOIDAL CATEGORIES

We begin our exposition by regarding string diagrams [39, 56] as terms of a typed language. Given a set \mathcal{S} of basic *sorts*, hereafter denoted by A, B, \dots , types are elements of \mathcal{S}^* , i.e. words over \mathcal{S} . Terms are defined by the following context free grammar

$$f ::= id_A \mid id_I \mid s \mid \sigma_{A,B}^\circ \mid f;f \mid f \circ f \quad (6)$$

where s belongs to a fixed set Σ of *generators* and I is the empty word. Each $s \in \Sigma$ comes with two types: arity $ar(s)$ and coarity $coar(s)$. The tuple $(\mathcal{S}, \Sigma, ar, coar)$, Σ for short, forms a *monoidal signature*. Amongst the terms generated by (6) we consider only those that can be typed according to the inference rules in Table 1. String diagrams are such terms modulo the axioms in Table 1 where, for any $X, Y \in \mathcal{S}^*$, id_X and $\sigma_{X,Y}^\circ$ can be easily built using $id_I, id_A, \sigma_{A,B}^\circ, \circ$ and $;$ (see e.g. [62]).

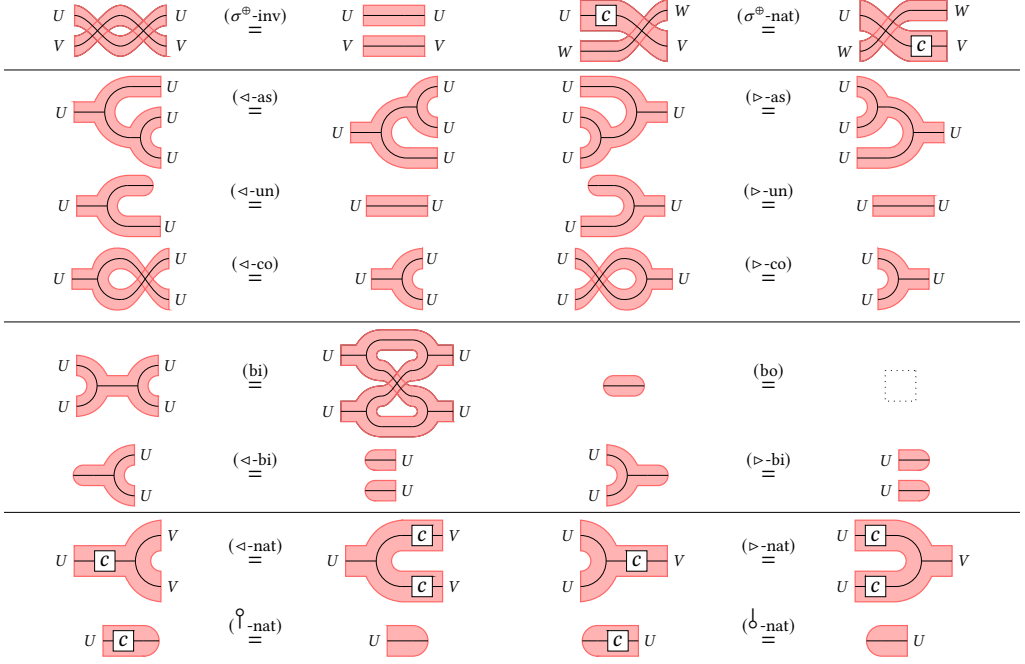

Fig. 1. Axioms for tape diagrams

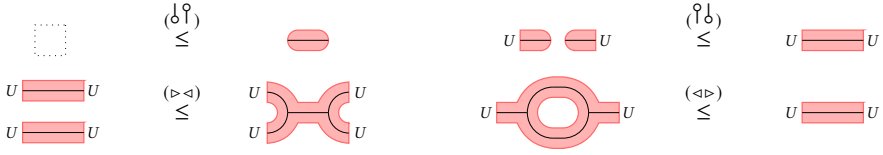
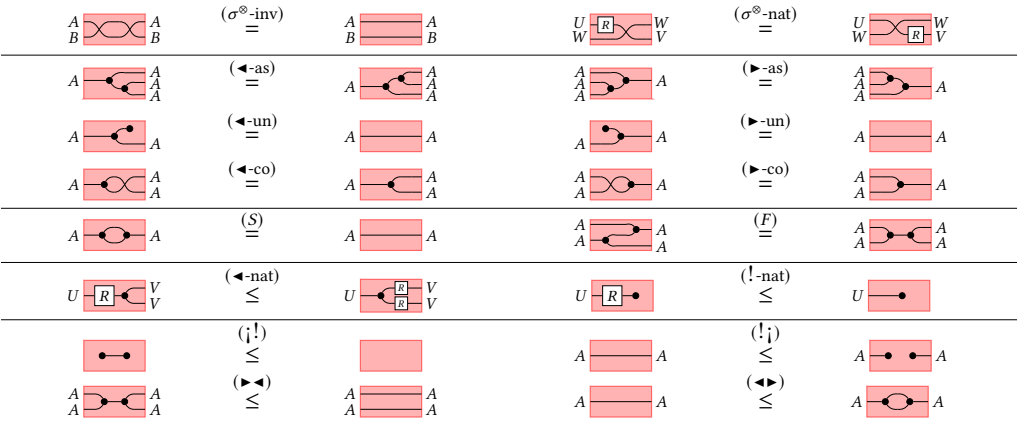

 Fig. 2. Axioms for \downarrow , \dagger and \triangleright

Fig. 3. Axioms of cartesian bicategories

Objects ($A \in \mathcal{S}$)	Arrows ($A \in \mathcal{S}, s \in \Sigma$)	
$X ::= A \mid I \mid X \circ X$	$f ::= id_A \mid id_I \mid s \mid f;g \mid f \circ g \mid \sigma_{A,B}^\circ$	
$(X \circ Y) \circ Z = X \circ (Y \circ Z)$ $X \circ I = X$ $I \circ X = X$	$(f;g);h = f;(g;h)$ $(f_1 \circ f_2);(g_1 \circ g_2) = (f_1;g_1) \circ (f_2;g_2)$ $id_I \circ f = f = f \circ id_I$ $\sigma_{A,B}^\circ; \sigma_{B,A}^\circ = id_{A \circ B}$	
	$id_X; f = f = f; id_Y$ $(f \circ g) \circ h = f \circ (g \circ h)$ $(s \circ id_Z); \sigma_{Y,Z}^\circ = \sigma_{X,Z}^\circ; (id_Z \circ s)$	
Typing rules		
$id_A: A \rightarrow A$	$id_I: I \rightarrow I$	$\sigma_{A,B}^\circ: A \circ B \rightarrow B \circ A$
$s: ar(s) \rightarrow coar(s) \in \Sigma$	$f: X_1 \rightarrow Y_1$	$g: X_2 \rightarrow Y_2$
$s: ar(s) \rightarrow coar(s)$	$f \circ g: X_1 \circ X_2 \rightarrow Y_1 \circ Y_2$	$f;g: X \rightarrow Z$

 Table 1. Axioms for C_Σ

String diagrams enjoy an elegant graphical representation: a generator s in Σ with arity X and coarity Y is depicted as a *box* having *labelled wires* on the left and on the right representing, respectively, the words X and Y . For instance $s: AB \rightarrow C$ in Σ is depicted as the leftmost diagram below. Moreover, id_A is displayed as one wire, id_I as the empty diagram and $\sigma_{A,B}^\circ$ as a crossing:

$$\begin{array}{c} A \\ B \end{array} \text{---} \boxed{s} \text{---} C \qquad A \text{---} A \qquad \square \qquad \begin{array}{c} A \\ B \end{array} \times \begin{array}{c} B \\ A \end{array}$$

Finally, composition $f;g$ is represented by connecting the right wires of f with the left wires of g when their labels match, while the monoidal product $f \circ g$ is depicted by stacking the corresponding diagrams on top of each other:

$$X \text{---} \boxed{f} \text{---} \boxed{g} \text{---} Z \qquad \begin{array}{c} X_1 \\ Y_2 \end{array} \text{---} \begin{array}{c} \boxed{f} \\ \boxed{g} \end{array} \text{---} \begin{array}{c} Y_1 \\ X_2 \end{array}$$

The first three rows of axioms for arrows in Table 1 are implicit in the graphical representation while the axioms in the last row are displayed as

$$\begin{array}{c} A \\ B \end{array} \times \begin{array}{c} A \\ B \end{array} = \begin{array}{c} A \\ B \end{array} \text{---} \begin{array}{c} A \\ B \end{array} \qquad \begin{array}{c} X \\ Z \end{array} \text{---} \boxed{s} \times \begin{array}{c} Z \\ Y \end{array} = \begin{array}{c} X \\ Z \end{array} \times \begin{array}{c} Z \\ Y \end{array} \text{---} \boxed{s}$$

Hereafter, we call C_Σ the category having as objects words in \mathcal{S}^* and as arrows string diagrams. Theorem 2.3 in [39] states that C_Σ is a *symmetric strict monoidal category freely generated* by Σ .

Definition 3.1. A *symmetric monoidal category* consists of a category \mathcal{C} , a bifunctor $\circ: \mathcal{C} \times \mathcal{C} \rightarrow \mathcal{C}$, an object I and natural isomorphisms

$$\alpha_{X,Y,Z}: (X \circ Y) \circ Z \rightarrow X \circ (Y \circ Z) \qquad \lambda_X: I \circ X \rightarrow X \qquad \rho_X: X \circ I \rightarrow X \qquad \sigma_{X,Y}^\circ: X \circ Y \rightarrow Y \circ X$$

satisfying some coherence axioms (in Figures 4 and 5). A monoidal category is said to be *strict* when α , λ and ρ are all identity natural isomorphisms. A *strict symmetric monoidal functor* is a functor $F: \mathcal{C} \rightarrow \mathcal{D}$ preserving \circ , I and σ° .

Remark 3.2. In *strict symmetric monoidal (ssm) categories* the symmetry σ is not forced to be the identity, since this would raise some problems: for instance, $(f_1;g_1) \circ (f_2;g_2) = (f_1;g_2) \circ (f_2;g_1)$ for all $f_1, f_2: A \rightarrow B$ and $g_1, g_2: B \rightarrow C$. As we will see in Section 4, this fact will make the issue of strictness for rig categories rather subtle.

To illustrate in which sense C_Σ is freely generated, it is convenient to introduce *interpretations* in a fashion similar to [56]: an interpretation \mathcal{I} of Σ into an ssm category \mathcal{D} consists of two functions $\alpha_{\mathcal{S}}: \mathcal{S} \rightarrow Ob(\mathcal{D})$ and $\alpha_{\Sigma}: \Sigma \rightarrow Ar(\mathcal{D})$ such that, for all $s \in \Sigma$, $\alpha_{\Sigma}(s)$ is an arrow having as domain

$\alpha_S^\sharp(ar(s))$ and codomain $\alpha_S^\sharp(coar(s))$, for $\alpha_S^\sharp: \mathcal{S}^* \rightarrow Ob(\mathbf{D})$ the inductive extension of α_S . C_Σ is freely generated by Σ in the sense that, for all symmetric strict monoidal categories \mathbf{D} and all interpretations \mathcal{I} of Σ in \mathbf{D} , there exists a unique ssm-functor $\llbracket - \rrbracket_{\mathcal{I}}: C_\Sigma \rightarrow \mathbf{D}$ extending \mathcal{I} (i.e. $\llbracket s \rrbracket_{\mathcal{I}} = \alpha_\Sigma(s)$ for all $s \in \Sigma$).

One can easily extend the notion of interpretation of Σ into a symmetric monoidal category \mathbf{D} that is not necessarily strict. In this case we set $\alpha_S^\sharp: \mathcal{S}^* \rightarrow Ob(\mathbf{D})$ to be the *right bracketing* of the inductive extension of α_S . For instance, $\alpha_S^\sharp(ABC) = \alpha_S(A) \odot (\alpha_S(B) \odot \alpha_S(C))$.

Example 3.3. The set Σ in CR_Σ can be regarded as a monoidal signature. The set of sorts \mathcal{S} is the singleton set $\{A\}$, while the set of generators is exactly Σ . Each generator $R \in \Sigma$ has both arity and coarity A . Now, interpretations $\mathcal{I} = (\alpha_S, \alpha_\Sigma)$ of this monoidal signature into \mathbf{Rel} , the category of sets and relations, are exactly relational interpretations as intended for CR : a set $\alpha_S(A)$ (named X in CR) together with, for all $R \in \Sigma$, a relation $\alpha_\Sigma(R): \alpha_S(A) \rightarrow \alpha_S(A)$ (named $\rho(R)$ in CR).

3.1 The two monoidal structures of \mathbf{Rel}

It is often the case that the same category carries more than one monoidal product. An example relevant to this work is \mathbf{Rel} which exhibits two monoidal structures: $(\mathbf{Rel}, \otimes, 1)$ and $(\mathbf{Rel}, \oplus, 0)$. In the former, \otimes is given by the cartesian product, i.e. $R \otimes S \stackrel{\text{def}}{=} \{(x_1, x_2), (y_1, y_2) \mid (x_1, y_1) \in R \text{ and } (x_2, y_2) \in S\}$ for all relations R, S , and the monoidal unit is the singleton set $1 = \{\bullet\}$. In the latter, \oplus is given by disjoint union, i.e. $R \oplus S \stackrel{\text{def}}{=} \{(x, 0), (y, 0) \mid (x, y) \in R\} \cup \{(x, 1), (y, 1) \mid (x, y) \in S\}$, and the monoidal unit 0 is the empty set. It is worth recalling that in \mathbf{Rel} the empty set is both an initial and final object, i.e. a zero object, and that the disjoint union is both a coproduct and product, in fact a biproduct. Indeed $(\mathbf{Rel}, \oplus, 0)$ is our first example of a finite biproduct category.

Definition 3.4. A *finite biproduct category* is a symmetric monoidal category (\mathbf{C}, \odot, I) where for every object X there are morphisms $\triangleright_X: X \odot X \rightarrow X$, $\lrcorner_X: I \rightarrow X$, $\triangleleft_X: X \rightarrow X \odot X$, $\uparrow_X: X \rightarrow I$ s.t.

- (1) $(\triangleright_X, \lrcorner_X)$ is a commutative monoid and $(\triangleleft_X, \uparrow_X)$ is a cocommutative comonoid, satisfying the coherence axioms in Figure 6,
- (2) every arrow $f: X \rightarrow Y$ is both a monoid and a comonoid homomorphism, i.e.

$$(f \circ f); \triangleright_Y = \triangleright_X; f, \quad \lrcorner_X; f = \lrcorner_Y, \quad f; \triangleleft_Y = \triangleleft_X; (f \circ f) \quad \text{and} \quad f; \uparrow_Y = \uparrow_X.$$

A *morphism of finite biproduct categories* is a symmetric monoidal functor preserving $\triangleright_X, \lrcorner_X, \triangleleft_X, \uparrow_X$.

Observe that the second condition simply amounts to naturality of monoids and comonoids. More generally, the reader who does not recognise the familiar definition of finite biproduct (fb) category may have a look at Appendix D. Monoids and comonoids in the monoidal category $(\mathbf{Rel}, \oplus, 0)$ are illustrated in the first column below:

$$\begin{array}{ll} \triangleright_X \stackrel{\text{def}}{=} \{((x, 0), x) \mid x \in X\} \cup \{((x, 1), x) \mid x \in X\} & \blacktriangleright_X \stackrel{\text{def}}{=} \blacktriangleleft_X^\dagger \\ \lrcorner_X \stackrel{\text{def}}{=} \{\} & \text{i}_X \stackrel{\text{def}}{=} \uparrow_X^\dagger \\ \triangleleft_X \stackrel{\text{def}}{=} \triangleright_X^\dagger & \blacktriangleleft_X \stackrel{\text{def}}{=} \{(x, (x, x)) \mid x \in X\} \\ \uparrow_X \stackrel{\text{def}}{=} \lrcorner_X^\dagger & \text{!}_X \stackrel{\text{def}}{=} \{(x, \bullet) \mid x \in X\} \subseteq X \times 1 \end{array} \quad (7)$$

Also $(\mathbf{Rel}, \otimes, 1)$ has monoids and comonoids, illustrated in the second column above. However, they fail to be natural and, for this reason, $(\mathbf{Rel}, \otimes, 1)$ is not an fb category. It is instead the archetypical example of a cartesian bicategory.

Definition 3.5. A *cartesian bicategory*, in the sense of [18], is a symmetric monoidal category (\mathbf{C}, \odot, I) enriched over the category of posets where for every object X there are morphisms $\blacktriangleright_X: X \odot X \rightarrow X$, $i_X: I \rightarrow X$, $\blacktriangleleft_X: X \rightarrow X \odot X$, $!_X: X \rightarrow I$ such that

- (1) $(\blacktriangleright_X, i_X)$ is a commutative monoid and $(\blacktriangleleft_X, !_X)$ is a cocommutative comonoid, satisfying the coherence axioms in Figure 6,
- (2) every arrow $f: X \rightarrow Y$ is a lax comonoid homomorphism, i.e.

$$f; \blacktriangleleft_Y \leq \blacktriangleleft_X; (f \odot f) \quad \text{and} \quad f; !_Y \leq !_X,$$

- (3) monoids and comonoids form special Frobenius bimonoids (see e.g. [42]),
- (4) the comonoid $(\blacktriangleleft_X, !_X)$ is left adjoint to the monoid $(\blacktriangleright_X, i_X)$, i.e. :

$$i_X; !_X \leq id_I \quad \blacktriangleright_X; \blacktriangleleft_X \leq id_X \odot id_X \quad id_X \leq !_X; i_X \quad id_X \leq \blacktriangleleft_X; \blacktriangleright_X$$

A *morphism of cartesian bicategories* is a poset enriched symmetric monoidal functor preserving monoids and comonoids.

In [14], the authors introduced a string diagrammatic language, named \mathbf{CB}_Σ , expressing the cartesian bicategory structure of $(\mathbf{Rel}, \otimes, 1)$. One can similarly define a language for $(\mathbf{Rel}, \oplus, 0)$, however combining them would require a diagrammatic language that is able to express two different monoidal products at once. The appropriate categorical structures for this are rig categories, discussed in the next section.

4 RIG CATEGORIES

Rig categories [38, 44], also known as *bimonoidal categories*, involve two monoidal structures where one distributes over the other. The structures introduced below are sometimes referred to as *symmetric rig categories*, but for the sake of brevity we will just call them rig categories.

Definition 4.1. A *rig category* is a category \mathbf{C} with two symmetric monoidal structures $(\mathbf{C}, \otimes, 1, \sigma^\otimes)$ and $(\mathbf{C}, \oplus, 0, \sigma^\oplus)$ and natural isomorphisms

$$\begin{aligned} \delta_{X,Y,Z}^l: X \otimes (Y \oplus Z) &\rightarrow (X \otimes Y) \oplus (X \otimes Z) & \lambda_X^\bullet: 0 \otimes X &\rightarrow 0 \\ \delta_{X,Y,Z}^r: (X \oplus Y) \otimes Z &\rightarrow (X \otimes Z) \oplus (Y \otimes Z) & \rho_X^\bullet: X \otimes 0 &\rightarrow 0 \end{aligned}$$

satisfying the coherence axioms in Figure 7. A rig category is said to be *right* (respectively *left*) *strict* when both its monoidal structures are strict and $\lambda^\bullet, \rho^\bullet$ and δ^r (respectively δ^l) are all identity natural isomorphisms.

The natural isomorphism δ^l (δ^r) is called *left* (*right*) *distributor*. The reader may wonder why only one of the two distributors is forced to be the identity within a strict rig category. This can intuitively be explained as follows: imagine requiring that both distributors are identities. This would imply that both equations below should hold for all objects X, Y, Z of any such strict category:

$$(X \oplus Y) \otimes Z = (X \otimes Z) \oplus (Y \otimes Z) \quad \text{and} \quad X \otimes (Y \oplus Z) = (X \otimes Y) \oplus (X \otimes Z).$$

The coexistence of the above laws would raise the same problems of strictification of symmetries (see Remark 3.2). Indeed it would hold at once that

$$(A \oplus B) \otimes (C \oplus D) = ((A \oplus B) \otimes C) \oplus ((A \oplus B) \otimes D) = ((A \otimes C) \oplus (B \otimes C)) \oplus ((A \otimes D) \oplus (B \otimes D))$$

and

$$(A \oplus B) \otimes (C \oplus D) = (A \otimes (C \oplus D)) \oplus (B \otimes (C \oplus D)) = ((A \otimes C) \oplus (A \otimes D)) \oplus ((B \otimes C) \oplus (B \otimes D))$$

Note that $(B \otimes C)$ and $(A \otimes D)$ are in the opposite order in the two terms.

The traditional approach to strictness is however unsatisfactory when studying freely generated categories. To illustrate our concerns, consider a right strict rig category freely generated by a

$X ::= A \mid 1 \mid 0 \mid X \otimes X \mid X \oplus X$	n -ary sums and products
$(X \otimes Y) \otimes Z = X \otimes (Y \otimes Z) \quad 1 \otimes X = X \quad X \otimes 1 = X$ $(X \oplus Y) \oplus Z = X \oplus (Y \oplus Z) \quad 0 \oplus X = X \quad X \oplus 0 = X$ $(X \otimes Y) \otimes Z = (X \otimes Z) \oplus (Y \otimes Z) \quad 0 \otimes X = 0 \quad X \otimes 0 = X$ $A \otimes (Y \oplus Z) = (A \otimes Y) \oplus (A \otimes Z)$	$\bigoplus_{i=1}^0 X_i = 0 \quad \bigoplus_{i=1}^1 X_i = X_1 \quad \bigoplus_{i=1}^{n+1} X_i = X_1 \oplus (\bigoplus_{i=1}^n X_{i+1})$ $\bigotimes_{i=1}^0 X_i = 1 \quad \bigotimes_{i=1}^1 X_i = X_1 \quad \bigotimes_{i=1}^{n+1} X_i = X_1 \otimes (\bigotimes_{i=1}^n X_{i+1})$
(a)	(b)

Table 2. Equations for the objects of a free sesquistrict rig category

signature Σ with sorts \mathcal{S} . The objects of this category are terms generated by the grammar in Table 2a modulo the equations in the first three rows of the same table. These equivalence classes of terms do not come with a very handy form, unlike, for instance, the objects of a strict monoidal category, which are words. For this reason several authors, like [24, 38], prefer to take as objects polynomials in \mathcal{S} at the price of working with a category that is not freely generated but only equivalent to a freely generated one. This fact forces one to consider functors that are not necessarily strict, thus most of the constructions need to properly deal with the tedious natural isomorphisms.

Here we propose a solution that might look a bit technical but, in our opinion, is rewarding. We focus on freely generated rig categories that we call *sesquistrict*, i.e. right strict but only partially left strict: namely the left distributor $\delta_{X,Y,Z}^l: X \otimes (Y \oplus Z) \rightarrow (X \otimes Y) \oplus (X \otimes Z)$ is the identity only when X is a basic sort $A \in \mathcal{S}$. In terms of the equations to impose on objects, this amounts to the one in the fourth row in Table 2a for each $A \in \mathcal{S}$. It is useful to observe that the addition of these equations avoids the problem of using left and right strictness at the same time. Indeed $(A \oplus B) \otimes (C \oplus D)$ turns out to be equal to $(A \otimes C) \oplus (A \otimes D) \oplus (B \otimes C) \oplus (B \otimes D)$ but not to $(A \otimes C) \oplus (B \otimes C) \oplus (A \otimes D) \oplus (B \otimes D)$. Moreover, by orienting all the equations in Table 2a from left to right, one obtains a rewriting system that is confluent and terminating and, most importantly, the unique normal forms are exactly polynomials.

Definition 4.2. A term X of the grammar in Table 2a is said to be in *polynomial* form if there exist n, m_i and $A_{i,j} \in \mathcal{S}$ for $i = 1 \dots n$ and $j = 1 \dots m_i$ such that $X = \bigoplus_{i=1}^n \bigotimes_{j=1}^{m_i} A_{i,j}$ (for n -ary sums and products as in Table 2b).

We will always refer to terms in polynomial form as *polynomials* and, for a polynomial like X above, we will call *monomials* of X the n terms $\bigotimes_{j=1}^{m_i} A_{i,j}$. For instance the monomials of $(A \otimes B) \oplus 1$ are $A \otimes B$ and 1 . Note that, differently from the polynomials we are used to dealing with, here neither \oplus nor \otimes is commutative so, for instance, $(A \otimes B) \oplus 1$ is different from both $1 \oplus (A \otimes B)$ and $(B \otimes A) \oplus 1$. Note that non-commutative polynomials are in one to one correspondence with *words of words* over \mathcal{S} , while monomials are words over \mathcal{S} .

Notation. Through the whole paper, we will denote by $A, B, C \dots$ the sorts in \mathcal{S} , by $U, V, W \dots$ the words in \mathcal{S}^* and by $P, Q, R, S \dots$ the words of words in $(\mathcal{S}^*)^*$. Given two words $U, V \in \mathcal{S}^*$, we will write UV for their concatenation and 1 for the empty word. Given two words of words $P, Q \in (\mathcal{S}^*)^*$, we will write $P \oplus Q$ for their concatenation and 0 for the empty word of words. Given a word of words P , we will write πP for the corresponding term in polynomial form, for instance $\pi(A \oplus BCD \oplus 1)$ is the term $A \oplus ((B \otimes (C \otimes D)) \oplus 1)$. Throughout this paper we often omit π , thus we implicitly identify words of words with polynomials.

Beyond concatenation (\oplus), one can define on $(\mathcal{S}^*)^*$ a product operation \otimes by taking the unique normal form of $\pi(P) \otimes \pi(Q)$ for any $P, Q \in (\mathcal{S}^*)^*$. More explicitly for $P = \bigoplus_i U_i$ and $Q = \bigoplus_j V_j$,

$$P \otimes Q \stackrel{\text{def}}{=} \bigoplus_i \bigoplus_j U_i V_j. \quad (8)$$

Observe that, if both P and Q are monomials, namely, $P = U$ and $Q = V$ for some $U, V \in \mathcal{S}^*$, then $P \otimes Q = UV$. We can thus safely write PQ in place of $P \otimes Q$ without the risk of any confusion.

Words of words are also exploited in the traditional *strictification* theorem for rig categories (see e.g. Theorem 5.4.6 in [38]): given a rig category \mathbf{C} , one can build a right strict rig category $\overline{\mathbf{C}}$ that is equivalent to it. The objects of the strictification $\overline{\mathbf{C}}$ are words of words of objects of \mathbf{C} , while $\overline{\mathbf{C}}[P, Q] = \mathbf{C}[\pi P, \pi Q]$. It is easy to see that \mathbf{C} embeds into $\overline{\mathbf{C}}$: a morphism $f: X \rightarrow Y$ in \mathbf{C} can be seen as a morphism in $\overline{\mathbf{C}}[X, Y]$, where X and Y are considered as unary words made of a single unary word. This embedding forms an equivalence of rig categories $\mathbf{C} \simeq \overline{\mathbf{C}}$. See [38] for further details.

It turns out that $\overline{\mathbf{C}}$ does actually satisfy a partial left distribution, with $Ob(\mathbf{C})$ playing the role of \mathcal{S} , as it were. To make this statement precise, we introduce the following notion.

Definition 4.3. A *sesquistrict rig category* is a functor $H: \mathcal{S} \rightarrow \mathbf{C}$, where \mathcal{S} is a discrete category and \mathbf{C} is a strict rig category, such that for all $A \in \mathcal{S}$

$$\delta_{H(A), X, Y}^l: H(A) \otimes (X \oplus Y) \rightarrow (H(A) \otimes X) \oplus (H(A) \otimes Y)$$

is an identity morphism. We will also say, in this case, that \mathbf{C} is a \mathcal{S} -sesquistrict rig category.

Given $H: \mathcal{S} \rightarrow \mathbf{C}$ and $H': \mathcal{S}' \rightarrow \mathbf{C}'$ two sesquistrict rig categories, a *sesquistrict rig functor* from H to H' is a pair $(\alpha: \mathcal{S} \rightarrow \mathcal{S}', \beta: \mathbf{C} \rightarrow \mathbf{C}')$, with α a functor and β a strict rig functor, such that $\alpha; H' = H; \beta$.

Theorem 4.4. Let \mathbf{C} be a rig category. Then its strictification $\overline{\mathbf{C}}$ is a $Ob(\mathbf{C})$ -sesquistrict rig category.

PROOF. We recall from [38] some facts regarding the strictification $\overline{\mathbf{C}}$ of \mathbf{C} .

Let P and Q be objects of $\overline{\mathbf{C}}$. Then $P \otimes Q$ is given as in (8) and it is immediate to see that $A \otimes (P \oplus Q) = (A \otimes P) \oplus (A \otimes Q)$ when $A \in Ob(\mathbf{C})$. In order to prove that $id_{A \otimes (P \oplus Q)} = \delta_{A, P, Q}^l$ in $\overline{\mathbf{C}}$, one needs to expand the definition of the left distributor δ^l and the symmetries σ^{\otimes} in $\overline{\mathbf{C}}$, which involve structural isomorphisms of \mathbf{C} , and use the coherence theorem for rig categories, as stated in Theorem 3.9.1 of [38]. For this it is enough to observe that $\pi(A \otimes (P \oplus Q))$ is *regular* in the sense of [38, Definition 3.1.25]. \square

Corollary 4.5 (Sesquistrictification). *Any rig category is rig equivalent to a sesquistrict rig category.*

In light of the corollary above, from now on we will only consider strictified rig categories. Moreover, in the rest of the article, whenever we will be considering strict symmetric monoidal functors $F: \mathbf{C} \rightarrow \mathbf{D}$ where \mathbf{D} is a rig category, we will actually mean that $F: \mathbf{C} \rightarrow \overline{\mathbf{D}}$ and we will assume that F sends objects of \mathbf{C} to objects of \mathbf{D} (embedded in $\overline{\mathbf{D}}$). This assumption is not restrictive, as witnessed by the following lemma.

Lemma 4.6. *Let \mathbf{D} be a rig category, $(\mathbf{C}, \otimes, 1)$ a strict symmetric monoidal category and $F: \mathbf{C} \rightarrow (\overline{\mathbf{D}}, \otimes, 1)$ a strict symmetric monoidal functor. Then there exists a ssm functor $F': \mathbf{C} \rightarrow \overline{\mathbf{D}}$, monoidally-naturally isomorphic to F , such that $F(Ob(\mathbf{C})) \subseteq Ob(\mathbf{D})$.*

4.1 Finite biproduct rig categories

On many occasions, one is interested in rig categories where \oplus has some additional structure. For instance, distributive monoidal categories are rig categories where \oplus is a coproduct. In this paper we will focus on rig categories where \oplus is a biproduct.

$\begin{array}{l} \triangleleft_A; (id_A \otimes \triangleleft_A) = \triangleleft_A; (\triangleleft_A \otimes id_A) \\ (id_A \otimes \triangleright_A); \triangleright_A = (\triangleright_A \otimes id_A); \triangleright_A \\ \triangleright_A; \triangleleft_A = \triangleleft_{A \otimes A}; (\triangleright_A \otimes \triangleright_A) \end{array}$	$\begin{array}{l} \triangleleft_A; (\overset{\circ}{\triangleright}_A \otimes id_A) = id_A \\ (\overset{\circ}{\triangleright}_A \otimes id_A); \triangleright_A = id_A \\ \triangleleft_A; \triangleleft_A = \overset{\circ}{\triangleright}_{A \otimes A} \\ \triangleleft_A; \underline{c} = \overset{\circ}{\triangleright}_B \end{array}$	$\begin{array}{l} \triangleleft_A; \sigma_{A,A} = \triangleleft_A \\ \sigma_{A,A}; \triangleright_A = \triangleright_A \\ \triangleleft_A; \overset{\circ}{\triangleright}_A = \overset{\circ}{\triangleright}_{A \otimes A} \\ \underline{c}; \triangleleft_B = \triangleleft_A; (\underline{c} \otimes \underline{c}) \\ \underline{c}; \triangleleft_B = \triangleleft_A; (\underline{c} \otimes \underline{c}) \end{array}$
$\underline{c}; \overset{\circ}{\triangleright}_B = \overset{\circ}{\triangleright}_A$	$\underline{c}; \triangleleft_B = \triangleleft_A; (\underline{c} \otimes \underline{c})$	$\underline{c}; \underline{d} = \underline{c}; \underline{d}$
$\underline{id}_A = id_A$		

 Table 3. Additional axioms for $F_2(\mathbb{C})$. Above, $c: A \rightarrow B$ is an arbitrary arrow of \mathbb{C}

Definition 4.7. A *finite biproduct (fb) rig category* is a rig category $(\mathbb{C}, \oplus, 0, \otimes, 1)$ such that $(\mathbb{C}, \oplus, 0)$ is a finite biproduct category.

It is worth remarking that, without the necessity of any extra coherence axioms, monoids and comonoids given by the fb structure of $(\mathbb{C}, \oplus, 0)$ interact well with \otimes . See Appendix D for all details.

Rel, with the two monoidal structures defined as in Section 3.1, is a fb rig category. Another example relevant to this paper is $\mathbf{Mat}(\mathbb{C})$, the category of complex matrices, with \otimes and \oplus being, respectively, the Kronecker product and the direct sum of matrices. Beyond these examples, our interest in fb rig categories is motivated by Theorem 4.9, which we are going to illustrate now.

Given \mathcal{S} a set of sorts, a *rig signature* is a tuple $(\mathcal{S}, \Sigma, ar, coar)$ where ar and $coar$ assign to each $s \in \Sigma$ an arity and a coarity respectively, which are terms in the grammar specified in Table 2a modulo the equations underneath it. (Notice that any monoidal signature is in particular a rig signature.) To define the notion of free sesquistrict fb rig category, we need to extend interpretations of monoidal signatures to the fb rig case. An *interpretation* of a rig signature $(\mathcal{S}, \Sigma, ar, coar)$ in a sesquistrict fb rig category $H: \mathbf{M} \rightarrow \mathbf{D}$ is a pair of functions $(\alpha_{\mathcal{S}}: \mathcal{S} \rightarrow Ob(\mathbf{M}), \alpha_{\Sigma}: \Sigma \rightarrow Ar(\mathbf{D}))$ such that, for all $s \in \Sigma$, $\alpha_{\Sigma}(s)$ is an arrow having as domain and codomain $(\alpha_{\mathcal{S}}; H)^{\#}(ar(s))$ and $(\alpha_{\mathcal{S}}; H)^{\#}(coar(s))$.

Definition 4.8. Let $(\mathcal{S}, \Sigma, ar, coar)$ (simply Σ for short) be a rig signature. A sesquistrict fb rig category $H: \mathbf{M} \rightarrow \mathbf{D}$ is said to be *freely generated* by Σ if there is an interpretation $(\alpha_{\mathcal{S}}, \alpha_{\Sigma})$ of Σ in H such that for every sesquistrict rig category $H': \mathbf{M}' \rightarrow \mathbf{D}'$ and every interpretation $(\alpha'_{\mathcal{S}}: \mathcal{S} \rightarrow Ob(\mathbf{M}'), \alpha'_{\Sigma}: \Sigma \rightarrow Ar(\mathbf{D}'))$ there exists a unique sesquistrict rig functor $(\alpha: \mathbf{M} \rightarrow \mathbf{M}', \beta: \mathbf{D} \rightarrow \mathbf{D}')$ such that $\alpha_{\mathcal{S}}; \alpha = \alpha'_{\mathcal{S}}$ and $\alpha_{\Sigma}; \beta = \alpha'_{\Sigma}$.

Sesquistrict fb rig categories generated by a given signature are isomorphic to each other, hence we will refer to “the” free sesquistrict rig category generated by a signature.

Theorem 4.9. For every rig signature (\mathcal{S}, Σ) there exists a monoidal signature (\mathcal{S}, Σ_M) such that the free sesquistrict fb rig categories generated by (\mathcal{S}, Σ) and by (\mathcal{S}, Σ_M) are isomorphic.

The proof of the above theorem follows the same pattern as the proof of the well known fact that one can reduce monoidal signatures to standard cartesian signatures when generating the free finite product category. In particular, Σ_M is obtained from Σ by replacing each generator $s: \bigoplus_{i=1}^n U_i \rightarrow \bigoplus_{j=1}^m V_j$ in Σ with new, formal symbols $s_{j,i}$ of type $U_i \rightarrow V_j$.

5 TAPE DIAGRAMS

We have seen in Section 3 that string diagrams provide a convenient graphical language for strict monoidal categories. In this section, we introduce tape diagrams to graphically represent arrows of sesquistrict rig categories.

In order to illustrate our main idea, it is convenient to recall the following functors amongst \mathbf{Cat} , the category of categories and functors, \mathbf{SMC} , the category of ssm categories and functors, and

FBC, the category of strict finite biproduct categories and functors.

$$\text{SMC} \xrightarrow{U_1} \text{Cat} \begin{array}{c} \xrightarrow{F_2} \\ \perp \\ \xleftarrow{U_2} \end{array} \text{FBC} \quad (9)$$

The functors U_1 and U_2 are the obvious forgetful functors. The functor F_2 is the left adjoint to U_2 , and can be described as follows.

Definition 5.1. Let \mathbf{C} be a category. The strict fb category freely generated by \mathbf{C} , hereafter denoted by $F_2(\mathbf{C})$, has as objects words of objects of \mathbf{C} . Arrows are terms inductively generated by the following grammar, where A, B and c range over arbitrary objects and arrows of \mathbf{C} ,

$$f ::= id_A \mid id_I \mid \overline{c} \mid \sigma_{A,B}^\circ \mid f;f \mid f \circ f \mid \uparrow_A \mid \triangleleft_A \mid \downarrow_A \mid \triangleright_A \quad (10)$$

modulo the axioms in Tables 1 and 3. Notice in particular the last two from Table 3:

$$\overline{id_A} = id_A \quad \overline{c;d} = \overline{c}; \overline{d} \quad (\text{Tape})$$

The assignment $\mathbf{C} \mapsto F_2(\mathbf{C})$ easily extends to functors $H: \mathbf{C} \rightarrow \mathbf{D}$. The unit of the adjunction $\eta: Id_{\text{Cat}} \Rightarrow F_2 U_2$ is defined for each category \mathbf{C} as the functor $\overline{\cdot}: \mathbf{C} \rightarrow U_2 F_2(\mathbf{C})$ which is the identity on objects and maps every arrow c in \mathbf{C} into the arrow \overline{c} of $U_2 F_2(\mathbf{C})$. Observe that $\overline{\cdot}$ is indeed a functor, namely an arrow in Cat , thanks to the axioms (Tape). We will refer hereafter to this functor as the *taping functor*.

Lemma 5.2. $F_2: \text{Cat} \rightarrow \text{FBC}$ is left adjoint to $U_2: \text{FBC} \rightarrow \text{Cat}$.

The main result of this section (Theorem 5.11) states that the sesquistrict fb rig category freely generated by a monoidal signature Σ is $F_2 U_1(\mathbf{C}_\Sigma)$, hereafter referred to as \mathbf{T}_Σ . This is somehow the fb rig category analogue to Theorem 2.3 in [39] mentioned in Section 3. Let us see why.

Recall that the set of objects of \mathbf{C}_Σ is \mathcal{S}^* , i.e. words of sorts in \mathcal{S} . The set of objects of \mathbf{T}_Σ is thus $(\mathcal{S}^*)^*$, namely words of words of sorts in \mathcal{S} . For arrows, consider the following two-layer grammar where $s \in \Sigma$, $A, B \in \mathcal{S}$ and $U, V \in \mathcal{S}^*$.

$$\begin{aligned} c &::= id_A \mid id_1 \mid s \mid \sigma_{A,B} \mid c;c \mid c \otimes c \\ \mathbf{t} &::= id_U \mid id_0 \mid \overline{c} \mid \sigma_{U,V}^\oplus \mid \mathbf{t};\mathbf{t} \mid \mathbf{t} \oplus \mathbf{t} \mid \uparrow_U \mid \triangleleft_U \mid \downarrow_U \mid \triangleright_U \end{aligned} \quad (11)$$

The terms of the first row, denoted by c , are called *circuits*. Modulo the axioms in Table 1 (after replacing \circ with \otimes), these are exactly the arrows of \mathbf{C}_Σ . The terms of the second row, denoted by \mathbf{t} , are called *tapes*. Modulo the axioms in Tables 1 and 3 (after replacing \circ with \oplus and A, B with U, V), these are exactly the arrows of $F_2 U_1(\mathbf{C}_\Sigma)$, i.e. \mathbf{T}_Σ .

Since circuits are arrows of \mathbf{C}_Σ , these can be graphically represented as string diagrams. Also tapes can be represented as string diagrams, since they satisfy all of the axioms of *ssmc*. Note however that *inside* tapes, there are string diagrams: this justifies the motto *tape diagrams are string diagrams of string diagrams*. We can thus render graphically the grammar in (11):

$$\begin{aligned} c &::= A \text{ --- } A \quad | \quad \boxed{} \quad | \quad A \text{ --- } \boxed{s} \text{ --- } B \quad | \quad \begin{array}{c} A \\ \text{X} \\ B \end{array} \begin{array}{c} B \\ A \end{array} \quad | \quad U \text{ --- } \boxed{c} \text{ --- } \boxed{c} \text{ --- } V \quad | \quad \begin{array}{c} U \text{ --- } \boxed{c} \text{ --- } V \\ U' \text{ --- } \boxed{c} \text{ --- } V' \end{array} \\ \mathbf{t} &::= U \text{ --- } \boxed{c} \text{ --- } U \quad | \quad \boxed{} \quad | \quad U \text{ --- } \boxed{c} \text{ --- } V \quad | \quad \begin{array}{c} U \\ \text{X} \\ V \end{array} \begin{array}{c} V \\ U \end{array} \quad | \quad \begin{array}{c} P \\ \vdots \\ \mathbf{t} \\ \vdots \\ Q \end{array} \begin{array}{c} Q \\ \vdots \\ \mathbf{t} \\ \vdots \\ S \end{array} \quad | \quad \begin{array}{c} P \\ \vdots \\ \mathbf{t} \\ \vdots \\ Q \end{array} \begin{array}{c} P' \\ \vdots \\ \mathbf{t} \\ \vdots \\ Q' \end{array} \quad | \\ & U \text{ --- } \boxed{c} \quad | \quad \begin{array}{c} U \\ \text{X} \\ U \end{array} \quad | \quad \begin{array}{c} U \\ \text{X} \\ U \end{array} \quad | \quad \begin{array}{c} U \\ \text{X} \\ U \end{array} \end{aligned}$$

The identity id_0 is rendered as the empty tape \square , while id_1 is --- : a tape filled with the empty circuit. For a monomial $U = A_1 \dots A_n$, id_U is depicted as a tape containing n wires labelled by A_i . For instance, id_{AB} is rendered as $\begin{matrix} A \\ \text{---} \\ B \end{matrix}$. When clear from the context, we will simply represent it as a single wire $U \text{---} U$ with the appropriate label. Similarly, for a polynomial $P = \bigoplus_{i=1}^n U_i$, id_P is obtained as a vertical composition of tapes, as illustrated below on the left.

$$id_{AB \oplus 1 \oplus C} = \begin{matrix} A \\ \text{---} \\ B \\ \text{---} \\ C \end{matrix} \quad \overline{\sigma_{AB,C}} = \begin{matrix} A & C \\ \text{---} & \text{---} \\ B & A \\ \text{---} & \text{---} \\ C & B \end{matrix} \quad \sigma_{AB \oplus 1, C}^{\oplus} = \begin{matrix} A & C \\ \text{---} & \text{---} \\ B & A \\ \text{---} & \text{---} \\ C & B \end{matrix}$$

We can render graphically the symmetries $\overline{\sigma_{U,V}} : UV \rightarrow VU$ and $\sigma_{P,Q}^{\oplus} : P \oplus Q \rightarrow Q \oplus P$ as crossings of wires and crossings of tapes, see the two rightmost diagrams above. The diagonal $\triangleleft_U : U \rightarrow U \oplus U$ is represented as a splitting of tapes, while the bang $\uparrow_U : U \rightarrow 0$ is a tape closed on its right boundary. Codiagonals and cobangs are represented in the same way but mirrored along the y-axis. Exploiting the coherence axioms in Figure 6, we can construct (co)diagonals and (co)bangs for arbitrary polynomials P . For example, \triangleleft_{AB} , \uparrow_{CD} , $\triangleright_{A \oplus B \oplus C}$ and $\downarrow_{AB \oplus B \oplus C}$ are depicted as:

$$\triangleleft_{AB} = \begin{matrix} A & B \\ \text{---} & \text{---} \\ B & A \end{matrix} \quad \uparrow_{CD} = \begin{matrix} C \\ \text{---} \\ D \end{matrix} \quad \triangleright_{A \oplus B \oplus C} = \begin{matrix} A & B & C \\ \text{---} & \text{---} & \text{---} \\ B & A & C \\ \text{---} & \text{---} & \text{---} \\ C & B & A \end{matrix} \quad \downarrow_{AB \oplus B \oplus C} = \begin{matrix} A \\ \text{---} \\ B \\ \text{---} \\ B \\ \text{---} \\ C \end{matrix}$$

When the structure inside a tape is not relevant the graphical language can be “compressed” in order to simplify the diagrammatic reasoning. For example, for arbitrary polynomials P, Q we represent id_P , $\sigma_{P,Q}^{\oplus}$, \triangleleft_P , \uparrow_P , \triangleright_P , \downarrow_P as follows:

$$\begin{matrix} P & P \\ \text{---} & \text{---} \\ \vdots & \vdots \end{matrix} \quad \begin{matrix} P & Q \\ \text{---} & \text{---} \\ Q & P \\ \text{---} & \text{---} \\ \vdots & \vdots \end{matrix} \quad \begin{matrix} P \\ \text{---} \\ \vdots \end{matrix} \quad \begin{matrix} P \\ \text{---} \\ \vdots \end{matrix} \quad \begin{matrix} P \\ \text{---} \\ \vdots \end{matrix} \quad \begin{matrix} P \\ \text{---} \\ \vdots \end{matrix}$$

Moreover, for an arbitrary tape diagram $t : P \rightarrow Q$ we write $\begin{matrix} P & Q \\ \text{---} & \text{---} \\ \vdots & \vdots \\ \text{---} & \text{---} \\ \vdots & \vdots \end{matrix} t \begin{matrix} P & Q \\ \text{---} & \text{---} \\ \vdots & \vdots \\ \text{---} & \text{---} \\ \vdots & \vdots \end{matrix}$.

It is important to observe that the graphical representation takes care of the two axioms in (Tape): both sides of the leftmost axiom are depicted as $A \text{---} A$ while both sides of the rightmost axiom as $U \text{---} [c] \text{---} [d] \text{---} V$. The axioms of monoidal categories are also implicit in the graphical representation, while those for symmetries and the fb-structure (in Table 3) have to be depicted explicitly as in Figure 1. In particular, the diagrams in the first row express the inverse law and naturality of σ^{\oplus} . In the second group there are the (co)monoid axioms and in the third group the bialgebra ones. Finally, the last group depicts naturality of the (co)diagonals and (co)bangs.

5.1 The finite biproduct rig structure of tapes

By definition T_{Σ} is equipped with a monoidal product \oplus that is a biproduct. We now show that T_{Σ} carries a second monoidal product \otimes which makes it a sesquistrict rig category.

On objects, \otimes is defined as in (8). For instance, $(A \oplus B) \otimes (C \oplus D)$ is $AC \oplus AD \oplus BC \oplus BD$ and not $AC \oplus BC \oplus AD \oplus BD$. This is justified by the fact that we want T_{Σ} to be a sesquistrict rig category and thus \otimes distributes over \oplus on the right (and only partially on the left).

$\delta_{P,Q,R}^l: P \otimes (Q \oplus R) \rightarrow (P \otimes Q) \oplus (P \otimes R)$	$\sigma_{P,Q}^\otimes: P \otimes Q \rightarrow Q \otimes P, \text{ with } P = \bigoplus_i U_i$
$\delta_{0,Q,R}^l \stackrel{\text{def}}{=} id_0$	$\sigma_{P,0}^\otimes \stackrel{\text{def}}{=} id_0$
$\delta_{U \oplus P', Q, R}^l \stackrel{\text{def}}{=} (id_{U \otimes (Q \oplus R)} \oplus \delta_{P', Q, R}^l); (id_{U \otimes Q} \oplus \sigma_{U \otimes R, P' \otimes Q}^\otimes \oplus id_{P' \otimes R})$	$\sigma_{P, V \oplus Q'}^\otimes \stackrel{\text{def}}{=} \delta_{P, V, Q'}^l: (\bigoplus_i \overline{\sigma_{U_i, V}} \oplus \sigma_{P, Q'}^\otimes)$
(a)	(b)

 Table 4. Inductive definition of δ^l and σ^\otimes

Remark 5.3. Observe that left distributivity holds not only for $A \in \mathcal{S}$, but for all monomials U : $U \otimes (P \oplus Q) = (U \otimes P) \oplus (U \otimes Q)$ for all polynomials P, Q .

In general, distributivity on the left is possible, but has to be made explicit through left distributors built just from identities and \oplus -symmetries, as shown in Table 4a. Similarly, arbitrary \otimes -symmetries can be built, as shown in Table 4b, from left distributors and symmetries within tapes $\overline{\sigma_{U,V}}$.

Example 5.4. By means of the inductive definition in Table 4, $\delta_{A \oplus B, C, D}^l: (A \oplus B)(C \oplus D) \rightarrow (A \oplus B)C \oplus (A \oplus B)D$ and $\sigma_{A \oplus B, C \oplus D}^\otimes: (A \oplus B)(C \oplus D) \rightarrow (C \oplus D)(A \oplus B)$ are depicted as follows:

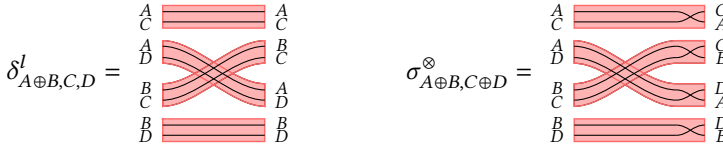

We can now introduce left and right whiskering for those objects U that are monomials.

Definition 5.5. Let U be a monomial. The *left* and *right whiskering* (with respect to U) are two functors $L_U, R_U: \mathbf{T}_\Sigma \rightarrow \mathbf{T}_\Sigma$ which are defined on objects as $L_U(P) \stackrel{\text{def}}{=} U \otimes P$ and $R_U(P) \stackrel{\text{def}}{=} P \otimes U$ and on arrows as:

$$\begin{array}{ll}
 L_U(id_0) \stackrel{\text{def}}{=} id_0 & R_U(id_0) \stackrel{\text{def}}{=} id_0 \\
 L_U(\overline{c}) \stackrel{\text{def}}{=} \overline{id_U \otimes c} & L_U(\sigma_{V,W}^\oplus) \stackrel{\text{def}}{=} \sigma_{UV, UW}^\oplus & R_U(\overline{c}) \stackrel{\text{def}}{=} \overline{c \otimes id_U} & R_U(\sigma_{V,W}^\oplus) \stackrel{\text{def}}{=} \sigma_{VU, WU}^\oplus \\
 L_U(\triangleleft_V) \stackrel{\text{def}}{=} \triangleleft_{UV} & L_U(\uparrow_V) \stackrel{\text{def}}{=} \uparrow_{UV} & R_U(\triangleleft_V) \stackrel{\text{def}}{=} \triangleleft_{VU} & R_U(\uparrow_V) \stackrel{\text{def}}{=} \uparrow_{VU} \\
 L_U(\triangleright_V) \stackrel{\text{def}}{=} \triangleright_{UV} & L_U(\downarrow_V) \stackrel{\text{def}}{=} \downarrow_{UV} & R_U(\triangleright_V) \stackrel{\text{def}}{=} \triangleright_{VU} & R_U(\downarrow_V) \stackrel{\text{def}}{=} \downarrow_{VU} \\
 L_U(\mathbf{t}_1; \mathbf{t}_2) \stackrel{\text{def}}{=} L_U(\mathbf{t}_1); L_U(\mathbf{t}_2) & & R_U(\mathbf{t}_1; \mathbf{t}_2) \stackrel{\text{def}}{=} R_U(\mathbf{t}_1); R_U(\mathbf{t}_2) \\
 L_U(\mathbf{t}_1 \oplus \mathbf{t}_2) \stackrel{\text{def}}{=} L_U(\mathbf{t}_1) \oplus L_U(\mathbf{t}_2) & & R_U(\mathbf{t}_1 \oplus \mathbf{t}_2) \stackrel{\text{def}}{=} R_U(\mathbf{t}_1) \oplus R_U(\mathbf{t}_2)
 \end{array}$$

Example 5.6. The meaning of the monomial whiskering is quite immediate in graphical terms: below we draw the left whiskering of a tape \mathfrak{s} and the right whiskering of a tape \mathfrak{t} . $L_U(\mathfrak{s})$ *thickens* the tapes which \mathfrak{s} is made of, by stacking the wires of id_U inside them; the right whiskering works analogously except that the additional wires are stacked at the bottom of the single tapes:

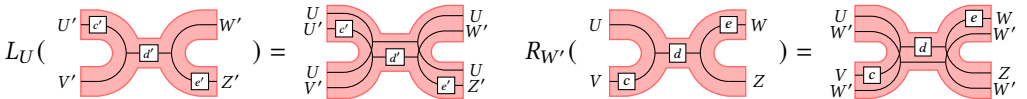

We can extend Definition 5.5 to arbitrary polynomials S as follows.

$L_S(id_P) = id_{SP}$	$R_S(id_P) = id_{PS}$	(W1)
$L_S(t; s) = L_S(t); L_S(s)$	$R_S(t; s) = R_S(t); R_S(s)$	(W2)
$L_1(t) = t$	$R_1(t) = t$	(W3)
$L_0(t) = id_0$	$R_0(t) = id_0$	(W4)
$L_S(t_1 \oplus t_2) = \delta_{S, P_1, P_2}^l; (L_S(t_1) \oplus L_S(t_2)); \delta_{S, Q_1, Q_2}^{-l}$	$R_S(t_1 \oplus t_2) = R_S(t_1) \oplus R_S(t_2)$	(W5)
$L_{S \oplus T}(t) = L_S(t) \oplus L_T(t)$	$R_{S \oplus T}(t) = \delta_{P, S, T}^l; (R_S(t) \oplus R_T(t)); \delta_{Q, S, T}^{-l}$	(W6)
$L_{P_1}(t_2); R_{Q_2}(t_1) = R_{P_2}(t_1); L_{Q_1}(t_2)$		(W7)
$R_S(\triangleleft_U) = \triangleleft_{US}$	$R_S(\triangleright_U) = \triangleright_{US}$	(W8)
$R_S(\overset{\circ}{U}) = \overset{\circ}{US}$	$R_S(\underset{\circ}{U}) = \underset{\circ}{US}$	(W9)
$R_S(\sigma_{P,Q}^{\oplus}) = \sigma_{PS, QS}^{\oplus}$	$\sigma_{PQ, S}^{\oplus} = LP(\sigma_{Q, S}^{\oplus}); RQ(\sigma_{P, S}^{\oplus})$	(W10)
$R_S(t); \sigma_{Q, S}^{\oplus} = \sigma_{P, S}^{\oplus}; L_S(t)$	$L_S(R_T(t)) = R_T(L_S(t))$	(W12)
$L_{ST}(t) = L_S(L_T(t))$	$R_{TS}(t) = R_S(R_T(t))$	(W14)
$R_S(\delta_{P, Q, R}^l) = \delta_{P, QS, RS}^l$	$L_S(\delta_{P, Q, R}^l) = \delta_{SP, QR}^l; \delta_{S, PQ, PR}^{-l}$	(W16)
		(W17)

Table 5. The algebra of whiskerings

Definition 5.7. Let S be a polynomial. $L_S, R_S: \mathbf{T}_\Sigma \rightarrow \mathbf{T}_\Sigma$ are defined on objects as $L_S(P) \stackrel{\text{def}}{=} S \otimes P$ and $R_S(P) \stackrel{\text{def}}{=} P \otimes S$ and on arrows $t: P \rightarrow Q$ by induction on S :

$$\begin{aligned}
 L_0(t) &\stackrel{\text{def}}{=} id_0 & R_0(t) &\stackrel{\text{def}}{=} id_0 \\
 L_{W \oplus S'}(t) &\stackrel{\text{def}}{=} L_W(t) \oplus L_{S'}(t) & R_{W \oplus S'}(t) &\stackrel{\text{def}}{=} \delta_{P, W, S'}^l; (R_W(t) \oplus R_{S'}(t)); \delta_{Q, W, S'}^{-l}
 \end{aligned}$$

Observe that there is an asymmetry in the definition of left and right whiskerings for polynomials: again, this is justified by the fact that \otimes distributes over \oplus on the right. The whiskering of a tape $t: A \oplus B \rightarrow A' \oplus B'$ on the right with the polynomial $C \oplus D$, that is $R_{C \oplus D}(t)$, should go from $(A \oplus B) \otimes (C \oplus D) = AC \oplus AD \oplus BC \oplus BD$ to $(A' \oplus B') \otimes (C \oplus D) = A'C \oplus A'D \oplus B'C \oplus B'D$, whereas $R_C(t) \oplus R_D(t)$ goes from $AC \oplus BC \oplus AD \oplus BD$ to $A'C \oplus B'C \oplus A'D \oplus B'D$.

With Definition 5.7 we can finally introduce \otimes on arrows $t_1: P_1 \rightarrow Q_1, t_2: P_2 \rightarrow Q_2$ as

$$t_1 \otimes t_2 \stackrel{\text{def}}{=} L_{P_1}(t_2); R_{Q_2}(t_1). \quad (12)$$

Example 5.8. Consider $t: U \oplus V \rightarrow W \oplus Z$ and $s: U' \oplus V' \rightarrow W' \oplus Z'$ from Example 5.6, then $t \otimes s$ is simply the sequential composition of $L_{U \oplus V}(s)$ and $R_{W' \oplus Z'}(t)$:

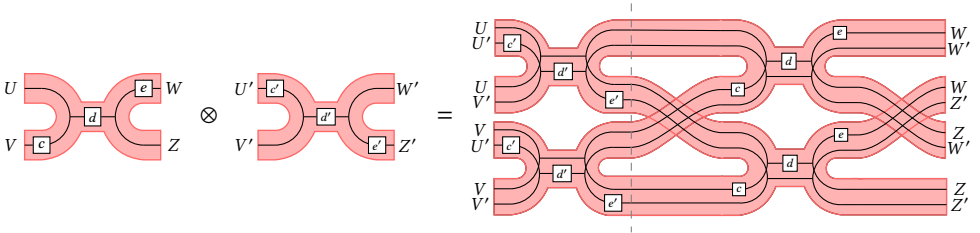

The dashed line highlights the boundary between left and right polynomial whiskerings: $L_{U \oplus V}(s)$, on the left, is simply the vertical composition of the monomial whiskerings $L_U(s)$ and $L_V(s)$ while, on the right, $R_{W' \oplus Z'}(t)$ is rendered as the vertical composition of $R_{W'}(t)$ and $R_{Z'}(t)$, precomposed and postcomposed with left distributors.

Lemma 5.9. The laws in Table 5 hold for any $t: P \rightarrow Q, s: Q \rightarrow R, t_1: P_1 \rightarrow Q_1, t_2: P_2 \rightarrow Q_2$.

The laws in Table 5 are useful in several occasions. In particular, they make it possible to easily prove that \mathbf{T}_Σ is a fb rig category. For instance, functoriality of \otimes immediately follows from (W2)

and (W7): for all $t_1: P \rightarrow Q, t_2: Q \rightarrow S, t_3: P' \rightarrow Q', t_4: Q' \rightarrow S'$,

$$\begin{aligned}
 (t_1; t_2) \otimes (t_3; t_4) &= L_P(t_3; t_4); R_{S'}(t_1; t_2) && \text{(Def. } \otimes) \\
 &= L_P(t_3); L_P(t_4); R_{S'}(t_1); R_{S'}(t_2) && \text{(W2)} \\
 &= L_P(t_3); R_{Q'}(t_1); L_Q(t_4); R_{S'}(t_2) && \text{(W7)} \\
 &= (t_1 \otimes t_3); (t_2 \otimes t_4) && \text{(Def. } \otimes)
 \end{aligned}$$

Theorem 5.10. T_Σ is a S -sesquistrict finite biproduct rig category.

In the future we will refer to the sesquistrict fb rig category $S \rightarrow T_\Sigma$ simply as T_Σ . We can now state the main result of this section.

Theorem 5.11. T_Σ is the free sesquistrict fb rig category generated by the monoidal signature (S, Σ) .

PROOF. We have a trivial interpretation of (S, Σ) in $S \rightarrow T_\Sigma$, given by $(id_S, \bar{\cdot})$. Suppose now that $H: M \rightarrow D$ is a sesquistrict fb rig category with an interpretation $I = (\alpha_S: S \rightarrow Ob(M), \alpha_\Sigma: \Sigma \rightarrow Ar(D))$. We aim to find a sesquistrict fb rig functor $(\alpha: S \rightarrow M, \beta: T_\Sigma \rightarrow D)$ such that $id_S; \alpha = \alpha_S$ and $\bar{\cdot}; \beta = \alpha_\Sigma$. Since (S, Σ) is a monoidal signature, I is in fact a monoidal interpretation of (S, Σ) into the ssm category $(D, \otimes, 1)$, hence by freeness of C_Σ there exists a unique ssm functor $\llbracket - \rrbracket_I: C_\Sigma \rightarrow D$ that extends I . Now, because $T_\Sigma = F_2(C_\Sigma)$ is by definition the free fb category generated by C_Σ and D is also a fb category, we have that there is a unique fb functor $\beta: T_\Sigma \rightarrow D$ that extends $\llbracket - \rrbracket_I$. The fact that β preserves the rest of the rig structure can be proved using the inductive definitions of the symmetries, distributors and the tensor of T_Σ . \square

Corollary 5.12. Let D be a fb rig category and $F: C_\Sigma \rightarrow (D, \otimes, 1)$ be a strict symmetric monoidal functor. Then there exists a unique sesquistrict rig functor $F^\sharp: T_\Sigma \rightarrow D$ such that $F = F^\sharp \circ \bar{\cdot}$.

The above corollary is rather effective: take C_Σ to be the syntax of a string diagrammatic language and the functor $F: C_\Sigma \rightarrow D$ to be its semantics. Whenever D carries the structure of an fb rig category, then one can extend the semantics F to the language of tape diagrams T_Σ .

Example 5.13 (ZX-calculus). Consider the ZX-calculus with scalars and let ZX be the smc of ZX diagrams and $\llbracket - \rrbracket: ZX \rightarrow \text{Mat}(\mathbb{C})$ the semantic functor given in [3, Definition 3.1.1]. Since $\text{Mat}(\mathbb{C})$ is a fb rig category, one can easily derive the semantics $\llbracket - \rrbracket^\sharp: T_{ZX} \rightarrow \text{Mat}(\mathbb{C})$ of ZX tapes (i.e. tape diagrams of ZX diagrams) as suggested in Corollary 5.12 above.

We show that this construction allows us to obtain an immediate graphical representation of control. Let $\text{---}U\text{---}$ be a ZX diagram for a unitary U and $\triangleleft\text{---}$, $\triangleleft\text{---}$, $\text{---}\triangleright$, $\text{---}\triangleright$ be shorthands for the computational basis states and effects given in [3, Equation 3.72]. For instance, $\llbracket \triangleleft\text{---} \rrbracket = |0\rangle = \begin{pmatrix} 1 \\ 0 \end{pmatrix}$ and $\llbracket \text{---}\triangleright \triangleleft\text{---} \rrbracket = |0\rangle \langle 0| = \begin{pmatrix} 1 & 0 \\ 0 & 0 \end{pmatrix}$. Consider the following diagram:

$$\left\| \begin{array}{c} \text{---}\triangleleft\text{---} \\ \text{---}\triangleleft\text{---} \\ \text{---}\triangleright\text{---} \\ \text{---}\triangleright\text{---} \\ \text{---}U\text{---} \end{array} \right\|^\sharp = |00\rangle \langle 00| + |01\rangle \langle 01| + (|1\rangle \otimes U |0\rangle) \langle 10| + (|1\rangle \otimes U |1\rangle) \langle 11|$$

As witnessed by the semantics the first wire acts as a control qubit on the unitary U and thus the whole diagram can be regarded as a rendering of the controlled unitary CU . The correspondence between the diagrammatic notation and the sum of matrices (+) will be clear in Section 6.

5.2 Diagrammatic reasoning with tapes

String diagrams allow graphical reasoning on arrows of (symmetric) monoidal categories. In particular, graphical proofs are significantly simpler, since the diagrammatic representation implicitly

and we write $\lesssim_{\hat{\mathbb{I}}}$ for the smallest precongruence (w.r.t. \oplus and $;$) generated by $\hat{\mathbb{I}}$, i.e. the relation inductively defined as

$$\frac{t_1 \hat{\mathbb{I}} t_2}{t_1 \lesssim_{\hat{\mathbb{I}}} t_2} (\hat{\mathbb{I}}) \quad \frac{-}{t \lesssim_{\hat{\mathbb{I}}} t} (r) \quad \frac{t_1 \lesssim_{\hat{\mathbb{I}}} t_2 \quad t_2 \lesssim_{\hat{\mathbb{I}}} t_3}{t_1 \lesssim_{\hat{\mathbb{I}}} t_3} (t) \quad \frac{t_1 \lesssim_{\hat{\mathbb{I}}} t_2 \quad s_1 \lesssim_{\hat{\mathbb{I}}} s_2}{t_1 \oplus s_1 \lesssim_{\hat{\mathbb{I}}} t_2 \oplus s_2} (\oplus) \quad \frac{t_1 \lesssim_{\hat{\mathbb{I}}} t_2 \quad s_1 \lesssim_{\hat{\mathbb{I}}} s_2}{t_1; s_1 \lesssim_{\hat{\mathbb{I}}} t_2; s_2} (;$$

Observe that in the above definition we do not close $\lesssim_{\hat{\mathbb{I}}}$ by \otimes . Yet, as stated by the following theorem, $\lesssim_{\hat{\mathbb{I}}}$ coincides with $\leq_{\mathbb{I}}$.

Theorem 5.15. *For all tapes t_1, t_2 , $t_1 \leq_{\mathbb{I}} t_2$ if and only if $t_1 \lesssim_{\hat{\mathbb{I}}} t_2$.*

PROOF. To prove that $\leq_{\mathbb{I}} \subseteq \lesssim_{\hat{\mathbb{I}}}$, first observe that $\mathbb{I} \subseteq \hat{\mathbb{I}}$ by (W3). Thus, to conclude it is enough to show that $\lesssim_{\hat{\mathbb{I}}}$ is closed under \otimes , i.e. that if $t_1 \lesssim_{\hat{\mathbb{I}}} t_2$ and $s_1 \lesssim_{\hat{\mathbb{I}}} s_2$, then $t_1 \otimes s_1 \lesssim_{\hat{\mathbb{I}}} t_2 \otimes s_2$. But this is easy using the definition of \otimes and the algebra of whiskering.

To prove that $\lesssim_{\hat{\mathbb{I}}} \subseteq \leq_{\mathbb{I}}$, it is enough to show that $\hat{\mathbb{I}} \subseteq \leq_{\mathbb{I}}$: if $t_1 \hat{\mathbb{I}} t_2$, there exists $(t'_1, t'_2) \in \mathbb{I}$ such that $R_U(t'_i) = t_i$ for some monomial U . Now, it is easy to see that $R_U(t_i) = t_i \otimes id_U$, thus by rules (r) and (\otimes), $t_1 \leq_{\mathbb{I}} t_2$. \square

The proof in Example 13 can then be carried out completely diagrammatically by virtue of Theorem 5.15. Indeed, steps $(*_1)$ and $(*_2)$ become trivial by means of the whiskered axioms

$$\begin{array}{c} \text{◁} \text{ } \text{▷} \\ \text{ } \text{ } \end{array} \stackrel{(\text{Wid})}{=} \text{---} \quad \begin{array}{c} \text{◁} \text{ } \text{▷} \\ \text{ } \text{ } \end{array} \stackrel{(\text{W}0)}{=} \text{◐} \text{ } \text{◑}$$

Remark 5.16. Tape diagrams for finite coproduct rig categories, namely rig categories where \oplus is a coproduct and 0 is an initial object, can be obtained by discarding from the definition of \mathbf{T}_{Σ} the comonoids $(\text{◁}_U, \text{▷}_U)$. Similarly, by ignoring the monoids $(\text{▷}_U, \text{◁}_U)$, one obtains tape diagrams for finite product rig categories. All the results in the current section hold verbatim for these constructions. However, our focus on finite biproduct categories is justified by the fact that, thanks to Theorem 4.9 which only holds when \oplus is a biproduct, tape diagrams provide a universal language for fb rig categories: all rig signatures generate fb rig categories whose arrows are tapes. In the next section, we illustrate several results that rely on the finite biproduct structure of \mathbf{T}_{Σ} .

6 TAPES AS MATRICES

Like any category with finite biproducts, \mathbf{T}_{Σ} is enriched over \mathbf{CMon} , the category of commutative monoids. For all polynomials P, Q , the homset $\mathbf{T}_{\Sigma}[P, Q]$ carries a commutative monoid defined as

$$\begin{array}{c} t_1 + t_2 \\ \text{ } \end{array} \stackrel{\text{def}}{=} \begin{array}{c} P \\ \text{ } \\ \text{ } \\ \text{ } \\ Q \\ \text{ } \\ t_1 \\ \text{ } \\ t_2 \\ \text{ } \end{array} \quad (\text{i.e. } t_1 + t_2 \stackrel{\text{def}}{=} \text{◁}_P; (t_1 \oplus t_2); \text{▷}_Q) \quad (15)$$

$$\mathbf{0}_{P,Q} \stackrel{\text{def}}{=} \begin{array}{c} P \\ \text{ } \\ \text{ } \\ \text{ } \\ Q \\ \text{ } \\ \text{ } \\ \text{ } \end{array} \quad (\text{i.e. } \mathbf{0}_{P,Q} \stackrel{\text{def}}{=} \text{◐}_P; \text{◑}_Q)$$

for all $t_1, t_2: P \rightarrow Q$. This structure distributes not only over $;$ but also with respect to \otimes .

Proposition 6.1. Let $t_1, t_2: P \rightarrow Q$ and s of the appropriate type. It holds that

- (1) $(t_1 + t_2); s = (t_1; s) + (t_2; s)$
- (2) $s; (t_1 + t_2) = (s; t_1) + (s; t_2)$
- (3) $\mathbf{0}; s = \mathbf{0} = s; \mathbf{0}$
- (4) $(t_1 + t_2) \otimes s = (t_1 \otimes s) + (t_2 \otimes s)$
- (5) $s \otimes (t_1 + t_2) = (s \otimes t_1) + (s \otimes t_2)$
- (6) $\mathbf{0} \otimes s = \mathbf{0} = s \otimes \mathbf{0}$

In this section, we illustrate how such enrichment can be exploited to define a matrix calculus of tapes. First of all we need to identify the entries of these matrices. Let \mathbf{Mnm} be the full subcategory of \mathbf{T}_{Σ} whose objects are just monomials (i.e. unary sums). It is immediate to see that \mathbf{Mnm} is a ssm category (w.r.t. \otimes), because if U and V are two monomials, then so is $U \otimes V$ by definition of \otimes . It is

also clearly enriched over **CMon**. Here are two examples of morphisms in **Mnm**.

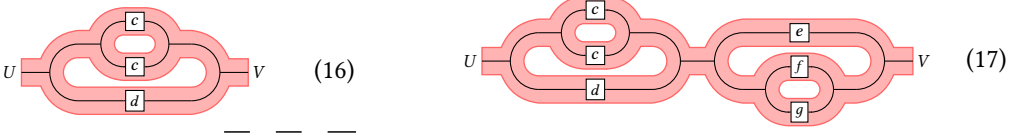

Notice that (16) is in fact $\overline{c} + \overline{c} + \overline{d}$, with $c, d \in \mathbf{C}_\Sigma$. Now, by definition, a morphism in **Mnm** is a tape of \mathbf{T}_Σ with only one ‘input’ and one ‘output’, but in between these two it can be arbitrarily complicated, like in (17) above. However, it turns out that every tape in **Mnm** can be written as the diagram in (16), that is, as a local sum $\sum_i \overline{c_i}$. This is a consequence of the fact that, as we will see in Corollary 6.7, **Mnm** is isomorphic to \mathbf{C}_Σ^+ : the free **CMon**-enriched category generated by \mathbf{C}_Σ .

Definition 6.2. Let \mathbf{C} be any category. The *free CMon-enriched category generated by \mathbf{C}* , denoted as \mathbf{C}^+ , is the category whose objects are those of \mathbf{C} , while $\mathbf{C}^+[A, B]$ is the free commutative monoid generated by $\mathbf{C}[A, B]$: a morphism in $\mathbf{C}^+[A, B]$ is a finite multiset of morphisms in $\mathbf{C}[A, B]$. We write multisets as $\{ \{ a_1, \dots, a_n \} \}$ where the a_i are not necessarily distinct. The identity for A in \mathbf{C}^+ is $\{ \{ id_A^C \} \}$, while if $f: A \rightarrow B$ and $g: B \rightarrow C$ are morphisms of \mathbf{C}^+ , then $f; g \stackrel{\text{def}}{=} \{ \{ a; b \mid a \in f, b \in g \} \}$ ($a; b$ has multiplicity equal to the product of the multiplicities of a in the multiset f and b in the multiset g). Addition of multisets is given by union, with the empty multiset being the neutral element.

The isomorphism between **Mnm** and \mathbf{C}_Σ^+ assigns to each arrow $\mathbf{m}: U \rightarrow V$ in **Mnm**, hereafter referred to as *monomial tapes*, a multiset whose elements are the morphisms of \mathbf{C}_Σ appearing in a path in the diagrammatic representation of \mathbf{m} . For instance, the monomial tape in (16) corresponds to the multiset $\{ \{ c, c, d \} \}$, while the one in (17) to $\{ \{ c; e, c; f, c; g, c; e, c; f, c; g, d; e, d; f, d; g \} \}$. Vice versa, every multiset $\{ \{ c_1, \dots, c_n \} \}$ of arrows in \mathbf{C}_Σ corresponds to the monomial tape $\mathbf{m} = \sum_{i=1}^n \overline{c_i}$.

We can now consider an arbitrary tape $\mathbf{t}: \bigoplus_{i=1}^n U_i \rightarrow \bigoplus_{j=1}^m V_j$. One can represent \mathbf{t} as a $m \times n$ matrix $M(\mathbf{t})$ whose (j, i) entry (row j , column i), is the monomial tape

$$\mathbf{t}_{ji} \stackrel{\text{def}}{=} \left(U_i \xrightarrow{\mu_i} \bigoplus_{k=1}^n U_k \xrightarrow{\mathbf{t}} \bigoplus_{k=1}^m V_k \xrightarrow{\pi_j} V_j \right) \quad (18)$$

where $\mu_i \stackrel{\text{def}}{=} \bigoplus_{k=1}^{i-1} \delta_{U_k} \oplus id_{U_i} \oplus \bigoplus_{k=i+1}^n \delta_{U_k}$ and π_j is defined dually. Hence we can associate to \mathbf{t} a $m \times n$ matrix $\mathcal{F}(\mathbf{t})$ whose entries are the multisets corresponding to the monomial tapes \mathbf{t}_{ji} .

Example 6.3. Consider again \mathbf{t} and \mathbf{s} from Example 5.6, then

$$\mathcal{F}(\mathbf{t}) = \begin{matrix} \swarrow & U & & V \\ W & \left\{ \begin{array}{c} \text{---} \overline{d} \text{---} \overline{e} \text{---} \\ \text{---} \overline{d} \text{---} \end{array} \right\} & \left\{ \begin{array}{c} \text{---} \overline{c} \text{---} \overline{d} \text{---} \overline{e} \text{---} \\ \text{---} \overline{c} \text{---} \overline{d} \text{---} \end{array} \right\} \\ Z & & \end{matrix} \quad \text{and} \quad \mathcal{F}(\mathbf{s}) = \begin{matrix} \swarrow & U' & & V' \\ W' & \left\{ \begin{array}{c} \text{---} \overline{c'} \text{---} \overline{d'} \text{---} \\ \text{---} \overline{d'} \text{---} \end{array} \right\} & \left\{ \begin{array}{c} \text{---} \overline{d'} \text{---} \\ \text{---} \overline{d'} \text{---} \overline{e'} \text{---} \end{array} \right\} \\ Z' & & \end{matrix}$$

This correspondence forms an isomorphism that we now illustrate in detail. Given a **CMon**-enriched category \mathbf{S} , one can form the *biproduct completion* [23, 46] of \mathbf{S} , denoted as $\mathbf{Mat}(\mathbf{S})$. Its objects are formal \oplus 's of objects of \mathbf{S} , while a morphism $M: \bigoplus_{k=1}^n A_k \rightarrow \bigoplus_{k=1}^m B_k$ is a $m \times n$ matrix where $M_{ji} \in \mathbf{S}[A_i, B_j]$. Composition is given by matrix multiplication, with the addition being the plus operation on the homsets (provided by the enrichment) and multiplication being composition. The identity morphism of $\bigoplus_{k=1}^n A_k$ is given by the $n \times n$ matrix (δ_{ji}) , where $\delta_{ji} = id_{A_j}$ if $i = j$, while if $i \neq j$, then δ_{ji} is the zero morphism of $\mathbf{S}[A_i, A_j]$.

Theorem 6.4. Let \mathbf{C} be any category. Then $F_2(\mathbf{C}) \cong \mathbf{Mat}(\mathbf{C}^+)$ as *fb* categories.

PROOF. By [46, Exercises VIII.2.5-6], we have a pair of adjunctions

$$\text{Cat} \begin{array}{c} \xrightarrow{(-)^+} \\ \perp \\ \xleftarrow{\text{Mat}(-)} \end{array} \text{CMonCat} \begin{array}{c} \xrightarrow{\text{Mat}(-)} \\ \perp \\ \xleftarrow{\text{Mat}(-)} \end{array} \text{FBC}$$

where the right adjoints are forgetful functors. Since adjunctions compose, the composite functor $\text{Mat}((-)^+)$ is left adjoint to the forgetful functor $U: \text{FBC} \rightarrow \text{Cat}$, as is F_2 : hence they are naturally isomorphic. This makes $F_2(\mathbf{C})$ and $\text{Mat}(\mathbf{C}^+)$ isomorphic as fb categories. Explicitly, the functor $\mathcal{F}: F_2(\mathbf{C}) \rightarrow \text{Mat}(\mathbf{C}^+)$ is the identity on objects and it is defined on morphisms by induction:

- $\mathcal{F}(\overline{c}) = \left(\{\!\!| c \!\!\} \right)$ (the 1×1 matrix of the multiset consisting of one copy of c)
- $\mathcal{F}(id) = id$, $\mathcal{F}(t_2 \circ t_1) = \mathcal{F}(t_2) \circ \mathcal{F}(t_1)$
- Given $A, B \in \mathbf{C}$, $\mathcal{F}(\sigma_{A,B}) = \begin{pmatrix} \emptyset & \{\!\!| id_B \!\!\} \\ \{\!\!| id_A \!\!\} & \emptyset \end{pmatrix}$ of size 2×2 ,

$$\mathcal{F}(\triangleleft_A) = \begin{pmatrix} \{\!\!| id_A \!\!\} \\ \{\!\!| id_A \!\!\} \end{pmatrix}$$

$$\mathcal{F}(\triangleright_A) = \left(\{\!\!| id_A \!\!\} \quad \{\!\!| id_A \!\!\} \right)$$

$$\mathcal{F}(\uparrow_A) = \text{empty matrix of size } 0 \times 1$$

$$\mathcal{F}(\downarrow_A) = \text{empty matrix of size } 1 \times 0$$

- For $f_1: \bigoplus_{i=1}^n A_i \rightarrow \bigoplus_{i=1}^{n'} A'_i$ and $f_2: \bigoplus_{i=1}^m B_j \rightarrow \bigoplus_{i=1}^{m'} B'_j$,

$$\mathcal{F}(f_1 \oplus f_2) = \begin{pmatrix} \mathcal{F}(f_1) & \emptyset_{n' \times m} \\ \emptyset_{m' \times n} & \mathcal{F}(f_2) \end{pmatrix} \quad \square$$

6.1 Kronecker product in $\text{Mat}(\mathbf{C}_\Sigma^+)$

If $(\mathbf{C}, \otimes_{\mathbf{C}}, 1_{\mathbf{C}})$ is a ssm category, then we can define a monoidal product on \mathbf{C}^+ :

$$f \otimes_{\mathbf{C}^+} g \stackrel{\text{def}}{=} \{\!\!| a \otimes_{\mathbf{C}} b \mid a \in f, b \in g \!\!\} : A \otimes_{\mathbf{C}} B \rightarrow A' \otimes_{\mathbf{C}} B'. \quad (19)$$

In turn, this allows us to define a monoidal product in $\text{Mat}(\mathbf{C}^+)$ à la Kronecker. We will denote it as \otimes . On objects it is given as $(\bigoplus_{i=1}^n A_i) \otimes (\bigoplus_{j=1}^m B_j) \stackrel{\text{def}}{=} \bigoplus_{i=1}^n \bigoplus_{j=1}^m A_i B_j$. If $M: \bigoplus_{i=1}^n A_i \rightarrow \bigoplus_{i'=1}^{n'} A'_{i'}$ and $N: \bigoplus_{j=1}^m B_j \rightarrow \bigoplus_{j'=1}^{m'} B'_{j'}$, then $M \otimes N$ is the matrix of size $n'm' \times nm$ defined as in the usual Kronecker product of matrices (with $\otimes_{\mathbf{C}^+}$ playing the role of multiplication).

Theorem 6.5. *Let \mathbf{C} be an ssm category. Then $\text{Mat}(\mathbf{C}^+)$ is a fb rig category, with tensor given by \otimes , and $F_2(\mathbf{C}) \cong \text{Mat}(\mathbf{C}^+)$ as fb rig categories.*

PROOF. One can define on $F_2(\mathbf{C})$ a monoidal product \otimes distributing on \oplus in a completely analogous way of \mathbf{T}_Σ , making it a fb rig category. This means that $\text{Mat}(\mathbf{C}^+)$ inherits the structure of a strict fb rig category from $F_2(\mathbf{C})$ via the isomorphism \mathcal{F} of Theorem 6.4, by simply setting $M \otimes N \stackrel{\text{def}}{=} \mathcal{F}(\mathcal{F}^{-1}(M) \otimes_{\mathbf{T}_\Sigma} \mathcal{F}^{-1}(N))$ and similarly for the rest of the rig structure. This immediately makes \mathcal{F} an isomorphism of fb rig categories. Moreover, one can prove that $\otimes = \otimes$ by means of direct calculations. \square

We conclude by applying our general result to $\mathbf{C} = \mathbf{C}_\Sigma$.

Corollary 6.6. $\mathbf{T}_\Sigma \cong \text{Mat}(\mathbf{C}_\Sigma^+)$ as fb rig categories.

Corollary 6.7. $\mathbf{Mnm} \cong \mathbf{C}_\Sigma^+$ as ssm categories.

Example 6.8. Recall from Example 5.8 the tape diagram $t \otimes s$. The corresponding matrix, which can be computed as the Kronecker product of $\mathcal{F}(t)$ and $\mathcal{F}(s)$ in Example 6.3, is illustrated below.

$$\mathcal{F}(t \otimes s) = \begin{array}{c} \begin{array}{c} \swarrow \\ WW' \\ WZ' \\ ZW' \\ ZZ' \end{array} \end{array} \left(\begin{array}{cccc} UU' & UV' & VU' & VV' \\ \left\{ \begin{array}{c} \overline{d} \overline{e} \\ \overline{c'} \overline{d'} \end{array} \right\} & \left\{ \begin{array}{c} \overline{d} \overline{e} \\ \overline{d'} \end{array} \right\} & \left\{ \begin{array}{c} \overline{c} \overline{d} \overline{e} \\ \overline{c'} \overline{d'} \end{array} \right\} & \left\{ \begin{array}{c} \overline{c} \overline{d} \overline{e} \\ \overline{d'} \end{array} \right\} \\ \left\{ \begin{array}{c} \overline{d} \overline{e} \\ \overline{c'} \overline{d'} \overline{e'} \end{array} \right\} & \left\{ \begin{array}{c} \overline{d} \overline{e} \\ \overline{d'} \overline{e'} \end{array} \right\} & \left\{ \begin{array}{c} \overline{c} \overline{d} \overline{e} \\ \overline{c'} \overline{d'} \overline{e'} \end{array} \right\} & \left\{ \begin{array}{c} \overline{c} \overline{d} \overline{e} \\ \overline{d'} \overline{e'} \end{array} \right\} \\ \left\{ \begin{array}{c} \overline{d} \\ \overline{c'} \overline{d'} \end{array} \right\} & \left\{ \begin{array}{c} \overline{d} \\ \overline{d'} \end{array} \right\} & \left\{ \begin{array}{c} \overline{c} \overline{d} \\ \overline{c'} \overline{d'} \end{array} \right\} & \left\{ \begin{array}{c} \overline{c} \overline{d} \\ \overline{d'} \end{array} \right\} \\ \left\{ \begin{array}{c} \overline{d} \\ \overline{c'} \overline{d'} \overline{e'} \end{array} \right\} & \left\{ \begin{array}{c} \overline{d} \\ \overline{d'} \overline{e'} \end{array} \right\} & \left\{ \begin{array}{c} \overline{c} \overline{d} \\ \overline{c'} \overline{d'} \overline{e'} \end{array} \right\} & \left\{ \begin{array}{c} \overline{c} \overline{d} \\ \overline{d'} \overline{e'} \end{array} \right\} \end{array} \right)$$

6.2 Poset Enrichment

We saw that T_Σ is isomorphic to a category of matrices in Corollary 6.6. Here we want to extend the isomorphism to the case where the category of tapes is equipped with a poset generated by a tape theory. We shall focus on a particular case of tape theory, namely the one arising from a monoidal theory (Σ, \mathbb{I}) by simply adding the four tape axioms in Figure 2. These axioms force \triangleright_U to be left adjoint to \triangleleft_U and \downarrow_U to \uparrow_U . Moreover, they make $+$, as defined in (15), idempotent, thus a join \sqcup , with \mathfrak{o} being its bottom element \perp (see Figure 12).

For a monoidal theory (Σ, \mathbb{I}) , we call *the generated tape theory* $(\Sigma, \tilde{\mathbb{I}})$ the tape theory where $\tilde{\mathbb{I}}$ consists of the four inequalities in Figure 2 together with all those pairs $(\overline{c}, \overline{d})$ whenever $(c, d) \in \mathbb{I}$. We can then form the category $T_{\Sigma, \tilde{\mathbb{I}}}^\sim$ as explained in Section 5.2. It turns out that $T_{\Sigma, \tilde{\mathbb{I}}}^\sim$ is isomorphic to a certain category of matrices that we are going to illustrate next.

Let (X, \leq) be a preordered set and $S \subseteq X$. The *downward closure* of S is defined to be the set $S \downarrow = \{x \in X \mid \exists s \in S. x \leq s\}$. S is said to be *downward closed* if $S = S \downarrow$; a downward closed set $A \subseteq X$ is said to be *finitely generated* if there exists a finite set $B \subseteq X$ such that $A = B \downarrow$. Consider now an arbitrary category C enriched over a preorder \leq_C . We can form a new category C^\downarrow whose objects are $Ob(C)$ while a morphism of type $X \rightarrow Y$ in C^\downarrow is a finitely generated downward closed subset of $C[X, Y]$. $C^\downarrow[X, Y]$ is partially ordered by inclusion, has all finite joins given by unions, composition is defined using the composition in C and this makes C^\downarrow a finite join-semilattice enriched category. For a monoidal theory (Σ, \mathbb{I}) , one can construct the poset enriched monoidal category $C_{\Sigma, \mathbb{I}}^\sim$ as in Section 5.2 and, since $C_{\Sigma, \mathbb{I}}^\sim \downarrow$ is enriched over finite join semilattices (and thus commutative monoids), one can take its biproduct completion.

Theorem 6.9. $T_{\Sigma, \tilde{\mathbb{I}}}^\sim \cong \text{Mat}(C_{\Sigma, \mathbb{I}}^\sim \downarrow)$ as poset-enriched fb rig categories.

PROOF. Let C be preorder-enriched: then we can equip $C^+[X, Y]$ with the Egli-Milner preorder

$$\{c_1, \dots, c_n\} \leq^{EM} \{d_1, \dots, d_m\} \iff \forall i. \exists j. c_i \leq_C d_j,$$

making C^+ , and in turn $\text{Mat}(C^+)$, preorder-enriched. We can also enrich $F_2(C)$ in a way that the isomorphism \mathcal{F} of Theorem 6.4 becomes preorder-enriched. To do so we add on the homsets of $F_2(C)$ the precongruence, with respect to composition, \oplus and \otimes , generated by the following axioms:

$$f \leq_C g \Rightarrow \overline{f} \leq \overline{g} \quad \triangleleft_A; \triangleright_A \leq id_A \quad id_{A \oplus A} \leq \triangleright_A; \triangleleft_A \quad \uparrow_A; \downarrow_A \leq id_A \quad id_{\mathfrak{o}} \leq \downarrow_A; \uparrow_A$$

(The last four axioms are the generalised version of Figure 2 for $F_2(C)$.) One can then prove that \mathcal{F} preserves and reflects the inequalities of $F_2(C)$. Taking now $F_2(C)^\sim$ and $\text{Mat}(C^+)^\sim$, we obtain a

poset-enriched isomorphism. Observe that $\mathbf{Mat}(\mathbf{C}^+)^\sim \cong \mathbf{Mat}((\mathbf{C}^+)^\sim)$, because the order on matrices is entry by entry, and that $(\mathbf{C}^+)^\sim \cong \mathbf{C}^\downarrow$, because for all $S, T \in \mathbf{C}^+[X, Y]$, $S \leq_{EM} T$ iff $S \downarrow \subseteq T \downarrow$.

If we apply this to $\mathbf{C} = \mathbf{C}_{\Sigma, \mathbb{I}}$, then we have that $F_2(\mathbf{C})^\sim = \mathbf{T}_{\Sigma, \mathbb{I}}^\sim$ and we obtain $\mathbf{T}_{\Sigma, \mathbb{I}}^\sim \cong \mathbf{Mat}(\mathbf{C}_{\Sigma, \mathbb{I}}^\downarrow)$. We conclude by simply observing that $\mathbf{C}_{\Sigma, \mathbb{I}}^\downarrow \cong \mathbf{C}_{\Sigma, \mathbb{I}}^\downarrow$. \square

A consequence of Theorem 6.9 is that we can characterise the partial order of $\mathbf{T}_{\Sigma, \mathbb{I}}^\sim[P, Q]$ as follows: for arbitrary monomials $\sum_{h=1}^n \overline{c_h}$ and $\sum_{k=1}^m \overline{d_k}$ we define $\leq_{\mathbb{I}}^{EM}$ as

$$\sum_{h=1}^n \overline{c_h} \leq_{\mathbb{I}}^{EM} \sum_{k=1}^m \overline{d_k} \iff \forall h. \exists k. c_h \leq_{\mathbb{I}} d_k$$

and we extend it to arbitrary tapes $\mathfrak{t}, \mathfrak{s}: \bigoplus_i U_i \rightarrow \bigoplus_j V_j$ as

$$\mathfrak{t} \leq_{\mathbb{I}}^{EM} \mathfrak{s} \iff \forall i, j. \mathfrak{t}_{ji} \leq_{\mathbb{I}}^{EM} \mathfrak{s}_{ji}$$

where \mathfrak{t}_{ji} and \mathfrak{s}_{ji} are the monomials in (18).

Corollary 6.10. $\mathfrak{t} \leq_{\mathbb{I}} \mathfrak{s}$ iff $\mathfrak{t} \leq_{\mathbb{I}}^{EM} \mathfrak{s}$.

Remark 6.11. Consider the case of \mathbb{I} being 0, the empty set. Then Theorem 6.9 asserts that $\mathbf{T}_{\Sigma, \emptyset}^\sim$, which is simply the poset enriched version of \mathbf{T}_Σ generated by the inequalities of Figure 2, is isomorphic to the biproduct completion of the free *join-semilattice enriched* category generated by \mathbf{C}_Σ . The latter is the same as \mathbf{C}_Σ^+ except that its homsets are sets, rather than multisets, of arrows of \mathbf{C}_Σ . Indeed, since the preorder on $\mathbf{C}_{\Sigma, 0}[X, Y]$ is discrete, we have that the finitely generated downward closed subsets of $\mathbf{C}_{\Sigma, 0}[X, Y]$ are exactly finite subsets of $\mathbf{C}_{\Sigma, 0}[X, Y]$.

Example 6.12 ($\mathbf{T}_{\mathbf{CB}_\Sigma}$). We recall from [14] \mathbf{CB}_Σ : the cartesian bicategory freely generated by a single sorted, i.e. $\mathcal{S} = \{A\}$, monoidal signature Σ . In a nutshell, \mathbf{CB}_Σ can be described as $\mathbf{C}_{\Gamma, \mathbb{I}}^\sim$ where the monoidal signature Γ is $\Sigma \cup \{\blacktriangleright_A: A \odot A \rightarrow A, \iota_A: I \rightarrow A, \blacktriangleleft_A: A \rightarrow A \odot A, !_A: A \rightarrow I\}$ and the set of axioms \mathbb{I} consists of those of cartesian bicategories, see Figure 3. There we draw, for all $U \in \mathcal{S}^{*1}$, $\blacktriangleright_U, \iota_U, \blacktriangleleft_U, !_U$ as

$$\begin{array}{ccccccc} \begin{array}{c} U \\ \downarrow \\ \blacktriangleright_U \end{array} & \begin{array}{c} \bullet \\ \downarrow \\ \iota_U \end{array} & \begin{array}{c} U \\ \downarrow \\ \blacktriangleleft_U \end{array} & \begin{array}{c} U \\ \downarrow \\ !_U \end{array} \end{array}$$

In the generated tape theory $(\Sigma, \tilde{\mathbb{I}})$, the set of axioms $\tilde{\mathbb{I}}$ consists of those in Figures 2 and 3. In the next section we will show that $\mathbf{T}_{\Gamma, \mathbb{I}}^\sim$ provides a complete calculus for relations. An essential ingredient is Corollary 6.10 above. Hereafter we will write $\mathbf{T}_{\mathbf{CB}_\Sigma}$ for $\mathbf{T}_{\Gamma, \mathbb{I}}^\sim$ and denote the poset of \mathbf{CB}_Σ as $\leq_{\mathbf{CB}_\Sigma}$ while the one in $\mathbf{T}_{\mathbf{CB}_\Sigma}$ as \leq_T .

Example 6.13 (\sqcup -props). By exploiting a mixture of algebraic and diagrammatic syntax, the authors of [9] introduced \sqcup -props to model piecewise linear systems (e.g. diodes). Tape diagrams, instead, provide a purely graphical calculus for \sqcup -props.

Consider a single sorted, i.e. $\mathcal{S} = \{A\}$, monoidal signature Σ and take \mathbb{I} to be the empty set 0 (no axioms). The objects of $\mathbf{T}_{\Sigma, \emptyset}^\sim$ can easily be seen to be in one-to-one correspondence with words of natural numbers: $\bigoplus_i^n A^{m_i} \mapsto m_1 m_2 \dots m_n$. In particular monomials are natural numbers and \otimes on monomials is just addition. Thus, by taking \mathbf{Mnm} , the full subcategory of $\mathbf{T}_{\Sigma, \emptyset}^\sim$ where objects are monomials, one obtains a *prop* [42, 45]. It is immediate to see that \mathbf{Mnm} is a \sqcup -*prop*: every homset carries a join semilattice with bottom (as in (15)), which is preserved by composition and monoidal product (Proposition 6.1). Most importantly, \mathbf{Mnm} is the \sqcup -prop freely generated by Σ , as defined

¹The coherence axioms of (co)monoids (in Figure 6) provide a recipe to define inductively, $\blacktriangleright_U, \iota_U, \blacktriangleleft_U, !_U$, for all $U \in \mathcal{S}^*$.

in [9]. One can readily see this by means of Theorem 6.9 and Remark 6.11. Therefore, whenever one is interested in the \sqcup -prop freely generated by some monoidal signature Σ , one can rather embed it into $\mathbf{T}_{\Sigma,0}^{\sim}$ and exploit the graphical calculus of tapes (see Figure 11 for an example). Notice that there is a little mismatch with the definition in [9], where the freely generated \sqcup -prop has as arrows only *non-empty* finite sets. The empty set is instead denoted in **Mnm** by \mathfrak{o} : the presence of \mathfrak{o} seems however a feature rather than an issue as illustrated, for instance, by the axiom (0).

7 BACK TO RELATIONS

The tape axioms introduced in Section 6.2 forcing $(\triangleright_X, \lrcorner_X)$ to be left adjoint to $(\triangleleft_X, \uparrow_X)$ (Figure 2) suggest a general categorical notion reconciling the two monoidal structures of **Rel** (Section 3.1).

Definition 7.1. A poset enriched rig category \mathbf{C} is said to be a *fb-cb rig category* (or simply fb-cb category for short) if

- (1) $(\mathbf{C}, \oplus, 0)$ is a finite biproduct category;
- (2) $(\mathbf{C}, \otimes, 1)$ is a cartesian bicategory;
- (3) the monoid $(\triangleright_X, \lrcorner_X)$ of \oplus is left adjoint to the comonoid $(\triangleleft_X, \uparrow_X)$, i.e.

$$id_0 \leq \lrcorner_X; \uparrow_X \quad id_X \oplus id_X \leq \triangleright_X; \triangleleft_X \quad \uparrow_X; \lrcorner_X \leq id_X \quad \text{and} \quad \triangleleft_X; \triangleright_X \leq id_X$$

- (4) the (co)monoids of both $(\mathbf{C}, \oplus, 0)$ and $(\mathbf{C}, \otimes, 1)$ satisfy the following coherence axioms:

$$\begin{aligned} \triangleleft_{X \oplus Y} &= (\triangleleft_X \oplus \lrcorner_{XY} \oplus \lrcorner_{YX} \oplus \triangleleft_Y); (\delta_{X,X,Y}^{-l} \oplus \delta_{Y,X,Y}^{-l}); (\delta_{X,Y,X \oplus Y}^{-r}) \quad !_{X \oplus Y} = (!_X \oplus !_Y); \triangleright_1 \\ \triangleright_{X \oplus Y} &= (\delta_{X,Y,X \oplus Y}^r); (\delta_{X,X,Y}^l \oplus \delta_{Y,X,Y}^l); (\triangleright_X \oplus \uparrow_{XY} \oplus \uparrow_{YX} \oplus \triangleright_Y) \quad i_{X \oplus Y} = \triangleleft_1; (i_X \oplus i_Y) \end{aligned}$$

A *morphism of fb-cb categories* is a poset enriched rig functor that is both a morphism of finite biproduct categories and a morphism of cartesian bicategories.

We have already seen in Section 3.1 that $(\mathbf{Rel}, \oplus, 0)$ is an fb-category and $(\mathbf{Rel}, \otimes, 1)$ is a cartesian bicategory. To conclude that **Rel** is an fb-cb category is enough to check that conditions (3) and (4) above are satisfied: this is trivial by using the definitions of the two (co)monoids of **Rel** in (7).

Remark 7.2. By exploiting the structure of fb-cb category, one can express finite unions and intersections in **Rel**. The reader can easily check that for all relations $R, S: X \rightarrow Y$, it holds that

$$R \cup S = \triangleleft_X; (R \oplus S); \triangleright_Y \quad \{\} = \uparrow_X; \lrcorner_Y \quad R \cap S = \triangleleft_X; (R \otimes S); \triangleright_Y \quad X \otimes Y = !_X; i_Y$$

Another example of fb-rig category is $\mathbf{T}_{\mathbf{CB}_{\Sigma}}$ from Example 6.12.

Theorem 7.3. $\mathbf{T}_{\mathbf{CB}_{\Sigma}}$ is an fb-cb category.

PROOF. By construction $\mathbf{T}_{\mathbf{CB}_{\Sigma}}$ is a poset enriched fb rig category with $(\triangleright_X, \lrcorner_X)$ left adjoint to $(\triangleleft_X, \uparrow_X)$. To prove that $(\mathbf{T}_{\mathbf{CB}_{\Sigma}}, \otimes, 1)$ is a cartesian bicategory, we need to define $\triangleleft_P: P \rightarrow P \otimes P$, $!_P: P \rightarrow 1$, $\triangleright_P: P \rightarrow P \otimes P$ and $i_P: 1 \rightarrow P$ for all polynomials P . The coherence axioms in Definition 7.1 provide us the recipe:

$$\begin{aligned} \triangleleft_0 &\stackrel{\text{def}}{=} id_0 & !_0 &\stackrel{\text{def}}{=} \lrcorner_1 \\ \triangleleft_{U \oplus P'} &\stackrel{\text{def}}{=} \triangleleft_U \oplus \lrcorner_{UP'} \oplus ((\lrcorner_{P'U} \oplus \triangleleft_{P'}); \delta_{P',U,P'}^{-l}) & !_U \oplus P' &\stackrel{\text{def}}{=} (!_U \oplus !_P'); \triangleright_1 \end{aligned} \quad (20)$$

$$\begin{aligned} \triangleright_0 &\stackrel{\text{def}}{=} id_0 & i_0 &\stackrel{\text{def}}{=} \uparrow_1 \\ \triangleright_{U \oplus P'} &\stackrel{\text{def}}{=} \triangleright_U \oplus \uparrow_{UP'} \oplus (\delta_{P',U,P'}^l; (\uparrow_{P'U} \oplus \triangleright_{P'})) & i_U \oplus P' &\stackrel{\text{def}}{=} \triangleleft_1; (i_U \oplus i_{P'}) \end{aligned} \quad (21)$$

$\llbracket u \text{---} \boxed{R} \text{---} v \rrbracket_{\mathcal{I}} = \alpha_{\Sigma}(R)$	$\llbracket A \text{---} \text{---} A \rrbracket_{\mathcal{I}} = \blacktriangleleft_X$	$\llbracket A \text{---} \bullet \rrbracket_{\mathcal{I}} = !_X$	$\llbracket A \text{---} \text{---} A \rrbracket_{\mathcal{I}} = \blacktriangleright_X$	$\llbracket \bullet \text{---} A \rrbracket_{\mathcal{I}} = i_X$
$\llbracket id_A \rrbracket_{\mathcal{I}} = id_X$	$\llbracket id_1 \rrbracket_{\mathcal{I}} = id_1$	$\llbracket \sigma_{A,A}^{\otimes} \rrbracket_{\mathcal{I}} = \sigma_{X,X}^{\otimes}$	$\llbracket [c_1; c_2] \rrbracket_{\mathcal{I}} = \llbracket [c_1] \rrbracket_{\mathcal{I}} ; \llbracket [c_2] \rrbracket_{\mathcal{I}}$	$\llbracket [c_1 \otimes c_2] \rrbracket_{\mathcal{I}} = \llbracket [c_1] \rrbracket_{\mathcal{I}} \otimes \llbracket [c_2] \rrbracket_{\mathcal{I}}$
$\llbracket u \text{---} \boxed{c} \text{---} v \rrbracket_{\mathcal{I}}^{\#} = \llbracket [c] \rrbracket_{\mathcal{I}}$	$\llbracket u \text{---} \text{---} u \rrbracket_{\mathcal{I}}^{\#} = \blacktriangleleft_W$	$\llbracket u \text{---} \bullet \rrbracket_{\mathcal{I}}^{\#} = !_W$	$\llbracket u \text{---} \text{---} u \rrbracket_{\mathcal{I}}^{\#} = \blacktriangleright_W$	$\llbracket \bullet \text{---} u \rrbracket_{\mathcal{I}}^{\#} = i_W$
$\llbracket id_U \rrbracket_{\mathcal{I}}^{\#} = id_W$	$\llbracket id_0 \rrbracket_{\mathcal{I}}^{\#} = id_0$	$\llbracket \sigma_{U,U'}^{\oplus} \rrbracket_{\mathcal{I}}^{\#} = \sigma_{W,W'}^{\oplus}$	$\llbracket [s; t] \rrbracket_{\mathcal{I}}^{\#} = \llbracket [s] \rrbracket_{\mathcal{I}}^{\#} ; \llbracket [t] \rrbracket_{\mathcal{I}}^{\#}$	$\llbracket [s \oplus t] \rrbracket_{\mathcal{I}}^{\#} = \llbracket [s] \rrbracket_{\mathcal{I}}^{\#} \oplus \llbracket [t] \rrbracket_{\mathcal{I}}^{\#}$

Table 6. The morphisms $\llbracket [\cdot] \rrbracket_{\mathcal{I}} : \mathbf{CB}_{\Sigma} \rightarrow \mathbf{Rel}$ and $\llbracket [\cdot] \rrbracket_{\mathcal{I}}^{\#} : \mathbf{TCB}_{\Sigma} \rightarrow \mathbf{Rel}$ extending an interpretation $\mathcal{I} = (\alpha_S, \alpha_{\Sigma})$ of a monoidal signature Σ in \mathbf{Rel} . We write X, W, W' for $\alpha_S(A)$, $\alpha_S^{\#}(U)$ and $\alpha_S^{\#}(U')$ respectively, and $\blacktriangleright_X, i_X, \blacktriangleleft_X, !_X, \blacktriangleright_W, i_W, \blacktriangleleft_W, !_W$ for the (co)monoids in \mathbf{Rel} defined as in (7).

For instance, $\blacktriangleleft_{A \oplus B} : A \oplus B \rightarrow (A \oplus B) \otimes (A \oplus B) = AA \oplus AB \oplus BA \oplus BB$ and $!_{A \oplus B} : A \oplus B \rightarrow 1$ are

$$\blacktriangleleft_{A \oplus B} = \begin{array}{c} A \text{---} \bullet \\ A \\ B \text{---} \bullet \\ B \end{array} \quad !_{A \oplus B} = \begin{array}{c} A \text{---} \bullet \\ B \text{---} \bullet \end{array} \quad \square$$

We now focus on fb-cb morphisms from \mathbf{TCB}_{Σ} to \mathbf{Rel} . In [14] it is shown that every interpretation \mathcal{I} of the monoidal signature Σ in \mathbf{Rel} gives rise to a morphism of cartesian bicategories $\llbracket [\cdot] \rrbracket_{\mathcal{I}} : \mathbf{CB}_{\Sigma} \rightarrow \mathbf{Rel}$. This extends in turn to a morphism of fb-cb categories $\llbracket [\cdot] \rrbracket_{\mathcal{I}}^{\#} : \mathbf{TCB}_{\Sigma} \rightarrow \mathbf{Rel}$ as illustrated in Table 6. More generally, the following holds.

Proposition 7.4. The following are (pairwise) in bijective correspondence:

- (1) interpretations of the monoidal signature Σ in \mathbf{Rel} ;
- (2) morphisms of cartesian bicategories $\mathbf{CB}_{\Sigma} \rightarrow \mathbf{Rel}$;
- (3) morphisms of sesquistrict fb-cb categories $\mathbf{TCB}_{\Sigma} \rightarrow \mathbf{Rel}$.

Arrows in \mathbf{TCB}_{Σ} can be thought of as expressions and $\llbracket [\cdot] \rrbracket_{\mathcal{I}}^{\#} : \mathbf{TCB}_{\Sigma} \rightarrow \mathbf{Rel}$ as a semantic map assigning to each expression t the denoted relation. For instance by using the definition in Table 6 and Remark 7.2, the reader can easily check that

$$\llbracket \left(\begin{array}{c} \text{---} \boxed{R} \text{---} \\ \text{---} \boxed{S} \text{---} \\ \text{---} \boxed{T} \text{---} \end{array} \right) \rrbracket_{\mathcal{I}}^{\#} = \alpha_{\Sigma}(R) \cup (\alpha_{\Sigma}(S) \cap \alpha_{\Sigma}(T)). \quad (22)$$

It turns out that if $\llbracket [s] \rrbracket_{\mathcal{I}}^{\#} \subseteq \llbracket [t] \rrbracket_{\mathcal{I}}^{\#}$ for all interpretations \mathcal{I} of Σ in \mathbf{Rel} , then one can derive that $s \leq_T t$ in \mathbf{TCB}_{Σ} . In other words, the axioms of \mathbf{TCB}_{Σ} are *complete* with respect to relational inclusion.

Theorem 7.5 (Completeness). *Let s, t be arrows in \mathbf{TCB}_{Σ} . Then $s \leq_T t$ if and only if $\mathcal{M}(s) \leq \mathcal{M}(t)$ for all morphisms of sesquistrict fb-cb categories $\mathcal{M} : \mathbf{TCB}_{\Sigma} \rightarrow \mathbf{Rel}$.*

PROOF. Soundness is trivial: since the \mathcal{M} 's by definition preserve the ordering, then $s \leq_T t$ entails $\mathcal{M}(s) \leq \mathcal{M}(t)$ for all \mathcal{M} . For completeness we will make use of the following facts, where every \mathcal{M} appearing below is intended to be a morphism of fb-cb categories:

- (1) For all $\mathcal{M} : \mathbf{TCB}_{\Sigma} \rightarrow \mathbf{Rel}$ and $c, d \in \mathbf{CB}_{\Sigma}[U, V]$, $\mathcal{M}(\overline{c + d}) = \mathcal{M}(\overline{c}) \cup \mathcal{M}(\overline{d})$.
- (2) Let $c, d_1, \dots, d_m \in \mathbf{CB}_{\Sigma}[U, V]$. If for all $\mathcal{M} : \mathbf{TCB}_{\Sigma} \rightarrow \mathbf{Rel}$ we have $\mathcal{M}(\overline{c}) \leq \mathcal{M}(\overline{\sum_{j=1}^m d_j})$, then there exists a j such that $c \leq_{\mathbf{CB}_{\Sigma}} d_j$.







$\mathcal{E}(R) = $		$\mathcal{E}(E^\dagger) = $	
$\mathcal{E}(\perp) = $		$\mathcal{E}(E_1 \cup E_2) = $	
$\mathcal{E}(\top) = $		$\mathcal{E}(E_1 \cap E_2) = $	
$\mathcal{E}(1) = $		$\mathcal{E}(E_1; E_2) = $	$\mathcal{E}(E_1); \mathcal{E}(E_2)$

 Table 7. The encoding $\mathcal{E}(-): \mathbf{CR}_\Sigma \rightarrow \mathbf{T}_{\mathbf{CB}_\Sigma}[A, A]$

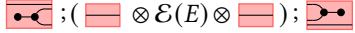
- (3) Let $c_1, \dots, c_n, d_1, \dots, d_m \in \mathbf{CB}_\Sigma[U, V]$. If for all $\mathcal{M}: \mathbf{T}_{\mathbf{CB}_\Sigma} \rightarrow \mathbf{Rel}$ we have $\mathcal{M}(\sum_{i=1}^n \overline{c_i}) \leq \mathcal{M}(\sum_{j=1}^m \overline{d_j})$, then for all i there exists a j such that $c_i \leq_{\mathbf{CB}_\Sigma} d_j$.
- (4) Let $\mathfrak{s}, \mathfrak{t}$ be arrows in \mathbf{Mnm} . If for all $\mathcal{M}: \mathbf{T}_{\mathbf{CB}_\Sigma} \rightarrow \mathbf{Rel}$ we have $\mathcal{M}(\mathfrak{s}) \leq \mathcal{M}(\mathfrak{t})$, then $\mathfrak{s} \leq_T \mathfrak{t}$.
- (5) Let \mathbf{C} be a fb category monoidally enriched over a preorder \leq . Let $f, g: \bigoplus_{i=1}^n A_i \rightarrow \bigoplus_{j=1}^m B_j$ be arrows in \mathbf{C} . Let f_{ji} and g_{ji} be, respectively, $\mu_i; f; \pi_j$ and $\mu_i; g; \pi_j$. Then $f \leq g$ if and only if $f_{ji} \leq g_{ji}$ for all i, j .

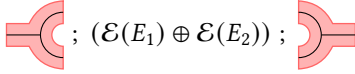
(1) and (5) are easy to prove. (2) follows from the proof of Theorem 17 in [14]: for all $c \in \mathbf{CB}_\Sigma[U, V]$, there exist a morphism $\mathcal{U}_c: \mathbf{CB}_\Sigma \rightarrow \mathbf{Rel}$ and an element $(\iota, \omega) \in \mathcal{U}_c(c)$ such that for all $d \in \mathbf{CB}_\Sigma[U, V]$, if $(\iota, \omega) \in \mathcal{U}_c(d)$ then $c \leq_{\mathbf{CB}_\Sigma} d$. (3) follows from (1) and (2). (4) follows from (3) and Corollary 6.10.

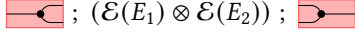
By recalling that, for arbitrary tape diagrams $\mathfrak{s}, \mathfrak{t}: \bigoplus U_i \rightarrow \bigoplus V_j$, \mathfrak{s}_{ji} and \mathfrak{t}_{ji} are in \mathbf{Mnm} , we can easily extend (4): if $\mathcal{M}(\mathfrak{s}) \leq \mathcal{M}(\mathfrak{t})$ for all morphisms of fb-cb categories $\mathcal{M}: \mathbf{T}_{\mathbf{CB}_\Sigma} \rightarrow \mathbf{Rel}$, then, by applying (5) to \mathbf{Rel} , $\mathcal{M}(\mathfrak{s})_{ji} \leq \mathcal{M}(\mathfrak{t})_{ji}$. Hence $\mathcal{M}(\mathfrak{s}_{ji}) = \mathcal{M}(\mathfrak{s})_{ji} \leq \mathcal{M}(\mathfrak{t})_{ji} = \mathcal{M}(\mathfrak{t}_{ji})$ for all fb-cb morphisms \mathcal{M} . By (4) we have $\mathfrak{s}_{ji} \leq_T \mathfrak{t}_{ji}$ and thus, again by (5), $\mathfrak{s} \leq_T \mathfrak{t}$. \square

Remark 7.6. Point (2) in the above proof already appears in different flavours in the literature: for instance it closely resembles Lemma 13 in [19] and Lemma 3 in [2]. In this sense, the proof above is analogous to the one in [54] that provides an algorithm for checking inclusion of disjunctive-conjunctive queries by relying on the algorithm in [19] for conjunctive queries.

Deconstructing the calculus of relations with tapes. We conclude by showing how tapes can help in dealing with $\leq_{\mathbf{CR}}$, i.e. the semantic inclusion of the calculus of binary relations (Section 2).

Recall from Example 3.3 that the set Σ in \mathbf{CR}_Σ can be regarded as a monoidal signature Σ with set of sorts $\mathcal{S} = \{A\}$. From this signature one constructs $\mathbf{T}_{\mathbf{CB}_\Sigma}$ as prescribed in Example 6.12 and encodes expressions of \mathbf{CR}_Σ into tapes of $\mathbf{T}_{\mathbf{CB}_\Sigma}$. The encoding $\mathcal{E}(\cdot)$ is illustrated in Table 7 where, to make the notation lighter, we avoided labelling all the wires with A . It is easy to see that all expressions are mapped into tapes of type $A \rightarrow A$. For instance,

$$\begin{aligned}
 \mathcal{E}(R \cup (S \cap T)) &= \text{Diagram 1} \\
 &= \text{Diagram 2} \\
 &= \text{Diagram 3} \\
 &= \text{Diagram 4}
 \end{aligned}$$

Observe that $\llbracket \mathcal{E}(R \cup (S \cap T)) \rrbracket^\sharp$, illustrated in (22), coincides with $\langle\langle R \cup (S \cap T) \rangle\rangle_I$ defined in (2). More generally, a simple inductive argument confirms that $\mathcal{E}(\cdot)$ preserves the semantics.

Proposition 7.7. For all expressions $E \in \text{CR}_\Sigma$ and interpretations \mathcal{I} , $\langle\langle E \rangle\rangle_I = \llbracket \mathcal{E}(E) \rrbracket_I^\sharp$.

By Propositions 7.4, 7.7 and the completeness theorem the next result follows immediately.

Corollary 7.8. For all $E_1, E_2 \in \text{CR}_\Sigma$, $E_1 \leq_{\text{CR}} E_2$ if and only if $\mathcal{E}(E_1) \leq_T \mathcal{E}(E_2)$.

Remark 7.9. The reader may wonder whether it is possible to encode tape diagrams into the calculus of relations. This is not the case, even when considering only tapes in $\text{T}_{\text{CB}_\Sigma}[A, A]$. To prove this it is enough to observe that a tape of type $A \rightarrow A$ can express the graph (8) in [52] which is known to be not expressible in CR_Σ . More generally, $\text{T}_{\text{CB}_\Sigma}$ can express coherent logic, i.e. the fragment of first order logic consisting of \exists , \wedge , \top , \vee and \perp , while the positive fragment of the calculus of relations expresses the restriction of coherent logic to formulae using at most three variables: indeed one needs four variables to express the graph (8) in [52]. The curious reader may try to extend the encoding in Figure 4 of [14] with some tapes expressing \vee and \perp .

8 CONCLUSION

Related work. The idea of inserting string diagrams into superstructures, like we do when passing from C_Σ to T_Σ , is not new. Here we mention a few examples, but this list is by no means exhaustive. Functorial boxes [47], for instance, are a graphical expedient that allows one to draw in a simple, intuitive manner monoidal functors $F: \mathbf{C} \rightarrow \mathbf{D}$: the image along F of a string diagram c in \mathbf{C} can be depicted as a box, labelled by F , drawn around c . A clear analogy to our tape diagrams, however, as a diagrammatic calculus for finite biproduct rig categories, does not seem to be evident. A more apparent resemblance with our drawings are *twisting polygraphs* used in [1] to give a formal syntax for the representation of proof nets in Multiplicative Linear Logic. In there the author develops a string diagrammatic calculus, where diagrams look like tree-shaped “tapes”, whose leaves are the axioms appearing in the proof. However, there is no mention of rig categories in [1]. Also in [7] the authors use a diagrammatic language consisting of certain surfaces that host internal string diagrams within them but these are, like sheet diagrams in [24], inherently three dimensional.

All in all, sheet diagrams are the closest related structures to tape diagrams. Similarities include the fact that the objects are polynomials in both cases and indeed also the category of sheet diagrams turns out to be a sesquistrict rig category. Moreover, the definition of \otimes in [24] exploits a notion of whiskering given in terms of diagrammatic manipulations, while in our approach it is defined inductively. The key difference between the two languages is that sheet diagrams may have nodes (morphisms) in the intersection of two different surfaces. In the presence of a biproduct, by virtue of our Theorem 4.9, we can reduce a rig signature into a monoidal one. In this case, all the generators will appear as nodes in a single sheet and never in an intersection of two or more. The only morphisms that will appear in an intersection are (co)diagonals whose existence is guaranteed by the biproduct structure of \oplus .

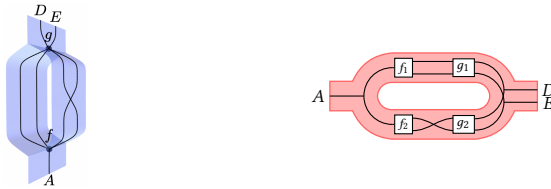

For example, consider the sheet diagram above (on the left) as a representation of a \mathbf{Vect} morphism. Since \mathbf{Vect} has biproducts the generator $f: A \rightarrow BC \oplus BC$ is decomposed as $\triangleleft_A; (f_1 \oplus f_2)$ where

$f_1, f_2: A \rightarrow BC$ are now generators of the novel monoidal signature. Applying the same procedure to $g: BC \oplus CB \rightarrow DE$ yields the tape diagram on the right. When \oplus is not a biproduct, Theorem 4.9 does not hold and thus the procedure described above may fail. One example is **Set**, where $+$ is not a biproduct and thus a function $f: A \times B \rightarrow X + Y$ cannot be canonically decomposed in two functions $f_1: A \times B \rightarrow X$ and $f_2: A \times B \rightarrow Y$. Therefore $f: A \times B \rightarrow X + Y$ can be drawn using sheet diagrams, crucially in 3 dimensions, but not using tape diagrams.

Conclusion and future work. Like string diagrams provide, by virtue of Theorem 2.3 in [39], a graphical language for symmetric monoidal categories, tape diagrams are, by Theorems 4.9 and 5.11, a universal language for rig categories with finite biproducts. In particular, thanks to Corollary 5.12, whenever the semantic domain of a string diagrammatic language carries the structure of a finite biproduct rig category (or even a finite (co)product, see Remark 5.16), one can wrap string diagrams into tapes and obtain a meaningful language. By applying this approach to the ZX-calculus, we are able to easily specify a primitive form of quantum control (Examples 5.13 and 5.14). Other relevant instances of tape diagrams are \sqcup -props from [9] (Example 6.13).

The leading example investigated in this paper is CR, the positive fragment of the calculus of relations [60]. The tape diagrams axioms in Figures 1, 2 and 3 allow us to prove all and only the valid equivalences between expressions of CR (Corollary 7.8). This result follows easily from the completeness theorem (Theorem 7.5) that is close in spirit to those in [33] and [57]. Note that Corollary 7.8 does not contradict the impossibility of a finite axiomatisation proved in [36], as our syntax is a radical departure from CR. However, the fact that a simple axiomatisation—consisting of several well known algebraic structures—is possible with tape diagrams seems to suggest that the tape notation is more suitable than the traditional one.

The obvious next step consists in considering the extension of CR with Kleene star (reflexive and transitive closure), see e.g. [16, 52]. In terms of tapes this can be obtained by adding a trace to the monoidal structure given by \oplus . Note that $T_{CB_{\Sigma}}$ is actually traced on \otimes , but this trace corresponds to feedbacks and not to Kleene star (iteration). The relationship between the two traced monoidal structures of **Rel** has been studied in [55], rephrasing an early work by Bainbridge [5], who was the first to observe the duality between *data flow* and *control flow* provided by $(\mathbf{Rel}, \otimes, 1)$ and $(\mathbf{Rel}, \oplus, 0)$. Indeed, the language resulting from adding a trace to $T_{CB_{\Sigma}}$ would represent data flow at the level of circuits and control flow at the level of tapes. Such language would be similar in spirit to a diagrammatic version of Hoare Logic [34] consisting of imperative programs, predicates on them and, in place of a proof system, diagrammatic laws. The ubiquity of our axioms gives us the hope that this language could be easily adjusted to deal with concurrent and quantum computations. Preliminary inspirations come, respectively, from [6, 35, 41] and [32].

ACKNOWLEDGMENTS

The authors would like to thank Dusko Pavlovic and Paweł Sobociński for the early discussions that eventually lead to tape diagrams. While writing the paper, we have received useful comments by Farzad Kianvash, Aleks Kissinger, Samuel Mimram, Chad Nester, Robin Piedeleu and Donald Yau. The authors would also like to thank the anonymous referees for their valuable comments and helpful suggestions. This work is supported by the Ministero dell’Università e della Ricerca of Italy under Grant No. 201784YSZ5, PRIN2017 – ASPRA (Analysis of Program Analyses) and partially supported by the Università di Pisa under Grant No. PRA-2022-2023 FM4HD.

REFERENCES

- [1] Matteo Acclavio. 2019. Proof Diagrams for Multiplicative Linear Logic: Syntax and Semantics. *Journal of Automated Reasoning* 63, 4 (Dec. 2019), 911–939. <https://doi.org/10.1007/s10817-018-9466-4>

- [2] H. Andr eka and D. A. Bredikhin. 1995. The Equational Theory of Union-Free Algebras of Relations. *Algebra Universalis* 33, 4 (Dec. 1995), 516–532. <https://doi.org/10.1007/BF01225472>
- [3] M Backens. 2015. *Completeness and the ZX-calculus*. Ph. D. Dissertation. University of Oxford. <https://ora.ox.ac.uk/objects/uuid:0120239e-b504-4376-973d-d720a095f02e>
- [4] John Baez and Jason Erbele. 2015. Categories In Control. *Theory and Applications of Categories* 30 (2015), 836–881. <http://www.tac.mta.ca/tac/volumes/30/24/30-24abs.html>
- [5] Edwin S. Bainbridge. 1976. Feedback and Generalized Logic. *Information and Control* 31, 1 (May 1976), 75–96. [https://doi.org/10.1016/S0019-9958\(76\)90390-9](https://doi.org/10.1016/S0019-9958(76)90390-9)
- [6] Paolo Baldan and Fabio Gadducci. 2019. Petri nets are dioids: a new algebraic foundation for non-deterministic net theory. *Acta Informatica* 56, 1 (2019), 61–92. <https://doi.org/10.1007/s00236-018-0314-0>
- [7] Bruce Bartlett, Christopher L. Douglas, Christopher J. Schommer-Pries, and Jamie Vicary. 2015. Modular Categories as Representations of the 3-Dimensional Bordism 2-Category. <https://doi.org/10.48550/arXiv.1509.06811> [math]
- [8] Corrado B ohm and Giuseppe Jacopini. 1979. Flow Diagrams, Turing Machines and Languages with Only Two Formation Rules. In *Classics in Software Engineering*. Yourdon Press, USA, 11–25. <https://dl.acm.org/doi/abs/10.5555/1241515.1241517>
- [9] Guillaume Boisseau and Robin Piedeleu. 2022. Graphical Piecewise-Linear Algebra. In *Foundations of Software Science and Computation Structures (Lecture Notes in Computer Science)*, Patricia Bouyer and Lutz Schr oder (Eds.). Springer International Publishing, Cham, 101–119. https://doi.org/10.1007/978-3-030-99253-8_6
- [10] Benedikt Bollig, Alain Finkel, and Amrita Suresh. 2020. Bounded Reachability Problems Are Decidable in FIFO Machines. In *31st International Conference on Concurrency Theory (CONCUR 2020) (Leibniz International Proceedings in Informatics (LIPIcs), Vol. 171)*, Igor Konnov and Laura Kov acs (Eds.). Schloss Dagstuhl–Leibniz-Zentrum f ur Informatik, Dagstuhl, Germany, 49:1–49:17. <https://doi.org/10.4230/LIPIcs.CONCUR.2020.49>
- [11] Filippo Bonchi, Fabio Gadducci, Aleks Kissinger, Pawel Sobocinski, and Fabio Zanasi. 2022. String Diagram Rewrite Theory I: Rewriting with Frobenius Structure. *J. ACM* 69, 2 (2022), 14:1–14:58. <https://doi.org/10.1145/3502719>
- [12] Filippo Bonchi, Joshua Holland, Robin Piedeleu, Pawel Sobociński, and Fabio Zanasi. 2019. Diagrammatic Algebra: From Linear to Concurrent Systems. *Proceedings of the ACM on Programming Languages* 3, POPL (Jan. 2019), 25:1–25:28. <https://doi.org/10.1145/3290338>
- [13] Filippo Bonchi, Robin Piedeleu, Pawel Sobociński, and Fabio Zanasi. 2019. Graphical Affine Algebra. In *2019 34th Annual ACM/IEEE Symposium on Logic in Computer Science (LICS)*. 1–12. <https://doi.org/10.1109/LICS.2019.8785877>
- [14] Filippo Bonchi, Jens Seeber, and Pawel Sobocinski. 2018. Graphical Conjunctive Queries. In *27th EACSL Annual Conference on Computer Science Logic (CSL 2018) (Leibniz International Proceedings in Informatics (LIPIcs), Vol. 119)*, Dan Ghica and Achim Jung (Eds.). Schloss Dagstuhl–Leibniz-Zentrum fuer Informatik, Dagstuhl, Germany, 13:1–13:23. <https://doi.org/10.4230/LIPIcs.CSL.2018.13>
- [15] Filippo Bonchi, Pawel Sobocinski, and Fabio Zanasi. 2015. Full Abstraction for Signal Flow Graphs. In *Proceedings of the 42nd Annual ACM SIGPLAN-SIGACT Symposium on Principles of Programming Languages (POPL ’15)*. Association for Computing Machinery, New York, NY, USA, 515–526. <https://doi.org/10.1145/2676726.2676993>
- [16] Paul Brunet and Damien Pous. 2015. Petri Automata for Kleene Allegories. In *2015 30th Annual ACM/IEEE Symposium on Logic in Computer Science*. 68–79. <https://doi.org/10.1109/LICS.2015.17>
- [17] Roberto Bruni, Ivan Lanese, and Ugo Montanari. 2006. A Basic Algebra of Stateless Connectors. *Theoretical Computer Science* 366, 1 (Nov. 2006), 98–120. <https://doi.org/10.1016/j.tcs.2006.07.005>
- [18] A. Carboni and R. F. C. Walters. 1987. Cartesian Bicategories I. *Journal of Pure and Applied Algebra* 49, 1 (Nov. 1987), 11–32. [https://doi.org/10.1016/0022-4049\(87\)90121-6](https://doi.org/10.1016/0022-4049(87)90121-6)
- [19] Ashok K. Chandra and Philip M. Merlin. 1977. Optimal Implementation of Conjunctive Queries in Relational Data Bases. In *Proceedings of the Ninth Annual ACM Symposium on Theory of Computing (STOC ’77)*. Association for Computing Machinery, New York, NY, USA, 77–90. <https://doi.org/10.1145/800105.803397>
- [20] Bob Coecke and Ross Duncan. 2008. Interacting Quantum Observables. In *Automata, Languages and Programming (Lecture Notes in Computer Science)*, Luca Aceto, Ivan Damg ard, Leslie Ann Goldberg, Magn us M. Halld rsson, Anna Ing olfssd ttir, and Igor Walukiewicz (Eds.). Springer, Berlin, Heidelberg, 298–310. https://doi.org/10.1007/978-3-540-70583-3_25
- [21] Bob Coecke and Ross Duncan. 2011. Interacting Quantum Observables: Categorical Algebra and Diagrammatics. *New Journal of Physics* 13, 4 (April 2011), 043016. <https://doi.org/10.1088/1367-2630/13/4/043016>
- [22] Bob Coecke and Aleks Kissinger. 2017. *Picturing Quantum Processes: A First Course in Quantum Theory and Diagrammatic Reasoning*. Cambridge University Press. <https://doi.org/10.1017/9781316219317>
- [23] Bob Coecke, John Selby, and Sean Tull. 2018. Two Roads to Classicality. 266 (Feb. 2018), 104–118. <https://doi.org/10.4204/EPTCS.266.7>

- [24] Cole Comfort, Antonin Delpuch, and Jules Hedges. 2020. Sheet Diagrams for Bimonoidal Categories. <https://doi.org/10.48550/arXiv.2010.13361> arXiv:2010.13361 [math]
- [25] Ross Duncan. 2009. Generalised Proof-Nets for Compact Categories with Biproducts. In *Semantics of Quantum Computation*, Simon Gay and Ian Mackie (Eds.). Cambridge University Press.
- [26] Leonardo Bigolli Pisani vulgo Fibonacci. 2020. *Liber Abbaci / editio Enrico Giusti coadiuvante Paolo D'Alessandro* (Olschki ed.). Biblioteca di «Nuncius», Vol. 79. Firenze, Italy.
- [27] Brendan Fong, Paweł Sobociński, and Paolo Rapisarda. 2016. A Categorical Approach to Open and Interconnected Dynamical Systems. In *Proceedings of the 31st Annual ACM/IEEE Symposium on Logic in Computer Science (LICS '16)*. Association for Computing Machinery, New York, NY, USA, 495–504. <https://doi.org/10.1145/2933575.2934556>
- [28] Brendan Fong and David Spivak. 2020. String Diagrams for Regular Logic (Extended Abstract). In *Applied Category Theory 2019 (Electronic Proceedings in Theoretical Computer Science, Vol. 323)*, John Baez and Bob Coecke (Eds.). Open Publishing Association, 196–229. <https://doi.org/10.4204/eptcs.323.14>
- [29] Peter Freyd and Andre Scedrov. 1990. *Categories, Allegories*. North-Holland Mathematical Library, Vol. 39. Elsevier B.V.
- [30] Tobias Fritz. 2009. A Presentation of the Category of Stochastic Matrices. <https://doi.org/10.48550/arXiv.0902.2554> arXiv:0902.2554
- [31] Dan R. Ghica and Achim Jung. 2016. Categorical semantics of digital circuits. In *2016 Formal Methods in Computer-Aided Design (FMCAD)*. 41–48. <https://doi.org/10.1109/FMCAD.2016.7886659>
- [32] John Harding. 2008. Orthomodularity in dagger biproduct categories. *Preprint* (2008). https://www.researchgate.net/publication/228354796_Orthomodularity_in_dagger_biproduct_categories
- [33] Masahito Hasegawa, Martin Hofmann, and Gordon Plotkin. 2008. Finite Dimensional Vector Spaces Are Complete for Traced Symmetric Monoidal Categories. In *Pillars of Computer Science: Essays Dedicated to Boris (Boaz) Trakhtenbrot on the Occasion of His 85th Birthday*, Arnon Avron, Nachum Dershowitz, and Alexander Rabinovich (Eds.). Springer, Berlin, Heidelberg, 367–385. https://doi.org/10.1007/978-3-540-78127-1_20
- [34] Charles A. R. Hoare. 1969. An Axiomatic Basis for Computer Programming. *Commun. ACM* 12, 10 (Oct. 1969), 576–580. <https://doi.org/10.1145/363235.363259>
- [35] Tony Hoare, Bernhard Möller, Georg Struth, and Ian Wehrman. 2011. Concurrent Kleene Algebra and Its Foundations. *The Journal of Logic and Algebraic Programming* 80, 6 (Aug. 2011), 266–296. <https://doi.org/10.1016/j.jlap.2011.04.005>
- [36] Ian Hodkinson and Szabolcs Mikulás. 2000. Axiomatizability of Reducts of Algebras of Relations. *Algebra Universalis* 43, 2 (Aug. 2000), 127–156. <https://doi.org/10.1007/s000120050150>
- [37] Roshan P. James and Amr Sabry. 2012. Information Effects. *ACM SIGPLAN Notices* 47, 1 (Jan. 2012), 73–84. <https://doi.org/10.1145/2103621.2103667>
- [38] Niles Johnson and Donald Yau. 2022. Bimonoidal Categories, E_n -Monoidal Categories, and Algebraic K -Theory. (2022). <https://nilesjohnson.net/En-monoidal.html>
- [39] André Joyal and Ross Street. 1991. The Geometry of Tensor Calculus, I. *Advances in Mathematics* 88, 1 (July 1991), 55–112. [https://doi.org/10.1016/0001-8708\(91\)90003-P](https://doi.org/10.1016/0001-8708(91)90003-P)
- [40] David Kaiser. 2009. *Drawing Theories Apart: The Dispersion of Feynman Diagrams in Postwar Physics*. University of Chicago Press. <https://doi.org/10.7208/9780226422657>
- [41] Tobias Kappé, Paul Brunet, Alexandra Silva, and Fabio Zanasi. 2018. Concurrent Kleene Algebra: Free Model and Completeness. In *Programming Languages and Systems (Lecture Notes in Computer Science)*, Amal Ahmed (Ed.). Springer International Publishing, Cham, 856–882. https://doi.org/10.1007/978-3-319-89884-1_30
- [42] Stephen Lack. 2004. Composing PROPs. *Theory and Application of Categories* 13, 9 (2004), 147–163. <http://www.tac.mta.ca/tac/volumes/13/9/13-09abs.html>
- [43] Yves Lafont. 2003. Towards an Algebraic Theory of Boolean Circuits. *Journal of Pure and Applied Algebra* 184, 2 (Nov. 2003), 257–310. [https://doi.org/10.1016/S0022-4049\(03\)00069-0](https://doi.org/10.1016/S0022-4049(03)00069-0)
- [44] Miguel L. Laplaza. 1972. Coherence for Distributivity. In *Coherence in Categories (Lecture Notes in Mathematics)*, G. M. Kelly, M. Laplaza, G. Lewis, and Saunders Mac Lane (Eds.). Springer, Berlin, Heidelberg, 29–65. <https://doi.org/10.1007/BFb0059555>
- [45] Saunders Mac Lane. 1965. Categorical Algebra. *Bull. Amer. Math. Soc.* 71, 1 (1965), 40–106. <https://doi.org/10.1090/S0002-9904-1965-11234-4>
- [46] S. Mac Lane. 1978. *Categories for the Working Mathematician* (second ed.). Graduate Texts in Mathematics, Vol. 5. Springer-Verlag, New York. <https://www.springer.com/gb/book/9780387984032>
- [47] Paul-André Mellies. 2006. Functorial Boxes in String Diagrams. In *Computer Science Logic (Lecture Notes in Computer Science)*, Zoltán Ésik (Ed.). Springer, Berlin, Heidelberg, 1–30. https://doi.org/10.1007/11874683_1
- [48] Donald Monk. 1964. On representable relation algebras. *Michigan Mathematical Journal* 11, 3 (1964), 207 – 210. <https://doi.org/10.1307/mmj/1028999131>

- [49] Koko Muroya, Steven W. T. Cheung, and Dan R. Ghica. 2018. The Geometry of Computation-Graph Abstraction. In *Proceedings of the 33rd Annual ACM/IEEE Symposium on Logic in Computer Science, LICS 2018, Oxford, UK, July 09-12, 2018*, Anuj Dawar and Erich Grädel (Eds.). ACM, 749–758. <https://doi.org/10.1145/3209108.3209127>
- [50] Roger Penrose. 1971. Applications of Negative Dimensional Tensors. In *Combinatorial Mathematics and Its Applications*, D. J. A. Welsh (Ed.). Academic Press.
- [51] Robin Piedeleu and Fabio Zanasi. 2021. A String Diagrammatic Axiomatisation of Finite-State Automata. In *Foundations of Software Science and Computation Structures (Lecture Notes in Computer Science)*, Stefan Kiefer and Christine Tasson (Eds.). Springer International Publishing, Cham, 469–489. https://doi.org/10.1007/978-3-030-71995-1_24
- [52] Damien Pous. 2018. On the Positive Calculus of Relations with Transitive Closure. In *35th Symposium on Theoretical Aspects of Computer Science, STACS 2018, February 28 to March 3, 2018, Caen, France (LIPIcs, Vol. 96)*, Rolf Niedermeier and Brigitte Vallée (Eds.). Schloss Dagstuhl - Leibniz-Zentrum für Informatik, 3:1–3:16. <https://doi.org/10.4230/LIPIcs.STACS.2018.3>
- [53] Valentin N Redko. 1964. On defining relations for the algebra of regular events. *Ukrainskii Matematicheskii Zhurnal* 16 (1964), 120–126.
- [54] Yehoshua Sagiv and Mihalis Yannakakis. 1980. Equivalences Among Relational Expressions with the Union and Difference Operators. *J. ACM* 27, 4 (Oct. 1980), 633–655. <https://doi.org/10.1145/322217.322221>
- [55] Peter Selinger. 1998. *A Note on Bainbridge’s Power Set Construction*. Technical Report. BRICS, Basic Research in Computer Science, Aarhus, Denmark.
- [56] Peter Selinger. 2010. A survey of graphical languages for monoidal categories. In *New structures for physics*. Springer, 289–355. https://doi.org/10.1007/978-3-642-12821-9_4
- [57] Peter Selinger. 2012. Finite Dimensional Hilbert Spaces Are Complete for Dagger Compact Closed Categories. *Logical Methods in Computer Science* Volume 8, Issue 3 (Aug. 2012). [https://doi.org/10.2168/LMCS-8\(3:6\)2012](https://doi.org/10.2168/LMCS-8(3:6)2012)
- [58] Sam Staton. 2015. Algebraic Effects, Linearity, and Quantum Programming Languages. *ACM SIGPLAN Notices* 50, 1 (Jan. 2015), 395–406. <https://doi.org/10.1145/2775051.2676999>
- [59] Tobias Stollenwerk and Stuart Hadfield. 2022. Diagrammatic Analysis for Parameterized Quantum Circuits. arXiv:2204.01307 [quant-ph] <http://arxiv.org/abs/2204.01307>
- [60] Alfred Tarski. 1941. On the Calculus of Relations. *The Journal of Symbolic Logic* 6, 3 (Sept. 1941), 73–89. <https://doi.org/10.2307/2268577>
- [61] Alexis Toumi, Richie Yeung, and Giovanni de Felice. 2021. Diagrammatic Differentiation for Quantum Machine Learning. In *Proceedings 18th International Conference on Quantum Physics and Logic, QPL 2021, Gdansk, Poland, and online, 7-11 June 2021 (EPTCS, Vol. 343)*, Chris Heunen and Miriam Backens (Eds.). 132–144. <https://doi.org/10.4204/EPTCS.343.7>
- [62] Fabio Zanasi. 2015. *Interacting Hopf Algebras- the Theory of Linear Systems*. Ph.D. Dissertation. Ecole normale supérieure de Lyon - ENS LYON. <https://tel.archives-ouvertes.fr/tel-01218015>
- [63] Chen Zhao and Xiao-Shan Gao. 2021. Analyzing the Barren Plateau Phenomenon in Training Quantum Neural Networks with the ZX-calculus. *Quantum* 5 (June 2021), 466. <https://doi.org/10.22331/q-2021-06-04-466>

A COHERENCE AXIOMS

In this Appendix we collect together various Figures, listing the coherence axioms required by the definition of the algebraic structures we consider in the article.

$$\begin{array}{ccc}
 (X \otimes I) \otimes Y & \xrightarrow{\alpha_{X,I,Y}} & X \otimes (1 \otimes Y) \\
 \searrow \rho_X \otimes id_Y & & \swarrow id_X \otimes \lambda_Y \\
 & X \otimes Y &
 \end{array} \tag{M1}$$

$$\begin{array}{ccc}
 & (X \otimes Y) \otimes (Z \otimes W) & \\
 \alpha_{X \otimes Y, Z, W} \nearrow & & \searrow \alpha_{X, Y, Z \otimes W} \\
 ((X \otimes Y) \otimes Z) \otimes W & & X \otimes (Y \otimes (Z \otimes W)) \\
 \alpha_{X, Y, Z} \otimes id_W \downarrow & & \uparrow id_X \otimes \alpha_{Y, Z, W} \\
 (X \otimes (Y \otimes Z)) \otimes W & \xrightarrow{\alpha_{X, Y \otimes Z, W}} & X \otimes ((Y \otimes Z) \otimes W)
 \end{array} \tag{M2}$$

Fig. 4. Coherence axioms of monoidal categories

$$\begin{array}{ccc}
 X \otimes Y & \xrightarrow{\sigma_{X,Y}} & Y \otimes X \\
 \parallel & & \downarrow \sigma_{Y,X} \\
 & & X \otimes Y
 \end{array} \tag{S1}$$

$$\begin{array}{ccc}
 X \otimes I & \xrightarrow{\sigma_{X,I}} & I \otimes X \\
 \rho_X \downarrow & & \downarrow \lambda_X \\
 X & \xlongequal{\quad} & X
 \end{array} \tag{S2}$$

$$\begin{array}{ccc}
 & X \otimes (Y \otimes Z) \xrightarrow{id_X \otimes \sigma_{Y,Z}} X \otimes (Z \otimes Y) & \\
 \alpha_{X,Y,Z} \nearrow & & \searrow \alpha_{X,Z,Y}^- \\
 (X \otimes Y) \otimes Z & & (X \otimes Z) \otimes Y \\
 \sigma_{X \otimes Y, Z} \searrow & & \nearrow \sigma_{Z, X} \otimes id_Y \\
 & Z \otimes (X \otimes Y) \xrightarrow{\alpha_{Z, X, Y}^-} (Z \otimes X) \otimes Y &
 \end{array} \tag{S3}$$

Fig. 5. Coherence axioms of symmetric monoidal categories

$$\begin{array}{ccc}
 X \otimes Y & \xrightarrow{\triangleleft_{X \otimes Y}} & (X \otimes Y) \otimes (X \otimes Y) \\
 \triangleleft_{X \otimes Y} \downarrow & & \uparrow \alpha_{X,Y,X \otimes Y}^- \\
 (X \otimes Y) \otimes (Y \otimes Y) & & \\
 \alpha_{X,X,Y \otimes Y} \downarrow & & \\
 X \otimes (X \otimes (Y \otimes Y)) & & X \otimes (Y \otimes (X \otimes Y)) \\
 id_X \otimes \alpha_{X,Y,Y}^- \downarrow & & \uparrow id_X \otimes \alpha_{Y,X,Y} \\
 X \otimes ((X \otimes Y) \otimes Y) & \xrightarrow{id_X \otimes (\sigma_{X,Y} \otimes id_Y)} & X \otimes ((Y \otimes X) \otimes Y)
 \end{array} \tag{FP1}$$

$$\begin{array}{ccc}
 X \otimes Y & \xrightarrow{\hat{\imath}_{X \otimes Y}} & I \\
 \hat{\imath}_X \otimes \hat{\imath}_Y \downarrow & \nearrow \lambda_I & \\
 I \otimes I & &
 \end{array} \tag{FP2}$$

$$I \xrightleftharpoons[\lambda_I^-]{\triangleleft_I} I \otimes I \tag{FP3}$$

$$I \xrightleftharpoons[id_I]{\hat{\imath}_I} I \tag{FP4}$$

$$\begin{array}{ccc}
 (X \otimes Y) \otimes (X \otimes Y) & \xrightarrow{\triangleright_{X \otimes Y}} & X \otimes Y \\
 \alpha_{X,Y,X \otimes Y} \downarrow & & \uparrow \triangleright_{X \otimes Y} \\
 X \otimes (Y \otimes (X \otimes Y)) & & (X \otimes X) \otimes (Y \otimes Y) \\
 \alpha_{X,X,Y \otimes Y}^- \uparrow & & \uparrow \alpha_{X,X,Y \otimes Y}^- \\
 X \otimes (X \otimes (Y \otimes Y)) & & \\
 id_X \otimes \alpha_{Y,X,Y}^- \downarrow & & \uparrow id_X \otimes \alpha_{X,Y,Y} \\
 X \otimes ((Y \otimes X) \otimes Y) & \xrightarrow{id_X \otimes (\sigma_{Y,X} \otimes id_Y)} & X \otimes ((X \otimes Y) \otimes Y)
 \end{array} \tag{FC1}$$

$$\begin{array}{ccc}
 I & \xrightarrow{\hat{\jmath}_{X \otimes Y}} & X \otimes Y \\
 \lambda_I^- \downarrow & \nearrow \hat{\jmath}_X \otimes \hat{\jmath}_Y & \\
 I \otimes I & &
 \end{array} \tag{FC2}$$

$$I \otimes I \xrightleftharpoons[\lambda_I]{\triangleright_I} I \tag{FC3}$$

$$I \xrightleftharpoons[id_I]{\hat{\jmath}_I} I \tag{FC4}$$

Fig. 6. Coherence axioms for (co)commutative (co)monoids

$$\begin{array}{ccc}
 \begin{array}{ccc}
 (X \oplus Y)Z \xrightarrow{\delta_{X,Y,Z}^r} XZ \oplus YZ \\
 \sigma_{X \oplus Y, Z}^{\otimes} \downarrow & & \downarrow \sigma_{X,Z}^{\otimes} \oplus \sigma_{Y,Z}^{\otimes} \\
 Z(X \oplus Y) \xrightarrow{\delta_{Z,X,Y}^l} ZX \oplus ZY
 \end{array} & \text{(R1)} & \\
 \end{array}
 \qquad
 \begin{array}{ccc}
 (X \oplus Y)Z \xrightarrow{\delta_{X,Y,Z}^r} XZ \oplus YZ \\
 \sigma_{X,Y}^{\otimes} \otimes id_Z \downarrow & & \downarrow \sigma_{XZ,YZ}^{\otimes} \\
 (Y \oplus X)Z \xrightarrow{\delta_{Y,X,Z}^r} YZ \oplus XZ
 \end{array}
 \text{(R2)}$$

$$\begin{array}{ccc}
 ((X \oplus Y) \oplus Z)W \xrightarrow{\delta_{X \oplus Y, Z, W}^r} (X \oplus Y)W \oplus ZW \xrightarrow{\delta_{X,Y,W}^r \otimes id_{ZW}} (XW \oplus YW) \oplus ZW \\
 \alpha_{X,Y,Z}^{\otimes} \otimes id_W \downarrow & & \downarrow \alpha_{XW,YW,ZW}^{\otimes} \\
 (X \oplus (Y \oplus Z))W \xrightarrow{\delta_{X,Y \oplus Z, W}^r} XW \oplus (Y \oplus Z)W \xrightarrow{id_{XW} \otimes \delta_{Y,Z,W}^r} XW \oplus (YW \oplus ZW)
 \end{array}
 \text{(R3)}$$

$$\begin{array}{ccc}
 ((X \oplus Y)Z)W \xrightarrow{\delta_{X,Y,Z}^r \otimes id_W} (XZ \oplus YZ)W \xrightarrow{\delta_{XZ,YZ,W}^r} (XZ)W \oplus (YZ)W \\
 \alpha_{X \oplus Y, Z, W}^{\otimes} \downarrow & & \downarrow \alpha_{X,Z,W}^{\otimes} \oplus \alpha_{Y,Z,W}^{\otimes} \\
 (X \oplus Y)(ZW) \xrightarrow{\delta_{X,Y,Z,W}^r} X(ZW) \oplus Y(ZW)
 \end{array}
 \text{(R4)}$$

$$\begin{array}{ccc}
 (X \oplus Y)(Z \oplus W) \xrightarrow{\delta_{X,Y,Z \oplus W}^r} X(Z \oplus W) \oplus Y(Z \oplus W) \\
 \delta_{X \oplus Y, Z, W}^l \downarrow & & \downarrow \delta_{X,Z,W}^l \oplus \delta_{Y,Z,W}^l \\
 (X \oplus Y)Z \oplus (X \oplus Y)W & & (XZ \oplus XW) \oplus (YZ \oplus YW) \\
 \delta_{X,Y,Z}^r \oplus \delta_{X,Y,W}^r \downarrow & & \downarrow \alpha_{XZ,XW,YZ,YW}^{\otimes} \\
 (XZ \oplus YZ) \oplus (XW \oplus YW) & & XZ \oplus (XW \oplus (YZ \oplus YW)) \\
 \alpha_{XZ,YZ,XW,YW}^{\otimes} \downarrow & & \downarrow id_{XZ} \oplus \alpha_{XW,YZ,YW}^{\otimes} \\
 XZ \oplus (YZ \oplus (XW \oplus YW)) & & XZ \oplus ((XW \oplus YZ) \oplus YW) \\
 id_{XZ} \oplus \alpha_{YZ,XW,YW}^{\otimes} \downarrow & & \downarrow id_{XZ} \oplus (\sigma_{XW,YZ}^{\otimes} \oplus id_{YW}) \\
 XZ \oplus ((YZ \oplus XW) \oplus YW) & \equiv & XZ \oplus ((YZ \oplus XW) \oplus YW)
 \end{array}
 \text{(R5)}$$

$$0 \otimes 0 \xrightarrow[\rho_0^*]{\lambda_0^*} 0 \text{ (R6)} \qquad
 \begin{array}{ccc}
 (X \oplus Y)0 \xrightarrow{\delta_{X,Y,0}^r} X0 \oplus Y0 \\
 \rho_{X \oplus Y}^* \downarrow & & \downarrow \rho_X^* \oplus \rho_Y^* \\
 0 & \xleftarrow{\lambda_0^{\otimes}} & 0 \oplus 0
 \end{array}
 \text{(R7)} \qquad
 0 \otimes 1 \xrightarrow[\rho_0^{\otimes}]{\lambda_1^*} 0 \text{ (R8)}$$

$$\begin{array}{ccc}
 X \otimes 0 \xrightarrow{\sigma_{X,0}^{\otimes}} 0 \otimes X \\
 \rho_X^* \searrow & & \swarrow \lambda_X^* \\
 & 0 &
 \end{array}
 \text{(R9)}$$

$$\begin{array}{ccc}
 (XY)0 \xrightarrow{\alpha_{X,Y,0}^{\otimes}} X(Y0) \\
 \rho_{XY}^* \downarrow & & \downarrow id_X \otimes \rho_Y^* \\
 0 & \xleftarrow{\rho_X^*} & X0
 \end{array}
 \text{(R10)}$$

$$\begin{array}{ccc}
 (0 \oplus X)Y \xrightarrow{\delta_{0,X,Y}^r} 0Y \oplus XY \\
 \lambda_X^{\otimes} \otimes id_Y \downarrow & & \downarrow \lambda_Y^* \otimes id_{XY} \\
 XY & \xleftarrow{\lambda_{XY}^{\otimes}} & 0 \oplus XY
 \end{array}
 \text{(R11)}$$

$$\begin{array}{ccc}
 (X \oplus Y)1 \xrightarrow{\delta_{X,Y,1}^r} X1 \oplus Y1 \\
 \rho_{X \oplus Y}^{\otimes} \searrow & & \swarrow \rho_X^{\otimes} \oplus \rho_Y^{\otimes} \\
 & X \oplus Y &
 \end{array}
 \text{(R12)}$$

Fig. 7. Coherence Axioms of symmetric rig categories

$$\begin{array}{ccc}
 X(Y \oplus Z) & \xrightarrow{\delta_{X,Y,Z}^l} & XY \oplus XZ \\
 id_X \otimes \sigma_{Y,Z}^\oplus \downarrow & & \downarrow \sigma_{XY,XZ}^\oplus \\
 X(Z \oplus Y) & \xrightarrow{\delta_{X,Z,Y}^l} & XZ \oplus XY
 \end{array} \quad (23)$$

$$\begin{array}{ccc}
 X[(Y \oplus Z) \oplus W] & \xrightarrow{\delta_{X,Y \oplus Z,W}^l} & X(Y \oplus Z) \oplus XW & \xrightarrow{\delta_{X,Y,Z \oplus XW}^l} & (XY \oplus XZ) \oplus XW \\
 id_X \otimes \alpha_{Y,Z,W}^\oplus \downarrow & & & & \downarrow \alpha_{XY,XZ,XW}^\oplus \\
 X[Y \oplus (Z \oplus W)] & \xrightarrow{\delta_{X,Y,Z \oplus W}^l} & XY \oplus X(Z \oplus W) & \xrightarrow{id_{XY} \oplus \delta_{X,Z,W}^l} & XY \oplus (XZ \oplus XW)
 \end{array} \quad (24)$$

$$\begin{array}{ccc}
 (XY)(Z \oplus W) & \xrightarrow{\delta_{XY,Z,W}^l} & (XY)Z \oplus (XY)W \\
 \alpha_{X,Y,Z \oplus W}^\oplus \downarrow & & \downarrow \alpha_{X,Y,Z}^\oplus \oplus \alpha_{X,Y,W}^\oplus \\
 X(Y(Z \oplus W)) & \xrightarrow{id_X \otimes \delta_{Y,Z,W}^l} & X(YZ \oplus YW) & \xrightarrow{\delta_{X,YZ,YW}^l} & X(YZ) \oplus X(YW)
 \end{array} \quad (25)$$

$$\begin{array}{ccc}
 0(X \oplus Y) & \xrightarrow{\delta_{0,X,Y}^l} & 0X \oplus 0Y \\
 \lambda_{X \oplus Y}^\bullet \downarrow & & \downarrow \lambda_X^\bullet \oplus \lambda_Y^\bullet \\
 0 & \xleftarrow{\lambda_0^\oplus} & 0 \oplus 0
 \end{array} \quad (26)$$

$$\begin{array}{ccc}
 X(0 \oplus Y) & \xrightarrow{\delta_{X,0,Y}^l} & X0 \oplus XY \\
 id_X \otimes \lambda_Y^\oplus \downarrow & & \downarrow \rho_X^\oplus \otimes id_{XY} \\
 XY & \xleftarrow{\lambda_{XY}^\oplus} & 0 \oplus XY
 \end{array} \quad (27)$$

$$\begin{array}{ccc}
 X(Y \oplus 0) & \xrightarrow{\delta_{X,Y,0}^l} & XY \oplus X0 \\
 id_X \otimes \rho_Y^\oplus \downarrow & & \downarrow id_{XY} \oplus \rho_X^\oplus \\
 XY & \xleftarrow{\rho_{XY}^\oplus} & XY \oplus 0
 \end{array} \quad (28)$$

$$\begin{array}{ccc}
 (X \oplus 0)Y & \xrightarrow{\delta_{X,0,Y}^r} & XY \oplus 0Y \\
 \rho_X^\oplus \otimes id_Y \downarrow & & \downarrow id_{XY} \oplus \lambda_Y^\bullet \\
 XY & \xleftarrow{\rho_{XY}^\oplus} & XY \oplus 0
 \end{array} \quad (29)$$

$$\begin{array}{ccc}
 1(X \oplus Y) & \xrightarrow{\delta_{1,X,Y}^l} & 1X \oplus 1Y \\
 \lambda_{X \oplus Y}^\oplus \searrow & & \swarrow \lambda_X^\oplus \oplus \lambda_Y^\oplus \\
 & & X \oplus Y
 \end{array} \quad (30)$$

Fig. 8. Derived laws of symmetric rig categories

B ADDITIONAL FIGURES

In this Appendix we provide some additional figures representing useful/interesting axioms and derivations.

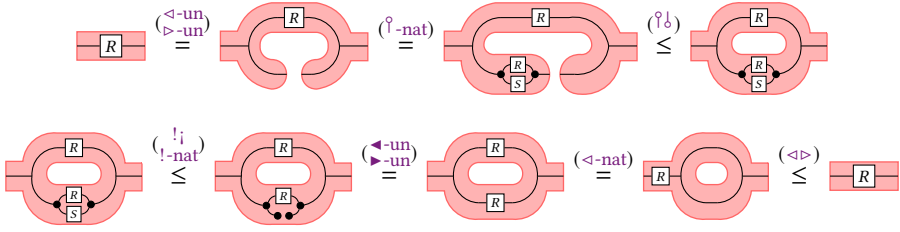

Fig. 9. Graphical proof for $R \cup (R \cap S) \equiv_{CR} R$

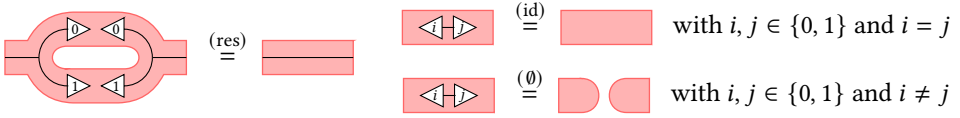

Fig. 10. The axioms above are a graphical rendering of the necessary and sufficient conditions for $|0\rangle$ and $|1\rangle$ to form an orthonormal basis (see [22, Theorem 5.32]). In particular, axiom (id) asserts that the basis vectors have norm 1, while (\emptyset) says that they are orthogonal to each other.



Fig. 11. The axiom of GPLA [9] on the left expresses the totality of an ordering relation \leq . Within tape diagrams the same axiom can be rendered completely graphically as shown on the right.

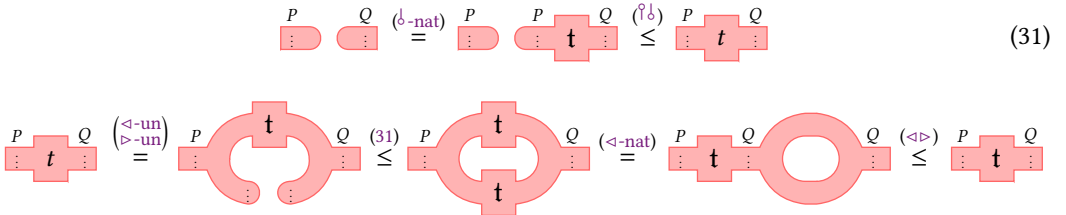
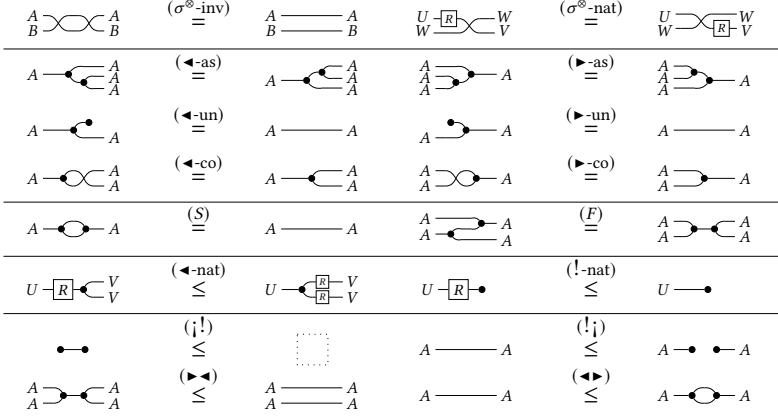

Fig. 12. Graphical derivation proving that with the axioms in Figure 2 \mathbf{t} becomes idempotent with \mathbf{o} as bottom element

 Fig. 13. Axioms of CB_Σ

C APPENDIX TO SECTION 3

In this Appendix we show how Definition 3.4 is equivalent to the more standard definition of a category with finite biproducts.

Traditionally a category \mathbf{C} with a zero object 0 is said to have finite biproducts if for every pair of objects X_1 and X_2 there exists a third object $X_1 \oplus X_2$ and morphisms $\pi_i: X_1 \oplus X_2 \rightarrow X_i$, $\mu_i: X_i \rightarrow X_1 \oplus X_2$ such that $(X_1 \oplus X_2, \pi_1, \pi_2)$ is a product, $(X_1 \oplus X_2, \mu_1, \mu_2)$ is a coproduct and

$$\mu_i; \pi_j = \delta_{i,j}$$

where $\delta_{i,j} = id_{X_i}$ if $i = j$, otherwise $\delta_{i,j} = 0_{X_i, X_j}$ (i.e. $\overset{\circ}{\rho}_{X_i}; \overset{\circ}{\rho}_{X_j}$). This is consistent with Definition 3.4, as we show now.

For any two objects X_1, X_2 of a fb-category \mathbf{C} , $X_1 \odot X_2$ is the categorical product $X_1 \times X_2$: the projections $\pi_1: X_1 \odot X_2 \rightarrow X_1$ and $\pi_2: X_1 \odot X_2 \rightarrow X_2$ are

$$X_1 \odot X_2 \xrightarrow{id_{X_1} \odot \overset{\circ}{\rho}_{X_2}} X_1 \odot I \xrightarrow{\rho_{X_1}} X_1 \quad \text{and} \quad X_1 \odot X_2 \xrightarrow{\overset{\circ}{\rho}_{X_1} \odot id_{X_2}} I \odot X_2 \xrightarrow{\lambda_{X_2}} X_2.$$

The unit I is the terminal object and $\overset{\circ}{\rho}_X$ the unique morphism of type $X \rightarrow I$. For $f_1: Y \rightarrow X_1$, $f_2: Y \rightarrow X_2$, their pairing $\langle f_1, f_2 \rangle: Y \rightarrow X_1 \odot X_2$ is given by

$$Y \xrightarrow{\triangleleft_Y} Y \odot Y \xrightarrow{f_1 \odot f_2} X_1 \odot X_2.$$

$X_1 \odot X_2$ is also a categorical coproduct, with injections $\mu_i: X_i \rightarrow X_1 \odot X_2$ and copairing $[f_1, f_2]: X_1 \odot X_2 \rightarrow Y$, for $f_1: X_1 \rightarrow Y$ and $f_2: X_2 \rightarrow Y$, in the dual way. Also dually I is the initial object and $\overset{\circ}{\rho}_X$ the unique morphism of type $I \rightarrow X$.

Hence I is a zero object and $\overset{\circ}{\rho}_X; \overset{\circ}{\rho}_Y: X \rightarrow Y$ is a zero morphism. Also the third requirement $\mu_i; \pi_j = \delta_{i,j}$ holds. Indeed,

PROOF. We prove the first item by induction on U .

Case $U = 1$: $\delta_{1,Y,Z}^l \stackrel{(30)}{=} id_{Y \oplus Z}$.

Case $U = H(A)U'$:

$$\begin{aligned} \delta_{H(A)U',Y,Z}^l &= (id_{H(A)} \otimes \delta_{U',Y,Z}^l); \delta_{H(A),U'Y,U'Z}^l & (25) \\ &= (id_{H(A)} \otimes id_{U'Y \oplus U'Z}); id_{H(A)U'Y \oplus H(A)U'Z} & (\text{Ind. hp., sesquistrictness}) \\ &= id_{H(A)U'Y \oplus H(A)U'Z} \end{aligned}$$

We prove the second point by induction on Y .

Case $Y = 0$: it follows from axiom (R9).

Case $Y = U \oplus Y'$: Let $Y' = \bigoplus_{i'} U'_{i'}$

$$\begin{aligned} \sigma_{U \oplus Y',V}^{\otimes} &= (\sigma_{U,V}^{\otimes} \oplus \sigma_{Y',V}^{\otimes}); \delta_{V,U,Y'}^{-l} & (R1) \\ &= \sigma_{U,V}^{\otimes} \oplus \sigma_{Y',V}^{\otimes} & (\text{Lemma D.3.1}) \\ &= \sigma_{U,V}^{\otimes} \oplus \bigoplus_{i'} \sigma_{U'_{i'},V}^{\otimes} & (\text{Ind. hp.}) \end{aligned}$$

□

The following useful result is an immediate consequence of Proposition D.1 and Lemma D.3.

Lemma D.4. *Let $H: \mathbf{M} \rightarrow \mathbf{D}$ be a sesquistrict fb rig category, U a monomial and Y a polynomial. Then:*

- (1) $id_U \otimes \triangleleft_Y = \triangleleft_{UY} = \triangleleft_U \otimes id_Y$.
- (2) $id_U \otimes \uparrow_Y = \uparrow_{UY} = \uparrow_U \otimes id_Y$.
- (3) $id_U \otimes \triangleright_Y = \triangleright_{UY} = \triangleright_U \otimes id_Y$.
- (4) $id_U \otimes \downarrow_Y = \downarrow_{UY} = \downarrow_U \otimes id_Y$.

D.2 Proofs of Section 4

PROOF OF THEOREM 4.4. We recall from [38] some facts regarding the strictification $\bar{\mathbf{C}}$ of \mathbf{C} .

Let $P = \bigoplus_{i=1}^r U_i$ and $Q = \bigoplus_{j=1}^s V_j$ be objects of $\bar{\mathbf{C}}$ (the U_i 's and V_j 's are words of objects of \mathbf{C}). Then $P \otimes Q$ is given as in (8) and it is immediate to see that $A \otimes (P \oplus Q) = (A \otimes P) \oplus (A \otimes Q)$ when $A \in \text{Ob}(\mathbf{C})$. We need to show that $id_{A \otimes (P \oplus Q)} = \delta_{A,P,Q}^l$ in $\bar{\mathbf{C}}$.

In $\bar{\mathbf{C}}$, the left distributor $\delta_{S,P,Q}^l: S \otimes (P \oplus Q) \rightarrow (S \otimes P) \oplus (S \otimes Q)$ is defined as

$$\begin{array}{ccc} S \otimes (P \oplus Q) & \xrightarrow{\delta_{S,P,Q}^l} & (S \otimes P) \oplus (S \otimes Q) \\ \sigma_{S,P \oplus Q}^{\otimes} \downarrow & & \uparrow \sigma_{P,S}^{\otimes} \oplus \sigma_{Q,S}^{\otimes} \\ (P \oplus Q) \otimes S & \xrightarrow{id} & (P \otimes S) \oplus (Q \otimes S) \end{array} \quad (\text{in } \bar{\mathbf{C}})$$

where the symmetry $\sigma_{R,T}^{\otimes}: R \otimes T \rightarrow T \otimes R$ in $\bar{\mathbf{C}}$ is defined as the following composite in \mathbf{C} :

$$\begin{array}{ccc} \pi(R \otimes T) & \xrightarrow{\sigma_{R,T}^{\otimes}} & \pi(T \otimes R) \\ \cong_{Lap}^{-1} \downarrow & & \uparrow \cong_{Lap} \\ \pi(R) \otimes \pi(T) & \xrightarrow{\sigma_{\pi(R),\pi(T)}^{\otimes}} & \pi(T) \otimes \pi(R) \end{array}$$

The arrow \cong_{Lap} is the isomorphism built up using the structure of rig category whose existence and uniqueness is guaranteed by the coherence theorem for rig categories [38, 44].

In order to prove that $id_{A \otimes (P \oplus Q)} = \delta_{A,P,Q}^l$ in $\overline{\mathbf{C}}$, we will use the coherence theorem for rig categories as formulated in [38]. Suppose that $U_i = B_1^i \dots B_{n_i}^i$ and $V_j = C_1^j \dots C_{m_j}^j$. Now, we have that $\pi(A \otimes (P \oplus Q))$ is the right bracketing of the following object of \mathbf{C} :

$$\bigoplus_{i=1}^r \bigotimes_{k=1}^{n_i} (A \otimes B_k^i) \oplus \bigoplus_{j=1}^m \bigotimes_{k=1}^{m_j} (A \otimes C_k^j)$$

This object, as a term of the free $\{\oplus, \otimes\}$ -algebra generated by the set

$$X = \{A, B_1^1, \dots, B_{n_1}^1, \dots, B_1^r, \dots, B_{n_r}^r, C_1^1, \dots, C_{m_1}^1, \dots, C_1^s, \dots, C_{m_s}^s, 0^X, 1^X\},$$

is *regular* in the sense of [38, Definition 3.1.25]. Indeed, for every i the factors $A, B_1^i, \dots, B_{n_i}^i$ are all distinct elements of X , and similarly for every j the factors $A, C_1^j, \dots, C_{m_j}^j$ are all distinct elements of X ; moreover, all the $r + s$ addends $\bigotimes_{k=1}^{n_i} (A \otimes B_k^i)$ and $\bigotimes_{k=1}^{m_j} (A \otimes C_k^j)$ are all pairwise distinct elements of the free $\{\oplus, \otimes\}$ -algebra on X . Hence, by the coherence theorem for rig categories, as stated in Theorem 3.9.1 of [38], there exists a unique isomorphism, built up using instances of the natural isomorphisms given by the structure of rig category and involving only the objects in X , from $\pi(A \otimes (P \oplus Q))$ to itself. Since $id_{A \otimes (P \oplus Q)}$ and $\delta_{A,P,Q}^l$ are two such structural isomorphisms, they must coincide. \square

PROOF OF LEMMA 4.6. Simply postcompose F with the two functors $\overline{\mathbf{D}} \rightarrow \mathbf{D} \rightarrow \overline{\mathbf{D}}$ that make the equivalence $\mathbf{D} \simeq \overline{\mathbf{D}}$. \square

PROOF OF THEOREM 4.9. Let Σ be a rig signature and let s be a generator in Σ , say

$$s: \bigoplus_{i=1}^{n_s} U_i \rightarrow \bigoplus_{j=1}^{m_s} V_j$$

where U_i, V_j are monomials for $i = 1 \dots n_s$ and $j = 1 \dots m_s$. For each (i, j) , we define a new generator

$$s_{j,i}: U_i \rightarrow V_j$$

having as arity the monomial U_i and as coarity the monomial V_j . These $s_{j,i}$'s are now formal symbols that we use to define a signature Σ_M , obtained from Σ by replacing each $s \in \Sigma$ with all the $s_{j,i}$'s:

$$\Sigma_M \stackrel{\text{def}}{=} \{s_{j,i} \mid s \in \Sigma, j = 1 \dots m_s, i = 1 \dots n_s\}.$$

Observe that Σ_M is a monoidal signature since it only contains symbols having as arity and coarity some monomials.

For example, assume that Σ consists of a single generator $s: AB \oplus C \rightarrow A \oplus B \oplus C$ depicted as follows:

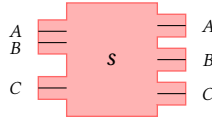

Then Σ_M is the signature consisting of the following six generators:

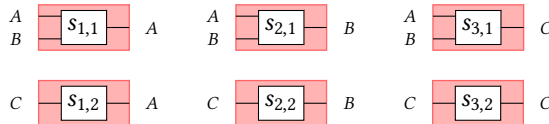

Now, call ssR_Σ^b and $\text{ssR}_{\Sigma_M}^b$ the free sesquistrict fb rig categories generated, respectively, by Σ and Σ_M . We show that there is an isomorphism of rig categories

$$\begin{array}{ccc} & \xrightarrow{F} & \\ \text{ssR}_\Sigma^b & & \text{ssR}_{\Sigma_M}^b \\ & \xleftarrow{G} & \end{array}$$

The functor F is the unique strict fb-rig functor mapping every $s \in \Sigma$ with arity $\bigoplus_{i=1}^n U_i$ and coarity $\bigoplus_{j=1}^m V_j$ into

$$\bigoplus_{i=1}^n U_i \xrightarrow{\triangleleft_{\bigoplus_{i=1}^n U_i}} \bigoplus_{i=1}^n \bigoplus_{j=1}^m U_i \xrightarrow{\bigoplus_{i=1}^n \bigoplus_{j=1}^m s_{ji}} \bigoplus_{i=1}^n \bigoplus_{j=1}^m V_j \xrightarrow{\triangleright_{\bigoplus_{j=1}^m V_j}} \bigoplus_{j=1}^m V_j$$

Similarly, the functor G is the unique strict fb-rig functor mapping every $s_{ji} \in \Sigma_M$ into

$$U_i \xrightarrow{\mu_i} \bigoplus_{i=1}^n U_i \xrightarrow{s} \bigoplus_{j=1}^m V_j \xrightarrow{\pi_j} V_j$$

To prove that $GF = \text{Id}_{\text{ssR}_\Sigma^b}$, it is enough to check that $GF(s) = s$. Since G preserves the finite biproduct rig structure, it holds that $GF(s)$ is

$$\bigoplus_{i=1}^n U_i \xrightarrow{\triangleleft_{\bigoplus_{i=1}^n U_i}} \bigoplus_{i=1}^n \bigoplus_{j=1}^m U_i \xrightarrow{\bigoplus_{i=1}^n \bigoplus_{j=1}^m G(s_{ji})} \bigoplus_{i=1}^n \bigoplus_{j=1}^m V_j \xrightarrow{\triangleright_{\bigoplus_{j=1}^m V_j}} \bigoplus_{j=1}^m V_j$$

which, by Proposition F.4, is exactly s .

To prove that $FG(s_{ji}) = s_{ji}$, just observe that $FG(s_{ji})$ is the upper leg of the following diagram:

$$\begin{array}{ccccc} & & \bigoplus_{h=1}^n \bigoplus_{k=1}^m U_h & \xrightarrow{\bigoplus_{h=1}^n \bigoplus_{k=1}^m s_{kh}} & \bigoplus_{h=1}^n \bigoplus_{k=1}^m V_k \\ & \nearrow \triangleleft_{\bigoplus_{h=1}^n U_h} & \uparrow \mu_i & & \uparrow \mu_i \\ & \bigoplus_{h=1}^n U_h & \bigoplus_{k=1}^m U_i & \xrightarrow{\bigoplus_{k=1}^m s_{ki}} & \bigoplus_{k=1}^m V_k \\ & \nearrow \triangleleft_{\bigoplus_{h=1}^n U_h} & \downarrow \pi_j & & \downarrow \pi_j \\ U_i & \xrightarrow{id} & U_i & \xrightarrow{s_{ji}} & V_j \\ & \searrow \mu_i & & & \searrow \pi_j \\ & & & & \bigoplus_{k=1}^m V_k \\ & & & & \downarrow \pi_j \\ & & & & V_j \end{array}$$

which commutes because of the naturality of the injections and the projections for the biproduct \oplus , as well as the universal property of $\triangleright_{\bigoplus_k V_k}^n$ as the copairing of n copies of $\text{id}_{\bigoplus_k V_k}$ (in the top-right triangle). \square

E APPENDIX TO SECTION 5

In this Appendix we study, in detail, the properties of \otimes_{T_Σ} . It is divided in four subsections. In Section E.1 we state and prove several properties of the distributors and the symmetries (Lemma E.1 and E.2). In Section E.2 we present some additional lemmas for monomial whiskerings (Lemma E.3 and E.4), which are needed to prove, in Section E.3, the 17 equations stated in Table 5: the algebra of

whiskerings. Finally, in Section E.4 we prove the remaining results that were claimed in Section 5, namely Theorems 5.10, 5.11, 5.15 and Corollary 5.12.

E.1 Properties of distributors and symmetries in T_Σ

The following lemma provides a sanity check for our inductive definitions.

Lemma E.1. *For all P, P', Q, R , monomials U, V the followings hold:*

- (1) $\delta_{U,Q,R}^l = id_{U(Q \oplus R)}$
- (2) $\delta_{P \oplus P', Q, R}^l = (\delta_{P,Q,R}^l \oplus \delta_{P',Q,R}^l); (id_{PQ} \oplus \sigma_{PR,P'Q}^\oplus \oplus id_{P'R})$
- (3) $\delta_{P,0,R}^l = id_{PR}$
- (4) $\delta_{P,Q,0}^l = id_{PQ}$
- (5) $\sigma_{P,Q}^\otimes; \sigma_{Q,P}^\otimes = id_{PQ}$
- (6) $\sigma_{P,Q \oplus R}^\otimes = \delta_{P,Q,R}^l; (\sigma_{P,Q}^\otimes \oplus \sigma_{P,R}^\otimes)$
- (7) $\sigma_{P,1}^\otimes = id_P$
- (8) $\sigma_{P,V}^\otimes = \bigoplus_i \overline{\sigma_{U_i,V}}$ for $P = \bigoplus_i U_i$. In particular $\sigma_{U,V}^\otimes = \overline{\sigma_{U,V}}$.

PROOF OF LEMMA E.1.1. It holds by definition of δ^l . □

PROOF OF LEMMA E.1.2. We prove that $\delta_{P \oplus P', Q, R}^l = (\delta_{P,Q,R}^l \oplus \delta_{P',Q,R}^l); (id_{PQ} \oplus \sigma_{PR,P'Q}^\oplus \oplus id_{P'R})$ by induction on P .

Case $P = 0$: it holds by definition of δ^l .

Case $P = U \oplus P''$:

$$\begin{aligned} \delta_{U \oplus P'' \oplus P', Q, R}^l &= \delta_{U \oplus (P'' \oplus P'), Q, R}^l \\ &= (id_{U(Q \oplus R)} \oplus \delta_{P'' \oplus P', Q, R}^l); (id_{UQ} \oplus \sigma_{UR, P''Q \oplus P'Q}^\oplus \oplus id_{P''R \oplus P'R}) \end{aligned} \quad (\text{Def. } \delta^l)$$

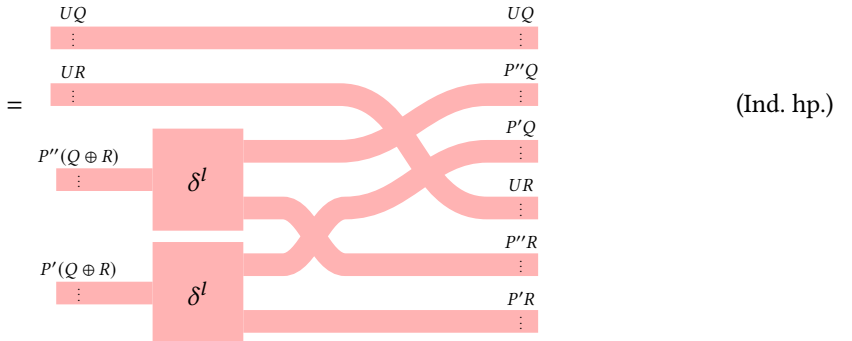
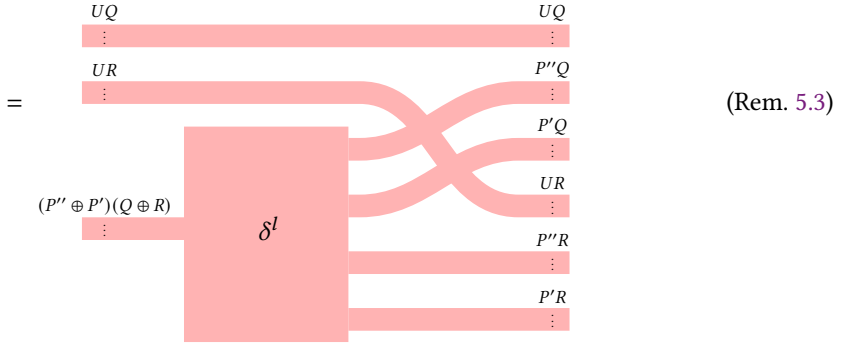

$$\begin{aligned}
 & \begin{array}{ccc}
 UQ & & UQ \\
 \vdots & \text{---} & \vdots \\
 UR & & P''Q \\
 \vdots & & \vdots \\
 P''(Q \oplus R) & \begin{array}{c} \delta^l \\ \square \end{array} & \begin{array}{c} P'Q \\ \vdots \\ UR \\ \vdots \\ P''R \\ \vdots \\ P'R \end{array} \\
 \vdots & & \vdots \\
 P'(Q \oplus R) & \begin{array}{c} \delta^l \\ \square \end{array} & \vdots \\
 \vdots & & \vdots
 \end{array}
 \end{array} \quad (\text{Funct. } \oplus)$$

$$\begin{aligned}
 & = (((id_{U(Q \oplus R)} \oplus \delta_{P'',Q,R}^l); (id_{UQ} \oplus \sigma_{UR,P''Q}^\oplus \oplus id_{P''R})) \oplus \delta_{P',Q,R}^l); \\
 & \quad (id_{UQ \oplus P''Q} \oplus \sigma_{UR \oplus P''R, P'Q}^\oplus \oplus id_{P'R}) \\
 & = (\delta_{U \oplus P'',Q,R}^l \oplus \delta_{P',Q,R}^l); (id_{UQ \oplus P''Q} \oplus \sigma_{UR \oplus P''R, P'Q}^\oplus \oplus id_{P'R}) \quad (\text{Def. } \delta^l)
 \end{aligned}$$

□

PROOF OF LEMMA E.1.3. We prove that $\delta_{P,0,R}^l = id_{PR}$ by induction on P .

Case $P = 0$: it holds by definition of δ^l .

Case $P = U \oplus P'$:

$$\begin{aligned}
 \delta_{U \oplus P',0,R}^l & = (id_{U(0 \oplus R)} \oplus \delta_{P',0,R}^l); (id_{U0} \oplus \sigma_{UR,P'0}^\oplus \oplus id_{P'R}) & (\text{Def. } \delta^l) \\
 & = (id_{UR} \oplus id_{P'R}); (id_0 \oplus \sigma_{UR,0}^\oplus \oplus id_{P'R}) & (\text{Ind. hp.}) \\
 & = (id_{UR} \oplus id_{P'R}); (id_{UR} \oplus id_{P'R}) & (\text{S2}) \\
 & = id_{UR \oplus P'R} & (\text{Funct. } \oplus) \\
 & = id_{(U \oplus P')R} & (\text{Rem. 5.3})
 \end{aligned}$$

□

PROOF OF LEMMA E.1.4. Analogous to the proof of Lemma E.1.3 above. □

PROOF OF LEMMA E.1.5. We want to prove that $\sigma_{P,Q}^\otimes; \sigma_{Q,P}^\otimes = id_{PQ}$. First we prove the following three equations:

$$\sigma_{0,Q}^\otimes = id_0 \quad (*_1)$$

$$\sigma_{U \oplus P',V}^\otimes = (\sigma_{U,V}^\otimes \oplus \sigma_{P',V}^\otimes); \delta_{V,U,P'}^{-l} \quad (*_2.1)$$

$$\sigma_{U \oplus P',Q}^\otimes = \left(\bigoplus_j \overline{\sigma_{U,V_j}} \oplus \sigma_{P',Q}^\otimes \right); \delta_{Q,U,P'}^{-l} \text{ with } Q = \bigoplus_j V_j \quad (*_2)$$

For $(*_1)$ we proceed by induction on Q :

Case $Q = 0$: it holds by definition of σ^\otimes .

Case $Q = V \oplus Q'$:

$$\begin{aligned}
 \sigma_{0,V \oplus Q'}^\otimes & = \delta_{0,V,Q'}^l; \left(\bigoplus_{i=1}^0 \overline{\sigma_{U_i,V}} \oplus \sigma_{0,Q'}^\otimes \right) & (\text{Def. } \sigma^\otimes) \\
 & = id_0 & (\text{Def. } \delta^l, \text{ ind. hp.})
 \end{aligned}$$

For (*_{2.1}), suppose that $P' = \bigoplus_{i'} U'_{i'}$ and observe that the following holds:

$$\begin{aligned}
 \sigma_{U \oplus P', V}^{\otimes} &= \delta_{U \oplus P', V, 0}^l; (\overline{\sigma_{U, V}} \oplus \bigoplus_{i'} \overline{\sigma_{U'_{i'}, V}} \oplus \sigma_{U, 0}^{\otimes}) && \text{(Def. } \sigma^{\otimes}\text{)} \\
 &= \delta_{U \oplus P', V, 0}^l; (\sigma_{U, V}^{\otimes} \oplus \sigma_{P', V}^{\otimes}) && \text{(Def. } \sigma^{\otimes}\text{)} \\
 &= (\sigma_{U, V}^{\otimes} \oplus \sigma_{P', V}^{\otimes}) && \text{(Lemma E.1.3)} \\
 &= (\sigma_{U, V}^{\otimes} \oplus \sigma_{P', V}^{\otimes}); \delta_{V, U, P'}^{-l} && \text{(Lemma E.1.1)}
 \end{aligned}$$

For (*₂) we proceed by induction on Q :

Case $Q = 0$:

$$\begin{aligned}
 \sigma_{U \oplus P', 0}^{\otimes} &= id_0 && \text{(Def. } \sigma^{\otimes}\text{)} \\
 &= (\bigoplus_{i=1}^0 \overline{\sigma_{U_i, V}} \oplus \sigma_{0, Q'}^{\otimes}); \delta_{0, V, Q'}^l && \text{(Def. } \delta^l\text{)}
 \end{aligned}$$

Case $Q = V \oplus Q'$:

$$\begin{aligned}
 \sigma_{U \oplus P', V \oplus Q'}^{\otimes} &= \delta_{U \oplus P', V, Q'}^l; (\overline{\sigma_{U, V}} \oplus \bigoplus_{i'} \overline{\sigma_{U'_{i'}, V}} \oplus \sigma_{U \oplus P', Q'}^{\otimes}) && \text{(Def. } \sigma^{\otimes}\text{)} \\
 &= \delta_{U \oplus P', V, Q'}^l; (\sigma_{U \oplus P', V}^{\otimes} \oplus \sigma_{U \oplus P', Q'}^{\otimes}) && \text{(Lemma E.1.8)} \\
 &= \delta_{U \oplus P', V, Q'}^l; (((\sigma_{U, V}^{\otimes} \oplus \sigma_{P', V}^{\otimes}); \delta_{V, U, P'}^{-l}) \oplus ((\sigma_{U, Q'}^{\otimes} \oplus \sigma_{P', Q'}^{\otimes}); \delta_{Q', U, P'}^{-l})) && \text{(*2.1, ind. hp.)} \\
 &= (\delta_{U, V, Q'}^l \oplus \delta_{P', V, Q'}^l); (id_{UV} \oplus \sigma_{UQ', P'V}^{\oplus} \oplus id_{P'Q'}); && \text{(Def. } \delta^l\text{)} \\
 &\quad (((\sigma_{U, V}^{\otimes} \oplus \sigma_{P', V}^{\otimes}); \delta_{V, U, P'}^{-l}) \oplus ((\sigma_{U, Q'}^{\otimes} \oplus \sigma_{P', Q'}^{\otimes}); \delta_{Q', U, P'}^{-l})) \\
 &= (\delta_{U, V, Q'}^l \oplus \delta_{P', V, Q'}^l); (id_{UV} \oplus \sigma_{UQ', P'V}^{\oplus} \oplus id_{P'Q'}); && \text{(Funct. } \oplus\text{)} \\
 &\quad (\sigma_{U, V}^{\otimes} \oplus \sigma_{P', V}^{\otimes} \oplus \sigma_{U, Q'}^{\otimes} \oplus \sigma_{P', Q'}^{\otimes}); (\delta_{V, U, P'}^{-l} \oplus \delta_{Q', U, P'}^{-l}) \\
 &= (\delta_{U, V, Q'}^l \oplus \delta_{P', V, Q'}^l); (\sigma_{U, V}^{\otimes} \oplus \sigma_{U, Q'}^{\otimes} \oplus \sigma_{P', V}^{\otimes} \oplus \sigma_{P', Q'}^{\otimes}); && \text{(*}^{\oplus}\text{-nat)} \\
 &\quad (id_{VU} \oplus \sigma_{QU, VP'}^{\oplus} \oplus id_{Q'P}); (\delta_{V, U, P'}^{-l} \oplus \delta_{Q', U, P'}^{-l}) \\
 &= (\delta_{U, V, Q'}^l \oplus \delta_{P', V, Q'}^l); (\sigma_{U, V}^{\otimes} \oplus \sigma_{U, Q'}^{\otimes} \oplus \sigma_{P', V}^{\otimes} \oplus \sigma_{P', Q'}^{\otimes}); \delta_{V \oplus Q', U, P'}^{-l} && \text{(Def. } \delta^l\text{)} \\
 &= (\delta_{U, V, Q'}^l; (\sigma_{U, V}^{\otimes} \oplus \sigma_{U, Q'}^{\otimes})) \oplus (\delta_{P', V, Q'}^l; (\sigma_{P', V}^{\otimes} \oplus \sigma_{P', Q'}^{\otimes})); \delta_{V \oplus Q', U, P'}^{-l} && \text{(Funct. } \oplus\text{)} \\
 &= (\sigma_{U, V \oplus Q'}^{\otimes} \oplus \sigma_{P', V \oplus Q'}^{\otimes}); \delta_{V \oplus Q', U, P'}^{-l} && \text{(Def. } \sigma^{\otimes}, \text{Lemma E.1.8)}
 \end{aligned}$$

The rest of the proof is by induction on Q :

Case $Q = 0$

$$\begin{aligned}
 \sigma_{P', 0}^{\otimes}; \sigma_{0, P}^{\otimes} &= id_0; \sigma_{0, P}^{\otimes} && \text{(Def. } \sigma^{\otimes}\text{)} \\
 &= id_0; id_0 && \text{(*}_1\text{)} \\
 &= id_0
 \end{aligned}$$

Case $Q = V \oplus Q'$

$$\begin{aligned}
 \sigma_{P,V \oplus Q'}^{\otimes}; \sigma_{V \oplus Q',P}^{\otimes} &= \delta_{P,V,Q'}^l; \left(\bigoplus_i \overline{\sigma_{U_i,V}} \oplus \sigma_{P,Q'}^{\otimes} \right); \left(\bigoplus_i \overline{\sigma_{V,U_i}} \oplus \sigma_{Q',P}^{\otimes} \right); \delta_{P,V,Q'}^{-l} && \text{(Def. } \sigma^{\otimes}, *_2) \\
 &= \delta_{P,V,Q'}^l; \left(\left(\bigoplus_i \overline{\sigma_{U_i,V}}; \bigoplus_i \overline{\sigma_{V,U_i}} \right) \oplus (\sigma_{P,Q'}^{\otimes}; \sigma_{Q',P}^{\otimes}) \right); \delta_{P,V,Q'}^{-l} && \text{(Funct. } \oplus) \\
 &= \delta_{P,V,Q'}^l; (id_{PV} \oplus id_{PQ'}); \delta_{P,V,Q'}^{-l} && \text{(S1, ind. hp.)} \\
 &= id_{P(V \oplus Q')} && \text{(Iso)}
 \end{aligned}$$

□

PROOF OF LEMMA E.1.8. It holds by definition of σ^{\otimes} . □

Lemma E.2. *The following holds for all monomials V and polynomials P, Q, R :*

$$\delta_{U \oplus P', V \oplus Q, R}^l; (\delta_{P', V, Q}^l \oplus id_{PR}) = \delta_{P', V, Q \oplus R}^l; (id_{PV} \oplus \delta_{P', Q, R}^l)$$

PROOF. By induction on P .

Case $P = 0$: it holds since both sides of the equation are id_0 by definition of δ^l .

Case $P = U \oplus P'$: For the inductive case we will mix the classical syntax with tape diagrams to ease the reading.

$$\begin{aligned}
 &\delta_{U \oplus P', V \oplus Q, R}^l; (\delta_{U \oplus P', V, Q}^l \oplus id_{UR \oplus P'R}) \\
 &= (id_{U((V \oplus Q) \oplus R)} \oplus \delta_{P', V \oplus Q, R}^l); (id_{UV \oplus UQ} \oplus \sigma_{UR, P'(V \oplus Q)}^{\oplus} \oplus id_{P'R}); && \text{(Def. } \delta^l) \\
 &\hspace{15em} (\delta_{U \oplus P', V, Q}^l \oplus id_{UR \oplus P'R}) \\
 &= (id_{U((V \oplus Q) \oplus R)} \oplus \delta_{P', V \oplus Q, R}^l); (id_{UV \oplus UQ} \oplus \sigma_{UR, P'(V \oplus Q)}^{\oplus} \oplus id_{P'R}); && \text{(Def. } \delta^l) \\
 &\hspace{2em} (((id_{U(V \oplus Q)} \oplus \delta_{P', V, Q}^l); (id_{UV} \oplus \sigma_{UQ, P'V}^{\oplus} \oplus id_{P'Q})) \oplus id_{UR \oplus P'R})
 \end{aligned}$$

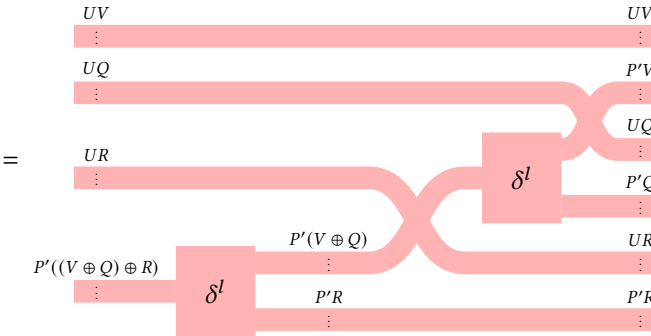

$$\begin{array}{c}
 \begin{array}{ccc}
 UV & & UV \\
 \vdots & & \vdots \\
 UQ & & P'V \\
 \vdots & & \vdots \\
 UR & & UQ \\
 \vdots & & \vdots \\
 P'((V \oplus Q) \oplus R) & \delta^l & P'(V \oplus Q) \quad \delta^l \\
 \vdots & & P'R \\
 \vdots & & \vdots
 \end{array} \\
 = \\
 \begin{array}{ccc}
 UV & & UV \\
 \vdots & & \vdots \\
 UQ & & P'V \\
 \vdots & & \vdots \\
 UR & & UQ \\
 \vdots & & \vdots \\
 P'((V \oplus Q) \oplus R) & \delta^l & P'V \\
 \vdots & & P'(Q \oplus R) \quad \delta^l \\
 \vdots & & UR \\
 \vdots & & P'R
 \end{array} \\
 = \\
 \begin{array}{ccc}
 UV & & UV \\
 \vdots & & \vdots \\
 UQ & & P'V \\
 \vdots & & \vdots \\
 UR & & UQ \\
 \vdots & & \vdots \\
 P'((V \oplus Q) \oplus R) & \delta^l & P'V \\
 \vdots & & P'(Q \oplus R) \\
 \vdots & & UR \\
 \vdots & & P'R
 \end{array} \\
 = \\
 \begin{array}{ccc}
 UV & & UV \\
 \vdots & & \vdots \\
 UQ & & P'V \\
 \vdots & & \vdots \\
 UR & & UQ \\
 \vdots & & \vdots \\
 P'((V \oplus Q) \oplus R) & \delta^l & P'V \\
 \vdots & & P'(Q \oplus R) \\
 \vdots & & UR \\
 \vdots & & P'R
 \end{array} \\
 = (id_{U(V \oplus (Q \oplus R))} \oplus \delta_{P', V, Q \oplus R}^l); (id_{UV} \oplus \sigma_{U(Q \oplus R), P'V}^{\oplus} \oplus id_{P'(Q \oplus R)}); \\
 (id_{UV \oplus P'V} \oplus ((id_{U(Q \oplus R)} \oplus \delta_{P', Q, R}^l); (id_{UQ} \oplus \sigma_{UR, P'Q}^{\oplus} \oplus id_{P'R}))) \\
 = \delta_{U \oplus P', V, Q \oplus R}^l; (id_{UV \oplus P'V} \oplus \delta_{U \oplus P', Q, R}^l)
 \end{array}
 \tag{Def. δ^l }$$

$(\sigma^{\oplus}\text{-nat})$
 (Ind. hp.)
 $(\text{Funct. } \oplus)$

□

PROOF OF LEMMA E.1.6. We want to prove that $\sigma_{P', Q \oplus R}^{\otimes} = \delta_{P', Q, R}^l; (\sigma_{P', Q}^{\otimes} \oplus \sigma_{P', R}^{\otimes})$ by induction on Q .

Case $Q = 0$: By Lemma E.1.3, $\delta_{P', 0, R}^l = id_R$ and by definition of σ^{\otimes} , $\sigma_{P', 0}^{\otimes} = id_0$. The right-hand side reduces therefore to $\sigma_{P', R}^{\otimes}$, as desired.

Case $Q = V \oplus Q'$:

$$\begin{aligned}
 \sigma_{P,V \oplus Q' \oplus R}^{\otimes} &= \delta_{P,V,Q' \oplus R}^l; \left(\bigoplus_i \overline{\sigma_{U_i,V}} \oplus \sigma_{P,Q' \oplus R}^{\otimes} \right) && \text{(Def. } \sigma^{\otimes} \text{)} \\
 &= \delta_{P,V,Q' \oplus R}^l; \left(\bigoplus_i \overline{\sigma_{U_i,V}} \oplus (\delta_{P,Q',R}^l; (\sigma_{P,Q'}^{\otimes} \oplus \sigma_{P,R}^{\otimes})) \right) && \text{(Ind. hp.)} \\
 &= \delta_{P,V,Q' \oplus R}^l; (id_{PV} \oplus \delta_{P,Q',R}^l); \left(\bigoplus_i \overline{\sigma_{U_i,V}} \oplus \sigma_{P,Q'}^{\otimes} \oplus \sigma_{P,R}^{\otimes} \right) && \text{(Funct. } \oplus \text{)} \\
 &= \delta_{P,V \oplus Q',R}^l; (\delta_{P,V,Q'}^l \oplus id_{PR}); \left(\bigoplus_i \overline{\sigma_{U_i,V}} \oplus \sigma_{P,Q'}^{\otimes} \oplus \sigma_{P,R}^{\otimes} \right) && \text{(Lemma E.2)} \\
 &= \delta_{P,V \oplus Q',R}^l; ((\delta_{P,V,Q'}^l; (\bigoplus_i \overline{\sigma_{U_i,V}} \oplus \sigma_{P,Q'}^{\otimes})) \oplus \sigma_{P,R}^{\otimes}) && \text{(Funct. } \oplus \text{)} \\
 &= \delta_{P,V \oplus Q',R}^l; (\sigma_{P,V \oplus Q'}^{\otimes} \oplus \sigma_{P,R}^{\otimes}) && \text{(Def. } \sigma^{\otimes} \text{)}
 \end{aligned}$$

□

PROOF OF LEMMA E.1.7. We want to prove that $\sigma_{P,1}^{\otimes} = id_P$ by induction on P .

Case $P = 0$: it holds by definition of σ^{\otimes} .

Case $P = U \oplus P'$:

$$\begin{aligned}
 \sigma_{U \oplus P',1}^{\otimes} &= \sigma_{1,U \oplus P'}^{-\otimes} && \text{(Lemma E.1.5)} \\
 &= (\overline{\sigma_{U,1}} \oplus \sigma_{P',1}^{\otimes}); \delta_{1,U,P'}^{-l} && \text{(Def. } \sigma^{\otimes} \text{)} \\
 &= (\overline{\sigma_{U,1}} \oplus \sigma_{P',1}^{\otimes}); id_{UP'} && \text{(Lemma E.1.1)} \\
 &= id_U \oplus id_{P'} && \text{(S2, ind. hp.)} \\
 &= id_{U \oplus P'}
 \end{aligned}$$

□

E.2 Additional lemmas for monomial whiskerings

Lemma E.3. Let $\mathfrak{t}: \bigoplus_i U_i \rightarrow \bigoplus_j V_j$ be a tape diagram, then the following holds

$$R_W(\mathfrak{t}) = \bigoplus_i \overline{\sigma_{U_i,W}}; L_W(\mathfrak{t}); \bigoplus_j \overline{\sigma_{W,V_j}}$$

PROOF. By induction on \mathfrak{t} .

Case $\mathfrak{t} = id_0$: Notice that $\bigoplus_{i=1}^0 \overline{\sigma_{U_i,W}} = \bigoplus_{j=1}^0 \overline{\sigma_{W,V_j}} = id_0$ and thus $R_W(id_0) = id_0 = L_W(id_0)$.

Case $\mathfrak{t} = \overline{c}$: Suppose $c: U \rightarrow V$, then

$$\begin{aligned}
 R_W(\overline{c}) &= \overline{c \otimes id_W} && \text{(Def. } R \text{)} \\
 &= \overline{c \otimes id_W}; \overline{\sigma_{V,W}}; \overline{\sigma_{W,V}} && \text{(S1)} \\
 &= \overline{\sigma_{U,W}}; \overline{id_W \otimes c}; \overline{\sigma_{W,V}} && \text{(Nat. } \overline{\sigma} \text{)} \\
 &= \overline{\sigma_{U,W}}; L_W(\overline{c}); \overline{\sigma_{W,V}} && \text{(Def. } L \text{)}
 \end{aligned}$$

Case $t = \sigma_{U,V}^\oplus$:

$$\begin{aligned}
 R_W(\sigma_{U,V}^\oplus) &= \sigma_{UW,VW}^\oplus && \text{(Def. R)} \\
 &= \sigma_{UW,VW}^\oplus; ((\overline{\sigma_{V,W}}; \overline{\sigma_{W,V}}) \oplus (\overline{\sigma_{U,W}}; \overline{\sigma_{W,U}})) && \text{(S1)} \\
 &= (\overline{\sigma_{U,W}} \oplus \overline{\sigma_{V,W}}); \sigma_{WU,WV}^\oplus; (\overline{\sigma_{W,V}} \oplus \overline{\sigma_{W,U}}) && (\sigma^\oplus\text{-nat)} \\
 &= (\overline{\sigma_{U,W}} \oplus \overline{\sigma_{V,W}}); L_W(\sigma_{U,V}^\oplus); (\overline{\sigma_{W,V}} \oplus \overline{\sigma_{W,U}}) && \text{(Def. L)}
 \end{aligned}$$

Case $t = \triangleleft_U$: (similarly for \triangleright_U)

$$\begin{aligned}
 R_W(\triangleleft_U) &= \triangleleft_{UW} && \text{(Def. R)} \\
 &= \triangleleft_{UW}; ((\overline{\sigma_{U,W}}; \overline{\sigma_{W,U}}) \oplus (\overline{\sigma_{U,W}}; \overline{\sigma_{W,U}})) && \text{(S1)} \\
 &= \overline{\sigma_{U,W}}; \triangleleft_{WU}; (\overline{\sigma_{W,U}} \oplus \overline{\sigma_{W,U}}) && (\triangleleft\text{-nat)} \\
 &= \overline{\sigma_{U,W}}; L_W(\triangleleft_U); (\overline{\sigma_{W,U}} \oplus \overline{\sigma_{W,U}}) && \text{(Def. L)}
 \end{aligned}$$

Case $t = \uparrow_U$: (similarly for \downarrow_U)

$$\begin{aligned}
 R_W(\uparrow_U) &= \uparrow_{UW} && \text{(Def. R)} \\
 &= \overline{\sigma_{U,W}}; \overline{\sigma_{W,U}}; \uparrow_{UW} && \text{(S1)} \\
 &= \overline{\sigma_{U,W}}; \uparrow_{WU} && (\uparrow\text{-nat)} \\
 &= \overline{\sigma_{U,W}}; L_W(\uparrow_U) && \text{(Def. L)}
 \end{aligned}$$

Case $t = t_1; t_2$: Suppose $t_1: \bigoplus_i U_i \rightarrow \bigoplus_l Z_l$, $t_2: \bigoplus_l Z_l \rightarrow \bigoplus_j V_j$, then

$$\begin{aligned}
 R_W(t_1; t_2) &= R_W(t_1); R_W(t_2) && \text{(Def. R)} \\
 &= \bigoplus_i \overline{\sigma_{U_i,W}}; L_W(t_1); \bigoplus_l \overline{\sigma_{W,Z_l}}; \bigoplus_l \overline{\sigma_{Z_l,W}}; L_W(t_2); \bigoplus_j \overline{\sigma_{W,V_j}} && \text{(Ind. hp.)} \\
 &= \bigoplus_i \overline{\sigma_{U_i,W}}; L_W(t_1); L_W(t_2); \bigoplus_j \overline{\sigma_{W,V_j}} && \text{(S1)} \\
 &= \bigoplus_i \overline{\sigma_{U_i,W}}; L_W(t_1; t_2); \bigoplus_j \overline{\sigma_{W,V_j}} && \text{(Def. L)}
 \end{aligned}$$

Case $t = t_1 \oplus t_2$: Suppose $t_1: \bigoplus_i U_i \rightarrow \bigoplus_j V_j$, $t_2: \bigoplus_{i'} U'_{i'} \rightarrow \bigoplus_{j'} V'_{j'}$, then

$$\begin{aligned}
 R_W(t_1 \oplus t_2) &= R_W(t_1) \oplus R_W(t_2) && \text{(Def. R)} \\
 &= (\bigoplus_i \overline{\sigma_{U_i,W}}; L_W(t_1); \bigoplus_j \overline{\sigma_{W,V_j}}) \oplus (\bigoplus_{i'} \overline{\sigma_{U'_{i'},W}}; L_W(t_2); \bigoplus_{j'} \overline{\sigma_{W,V'_{j'}}}) && \text{(Ind. hp.)} \\
 &= (\bigoplus_i \overline{\sigma_{U_i,W}} \oplus \bigoplus_{i'} \overline{\sigma_{U'_{i'},W}}); (L_W(t_1) \oplus L_W(t_2)); (\bigoplus_j \overline{\sigma_{W,V_j}} \oplus \bigoplus_{j'} \overline{\sigma_{W,V'_{j'}}}) && \text{(Funct. } \oplus \text{)} \\
 &= (\bigoplus_i \overline{\sigma_{U_i,W}} \oplus \bigoplus_{i'} \overline{\sigma_{U'_{i'},W}}); (L_W(t_1 \oplus t_2)); (\bigoplus_j \overline{\sigma_{W,V_j}} \oplus \bigoplus_{j'} \overline{\sigma_{W,V'_{j'}}}) && \text{(Def. L)}
 \end{aligned}$$

□

Lemma E.4. For all $\underline{c}: U \rightarrow V$, $t: P \rightarrow Q$, $L_U(t); R_Q(\underline{c}) = R_P(\underline{c}); L_V(t)$.

PROOF. We fix $P = \bigoplus_k W_k$ and $Q = \bigoplus_l Z_l$. By definition of $R_P(-)$ and δ^l , it is immediate that $R_Q(\overline{c}) = \bigoplus_l \overline{c \otimes id_{Z_l}}$ and $R_P(\overline{c}) = \bigoplus_k \overline{c \otimes id_{W_k}}$.

We proceed by induction on \mathbf{t} .

Case $\mathbf{t} = id_0$: $L_U(id_0); \bigoplus_{l=1}^0 \overline{c \otimes id_{Z_l}} = id_0 = (\bigoplus_{k=1}^0 \overline{c \otimes id_{W_k}}); L_V(id_0)$

Case $\mathbf{t} = \overline{d}$: Suppose $d: W \rightarrow Z$, then

$$\begin{aligned} L_U(\overline{d}); \overline{c \otimes id_Z} &= \overline{id_U \otimes d}; \overline{c \otimes id_Z} && \text{(Def. L)} \\ &= \overline{c \otimes d} && \text{(Funct. } \overline{\otimes}) \\ &= \overline{c \otimes id_W}; \overline{id_V \otimes d} && \text{(Funct. } \overline{\otimes}) \\ &= \overline{c \otimes id_W}; L_V(\overline{d}) && \text{(Def. L)} \end{aligned}$$

Case $\mathbf{t} = \sigma_{W,Z}^\oplus$:

$$\begin{aligned} L_U(\sigma_{W,Z}^\oplus); (\overline{c \otimes id_Z} \oplus \overline{c \otimes id_W}) &= \sigma_{UW,UZ}^\oplus; (\overline{c \otimes id_Z} \oplus \overline{c \otimes id_W}) && \text{(Def. L)} \\ &= (\overline{c \otimes id_W} \oplus \overline{c \otimes id_Z}); \sigma_{VW,VZ}^\oplus && (\sigma^\oplus\text{-nat)} \\ &= (\overline{c \otimes id_W} \oplus \overline{c \otimes id_Z}); L_V(\sigma_{W,Z}^\oplus) && \text{(Def. L)} \end{aligned}$$

Case $\mathbf{t} = \triangleleft_W$: (similarly for \triangleright_W)

$$\begin{aligned} L_U(\triangleleft_W); (\overline{c \otimes id_W} \oplus \overline{c \otimes id_W}) &= \triangleleft_{UW}; (\overline{c \otimes id_W} \oplus \overline{c \otimes id_W}) && \text{(Def. L)} \\ &= \overline{c \otimes id_W}; \triangleleft_{VW} && (\triangleleft\text{-nat)} \\ &= \overline{c \otimes id_W}; L_V(\triangleleft_W) && \text{(Def. L)} \end{aligned}$$

Case $\mathbf{t} = \hat{\imath}_W$: (similarly for $\hat{\circ}_W$)

$$\begin{aligned} L_U(\hat{\imath}_W); \bigoplus_{l=1}^0 \overline{c \otimes id_{Z_l}} &= \hat{\imath}_{UW} && \text{(Def. L)} \\ &= \overline{c \otimes id_W}; \hat{\imath}_{VW} && (\hat{\imath}\text{-nat)} \\ &= \overline{c \otimes id_W}; L_V(\hat{\imath}_W) && \text{(Def. L)} \end{aligned}$$

Case $\mathbf{t} = \mathbf{t}_1; \mathbf{t}_2$: Suppose $\mathbf{t}_1: \bigoplus_k W_k \rightarrow \bigoplus_j V_j$, $\mathbf{t}_2: \bigoplus_j V_j \rightarrow \bigoplus_l Z_l$, then

$$\begin{aligned} L_U(\mathbf{t}_1; \mathbf{t}_2); \bigoplus_l \overline{c \otimes id_{Z_l}} &= L_U(\mathbf{t}_1); L_U(\mathbf{t}_2); \bigoplus_l \overline{c \otimes id_{Z_l}} && \text{(Def. L)} \\ &= L_U(\mathbf{t}_1); \bigoplus_j \overline{c \otimes id_{V_j}}; L_V(\mathbf{t}_2) && \text{(Ind. hp.)} \\ &= \bigoplus_k \overline{c \otimes id_{W_k}}; L_V(\mathbf{t}_1); L_V(\mathbf{t}_2) && \text{(Ind. hp.)} \\ &= \bigoplus_k \overline{c \otimes id_{W_k}}; L_V(\mathbf{t}_1; \mathbf{t}_2) && \text{(Def. L)} \end{aligned}$$

Case $\mathbf{t} = \mathbf{t}_1 \oplus \mathbf{t}_2$: Suppose $\mathbf{t}_1: \bigoplus_k W_k \rightarrow \bigoplus_l Z_l$, $\mathbf{t}_2: \bigoplus_{k'} W'_{k'} \rightarrow \bigoplus_{l'} Z'_{l'}$, then

$$\begin{aligned}
 & L_U(\mathbf{t}_1 \oplus \mathbf{t}_2); \left(\bigoplus_l \overline{c \otimes id_{Z_l}} \oplus \bigoplus_{l'} \overline{c \otimes id_{Z'_{l'}}} \right) \\
 &= (L_U(\mathbf{t}_1) \oplus L_U(\mathbf{t}_2)); \left(\bigoplus_l \overline{c \otimes id_{Z_l}} \oplus \bigoplus_{l'} \overline{c \otimes id_{Z'_{l'}}} \right) && \text{(Def. L)} \\
 &= (L_U(\mathbf{t}_1); \bigoplus_l \overline{c \otimes id_{Z_l}}) \oplus (L_U(\mathbf{t}_2); \bigoplus_{l'} \overline{c \otimes id_{Z'_{l'}}}) && \text{(Funct. } \oplus) \\
 &= \left(\bigoplus_k \overline{c \otimes id_{W_k}}; L_V(\mathbf{t}_1) \right) \oplus \left(\bigoplus_{k'} \overline{c \otimes id_{W'_{k'}}}; L_V(\mathbf{t}_2) \right) && \text{(Ind. hp.)} \\
 &= \left(\bigoplus_k \overline{c \otimes id_{W_k}} \oplus \bigoplus_{k'} \overline{c \otimes id_{W'_{k'}}} \right); (L_V(\mathbf{t}_1) \oplus L_V(\mathbf{t}_2)) && \text{(Funct. } \oplus) \\
 &= \left(\bigoplus_k \overline{c \otimes id_{W_k}} \oplus \bigoplus_{k'} \overline{c \otimes id_{W'_{k'}}} \right); L_V(\mathbf{t}_1 \oplus \mathbf{t}_2) && \text{(Def. L)}
 \end{aligned}$$

□

E.3 Proof of Lemma 5.9: the algebra of whiskerings

The properties of the left whiskering are all trivial, thus we show only the proofs for their right counterpart.

Let $P = \bigoplus_i U_i$, $Q = \bigoplus_j V_j$, $S = \bigoplus_k W_k$, $T = \bigoplus_l Z_l$.

EQUATION (W1): $R_S(id_P) = id_{PS}$. We prove it by induction on S .

Case $S = 0$: it holds by Definition 5.7.

Case $S = W \oplus S'$:

$$\begin{aligned}
 R_{W \oplus S'}(id_Q) &= \delta_{Q,W,S'}^l; (R_W(id_Q) \oplus R_{S'}(id_Q)); \delta_{Q,W,S'}^{-l} && \text{(Def. R)} \\
 &= \delta_{Q,W,S'}^l; (id_{QW} \oplus id_{QS'}); \delta_{Q,W,S'}^{-l} && \text{(Def. R, ind. hp.)} \\
 &= id_{Q(W \oplus S')} && \text{(Iso)}
 \end{aligned}$$

EQUATION (W2): $R_S(\mathbf{t}_1; \mathbf{t}_2) = R_S(\mathbf{t}_1); R_S(\mathbf{t}_2)$. Let $\mathbf{t}_1: P \rightarrow Q$, $\mathbf{t}_2: Q \rightarrow T$, we prove it by induction on S .

Case $S = 0$: it holds by Definition 5.7.

Case $S = W \oplus S'$:

$$\begin{aligned}
 & R_{W \oplus S'}(\mathbf{t}_1; \mathbf{t}_2) \\
 &= \delta_{P,W,S'}^l; (R_W(\mathbf{t}_1; \mathbf{t}_2) \oplus R_{S'}(\mathbf{t}_1; \mathbf{t}_2)); \delta_{T,W,S'}^{-l} && \text{(Def. R)} \\
 &= \delta_{P,W,S'}^l; ((R_W(\mathbf{t}_1); R_W(\mathbf{t}_2)) \oplus (R_{S'}(\mathbf{t}_1); R_{S'}(\mathbf{t}_2))); \delta_{T,W,S'}^{-l} && \text{(Def. R, ind. hp.)} \\
 &= \delta_{P,W,S'}^l; ((R_W(\mathbf{t}_1) \oplus R_{S'}(\mathbf{t}_1)); (R_W(\mathbf{t}_2) \oplus R_{S'}(\mathbf{t}_2))); \delta_{T,W,S'}^{-l} && \text{(Funct. } \oplus) \\
 &= \delta_{P,W,S'}^l; ((R_W(\mathbf{t}_1) \oplus R_{S'}(\mathbf{t}_1)); \delta_{Q,W,S'}^{-l}; \delta_{Q,W,S'}^l; (R_W(\mathbf{t}_2) \oplus R_{S'}(\mathbf{t}_2))); \delta_{T,W,S'}^{-l} && \text{(Iso)} \\
 &= R_{W \oplus S'}(\mathbf{t}_1); R_{W \oplus S'}(\mathbf{t}_2) && \text{(Def. R)}
 \end{aligned}$$

EQUATION (W3): $R_1(\mathbf{t}) = \mathbf{t}$. We prove it by induction on \mathbf{t} . All the base cases are trivial and the inductive cases follow by inductive hypothesis and functoriality of R and \oplus .

EQUATION (W4): $R_0(\mathbf{t}) = id_0$. It holds by Definition 5.7.

EQUATION (W6): $R_{S \oplus T}(\mathbf{t}) = \delta_{P,S,T}^l; (R_S(\mathbf{t}) \oplus R_T(\mathbf{t})); \delta_{Q,S,T}^{-l}$. Let $\mathbf{t}: P \rightarrow Q$, we prove it by induction on S .

Case $S = 0$: it holds by Definition 5.7.

Case $S = W \oplus S'$:

$$\begin{aligned}
 & R_{W \oplus S' \oplus T}(\mathbf{t}) \\
 &= \delta_{P, W, S' \oplus T}^l; (R_W(\mathbf{t}) \oplus R_{S' \oplus T}(\mathbf{t})); \delta_{Q, W, S' \oplus T}^{-l} && \text{(Def. R)} \\
 &= \delta_{P, W, S' \oplus T}^l; (R_W(\mathbf{t}) \oplus (\delta_{P, S', T}^l; (R_{S'}(\mathbf{t}) \oplus R_T(\mathbf{t})); \delta_{Q, S', T}^{-l})); \delta_{Q, W, S' \oplus T}^{-l} && \text{(Ind. hp.)} \\
 &= \delta_{P, W, S' \oplus T}^l; (id_{PW} \oplus \delta_{P, S', T}^l); (R_W(\mathbf{t}) \oplus ((R_{S'}(\mathbf{t}) \oplus R_T(\mathbf{t})); \delta_{Q, S', T}^{-l})); \delta_{Q, W, S' \oplus T}^{-l} && \text{(Funct. } \oplus) \\
 &= \delta_{P, W \oplus S', T}^l; (\delta_{P, W, S'}^l \oplus id_{PT}); (R_W(\mathbf{t}) \oplus ((R_{S'}(\mathbf{t}) \oplus R_T(\mathbf{t})); \delta_{Q, S', T}^{-l})); \delta_{Q, W, S' \oplus T}^{-l} && \text{(Lemma E.2)} \\
 &= \delta_{P, W \oplus S', T}^l; (\delta_{P, W, S'}^l \oplus id_{PT}); (R_W(\mathbf{t}) \oplus R_{S'}(\mathbf{t}) \oplus R_T(\mathbf{t})); (id_{QW} \oplus \delta_{Q, S', T}^{-l}); \delta_{Q, W, S' \oplus T}^{-l} && \text{(Funct. } \oplus) \\
 &= \delta_{P, W \oplus S', T}^l; (\delta_{P, W, S'}^l \oplus id_{PT}); (R_W(\mathbf{t}) \oplus R_{S'}(\mathbf{t}) \oplus R_T(\mathbf{t})); (\delta_{Q, W, S'}^{-l} \oplus id_{QT}); \delta_{Q, W \oplus S', T}^{-l} && \text{(Lemma E.2)} \\
 &= \delta_{P, W \oplus S', T}^l; ((\delta_{P, W, S'}^l; (R_W(\mathbf{t}) \oplus R_{S'}(\mathbf{t})); \delta_{Q, W, S'}^{-l}) \oplus R_T(\mathbf{t})); \delta_{Q, W \oplus S', T}^{-l} && \text{(Funct. } \oplus) \\
 &= \delta_{P, W \oplus S', T}^l; (R_{W \oplus S'}(\mathbf{t}) \oplus R_T(\mathbf{t})); \delta_{Q, W \oplus S', T}^{-l} && \text{(Def. R)}
 \end{aligned}$$

EQUATION (W5): $R_S(\mathbf{t}_1 \oplus \mathbf{t}_2) = R_S(\mathbf{t}_1) \oplus R_S(\mathbf{t}_2)$. Let $\mathbf{t}_1: P \rightarrow Q$, $\mathbf{t}_2: P' \rightarrow Q'$, we prove it by induction on S .

Case $S = 0$: it holds by Definition 5.7.

Case $S = W \oplus S'$:

$$\begin{aligned}
 & R_{W \oplus S'}(\mathbf{t}_1 \oplus \mathbf{t}_2) \\
 &= \delta_{P \oplus P', W, S'}^l; (R_W(\mathbf{t}_1 \oplus \mathbf{t}_2) \oplus R_{S'}(\mathbf{t}_1 \oplus \mathbf{t}_2)); \delta_{Q \oplus Q', W, S'}^{-l} && \text{(W6)} \\
 &= \delta_{P \oplus P', W, S'}^l; (R_W(\mathbf{t}_1) \oplus R_W(\mathbf{t}_2) \oplus R_{S'}(\mathbf{t}_1) \oplus R_{S'}(\mathbf{t}_2)); \delta_{Q \oplus Q', W, S'}^{-l} && \text{(Def. R, ind. hp.)} \\
 &= (\delta_{P, W, S'}^l \oplus \delta_{P', W, S'}^l); (id_{PW} \oplus \sigma_{P S', P' W}^\oplus \oplus id_{P' S'}); && \text{(Lemma E.1.2)} \\
 &\quad (R_W(\mathbf{t}_1) \oplus R_W(\mathbf{t}_2) \oplus R_{S'}(\mathbf{t}_1) \oplus R_{S'}(\mathbf{t}_2)); \\
 &\quad (id_{QW} \oplus \sigma_{Q' W, Q S'}^\oplus \oplus id_{Q' S'}); (\delta_{Q, W, S'}^{-l} \oplus \delta_{Q', W, S'}^{-l}) \\
 &= (\delta_{P, W, S'}^l \oplus \delta_{P', W, S'}^l); (R_W(\mathbf{t}_1) \oplus R_{S'}(\mathbf{t}_1) \oplus R_W(\mathbf{t}_2) \oplus R_{S'}(\mathbf{t}_2)); (\delta_{Q, W, S'}^{-l} \oplus \delta_{Q', W, S'}^{-l}) && \text{(\sigma}^\oplus\text{-nat)} \\
 &= (\delta_{P, W, S'}^l; (R_W(\mathbf{t}_1) \oplus R_{S'}(\mathbf{t}_1)); \delta_{Q, W, S'}^{-l}) \oplus (\delta_{P', W, S'}^l; (R_W(\mathbf{t}_2) \oplus R_{S'}(\mathbf{t}_2)); \delta_{Q', W, S'}^{-l}) && \text{(Funct. } \oplus) \\
 &= R_{W \oplus S'}(\mathbf{t}_1) \oplus R_{W \oplus S'}(\mathbf{t}_2) && \text{(W6)}
 \end{aligned}$$

EQUATION (W8): $R_S(\triangleleft_U) = \triangleleft_{US}$. We prove it by induction on S .

Case $S = 0$: it holds by Definition 5.7 and definition of \triangleleft .

Case $S = W \oplus S'$:

$$\begin{aligned}
 & R_{W \oplus S'}(\triangleleft_U) \\
 &= \delta_{U, W, S'}^l; (R_W(\triangleleft_U) \oplus R_{S'}(\triangleleft_U)); \delta_{U \oplus U, W, S'}^{-l} && \text{(W6)} \\
 &= (R_W(\triangleleft_U) \oplus R_{S'}(\triangleleft_U)); (id_{UW} \oplus \sigma_{U W, U S'}^\oplus \oplus id_{U S'}); (id_{U(W \oplus S')} \oplus \delta_{U, W, S'}^{-l}) && \text{(Lemma E.1.1, def. } \delta^l) \\
 &= (R_W(\triangleleft_U) \oplus R_{S'}(\triangleleft_U)); (id_{UW} \oplus \sigma_{U W, U S'}^\oplus \oplus id_{U S'}) && \text{(Lemma E.1.1)} \\
 &= (\triangleleft_{UW} \oplus \triangleleft_{U S'}); (id_{UW} \oplus \sigma_{U W, U S'}^\oplus \oplus id_{U S'}) && \text{(Def. R, ind. hp.)} \\
 &= \triangleleft_{UW \oplus U S'} && \text{(Def. } \triangleleft) \\
 &= \triangleleft_{U(W \oplus S')} && \text{(Rem. 5.3)}
 \end{aligned}$$

The case for \triangleright_U is completely analogous.

EQUATION (W9): $R_S(\uparrow_U) = \uparrow_{US}$. We prove it by induction on S .

Case $S = 0$: it holds by Definition 5.7 and definition of \uparrow .

Case $S = W \oplus S'$:

$$\begin{aligned}
 R_{W \oplus S'}(\uparrow_U) &= \delta_{U, W, S'}^l; (R_W(\uparrow_U) \oplus R_{S'}(\uparrow_U)); \delta_{0, W, S'}^{-l} && \text{(W6)} \\
 &= R_W(\uparrow_U) \oplus R_{S'}(\uparrow_U) && \text{(Lemma E.1.1, def. } \delta^l) \\
 &= \uparrow_{UW} \oplus \uparrow_{US'} && \text{(Def. } R, \text{ ind. hp.)} \\
 &= \uparrow_{UW \oplus US'} && \text{(Def. } \uparrow) \\
 &= \uparrow_{U(W \oplus S')} && \text{(Rem. 5.3)}
 \end{aligned}$$

The case for \circlearrowleft_U is completely analogous.

EQUATION (W10): $R_S(\sigma_{P,Q}^\oplus) = \sigma_{PS, QS}^\oplus$. We prove it by induction on P .

Case $P = 0$:

$$\begin{aligned}
 R_S(\sigma_{0,Q}^\oplus) &= R_S(id_Q) && \text{(S2)} \\
 &= id_{QS} && \text{(W1)} \\
 &= \sigma_{0, QS}^\oplus && \text{(S2)}
 \end{aligned}$$

Case $P = U \oplus P'$:

$$\begin{aligned}
 R_S(\sigma_{U \oplus P', Q}^\oplus) &= R_S((id_U \oplus \sigma_{P', Q}^\oplus); (\sigma_{U, Q}^\oplus \oplus id_{P'})) && \text{(S3)} \\
 &= (R_S(id_U) \oplus R_S(\sigma_{P', Q}^\oplus)); (R_S(\sigma_{U, Q}^\oplus) \oplus R_S(id_{P'})) && \text{(W2, W5)} \\
 &= (id_{US} \oplus \sigma_{P', QS}^\oplus); (\sigma_{US, QS}^\oplus \oplus id_{P'S}) && \text{(W1, ind. hp)} \\
 &= \sigma_{US \oplus P'S, QS}^\oplus && \text{(S3)} \\
 &= \sigma_{(U \oplus P')S, QS}^\oplus && \text{(Rem. 5.3)}
 \end{aligned}$$

EQUATION (W16): $R_S(\delta_{P, Q, R}^l) = \delta_{P, QS, RS}^l$. We prove it by induction on P .

Case $P = 0$: it follows from Definition 5.7 and definition of δ^l .

Case $P = U \oplus P'$:

$$\begin{aligned}
 R_S(\delta_{U \oplus P', Q, R}^l) &= R_S((id_{U(Q \oplus R)} \oplus \delta_{P', Q, R}^l); (id_{UQ} \oplus \sigma_{UR, P'Q}^\oplus \oplus id_{P'R})) && \text{(Def. } \delta^l) \\
 &= (R_S(id_{U(Q \oplus R)}) \oplus R_S(\delta_{P', Q, R}^l)); (R_S(id_{UQ}) \oplus R_S(\sigma_{UR, P'Q}^\oplus) \oplus R_S(id_{P'R})) && \text{(W2, W5)} \\
 &= (R_S(id_{U(Q \oplus R)}) \oplus \delta_{P', QS, RS}^l); (R_S(id_{UQ}) \oplus R_S(\sigma_{UR, P'Q}^\oplus) \oplus R_S(id_{P'R})) && \text{(Ind. hp.)} \\
 &= (id_{U(Q \oplus R)S} \oplus \delta_{P', QS, RS}^l); (id_{UQS} \oplus \sigma_{URS, P'QS}^\oplus \oplus id_{P'RS}) && \text{(W1, W10)} \\
 &= \delta_{U \oplus P', QS, RS}^l && \text{(Def. } \delta^l)
 \end{aligned}$$

EQUATION (W11): $\sigma_{PQ, S}^\otimes = L_P(\sigma_{Q, S}^\otimes); R_Q(\sigma_{P, S}^\otimes)$. First we prove the following equations:

$$L_U(\overline{\sigma_{V,W}}); R_V(\overline{\sigma_{U,W}}) = \overline{\sigma_{UV,W}} \quad (*_1)$$

$$L_U\left(\bigoplus_j \overline{\sigma_{V_j,W}}\right); R_Q(\overline{\sigma_{U,W}}) = \bigoplus_j \overline{\sigma_{UV_j,W}} \quad \text{where } Q = \bigoplus_j V_j \quad (*_2)$$

$$L_P(\sigma_{Q,W}^{\otimes}); R_Q(\sigma_{P,W}^{\otimes}) = \sigma_{PQ,W}^{\otimes} \quad (*_3)$$

For $(*_1)$ observe that the following holds:

$$\begin{aligned} L_U(\overline{\sigma_{V,W}}); R_V(\overline{\sigma_{U,W}}) &= \overline{id_U \otimes \sigma_{V,W}}; \overline{\sigma_{U,W} \otimes id_V} && \text{(Def. } L, R) \\ &= \overline{\sigma_{UV,W}} && (S3) \end{aligned}$$

For $(*_2)$ we proceed by induction on Q :

$$L_U\left(\bigoplus_j \overline{\sigma_{V_j,W}}\right); R_Q(\overline{\sigma_{U,W}}) = \bigoplus_j \overline{\sigma_{UV_j,W}} \quad \text{where } Q = \bigoplus_j V_j \quad (32)$$

Case $Q = 0$: it follows from Definitions 5.5 and 5.7 and from the fact that $\bigoplus_{j=1}^0 \overline{\sigma_{V_j,W}} = id_0$.

Case $Q = V \oplus Q'$: Let $Q' = \bigoplus_{j'} V_{j'}$, then

$$\begin{aligned} &L_U(\overline{\sigma_{V,W}} \oplus \bigoplus_{j'} \overline{\sigma_{V_{j'},W}}); R_{V \oplus Q'}(\overline{\sigma_{U,W}}) \\ &= (L_U(\overline{\sigma_{V,W}}) \oplus L_U(\bigoplus_{j'} \overline{\sigma_{V_{j'},W}})); \delta_{UW,V,Q'}^l; (R_V(\overline{\sigma_{U,W}}) \oplus R_{Q'}(\overline{\sigma_{U,W}})); \delta_{WU,V,Q'}^{-l} \\ & && \text{(Def. } L, W6) \\ &= (L_U(\overline{\sigma_{V,W}}) \oplus L_U(\bigoplus_{j'} \overline{\sigma_{V_{j'},W}})); (R_V(\overline{\sigma_{U,W}}) \oplus R_{Q'}(\overline{\sigma_{U,W}})) && \text{(Lemma E.1.1)} \\ &= (L_U(\overline{\sigma_{V,W}}); R_V(\overline{\sigma_{U,W}})) \oplus (L_U(\bigoplus_{j'} \overline{\sigma_{V_{j'},W}}); R_{Q'}(\overline{\sigma_{U,W}})) && \text{(Funct. } \oplus) \\ &= \overline{\sigma_{UV,W}} \oplus \bigoplus_{j'} \overline{\sigma_{UV_{j'},W}} && (*_1, \text{ ind. hp.}) \end{aligned}$$

For $(*_3)$ observe that the following holds:

$$\begin{aligned}
 & L_P(\sigma_{Q,W}^\otimes); R_Q(\sigma_{P,W}^\otimes) \\
 &= L_P\left(\bigoplus_j \overline{\sigma_{V_j,W}}\right); R_Q\left(\bigoplus_i \overline{\sigma_{U_i,W}}\right) && \text{(Lemma E.1.8)} \\
 &= \bigoplus_i L_{U_i}\left(\bigoplus_j \overline{\sigma_{V_j,W}}\right); \bigoplus_i R_Q\left(\overline{\sigma_{U_i,W}}\right) && \text{(Def. L, W5)} \\
 &= \bigoplus_i (L_{U_i}\left(\bigoplus_j \overline{\sigma_{V_j,W}}\right); R_Q\left(\overline{\sigma_{U_i,W}}\right)) && \text{(Funct. } \oplus) \\
 &= \bigoplus_i \bigoplus_j \overline{\sigma_{U_i V_j, W}} && (*_2) \\
 &= \sigma_{PQ,W}^\otimes && \text{(Lemma E.1.8)}
 \end{aligned}$$

Now we are ready to prove Equation (W11) by induction on S :

Case $S = 0$: it follows from Definitions 5.5, 5.7 and definition of σ^\otimes .

Case $S = W \oplus S'$:

$$\begin{aligned}
 & L_P(\sigma_{Q,W \oplus S'}^\otimes); R_Q(\sigma_{P,W \oplus S'}^\otimes) \\
 &= L_P(\delta_{Q,W,S'}^l; (\sigma_{Q,W}^\otimes \oplus \sigma_{Q,S'}^\otimes)); R_Q(\delta_{P,W,S'}^l; (\sigma_{P,W}^\otimes \oplus \sigma_{P,S'}^\otimes)) && \text{(Lemma E.1.6)} \\
 &= L_P(\delta_{Q,W,S'}^l; \delta_{P,QW,QS'}^l; (L_P(\sigma_{Q,W}^\otimes) \oplus L_P(\sigma_{Q,S'}^\otimes)); \delta_{P,WQ,S'Q}^{-l}; && \text{(W2, W5)} \\
 &\quad R_Q(\delta_{P,W,S'}^l; (R_Q(\sigma_{P,W}^\otimes) \oplus R_Q(\sigma_{P,S'}^\otimes))) \\
 &= \delta_{PQ,W,S'}^l; \delta_{P,QW,QS'}^{-l}; \delta_{P,QW,QS'}^l; (L_P(\sigma_{Q,W}^\otimes) \oplus L_P(\sigma_{Q,S'}^\otimes)); \delta_{P,WQ,S'Q}^{-l}; && \text{(W17, W16)} \\
 &\quad \delta_{P,WQ,S'Q}^l; (R_Q(\sigma_{P,W}^\otimes) \oplus R_Q(\sigma_{P,S'}^\otimes)) \\
 &= \delta_{PQ,W,S'}^l; (L_P(\sigma_{Q,W}^\otimes) \oplus L_P(\sigma_{Q,S'}^\otimes)); (R_Q(\sigma_{P,W}^\otimes) \oplus R_Q(\sigma_{P,S'}^\otimes)) && \text{(Iso)} \\
 &= \delta_{PQ,W,S'}^l; ((L_P(\sigma_{Q,W}^\otimes); R_Q(\sigma_{P,W}^\otimes)) \oplus (L_P(\sigma_{Q,S'}^\otimes); R_Q(\sigma_{P,S'}^\otimes))) && \text{(Funct. } \oplus) \\
 &= \delta_{PQ,W,S'}^l; (\sigma_{PQ,W}^\otimes \oplus \sigma_{PQ,S'}^\otimes) && (*_3, \text{ ind. hp.}) \\
 &= \sigma_{PQ,W \oplus S'}^\otimes && \text{(Lemma E.1.6)}
 \end{aligned}$$

EQUATION (W12): $R_S(\mathbf{t}); \sigma_{Q,S}^\otimes = \sigma_{P,S}^\otimes; L_S(\mathbf{t})$. First observe that when S is a monomial W , the following holds:

$$R_W(\mathbf{t}); \sigma_{Q,W}^\otimes = \sigma_{P,W}^\otimes; L_W(\mathbf{t}) \quad (*)$$

$$\begin{aligned}
 R_W(\mathbf{t}); \sigma_{Q,W}^\otimes &= R_W(\mathbf{t}); \bigoplus_j \overline{\sigma_{V_j,W}} && \text{(Lemma E.1.8)} \\
 &= \bigoplus_i \overline{\sigma_{U_i,W}}; L_W(\mathbf{t}) && \text{(Lemma E.3)} \\
 &= \sigma_{P,W}^\otimes; L_W(\mathbf{t}) && \text{(Lemma E.1.8)}
 \end{aligned}$$

Then we proceed by induction on S .

Case $S = 0$ it follows from Definitions 5.7 and definition of σ^\otimes .

Case $S = W \oplus S'$:

$$\begin{aligned}
 & R_{W \oplus S'}(\mathbf{t}); \sigma_{Q, W \oplus S'}^{\otimes} \\
 &= \delta_{P, W, S'}^l; (R_W(\mathbf{t}) \oplus R_{S'}(\mathbf{t})); \delta_{Q, W, S'}^{-l}; \delta_{Q, W, S'}^l; (\sigma_{Q, W}^{\otimes} \oplus \sigma_{Q, S'}^{\otimes}) && \text{(W6, Lemma E.1.6)} \\
 &= \delta_{P, W, S'}^l; (R_W(\mathbf{t}) \oplus R_{S'}(\mathbf{t})); (\sigma_{Q, W}^{\otimes} \oplus \sigma_{Q, S'}^{\otimes}) && \text{(Iso)} \\
 &= \delta_{P, W, S'}^l; ((R_W(\mathbf{t}); \sigma_{Q, W}^{\otimes}) \oplus (R_{S'}(\mathbf{t}); \sigma_{Q, S'}^{\otimes})) && \text{(Funct. } \oplus) \\
 &= \delta_{P, W, S'}^l; ((\sigma_{P, W}^{\otimes}; L_W(\mathbf{t})) \oplus (\sigma_{P, S'}^{\otimes}; L_{S'}(\mathbf{t}))) && (*, \text{ ind. hp.}) \\
 &= \delta_{P, W, S'}^l; (\sigma_{P, W}^{\otimes} \oplus \sigma_{P, S'}^{\otimes}); (L_W(\mathbf{t}) \oplus L_{S'}(\mathbf{t})) && \text{(Funct. } \oplus) \\
 &= \sigma_{P, W \oplus S'}^{\otimes}; L_{W \oplus S'}(\mathbf{t}) && \text{(Lemma E.1.6, W6)}
 \end{aligned}$$

EQUATIONS (W14): $L_{ST}(\mathbf{t}) = L_S(L_T(\mathbf{t}))$, (W13): $L_S(R_T(\mathbf{t})) = R_T(L_S(\mathbf{t}))$, (W15): $R_{TS}(\mathbf{t}) = R_S(R_T(\mathbf{t}))$.
 First we prove the particular cases in which S and T are monomials:

$$\begin{aligned}
 L_W(L_Z(\mathbf{t})) &= L_{WZ}(\mathbf{t}) && (*_1) \\
 L_W(R_Z(\mathbf{t})) &= R_Z(L_W(\mathbf{t})) && (*_2) \\
 R_W(R_Z(\mathbf{t})) &= R_{ZW}(\mathbf{t}) && (*_3)
 \end{aligned}$$

All the three equations are proved by induction on \mathbf{t} as follows: the base cases $\mathbf{t} = id_0, \sigma_{U, V}^{\oplus}, \triangleleft_U, \circlearrowleft_U, \triangleright_U, \circlearrowright_U$ are trivial by definition of L and R . For $\mathbf{t} = \overline{c}$ we apply the definition of L and R and the fact that \otimes is associative inside a tape. The inductive cases follow from functoriality of L and R and the inductive hypothesis.

For the general cases, we start with (W14):

$$\begin{aligned}
 L_S(L_T(\mathbf{t})) &= \bigoplus_k \bigoplus_l L_{W_k}(L_{Z_l}(\mathbf{t})) && \text{(Def. } L) \\
 &= \bigoplus_k \bigoplus_l L_{W_k Z_l}(\mathbf{t}) && (*_1) \\
 &= L_{ST}(\mathbf{t}) && \text{(Def. } L)
 \end{aligned}$$

Regarding Equation (W13), first observe that the following holds:

$$R_W(L_T(\mathbf{t})) = L_T(R_W(\mathbf{t})) \quad (*)$$

indeed:

$$\begin{aligned}
 R_W(L_T(\mathbf{t})) &= R_W\left(\bigoplus_l L_{Z_l}(\mathbf{t})\right) && \text{(Def. } L) \\
 &= \bigoplus_l R_W(L_{Z_l}(\mathbf{t})) && \text{(Def. } R) \\
 &= \bigoplus_l L_{Z_l}(R_W(\mathbf{t})) && (*_2) \\
 &= L_T(R_W(\mathbf{t})) && \text{(Def. } L)
 \end{aligned}$$

Then we proceed by induction on S :

Case $S = 0$: it follows from Definition 5.7 and (W4).

Case $S = W \oplus S'$:

$$\begin{aligned}
 & R_{W \oplus S'}(L_T(\mathbf{t})) \\
 &= \delta_{TP, W, S'}^l; (R_W(L_T(\mathbf{t})) \oplus R_{S'}(L_T(\mathbf{t}))); \delta_{TQ, W, S'}^{-l} && \text{(Def. } R) \\
 &= \delta_{TP, W, S'}^l; (L_T(R_W(\mathbf{t})) \oplus L_T(R_{S'}(\mathbf{t}))); \delta_{TQ, W, S'}^{-l} && (*, \text{ ind. hp.}) \\
 &= \delta_{TP, W, S'}^l; \delta_{T, PW, PS'}^{-l}; L_T(R_W(\mathbf{t}) \oplus R_{S'}(\mathbf{t})); \delta_{T, QW, QS'}^l; \delta_{TQ, W, S'}^{-l} && \text{(W5)} \\
 &= L_T(\delta_{P, W, S'}^l); L_T(R_W(\mathbf{t}) \oplus R_{S'}(\mathbf{t})); L_T(\delta_{Q, W, S'}^{-l}) && \text{(W17)} \\
 &= L_T(\delta_{P, W, S'}^l; (R_W(\mathbf{t}) \oplus R_{S'}(\mathbf{t})); \delta_{Q, W, S'}^{-l}) && \text{(W2)} \\
 &= L_T(R_{W \oplus S'}(\mathbf{t})) && \text{(W6)}
 \end{aligned}$$

Equation (W15) is proved by means of the other two:

$$\begin{aligned}
 R_{TS}(\mathbf{t}) &= \sigma_{P, TS}^\otimes; L_{TS}(\mathbf{t}); \sigma_{TS, Q}^\otimes && \text{(W12)} \\
 &= \sigma_{P, TS}^\otimes; L_T(L_S(\mathbf{t})); \sigma_{TS, Q}^\otimes && \text{(W14)} \\
 &= R_S(\sigma_{P, T}^\otimes); L_T(\sigma_{P, S}^\otimes); L_T(L_S(\mathbf{t})); L_T(\sigma_{S, Q}^\otimes); R_S(\sigma_{T, Q}^\otimes) && \text{(W11)} \\
 &= R_S(\sigma_{P, T}^\otimes); L_T(\sigma_{P, S}^\otimes; L_S(\mathbf{t}); \sigma_{S, Q}^\otimes); R_S(\sigma_{T, Q}^\otimes) && \text{(W2)} \\
 &= R_S(\sigma_{P, T}^\otimes); L_T(R_S(\mathbf{t})); R_S(\sigma_{T, Q}^\otimes) && \text{(W12)} \\
 &= R_S(\sigma_{P, T}^\otimes); R_S(L_T(\mathbf{t})); R_S(\sigma_{T, Q}^\otimes) && \text{(W13)} \\
 &= R_S(\sigma_{P, T}^\otimes; L_T(\mathbf{t}); \sigma_{T, Q}^\otimes) && \text{(W2)} \\
 &= R_S(R_T(\mathbf{t})) && \text{(W12)}
 \end{aligned}$$

EQUATION (W7): $L_P(\mathbf{t}_2); R_S(\mathbf{t}_1) = R_R(\mathbf{t}_1); L_Q(\mathbf{t}_2)$. Let $\mathbf{t}_1: P \rightarrow Q, \mathbf{t}_2: R \rightarrow S$, then we show by induction on \mathbf{t}_1 that

$$L_P(\mathbf{t}_2); R_S(\mathbf{t}_1) = R_R(\mathbf{t}_1); L_Q(\mathbf{t}_2)$$

Case $\mathbf{t}_1 = id_0$: by (W1), $R_S(id_0) = id_0 = R_R(id_0)$. By definition, $L_0(\mathbf{t}_2) = id_0$.

Case $\mathbf{t}_1 = \overline{c}$: it holds by Lemma E.4.

Case $\mathbf{t}_1 = \sigma_{U, V}^\oplus, \triangleleft_U, \uparrow_U$: these cases all follow the same pattern, thus we show only the one for \triangleleft_U :

$$\begin{aligned}
 L_U(\mathbf{t}_2); R_S(\triangleleft_U) &= L_U(\mathbf{t}_2); \triangleleft_{US} && \text{(W8)} \\
 &= \triangleleft_{UR}; (L_U(\mathbf{t}_2) \oplus L_U(\mathbf{t}_2)) && \text{(\triangleleft-nat)} \\
 &= R_R(\triangleleft_U); (L_U(\mathbf{t}_2) \oplus L_U(\mathbf{t}_2)) && \text{(W8)} \\
 &= R_R(\triangleleft_U); (L_{U \oplus U}(\mathbf{t}_2)) && \text{(Def. } L)
 \end{aligned}$$

Case $\mathbf{t}_1 = \mathbf{t}'_1; \mathbf{t}''_1$: Suppose $\mathbf{t}'_1: P \rightarrow P', \mathbf{t}''_1: P' \rightarrow Q, \mathbf{t}_2: R \rightarrow S$

$$\begin{aligned}
 L_P(\mathbf{t}_2); R_S(\mathbf{t}'_1; \mathbf{t}''_1) &= L_P(\mathbf{t}_2); R_S(\mathbf{t}'_1); R_S(\mathbf{t}''_1) && \text{(W2)} \\
 &= R_R(\mathbf{t}'_1); L_{P'}(\mathbf{t}_2); R_S(\mathbf{t}''_1) && \text{(Ind. hp.)} \\
 &= R_R(\mathbf{t}'_1); R_R(\mathbf{t}''_1); L_Q(\mathbf{t}_2) && \text{(Ind. hp.)} \\
 &= R_R(\mathbf{t}'_1; \mathbf{t}''_1); L_Q(\mathbf{t}_2) && \text{(W2)}
 \end{aligned}$$

Case $\mathbf{t}_1 = \mathbf{t}'_1 \oplus \mathbf{t}''_1$: Suppose $\mathbf{t}'_1: P_1 \rightarrow Q_1, \mathbf{t}''_1: P' \rightarrow Q', \mathbf{t}_2: R \rightarrow S$

$$\begin{aligned}
 L_{P_1 \oplus P'}(\mathbf{t}_2); R_S(\mathbf{t}'_1 \oplus \mathbf{t}''_1) &= (L_{P_1}(\mathbf{t}_2) \oplus L_{P'}(\mathbf{t}_2)); (R_S(\mathbf{t}'_1) \oplus R_S(\mathbf{t}''_1)) && \text{(W6, W5)} \\
 &= (L_{P_1}(\mathbf{t}_2); R_S(\mathbf{t}'_1)) \oplus (L_{P'}(\mathbf{t}_2); R_S(\mathbf{t}''_1)) && \text{(Funct. } \oplus) \\
 &= (R_R(\mathbf{t}'_1); L_{Q_1}(\mathbf{t}_2)) \oplus (R_R(\mathbf{t}''_1); L_{Q'}(\mathbf{t}_2)) && \text{(Ind. hp.)} \\
 &= (R_R(\mathbf{t}'_1) \oplus R_R(\mathbf{t}''_1)); (L_{Q_1}(\mathbf{t}_2) \oplus L_{Q'}(\mathbf{t}_2)) && \text{(Funct. } \oplus) \\
 &= R_R(\mathbf{t}'_1 \oplus \mathbf{t}''_1); L_{Q_1 \oplus Q'}(\mathbf{t}_2) && \text{(W6, W5)}
 \end{aligned}$$

This concludes the proof of Lemma 5.9.

E.4 Other proofs of Section 5

PROOF OF LEMMA 5.2. Given a strict fb category \mathbf{D} and functor $H: \mathbf{C} \rightarrow U_2(\mathbf{D})$, one can define the fb-functor $H^\sharp: F_2(\mathbf{C}) \rightarrow \mathbf{D}$ inductively on objects of $F_2(\mathbf{C})$ as

$$H^\sharp(I) = I \quad H^\sharp(AW) = H(A) \odot H^\sharp(W)$$

and on arrows as

$$\begin{aligned}
 H^\sharp(id_I) &= id_I & H^\sharp(id_A) &= H(id_A) & H^\sharp(\overline{c}) &= H(c) \\
 H^\sharp(f; g) &= H^\sharp(f); H^\sharp(g) & H^\sharp(f \odot g) &= H^\sharp(f) \odot H^\sharp(g) & H^\sharp(\sigma_{A,B}) &= \sigma_{H(A), H(B)} \\
 H^\sharp(\uparrow_A) &= \uparrow_{H(A)} & H^\sharp(\triangleleft_A) &= \triangleleft_{H(A)} & H^\sharp(\circlearrowleft_A) &= \circlearrowleft_{H(A)} & H^\sharp(\triangleright_A) &= \triangleright_{H(A)}
 \end{aligned}$$

Observe that H^\sharp is well-defined:

$$\begin{aligned}
 H^\sharp(\overline{c; d}) &= H(c; d) && \text{(Def. } H^\sharp) \\
 &= H(c); H(d) && \text{(Fun. } H) \\
 H^\sharp(\overline{id_A}) &= H(id_A) && \text{(Def. } H^\sharp) \\
 &= H^\sharp(id_A) && \text{(Def. } H^\sharp) \\
 &= H^\sharp(\overline{c}); H^\sharp(\overline{d}) && \text{(Def. } H^\sharp) \\
 &= H^\sharp(\underline{c}; \underline{d}) && \text{(Fun. } H^\sharp)
 \end{aligned}$$

The axioms in Tables 1 and 3 are preserved by H^\sharp , since they hold in \mathbf{D} . By definition, $\overline{\cdot}; \underline{\cdot}; H^\sharp = H$. Moreover H^\sharp is the unique strict fb functor satisfying this equation. Thus indeed $F_2 \dashv U_2$. \square

PROOF OF THEOREM 5.10. Observe that for all objects S and arrows $\mathbf{t}: P \rightarrow Q$, it holds that

$$\mathbf{t} \otimes id_S = R_S(\mathbf{t}) \quad id_S \otimes \mathbf{t} = L_S(\mathbf{t}) \quad (33)$$

as shown below:

$$\begin{aligned}
 \mathbf{t} \otimes id_S &= L_P(id_S); R_S(\mathbf{t}) && \text{(Def. } \otimes) & id_S \otimes \mathbf{t} &= L_S(\mathbf{t}); R_Q(id_S) && \text{(Def. } \otimes) \\
 &= R_S(\mathbf{t}) && \text{(W1)} & &= L_S(\mathbf{t}) && \text{(W1)}
 \end{aligned}$$

Thus $id_P \otimes id_Q \stackrel{(33)}{=} L_P(id_Q) \stackrel{(W1)}{=} id_{P \otimes Q}$. To conclude functoriality of \otimes , the key is the sliding law (W7): for all $\mathbf{t}_1: P \rightarrow Q, \mathbf{t}_2: Q \rightarrow S, \mathbf{t}_3: P' \rightarrow Q', \mathbf{t}_4: Q' \rightarrow S'$,

$$\begin{aligned}
 (\mathbf{t}_1; \mathbf{t}_2) \otimes (\mathbf{t}_3; \mathbf{t}_4) &= L_P(\mathbf{t}_3; \mathbf{t}_4); R_{S'}(\mathbf{t}_1; \mathbf{t}_2) && \text{(Def. } \otimes) \\
 &= L_P(\mathbf{t}_3); L_P(\mathbf{t}_4); R_{S'}(\mathbf{t}_1); R_{S'}(\mathbf{t}_2) && \text{(W2)} \\
 &= L_P(\mathbf{t}_3); R_{Q'}(\mathbf{t}_1); L_Q(\mathbf{t}_4); R_{S'}(\mathbf{t}_2) && \text{(W7)} \\
 &= (\mathbf{t}_1 \otimes \mathbf{t}_3); (\mathbf{t}_2 \otimes \mathbf{t}_4) && \text{(Def. } \otimes)
 \end{aligned}$$

By (33) and (W3) it immediately follows that

$$id_1 \otimes t = t = t \otimes id_1$$

For associativity of \otimes , observe that for all $t_1: P_1 \rightarrow Q_1, t_2: P_2 \rightarrow Q_2, t_3: P_3 \rightarrow Q_3$,

$$\begin{aligned} ((t_1 \otimes t_2) \otimes t_3) &= L_{P_1 P_2}(t_3); R_{Q_3}(L_{P_1}(t_2); R_{Q_2}(t_1)) && \text{(Def. } \otimes) \\ &= L_{P_1 P_2}(t_3); R_{Q_3}(L_{P_1}(t_2)); R_{Q_3}(R_{Q_2}(t_1)) && \text{(W2)} \\ &= L_{P_1}(L_{P_2}(t_3)); L_{P_1}(R_{Q_3}(t_2)); R_{Q_2 Q_3}(t_1) && \text{(W14, W13, W15)} \\ &= L_{P_1}(L_{P_2}(t_3)); R_{Q_3}(t_2); R_{Q_2 Q_3}(t_1) && \text{(W2)} \\ &= (t_1 \otimes (t_2 \otimes t_3)) && \text{(Def. } \otimes) \end{aligned}$$

So far, we proved that $(\mathbf{T}_\Sigma, \otimes, 1)$ is a strict monoidal category. For symmetries, observe that naturality follows immediately by (33) and (W12). Inverses is Lemma E.1.5 and the coherence axioms (S2) and (S3) hold by Lemma E.1.7 and (W11).

By construction $(\mathbf{T}_\Sigma, \oplus, 0, \sigma^\oplus)$ is a symmetric strict monoidal category. We are left to prove a few laws. First,

$$id_0 \otimes t = id_0 = t \otimes id_0$$

hold by (33) and (W4). Regarding right distributivity of \otimes over \oplus , observe that for all $t_1: P_1 \rightarrow Q_1, t_2: P_2 \rightarrow Q_2, t_3: P_3 \rightarrow Q_3$ it holds that:

$$\begin{aligned} (t_1 \oplus t_2) \otimes t_3 &= L_{P_1 \oplus P_2}(t_3); R_{Q_3}(t_1 \oplus t_2) && \text{(Def. } \otimes) \\ &= (L_{P_1}(t_3) \oplus L_{P_2}(t_3)); (R_{Q_3}(t_1) \oplus R_{Q_3}(t_2)) && \text{(W6, W5)} \\ &= (L_{P_1}(t_3); R_{Q_3}(t_1)) \oplus (L_{P_2}(t_3); R_{Q_3}(t_2)) && \text{(Funct. } \oplus) \\ &= (t_1 \otimes t_3) \oplus (t_2 \otimes t_3) && \text{(Def. } \otimes) \end{aligned}$$

(This is tantamount to saying that \mathbf{T}_Σ has a natural right distributor whose components $\delta_{P, Q, R}^r$ are all identity morphisms).

Next we have to check the axioms of coherence for strict rig categories that amount just to (R1), (R2), (R5) and (R9) from Figure 7. Axiom (R1) is Lemma E.1.6. Axiom (R2) follows by (33) and (W10). Axiom (R5) is Lemma E.1.2. Axiom (R9) holds by definition of σ^\otimes in Table 4b. Finally, from Axiom (R1) and the naturality of the right distributor and of σ^\otimes we get that also δ^l is natural. This proves that \mathbf{T}_Σ is a strict rig category. $(\mathbf{T}_\Sigma, \oplus, 0, \sigma^\oplus)$ is a finite biproduct category by definition.

All that is left to do is to prove that the inclusion functor $\mathcal{S} \rightarrow \mathbf{T}_\Sigma$ makes \mathbf{T}_Σ a \mathcal{S} -sesquistrict fb rig category according to Definition 4.3. This means that we have to show that $\delta_{A, Q, R}^l = id_{(A \otimes Q) \oplus (A \otimes R)}$ in \mathbf{T}_Σ for all $A \in \mathcal{S}$, which is easily inferred from the inductive definition of $\delta_{P, Q, R}^l$. \square

PROOF OF THEOREM 5.11. We have a trivial interpretation of (\mathcal{S}, Σ) in $\mathcal{S} \rightarrow \mathbf{T}_\Sigma$, given by $(id_{\mathcal{S}}, \bar{_})$. Suppose now that $H: \mathbf{M} \rightarrow \mathbf{D}$ is a sesquistrict fb rig category with an interpretation $\mathcal{I} = (\alpha_{\mathcal{S}}: \mathcal{S} \rightarrow Ob(\mathbf{M}), \alpha_\Sigma: \Sigma \rightarrow Ar(\mathbf{D}))$. We aim to find a sesquistrict fb rig functor $(\alpha: \mathcal{S} \rightarrow \mathbf{M}, \beta: \mathbf{T}_\Sigma \rightarrow \mathbf{D})$ such that $id_{\mathcal{S}}; \alpha = \alpha_{\mathcal{S}}$ and $\bar{_}; \beta = \alpha_\Sigma$. Since (\mathcal{S}, Σ) is a monoidal signature, \mathcal{I} is in fact a monoidal interpretation of (\mathcal{S}, Σ) into the ssm category $(\mathbf{D}, \otimes, 1)$, hence by freeness of \mathbf{C}_Σ there exists a unique ssm functor $\llbracket - \rrbracket_{\mathcal{I}}: \mathbf{C}_\Sigma \rightarrow \mathbf{D}$ that extends \mathcal{I} . Now, because $\mathbf{T}_\Sigma = F_2(\mathbf{C}_\Sigma)$ is by definition the free fb category generated by \mathbf{C}_Σ and \mathbf{D} is also a fb category, we have that there is a unique fb functor $\beta: \mathbf{T}_\Sigma \rightarrow \mathbf{D}$ that extends $\llbracket - \rrbracket_{\mathcal{I}}$. Now we prove that β preserves the rest of the rig structure in several steps. For the rest of this proof, to lighten up the calculations, with little abuse of notation we will treat β as if it were the identity on objects. The context will make clear whether we will be speaking of $P \in Ob(\mathbf{T}_\Sigma)$ or of $\beta(P) \in Ob(\mathbf{D})$.

i. We show that $\beta(\delta_{P,Q,R}^l) = \delta_{P,Q,R}^l$ by induction on P .

Case $P = 0$:

$$\begin{aligned} \beta(\delta_{0,Q,R}^l) &= \beta(id_0) && \text{(Def. } \delta^l) \\ &= id_0 && \text{(Def. } \beta) \\ &= \delta_{0,Q,R}^l && (26) \end{aligned}$$

Case $P = U \oplus P'$:

$$\begin{aligned} \beta(\delta_{U \oplus P', Q, R}^l) &= \beta((id_{U(Q \oplus R)} \oplus \delta_{P', Q, R}^l); (id_{UQ} \oplus \sigma_{U R, P' Q}^\oplus \oplus id_{P' R})) && \text{(Def. } \delta^l) \\ &= (\beta(id_{U(Q \oplus R)}) \oplus \beta(\delta_{P', Q, R}^l)); (\beta(id_{UQ}) \oplus \beta(\sigma_{U R, P' Q}^\oplus) \oplus \beta(id_{P' R})) && \text{(Funct. } \beta) \\ &= (id_{U(Q \oplus R)} \oplus \delta_{P', Q, R}^l); (id_{UQ} \oplus \sigma_{U R, P' Q}^\oplus \oplus id_{P' R}) && \text{(Def. } \beta) \\ &= (\delta_{U, Q, R}^l \oplus \delta_{P', Q, R}^l); (id_{UQ} \oplus \sigma_{U R, P' Q}^\oplus \oplus id_{P' R}) && \text{(Def. } \delta^l) \\ &= \delta_{U \oplus P', Q, R}^l. && (R5) \end{aligned}$$

ii. Next we prove that $\beta(\sigma_{P,Q}^\otimes) = \sigma_{P,Q}^\otimes$ by induction on Q .

Case $Q = 0$: it follows from definitions of σ^\otimes and β .

Case $Q = V \oplus Q'$:

$$\begin{aligned} \beta(\sigma_{P, V \oplus Q'}^\otimes) &= \beta(\delta_{P, V, Q'}^l; (\bigoplus_i \overline{\sigma_{U_i, V}} \oplus \sigma_{P, Q'}^\otimes)) && \text{(Def. } \sigma^\otimes) \\ &= \beta(\delta_{P, V, Q'}^l; (\bigoplus_i \beta(\overline{\sigma_{U_i, V}}) \oplus \beta(\sigma_{P, Q'}^\otimes))) && \text{(Def. } \beta) \\ &= \delta_{P, V, Q'}^l; (\bigoplus_i \beta(\overline{\sigma_{U_i, V}}) \oplus \beta(\sigma_{P, Q'}^\otimes)) && (i.) \\ &= \delta_{P, V, Q'}^l; (\bigoplus_i \sigma_{U_i, V}^\otimes \oplus \sigma_{P, Q'}^\otimes) && \text{(Def. } \beta, \text{ ind. hp.)} \\ &= \delta_{P, V, Q'}^l; (\sigma_{P, V}^\otimes \oplus \sigma_{P, Q'}^\otimes) && \text{(Lemma D.3)} \\ &= \sigma_{P, V \oplus Q'}^\otimes && (R1) \end{aligned}$$

iii. Now we show that if $t: P \rightarrow Q$ be a tape diagram, then $\beta(R_W(t)) = \beta(t) \otimes id_W$. We reason by induction on t .

Case $t = id_0$: $\beta(R_W(id_0)) = \beta(id_0) = id_0 = id_0 \otimes id_W = \beta(id_0) \otimes id_W$

Case c : $\beta(R_W(\overline{c})) = \beta(\overline{c \otimes id_W}) = c \otimes id_W = \beta(\overline{c}) \otimes id_W$

Case $\sigma_{U,V}^\oplus$: $\beta(R_W(\sigma_{U,V}^\oplus)) = \beta(\sigma_{UW, VW}^\oplus) = \sigma_{UW, VW}^\oplus \stackrel{(R2)}{=} \sigma_{U,V}^\oplus \otimes id_W = \beta(\sigma_{U,V}^\oplus) \otimes id_W$

Case \triangleleft_U : $\beta(R_W(\triangleleft_U)) = \beta(\triangleleft_{UW}) = \triangleleft_{UW} \stackrel{\text{Prop. D.1}}{=} \triangleleft_U \otimes id_W = \beta(\triangleleft_U) \otimes id_W$ and analogously for $\hat{\triangleright}_U, \triangleright_U, \hat{\triangleleft}_U$.

Case $t = t_1; t_2$: $\beta(R_W((t_1; t_2))) = \beta(R_W(t_1)); \beta(R_W(t_2)) = (\beta(t_1) \otimes id_W); (\beta(t_2) \otimes id_W) = (\beta(t_1); \beta(t_2)) \otimes id_W = \beta(t_1; t_2) \otimes id_W$

Case $t = t_1 \oplus t_2$: $\beta(R_W((t_1 \oplus t_2))) = \beta(R_W(t_1)) \oplus \beta(R_W(t_2)) = (\beta(t_1) \otimes id_W) \oplus (\beta(t_2) \otimes id_W) = (\beta(t_1) \oplus \beta(t_2)) \otimes id_W = \beta(t_1 \oplus t_2) \otimes id_W$.

iv. Next we show that if $t: P \rightarrow Q$ be a tape diagram, then

(a) $\beta(R_S(t)) = \beta(t) \otimes id_S$

(b) $\beta(L_S(\mathbf{t})) = id_S \otimes \beta(\mathbf{t})$

We prove the first point by induction on S :

Case $S = 0$: $\beta(R_0(\mathbf{t})) = \beta(id_0) = id_0 = \beta(\mathbf{t}) \otimes id_0$.

Case $S = W \oplus S'$:

$$\begin{aligned}
 \beta(R_{W \oplus S'}(\mathbf{t})) &= \beta(\delta_{P,W,S'}^l; (R_W(\mathbf{t}) \oplus R_{S'}(\mathbf{t})); \delta_{Q,W,S'}^l) && \text{(W6)} \\
 &= \beta(\delta_{P,W,S'}^l; (\beta(R_W(\mathbf{t})) \oplus \beta(R_{S'}(\mathbf{t}))); \beta(\delta_{Q,W,S'}^l)) && \text{(Def. } \beta) \\
 &= \delta_{P,W,S'}^l; (\beta(R_W(\mathbf{t})) \oplus \beta(R_{S'}(\mathbf{t}))); \delta_{Q,W,S'}^l && \text{(i)} \\
 &= \delta_{P,W,S'}^l; ((\beta(\mathbf{t}) \otimes id_W) \oplus (\beta(\mathbf{t}) \otimes id_{S'})); \delta_{Q,W,S'}^l && \text{(iii, ind. hp.)} \\
 &= \beta(\mathbf{t}) \otimes (id_W \oplus id_{S'}) && \text{(Nat. } \delta^l) \\
 &= \beta(\mathbf{t}) \otimes id_{W \oplus S'} && \text{(Funct. } \oplus)
 \end{aligned}$$

For the second point, we use the first point and naturality of \otimes -symmetries.

$$\begin{aligned}
 \beta(L_S(\mathbf{t})) &= \beta(\sigma_{S,P}^\otimes; \sigma_{P,S}^\otimes; L_S(\mathbf{t})) && \text{(Lemma E.1.5)} \\
 &= \beta(\sigma_{S,P}^\otimes; R_S(\mathbf{t}); \sigma_{Q,S}^\otimes) && \text{(W12)} \\
 &= \beta(\sigma_{S,P}^\otimes); \beta(R_S(\mathbf{t})); \beta(\sigma_{Q,S}^\otimes) && \text{(Funct. } \beta) \\
 &= \sigma_{S,P}^\otimes; \beta(R_S(\mathbf{t})); \sigma_{Q,S}^\otimes && \text{(ii)} \\
 &= \sigma_{S,P}^\otimes; (\beta(\mathbf{t}) \otimes id_S); \sigma_{Q,S}^\otimes && \text{(iv.a)} \\
 &= id_S \otimes \beta(\mathbf{t}) && \text{(Nat. } \sigma^\otimes)
 \end{aligned}$$

v. Finally, we prove that if $\mathbf{t}_1: P \rightarrow Q$, $\mathbf{t}_2: R \rightarrow S$ are tape diagrams, then $\beta(\mathbf{t}_1 \otimes \mathbf{t}_2) = \beta(\mathbf{t}_1) \otimes \beta(\mathbf{t}_2)$:

$$\begin{aligned}
 \beta(\mathbf{t}_1 \otimes \mathbf{t}_2) &= \beta(L_P(\mathbf{t}_2); R_S(\mathbf{t}_1)) && \text{(Def. } \otimes) \\
 &= \beta(L_P(\mathbf{t}_2)); \beta(R_S(\mathbf{t}_1)) && \text{(Funct. } \beta) \\
 &= (id_P \otimes \beta(\mathbf{t}_2)); (\beta(\mathbf{t}_1) \otimes id_S) && \text{(iv)} \\
 &= \beta(\mathbf{t}_1) \otimes \beta(\mathbf{t}_2) && \text{(Funct. } \otimes)
 \end{aligned}$$

This concludes the proof of Theorem 5.11. \square

PROOF OF COROLLARY 5.12. Recall our convention following Lemma 4.6 that in fact we are considering the codomain of F to be $\overline{\mathbf{D}}$, and that we will expect the codomain of F^\sharp also to be $\overline{\mathbf{D}}$. Let us call \overline{I}_M and \overline{I}_R the obvious interpretations of (\mathcal{S}, Σ) in \mathbf{C}_Σ and in \mathbf{T}_Σ , respectively (the first is a monoidal, the second a sesquistrict rig interpretation). Notice that $\overline{I}_R = \overline{\cdot} \circ \overline{I}_M$. We have that F induces a sesquistrict rig interpretation $F \circ \overline{I}_M$ of (\mathcal{S}, Σ) in $\overline{\mathbf{D}}$, given by

$$\begin{array}{ccc}
 \mathcal{S} & \xrightarrow{\alpha_S} & Ob(\mathbf{D}) & \quad & \Sigma & \xrightarrow{\alpha_\Sigma} & Ar(\overline{\mathbf{D}}) \\
 A & \longmapsto & F(A) & \quad & f & \longmapsto & F(f)
 \end{array}$$

(we are assuming that $F(A)$ is a unary word of a unary word as a consequence of Lemma 4.6). This makes $(\alpha_S, \alpha_\Sigma)$ an interpretation because F is strict monoidal. Indeed, if $ar(f) = U$ with $U = A_1 \dots A_n$, then the domain of $\alpha_\Sigma(f) = F(f)$ in $\overline{\mathbf{D}}$ is the formal monomial $F(U) = F(A_1) \otimes \dots \otimes F(A_n)$, which is the result of applying the inductive extension of iF to $U \in \mathcal{S}^*$ ($i: \mathbf{D} \rightarrow \overline{\mathbf{D}}$ being the inclusion functor). Since \mathbf{T}_Σ is the free sesquistrict fb rig category generated by (\mathcal{S}, Σ) , there exists a unique strict fb rig functor $F^\sharp: \mathbf{T}_\Sigma \rightarrow \mathbf{D}$ such that

- the pair (α_S, F^\sharp) is a sesquistrict fb rig functor from $(\mathcal{S} \rightarrow \mathbf{T}_\Sigma)$ to $(Ob(\mathbf{D}) \rightarrow \overline{\mathbf{D}})$,

- $F^\sharp \circ \mathcal{I}_R = F \circ \mathcal{I}_M$.

The second condition means that $F^\sharp(\overline{f}) = F(f)$ for all $f \in \Sigma$. Now we want to prove that $F^\sharp(\overline{c}) = F(\overline{c})$ for every circuit $c \in \mathbf{C}_\Sigma$.

We note that $F^\sharp \circ \mathcal{I}_R$ is in fact a monoidal interpretation of (\mathcal{S}, Σ) in the ssm category $(\mathbf{D}, \otimes, 1)$, given by

$$\alpha'_S = \alpha_S \quad \begin{array}{l} \Sigma \xrightarrow{\alpha'_\Sigma} \text{Ar}(\mathbf{D}) \\ f \longmapsto F^\sharp(\overline{f}) \end{array}$$

Now, since \mathbf{C}_Σ is the free strict symmetric monoidal category generated by (\mathcal{S}, Σ) , there exists a unique strict monoidal functor $G: \mathbf{C}_\Sigma \rightarrow \mathbf{D}$ such that $G \circ \mathcal{I}_M = F^\sharp \circ \mathcal{I}_R$. But both $G = F$ and $G = F^\sharp \circ \overline{\cdot}$ satisfy the above equation. Hence $F = F^\sharp \circ \overline{\cdot}$.

Regarding uniqueness: we have shown that every functor $H: \mathbf{T}_\Sigma \rightarrow \mathbf{D}$ extending the interpretation $F \circ \mathcal{I}_M$ also satisfies $F = H \circ \overline{\cdot}$. Vice versa, any functor H extending F via $\overline{\cdot}$ clearly extends the interpretation $F \circ \mathcal{I}_M$. Hence these two sets are in bijective correspondence, and by freeness of \mathbf{T}_Σ we know that there is only one F^\sharp extending the interpretation $F \circ \mathcal{I}_M$. Thus we conclude. \square

We conclude by proving Theorem 5.15. For this, it is convenient to first prove the following two lemmas.

PROOF OF THEOREM 5.15. In the main text, we claimed that $\lesssim_{\hat{\mathbb{I}}}$ is closed under \otimes , i.e. that if $\mathbf{t}_1 \lesssim_{\hat{\mathbb{I}}} \mathbf{t}_2$ and $\mathbf{s}_1 \lesssim_{\hat{\mathbb{I}}} \mathbf{s}_2$, then $\mathbf{t}_1 \otimes \mathbf{s}_1 \lesssim_{\hat{\mathbb{I}}} \mathbf{t}_2 \otimes \mathbf{s}_2$. This is immediate using the definition of \otimes and Lemma E.6, which we prove below. \square

Lemma E.5. *If $\mathbf{t}_1 \lesssim_{\hat{\mathbb{I}}} \mathbf{t}_2$, then $R_U(\mathbf{t}_1) \lesssim_{\hat{\mathbb{I}}} R_U(\mathbf{t}_2)$ for all monomials U .*

PROOF. We proceed by induction on the rule generating $\lesssim_{\hat{\mathbb{I}}}$.

If $\mathbf{t}_1 \lesssim_{\hat{\mathbb{I}}} \mathbf{t}_2$ by rule $(\hat{\mathbb{I}})$, then $\mathbf{t}_1 \lesssim_{\hat{\mathbb{I}}} \mathbf{t}_2$, i.e. there exists $(\mathbf{t}'_1, \mathbf{t}'_2) \in \mathbb{I}$ and $V \in S^*$ such that $\mathbf{t}_i = R_V(\mathbf{t}'_i)$. Thus $R_U(\mathbf{t}_i) = R_U(R_V(\mathbf{t}'_i)) \stackrel{(\text{W15})}{=} R_{VU}(\mathbf{t}'_i)$. Since $(\mathbf{t}'_1, \mathbf{t}'_2) \in \mathbb{I}$, by definition of $\hat{\mathbb{I}}$, it holds that $\mathbf{t}'_1 \hat{\mathbb{I}} \mathbf{t}'_2$ and thus, by rule $(\hat{\mathbb{I}})$, it holds that $R_U(\mathbf{t}_1) \lesssim_{\hat{\mathbb{I}}} R_U(\mathbf{t}_2)$.

If $\mathbf{t}_1 \lesssim_{\hat{\mathbb{I}}} \mathbf{t}_2$ by rule (t) , then there exists \mathbf{t} such that $\mathbf{t}_1 \lesssim_{\hat{\mathbb{I}}} \mathbf{t}$ and $\mathbf{t} \lesssim_{\hat{\mathbb{I}}} \mathbf{t}_2$. By induction hypothesis, it holds that $R_U(\mathbf{t}_1) \lesssim_{\hat{\mathbb{I}}} R_U(\mathbf{t})$ and $R_U(\mathbf{t}) \lesssim_{\hat{\mathbb{I}}} R_U(\mathbf{t}_2)$. Thus by rule (t) , $R_U(\mathbf{t}_1) \lesssim_{\hat{\mathbb{I}}} R_U(\mathbf{t}_2)$.

The cases for $;$ and \oplus exploit induction in the same way and the laws (W2) and (W5) expressing the fact that $R_U(-)$ preserves both $;$ and \oplus . The case for (r) is trivial. \square

Lemma E.6. *If $\mathbf{t}_1 \lesssim_{\hat{\mathbb{I}}} \mathbf{t}_2$, then $R_S(\mathbf{t}_1) \lesssim_{\hat{\mathbb{I}}} R_S(\mathbf{t}_2)$ and $L_S(\mathbf{t}_1) \lesssim_{\hat{\mathbb{I}}} L_S(\mathbf{t}_2)$ for all polynomials S .*

PROOF. We first show the case for $R_S(-)$. The proof proceed by induction on S .

Case $S = 0$: $R_0(\mathbf{t}_1) = id_0 \lesssim_{\hat{\mathbb{I}}} id_0 = R_0(\mathbf{t}_2)$.

Case $S = W \oplus S'$:

$$\begin{aligned} R_{W \oplus S'}(\mathbf{t}_1) &= \delta_{P,W,S'}^l; (R_W(\mathbf{t}_1) \oplus R_{S'}(\mathbf{t}_1)); \delta_{Q,W,S'}^{-l} && (\text{Def. } R) \\ &\lesssim_{\hat{\mathbb{I}}} \delta_{P,W,S'}^l; (R_W(\mathbf{t}_2) \oplus R_{S'}(\mathbf{t}_1)); \delta_{Q,W,S'}^{-l} && (\text{Lemma E.5, Rules } (r), (;), (\oplus)) \\ &\lesssim_{\hat{\mathbb{I}}} \delta_{P,W,S'}^l; (R_W(\mathbf{t}_2) \oplus R_{S'}(\mathbf{t}_2)); \delta_{Q,W,S'}^{-l} && (\text{Ind. Hyp., Rules } (r), (;), (\oplus)) \\ &= R_{W \oplus S'}(\mathbf{t}_2) && (\text{Def. } R) \end{aligned}$$

The proof for $L_S(-)$ is trivial using the result for $R_S(-)$ and (W12). \square

F APPENDIX TO SECTION 6

In this Appendix we dive into the details of the calculus of matrices for categories with finite biproducts. In Section F.1 we present the standard calculus in the general setting of an arbitrary fb category. In Section F.2 we prove Theorem 6.5, showing how $F_2(\mathbf{C})$ and $\mathbf{Mat}(\mathbf{C}^+)$ are isomorphic as fb rig categories. In Section F.3 we define in detail the Kronecker product on $\mathbf{Mat}(\mathbf{C}_\Sigma^+)$ and we show that it coincides with the monoidal product inherited from $F_2(\mathbf{C}_\Sigma) = \mathbf{T}_\Sigma$. Finally, Section F.4 is dedicated to the proof of Theorem 6.9.

F.1 Matrix calculus for categories with finite biproducts

It is well known that morphisms in a fb category have a matrix representation such that composition corresponds to the usual matrix multiplication (see, for example, [46]). Here we recall how the correspondence is defined and a few useful properties. For the rest of this section we denote the composite of two morphisms $f_1: X \rightarrow Y$ and $f_2: Y \rightarrow Z$ as $f_2 \circ f_1: X \rightarrow Z$.

Definition F.1. Let $f: \bigoplus_{k=1}^n A_k \rightarrow \bigoplus_{k=1}^m B_k$ in \mathbf{C} . The *matrix associated to f* is the $m \times n$ matrix $M(f)$ whose (j, i) entry (row j , column i), for $j = 1, \dots, m$ and $i = 1, \dots, n$, is

$$f_{ji} \stackrel{\text{def}}{=} \left(A_i \xrightarrow{\mu_i} \bigoplus_{k=1}^n A_k \xrightarrow{f} \bigoplus_{k=1}^m B_k \xrightarrow{\pi_j} B_j \right).$$

For $f: \bigoplus_{k=1}^n A_k \rightarrow \bigoplus_{k=1}^m B_k$, we have

$$M(f) = \begin{array}{c} \begin{array}{ccc} \swarrow & A_1 \cdots & A_n \\ B_1 \left(\begin{array}{ccc} f_{11} & \cdots & f_{1n} \\ \vdots & & \vdots \\ f_{m1} & \cdots & f_{mn} \end{array} \right) \\ \vdots & & \vdots \\ B_m \end{array} \end{array}$$

Notice how all morphisms in the i -th column have domain A_i , hence it makes sense to consider their pairing $\langle f_{i1}, \dots, f_{im} \rangle: A_i \rightarrow \bigoplus_k B_k$. Ranging over $i = 1, \dots, n$, we can now consider their copairing $[\langle f_{11}, \dots, f_{m1} \rangle, \dots, \langle f_{1n}, \dots, f_{mn} \rangle]$, which is now a morphism of type $\bigoplus_k A_k \rightarrow \bigoplus_k B_k$, just like f . Also, all morphisms in the j -th row have codomain B_j , hence we can take their copairing $[f_{j1}, \dots, f_{jn}]: \bigoplus_k A_k \rightarrow B_j$ and then, ranging over $j = 1, \dots, m$, their collective pairing $\langle [f_{11}, \dots, f_{1n}], \dots, [f_{m1}, \dots, f_{mn}] \rangle$, which is also of type $\bigoplus_k A_k \rightarrow \bigoplus_k B_k$. It turns out these morphisms are all equal to each other.

Lemma F.2. Let $f: \bigoplus_{k=1}^n A_k \rightarrow \bigoplus_{k=1}^m B_k$. Then

$$\begin{aligned} f &= [\langle f_{11}, \dots, f_{m1} \rangle, \dots, \langle f_{1n}, \dots, f_{mn} \rangle] \\ &= \langle [f_{11}, \dots, f_{1n}], \dots, [f_{m1}, \dots, f_{mn}] \rangle \end{aligned}$$

PROOF. For the first equality we need to prove that $\mu_i; f = \langle f_{i1}, \dots, f_{im} \rangle$ for all $i \in \{1, \dots, n\}$. This holds for any i because $(\mu_i; f); \pi_j = f_{ji}$ for all $j \in \{1, \dots, m\}$.

Similarly, for the second equality we need to prove that for all $j \in \{1, \dots, m\}$ we have $f; \pi_j = [f_{j1}, \dots, f_{jn}]$, which is true because for all $i \in \{1, \dots, n\}$ it holds that $\mu_i; (f; \pi_j) = f_{ji}$. \square

Corollary F.3. Let f and g have same domain and codomain. Then $M(f) = M(g)$ if and only if $f = g$.

We denote with $\triangleleft_X^m: X \rightarrow \bigoplus_{j=1}^m X$ the generalised diagonal of X , inductively defined in the obvious way:

$$\triangleleft_X^0 \stackrel{\text{def}}{=} \circlearrowleft_X \quad \triangleleft_X^{m+1} \stackrel{\text{def}}{=} \left(X \xrightarrow{\triangleleft_X} X \oplus X \xrightarrow{id_X \oplus \triangleleft_X^m} \bigoplus_{j=1}^{m+1} X \right) \quad (34)$$

Similarly, we denote with $\triangleright_X^n: \bigoplus_{i=1}^n X \rightarrow X$ the generalised codiagonal of X , inductively defined as:

$$\triangleright_X^0 \stackrel{\text{def}}{=} \circlearrowright_X \quad \triangleright_X^{n+1} \stackrel{\text{def}}{=} \left(\bigoplus_{i=1}^{n+1} X \xrightarrow{id_X \oplus \triangleright_X^n} X \oplus X \xrightarrow{\triangleright_X} X \right). \quad (35)$$

Proposition F.4. Let $f: \bigoplus_{k=1}^n A_k \rightarrow \bigoplus_{k=1}^m B_k$. Then

$$\begin{aligned} f &= \left(\bigoplus_{i=1}^n A_i \xrightarrow{\bigoplus_{i=1}^n \triangleleft_{A_i}^m} \bigoplus_{i=1}^n \bigoplus_{j=1}^m A_i \xrightarrow{\bigoplus_{i=1}^n \bigoplus_{j=1}^m f_{ji}} \bigoplus_{i=1}^n \bigoplus_{j=1}^m B_j \xrightarrow{\triangleright_{\bigoplus_{j=1}^m B_j}^n} \bigoplus_{j=1}^m B_j \right) \\ &= \left(\bigoplus_{i=1}^n A_i \xrightarrow{\triangleleft_{\bigoplus_{i=1}^n A_i}^m} \bigoplus_{j=1}^m \bigoplus_{i=1}^n A_i \xrightarrow{\bigoplus_{j=1}^m \bigoplus_{i=1}^n f_{ji}} \bigoplus_{j=1}^m \bigoplus_{i=1}^n B_j \xrightarrow{\triangleright_{\bigoplus_{j=1}^m B_j}^m} \bigoplus_{j=1}^m B_j \right) \end{aligned}$$

PROOF. In general, if $u_j: X \rightarrow Y_j$, with $j = 1, \dots, m$, we have

$$\langle u_1, \dots, u_m \rangle = \left(X \xrightarrow{\triangleleft_X^m} \bigoplus_{j=1}^m X \xrightarrow{\bigoplus_j u_j} \bigoplus_{j=1}^m Y_j \right)$$

(one can prove it by showing that the above satisfies the same universal property of $\langle u_1, \dots, u_m \rangle$). Hence, for any $i \in \{1, \dots, n\}$,

$$\langle f_{1i}, \dots, f_{mi} \rangle = \left(A_i \xrightarrow{\triangleleft_{A_i}^m} \bigoplus_{j=1}^m A_j \xrightarrow{\bigoplus_{j=1}^m f_{ji}} \bigoplus_{j=1}^m B_j \right)$$

Analogously, if $v_i: W_i \rightarrow Z$, with $i = 1, \dots, n$,

$$[v_1, \dots, v_n] = \left(\bigoplus_{i=1}^n W_i \xrightarrow{\bigoplus_{i=1}^n v_i} \bigoplus_{i=1}^n Z \xrightarrow{\triangleright_Z^n} Z \right)$$

Using these facts and Lemma F.2, we get the two equations of the statement. \square

Example F.5. Let $A = \bigoplus_{k=1}^n A_k$ and $B = \bigoplus_{k=1}^m B_k$. Then

$$M(id_A) = (\delta_{A_i, A_j}) = \begin{array}{c} A_1 \\ A_2 \\ \vdots \\ A_{n-1} \\ A_n \end{array} \begin{array}{c} A_1 \quad A_2 \cdots A_{n-1} \quad A_n \\ \left(\begin{array}{cccc} id_{A_1} & 0_{A_2, A_1} & \cdots & 0_{A_n, A_1} \\ 0_{A_1, A_2} & \ddots & \ddots & \ddots \\ \vdots & \ddots & \ddots & \ddots \\ 0_{A_1, A_n} & \cdots & 0_{A_{n-1}, A_n} & id_{A_n} \end{array} \right) \end{array}$$

while

$$M(0_{A,B}) = (0_{A_i, B_j}) = \begin{array}{c} B_1 \\ \vdots \\ B_m \end{array} \begin{array}{c} A_1 \quad \cdots \quad A_n \\ \left(\begin{array}{ccc} 0_{A_1, B_1} & \cdots & 0_{A_n, B_1} \\ \vdots & \ddots & \vdots \\ 0_{A_1, B_m} & \cdots & 0_{A_n, B_m} \end{array} \right) \end{array}$$

For this reason we will sometimes simply write $0_{A,B}$ for the matrix $M(0_{A,B})$ and id_A for the matrix $M(id_A)$. The context they appear in will make clear whether we are referring to a matrix or to a morphism of \mathbf{C} .

The matrix representation of morphisms in fb categories enjoys several nice properties.

Proposition F.6. For f and g of the appropriate type, we have:

(1) $M(g \circ f) = M(g)M(f)$,

(2) $M(f \oplus g) = \begin{pmatrix} M(f) & 0 \\ 0 & M(g) \end{pmatrix}$

(3) $M(\langle f, g \rangle) = \begin{pmatrix} M(f) \\ M(g) \end{pmatrix}$

(4) $M([f, g]) = \begin{pmatrix} M(f) & M(g) \end{pmatrix}$

(5) $M(\mu_i: A_i \rightarrow \bigoplus_{k=1}^n A_k) = \begin{pmatrix} \delta_{i,1} \\ \vdots \\ \delta_{i,n} \end{pmatrix}$, $M(\pi_j: \bigoplus_{k=1}^n A_k \rightarrow A_j) = (\delta_{1,j} \cdots \delta_{n,j})$

(6) For $A = \bigoplus_{k=1}^n A_k$ and $B = \bigoplus_{k=1}^m B_k$,

$$M(\sigma_{A,B}) = \begin{pmatrix} M(0_{B,A}) & M(id_B) \\ M(id_A) & M(0_{A,B}) \end{pmatrix}$$

matrix of size $(m+n) \times (n+m)$.

F.2 Additional details of the Proof of Theorem 6.4

We present here the two functors

$$\begin{array}{ccc}
 & \mathcal{F} & \\
 F_2(\mathbb{C}) & \xrightarrow{\quad} & \mathbf{Mat}(\mathbb{C}^+) \\
 & \mathcal{G} & \\
 & \cong &
 \end{array} \quad (36)$$

of Theorem 6.4 explicitly.

\mathcal{F} was defined in the proof of Theorem 6.4, so let us define \mathcal{G} . On objects it simply is the identity. On morphisms: let

$$M = (M_{ji})_{\substack{j=1\dots m \\ i=1\dots n}} : \bigoplus_{i=1}^n A_i \rightarrow \bigoplus_{j=1}^m B_j \text{ in } \mathbf{Mat}(\mathbb{C}^+).$$

If $m = 0$, then define $\mathcal{G}(M) = \mathring{\bigoplus}_{j=1}^m B_j$; if $n = 0$ define instead $\mathcal{G}(M) = \mathring{\bigoplus}_{i=1}^n A_i$. (This is consistent with the case $n = 0 = m$, because $\mathring{\bigoplus}_0 = \mathring{\bigoplus}_0 = id_0$ by Axioms (FP4) and (FC4).)

Suppose now that $n \neq 0 \neq m$. We have that M_{ji} is a multiset of morphisms of type $A_i \rightarrow B_j$ in \mathbb{C} . M_{ji} determines a morphism in $F_2(\mathbb{C})$:

$$\overline{\mathcal{G}}(M_{ji}) \stackrel{\text{def}}{=} \sum_{a \in M_{ji}} \overline{a} : A_i \rightarrow B_j$$

Notice that for $M_{ji} = \emptyset$ we get $\overline{\mathcal{G}}(\emptyset) = 0_{A_i, B_j}$. Now, $(\overline{\mathcal{G}}(M_{ji}))_{j=1\dots m, i=1\dots n}$ is a matrix of morphisms of $F_2(\mathbb{C})$, to which corresponds a unique arrow of the same type of M :

$$\mathcal{G}(M) \stackrel{\text{def}}{=} \left(\bigoplus_{i=1}^n A_i \xrightarrow{\mathring{\bigoplus}_{i=1}^n \mathring{\bigoplus}_{j=1}^m A_i} \bigoplus_{i=1}^n \bigoplus_{j=1}^m A_i \xrightarrow{\bigoplus_{i=1}^n \bigoplus_{j=1}^m \overline{\mathcal{G}}(M_{ji})} \bigoplus_{i=1}^n \bigoplus_{j=1}^m B_j \xrightarrow{\mathring{\bigoplus}_{j=1}^m B_j} \bigoplus_{j=1}^m B_j \right)$$

where $\mathring{\bigoplus}_X^m : X \rightarrow \bigoplus^m X$ and $\mathring{\bigoplus}_Y^n : Y \rightarrow \bigoplus^n Y$ are defined as:

$$\begin{array}{ccc}
 \mathring{\bigoplus}_X^0 & \stackrel{\text{def}}{=} & \mathring{\bigoplus}_X \\
 \mathring{\bigoplus}_X^{m+1} & \stackrel{\text{def}}{=} & \mathring{\bigoplus}_X; \mathring{\bigoplus}_X^m \\
 \mathring{\bigoplus}_Y^0 & \stackrel{\text{def}}{=} & \mathring{\bigoplus}_Y \\
 \mathring{\bigoplus}_Y^{n+1} & \stackrel{\text{def}}{=} & \mathring{\bigoplus}_Y; \mathring{\bigoplus}_Y^n
 \end{array} \quad (37)$$

Now we start showing that \mathcal{F} and \mathcal{G} are mutually inverse. We first observe a few properties of

\mathcal{F} : if $U = \bigoplus_{i=1}^n A_i$ then

$$\mathcal{F}(id_U) = \left(\begin{array}{ccc} \{id_{A_1}\} & \emptyset & \emptyset \\ \emptyset & \dots & \emptyset \\ \emptyset & \dots & \emptyset \\ \emptyset & \dots & \{id_{A_n}\} \end{array} \right)$$

Since \mathcal{F} sends symmetries, (co)diagonals and (co)bangs into symmetries, (co)diagonals and (co)bangs of $\mathbf{Mat}(\mathbb{C}^+)$, if $U = \bigoplus_{i=1}^n A_i$ and $V = \bigoplus_{j=1}^m B_j$ then:

$$\mathcal{F}(\sigma_{U,V}) = \begin{pmatrix} \mathbb{0}_{m \times n} & \mathcal{F}(id_V) \\ \mathcal{F}(id_U) & \mathbb{0}_{n \times m} \end{pmatrix}$$

$$\mathcal{F}(\triangleleft_U) = \begin{pmatrix} \mathcal{F}(id_U) & \mathcal{F}(id_U) \end{pmatrix} \quad \mathcal{F}(\triangleright_U) = \begin{pmatrix} \mathcal{F}(id_U) \\ \mathcal{F}(id_U) \end{pmatrix}$$

$$\mathcal{F}(\uparrow_U) = \text{empty matrix of size } 0 \times n \quad \mathcal{F}(\downarrow_U) = \text{empty matrix of size } n \times 0$$

Remark F.7. Since \mathbf{C} has all finite biproducts, $\mathbf{C}[U, V]$ is a commutative monoid where addition is given using diagonals and codiagonals as in (15). The action of \mathcal{F} on $f_1 + f_2: U \rightarrow V$, with $U = \bigoplus_{i=1}^n A_i$ and $V = \bigoplus_{j=1}^m B_j$, is the usual entry-by-entry addition of matrices:

$$\begin{aligned} \mathcal{F}(f_1 + f_2) &= \mathcal{F}(\triangleright_V) \circ \mathcal{F}(f_1 \oplus f_2) \circ \mathcal{F}(\triangleleft_U) \\ &= \begin{pmatrix} \mathcal{F}(id_V) & \mathcal{F}(id_V) \end{pmatrix} \begin{pmatrix} \mathcal{F}(f_1) & \mathbf{0}_{m \times n} \\ \mathbf{0}_{m \times n} & \mathcal{F}(f_2) \end{pmatrix} \begin{pmatrix} \mathcal{F}(id_U) \\ \mathcal{F}(id_U) \end{pmatrix} \\ &= \begin{pmatrix} \mathcal{F}(f_1) & \mathcal{F}(f_2) \end{pmatrix} \begin{pmatrix} \mathcal{F}(id_U) \\ \mathcal{F}(id_U) \end{pmatrix} \\ &= \mathcal{F}(f_1) + \mathcal{F}(f_2). \end{aligned}$$

Remark F.8. If $f_1: W \rightarrow U$ and $f_2: W \rightarrow V$ then

$$\begin{aligned} \mathcal{F}(\langle f_1, f_2 \rangle) &= \mathcal{F}((f_1 \oplus f_2) \circ \langle id_W, id_W \rangle) \\ &= \mathcal{F}(f_1 \oplus f_2) \circ \mathcal{F}(\triangleleft_W) \\ &= \begin{pmatrix} \mathcal{F}(f_1) & \mathbf{0} \\ \mathbf{0} & \mathcal{F}(f_2) \end{pmatrix} \begin{pmatrix} \mathcal{F}(id_W) \\ \mathcal{F}(id_W) \end{pmatrix} \\ &= \begin{pmatrix} \mathcal{F}(f_1) \\ \mathcal{F}(f_2) \end{pmatrix} \end{aligned}$$

Analogously, if $f_1: U \rightarrow W$ and $f_2: V \rightarrow W$ then $\mathcal{F}([f_1, f_2]) = \begin{pmatrix} \mathcal{F}(f_1) & \mathcal{F}(f_2) \end{pmatrix}$.

Proposition F.9. $\mathcal{G}: \mathbf{Mat}(\mathbf{C}^+) \rightarrow F_2(\mathbf{C})$ is a functor that preserves biproducts.

PROOF. Let

$$\bigoplus_{i=1}^n A_i \xrightarrow{M} \bigoplus_{k=1}^m V_k \xrightarrow{N} \bigoplus_{j=1}^l W_j.$$

We aim to compute $\mathcal{G}(N \circ M)$. We have

$$\begin{aligned} (N \circ M)_{ji} &= (N \cdot M)_{ji} = \sum_{k=1}^m N_{jk} \circ M_{ki} && \text{(Sum and composition in } \mathbf{C}_\Sigma^+) \\ &= \bigcup_{k=1}^m \{ \{ b \circ_{\mathbf{C}} a \mid a \in M_{ki}, b \in N_{jk} \} \} && \text{(Union of multisets)} \end{aligned}$$

therefore

$$\overline{\mathcal{G}}((N \circ M)_{ji}) = \sum_{k=1}^m \sum_{\substack{a \in M_{ki} \\ b \in N_{jk}}} \overline{b \circ a}$$

Now, $\mathcal{G}(N) \circ \mathcal{G}(M)$ is a morphism in $F_2(\mathbb{C})$ whose associated matrix, by Proposition F.6, is

$$\left(\overline{\mathcal{G}}(N_{wv})\right)_{\substack{w=1\dots l \\ v=1\dots m}} \cdot \left(\overline{\mathcal{G}}(M_{vu})\right)_{\substack{v=1\dots m \\ u=1\dots n}}$$

whose entry (j, i) , for $i \in \{1, \dots, n\}$ and $j \in \{1, \dots, m\}$, is the following sum of compositions in $F_2(\mathbb{C})$:

$$\begin{aligned} (M(\mathcal{G}(N) \circ \mathcal{G}(M)))_{ji} &= \sum_{k=1}^m \overline{\mathcal{G}}(N_{jk}) \circ \overline{\mathcal{G}}(M_{ki}) \\ &= \sum_{k=1}^m \left(\sum_{b \in N_{jk}} \overline{b} \right) \circ \left(\sum_{a \in M_{ki}} \overline{a} \right) \\ &= \sum_{k=1}^m \sum_{a \in M_{ki}} \left(\sum_{b \in N_{jk}} \overline{b} \right) \circ \overline{a} \\ &\quad \text{(CMon-enrichment: } v \circ (f + g) = v \circ f + v \circ g) \\ &= \sum_{k=1}^m \sum_{a \in M_{ki}} \sum_{b \in N_{jk}} \overline{b} \circ \overline{a} \quad \text{(CMon-enrichment: } (f + g) \circ u = f \circ u + g \circ u) \\ &= \sum_{k=1}^m \sum_{a \in M_{ki}} \sum_{b \in N_{jk}} \overline{b \circ a} \quad \text{(Tape)} \\ &= \overline{\mathcal{G}}((N \circ M)_{ji}) \\ &= M(\mathcal{G}(N \circ M))_{ji}. \end{aligned}$$

Hence $\mathcal{G}(N) \circ \mathcal{G}(M) = \mathcal{G}(N \circ M)$ by Corollary F.3.

Regarding preservation of biproducts, if $M: \bigoplus_{k=1}^n A_k \rightarrow \bigoplus_{k=1}^{n'} A'_k$ and $N: \bigoplus_{k=1}^m B_k \rightarrow \bigoplus_{k=1}^{m'} B'_k$ are any two matrices, we have that

$$\mathcal{G}(M \oplus N) = \mathcal{G} \begin{pmatrix} M & \emptyset \\ \emptyset & N \end{pmatrix} \quad \text{(block matrix)}$$

thus $\mathcal{G}(M \oplus N)$ is the morphism in \mathbf{T}_Σ whose associated matrix is

$$\left(\begin{array}{cc} \overline{\mathcal{G}}(M_{11}) \cdots \overline{\mathcal{G}}(M_{1n}) & 0 \cdots 0 \\ \vdots & \vdots \\ \overline{\mathcal{G}}(M_{n'1}) \cdots \overline{\mathcal{G}}(M_{n'n}) & 0 \cdots 0 \\ 0 \cdots 0 & \overline{\mathcal{G}}(N_{11}) \cdots \overline{\mathcal{G}}(N_{1m}) \\ \vdots & \vdots \\ 0 \cdots 0 & \overline{\mathcal{G}}(N_{m'1}) \cdots \overline{\mathcal{G}}(N_{m'm}) \end{array} \right)$$

which is exactly the block matrix $\begin{pmatrix} M(\mathcal{G}(M)) & 0 \\ 0 & M(\mathcal{G}(N)) \end{pmatrix}$, which in turn is $M(\mathcal{G}(M) \oplus \mathcal{G}(N))$ by Proposition F.6 (2). Hence $\mathcal{G}(M \oplus N) = \mathcal{G}(M) \oplus \mathcal{G}(N)$.

In light of this, in order to check that \mathcal{G} preserves identities it suffices to make sure that $\mathcal{G}(id_A) = id_A$ for A object in \mathbf{C} (seen as a unary list). And indeed $\mathcal{G}(id_A)$ is the morphism whose associated matrix is the 1×1 matrix $(\{\!\! \{ id_A \}\!\!\})$, hence $\mathcal{G}(id_A) = id_A$. \square

Proposition F.10. \mathcal{F} and \mathcal{G} are mutually inverse.

PROOF. It is not difficult to prove by induction on f that $\mathcal{G}\mathcal{F}(f) = f$, using Proposition F.6. We show here that $\mathcal{F}\mathcal{G} = id$: let $M: \bigoplus_{i=1}^n A_i \rightarrow \bigoplus_{j=1}^m B_j$. First notice that

$$\mathcal{G}(M) = [\langle \overline{\mathcal{G}}(M_{11}), \dots, \overline{\mathcal{G}}(M_{n1}) \rangle, \dots, \langle \overline{\mathcal{G}}(M_{1m}), \dots, \overline{\mathcal{G}}(M_{nm}) \rangle]$$

by Lemma F.2 and Proposition F.4. Then

$$\begin{aligned} \mathcal{F}\mathcal{G}(M) &= \mathcal{F}\left(\left[\left\langle \sum_{f \in M_{11}} \overline{f}, \dots, \sum_{f \in M_{n1}} \overline{f} \right\rangle, \dots, \left\langle \sum_{f \in M_{1m}} \overline{f}, \dots, \sum_{f \in M_{nm}} \overline{f} \right\rangle\right]\right) && \text{(Definition of } \mathcal{G}\text{)} \\ &= \left(\begin{array}{ccc} \mathcal{F}\left(\sum_{f \in M_{11}} \overline{f}\right) & \cdots & \mathcal{F}\left(\sum_{f \in M_{1m}} \overline{f}\right) \\ \vdots & \ddots & \vdots \\ \mathcal{F}\left(\sum_{f \in M_{n1}} \overline{f}\right) & \cdots & \mathcal{F}\left(\sum_{f \in M_{nm}} \overline{f}\right) \end{array} \right) && \text{(Remark F.8)} \\ &= M \end{aligned}$$

because for every $j \in \{1, \dots, m\}$ and $i \in \{1, \dots, n\}$

$$\begin{aligned} \mathcal{F}\left(\sum_{f \in M_{ji}} \overline{f}\right) &= \sum_{f \in M_{ji}} \mathcal{F}(\overline{f}) && \text{(Remark F.7)} \\ &= \sum_{f \in M_{ji}} (\{\!\! \{ f \}\!\!\}) \\ &= M_{ji} \end{aligned}$$

where above $\sum_{f \in M_{ji}} (\{\!\! \{ f \}\!\!\})$ is an entry-by-entry sum of 1×1 matrices, which yields the matrix whose only entry is $\sum_{f \in M_{ji}} \{\!\! \{ f \}\!\!\}$: a sum of multisets equal to M_{ji} itself. \square

F.3 Kronecker product. Details of the proof of Theorem 6.5

We will work using $\mathbf{C} = \mathbf{C}_\Sigma$ here, but everything that follows can be generalised to an arbitrary SMC. Recall the definition of \otimes . On objects it is set as follows:

$$\left(\bigoplus_{i=1}^n U_i\right) \otimes \left(\bigoplus_{j=1}^m V_j\right) \stackrel{\text{def}}{=} \bigoplus_{i=1}^n \bigoplus_{j=1}^m U_i V_j.$$

If $M: \bigoplus_{i=1}^n U_i \rightarrow \bigoplus_{i'=1}^{n'} U_{i'}$ and $N: \bigoplus_{j=1}^m V_j \rightarrow \bigoplus_{j'=1}^{m'} V_{j'}$, define $M \otimes N$ as the block matrix:

$$M \otimes N = \begin{pmatrix} U_1 V_1 & \dots & U_1 V_m & \dots & U_n V_1 & \dots & U_n V_m \\ \vdots & & \vdots & & \vdots & & \vdots \\ U'_1 V'_1 & & & & & & \\ \vdots & & \vdots & & \vdots & & \vdots \\ U'_1 V'_{m'} & & & & & & \\ \vdots & & \vdots & & \vdots & & \vdots \\ U'_{n'} V'_1 & & & & & & \\ \vdots & & \vdots & & \vdots & & \vdots \\ U'_{n'} V'_{m'} & & & & & & \end{pmatrix} \begin{matrix} M_{11} \otimes N & & & & M_{1n} \otimes N & & \\ & \dots & & & & \dots & \\ & & M_{n'1} \otimes N & & & & M_{n'n} \otimes N \end{matrix}$$

where

$$M_{i'i} \otimes N = \begin{pmatrix} M_{i'i} \otimes N_{11} & \dots & M_{i'i} \otimes N_{1m} \\ \vdots & \ddots & \vdots \\ M_{i'i} \otimes N_{m'1} & \dots & M_{i'i} \otimes N_{m'n'} \end{pmatrix}$$

In other words, $M \otimes N$ is a matrix of size $n'm' \times nm$, whose rows are indexed by $(i', j') \in \{1, \dots, n'\} \times \{1, \dots, m'\}$ and whose columns by $(i, j) \in \{1, \dots, n\} \times \{1, \dots, m\}$; then we have

$$(M \otimes N)_{(i', j'), (i, j)} = M_{i'i} \otimes N_{j'j} = \{ \{ a \otimes_{\mathbb{C}_\Sigma} b \mid a \in M_{i'i}, b \in N_{j'j} \} \}.$$

We will show that \otimes coincides with the tensor product inherited from \mathbf{T}_Σ . We begin by proving some preliminary results.

Proposition F.11. Let $M: P \rightarrow P'$ and $N: Q \rightarrow Q'$, with $P = \bigoplus_{i=1}^n U_i$, $P' = \bigoplus_{i'=1}^{n'} U_{i'}$, $Q = \bigoplus_{j=1}^m V_j$ and $Q' = \bigoplus_{j'=1}^{m'} V_{j'}$. Then

$$\begin{aligned} M \otimes N &= (id_{P'} \otimes N) \circ (M \otimes id_Q) \\ &= (M \otimes id_{Q'}) \circ (id_P \otimes N) \end{aligned}$$

PROOF. We only show the first equality: the other is analogous. We have:

$$id_{P'} \otimes N = \begin{pmatrix} \{ \{ id_{U'_1} \} \} \otimes N & \emptyset \otimes N & \dots & \emptyset \otimes N \\ \emptyset \otimes N & \ddots & & \emptyset \otimes N \\ \emptyset \otimes N & \dots & \emptyset \otimes N & \{ \{ id_{U'_{n'}} \} \} \otimes N \end{pmatrix}$$

Notice that $\emptyset \otimes N$ is $\emptyset_{m' \times m}$, the $m' \times m$ matrix whose every entry is the empty multiset. Next,

$$M \otimes id_Q = \begin{pmatrix} M_{11} \otimes id_Q & \dots & M_{1n} \otimes id_Q \\ \vdots & \ddots & \vdots \\ M_{n'1} \otimes id_Q & \dots & M_{n'n} \otimes id_Q \end{pmatrix}$$

(in the above $id_{P'}$ and id_Q are identity morphisms in $\mathbf{Mat}(\mathbf{C}_\Sigma^+)$, hence they are matrices). To save space, we shall drop the multiset brackets in $\left\{ id_{U_{i'}} \right\}$, since it is a singleton, and simply write $id_{U_{i'}}$. Therefore $(id_{P'} \otimes N) \circ (M \otimes id_Q)$ is equal to:

$$\left(\begin{array}{ccc} (id_{U_{1'}} \otimes N) \circ (M_{11} \otimes id_Q) & (id_{U_{1'}} \otimes N) \circ (M_{12} \otimes id_Q) & \dots & (id_{U_{1'}} \otimes N) \circ (M_{1n} \otimes id_Q) \\ (id_{U_{2'}} \otimes N) \circ (M_{21} \otimes id_Q) & (id_{U_{2'}} \otimes N) \circ (M_{22} \otimes id_Q) & \dots & (id_{U_{2'}} \otimes N) \circ (M_{2n} \otimes id_Q) \\ \vdots & \vdots & \ddots & \vdots \\ (id_{U_{i'n'}} \otimes N) \circ (M_{n'1} \otimes id_Q) & (id_{U_{i'n'}} \otimes N) \circ (M_{n'2} \otimes id_Q) & \dots & (id_{U_{i'n'}} \otimes N) \circ (M_{n'n} \otimes id_Q) \end{array} \right)$$

In other words, $(id_{P'} \otimes N) \circ (M \otimes id_Q)$ is a matrix consisting of $n' \times n$ blocks (the entries in the matrix above), each of size $m' \times m$, where the block at row i' and column i is

$$B^{i'i} = \underbrace{(id_{U_{i'}} \otimes N)}_{m' \times m} \circ \underbrace{(M_{i'i} \otimes id_Q)}_{m' \times m}.$$

The entry (j', j) of the above block is the following sum of composite of multisets:

$$\begin{aligned} B_{j'j}^{i'i} &= \sum_{k=1}^m (id_{U_{i'}} \otimes N)_{j'k} \circ (M_{i'i} \otimes id_Q)_{kj} \\ &= \sum_{k=1}^m (id_{U_{i'}} \otimes N_{j'k}) \circ (M_{i'i} \otimes (id_Q)_{kj}) \end{aligned}$$

Now, if $k \neq j$ then $(id_Q)_{kj} = \emptyset$, hence $M_{i'i} \otimes \emptyset = \emptyset$ and $(id_{U_{i'}} \otimes N_{j'k}) \circ \emptyset = \emptyset$. Therefore,

$$\begin{aligned} B_{j'j}^{i'i} &= (id_{U_{i'}} \otimes N_{j'j}) \circ (M_{i'i} \otimes id_{V_j}) \\ &= \left\{ id_{U_{i'}} \otimes_{\mathbf{C}_\Sigma} b \mid b \in N_{j'j} \right\} \circ \left\{ a \otimes_{\mathbf{C}_\Sigma} id_{V_j} \mid a \in M_{i'i} \right\} && \text{(Definition of } \otimes_{\mathbf{C}_\Sigma^+} \text{)} \\ &= \left\{ (id_{U_{i'}} \otimes_{\mathbf{C}_\Sigma} b) \circ (a \otimes_{\mathbf{C}_\Sigma} id_{V_j}) \mid a \in M_{i'i}, b \in N_{j'j} \right\} && \text{(Definition of } \circ \text{ in } \mathbf{C}_\Sigma^+ \text{)} \\ &= \left\{ a \otimes_{\mathbf{C}_\Sigma} b \mid a \in M_{i'i}, b \in N_{j'j} \right\} && \text{(Functoriality of } \otimes_{\mathbf{C}_\Sigma} \text{)} \\ &= (M \otimes N)_{(i',j'),(i,j)}. && \square \end{aligned}$$

$\mathbf{Mat}(\mathbf{C}_\Sigma^+)$ inherits a tensor functor $\otimes_{\mathbf{Mat}}$ from \mathbf{T}_Σ , via the isomorphism (36), defined as

$$M \otimes_{\mathbf{Mat}} N \stackrel{\text{def}}{=} \mathcal{F}(\mathcal{G}(M) \otimes_{\mathbf{T}_\Sigma} \mathcal{G}(N)).$$

This makes $\mathbf{Mat}(\mathbf{C}_\Sigma^+)$ a strict fb rig category, where \mathcal{F} and \mathcal{G} strictly preserve the rig structure. Now we show that $\otimes_{\mathbf{Mat}}$ actually coincides with the Kronecker product.

Proposition F.12. Let $P = \bigoplus_{i=1}^n U_i$ and $Q = \bigoplus_{j=1}^m V_j$. Then $id_P \otimes id_Q = id_{P \otimes Q}$.

PROOF. We have:

$$\begin{aligned}
 id_P \otimes id_Q &= \begin{pmatrix} (id_P)_{11} \otimes id_Q & \dots & (id_P)_{1n} \otimes id_Q \\ \vdots & & \vdots \\ (id_P)_{n1} \otimes id_Q & \dots & (id_P)_{nn} \otimes id_Q \end{pmatrix} \\
 &= \begin{pmatrix} \{id_{U_1}\} \otimes id_Q & \emptyset & \dots & \emptyset \\ \emptyset & \dots & \dots & \emptyset \\ \vdots & & & \vdots \\ \emptyset & \dots & \dots & \{id_{U_n}\} \otimes id_Q \end{pmatrix} \\
 &= \begin{pmatrix} \{id_{U_1} \otimes id_{V_1}\} & \emptyset & \dots & \emptyset \\ \emptyset & \dots & \dots & \emptyset \\ \vdots & & & \vdots \\ \emptyset & \dots & \dots & \{id_{U_n} \otimes id_{V_m}\} \end{pmatrix} \\
 &= id_{\bigoplus_i \bigoplus_j U_i V_j} \\
 &= id_{P \otimes Q}.
 \end{aligned}$$

□

Theorem F.13. $\otimes_{\text{Mat}} = \otimes$ in $\text{Mat}(\mathbb{C}_\Sigma^+)$.

PROOF. On objects: if $P = \bigoplus_{i=1}^n U_i$ and $Q = \bigoplus_{j=1}^m V_j$ we have $P \otimes_{\text{Mat}} Q = \mathcal{F}(P \otimes_{\mathbb{T}_\Sigma} Q) = \mathcal{F}(\bigoplus_i \bigoplus_j U_i V_j) = P \otimes Q$.

Claim: $\mathcal{F}(t \otimes_{\mathbb{T}_\Sigma} id) = \mathcal{F}(t) \otimes id$ and $\mathcal{F}(id \otimes_{\mathbb{T}_\Sigma} t) = id \otimes \mathcal{F}(t)$ for every $t \in \mathbb{T}_\Sigma$.

The claim will allow us to conclude the proof, because we will have:

$$\begin{aligned}
 M \otimes_{\text{Mat}} N &= \mathcal{F}(\mathcal{G}(M) \otimes_{\mathbb{T}_\Sigma} \mathcal{G}(N)) && \text{(Definition of } \otimes_{\text{Mat}} \text{)} \\
 &= \mathcal{F}((id \otimes_{\mathbb{T}_\Sigma} \mathcal{G}(N)) \circ (\mathcal{G}(M) \otimes_{\mathbb{T}_\Sigma} id)) && \text{(Functoriality of } \otimes_{\mathbb{T}_\Sigma} \text{)} \\
 &= \mathcal{F}((id \otimes_{\mathbb{T}_\Sigma} \mathcal{G}(N))) \circ \mathcal{F}(\mathcal{G}(M) \otimes_{\mathbb{T}_\Sigma} id) && \text{(Functoriality of } \mathcal{F} \text{)} \\
 &= (id \otimes \mathcal{F}\mathcal{G}(N)) \circ (\mathcal{F}\mathcal{G}(M) \otimes id) && \text{(Claim)} \\
 &= (id \otimes N) \circ (M \otimes id) && \text{(} \mathcal{F}\mathcal{G} = id \text{)} \\
 &= M \otimes N && \text{(Proposition F.11)}
 \end{aligned}$$

We now proceed to prove the claim. First of all, if $t = id_P$ say, then

$$\begin{aligned}
 \mathcal{F}(id_P \otimes_{\mathbb{T}_\Sigma} id_R) &= \mathcal{F}(id_{P \otimes_{\mathbb{T}_\Sigma} R}) && \text{(Functoriality of } \otimes_{\mathbb{T}_\Sigma} \text{)} \\
 &= id_{P \otimes_{\text{Mat}} R} && \text{(Functoriality of } \mathcal{F} \text{)} \\
 &= id_{P \otimes R} && \text{(} \otimes_{\text{Mat}} \text{ and } \otimes \text{ coincide on objects)} \\
 &= id_P \otimes id_R && \text{(Proposition F.12)}
 \end{aligned}$$

therefore the claim holds.

Next, suppose $t \neq id$. Then t can be written as a composite of morphisms of the form $id_P \oplus t' \oplus id_Q$ with $t' = \overline{c}, \sigma_{U,V}^\oplus, \triangleleft_U, \uparrow_U, \triangleright_U, \downarrow_U$ with U, V tensors of basic sorts. Now, since $\otimes_{\mathbb{T}_\Sigma}$ is right

distributive,

$$(id_P \oplus t' \oplus id_Q) \otimes_{T_\Sigma} id_R = (id_P \otimes_{T_\Sigma} id_R) \oplus (t' \otimes_{T_\Sigma} id_R) \oplus (id_Q \otimes_{T_\Sigma} id_R).$$

Since \mathcal{F} preserves biproducts, it suffices to prove that

$$\mathcal{F}(t \otimes id_R) = \mathcal{F}(t) \otimes id_R$$

for $t = \overline{c}$, $\sigma_{U,V}^\oplus$, \triangleleft_U , \uparrow_U , $\triangleright_U \circ_U$ and $R = \bigoplus_{k=1}^l Z_k$ in order to prove the first half of the claim.

Case 1: $t = \overline{c} : U \rightarrow U'$. We have that

$$t \otimes_{T_\Sigma} id_R = \bigoplus_{k=1}^l \overline{c \otimes_{C_\Sigma} id_{Z_k}} : \bigoplus_{k=1}^l U Z_k \rightarrow \bigoplus_{k=1}^l U' Z_k.$$

Therefore

$$\begin{aligned} \mathcal{F}(t \otimes_{T_\Sigma} id_R) &= \left(\begin{array}{ccc} \mathcal{F}(\overline{c \otimes_{C_\Sigma} id_{Z_1}}) & \emptyset & \emptyset \\ \emptyset & \ddots & \emptyset \\ \emptyset & \emptyset & \mathcal{F}(\overline{c \otimes_{C_\Sigma} id_{Z_l}}) \end{array} \right) \\ &= \left(\begin{array}{ccc} \{ \{ c \otimes_{C_\Sigma} id_{Z_1} \} \} & \emptyset & \emptyset \\ \emptyset & \ddots & \emptyset \\ \emptyset & \emptyset & \{ \{ c \otimes_{C_\Sigma} id_{Z_l} \} \} \end{array} \right) \\ &= (\{ \{ c \} \}) \otimes \left(\begin{array}{ccc} \{ \{ id_{Z_1} \} \} & \emptyset & \emptyset \\ \emptyset & \ddots & \emptyset \\ \emptyset & \emptyset & \{ \{ id_{Z_l} \} \} \end{array} \right) \\ &= \mathcal{F}(\overline{c}) \otimes id_R. \end{aligned}$$

Case 2: $t = \sigma_{U,V}^\oplus$. We have:

$$\begin{aligned} \mathcal{F}(t \otimes_{T_\Sigma} id_R) &= \mathcal{F}(\sigma_{\bigoplus_k U Z_k, \bigoplus_k V Z_k}^\oplus) \\ &= \begin{pmatrix} \emptyset_{I \times I} & id_{\bigoplus_k V Z_k} \\ id_{\bigoplus_k U Z_k} & \emptyset_{I \times I} \end{pmatrix} \end{aligned}$$

$$\begin{aligned}
 &= \left(\begin{array}{ccc} \mathcal{F}(\overline{c \otimes_{C_\Sigma} id_{Z_1}}) & \emptyset & \emptyset \\ \emptyset & \emptyset & \emptyset \\ \emptyset & \emptyset & \mathcal{F}(\overline{c \otimes_{C_\Sigma} id_{Z_1}}) \end{array} \right) \\
 &= \left(\begin{array}{ccc|ccc} & & & \{\!\! \{ id_{V_{Z_1}} \}\!\!\} & \emptyset & \emptyset \\ & & & \emptyset & \emptyset & \emptyset \\ & & & \emptyset & \emptyset & \emptyset \\ \hline \emptyset & & & & & \{\!\! \{ id_{V_{Z_1}} \}\!\!\} \\ \{\!\! \{ id_{U_{Z_1}} \}\!\!\} & \emptyset & \emptyset & & & \\ \emptyset & \emptyset & \emptyset & & & \\ \emptyset & \emptyset & \emptyset & & & \{\!\! \{ id_{U_{Z_1}} \}\!\!\} \end{array} \right) \\
 &= \left(\begin{array}{cc|ccc} \emptyset & \{\!\! \{ id_V \}\!\!\} & \emptyset & \emptyset & \emptyset \\ \{\!\! \{ id_U \}\!\!\} & \emptyset & \emptyset & \emptyset & \emptyset \\ \hline \{\!\! \{ id_{Z_1} \}\!\!\} & \emptyset & \emptyset & \emptyset & \emptyset \\ \emptyset & \emptyset & \emptyset & \emptyset & \emptyset \\ \emptyset & \emptyset & \emptyset & \emptyset & \{\!\! \{ id_{Z_1} \}\!\!\} \end{array} \right) \\
 &= \left(\begin{array}{cc} \emptyset & \{\!\! \{ id_V \}\!\!\} \\ \{\!\! \{ id_U \}\!\!\} & \emptyset \end{array} \right) \otimes \left(\begin{array}{ccc} \{\!\! \{ id_{Z_1} \}\!\!\} & \emptyset & \emptyset \\ \emptyset & \emptyset & \emptyset \\ \emptyset & \emptyset & \{\!\! \{ id_{Z_1} \}\!\!\} \end{array} \right) \\
 &= \mathcal{F}(\sigma_{U,V}^\oplus) \otimes id_R.
 \end{aligned}$$

Case 3: $t = \triangleleft_U$. We have:

$$\begin{aligned}
 \mathcal{F}(\triangleleft_U \otimes_{T_\Sigma} id_R) &= \mathcal{F}(\triangleleft_{\bigoplus_k U_{Z_k}}) \\
 &= \left(\begin{array}{ccc} \{\!\! \{ id_{U_{Z_1}} \}\!\!\} & \emptyset & \emptyset \\ \emptyset & \emptyset & \emptyset \\ \emptyset & \emptyset & \{\!\! \{ id_{U_{Z_1}} \}\!\!\} \\ \hline \{\!\! \{ id_{U_{Z_1}} \}\!\!\} & \emptyset & \emptyset \\ \emptyset & \emptyset & \emptyset \\ \emptyset & \emptyset & \{\!\! \{ id_{U_{Z_1}} \}\!\!\} \end{array} \right)
 \end{aligned}$$

$$\begin{aligned}
 &= \left(\begin{array}{c} \{ \{ id_U \} \} \\ \{ \{ id_U \} \} \end{array} \right) \otimes \left(\begin{array}{ccc} \{ \{ id_{UZ_1} \} \} & \emptyset & \emptyset \\ \emptyset & \dots & \emptyset \\ \emptyset & \dots & \emptyset \\ \emptyset & \dots & \{ \{ id_{UZ_1} \} \} \end{array} \right) \\
 &= \mathcal{F}(\triangleleft_U) \otimes id_R.
 \end{aligned}$$

Case 4: $\mathfrak{t} = \mathring{\uparrow}_U$. We have:

$$\begin{aligned}
 \mathcal{F}(\mathring{\uparrow}_U \otimes_{T_\Sigma} id_R) &= \mathcal{F}(\mathring{\uparrow}_{\bigoplus_k UZ_k}) = \emptyset_{0 \times l} = \emptyset_{0 \times 1} \otimes \left(\begin{array}{ccc} \{ \{ id_{Z_1} \} \} & \emptyset & \emptyset \\ \emptyset & \dots & \emptyset \\ \emptyset & \dots & \emptyset \\ \emptyset & \dots & \{ \{ id_{Z_1} \} \} \end{array} \right) \\
 &= \mathcal{F}(\mathring{\uparrow}_U) \otimes id_R.
 \end{aligned}$$

The other cases concerning \triangleright_U and \circlearrowleft_U are analogous. Now we prove that

$$\mathcal{F}(id_R \otimes_{T_\Sigma} (id_P \oplus \mathfrak{t} \oplus id_Q)) = id_R \otimes \mathcal{F}(id_P \oplus \mathfrak{t} \oplus Q)$$

with $P = \bigoplus_{i=1}^n X_i$, $Q = \bigoplus_{j=1}^m Y_j$, $R = \bigoplus_{k=1}^l Z_k$. To lighten notation, for the rest of the proof we will often denote identity morphisms with their corresponding objects, that is we will simply write X instead of id_X .

Case 1: $\mathfrak{t} = \overline{\underline{c}} : U \rightarrow V$.

$$\begin{aligned}
 \mathcal{F}(R \otimes_{T_\Sigma} (P \oplus \mathfrak{t} \oplus Q)) &= \mathcal{F}\left(\bigoplus_{k=1}^l \left(\bigoplus_{i=1}^n Z_k X_i \oplus \overline{Z_k \otimes_{C_\Sigma} c} \oplus \bigoplus_{j=1}^m Z_k Y_j\right)\right) \\
 &= \bigoplus_{k=1}^l \left[\bigoplus_{i=1}^n (\{ \{ Z_k X_i \} \}) \oplus (\{ \{ Z_k \otimes_{C_\Sigma} c \} \}) \oplus \bigoplus_{j=1}^m (\{ \{ Z_k Y_j \} \}) \right] \\
 &= \bigoplus_{k=1}^l \left(\begin{array}{ccc} \{ \{ Z_k X_1 \} \} & \emptyset & \emptyset \\ \emptyset & \dots & \emptyset \\ \emptyset & \dots & \emptyset \\ \emptyset & \dots & \{ \{ Z_k Y_m \} \} \end{array} \right)
 \end{aligned}$$

$$\begin{aligned}
 &= id_R \otimes \left(\begin{array}{c|c|c} id_P & \emptyset & \emptyset \\ \hline \emptyset \cdots \emptyset & c & \emptyset \cdots \emptyset \\ \hline \emptyset & \emptyset & id_Q \end{array} \right) \\
 &= id_R \otimes \mathcal{F}(P \oplus \mathfrak{t} \oplus Q).
 \end{aligned}$$

Case 2: $\mathfrak{t} = \sigma_{U,V}^{\oplus}$.

$\mathcal{F}(R \otimes_{T_{\Sigma}} (P \oplus \mathfrak{t} \oplus Q))$

$$\begin{aligned}
 &= \bigoplus_{k=1}^l \left[\bigoplus_{i=1}^n (\{Z_k X_i\}) \oplus \left(\begin{array}{cc} \emptyset & \{Z_k V\} \\ \{Z_k U\} & \emptyset \end{array} \right) \oplus \bigoplus_{j=1}^m (\{Z_k Y_j\}) \right] \\
 &= \bigoplus_{k=1}^l \left(\begin{array}{c|c|c} \begin{array}{ccc} \{Z_k X_1\} & \emptyset & \emptyset \\ \emptyset & \cdots & \emptyset \\ \emptyset & \emptyset & \emptyset \\ \emptyset & \emptyset & \{Z_k X_n\} \end{array} & \emptyset & \emptyset \\ \hline \emptyset & \begin{array}{cc} \emptyset & \{Z_k V\} \\ \{Z_k U\} & \emptyset \end{array} & \emptyset \\ \hline \emptyset & \emptyset & \begin{array}{ccc} \{Z_k Y_1\} & \emptyset & \emptyset \\ \emptyset & \cdots & \emptyset \\ \emptyset & \emptyset & \emptyset \\ \emptyset & \emptyset & \{Z_k Y_m\} \end{array} \end{array} \right) \\
 &= id_R \otimes \left(\begin{array}{c|c|c} \begin{array}{ccc} \{X_1\} & \emptyset & \emptyset \\ \emptyset & \cdots & \emptyset \\ \emptyset & \emptyset & \emptyset \\ \emptyset & \emptyset & \{X_n\} \end{array} & \emptyset & \emptyset \\ \hline \emptyset & \begin{array}{cc} \emptyset & \{V\} \\ \{U\} & \emptyset \end{array} & \emptyset \\ \hline \emptyset & \emptyset & \begin{array}{ccc} \{Y_1\} & \emptyset & \emptyset \\ \emptyset & \cdots & \emptyset \\ \emptyset & \emptyset & \emptyset \\ \emptyset & \emptyset & \{Y_m\} \end{array} \end{array} \right)
 \end{aligned}$$

$$= id_R \otimes \mathcal{F}(P \oplus \mathfrak{t} \oplus Q).$$

Case 3: $\mathfrak{t} = \triangleleft_U$.

$$\mathcal{F}(R \otimes_{\Gamma_\Sigma} (P \oplus \mathfrak{t} \oplus Q))$$

$$= \bigoplus_{k=1}^l \left[\bigoplus_{i=1}^n (\{ Z_k X_i \}) \oplus (\{ Z_k U \}) \oplus \bigoplus_{j=1}^m (\{ Z_k Y_j \}) \right]$$

$$= \bigoplus_{k=1}^l \left(\begin{array}{c|c|c} \begin{array}{ccc} \{ Z_k X_1 \} & \emptyset & \emptyset \\ & \ddots & \vdots \\ \emptyset & & \emptyset \\ & \vdots & \vdots \\ \emptyset & & \{ Z_k X_n \} \end{array} & \emptyset & \emptyset \\ \hline \emptyset & \{ Z_k U \} & \emptyset \\ \emptyset & \{ Z_k U \} & \emptyset \\ \hline \emptyset & \emptyset & \begin{array}{ccc} \{ Z_k Y_1 \} & \emptyset & \emptyset \\ & \ddots & \vdots \\ \emptyset & & \emptyset \\ & \vdots & \vdots \\ \emptyset & & \{ Z_k Y_m \} \end{array} \end{array} \right)$$

$$= id_R \otimes \left(\begin{array}{c|c|c} \begin{array}{ccc} \{ X_1 \} & \emptyset & \emptyset \\ & \ddots & \vdots \\ \emptyset & & \emptyset \\ & \vdots & \vdots \\ \emptyset & & \{ X_n \} \end{array} & \emptyset & \emptyset \\ \hline \emptyset & \{ U \} & \emptyset \\ \emptyset & \{ U \} & \emptyset \\ \hline \emptyset & \emptyset & \begin{array}{ccc} \{ Y_1 \} & \emptyset & \emptyset \\ & \ddots & \vdots \\ \emptyset & & \emptyset \\ & \vdots & \vdots \\ \emptyset & & \{ Y_m \} \end{array} \end{array} \right)$$

$$= id_R \otimes \mathcal{F}(P \oplus \mathfrak{t} \oplus Q).$$

Case 4: $\mathfrak{t} = \hat{\Upsilon}_U$.

$$\mathcal{F}(R \otimes_{\Gamma_\Sigma} (P \oplus \mathfrak{t} \oplus Q))$$

$$= \bigoplus_{k=1}^l \left[\bigoplus_{i=1}^n (\{ Z_k X_i \}) \oplus \emptyset_{0 \times 1} \oplus \bigoplus_{j=1}^m (\{ Z_k Y_j \}) \right]$$

$$\begin{aligned}
 &= \bigoplus_{k=1}^l \left(\begin{array}{c|c} \left(\begin{array}{ccc} \{\{Z_k X_1\}\} & \emptyset & \emptyset \\ \emptyset & \emptyset & \emptyset \\ \emptyset & \emptyset & \{\{Z_k X_n\}\} \end{array} \right) & \emptyset \\ \hline \emptyset & \left(\begin{array}{ccc} \{\{Z_k Y_1\}\} & \emptyset & \emptyset \\ \emptyset & \emptyset & \emptyset \\ \emptyset & \emptyset & \{\{Z_k X Y_m\}\} \end{array} \right) \end{array} \right) \\
 &= id_R \otimes (P \oplus \emptyset_{0 \times 1} \oplus Q).
 \end{aligned}$$

The other cases concerning $t = \triangleright_U$ and $t = \lrcorner_U$ are analogous. This concludes the proof of the claim, thus of the Theorem. \square

PROOF OF COROLLARY 6.7. The functor $\mathcal{F} : \mathbf{T}_\Sigma \rightarrow \mathbf{Mat}(\mathbf{C}_\Sigma^+)$ restricts and corestricts to an isomorphism of symmetric monoidal categories (with respect to \otimes) between \mathbf{Mnm} and the subcategory of $\mathbf{Mat}(\mathbf{C}_\Sigma^+)$ consisting only of 1×1 matrices, which is monoidally isomorphic to \mathbf{C}_Σ^+ . \square

F.4 Proof of Theorem 6.9

Let \mathbf{C} be any preorder-enriched category. Then we can equip $\mathbf{C}^+[X, Y]$ with the Egli-Milner preorder, which is defined as

$$\{c_1, \dots, c_n\} \leq^{EM} \{d_1, \dots, d_m\} \iff \forall i. \exists j. c_i \leq_{\mathbf{C}} d_j,$$

and this makes \mathbf{C}^+ a preorder-enriched category. Then also $\mathbf{Mat}(\mathbf{C}^+)$ is preorder-enriched, by simply setting

$$M \leq N \iff \forall j, i. M_{ji} \leq^{EM} N_{ji}.$$

We can also enrich $F_2(\mathbf{C})$ in a way that the isomorphism (36) becomes an isomorphism of preorder-enriched fb rig categories. To do so we need to add on the homsets of $F_2(\mathbf{C})$ the precongruence, with respect to composition, \oplus and \otimes , generated by the following axioms:

$$f \leq_{\mathbf{C}} g \implies \overline{f} \leq \overline{g}$$

$$\triangleleft_A; \triangleright_A \leq id_A$$

$$id_{A \oplus A} \leq \triangleright_A; \triangleleft_A$$

$$\uparrow_A; \lrcorner_A \leq id_A$$

$$id_0 \leq \lrcorner_A; \uparrow_A$$

It is straightforward to see that the functor \mathcal{F} of (36) preserves the inequalities of $F_2(\mathbf{C})$, while to show that \mathcal{G} respects the preorder on $\mathbf{Mat}(\mathbf{C}^+)$ we need the following result.

Lemma F.14. *Let \mathbf{C} be a preorder-enriched category and $c_1, \dots, c_n, d_1, \dots, d_m : A \rightarrow B$ in \mathbf{C} . If for all $i = 1, \dots, n$ there exists $j = 1, \dots, m$ such that $c_i \leq_{\mathbf{C}} d_j$, then*

$$\sum_{i=1}^n \overline{c_i} \leq \sum_{j=1}^m \overline{d_j}$$

where the above sums are induced by the finite biproduct structure of $F_2(\mathbf{C})$.

PROOF. By induction on n . Suppose $n = 0$: the premiss of the implication is trivially satisfied, and we have that

$$\begin{aligned}
 \sum_{i=1}^n \overline{c_i} &= 0_{A,B} \\
 &= \mathfrak{I}_A; \mathfrak{I}_B && \text{(definition of } 0_{A,B}\text{)} \\
 &= \mathfrak{I}_A; \mathfrak{I}_A; \sum_{j=1}^m \overline{d_j} && \text{(naturality of } \mathfrak{I}\text{)} \\
 &\leq \sum_{j=1}^m \overline{d_j} && (\mathfrak{I}_A; \mathfrak{I}_A \leq id_A)
 \end{aligned}$$

Let now $n \geq 0$, suppose the statement is true for n , consider $c_1, \dots, c_{n+1}, d_1, \dots, d_m : A \rightarrow B$ in \mathbf{C} such that for all $i = 1, \dots, n+1$ there is $j = 1, \dots, m$ for which $c_i \leq_C d_j$. Then we have

$$\begin{aligned}
 \sum_{i=1}^{n+1} \overline{c_i} &= \sum_{i=1}^n \overline{c_i} + \overline{c_{n+1}} && \text{(associativity of } +\text{)} \\
 &\leq \sum_{j=1}^m \overline{d_j} + \overline{c_{n+1}} && \text{(inductive hypothesis)} \\
 &\leq \sum_{j=1}^m \overline{d_j} + \overline{d_k} && (\overline{c_{n+1}} \leq \overline{d_k} \text{ for some } k) \\
 &= \sum_{\substack{1 \leq j \leq m \\ j \neq k}} \overline{d_j} + \overline{d_k} + \overline{d_k} && \text{(commutativity of } +\text{)} \\
 &= \sum_{\substack{1 \leq j \leq m \\ j \neq k}} \overline{d_j} + (\triangleleft_A; \overline{d_k} \oplus \overline{d_k}; \triangleright_B) && \text{(definition of } +\text{)} \\
 &= \sum_{\substack{1 \leq j \leq m \\ j \neq k}} \overline{d_j} + (\overline{d_k}; \triangleleft_B; \triangleright_B) && \text{(naturality of } \triangleleft\text{)} \\
 &\leq \sum_{\substack{1 \leq j \leq m \\ j \neq k}} \overline{d_j} + \overline{d_k} && (\triangleleft_B; \triangleright_B \leq id_B) \\
 &= \sum_{j=1}^m \overline{d_j} && \square
 \end{aligned}$$

Taking now $F_2(\mathbf{C})^\sim$ and $\mathbf{Mat}(\mathbf{C}^\dagger)^\sim$, we obtain a *poset*-enriched isomorphism. Observe that $\mathbf{Mat}(\mathbf{C}^\dagger)^\sim \cong \mathbf{Mat}((\mathbf{C}^\dagger)^\sim)$, because the order on matrices is entry by entry, and that $(\mathbf{C}^\dagger)^\sim \cong \mathbf{C}^\downarrow$, because it holds that for all $S, T \in \mathbf{C}^\dagger[X, Y]$:

$$S \leq^{EM} T \wedge T \leq^{EM} S \iff S \downarrow = T \downarrow.$$

If we apply this to $\mathbf{C} = \mathbf{C}_{\Sigma, \mathbb{I}}$, then we have that $F_2(\mathbf{C})^\sim = \mathbf{T}_{\Sigma, \mathbb{I}}^\sim$ and we obtain

$$\mathbf{T}_{\Sigma, \mathbb{I}}^\sim \cong \mathbf{Mat}(\mathbf{C}_{\Sigma, \mathbb{I}}^\downarrow).$$

Theorem 6.9 now follows from the simple observation that $\mathbf{C}_{\Sigma, \mathbb{I}}^\downarrow \cong \mathbf{C}_{\Sigma, \mathbb{I}}^\downarrow$.

G PROOFS OF SECTION 7

In this Appendix we provide the details for proofs in Section 7. In Section G.1 we prove Theorem 7.3, which states that \mathbf{T}_{CB_2} is a cartesian bicategory. In Section G.2 we prove Proposition 7.4, regarding the bijective correspondence between interpretations and morphisms of sesquistrict fb-cb rig categories. In Section G.3 we prove our completeness result (Theorem 7.5). Finally in Section G.4 we show the proof for the other results stated in Section 7, that is Proposition 7.7 and Corollary 7.8.

G.1 Proof of Theorem 7.3

Lemma G.1. *For all P_1, P_2 polynomials the following holds:*

$$\blacktriangleleft_{P_1 \oplus P_2} = (\blacktriangleleft_{P_1} \oplus \flat_{P_1 P_2}); (\delta_{P_1, P_1, P_2}^{-l} \oplus (\flat_{P_2 P_1} \oplus \blacktriangleleft_{P_2})); \delta_{P_2, P_1, P_2}^{-l}$$

PROOF. First observe that the following holds for all polynomials P, Q, R :

$$\flat_{P(Q \oplus R)} \stackrel{(W9)}{=} R_{Q \oplus R}(\flat_P) \stackrel{(W6)}{=} (R_Q(\flat_P) \oplus R_R(\flat_P)); \delta_{P, Q, R}^{-l} \stackrel{(W9)}{=} (\flat_{PQ} \oplus \flat_{PR}); \delta_{P, Q, R}^{-l} \quad (*)$$

Then we proceed by induction on P_1 .

Case $P = 0$:

$$\begin{aligned} & (\blacktriangleleft_0 \oplus \flat_{0 P_2}); \delta_{0, 0, P_2}^{-l} \oplus (\flat_{P_2 0} \oplus \blacktriangleleft_{P_2}); \delta_{P_2, 0, P_2}^{-l} \\ &= (id_0 \oplus \flat_{0 P_2}); \delta_{0, 0, P_2}^{-l} \oplus (\flat_{P_2 0} \oplus \blacktriangleleft_{P_2}); \delta_{P_2, 0, P_2}^{-l} && \text{(Def. } \blacktriangleleft) \\ &= (id_0 \oplus id_0); \delta_{0, 0, P_2}^{-l} \oplus (id_0 \oplus \blacktriangleleft_{P_2}); \delta_{P_2, 0, P_2}^{-l} && \text{(Def. } \flat) \\ &= (id_0 \oplus id_0); id_0 \oplus (id_0 \oplus \blacktriangleleft_{P_2}); \delta_{P_2, 0, P_2}^{-l} && \text{(Def. } \delta^l) \\ &= (id_0 \oplus id_0); id_0 \oplus (id_0 \oplus \blacktriangleleft_{P_2}); id_{P_2 P_2} && \text{(Lemma E.1.3)} \\ &= \blacktriangleleft_{P_2} \\ &= \blacktriangleleft_{0 \oplus P_2} && \text{(Funct. } \otimes) \end{aligned}$$

Case $P = U \oplus P'$:

The diagrammatic proof for $P = U \oplus P'$ consists of four stages:

- Stage 1 (Top Left):** The initial expression $\blacktriangleleft_{U \oplus P_2}$ is expanded into its components: $(\blacktriangleleft_U \oplus \flat_{U P_2}); (\delta_{U \oplus P', U \oplus P', P_2}^{-l} \oplus (\flat_{P_2 U} \oplus \blacktriangleleft_{P_2})); \delta_{P_2, U \oplus P', P_2}^{-l}$.
- Stage 2 (Top Right):** The expression is simplified using the definition of \blacktriangleleft to $(\blacktriangleleft_U \oplus \flat_{U P_2}); \delta_{U \oplus P', U \oplus P', P_2}^{-l} \oplus (\flat_{P_2 U} \oplus \blacktriangleleft_{P_2}); \delta_{P_2, U \oplus P', P_2}^{-l}$.
- Stage 3 (Bottom Left):** Further simplification using the definition of δ^l and axiom (W9) leads to $(\blacktriangleleft_U \oplus \flat_{U P_2}); id_U \oplus (id_{U \oplus P'} \oplus \blacktriangleleft_{P_2}); \delta_{P_2, U \oplus P', P_2}^{-l}$.
- Stage 4 (Bottom Right):** The final expression is $(\blacktriangleleft_U \oplus \flat_{U P_2}); id_U \oplus (id_{U \oplus P'} \oplus \blacktriangleleft_{P_2}); \delta_{P_2, U \oplus P', P_2}^{-l}$, which is equal to the original expression by axiom (W5).

Deconstructing the Calculus of Relations with Tape Diagrams

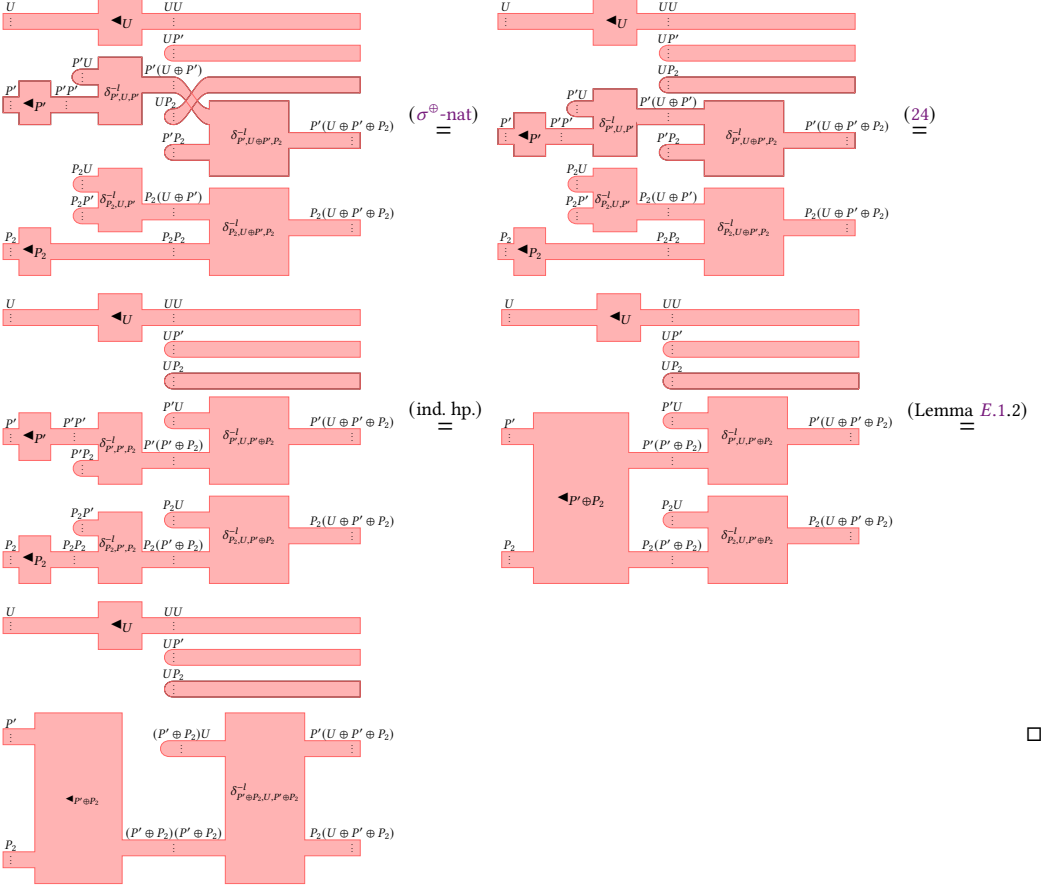

Lemma G.2. For all P_1, P_2 polynomials the following holds:

$$!_{P_1 \oplus P_2} = (!_{P_1} \oplus !_{P_2}); \triangleright_1$$

PROOF. By induction on P_1 .

Case $P = 0$:

$$(!_0 \oplus !_{P_2}); \triangleright_1 \stackrel{(\text{def. } !)}{=} (!_1 \oplus !_{P_2}); \triangleright_1 \stackrel{(\text{funct. } \oplus)}{=} (id_0 \oplus !_{P_2}); (\!_1 \oplus id_1); \triangleright_1 \stackrel{(\triangleright\text{-un})}{=} !_{P_2} \stackrel{(\text{funct. } \oplus)}{=} !_{0 \oplus P_2}$$

Case $P = U \oplus P'$:

$$\begin{aligned} !_{(U \oplus P') \oplus P_2} &= !_{U \oplus (P' \oplus P_2)} && (\text{Assoc. } \oplus) \\ &= (!_U \oplus !_{P' \oplus P_2}); \triangleright_1 && (\text{Def. } !) \\ &= (!_U \oplus ((!_{P'} \oplus !_{P_2}); \triangleright_1)); \triangleright_1 && (\text{Ind. hp.}) \\ &= (((!_U \oplus !_{P'}); \triangleright_1) \oplus !_{P_2}); \triangleright_1 && (\triangleright\text{-as}) \\ &= (!_{U \oplus P'} \oplus !_{P_2}); \triangleright_1 && (\text{Def. } !) \end{aligned}$$

□

Lemma G.3 (Adjointness). The following hold for any polynomial P

$$!_P; !_P \leq id_1 \quad id_P \leq !_P; !_P \quad \triangleright_P; \triangleleft_P \leq id_{P \otimes P} \quad id_P \leq \triangleleft_P; \triangleright_P$$

PROOF.

EQUATION $i_P; !P \leq id_1$: by induction on P .

Case $P = 0$: $i_0; !_0 \stackrel{(\text{def. } i; !)}{=} \circlearrowleft_1; \circlearrowright_1 \stackrel{(\text{?}\delta)}{\leq} id_1$

Case $P = U \oplus P'$:

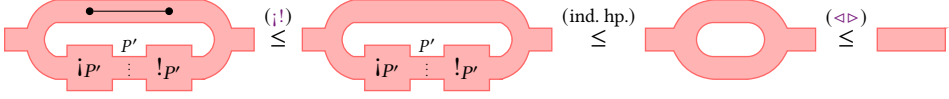

EQUATION $id_P \leq !P; i_P$: by induction on P .

Case $P = 0$: $id_0 \stackrel{(\text{bo})}{=} \circlearrowright_1; \circlearrowleft_1 \stackrel{(\text{def. } !; i)}{=} !_0; i_0$

Case $P = U \oplus P'$:

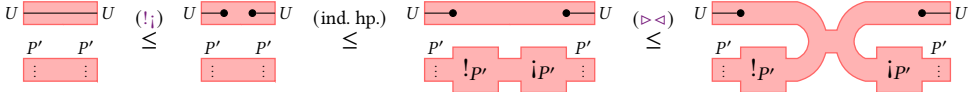

EQUATION $\blacktriangleright_P; \blacktriangleleft_P \leq id_{P \otimes P}$: by induction on P .

Case $P = 0$: $id_0; id_0 = id_0 = id_{0 \otimes 0}$

Case $P = U \oplus P'$:

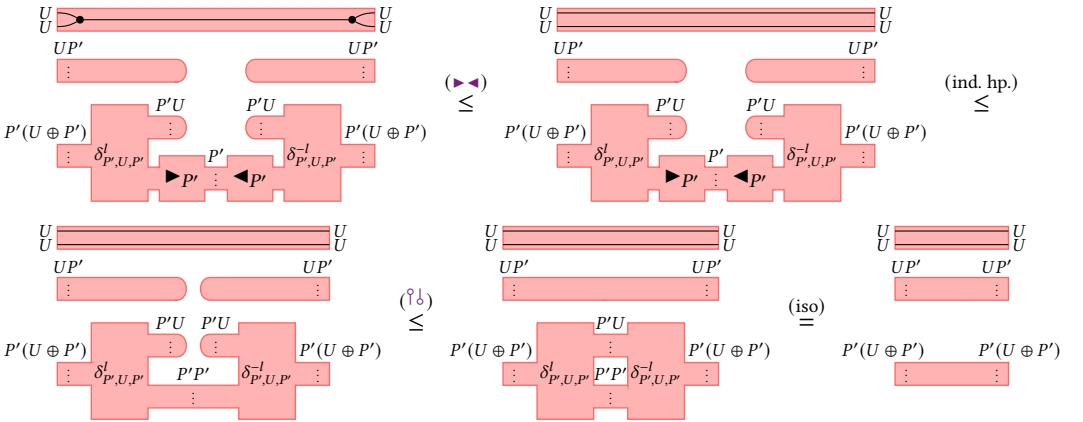

EQUATION $id_P \leq \blacktriangleleft_P; \blacktriangleright_P$: by induction on P .

Case $P = 0$: $id_0 \leq id_0 = id_0; id_0$

Case $P = U \oplus P'$:

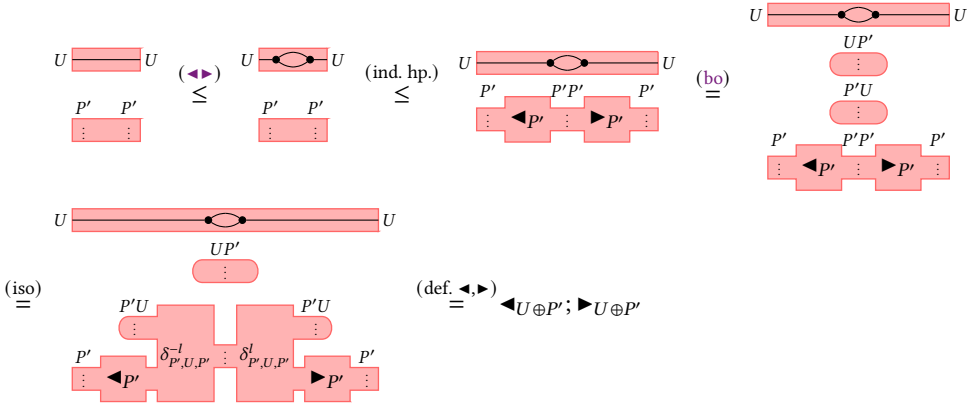

□

Lemma G.4 (Comonoid). *The following hold for any polynomial P*

$$\blacktriangleleft_P; \sigma_{P,P}^{\otimes} = \blacktriangleleft_P \quad \blacktriangleleft_P; R_P(!_P) = id_P \quad \blacktriangleleft_P; R_P(\blacktriangleleft_P) = \blacktriangleleft_P; L_P(\blacktriangleleft_P)$$

PROOF.

EQUATION $\blacktriangleleft_P; \sigma_{P,P}^{\otimes} = \blacktriangleleft_P$: by induction on P .

Case $P = 0$: $\blacktriangleleft_0; \sigma_{0,0}^{\otimes} = id_0; id_0 = id_0 = \blacktriangleleft_0$

Case $P = U \oplus P'$:

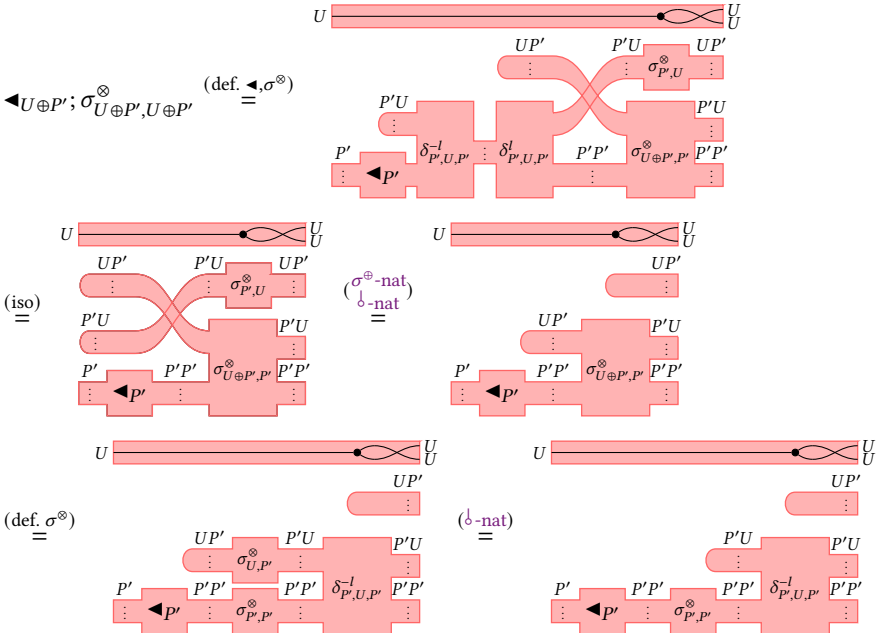

$$\begin{array}{c}
 U \xrightarrow{\quad} U \\
 \text{ind. hp.} \leq \begin{array}{c} \leftarrow \text{co} \\ \text{ind. hp.} \end{array} \leq \begin{array}{c} \text{UP}' \\ \vdots \\ \text{P}'U \quad \text{P}'U \\ \vdots \\ \text{P}' \quad \text{P}'P' \quad \delta_{P',U,P'}^{-l} \quad \text{P}'P' \\ \vdots \\ \leftarrow \text{P}' \quad \vdots \end{array} \xrightarrow{\text{def. } \leftarrow} \leftarrow_{U \oplus P'}
 \end{array}$$

EQUATION $\leftarrow_P; R_P(!_P) = id_P$: by induction on P .

Case $P = 0$: $id_0; R_0(\delta_1) = id_0; id_0 = id_0$

Case $P = U \oplus P'$:

$$\begin{aligned}
 & \leftarrow_{U \oplus P'}; R_{U \oplus P'}(!_U \oplus P') \\
 &= (\leftarrow_U \oplus \downarrow_{UP'} \oplus ((\downarrow_{P'U} \oplus \leftarrow_{P'}); \delta_{P',U,P'}^{-l}); R_{U \oplus P'}(!_U \oplus !_{P'}; \triangleright_1)) && \text{(Def. } \leftarrow, !\text{)} \\
 &= (\leftarrow_U \oplus \downarrow_{UP'} \oplus ((\downarrow_{P'U} \oplus \leftarrow_{P'}); \delta_{P',U,P'}^{-l}); && \text{(W6)} \\
 & \quad \delta_{U \oplus P',U,P'}^l; (R_U(!_U \oplus !_{P'}; \triangleright_1) \oplus R_{P'}(!_U \oplus !_{P'}; \triangleright_1))) \\
 &= (\leftarrow_U \oplus \downarrow_{UP'} \oplus ((\downarrow_{P'U} \oplus \leftarrow_{P'}); \delta_{P',U,P'}^{-l}); && \text{(Def. } \delta^l\text{)} \\
 & \quad (id_{U(U \oplus P')} \oplus \delta_{P',U,P'}^l); (id_{UU} \oplus \sigma_{UP',P'U}^{\oplus} \oplus id_{P'P'}) \\
 & \quad (R_U(!_U \oplus !_{P'}; \triangleright_1) \oplus R_{P'}(!_U \oplus !_{P'}; \triangleright_1))) \\
 &= (\leftarrow_U \oplus \downarrow_{UP'} \oplus ((\downarrow_{P'U} \oplus \leftarrow_{P'}); \delta_{P',U,P'}^{-l}; \delta_{P',U,P'}^l)); && \text{(Funct. } \oplus\text{)} \\
 & \quad (id_{UU} \oplus \sigma_{UP',P'U}^{\oplus} \oplus id_{P'P'}); (R_U(!_U \oplus !_{P'}; \triangleright_1) \oplus R_{P'}(!_U \oplus !_{P'}; \triangleright_1)) \\
 &= (\leftarrow_U \oplus \downarrow_{UP'} \oplus \downarrow_{P'U} \oplus \leftarrow_{P'}); && \text{(Iso)} \\
 & \quad (id_{UU} \oplus \sigma_{UP',P'U}^{\oplus} \oplus id_{P'P'}); (R_U(!_U \oplus !_{P'}; \triangleright_1) \oplus R_{P'}(!_U \oplus !_{P'}; \triangleright_1)) \\
 &= (\leftarrow_U \oplus \downarrow_{P'U} \oplus \downarrow_{UP'} \oplus \leftarrow_{P'}); (R_U(!_U \oplus !_{P'}; \triangleright_1) \oplus R_{P'}(!_U \oplus !_{P'}; \triangleright_1)) && \text{(\sigma}^{\oplus}\text{-nat)} \\
 &= (\leftarrow_U \oplus \downarrow_{P'U} \oplus \downarrow_{UP'} \oplus \leftarrow_{P'}); ((R_U(!_U) \oplus R_U(!__{P'})); R_U(\triangleright_1) \oplus R_{P'}(!_U) \oplus R_{P'}(!__{P'})); R_P(\triangleright_1)) && \text{(W2)} \\
 &= (\leftarrow_U \oplus \downarrow_{P'U} \oplus \downarrow_{UP'} \oplus \leftarrow_{P'}); ((\text{U} \xrightarrow{\quad} \text{U} \oplus R_U(!__{P'})); \triangleright_U \oplus R_{P'}(!_U) \oplus R_{P'}(!__{P'})); \triangleright_{P'}) && \text{(Def. } R\text{)} \\
 &= (\text{U} \xrightarrow{\quad} \text{U} \oplus \downarrow_{P'U}; R_U(!__{P'})); \triangleright_U \oplus (\downarrow_{P'U}; R_{P'}(!_U) \oplus \leftarrow_{P'}; R_{P'}(!__{P'})); \triangleright_{P'} && \text{(Funct. } \oplus\text{)} \\
 &= (id_U \oplus \downarrow_{P'U}; R_U(!__{P'})); \triangleright_U \oplus (\downarrow_{P'U}; R_{P'}(!_U) \oplus id_{P'}); \triangleright_{P'} && \text{(\leftarrow-un, ind. hp.)} \\
 &= (id_U \oplus \downarrow_U); \triangleright_U \oplus (\downarrow_{P'} \oplus id_{P'}); \triangleright_{P'} && \text{(\uparrow-nat)} \\
 &= id_U \oplus id_{P'} && \text{(\triangleright-un)} \\
 &= id_{U \oplus P'} && \text{(Funct. } \oplus\text{)}
 \end{aligned}$$

EQUATION $\leftarrow_P; R_P(\leftarrow_P) = \leftarrow_P; L_P(\leftarrow_P)$: by induction on P .

Case $P = 0$: $\leftarrow_0; R_0(\leftarrow_0) \stackrel{\text{(def. } \leftarrow, R\text{)}}{=} id_0; id_0 \stackrel{\text{(def. } \leftarrow, L\text{)}}{=} \leftarrow_0; L_0(\leftarrow_0)$

Case $P = U \oplus P'$: We will split the proof in two parts. The first part proves the following statement:

$$(\leftarrow_U \oplus \downarrow_{UP'}); R_{U \oplus P'}(\leftarrow_U \oplus \downarrow_{UP'}) = (\leftarrow_U \oplus \downarrow_{UP'}); L_U(\leftarrow_U \oplus P') \quad (*1)$$

$$\begin{aligned}
 & (\blacktriangleleft_U \oplus \flat_{UP'}) ; R_{U \oplus P'}(\blacktriangleleft_U \oplus \flat_{UP'}) \\
 &= (\blacktriangleleft_U \oplus \flat_{UP'}) ; (R_{U \oplus P'}(\blacktriangleleft_U) \oplus R_{U \oplus P'}(\flat_{UP'})) && \text{(W5)} \\
 &= (\blacktriangleleft_U \oplus \flat_{UP'}) ; (R_U(\blacktriangleleft_U) \oplus R_{P'}(\blacktriangleleft_U) \oplus R_{U \oplus P'}(\flat_{UP'})) && \text{(W6)} \\
 &= (\blacktriangleleft_U ; R_U(\blacktriangleleft_U)) \oplus \flat_{UP'} ; (R_{P'}(\blacktriangleleft_U) \oplus R_{U \oplus P'}(\flat_{UP'})) && \text{(Funct. } \oplus) \\
 &= (\blacktriangleleft_U ; R_U(\blacktriangleleft_U)) \oplus \flat_{UUP' \oplus UP'}(U \oplus P') && (\flat\text{-nat)} \\
 &= (\blacktriangleleft_U ; L_U(\blacktriangleleft_U)) \oplus \flat_{UUP' \oplus UP'}(U \oplus P') && (\blacktriangleleft\text{-as)} \\
 &= (\blacktriangleleft_U ; L_U(\blacktriangleleft_U)) \oplus (\flat_{UP'} ; L_U(\flat_{UP'} \oplus (\flat_{P'U} \oplus \blacktriangleleft_{P'})) ; \delta_{P',U,P'}^l) && (\flat\text{-nat)} \\
 &= (\blacktriangleleft_U \oplus \flat_{UP'}) ; (L_U(\blacktriangleleft_U) \oplus L_U(\flat_{UP'} \oplus (\flat_{P'U} \oplus \blacktriangleleft_{P'})) ; \delta_{P',U,P'}^l) && \text{(Funct. } \oplus) \\
 &= (\blacktriangleleft_U \oplus \flat_{UP'}) ; (L_U(\blacktriangleleft_U \oplus \flat_{UP'} \oplus (\flat_{P'U} \oplus \blacktriangleleft_{P'})) ; \delta_{P',U,P'}^l) && \text{(W5)} \\
 &= (\blacktriangleleft_U \oplus \flat_{UP'}) ; L_U(\blacktriangleleft_{U \oplus P'}) && \text{(Def. } \blacktriangleleft)
 \end{aligned}$$

For the second part we prove the following statement

$$(\flat_{P'U} \oplus \blacktriangleleft_{P'}) ; \delta_{P',U,P'}^{-l} ; R_{U \oplus P'}((\flat_{P'U} \oplus \blacktriangleleft_{P'}) ; \delta_{P',U,P'}^{-l}) = (\flat_{P'U} \oplus \blacktriangleleft_{P'}) ; \delta_{P',U,P'}^{-l} ; L_{P'}(\blacktriangleleft_{U \oplus P'}) \quad (*_2)$$

Starting from the right hand side of the equation

$$\begin{aligned}
 & (\flat_{P'U} \oplus \blacktriangleleft_{P'}) ; \delta_{P',U,P'}^{-l} ; L_{P'}(\blacktriangleleft_{U \oplus P'}) \\
 &= (\flat_{P'U} \oplus \blacktriangleleft_{P'}) ; \delta_{P',U,P'}^{-l} ; L_{P'}(\blacktriangleleft_U \oplus \flat_{UP'} \oplus (\flat_{P'U} \oplus \blacktriangleleft_{P'})) ; \delta_{P',U,P'}^{-l} && \text{(Def. } \blacktriangleleft) \\
 &= (\flat_{P'U} \oplus \blacktriangleleft_{P'}) ; (L_{P'}(\blacktriangleleft_U \oplus \flat_{UP'}) \oplus L_{P'}((\flat_{P'U} \oplus \blacktriangleleft_{P'}) ; \delta_{P',U,P'}^{-l})) ; \delta_{P',U}^{-l}(U \oplus P'), P'(U \oplus P') && \text{(W5)} \\
 &= ((\flat_{P'U} ; L_{P'}(\blacktriangleleft_U \oplus \flat_{UP'})) \oplus (\blacktriangleleft_{P'} ; L_{P'}((\flat_{P'U} \oplus \blacktriangleleft_{P'}) ; \delta_{P',U,P'}^{-l}))) ; \delta_{P',U}^{-l}(U \oplus P'), P'(U \oplus P') && \text{(Funct. } \oplus) \\
 &= (\flat_{P'U}(U \oplus P')) \oplus (\blacktriangleleft_{P'} ; L_{P'}((\flat_{P'U} \oplus \blacktriangleleft_{P'}) ; \delta_{P',U,P'}^{-l})) ; \delta_{P',U}^{-l}(U \oplus P'), P'(U \oplus P') && (\flat\text{-nat)} \\
 &= (\flat_{P'U}(U \oplus P')) \oplus (\blacktriangleleft_{P'} ; L_{P'}(\blacktriangleleft_{P'} ; (\flat_{P'U} \oplus id_{P'})) ; \delta_{P',U,P'}^{-l}) ; \delta_{P',U}^{-l}(U \oplus P'), P'(U \oplus P') && \text{(Funct. } \oplus) \\
 &= (\flat_{P'U}(U \oplus P')) \oplus (\blacktriangleleft_{P'} ; L_{P'}(\blacktriangleleft_{P'} ; L_{P'}(\flat_{P'U} \oplus id_{P'})) ; L_{P'}(\delta_{P',U,P'}^{-l})) ; \delta_{P',U}^{-l}(U \oplus P'), P'(U \oplus P') && \text{(W2)} \\
 &= (\flat_{P'U}(U \oplus P')) \oplus (\blacktriangleleft_{P'} ; L_{P'}(\blacktriangleleft_{P'} ; L_{P'}(\flat_{P'U} \oplus id_{P'})) ; \delta_{P',P',U,P'}^l ; \delta_{P',P',U,P'}^{-l}) ; \delta_{P',U}^{-l}(U \oplus P'), P'(U \oplus P') && \text{(W16)} \\
 &= (\flat_{P'U}(U \oplus P')) \oplus (\blacktriangleleft_{P'} ; L_{P'}(\blacktriangleleft_{P'})) ; (L_{P'}(\flat_{P'U}) \oplus L_{P'}(id_{P'})) ; \delta_{P',P',U,P'}^{-l} ; \delta_{P',U}^{-l}(U \oplus P'), P'(U \oplus P') && \text{(W5)} \\
 &= (\flat_{P'U}(U \oplus P')) \oplus (\blacktriangleleft_{P'} ; L_{P'}(\blacktriangleleft_{P'})) ; (\flat_{P'P'U} \oplus id_{P'P'}) ; \delta_{P',P',U,P'}^{-l} ; \delta_{P',U}^{-l}(U \oplus P'), P'(U \oplus P') && \text{(W9, W1)} \\
 &= (\flat_{P'U}(U \oplus P')) \oplus ((\flat_{P'P'U} \oplus \blacktriangleleft_{P'} ; L_{P'}(\blacktriangleleft_{P'})) ; \delta_{P',P',U,P'}^{-l}) ; \delta_{P',U}^{-l}(U \oplus P'), P'(U \oplus P') && \text{(Funct. } \oplus) \\
 &= (R_{U \oplus P'}(\flat_{P'U}) \oplus ((\flat_{P'P'U} \oplus \blacktriangleleft_{P'} ; L_{P'}(\blacktriangleleft_{P'})) ; \delta_{P',P',U,P'}^{-l})) ; \delta_{P',U}^{-l}(U \oplus P'), P'(U \oplus P') && \text{(W9)} \\
 &= (((\flat_{P'UU} \oplus \flat_{P'UP'}) ; \delta_{P',U,P'}^{-l}) \oplus ((\flat_{P'P'U} \oplus \blacktriangleleft_{P'} ; L_{P'}(\blacktriangleleft_{P'})) ; \delta_{P',P',U,P'}^{-l})) ; \delta_{P',U}^{-l}(U \oplus P'), P'(U \oplus P') && \text{(W6)} \\
 &= (\flat_{P'UU} \oplus \flat_{P'UP'} \oplus \flat_{P'P'U} \oplus \blacktriangleleft_{P'} ; L_{P'}(\blacktriangleleft_{P'})) ; (\delta_{P',U,P'}^{-l} \oplus \delta_{P',P',U,P'}^{-l}) ; \delta_{P',U}^{-l}(U \oplus P'), P'(U \oplus P') && \text{(Funct. } \oplus) \\
 &= (\flat_{P'UU} \oplus \flat_{P'UP'} \oplus \flat_{P'P'U} \oplus \blacktriangleleft_{P'} ; L_{P'}(\blacktriangleleft_{P'})) ; && \text{(Lemma E.1.2)} \\
 & \quad (id_{P'UU} \oplus \sigma_{P'UP',P'P'U}^{\oplus} id_{P'P'P'}) ; \delta_{P',U \oplus P',U,P'}^{-l} ; \delta_{P',U}^{-l}(U \oplus P'), P'(U \oplus P')
 \end{aligned}$$

$$\begin{aligned}
 &= (\flat_{P'UU} \oplus \flat_{P'P'U} \oplus \flat_{P'UP'} \oplus \blacktriangleleft_{P'}; L_{P'}(\blacktriangleleft_{P'})); \delta_{P'U \oplus P'P', U, P'}^{-1}; \delta_{P', U(U \oplus P'), P'(U \oplus P')}^{-1} && (\sigma^{\oplus}\text{-nat}) \\
 &= (\flat_{P'UU} \oplus \flat_{P'P'U} \oplus \flat_{P'UP'} \oplus \blacktriangleleft_{P'}; R_{P'}(\blacktriangleleft_{P'})); \delta_{P'U \oplus P'P', U, P'}^{-1}; \delta_{P', U(U \oplus P'), P'(U \oplus P')}^{-1} && (\text{Ind. hp.}) \\
 &= (\flat_{P'UU} \oplus \flat_{P'P'U} \oplus R_{P'}(\flat_{P'U}) \oplus \blacktriangleleft_{P'}; R_{P'}(\blacktriangleleft_{P'})); \delta_{P'U \oplus P'P', U, P'}^{-1}; R_{U \oplus P'}(\delta_{P', U, P'}^{-1}) && (\text{W9, W16}) \\
 &= (\flat_{P'UU} \oplus \flat_{P'P'U} \oplus \blacktriangleleft_{P'}; (R_{P'}(\flat_{P'U}) \oplus R_{P'}(\blacktriangleleft_{P'}))); \delta_{P'U \oplus P'P', U, P'}^{-1}; R_{U \oplus P'}(\delta_{P', U, P'}^{-1}) && (\text{Funct. } \oplus) \\
 &= (\flat_{P'UU} \oplus \flat_{P'P'U} \oplus \blacktriangleleft_{P'}; R_{P'}(\flat_{P'U} \oplus \blacktriangleleft_{P'})); \delta_{P'U \oplus P'P', U, P'}^{-1}; R_{U \oplus P'}(\delta_{P', U, P'}^{-1}) && (\text{W5}) \\
 &= ((\flat_{P'U}; R_U(\flat_{P'U} \oplus \blacktriangleleft_{P'})) \oplus \blacktriangleleft_{P'}; R_{P'}(\flat_{P'U} \oplus \blacktriangleleft_{P'})); \delta_{P'U \oplus P'P', U, P'}^{-1}; R_{U \oplus P'}(\delta_{P', U, P'}^{-1}) && (\flat\text{-nat}) \\
 &= (\flat_{P'U} \oplus \blacktriangleleft_{P'}); (R_U(\flat_{P'U} \oplus \blacktriangleleft_{P'}) \oplus R_{P'}(\flat_{P'U} \oplus \blacktriangleleft_{P'})); \delta_{P'U \oplus P'P', U, P'}^{-1}; R_{U \oplus P'}(\delta_{P', U, P'}^{-1}) && (\text{Funct. } \oplus) \\
 &= (\flat_{P'U} \oplus \blacktriangleleft_{P'}); \delta_{P', U, P'}^{-1}; R_{U \oplus P'}(\flat_{P'U} \oplus \blacktriangleleft_{P'}); R_{U \oplus P'}(\delta_{P', U, P'}^{-1}) && (\text{W6}) \\
 &= (\flat_{P'U} \oplus \blacktriangleleft_{P'}); \delta_{P', U, P'}^{-1}; R_{U \oplus P'}((\flat_{P'U} \oplus \blacktriangleleft_{P'}); \delta_{P', U, P'}^{-1}) && (\text{W2})
 \end{aligned}$$

We conclude the proof by showing that

$$\begin{aligned}
 &\blacktriangleleft_{U \oplus P'}; R_{U \oplus P'}(\blacktriangleleft_{U \oplus P'}) \\
 &= (\blacktriangleleft_U \oplus \flat_{UP'} \oplus (\flat_{P'U} \oplus \blacktriangleleft_{P'}); \delta_{P', U, P'}^{-1}; R_{U \oplus P'}(\blacktriangleleft_U \oplus \flat_{UP'} \oplus (\flat_{P'U} \oplus \blacktriangleleft_{P'}); \delta_{P', U, P'}^{-1})) && (\text{Def. } \blacktriangleleft) \\
 &= (\blacktriangleleft_U \oplus \flat_{UP'} \oplus (\flat_{P'U} \oplus \blacktriangleleft_{P'}); \delta_{P', U, P'}^{-1}; (R_{U \oplus P'}(\blacktriangleleft_U \oplus \flat_{UP'}) \oplus R_{U \oplus P'}((\flat_{P'U} \oplus \blacktriangleleft_{P'}); \delta_{P', U, P'}^{-1}))) && (\text{W5}) \\
 &= (\blacktriangleleft_U \oplus \flat_{UP'}); R_{U \oplus P'}(\blacktriangleleft_U \oplus \flat_{UP'}) \oplus (\flat_{P'U} \oplus \blacktriangleleft_{P'}); \delta_{P', U, P'}^{-1}; R_{U \oplus P'}((\flat_{P'U} \oplus \blacktriangleleft_{P'}); \delta_{P', U, P'}^{-1}) && (\text{Funct. } \oplus) \\
 &= (\blacktriangleleft_U \oplus \flat_{UP'}); L_U(\blacktriangleleft_{U \oplus P'}) \oplus (\flat_{P'U} \oplus \blacktriangleleft_{P'}); \delta_{P', U, P'}^{-1}; L_{P'}(\blacktriangleleft_{U \oplus P'}) && (*_1, *_2) \\
 &= (\blacktriangleleft_U \oplus \flat_{UP'} \oplus (\flat_{P'U} \oplus \blacktriangleleft_{P'}); \delta_{P', U, P'}^{-1}; (L_U(\blacktriangleleft_{U \oplus P'}) \oplus L_{P'}(\blacktriangleleft_{U \oplus P'}))) && (\text{Funct. } \oplus) \\
 &= (\blacktriangleleft_U \oplus \flat_{UP'} \oplus (\flat_{P'U} \oplus \blacktriangleleft_{P'}); \delta_{P', U, P'}^{-1}; L_{U \oplus P'}(\blacktriangleleft_{U \oplus P'})) && (\text{W6}) \\
 &= \blacktriangleleft_{U \oplus P'}; L_{U \oplus P'}(\blacktriangleleft_{U \oplus P'}) && (\text{Def. } \blacktriangleleft)
 \end{aligned}$$

as required. \square

Lemma G.5 (Frobenius). *The following hold for any polynomial P*

$$\blacktriangleleft_P; \blacktriangleright_P = id_P \quad R_P(\blacktriangleleft_P); L_P(\blacktriangleright_P) = \blacktriangleright_P; \blacktriangleleft_P$$

PROOF.

EQUATION $\blacktriangleleft_P; \blacktriangleright_P = id_P$: analogous to the proof of $id_P \leq \blacktriangleleft_P; \blacktriangleright_P$.

EQUATION $R_P(\blacktriangleleft_P); L_P(\blacktriangleright_P) = \blacktriangleright_P; \blacktriangleleft_P$: by induction on P .

Case $P = 0$: $\blacktriangleright_0; \blacktriangleleft_0 = id_0$; $id_0 = R_0(\blacktriangleleft_0); L_P(\blacktriangleright_0)$

Case $P = U \oplus P'$: We will split the proof in two parts. The first part proves the following statement:

$$R_{U \oplus P'}(\blacktriangleleft_U \oplus \flat_{UP'}); L_U(\blacktriangleright_{U \oplus P'}) = (\blacktriangleright_U; \blacktriangleleft_U) \oplus (\flat_{UP'}; \flat_{UP'}) \quad (*1)$$

$$\begin{aligned}
 & RU_{\oplus P'}(\blacktriangleleft_U \oplus \downarrow_{UP'}); LU(\blacktriangleright_{U \oplus P'}) \\
 &= (RU_{\oplus P'}(\blacktriangleleft_U) \oplus RU_{\oplus P'}(\downarrow_{UP'})); LU(\blacktriangleright_{U \oplus P'}) \tag{W5} \\
 &= (RU_{\oplus P'}(\blacktriangleleft_U) \oplus RU_{\oplus P'}(\downarrow_{UP'})); LU(\blacktriangleright_U \oplus \uparrow_{UP'} \oplus \delta_{P',U,P'}^l; (\uparrow_{P'U} \oplus \blacktriangleright_{P'})) \tag{Def. \blacktriangleright} \\
 &= (RU_{\oplus P'}(\blacktriangleleft_U) \oplus RU_{\oplus P'}(\downarrow_{UP'})); (LU(\blacktriangleright_U \oplus \uparrow_{UP'}) \oplus LU(\delta_{P',U,P'}^l; (\uparrow_{P'U} \oplus \blacktriangleright_{P'}))) \tag{W5} \\
 &= (RU_{\oplus P'}(\blacktriangleleft_U); LU(\blacktriangleright_U \oplus \uparrow_{UP'})) \oplus (RU_{\oplus P'}(\downarrow_{UP'}); LU(\delta_{P',U,P'}^l; (\uparrow_{P'U} \oplus \blacktriangleright_{P'}))) \tag{Funct. \oplus} \\
 &= (RU_{\oplus P'}(\blacktriangleleft_U); LU(\blacktriangleright_U \oplus \uparrow_{UP'})) \oplus (\downarrow_{UP'}(U \oplus P'); LU(\delta_{P',U,P'}^l; (\uparrow_{P'U} \oplus \blacktriangleright_{P'}))) \tag{W9} \\
 &= (RU_{\oplus P'}(\blacktriangleleft_U); LU(\blacktriangleright_U \oplus \uparrow_{UP'})) \oplus \downarrow_{UP'} \tag{\downarrow-nat} \\
 &= ((RU(\blacktriangleleft_U) \oplus R_{P'}(\blacktriangleleft_U)); (LU(\blacktriangleright_U) \oplus LU(\uparrow_{UP'}))) \oplus \downarrow_{UP'} \tag{W6, W5} \\
 &= (RU(\blacktriangleleft_U); LU(\blacktriangleright_U)) \oplus (R_{P'}(\blacktriangleleft_U); LU(\uparrow_{UP'})) \oplus \downarrow_{UP'} \tag{Funct. \oplus} \\
 &= (RU(\blacktriangleleft_U); LU(\blacktriangleright_U)) \oplus (R_{P'}(\blacktriangleleft_U); \uparrow_{UP'}) \oplus \downarrow_{UP'} \tag{W9} \\
 &= (RU(\blacktriangleleft_U); LU(\blacktriangleright_U)) \oplus \uparrow_{UP'} \oplus \downarrow_{UP'} \tag{\uparrow-nat} \\
 &= (\blacktriangleright_U; \blacktriangleleft_U) \oplus \uparrow_{UP'} \oplus \downarrow_{UP'} \tag{F}
 \end{aligned}$$

For the second part we prove the following statement

$$RU_{\oplus P'}((\downarrow_{P'U} \oplus \blacktriangleleft_{P'}); \delta_{P',U,P'}^{-l}; L_{P'}(\blacktriangleright_{U \oplus P'})) = \delta_{P',U,P'}^l; (\uparrow_{P'U} \oplus \blacktriangleright_{P'}); (\downarrow_{P'U} \oplus \blacktriangleleft_{P'}); \delta_{P',U,P'}^{-l} \tag{*_2}$$

$$\begin{aligned}
 & RU_{\oplus P'}((\downarrow_{P'U} \oplus \blacktriangleleft_{P'}); \delta_{P',U,P'}^{-l}; L_{P'}(\blacktriangleright_{U \oplus P'})) \\
 &= RU_{\oplus P'}(\downarrow_{P'U} \oplus \blacktriangleleft_{P'}); RU_{\oplus P'}(\delta_{P',U,P'}^{-l}); L_{P'}(\blacktriangleright_U \oplus \uparrow_{UP'} \oplus \delta_{P',U,P'}^l; (\uparrow_{P'U} \oplus \blacktriangleright_{P'})) \tag{W2, Def. \blacktriangleright} \\
 &= RU_{\oplus P'}(\downarrow_{P'U} \oplus \blacktriangleleft_{P'}); RU_{\oplus P'}(\delta_{P',U,P'}^{-l}); \tag{W5} \\
 &\quad \delta_{P',U(U \oplus P'),P'(U \oplus P')}^l; (L_{P'}(\blacktriangleright_U \oplus \uparrow_{UP'}) \oplus L_{P'}(\delta_{P',U,P'}^l; (\uparrow_{P'U} \oplus \blacktriangleright_{P'}))); \delta_{P',U,P'}^{-l} \\
 &= RU_{\oplus P'}(\downarrow_{P'U} \oplus \blacktriangleleft_{P'}); RU_{\oplus P'}(\delta_{P',U,P'}^{-l}); \tag{W16} \\
 &\quad RU_{\oplus P'}(\delta_{P',U,P'}^l; (L_{P'}(\blacktriangleright_U \oplus \uparrow_{UP'}) \oplus L_{P'}(\delta_{P',U,P'}^l; (\uparrow_{P'U} \oplus \blacktriangleright_{P'}))); \delta_{P',U,P'}^{-l} \\
 &= RU_{\oplus P'}(\downarrow_{P'U} \oplus \blacktriangleleft_{P'}); (L_{P'}(\blacktriangleright_U \oplus \uparrow_{UP'}) \oplus L_{P'}(\delta_{P',U,P'}^l; (\uparrow_{P'U} \oplus \blacktriangleright_{P'}))); \delta_{P',U,P'}^{-l} \tag{Iso} \\
 &= (RU_{\oplus P'}(\downarrow_{P'U}) \oplus RU_{\oplus P'}(\blacktriangleleft_{P'})); (L_{P'}(\blacktriangleright_U \oplus \uparrow_{UP'}) \oplus L_{P'}(\delta_{P',U,P'}^l; (\uparrow_{P'U} \oplus \blacktriangleright_{P'}))); \delta_{P',U,P'}^{-l} \tag{W5} \\
 &= (\downarrow_{P'U}(U \oplus P') \oplus RU_{\oplus P'}(\blacktriangleleft_{P'})); (L_{P'}(\blacktriangleright_U \oplus \uparrow_{UP'}) \oplus L_{P'}(\delta_{P',U,P'}^l; (\uparrow_{P'U} \oplus \blacktriangleright_{P'}))); \delta_{P',U,P'}^{-l} \tag{W9} \\
 &= ((\downarrow_{P'U}(U \oplus P'); L_{P'}(\blacktriangleright_U \oplus \uparrow_{UP'})) \oplus (RU_{\oplus P'}(\blacktriangleleft_{P'}); L_{P'}(\delta_{P',U,P'}^l; (\uparrow_{P'U} \oplus \blacktriangleright_{P'}))))); \delta_{P',U,P'}^{-l} \tag{Funct. \oplus} \\
 &= (\downarrow_{P'U} \oplus (RU_{\oplus P'}(\blacktriangleleft_{P'}); L_{P'}(\delta_{P',U,P'}^l; (\uparrow_{P'U} \oplus \blacktriangleright_{P'}))))); \delta_{P',U,P'}^{-l} \tag{\downarrow-nat} \\
 &= (\downarrow_{P'U} \oplus (\delta_{P',U,P'}^l; (RU(\blacktriangleleft_{P'}) \oplus R_{P'}(\blacktriangleleft_{P'})); \delta_{P',U,P'}^{-l}; L_{P'}(\delta_{P',U,P'}^l; (\uparrow_{P'U} \oplus \blacktriangleright_{P'}))))); \delta_{P',U,P'}^{-l} \tag{W6} \\
 &= (\downarrow_{P'U} \oplus (\delta_{P',U,P'}^l; (RU(\blacktriangleleft_{P'}) \oplus R_{P'}(\blacktriangleleft_{P'})); \delta_{P',U,P'}^{-l}; L_{P'}(\delta_{P',U,P'}^l; (\uparrow_{P'U} \oplus \blacktriangleright_{P'}))))); \delta_{P',U,P'}^{-l} \tag{W17} \\
 &\quad \delta_{P',P',U,P'}^l; \delta_{P',UP',P',P'}^{-l}; L_{P'}((\uparrow_{P'U} \oplus \blacktriangleright_{P'}))); \delta_{P',U,P'}^{-l} \\
 &= (\downarrow_{P'U} \oplus (\delta_{P',U,P'}^l; (RU(\blacktriangleleft_{P'}) \oplus R_{P'}(\blacktriangleleft_{P'})); \delta_{P',UP',P',P'}^{-l}; L_{P'}((\uparrow_{P'U} \oplus \blacktriangleright_{P'}))))); \delta_{P',U,P'}^{-l} \tag{Iso} \\
 &= (\downarrow_{P'U} \oplus (\delta_{P',U,P'}^l; (RU(\blacktriangleleft_{P'}) \oplus R_{P'}(\blacktriangleleft_{P'})); (L_{P'}(\uparrow_{P'U}) \oplus L_{P'}(\blacktriangleright_{P'})))); \delta_{P',U,P'}^{-l} \tag{W5} \\
 &= (\downarrow_{P'U} \oplus (\delta_{P',U,P'}^l; ((RU(\blacktriangleleft_{P'}); L_{P'}(\uparrow_{P'U})) \oplus (R_{P'}(\blacktriangleleft_{P'}); L_{P'}(\blacktriangleright_{P'}))))); \delta_{P',U,P'}^{-l} \tag{Funct. \oplus}
 \end{aligned}$$

$$\begin{aligned}
 &= (\flat_{P'U} \oplus (\delta_{P',U,P'}^l; ((R_U(\blacktriangleleft_{P'}); \mathring{\Upsilon}_{P'P'U}) \oplus (R_{P'}(\blacktriangleleft_{P'}); L_{P'}(\blacktriangleright_{P'})))); \delta_{P',U,P'}^{-l}) && \text{(W9)} \\
 &= (\flat_{P'U} \oplus (\delta_{P',U,P'}^l; (\mathring{\Upsilon}_{P'U} \oplus (R_{P'}(\blacktriangleleft_{P'}); L_{P'}(\blacktriangleright_{P'})))); \delta_{P',U,P'}^{-l}) && \text{(\mathring{\Upsilon}-nat)} \\
 &= (\flat_{P'U} \oplus (\delta_{P',U,P'}^l; (\mathring{\Upsilon}_{P'U} \oplus (\blacktriangleright_{P'}; \blacktriangleleft_{P'})))); \delta_{P',U,P'}^{-l} && \text{(Ind. hp.)} \\
 &= \delta_{P',U,P'}^l; (\mathring{\Upsilon}_{P'U} \oplus \blacktriangleright_{P'}); (\flat_{P'U} \oplus \blacktriangleleft_{P'}); \delta_{P',U,P'}^{-l} && \text{(Funct. } \oplus \text{)}
 \end{aligned}$$

We conclude the proof by showing that

$$\begin{aligned}
 &R_{U \oplus P'}(\blacktriangleleft_{U \oplus P'}); L_{U \oplus P'}(\blacktriangleright_{U \oplus P'}) \\
 &= R_{U \oplus P'}(\blacktriangleleft_U \oplus \flat_{UP'} \oplus (\flat_{P'U} \oplus \blacktriangleleft_{P'}); \delta_{P',U,P'}^{-l}); L_{U \oplus P'}(\blacktriangleright_{U \oplus P'}) && \text{(Def. } \blacktriangleleft \text{)} \\
 &= (R_{U \oplus P'}(\blacktriangleleft_U \oplus \flat_{UP'}) \oplus R_{U \oplus P'}((\flat_{P'U} \oplus \blacktriangleleft_{P'}); \delta_{P',U,P'}^{-l})); (L_U(\blacktriangleright_{U \oplus P'}) \oplus L_{P'}(\blacktriangleright_{U \oplus P'})) && \text{(W5, W6)} \\
 &= (R_{U \oplus P'}(\blacktriangleleft_U \oplus \flat_{UP'}); L_U(\blacktriangleright_{U \oplus P'})) \oplus (R_{U \oplus P'}((\flat_{P'U} \oplus \blacktriangleleft_{P'}); \delta_{P',U,P'}^{-l}); L_{P'}(\blacktriangleright_{U \oplus P'})) && \text{(Funct. } \oplus \text{)} \\
 &= (\blacktriangleright_U; \blacktriangleleft_U) \oplus (\mathring{\Upsilon}_{UP'}; \flat_{UP'}) \oplus (\delta_{P',U,P'}^l; (\mathring{\Upsilon}_{P'U} \oplus \blacktriangleright_{P'}); (\flat_{P'U} \oplus \blacktriangleleft_{P'}); \delta_{P',U,P'}^{-l}) && \text{(*}_1, *_2 \text{)} \\
 &= (\blacktriangleright_U \oplus \mathring{\Upsilon}_{UP'} \oplus \delta_{P',U,P'}^l; (\mathring{\Upsilon}_{P'U} \oplus \blacktriangleleft_{P'})); (\blacktriangleleft_U \oplus \flat_{UP'} \oplus (\flat_{P'U} \oplus \blacktriangleleft_{P'}); \delta_{P',U,P'}^{-l}) && \text{(Funct. } \oplus \text{)} \\
 &\Rightarrow \blacktriangleright_{U \oplus P'}; \blacktriangleleft_{U \oplus P'} && \text{(Def. } \blacktriangleright, \blacktriangleleft \text{)}
 \end{aligned}$$

as required. \square

Lemma G.6 (Lax comonoid homomorphisms). *The following hold for any $t: P \rightarrow Q$*

$$t; !_Q \leq !_P \quad t; \blacktriangleleft_Q \leq \blacktriangleleft_P; (t \otimes t)$$

PROOF.

EQUATION $t; !_Q \leq !_P$: by induction on t .

Case $t = id_0$: $id_0; !_0 \stackrel{(\text{def. } !)}{=} id_0; \flat_1 = \flat_1 \stackrel{(\text{def. } !)}{=} !_0$

Case $t = \overline{c}$: Suppose $c: U \rightarrow V$, then $\overline{c}; !_V \stackrel{(\text{def. } !)}{=} U \xrightarrow{\overline{c}} V \stackrel{(!\text{-nat})}{\leq} !_U \stackrel{(\text{def. } !)}{=} !_U$

Case $t = \sigma_{U,V}^{\oplus}$:

$$\sigma_{U,V}^{\oplus}; !_{V \oplus U} \stackrel{(\text{def. } !)}{=} U \begin{array}{c} \text{X} \\ \text{V} \end{array} \xrightarrow{(\sigma^{\oplus}\text{-nat})} U \begin{array}{c} \text{X} \\ \text{V} \end{array} \xrightarrow{(\blacktriangleright\text{-co})} U \begin{array}{c} \text{X} \\ \text{V} \end{array} \stackrel{(\text{def. } !)}{=} !_{U \oplus V}$$

Case $t = \blacktriangleleft_U$: (similarly for \blacktriangleright_U)

$$\blacktriangleleft_U; !_{U \oplus U} \stackrel{(\text{def. } !)}{=} U \begin{array}{c} \text{X} \\ \text{U} \end{array} \xrightarrow{(\blacktriangleleft\text{-nat})} U \begin{array}{c} \text{X} \\ \text{U} \end{array} \stackrel{(\blacktriangleleft\text{-})}{\leq} !_U$$

Case $t = \mathring{\Upsilon}_U$: (similarly for \flat_U) $U \xrightarrow{\mathring{\Upsilon}} U \stackrel{(\mathring{\Upsilon}\text{-nat})}{=} U \xrightarrow{\mathring{\Upsilon}} U \stackrel{(\mathring{\Upsilon}\text{-})}{\leq} !_U$

Case $t = t_1; t_2$: Suppose $t_1: P \rightarrow Q, t_2: Q \rightarrow R$, then

$$t_1; t_2; !_R \stackrel{(\text{ind. hp.})}{\leq} t_1; !_Q \stackrel{(\text{ind. hp.})}{\leq} !_P$$

Case $t = t_1 \oplus t_2$: Suppose $t_1: P_1 \rightarrow Q_1, t_2: P_2 \rightarrow Q_2$, then

$$\begin{aligned}
 (t_1 \oplus t_2); !_{Q_1 \oplus Q_2} &\stackrel{(\text{Lemma G.2})}{=} (t_1 \oplus t_2); (!_{Q_1} \oplus !_{Q_2}); \blacktriangleright_1 \stackrel{(\text{funct. } \oplus)}{=} ((t_1; !_{Q_1}) \oplus (t_2; !_{Q_2})); \blacktriangleright_1 \\
 &\stackrel{(\text{ind. hp.})}{\leq} (!_{P_1} \oplus !_{P_2}); \blacktriangleright_1 \stackrel{(\text{Lemma G.2})}{=} !_{P_1 \oplus P_2}
 \end{aligned}$$

EQUATION $t; \blacktriangleleft_Q \leq \blacktriangleleft_P; (t \otimes t)$: by induction on t .

Case $t = id_0$: $id_0; \blacktriangleleft_0 \stackrel{(\text{def. } \blacktriangleleft)}{=} id_0; id_0 \stackrel{(\text{def. } \blacktriangleleft)}{=} \blacktriangleleft_0; id_0 = \blacktriangleleft_0; (id_0 \otimes id_0)$

Case $t = \overline{c}$: Suppose $c: U \rightarrow V$, then

$$\overline{c}; \blacktriangleleft_V \stackrel{(\text{def. } \blacktriangleleft)}{=} U \text{ } \boxed{\blacktriangleleft_V} \text{ } V \stackrel{(\blacktriangleleft\text{-nat})}{\leq} U \text{ } \boxed{\blacktriangleleft_V} \text{ } V \stackrel{(\text{def. } \blacktriangleleft)}{=} \blacktriangleleft_U; (\overline{c} \otimes \overline{c})$$

Case $t = \sigma_{U,V}^{\oplus}$:

$$\blacktriangleleft_{U \oplus V}; (\sigma_{U,V}^{\oplus} \otimes \sigma_{U,V}^{\oplus}) = \text{Diagram} \stackrel{(\sigma^{\oplus}\text{-nat})}{=} \text{Diagram} \stackrel{(\text{def. } \blacktriangleleft)}{=} \sigma_{U,V}^{\oplus}; \blacktriangleleft_{V \oplus U}$$

Case $t = \blacktriangleleft_U$: (similarly for \blacktriangleright_U)

$$\begin{aligned} \blacktriangleleft_U; \blacktriangleleft_{U \oplus U} &\stackrel{(\text{def. } \blacktriangleleft)}{=} \text{Diagram} \stackrel{(\blacktriangleleft\text{-nat})}{=} \text{Diagram} \stackrel{(\blacktriangleleft\text{-un})}{=} \text{Diagram} \\ &\stackrel{(\hat{\imath}\blacktriangleleft)}{\leq} \text{Diagram} \stackrel{(\text{def. } \blacktriangleleft)}{=} \blacktriangleleft_U; (\blacktriangleleft_U \otimes \blacktriangleleft_U) \end{aligned}$$

Case $t = \hat{\imath}_U$: (similarly for \blacktriangleleft_U)

$$\hat{\imath}_U; \blacktriangleleft_0 \stackrel{(\text{def. } \blacktriangleleft)}{=} \hat{\imath}_U; id_0 = \hat{\imath}_U \stackrel{(\hat{\imath}\text{-nat})}{=} \blacktriangleleft_U; \hat{\imath}_{UU}$$

Case $t = t_1; t_2$: Suppose $t_1: P \rightarrow Q, t_2: Q \rightarrow R$, then

$$t_1; t_2; \blacktriangleleft_R \stackrel{(\text{ind. hp.})}{\leq} t_1; \blacktriangleleft_Q; (t_2 \otimes t_2) \stackrel{(\text{ind. hp.})}{\leq} \blacktriangleleft_P; (t_1 \otimes t_1); (t_2 \otimes t_2) \stackrel{(\text{funct. } \otimes)}{=} \blacktriangleleft_P; ((t_1; t_2) \otimes (t_1; t_2))$$

Case $t = t_1 \oplus t_2$: Suppose $t_1: P_1 \rightarrow Q_1, t_2: P_2 \rightarrow Q_2$, then

$$\begin{aligned} &\blacktriangleleft_{P_1 \oplus P_2}; ((t_1 \oplus t_2) \otimes (t_1 \oplus t_2)) \\ &= \blacktriangleleft_{P_1 \oplus P_2}; \delta_{P_1 \oplus P_2, P_1, P_2}^l; (((t_1 \oplus t_2) \otimes t_1) \oplus ((t_1 \oplus t_2) \otimes t_2)); \delta_{Q_1 \oplus Q_2, Q_1, Q_2}^{-l} \quad (\text{Nat. } \delta^l) \\ &= \blacktriangleleft_{P_1 \oplus P_2}; \delta_{P_1 \oplus P_2, P_1, P_2}^l; (t_1 t_1 \oplus t_2 t_1 \oplus t_1 t_2 \oplus t_2 t_2); \delta_{Q_1 \oplus Q_2, Q_1, Q_2}^{-l} \quad (\text{Theorem 5.10}) \\ &= ((\blacktriangleleft_{P_1} \oplus \blacktriangleleft_{P_1 P_2}); \delta_{P_1, P_1, P_2}^{-l} \oplus (\blacktriangleleft_{P_2 P_1} \oplus \blacktriangleleft_{P_2}); \delta_{P_2, P_1, P_2}^{-l}); \delta_{P_1 \oplus P_2, P_1, P_2}^l; (t_1 t_1 \oplus t_2 t_1 \oplus t_1 t_2 \oplus t_2 t_2); \delta_{Q_1 \oplus Q_2, Q_1, Q_2}^{-l} \\ &\quad (\text{Lemma G.1}) \\ &= (\blacktriangleleft_{P_1} \oplus \blacktriangleleft_{P_1 P_2} \oplus \blacktriangleleft_{P_2 P_1} \oplus \blacktriangleleft_{P_2}); (\delta_{P_1, P_1, P_2}^{-l} \oplus \delta_{P_2, P_1, P_2}^{-l}); \delta_{P_1 \oplus P_2, P_1, P_2}^l; (t_1 t_1 \oplus t_2 t_1 \oplus t_1 t_2 \oplus t_2 t_2); \delta_{Q_1 \oplus Q_2, Q_1, Q_2}^{-l} \\ &\quad (\text{Funct. } \oplus) \\ &= (\blacktriangleleft_{P_1} \oplus \blacktriangleleft_{P_1 P_2} \oplus \blacktriangleleft_{P_2 P_1} \oplus \blacktriangleleft_{P_2}); (id_{P_1 P_1} \oplus \sigma_{P_1 P_2, P_2 P_1}^{\oplus} \oplus id_{P_2 P_2}); (t_1 t_1 \oplus t_2 t_1 \oplus t_1 t_2 \oplus t_2 t_2); \delta_{Q_1 \oplus Q_2, Q_1, Q_2}^{-l} \\ &\quad (\text{Lemma E.1.2}) \\ &= (\blacktriangleleft_{P_1} \oplus \blacktriangleleft_{P_1 P_2} \oplus \blacktriangleleft_{P_2 P_1} \oplus \blacktriangleleft_{P_2}); (t_1 t_1 \oplus t_1 t_2 \oplus t_2 t_1 \oplus t_2 t_2); (id_{Q_1 Q_1} \oplus \sigma_{Q_1 Q_2, Q_2 Q_1}^{\oplus} \oplus id_{Q_2 Q_2}); \delta_{Q_1 \oplus Q_2, Q_1, Q_2}^{-l} \\ &\quad (\sigma^{\oplus}\text{-nat}) \\ &= (\blacktriangleleft_{P_1}; t_1 t_1 \oplus \blacktriangleleft_{P_1 P_2}; t_1 t_2 \oplus \blacktriangleleft_{P_2 P_1}; t_2 t_1 \oplus \blacktriangleleft_{P_2}; t_2 t_2); (id_{Q_1 Q_1} \oplus \sigma_{Q_1 Q_2, Q_2 Q_1}^{\oplus} \oplus id_{Q_2 Q_2}); \delta_{Q_1 \oplus Q_2, Q_1, Q_2}^{-l} \\ &\quad (\text{Funct. } \oplus) \end{aligned}$$

$$\begin{aligned}
 &= (\blacktriangleleft_{P_1}; \mathbf{t}_1 \mathbf{t}_1 \oplus \flat_{Q_1 Q_2} \oplus \flat_{Q_2 Q_1} \oplus \blacktriangleleft_{P_2}; \mathbf{t}_2 \mathbf{t}_2); (id_{Q_1 Q_1} \oplus \sigma_{Q_1 Q_2, Q_2 Q_1}^{\oplus} \oplus id_{Q_2 Q_2}); \delta_{Q_1 \oplus Q_2, Q_1, Q_2}^{-l} && (\flat\text{-nat}) \\
 &\geq (\mathbf{t}_1; \blacktriangleleft_{Q_1} \oplus \flat_{Q_1 Q_2} \oplus \flat_{Q_2 Q_1} \oplus \mathbf{t}_2; \blacktriangleleft_{Q_2}); (id_{Q_1 Q_1} \oplus \sigma_{Q_1 Q_2, Q_2 Q_1}^{\oplus} \oplus id_{Q_2 Q_2}); \delta_{Q_1 \oplus Q_2, Q_1, Q_2}^{-l} && (\text{Ind. hp.}) \\
 &= (\mathbf{t}_1; \blacktriangleleft_{Q_1} \oplus \flat_{Q_1 Q_2} \oplus \flat_{Q_2 Q_1} \oplus \mathbf{t}_2; \blacktriangleleft_{Q_2}); (\delta_{Q_1, Q_1, Q_2}^{-l} \oplus \delta_{Q_2, Q_1, Q_2}^{-l}) && (\text{Lemma E.1.2}) \\
 &= (\mathbf{t}_1 \oplus \mathbf{t}_2); (\blacktriangleleft_{Q_1} \oplus \flat_{Q_1 Q_2} \oplus \flat_{Q_2 Q_1} \oplus \blacktriangleleft_{Q_2}); (\delta_{Q_1, Q_1, Q_2}^{-l} \oplus \delta_{Q_2, Q_1, Q_2}^{-l}) && (\text{Funct. } \oplus) \\
 &= (\mathbf{t}_1 \oplus \mathbf{t}_2); ((\blacktriangleleft_{Q_1} \oplus \flat_{Q_1 Q_2}); \delta_{Q_1, Q_1, Q_2}^{-l} \oplus (\flat_{Q_2 Q_1} \oplus \blacktriangleleft_{Q_2}); \delta_{Q_2, Q_1, Q_2}^{-l}) && (\text{Funct. } \oplus) \\
 &= (\mathbf{t}_1 \oplus \mathbf{t}_2); \blacktriangleleft_{Q_1 \oplus Q_2} && (\text{Def. } \blacktriangleleft)
 \end{aligned}$$

as required. \square

G.2 Proofs of Proposition 7.4

We start by showing that an arbitrary morphism of strict cartesian bicategories $\mathcal{M}: \mathbf{CB}_{\Sigma} \rightarrow \mathbf{Rel}$ can be extended to a morphism of sesquistrict fb-cb rig categories $\mathcal{M}^{\sharp}: \mathbf{T}_{\mathbf{CB}_{\Sigma}} \rightarrow \mathbf{Rel}$.

Lemma G.7. *Let $\mathcal{M}: \mathbf{CB}_{\Sigma} \rightarrow \mathbf{Rel}$ be a morphism of cartesian bicategories. There exists a morphism of sesquistrict fb-cb rig categories $\mathcal{M}^{\sharp}: \mathbf{T}_{\mathbf{CB}_{\Sigma}} \rightarrow \mathbf{Rel}$ such that $\mathcal{M}^{\sharp}(\overline{c}) = \mathcal{M}(c)$ for all $c \in \mathbf{CB}_{\Sigma}$.*

PROOF. Recall our convention following Lemma 4.6: we assume that $\mathcal{M}: \mathbf{CB}_{\Sigma} \rightarrow \overline{\mathbf{Rel}}$. We define $\mathcal{M}^{\sharp}: \mathbf{T}_{\mathbf{CB}_{\Sigma}} \rightarrow \overline{\mathbf{Rel}}$ as follows. On objects, $\mathcal{M}^{\sharp}(0) = 0$, $\mathcal{M}^{\sharp}(U \oplus P) = \mathcal{M}(U) \oplus \mathcal{M}^{\sharp}(P)$. On morphisms:

$$\begin{aligned}
 \mathcal{M}^{\sharp}(id_U) &= id_{\mathcal{M}(U)} & \mathcal{M}^{\sharp}(id_0) &= id_0 & \mathcal{M}^{\sharp}(\overline{c}) &= \mathcal{M}(c) & \mathcal{M}^{\sharp}(\sigma_{U, U'}^{\oplus}) &= \sigma_{\mathcal{M}(U), \mathcal{M}(U')}^{\oplus} \\
 \mathcal{M}^{\sharp}(\triangleright_U) &= \triangleright_{\mathcal{M}(U)} & \mathcal{M}^{\sharp}(\flat_U) &= \flat_{\mathcal{M}(U)} & \mathcal{M}^{\sharp}(\blacktriangleleft_U) &= \blacktriangleleft_{\mathcal{M}(U)} & \mathcal{M}^{\sharp}(\mathring{U}) &= \mathring{U}_{\mathcal{M}(U)} \\
 \mathcal{M}^{\sharp}(\mathfrak{s}; \mathfrak{t}) &= \mathcal{M}^{\sharp}(\mathfrak{s}); \mathcal{M}^{\sharp}(\mathfrak{t}) & \mathcal{M}^{\sharp}(\mathfrak{s} \oplus \mathfrak{t}) &= \mathcal{M}^{\sharp}(\mathfrak{s}) \oplus \mathcal{M}^{\sharp}(\mathfrak{t})
 \end{aligned}$$

By definition \mathcal{M}^{\sharp} is an fb-morphism. Preservation of the rest of the rig structure follows from the inductive definitions of $\delta_{P, Q, R}^l$, σ^{\oplus} and \otimes , which all use the \oplus -structure and the internal tensor of \mathbf{C}_{Σ} , that are indeed preserved by \mathcal{M}^{\sharp} . The proof is similar to that of Theorem 5.11, in Appendix E. Hence \mathcal{M}^{\sharp} is a sesquistrict fb rig functor.

One can check that \mathcal{M}^{\sharp} preserves the cartesian bicategory structure of $\mathbf{T}_{\mathbf{CB}_{\Sigma}}$ by induction, knowing that it preserves \mathring{U} , \flat , δ^l and \oplus and using the coherence axioms of Definition 7.1.4. \square

PROOF OF PROPOSITION 7.4. Recall our convention following Lemma 4.6: in the statement we are more precisely interested in morphisms of cartesian bicategories $\mathbf{CB}_{\Sigma} \rightarrow \overline{\mathbf{Rel}}$ and of sesquistrict fb-cb rig categories $\mathbf{T}_{\mathbf{CB}_{\Sigma}} \rightarrow \overline{\mathbf{Rel}}$. Table 6 provides the recipe for the direction (1) \rightarrow (2). Lemma G.7 takes care of (2) \rightarrow (3). For (3) \rightarrow (1), consider $F: \mathbf{T}_{\mathbf{CB}_{\Sigma}} \rightarrow \overline{\mathbf{Rel}}$ a sesquistrict fb-cb rig functor. Then F induces an interpretation $\mathcal{I}_F = (\alpha_{\mathcal{S}}, \alpha_{\Sigma})$ given by

$$\begin{array}{ccc}
 \mathcal{S} & \xrightarrow{\alpha_{\mathcal{S}}} & Ob(\mathbf{Rel}) & \quad & \Sigma & \xrightarrow{\alpha_{\Sigma}} & Ar(\mathbf{Rel}) \\
 A & \longmapsto & F(A) & \quad & f & \longmapsto & F(\overline{f})
 \end{array}$$

We show that \mathcal{I}_F is actually an interpretation. First of all, notice that since F is sesquistrict it sends elements of \mathcal{S} into objects of \mathbf{Rel} , seen as unary words of unary words in $\overline{\mathbf{Rel}}$, so $\alpha_{\mathcal{S}}$ type-checks. Next, suppose $ar(f) = U$ with $U = A_1 \dots A_n$, then the domain of $\alpha_{\Sigma}(f) = F(\overline{f})$ in \mathbf{Rel} is the unary word consisting of the word $F(U)$, where $F(U) = F(A_1) \dots F(A_n)$ because F is strict. By definition

of $\overline{\mathbf{Rel}}$, we have that $F(\overline{f})$ is an actual arrow of \mathbf{Rel} whose domain (in \mathbf{Rel}) is the right-bracketing of the set $F(A_1) \otimes \dots \otimes F(A_n)$, which is indeed $\alpha_S^\#(A_1 \dots A_n)$.

It is very easy to see that the functions (1) \rightarrow (2) \rightarrow (3) are injective, while (3) \rightarrow (1) is also injective because F is completely determined by its action on \mathcal{S} and Σ , hence we conclude. \square

G.3 Proofs of Theorem 7.5 (Completeness)

We prove in detail the five points listed in the proof of Theorem 7.5 in the main text. We recall first the following result from [14].

Lemma G.8 (From [14]). *For all $c \in \mathbf{CB}_\Sigma[U, V]$, there exist a morphism $\mathcal{U}_c: \mathbf{CB}_\Sigma \rightarrow \mathbf{Rel}$ and an element $(\iota, \omega) \in \mathcal{U}_c(c)$ such that for all $d \in \mathbf{CB}_\Sigma[U, V]$, if $(\iota, \omega) \in \mathcal{U}_c(d)$ then $c \leq_{\mathbf{CB}_\Sigma} d$.*

The following five results are the points listed in the proof in the main text.

Lemma G.9. *For all morphisms $\mathcal{M}: \mathbf{T}_{\mathbf{CB}_\Sigma} \rightarrow \mathbf{Rel}$ and $c, d \in \mathbf{CB}_\Sigma[U, V]$, $\mathcal{M}(\overline{c} + \overline{d}) = \mathcal{M}(\overline{c}) \cup \mathcal{M}(\overline{d})$.*

PROOF.

$$\begin{aligned}
 \mathcal{M}(\overline{c} + \overline{d}) &= \mathcal{M}(\triangleleft_U; (\overline{c} \oplus \overline{d}); \triangleright_V) && \text{(def. +)} \\
 &= \mathcal{M}(\triangleleft_U); (\mathcal{M}(\overline{c}) \oplus \mathcal{M}(\overline{d})); \mathcal{M}(\triangleright_V) && \text{(funct } \mathcal{M}) \\
 &= \triangleleft_{\mathcal{M}U}; (\mathcal{M}(\overline{c}) \oplus \mathcal{M}(\overline{d})); \triangleright_{\mathcal{M}V} && \text{(M fb-morphism)} \\
 &= \mathcal{M}(\overline{c}) \cup \mathcal{M}(\overline{d}) && \text{(Def. } \triangleleft_U \triangleright_V \text{ in Rel)}
 \end{aligned}$$

\square

Lemma G.10. *Let $c, d_1, \dots, d_m \in \mathbf{CB}_\Sigma[U, V]$. If for all $\mathcal{M}: \mathbf{T}_{\mathbf{CB}_\Sigma} \rightarrow \mathbf{Rel}$, $\mathcal{M}(\overline{c}) \leq \mathcal{M}(\sum_{j=1}^m \overline{d_j})$, then there exists a j such that $c \leq_{\mathbf{CB}_\Sigma} d_j$.*

PROOF. Let $\mathcal{U}_c: \mathbf{CB}_\Sigma \rightarrow \mathbf{Rel}$ be the morphism from Lemma G.8 and $\mathcal{U}_c^\#: \mathbf{T}_{\mathbf{CB}_\Sigma} \rightarrow \mathbf{Rel}$ its extension to $\mathbf{T}_{\mathbf{CB}_\Sigma}$ (Lemma G.7). By assumption, we have that $\mathcal{U}_c^\#(\overline{c}) \leq \mathcal{U}_c^\#(\sum_{j=1}^m \overline{d_j})$. By Lemma G.9 this holds iff $\mathcal{U}_c(c) \leq \bigcup_{j=1}^m \mathcal{U}_c(d_j)$. Therefore, the element $(\iota, \omega) \in \mathcal{U}_c(c)$ from Lemma G.8 should belong to at least one $\mathcal{U}_c(d_j)$. By Lemma G.8, $c \leq_{\mathbf{CB}_\Sigma} d_j$ follows immediately. \square

Lemma G.11. *Let $c_1, \dots, c_n, d_1, \dots, d_m \in \mathbf{CB}_\Sigma[U, V]$. If for all $\mathcal{M}: \mathbf{T}_{\mathbf{CB}_\Sigma} \rightarrow \mathbf{Rel}$, $\mathcal{M}(\sum_{i=1}^n \overline{c_i}) \leq \mathcal{M}(\sum_{j=1}^m \overline{d_j})$, then for all i , there exists a j such that $c_i \leq_{\mathbf{CB}_\Sigma} d_j$.*

PROOF. By the hypothesis and Lemma G.9, one has that $\bigcup_{i=1}^n \mathcal{M}(\overline{c_i}) \leq \mathcal{M}(\sum_{j=1}^m \overline{d_j})$. Thus for all i , $\mathcal{M}(\overline{c_i}) \leq \mathcal{M}(\sum_{j=1}^m \overline{d_j})$ that, by Lemma G.10, entails that there exists a j such that $c_i \leq_{\mathbf{CB}_\Sigma} d_j$. \square

From the above result and Corollary 6.10, it follows immediately that:

Corollary G.12. *Let $\mathfrak{s}, \mathfrak{t}$ be arrows in \mathbf{Mnm} . If, for all morphisms of fb-cb categories $\mathcal{M}: \mathbf{T}_{\mathbf{CB}_\Sigma} \rightarrow \mathbf{Rel}$, $\mathcal{M}(\mathfrak{s}) \leq \mathcal{M}(\mathfrak{t})$, then $\mathfrak{s} \leq_T \mathfrak{t}$.*

To conclude we only need the following lemma which holds for arbitrary fb-categories.

Lemma G.13. *Let \mathbf{C} be a fb category monoidally enriched over a preorder \leq . Let $f, g: \bigoplus_{i=1}^n A_i \rightarrow \bigoplus_{j=1}^m B_j$ be arrows in \mathbf{C} . Let f_{ji} and g_{ji} be, respectively, $\mu_i; f; \pi_j$ and $\mu_i; g; \pi_j$. Then $f \leq g$ iff $f_{ji} \leq g_{ji}$ for all i, j .*

PROOF. Since composition is monotone, one has immediately that $f \leq g$ implies $f_{ji} \leq g_{ji}$. Vice versa, suppose that $f_{ji} \leq g_{ji}$ for all j, i . It is not difficult to verify that

$$f = \left(\bigoplus_{i=1}^n A_i \xrightarrow{\bigoplus_{i=1}^n \llcorner_{A_i}^m} \bigoplus_{i=1}^n \bigoplus_{j=1}^m A_i \xrightarrow{\bigoplus_{i=1}^n \bigoplus_{j=1}^m f_{ji}} \bigoplus_{i=1}^n \bigoplus_{j=1}^m B_j \xrightarrow{\triangleright_{\bigoplus_{j=1}^m B_j}^n} \bigoplus_{j=1}^m B_j \right)$$

and similarly for g . Then again because of the monotonicity of composition, we have $f \leq g$. \square

G.4 Other proofs of Section 7

PROOF OF PROPOSITION 7.7. Recall from Example 3.3 that for an interpretation $\mathcal{I} = (\alpha_S, \alpha_\Sigma)$, we set $\alpha_S(A) = X$ and, for all $R \in \Sigma$, $\alpha_\Sigma(R) = \rho(R)$. The proof is by induction on E . The base cases are trivial. For the inductive cases, we only illustrate the one for $E = E_1 \cap E_2$, as the remaining ones are simpler.

$$\begin{aligned} \llbracket \mathcal{E}(E_1 \cap E_2) \rrbracket_{\mathcal{I}}^{\#} &= \llbracket \overline{\llcorner_A}; (\mathcal{E}(E_1) \times \mathcal{E}(E_2)); \overline{\triangleright_A} \rrbracket_{\mathcal{I}}^{\#} && \text{(def. } \mathcal{E}(-) \text{)} \\ &= \llbracket \overline{\llcorner_A} \rrbracket_{\mathcal{I}}^{\#}; (\llbracket \mathcal{E}(E_1) \rrbracket_{\mathcal{I}}^{\#} \otimes \llbracket \mathcal{E}(E_2) \rrbracket_{\mathcal{I}}^{\#}); \llbracket \overline{\triangleright_A} \rrbracket_{\mathcal{I}}^{\#} && \text{(funct. } \llbracket - \rrbracket^{\#} \text{)} \\ &= \llcorner_X; (\llbracket \mathcal{E}(E_1) \rrbracket_{\mathcal{I}}^{\#} \otimes \llbracket \mathcal{E}(E_2) \rrbracket_{\mathcal{I}}^{\#}); \triangleright_X && \text{(} \mathcal{M} \text{ cb-morphism)} \\ &= \llcorner_X; (\llbracket \langle E_1 \rangle \rrbracket_{\mathcal{I}} \otimes \llbracket \langle E_2 \rangle \rrbracket_{\mathcal{I}}); \triangleright_X && \text{(ind. hyp.)} \\ &= \llbracket \langle E_1 \rangle \rrbracket_{\mathcal{I}} \cap \llbracket \langle E_2 \rangle \rrbracket_{\mathcal{I}} && \text{(Def. } \llcorner_X, \triangleright_X \text{ in Rel)} \\ &= \llbracket \langle E_1 \cap E_2 \rangle \rrbracket_{\mathcal{I}} && \text{(Def. } \llbracket - \rrbracket_{\mathcal{I}} \text{)} \end{aligned}$$

\square

PROOF OF COROLLARY 7.8.

$$\begin{aligned} E_1 \leq_{\text{CR}} E_2 &\iff \forall \mathcal{I}. \llbracket \langle E_1 \rangle \rrbracket_{\mathcal{I}} \leq \llbracket \langle E_2 \rangle \rrbracket_{\mathcal{I}} && \text{(def. } \leq_{\text{CR}} \text{)} \\ &\iff \forall \mathcal{I}. \llbracket \mathcal{E}(E_1) \rrbracket_{\mathcal{I}}^{\#} \leq \llbracket \mathcal{E}(E_2) \rrbracket_{\mathcal{I}}^{\#} && \text{(Proposition 7.7)} \\ &\iff \forall \mathcal{M}. \mathcal{M}(\mathcal{E}(E_1)) \leq \mathcal{M}(\mathcal{E}(E_2)) && \text{(Proposition 7.4)} \\ &\iff \mathcal{E}(E_1) \leq_T \mathcal{E}(E_2) && \text{(Theorem 7.5)} \end{aligned}$$

\square