

The First-Order Theory of Binary Overlap-Free Words is Decidable

Luke Schaeffer
 Institute for Quantum Computing (IQC)
 University of Waterloo
 Waterloo, ON N2L 3G1
 Canada
lrschaeffer@gmail.com

Jeffrey Shallit
 School of Computer Science
 University of Waterloo
 Waterloo, ON N2L 3G1
 Canada
shallit@uwaterloo.ca

September 8, 2022

Abstract

We show that the first-order logical theory of the binary overlap-free words (and, more generally, the α -free words for rational α , $2 < \alpha \leq 7/3$), is decidable. As a consequence, many results previously obtained about this class through tedious case-based proofs can now be proved “automatically”, using a decision procedure.

1 Introduction

Let $V_k(n)$ be the highest power of k dividing n ; thus, for example, we have $V_2(48) = 16$. A famous theorem of Büchi [7], as corrected and clarified by Bruyère et al. [6], states that for each integer $k \geq 2$, the first-order logical theory $\text{FO}(\mathbb{N}, +, <, 0, 1, V_k)$ is decidable. (The logical structure $(\mathbb{N}, +, <, 0, 1, V_2)$ is sometimes called *Büchi arithmetic*; it is an extension of the more familiar Presburger arithmetic.) As a consequence, it follows that the first-order theory of k -automatic sequences is decidable.

Recently decidability results have been proved for a number of interesting infinite classes of infinite sequences. For the paperfolding sequences, see [15]. For a class of Toeplitz words, see [13]. For the Sturmian sequences, see [16].

In this paper we prove that a similar result holds for the first-order theory of the binary overlap-free words (and, more generally, for α -power-free words for α a rational number with $2 < \alpha \leq 7/3$). This allows us to prove (in principle), purely mechanically, assertions about the factors of such words, compare different overlap-free words, and quantify over all overlap-free words or appropriate subsets of them.

A version of this decision algorithm has been implemented using **Walnut**, a theorem-prover originally designed by Hamoon Mousavi [21, 27], and we have used it to reprove various known results about overlap-free words, and some new ones.

2 Definitions and basic concepts

Let $x = e_{t-1} \cdots e_1 e_0$ be a word over the alphabet $\{0, 1, 2\}$. We define $[x]_2 = \sum_{0 \leq i < t} e_i 2^i$, the value of x when interpreted in base 2. The case where the $e_i \in \{0, 1\}$ corresponds to the ordinary binary representation of numbers; if the digit 2 is also allowed, we refer to the *extended binary representation*. For example $[210]_2 = [1010]_2 = 10$.

Let $x = x[0..n-1]$ be a finite word of length n . If $1 \leq p \leq n$ and $x[i] = x[i+p]$ for $0 \leq i < n-p$, then we say that x has *period* p . The least period is called *the period*, and is denoted $\text{per}(x)$. The *exponent* of a nonempty word x is defined to be $|x|/\text{per}(x)$. If $\text{exp}(x) = \alpha$, we say that x is an α -power. For example, the word **onion** is a $\frac{5}{2}$ -power.

The supremum of $\text{exp}(x)$, taken over all finite nonempty factors of x , is called the *critical exponent* of x , and is denoted $\text{ce}(x)$. If $\text{ce}(x) < \alpha$, we say that x *avoids α -powers* or that x is *α -power-free*. If $\text{ce}(x) \leq \alpha$, we say that x *avoids α^+ -powers* or that x is *α^+ -power-free*. Thus when we talk about power-freeness, we are using a sort of “extended reals”, under the agreement that $e < e^+ < f$ for all $e < f$; this very useful notational convention was apparently introduced by Kobayashi [19, p. 186]. These concepts extend seamlessly to infinite words. A *square* is a 2-power; an example in English is **murmur**. The *order* of a square xx is defined to be $|x|$.

An *overlap* is a word of the form $axaxa$, where a is a single letter and x is a possibly empty word. For example, the French word **entente** is an overlap. If a word has no factor that is an overlap, we say it is *overlap-free*. Equivalently, a word is overlap-free iff it avoids 2^+ -powers. Much of what we know about overlap-free words is contained in Thue’s seminal 1912 paper [30, 2]. For more recent advances, see [14, 24, 25, 8, 28, 22].

The most famous infinite binary overlap-free word is

$$\mathbf{t} = 01101001 \cdots,$$

the Thue-Morse sequence. It satisfies the equation $\mathbf{t} = \mu(\mathbf{t})$, as does its binary complement $\bar{\mathbf{t}}$, where μ is the *Thue-Morse morphism* mapping 0 to 01 and 1 to 10.

We write μ^n for the n -fold composition of μ with itself.

A theorem of Restivo and Salemi [25] provides a structural description of finite and infinite binary overlap-free words in terms of the Thue-Morse morphism μ . This result was extended to all powers $2 < \alpha \leq \frac{7}{3}$ in [18], as follows:

Theorem 1. *Let $S = \{\epsilon, 0, 1, 00, 11\}$. Let $2 < \alpha \leq \frac{7}{3}$ be a rational number (p/q) or extended rational $(p/q)^+$.*

(a) *Suppose w is a finite binary α -free word. Then there exist words*

$$x_0, x_1, \dots, x_n, y_0, y_1, \dots, y_{n-1} \in S$$

such that $x = x_0\mu(x_1)\mu^2(x_2) \cdots \mu^n(x_n)\mu^{n-1}(y_{n-1}) \cdots \mu(y_1)y_0$.

(b) *Suppose \mathbf{w} is an infinite binary α -free word. Then there exist infinitely many words x_0, x_1, \dots such that $\mathbf{w} = x_0\mu(x_1)\mu^2(x_2) \cdots$, or finitely many words x_0, x_1, \dots, x_n such that $\mathbf{w} = x_0\mu(x_1)\mu^2(x_2) \cdots \mu^n(x_n)\mathbf{t}$ or $\mathbf{w} = x_0\mu(x_1)\mu^2(x_2) \cdots \mu^n(x_n)\bar{\mathbf{t}}$.*

Of course, not all sequences of choices of the x_i and y_i result in overlap-free (or α -power-free) words. For example, taking $x_0 = 0$, $x_1 = 11$, $y_0 = 1$ gives the word $0\mu(11)1 = 010101 = (01)^3$. See [8, 9, 17, 4, 26, 23] for more details.

3 Decidability for binary overlap-free words

Theorem 1 is our basic tool. We code the words x_i and y_i with the following correspondence:

$$\begin{aligned} g(1) &= \epsilon \\ g(2) &= 0 \\ g(3) &= 1 \\ g(4) &= 00 \\ g(5) &= 11. \end{aligned}$$

The finite code $c_0c_1 \cdots c_t \in \{1, 2, 3, 4, 5\}^*$ is understood to specify the finite *Restivo word*

$$R(c_0c_1 \cdots c_t) = g(c_0)\mu(g(c_1))\mu^2(g(c_2)) \cdots \mu^t(g(c_t))$$

and the infinite code $c_0c_1 \cdots \in \{1, 2, 3, 4, 5\}^\omega$ is understood to specify the infinite Restivo word

$$R(c_0c_1 \dots) = g(c_0)\mu(g(c_1))\mu^2(g(c_2)) \cdots .$$

Thus the Restivo words correspond to “one-sided” part (a) of Theorem 1.

Similarly, the finite codes $c_0c_1 \cdots c_t, d_0d_1 \cdots d_{t-1} \in \{1, 2, 3, 4, 5\}^*$ are understood to specify the finite *Salemi word*

$$S(c_0c_1 \cdots c_t, d_0d_1 \cdots d_{t-1}) = g(c_0)\mu(g(c_1))\mu^2(g(c_2)) \cdots \mu^t(g(c_t))\mu^{t-1}(g(d_{t-1})) \cdots \mu^1(g(d_1))g(d_0).$$

Thus, the Salemi words correspond to the “two-sided” part (b) of Theorem 1.

We emphasize that we do *not* require that Restivo words and Salemi words be overlap-free, only that they are of the form given above with the $c_i, d_i \in S$.

We prove the following results:

Theorem 2. *Let $N_{c,d}$ be the structure $(\mathbb{N}, <, +, 0, 1, n \rightarrow V_2(n), n \rightarrow S(c, d)[n])$, where we augment Büchi arithmetic by a finitely coded Salemi word $S(c, d)$. Let $K_{\text{finite}} = \{N_{c,d} : c, d \in \{1, 2, 3, 4, 5\}^*\}$. Then the first-order logical theory $\text{FO}(K_{\text{finite}})$ is decidable.*

Theorem 3. *Let N'_c be the structure $(\mathbb{N}, <, +, 0, 1, n \rightarrow V_2(n), n \rightarrow R(\mathbf{c})[n])$, where we augment Büchi arithmetic by a Restivo word $R(\mathbf{c})$ with infinite code \mathbf{c} . Let $K_{\text{infinite}} = \{N'_c : \mathbf{c} \in \{1, 2, 3, 4, 5\}^\omega\}$. Then the first-order logical theory $\text{FO}(K_{\text{infinite}})$ is decidable.*

Proof of Theorems 2 and 3. The basic strategy of our decision procedure can be found in the papers of Büchi [7] and Bruyère et al. [6] mentioned previously. Since Büchi arithmetic itself is decidable, and is powerful enough to express the computations of a deterministic finite automaton (DFA) or deterministic finite automaton with output (DFAO), it suffices to construct a DFAO computing $n \rightarrow S(c, d)[n]$ and $n \rightarrow R(\mathbf{c})[n]$. Here the automata take the words coding c, d, \mathbf{c} and n (in binary) in parallel, and compute the n 'th bit of the corresponding word. We call these the *lookup automata*. For the Salemi words we use ordinary finite automata, and for infinite binary words we use Büchi automata.

We construct the lookup automata in stages. First we describe how to compute the lookup automaton for the finite Restivo word

$$R(c_0c_1 \cdots c_t) = g(c_0)\mu(g(c_1))\mu^2(g(c_2)) \cdots \mu^t(g(c_t)).$$

Given n , our first task is to determine in which factor the index n lies. To achieve this, we observe that $|\mu^j(g(i))| = 2^j|g(i)| = a \cdot 2^i$ for $i \in \{1, 2, 3, 4, 5\}, a \in \{0, 1, 2\}$. Defining the morphism h as follows:

$$\begin{aligned} h(1) &= 0 \\ h(2) &= 1 \\ h(3) &= 1 \\ h(4) &= 2 \\ h(5) &= 2, \end{aligned}$$

we see that $h(i) = |g(i)|$. If we now interpret $h(c_t \cdots c_1c_0)$ as a generalized base-2 number with the digit set $\{0, 1, 2\}$, we see that the n 'th symbol of $R(c_0c_1 \cdots c_t)$ is equal to the $n - k$ 'th symbol of $\mu^i(g(c_i))$, where

$$[h(c_{i-1} \cdots c_1c_0)]_2 \leq n < [h(c_i \cdots c_1c_0)]_2, \tag{1}$$

and $k = [h(c_{i-1} \cdots c_1c_0)]_2$. Here all words are indexed starting at position 0. We can find the appropriate i with an existential quantifier that checks the inequalities (1).

Since n is given in binary, we need a normalizer that takes as input two strings in parallel, one over the larger digit set $\{0, 1, 2\}$ and one over the ordinary digit set $\{0, 1\}$, and accepts if they represent the same number when considered in base 2. This is done with the automaton in Figure 1. Correctness of this automaton is easily proved by induction on the length of the input, using the fact that state 0 corresponds to “no carry” and state 1 corresponds to “carry expected”.

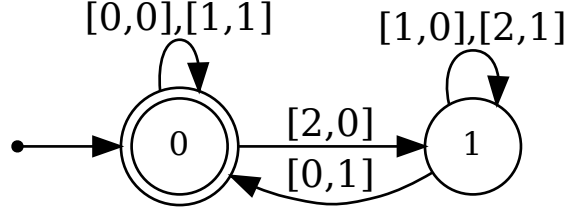

Figure 1: Normalizer for base-2 expansions.

The final piece is the observation that the first 2^i bits of \mathbf{t} are just $\mu^i(0)$, and the first 2^i bits of $\bar{\mathbf{t}}$ are $\mu^i(1)$. Since a 2-state automaton can compute the n 'th bit of \mathbf{t} (or $\bar{\mathbf{t}}$), we can determine the appropriate bit.

Exactly the same idea works for the infinite Restivo words, except now the code is an infinite word, so we need to use a Büchi automaton in order to process it correctly.

The finite Salemi words are only slightly more complicated. Here we use the (easily-verified) fact that

$$\mu^{t-1}g(d_{t-1}) \cdots \mu^1(g(d_1))g(d_0) = w^R,$$

where

$$w = \begin{cases} g(d_0)\mu(\overline{g(d_1)})\mu^2(\overline{g(d_2)})\mu^3(\overline{g(d_3)}) \cdots \mu^{t-1}(\overline{g(d_{t-1})}), & \text{if } t \text{ odd;} \\ g(d_0)\mu(\overline{g(d_1)})\mu^2(\overline{g(d_2)})\mu^3(\overline{g(d_3)}) \cdots \mu^{t-1}(\overline{g(d_{t-1})}), & \text{if } t \text{ even.} \end{cases}$$

On input n , we use the lengths of the finite words $g(c_0)\mu(g(c_1))\mu^2(g(c_2)) \cdots \mu^t(g(c_t))$ and $\mu^{t-1}g(d_{t-1}) \cdots \mu^1(g(d_1))g(d_0)$ to decide where the n 'th symbol lies, and then appeal to the lookup automaton for $R(c_0 \cdots c_t)$, or its modification for w , to compute the appropriate bit.

This completes our sketch of the decision procedure. \square

For an infinite word \mathbf{x} , we can write a first-order formulas asserting that \mathbf{x} has an overlap (resp., has a p/q -power), as follows:

$$\begin{aligned} \exists i, n (n \geq 1) \wedge \forall t (t \leq n) &\implies \mathbf{x}[i+t] = \mathbf{x}[i+t+n] \\ \exists i, n (n \geq 1) \wedge \forall t (qt < (p-q)n) &\implies \mathbf{x}[i+t] = \mathbf{x}[i+t+n]. \end{aligned}$$

Here p and q are positive integer constants and an expression like qt is shorthand for $\overbrace{t + t + \dots + t}^{q \text{ times}}$.

So, incorporating these two formulas into larger first-order logical formulas asserting that a given code specifies an overlap-free word (or α -free word for rational or extended rational α with $2 < \alpha \leq 7/3$), we immediately get the following corollary:

Corollary 4. *The first-order theory of the overlap-free words (or more generally, α -free words for rational or extended rational α with $2 < \alpha \leq 7/3$), is decidable.*

4 Implementation

We implemented part of the decision procedure discussed in Section 3 using `Walnut`, a theorem-prover originally designed by Hamoon Mousavi [21].

The main part we implemented was for the finite Restivo words. This allows us to solve many (but not all) questions about infinite overlap-free words. The limitation is because `Walnut` is based on ordinary finite automata and not Büchi automata.

To implement our decision procedure in `Walnut`, we represent encodings as strings over the alphabet $\{1, 2, 3, 4, 5\}$. Since the encoded binary string might need more binary digits to specify a position within it than the number of symbols in the encoding, we also allow an arbitrary number of trailing zeros in a code.

All numbers are represented in base 2, starting with the *least significant digit*.

Our `Walnut` solution needs various subautomata, as follows. Most of these are deterministic finite automata (DFA), with the exception of `CODE` and `LOOK`, which are DFAO's.

- **power2**: one argument n . True if n is a power of 2 and 0 otherwise.
- **adjacent**: two arguments m, n . True if $m = 2^i, n = 2^{i-1}$ for some $i \geq 1$, or if $m = 1$ and $n = 0$.
- **hmorph**: two arguments c, y . True if y represents applying h to the code specified by c .
- **validcode**: one argument c . True if c represents a valid code, that is, a word in $\{1, 2, 3, 4, 5\}^*$ followed by 0's.
- **length**: two arguments c, n . True if n is the length of the binary string encoded by the codes c .
- **prefix**: three arguments a, b, c . Both b, c are extended binary representations, while a is either 0 or a power of 2 in ordinary binary representation. The result is true if the word c equals b copied digit-by-digit, up to and including the position specified by the single 1 in a , and 0's thereafter.
- **CODE**: a DFAO, two arguments c, n . Returns the code in $\{1, 2, 3, 4, 5\}$ corresponding to the digit specified by n , a power of 2.

- `look1`: two arguments c, n . True if $R(c_0c_1 \cdots c_{t-1})[n] = 1$ and 0 otherwise (which includes the case where the index n is out of range).
- `look2`: two arguments c, n . True if the code c is invalid (for example, because it has interior 0's) or the index n is out of range.
- `LOOK`: a DFAO, two arguments c, n . Returns $R(c_0c_1 \cdots c_{t-1})[n]$ if the index is in range, and 2 otherwise. Obtained by combining the DFA's for `look1` and `look2`.

Here is the Walnut code for these. A brief reminder of Walnut's syntax may be necessary.

- `A` and `E` represent the universal and existential quantifiers, respectively.
- `lsd_k` tells Walnut to interpret numbers in base- k , using least-significant-digit first representation.
- `|` is logical OR, `&` is logical AND, `=>` is logical implication, `~` is logical NOT.
- `reg` defines a regular expression.
- `def` defines an automaton accepting the representation of free variables making the formula true.

```

reg power2 lsd_2 "0*10*":
def adjacent "?lsd_2 ($power2(m) & $power2(n) & m=2*n) | (m=1 & n=0)":
reg hmorph lsd_6 lsd_3 "([1,0] | [2,1] | [3,1] | [4,2] | [5,2])*[0,0]*":
reg validcode lsd_6 "(1|2|3|4|5)*0*":
reg prefix lsd_2 lsd_3 lsd_3 "(([0,0,0] | [0,1,0] | [0,2,0])* |
  (([0,0,0] | [0,1,1] | [0,2,2])*)([1,0,0] | [1,1,1] | [1,2,2])
  ([0,0,0] | [0,1,0] | [0,2,0])*):
def length "?lsd_2 E1 $hmorph(?lsd_6 c, ?lsd_3 l) &
  $normalize(?lsd_3 l, ?lsd_2 n)":

```

In order to construct the automaton `look1`, which is the most complicated part of our construction, we use the following auxiliary variables:

- p , the power of 2 that corresponds to the particular $\mu^i(g(c_i))$ block that the n 'th bit falls in.
- $q = \lfloor p/2 \rfloor$.
- l , a number in extended binary representing the lengths of the strings represented by the codes c .
- g , a number in extended binary where we have cancelled from l the bits corresponding to higher powers of 2 than p .

- h , a number in extended binary where we have cancelled from l the bits corresponding to higher powers of 2 than q .
- r , a base-2 index giving the start of the block after which n appears.
- s , a base-2 index giving the start of the block where n appears.
- x , the relative position inside the appropriate block corresponding to the bit n .

Once these are “guessed” with an existential quantifier, we verify them with the appropriate automata and then compute the appropriate bit depending on the particular c_i , as follows:

```
def look1 "?lsd_2 Ep,q,l,g,h,r,s,x $validcode(?lsd_6 c) & $adjacent(p,q) &
$hmorph(?lsd_6 c,?lsd_3 l) & $prefix(?lsd_2 p,?lsd_3 l,?lsd_3 g) &
$prefix(?lsd_2 q,?lsd_3 l,?lsd_3 h) & $normalize(?lsd_3 g,?lsd_2 r) &
$normalize(?lsd_3 h,?lsd_2 s) & n>=s & n<r & x+s=n &
((CODE[?lsd_2 p][?lsd_6 c]=@2 & T[x]=@1)
|(CODE[?lsd_2 p][?lsd_6 c]=@3 & T[x]=@0)
|(CODE[?lsd_2 p][?lsd_6 c]=@4 & x<p & T[x]=@1)
|(CODE[?lsd_2 p][?lsd_6 c]=@4 & x>=p & T[x-p]=@1)
|(CODE[?lsd_2 p][?lsd_6 c]=@5 & x<p & T[x]=@0)
|(CODE[?lsd_2 p][?lsd_6 c]=@5 & x>=p & T[x-p]=@0))":
def look2 "?lsd_2 (~$validcode(?lsd_6 c)) | (E1 $length(?lsd_6 c,?lsd_2 l)
& n>=1)":
combine LOOK look1=1 look2=2:
```

The resulting DFAO, LOOK, has 17 states. We do not display it here because its transition diagram is too complicated.

5 Applications

5.1 Overlap-free words

We can now use this DFAO to obtain a number of results. First, let us find an automaton recognizing all finite words $c_0 \cdots c_{t-1}$ such that $R(c_0 \cdots c_{t-1})$ is overlap-free. This is done as follows:

```
def hasover "?lsd_2 At (t<=n) => LOOK[?lsd_6 c][i+t]=LOOK[?lsd_6 c][i+n+t]":
def ovlf "?lsd_2 $validcode(?lsd_6 c) & ~Ei,n,l $length(?lsd_6 c,?lsd_2 l)
& n>=1 & i+2*n<l & $hasover(?lsd_6 c,?lsd_2 i,?lsd_2 n)":
reg good lsd_6 "(1|2|3|4|5)*":
def ovlfg "?lsd_6 $good(c) & $ovlf(c)":
```

The resulting automaton is depicted in Figure 2.

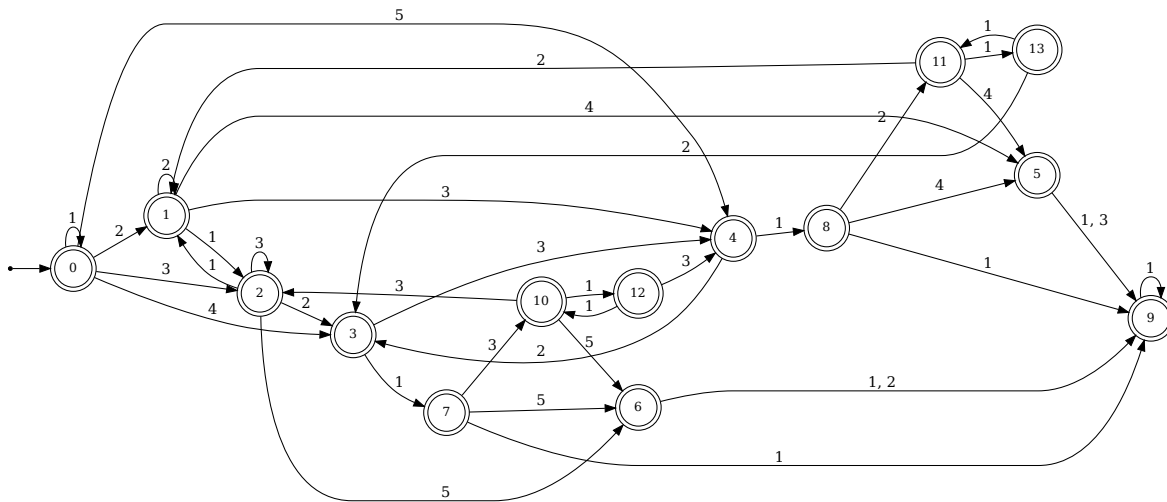

Figure 2: Codes for overlap-free sequences.

This automaton essentially accepts all infinite strings $c_0c_1c_2\cdots$ such that $R(c_0c_1\dots)$ is overlap-free. However, there are some subtleties that arise in interpreting it, due to the nature of our encoding. We describe them now.

When we compare the automaton in Figure 2 to that in [26], we see the following differences. First, the codes are different, and are related as follows:

encoded word	old code	new code
ϵ	0	1
0	1	2
1	3	3
00	2	4
11	4	5

Second, the names of states are different, and are related as follows:

old state	new state
A	0
B	1
C	3
D	2
E	4
F	7
G	10
H	12
I	8
J	11
K	13

Notice that the automaton in Figure 2 has three additional states, numbered 5,6,9, that do not appear in the automaton given in [26]. The explanation for this is as follows: the only accepting paths from these states end in an infinite tail of 1's. These paths can only correspond to either a suffix of \mathbf{t} or $\bar{\mathbf{t}}$, and in all cases the resulting words have overlaps. Therefore we can delete these states 5,6,9 from Figure 2 and obtain the automaton given in [26].

We now use our automaton for overlap-free words to prove a result, about the lexicographically least overlap-free infinite word, previously proved in [1].

Theorem 5. *The lexicographically least overlap-free infinite word is $001001\bar{\mathbf{t}}$.*

Proof. We create a Walnut formula that recognizes all finite code strings c with the property that the overlap-free word w specified by c is lexicographically \leq all overlap-free words w' with $|w'| \geq |w|$. This can be done as follows:

```

reg good lsd_6 "(1|2|3|4|5)*":
def agrees "?lsd_2 At (t<b) => LOOK[?lsd_6 c1][t]=LOOK[?lsd_6 c2][t]":
# inputs (b,c1,c2)
# does the word specified by c1 agree with that specified by c2
# on positions 0 through b-1?

def ispref "?lsd_2 E11,12 $length(?lsd_6 c1,?lsd_2 l1) &
  $length(?lsd_6 c2,?lsd_2 l2) & l1<=l2 &
  $agrees(l1,?lsd_6 c1, ?lsd_6 c2)":
# code c1, c2
# yes if word coded by c1 is a prefix of that coded by c2

def lexlt "?lsd_2 E11,12,m,i $length(?lsd_6 c1,?lsd_2 l1) &
  $length(?lsd_6 c2,?lsd_2 l2) & $min(l1,l2,m) & i<m &
  $agrees(i,?lsd_6 c1, ?lsd_6 c2) &

```

```
LOOK[?l6 c1][?l2 i]<LOOK[?l6 c2][?l2 i]":
```

```
def lexlte "?l6 $ispref(c1,c2) | $lexlt(c1,c2)":
```

```
def lexleast "?l2 $good(c1) & $validcode(?l6 c1) & $ovlf(?l6 c1)
& Ac2,11,12 ($validcode(?l6 c2) & $ovlf(?l6 c2)
& $length(?l6 c2,?l2 12) & $length(?l6 c1,?l2 11) & 11<=12)
=> $lexlte(c1,c2)":
```

The resulting automaton is depicted in Figure 3. This was a rather big computation in Walnut; the automaton for `agrees` has 122 states, and required 120G of RAM and 87762417 ms to compute. The largest intermediate automaton had 3534633 states.

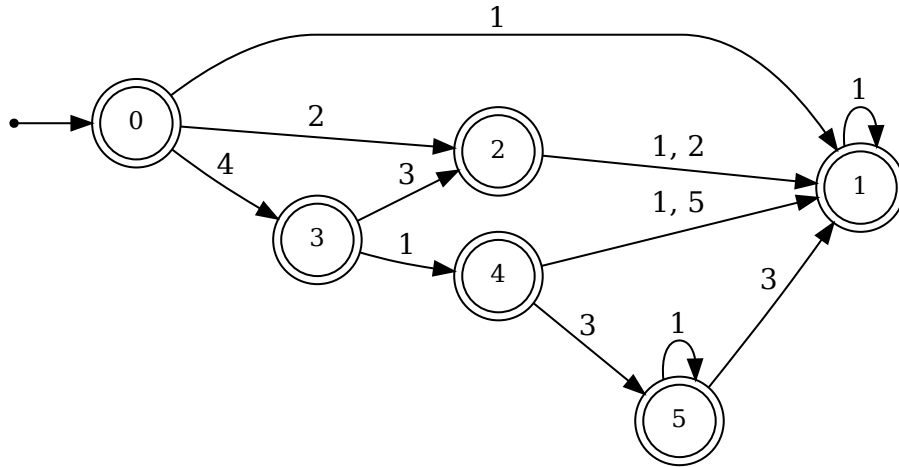

Figure 3: Codes for lexicographically smallest words.

By inspection of this automaton, we see that the only arbitrarily long accepting path that does not end in 1's is 4131*3. This corresponds to the word 001001 \bar{t} . \square

Remark 6. Using our technique, we can also prove that the same word 001001 \bar{t} is the lexicographically least $7/3$ -power-free word, and hence it is lexicographically least for all α -power-free words with $2 < \alpha \leq 7/3$.

Now we turn to the following theorem from [5]:

Theorem 7. *Take the Thue-Morse word \mathbf{t} and flip any finite nonzero number of bits, sending 0 to 1 and vice versa. Then the resulting word has an overlap.*

At first glance this theorem does not seem susceptible to our technique, because specifying an arbitrary finite set of positions to change requires second-order logic. But we can still prove it! Instead of quantifying over all finite sets of positions to change, we instead quantify over all infinite overlap-free words, and ask for which codes $c_0c_1c_2\cdots$ the specified word agrees with Thue-Morse on an infinite suffix.

If we had implemented our decision procedure for infinite Restivo words using Büchi automata instead of ordinary finite automata, this would be easy to translate into a first-order logical formula. However, the fact that our implementation can only deal with finite codes $c_0c_1\cdots c_t$ makes it somewhat harder.

Proof. Instead, we use the following idea: we design an automaton to accept all finite codes $c_0\cdots c_t$ with the property that there exists arbitrarily long finite codes $d_0\cdots d_s$ such that

- $c_0\cdots c_t$ is a prefix of $d_0\cdots d_s$;
- $w = R(d_0\cdots d_s)$ is overlap-free;
- $|R(c_0\cdots c_t)| = l$;
- w agrees with \mathbf{t} on the positions from index l to index $|w| - 1$.

This is done with the following Walnut code:

```
reg prefixc lsd_6 lsd_6 "([1,1] | [2,2] | [3,3] | [4,4] | [5,5])*
([0,1] | [0,2] | [0,3] | [0,4] | [0,5])*[0,0]*":
reg lastnzcode lsd_6 lsd_2 "([1,0] | [2,0] | [3,0] | [4,0] | [5,0])*
([1,1] | [2,1] | [3,1] | [4,1] | [5,1])[0,0]*":
def tmagree "?lsd_2 E1 $length(?lsd_6 c,?lsd_2 1) &
At (t>=n & t<1) => LOOK[?lsd_6 c][t] = T[t]":
def changebits "?lsd_2 $good(?lsd_6 c) & E1 $length(?lsd_6 c,?lsd_6 1) &
Az Ed,y $prefixc(?lsd_6 c,?lsd_6 d) & $length(?lsd_6 d,?lsd_2 y)
& y>=z & $tmagree(?lsd_6 d,?lsd_2 1) & $ovlf(?lsd_6 d)":
```

The resulting automaton only accepts 1^* , so there are no such codes except that specifying the Thue-Morse sequence. □

5.2 $\frac{7}{3}$ -power-free words

We now apply the method to re-derive the automaton given in [23] for $\frac{7}{3}$ -power-free words.

```
def avoid73 "?lsd_2 $validcode(?lsd_6 c) & ~Ei,n,1
$length(?lsd_6 c,?lsd_6 1) & n>=1 & i+(7*n)/3<1 &
At (3*t<4*n) => LOOK[?lsd_6 c][i+t]=LOOK[?lsd_6 c][i+n+t]":
def avoid73g "?lsd_6 $good(c) & $avoid73(c)":
```

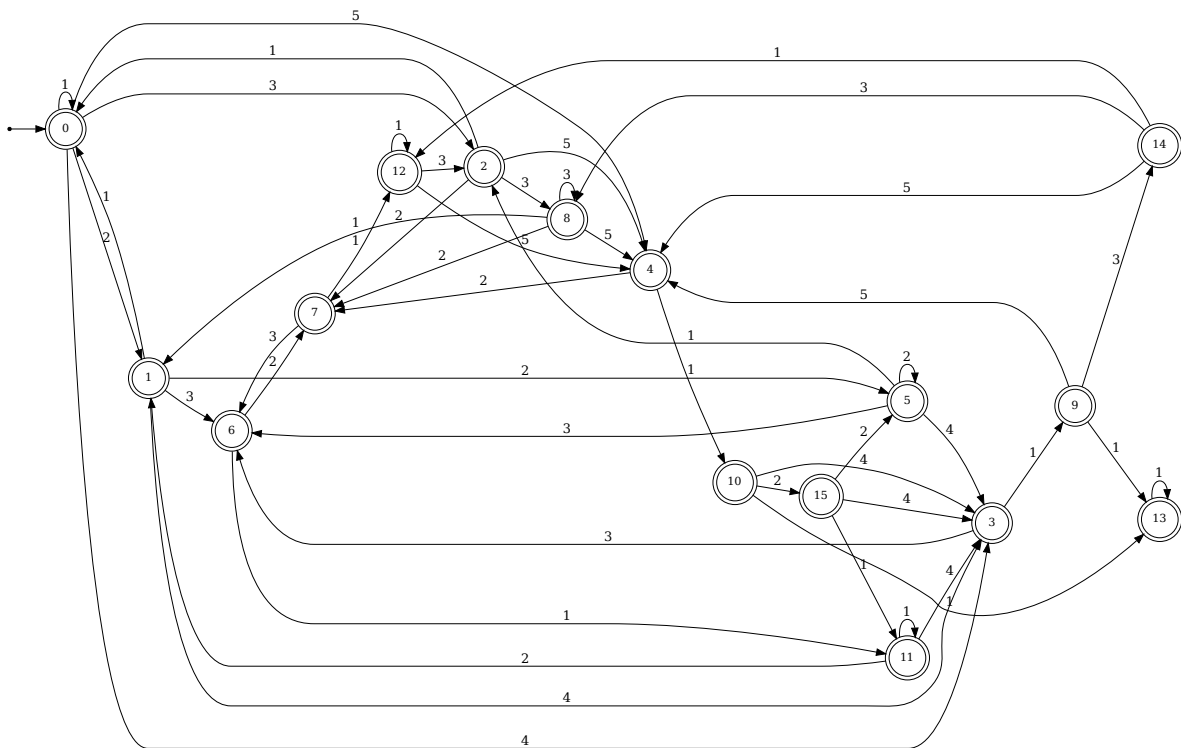

Figure 4: Codes for $\frac{7}{3}$ -power-free sequences.

This obtains, in a purely mechanical fashion, the automaton in Figure 2 of [23] that was previously constructed using a rather tedious examination of cases. The relationship between the old version in that paper and the new version given here is summarized in Table 5.2:

old state	new state
ϵ	0
1	1
2	3
3	2
4	4
11	5
13	6
31	7
33	8
20	9
40	10
130	11
310	12
203	14
401	15

Once again there is a state, state 13, that appears in Figure 4 but not in the paper [23]. Again, this is because the only accepting path reachable from this state consists of an infinite tail of 1's, which does not result in a $\frac{7}{3}$ -power-free word.

As an application, let us reprove a result from [11]:

Theorem 8. *There exist uncountably many infinite $\frac{7}{3}$ -power-free binary words, each containing arbitrarily large overlaps.*

Proof. We claim that every code in $212\{12, 1112\}^i$ corresponds to a $\frac{7}{3}$ -power-free word with overlaps of i different lengths. The automaton in Figure 4 clearly accepts every word in $212\{12, 1112\}^*$, so the words are $\frac{7}{3}$ -power-free. To check the property of containing arbitrarily large overlaps, we create an automaton that recognizes, in parallel, those codes in $(211^*)^*2$, together with the lengths of overlaps that occur in the resulting word.

```
reg two1 lsd_6 "(21(1*))20*":
def large_overl "?lsd_2 E1,i $length(?lsd_6 c,?lsd_2 1) & $two1(?lsd_6 c)
& n>=1 & i+2*n<1 & $hasover(?lsd_6 c,?lsd_2 i,?lsd_2 n)":
```

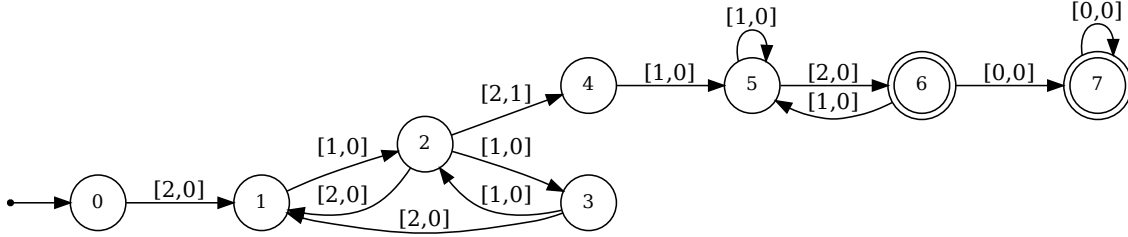

Figure 5: Large overlaps in a $\frac{7}{3}$ -power-free word.

Inspection of the automaton in Figure 5 proves the claim. Hence every word coded by $212\{12, 1112\}^\omega$ has overlaps of infinitely many different lengths. \square

5.3 New results

We can use the framework so far to prove a number of new results about overlap-free and Restivo words.

For example, it is an easy consequence of the Restivo-Salemi theorem that every infinite overlap-free binary word contains arbitrarily large squares. We can prove this and more in a quantitative sense.

Theorem 9. *Every finite overlap-free word of length $l > 7$ contains a square of order $\geq l/6$. Furthermore, the bound is best possible, in the sense that there are arbitrarily large overlap-free words for which the largest square is of order exactly $l/6$.*

Proof. We can check the first claim with Walnut as follows:

```
def has_square "?lsd_2 At (t<n) => LOOK[?lsd_6 c][i+t]=LOOK[?lsd_6 c][i+t+n]":
eval squ "?lsd_2 Ac,1 ($ovlf(?lsd_6 c) & $length(?lsd_6 c,?lsd_2 1) & l>7)
=> Ei,n i+2*n<=l & 6*n>=1 & $has_square(?lsd_6 c,?lsd_2 i,?lsd_2 n)":
```

For the second claim, we can actually determine all code sequences for which the largest square is of order exactly $l/6$.

```
def squ3 "?lsd_2 Ei,n,1 $ovlf(?lsd_6 c) & $length(?lsd_6 c,?lsd_2 1)
& i+2*n<=l & 6*n=1 & $has_square(?lsd_6 c, ?lsd_2 i, ?lsd_2 n)":
def squ3b "?lsd_2 Ai,n,1 ($ovlf(?lsd_6 c) & $length(?lsd_6 c,?lsd_2 1)
& i+2*n<=l & $has_square(?lsd_6 c, ?lsd_2 i, ?lsd_2 n)) => 6*n<=1":
def squ4g "?lsd_6 $good(c) & $squ3(c) & $squ3b(c)":
```

The resulting automaton is depicted in Figure 6.

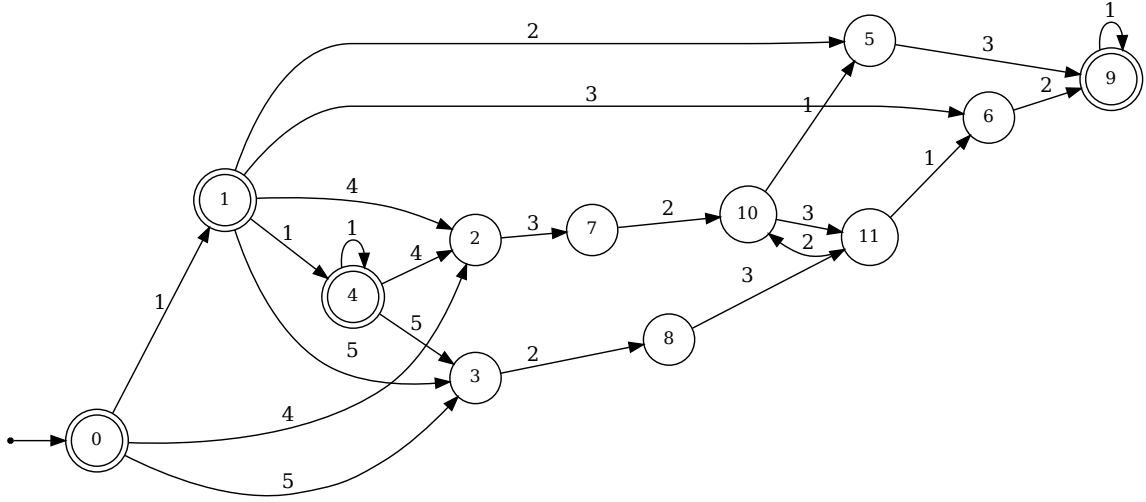

Figure 6: Codes for length- l overlap-free words with largest square of order $l/6$.

In particular, the code sequence $4(32)^i13$ has length $6 \cdot 4^i$ and has largest square of order 4^i . \square

We can prove a similar, but weaker bound, for the larger class of all Restivo words:

Theorem 10. *Every finite Restivo word of length $l > 8$ contains a square of order $\geq (l+2)/7$. Furthermore, the bound is best possible, in the sense that there are arbitrarily large overlap-free words for which the largest square is of order exactly $(l+2)/7$.*

Proof. For the first statement we use

```
eval squaresin "?lsd_2 Ai,n,1 ($validcode(?lsd_6 c) & $length(?lsd_6 c,?lsd_2 l)
  & l>8) => Ei,n i+2*n<=l & 7*n>=l+2 & $has_square(?lsd_6 c,?lsd_2 i,?lsd_2 n)":
```

which evaluates to TRUE.

For the second we construct an automaton accepting those code sequences c for which the largest square is of order exactly $(l+2)/7$.

```
def squ3 "?lsd_2 Ei,n,1 $validcode(?lsd_6 c) & $length(?lsd_6 c,?lsd_2 l)
  & i+2*n<=l & 7*n=1+2 & $has_square(?lsd_6 c,?lsd_2 i,?lsd_2 n)":
def squ3b "?lsd_2 Ai,n,1 ($validcode(?lsd_6 c) & $length(?lsd_6 c,?lsd_2 l)
  & i+2*n<=l & $has_square(?lsd_6 c,?lsd_2 i,?lsd_2 n)) => 7*n<=l+2":
def squ4g "?lsd_6 $good(c) & $squ3(c) & $squ3b(c)":
```

The resulting automaton is depicted in Figure 7.

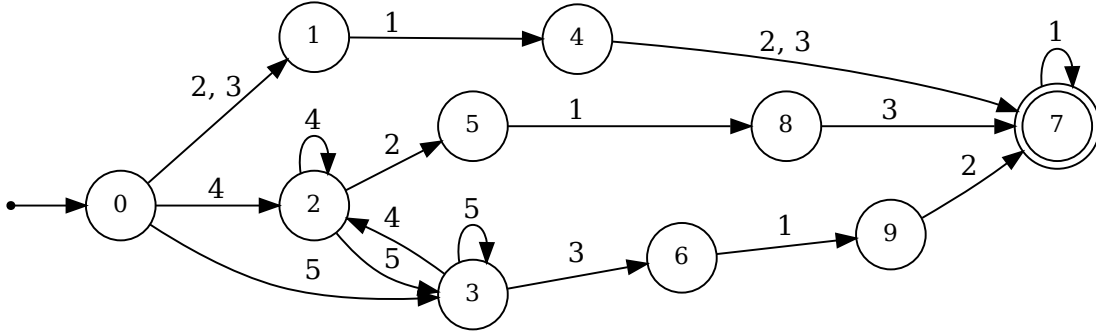

Figure 7: Codes for length- l Restivo words with largest square of order $(l + 2)/7$.

As you can see, code words of the form $5^i 312$ achieve the bound. □

As we have seen, not all code sequences result in overlap-free or $\frac{7}{3}$ -power-free words. If we consider all code sequences, however, then we can prove the following new result:

Theorem 11.

- (a) Every (one-sided right) infinite word coded by a member of $\{1, 2, 3, 4, 5\}^\omega$ is 4th-power-free.
- (b) Furthermore, this bound is best possible, in the sense that for each exponent $e < 4$ there is an infinite word coded by a code in $\{1, 2, 3, 4, 5\}^\omega$ having a critical exponent $> e$.

Proof.

- (a) We can check this with Walnut as follows:

```
eval fourthr "?lsd_2 Ei,n,1,c $validcode(?lsd_6 c) &
  $length(?lsd_6 c,?lsd_6 l) & n>=1 & i+3*n<=l & At (t<3*n)
  => LOOK[?lsd_6 c][i+t]=LOOK[?lsd_6 c][i+n+t]":
```

This asserts the existence of a 4th power, and returns FALSE, so no fourth power exists.

- (b) This requires a little more work. What we do is show that for all finite codes of length $t \geq 3$, there is a code resulting in a word having a factor of length $2^t - 1$ with period 2^{t-2} , and hence an exponent of $4(1 - 2^{-t})$.

```

reg lastnzcode lsd_6 lsd_2 "([1,0] | [2,0] | [3,0] | [4,0] | [5,0])*
([1,1] | [2,1] | [3,1] | [4,1] | [5,1])[0,0]*":
# last bit x with a nonzero code
# input is c,x
def maxexp "?lsd_2 Ex,1,i $lastnzcode(?lsd_6 c,?lsd_2 x) &
$length(?lsd_6 c,?lsd_2 l) & i+2*x+2<=l+1 & At (t<3*x/2-1)
=> LOOK[?lsd_6 c][i+t]=LOOK[?lsd_6 c][i+t+x/2]":

```

The resulting automaton is depicted in Figure 8.

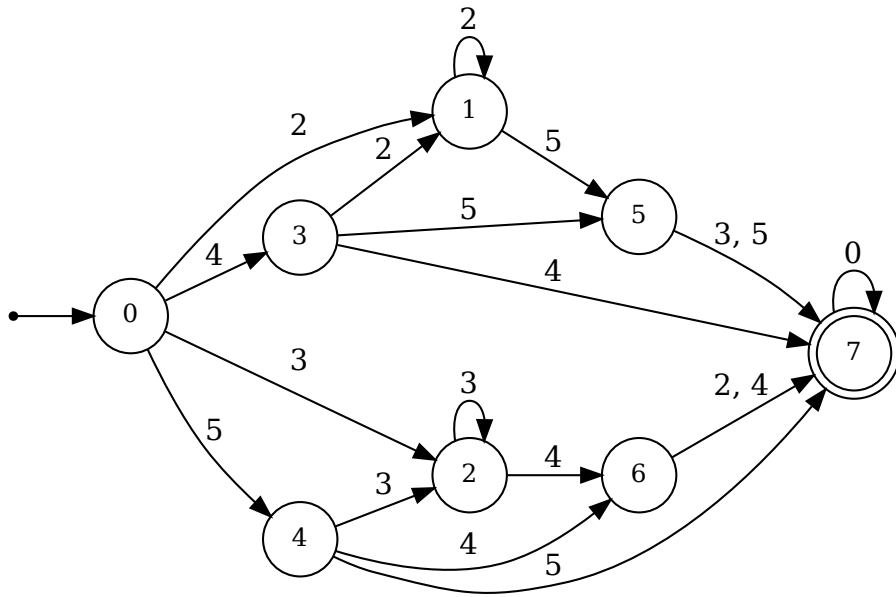

Figure 8: Codes for words of critical exponent close to 4.

From this, we see that the codes of length t specifying a word with critical exponent at least $4(1 - 2^{-t})$ are

$$2^{t-2}5\{3, 5\}, 3^{t-2}4\{2, 4\}, 42^{t-3}5\{3, 5\}, 53^{t-3}4\{2, 4\}.$$

□

6 Enumeration

As discussed in several previous papers (e.g., [10, 12]) the automaton-based technique can also be used to *enumerate*, not simply decide, certain aspects of sequences.

Here we will use these ideas to enumerate the “irreducibly extensible words” of Kobayashi [20]: these are binary words x such that there exists an infinite binary word \mathbf{y} such that $x\mathbf{y}$ is overlap-free. For example, it is easily checked that 010011001011010010 is extendable, but 010011001011010011 is not (every extension by a word of length 7 gives an overlap). Denote the number of such words as $E(n)$. Table 1 gives the first few values of this sequence.

n	1	2	3	4	5	6	7	8	9	10	11	12	13	14	15	16
$E(n)$	2	4	6	10	14	18	22	26	32	36	40	44	48	52	58	64

Table 1: First few values of $E(n)$.

This is sequence [A356959](#) in the *On-Line Encyclopedia of Integer Sequences* [29].

We can now obtain the following result of Kobayashi [20]:

Theorem 12. $E(n) = \Theta(n^c)$, for $c \doteq 1.15501186367066470321$.

Proof. In order to carry out the enumeration, we need to create a first-order logical formula asserting that c is a code for an overlap-free sequence of length at least n , and also that c is lexicographically first with this property in some appropriate order. The easiest lexicographic order results from interpreting c as a number in base 6. Then, counting the number of such codes corresponding to each n gives $E(n)$. We can carry this out with the following Walnut code:

```
def agrees "?lsd_2 At (t<b) => LOOK[?lsd_6 c1][t]=LOOK[?lsd_6 c2][t]":
def prefixequal "?lsd_2 E1,m $length(?lsd_6 c1,?lsd_2 1) &
  $length(?lsd_6 c2,?lsd_2 m) & 1>=n & m>=n &
  $agrees(?lsd_2 n,?lsd_6 c1, ?lsd_6 c2)":
def mincode "?lsd_2 E1 $ovlf(?lsd_6 c1) & $length(?lsd_6 c1, ?lsd_2 1) &
  1>=n & Ac2 ($prefixequal(?lsd_6 c1,?lsd_6 c2,?lsd_2 n) &
  $ovlf(?lsd_6 c2)) => (?lsd_6 c1<=c2)":
def minmat n "$mincode(?lsd_6 c,?lsd_2 n)":
```

Here Walnut returns a so-called *linear representation* for $E(n)$: this consists of a row vector v , a matrix-valued morphism γ , and a column vector w such that $E(n) = v\gamma(x)w$ if x is a binary word with $[x]_2 = n$. (For more about linear representations, see the book [3].) The *rank* of a linear representation is the dimension of the vector v ; in this case it is 57. With this linear representation in hand, we can compute $E(n)$ very rapidly even for large n .

The linear representation also can give us information about the asymptotic behavior of $E(n)$. To do so, it suffices to compute the minimal polynomial of the matrix $\gamma(0)$ with a

computer algebra system such as **Maple**; it is $X^4(X^4 - 2X^3 - X^2 + 2X - 2)(X - 1)^2(X + 1)^2$. Here the dominant zero is that of $X^4 - 2X^3 - X^2 + 2X - 2$, and it is

$$\zeta = \frac{1 + \sqrt{5 + 4\sqrt{3}}}{2} \doteq 2.22686154846556164.$$

It follows that $E(2^n) \sim \alpha \cdot \zeta^n$ for some constant α ; since E is strictly increasing, it follows that $E(n) = \Theta(n^c)$ for $c = \log_2(\zeta) \doteq 1.15501186367066470321$. \square

7 Going further

All the needed Walnut code can be downloaded from the website of the second author,

<https://cs.uwaterloo.ca/~shallit/walnut.html> .

In principle, one can extend this work to the Salemi words, and we were able to construct the needed lookup automaton, which has 124 states. However, so far we have been unable to use it to do much that is useful with it, because of the very large sizes of the intermediate automata (at least hundreds of millions of states). We leave this as a problem for future work.

References

- [1] J.-P. Allouche, J. Currie, and J. Shallit. Extremal infinite overlap-free binary words. *Electron. J. Combin.* **5** (1998), R27 (electronic). www.combinatorics.org/ojs/index.php/eljc/article/view/v5i1r27
- [2] J. Berstel. *Axel Thue's Papers on Repetitions in Words: a Translation*. Number 20 in Publications du Laboratoire de Combinatoire et d'Informatique Mathématique. Université du Québec à Montréal, February 1995.
- [3] J. Berstel and C. Reutenauer. *Noncommutative Rational Series with Applications*, Vol. 137 of *Encyclopedia of Mathematics and Its Applications*. Cambridge University Press, 2011.
- [4] V. D. Blondel, J. Cassaigne, and R. M. Jungers. On the number of α -power-free binary words for $2 < \alpha \leq 7/3$. *Theoret. Comput. Sci.* **410** (2009), 2823–2833.
- [5] S. Brown, N. Rampersad, J. Shallit, and T. Vasiga. Squares and overlaps in the Thue-Morse sequence and some variants. *RAIRO Inform. Théor. App.* **40** (2006), 473–484.
- [6] V. Bruyère, G. Hansel, C. Michaux, and R. Villemaire. Logic and p -recognizable sets of integers. *Bull. Belgian Math. Soc.* **1** (1994), 191–238. Corrigendum, *Bull. Belg. Math. Soc.* **1** (1994), 577.

- [7] J. R. Büchi. Weak second-order arithmetic and finite automata. *Z. Math. Logik Grundlagen Math.* **6** (1960), 66–92. Reprinted in S. Mac Lane and D. Siefkes, eds., *The Collected Works of J. Richard Büchi*, Springer-Verlag, 1990, pp. 398–424.
- [8] A. Carpi. Overlap-free words and finite automata. *Theoret. Comput. Sci.* **115** (1993), 243–260.
- [9] J. Cassaigne. Counting overlap-free binary words. In P. Enjalbert, A. Finkel, and K. W. Wagner, editors, *STACS 93*, Vol. 665 of *Lecture Notes in Computer Science*, pp. 216–225. Springer-Verlag, 1993.
- [10] É. Charlier, N. Rampersad, and J. Shallit. Enumeration and decidable properties of automatic sequences. *Internat. J. Found. Comp. Sci.* **23** (2012), 1035–1066.
- [11] J. Currie, N. Rampersad, and J. Shallit. Binary words containing infinitely many overlaps. *Electron. J. Combin.* **13** (2006), #R82 (electronic).
- [12] C. F. Du, H. Mousavi, L. Schaeffer, and J. Shallit. Decision algorithms for Fibonacci-automatic words III: Enumeration and abelian properties. *Internat. J. Found. Comp. Sci.* **27** (2016), 943–963.
- [13] G. Fici and J. Shallit. Properties of a class of Toeplitz words. *Theoret. Comput. Sci.* **922** (2022), 1–12.
- [14] E. D. Fife. Binary sequences which contain no *BBb*. *Trans. Amer. Math. Soc.* **261** (1980), 115–136.
- [15] D. Goč, H. Mousavi, L. Schaeffer, and J. Shallit. A new approach to the paperfolding sequences. In A. Beckmann et al., editor, *Computability in Europe, Cie 2015*, Vol. 9136 of *Lecture Notes in Computer Science*, pp. 34–43. Springer-Verlag, 2015.
- [16] P. Hieronymi, D. Ma, R. Oei, L. Schaeffer, C. Schulz, and J. Shallit. Decidability for Sturmian words. In F. Manea and A. Simpson, editors, *30th EACSL Annual Conference on Computer Science Logic (CSL 2022)*, Leibniz International Proceedings in Informatics, pp. 24:1–24:23. Schloss Dagstuhl—Leibniz-Zentrum für Informatik, Dagstuhl Publishing, 2022.
- [17] R. M. Jungers, V. Y. Protasov, and V. D. Blondel. Overlap-free words and spectra of matrices. *Theoret. Comput. Sci.* **410** (2009), 3670–3684.
- [18] J. Karhumäki and J. Shallit. Polynomial versus exponential growth in repetition-free binary words. *J. Combin. Theory. Ser. A* **105**(2) (2004), 335–347.
- [19] Y. Kobayashi. Repetition-free words. *Theoret. Comput. Sci.* **44** (1986), 175–197.
- [20] Y. Kobayashi. Enumeration of irreducible binary words. *Disc. Appl. Math.* **20** (1988), 221–232.

- [21] H. Mousavi. Automatic theorem proving in Walnut. Preprint, available at <http://arxiv.org/abs/1603.06017>, 2016.
- [22] N. Rampersad. *Overlap-Free Words and Generalizations*. PhD thesis, University of Waterloo, 2007.
- [23] N. Rampersad, J. Shallit, and A. Shur. Fife’s theorem for $(7/3)$ -powers. In P. Ambroz, S. Holub, and Z. Masakova, editors, *WORDS 2011*, Lecture Notes in Computer Science, pp. 189–198. Springer-Verlag, 2011.
- [24] A. Restivo and S. Salemi. On weakly square free words. *Bull. European Assoc. Theor. Comput. Sci.*, No. 21, (October 1983), 49–56.
- [25] A. Restivo and S. Salemi. Overlap free words on two symbols. In M. Nivat and D. Perrin, editors, *Automata on Infinite Words*, Vol. 192 of *Lecture Notes in Computer Science*, pp. 198–206. Springer-Verlag, 1985.
- [26] J. Shallit. Fife’s theorem revisited. In G. Mauri and A. Leporati, editors, *DLT 2011*, Vol. 6795 of *Lecture Notes in Computer Science*, pp. 397–405. Springer-Verlag, 2011.
- [27] J. Shallit. *The Logical Approach to Automatic Sequences: Exploring Combinatorics on Words with Walnut*. Cambridge University Press, 2022.
- [28] A. M. Shur. The structure of the set of cube-free \mathbb{Z} -words in a two-letter alphabet (Russian). *Izv. Ross. Akad. Nauk Ser. Mat.* **64** (2000), 201–224. English translation in *Izv. Math.* **64** (2000), 847–871.
- [29] N. J. A. Sloane et al. The on-line encyclopedia of integer sequences, 2022. Available at <https://oeis.org>.
- [30] A. Thue. Über die gegenseitige Lage gleicher Teile gewisser Zeichenreihen. *Norske vid. Selsk. Skr. Mat. Nat. Kl.* **1** (1912), 1–67. Reprinted in *Selected Mathematical Papers of Axel Thue*, T. Nagell, editor, Universitetsforlaget, Oslo, 1977, pp. 413–478.