

Maximum Independent Set Formation on a Finite Grid by Myopic Robots

Raja Das
rajad.math.rs@jadavpuruniversity.in
Jadavpur University
Kolkata, India

Avisek Sharma
aviseks.math.rs@jadavpuruniversity.in
Jadavpur University
Kolkata, India

Buddhadeb Sau
buddhadeb.sau@jadavpuruniversity.in
Jadavpur University
Kolkata, India

ABSTRACT

This work deals with the Maximum Independent Set (MIS) formation problem in a finite rectangular grid by autonomous robots. Suppose we are given a set of identical robots, where each robot is placed on a node of a finite rectangular grid \mathcal{G} such that no two robots are on the same node. The MIS formation problem asks to design an algorithm, executing which each robot will move autonomously and terminate at a node such that after a finite time the set of nodes occupied by the robots is a maximum independent set of \mathcal{G} . We assume that robots are anonymous and silent, and they execute the same distributed algorithm.

Previous works solving this problem used one or several door nodes through which the robots enter inside the grid or the graph one by one and occupy required nodes. In this work, we propose a deterministic algorithm that solves the MIS formation problem in a more generalized scenario, i.e., when the total number of required robots to form an MIS are arbitrarily placed on the grid. The proposed algorithm works under a semi-synchronous scheduler using robots with only 2 hop visibility range and only 3 colors.

KEYWORDS

Myopic robot, Maximum Independent Set, Finite Grid, Autonomous robots, Robot with lights, Distributed algorithms

ACM Reference Format:

Raja Das, Avisek Sharma, and Buddhadeb Sau. 2018. Maximum Independent Set Formation on a Finite Grid by Myopic Robots. In *Proceedings of Make sure to enter the correct conference title from your rights confirmation email (Conference acronym 'XX)*. ACM, New York, NY, USA, 10 pages. <https://doi.org/XXXXXXX.XXXXXXX>

1 INTRODUCTION

Consider a rectangular area R as a bounded region in the two-dimensional Euclidean plane. We embed a rectangular grid graph \mathcal{G} in that rectangular area R . Let a robot with sensing capability stay on the nodes of \mathcal{G} . Let depending on the sensing radius of the robot, the grid is embedded in such a way that, being placed on a node a robot can sense its immediate upward, immediate downward, immediate left, and immediate right neighbour node along with

Permission to make digital or hard copies of all or part of this work for personal or classroom use is granted without fee provided that copies are not made or distributed for profit or commercial advantage and that copies bear this notice and the full citation on the first page. Copyrights for components of this work owned by others than ACM must be honored. Abstracting with credit is permitted. To copy otherwise, or republish, to post on servers or to redistribute to lists, requires prior specific permission and/or a fee. Request permissions from permissions@acm.org.
Conference acronym 'XX, June 03–05, 2018, Woodstock, NY

© 2018 Association for Computing Machinery.
ACM ISBN 978-1-4503-XXXX-X/18/06...\$15.00
<https://doi.org/XXXXXXX.XXXXXXX>

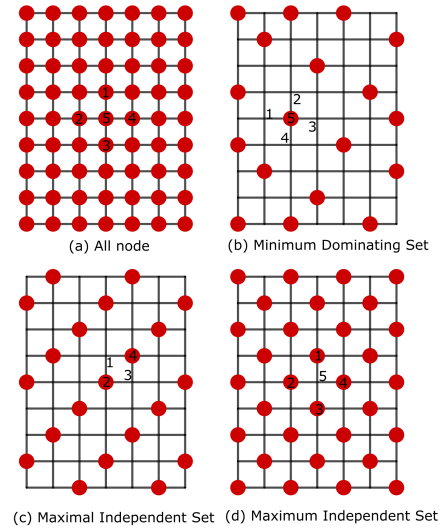

Figure 1: Various methods of covering

its position completely. Let a robot can move to its immediate upward, immediate downward, immediate left, and immediate right neighbour nodes through the edges of \mathcal{G} . Now we want to place a set of robots on some nodes of \mathcal{G} such that each node of \mathcal{G} is sensed by at least one robot. Now cost and resilience are the major parameters to consider. We can accomplish the target in different ways. One way can be by putting robots at each node. In this way, to disconnect a node we have to disable five robots. Here the resilience is highest but the cost is maximum (See Fig. 1(a)). If we put robots on a minimum dominating set of \mathcal{G} then disabling one robot will disconnect five nodes. Here the cost is minimum but resilience is the lowest (See Fig. 1(b)). If we put robots on a maximal independent set of \mathcal{G} then disabling two robots can disconnect at most four nodes. The number of robots required in this case is one-third of the number of nodes and this method gives a decent resilience (See Fig. 1(c)). If we put robots on a maximum independent set of \mathcal{G} then disabling four robots can disconnect at most five nodes. The number of robots required in this case is half of the number of nodes and this method gives good resilience (See Fig. 1(d)). So in this work, we consider robots placing on a maximum independent set of \mathcal{G} .

In this paper, we give an algorithm of Maximum Independent Set (MIS) formation on a finite grid. Let a swarm of autonomous robots is placed initially on the distinct nodes of \mathcal{G} . The MIS formation problem asks the robots to rearrange and take positions such that the robot occupied nodes form a MIS of \mathcal{G} . The robots work

autonomously, which means they work without any central control. The robots are homogeneous (i.e., they all run the same algorithm), identical (indistinguishable), and anonymous (without any identifier). Such robot swarms can have the capability to do certain tasks like gathering, dispersion, exploration, pattern formation, filling, etc. In some cases, robots have memory and can communicate with other robots. Based on these powers there are four types of robot models which are *OBLLOT*, *FSTA*, *FCOM*, *LUMI*. In *OBLLOT* model robots are silent (no communication) and oblivious (no persistent memory). In *FSTA* model robots are silent and non-oblivious. In *FCOM* model robots can communicate but are oblivious. In *LUMI* model robots can communicate and are non-oblivious. Robots can have a finite bit of memory which is generally interpreted as a finite number of lights that can take finitely many different colors. Seeing own light is equivalent to having memory and seeing the lights of other robots is equivalent to communication. After activation, each robot follows a look-compute-move (LCM) cycle. In the look phase, the robot takes a snapshot of its surrounding in its vicinity and gets the position and states of other robots. In compute phase it runs the algorithm and gets an output. In the move phase, the robot moves to its destination node or stays at the same node depending on the output. Activation plays a big role and it is determined by the scheduler. There are generally three types of schedulers. These are (1) fully synchronous scheduler where the time is divided into global rounds and each robot work activates in each round and simultaneously executes their LCM cycle; (2) Semi synchronous scheduler where also the time is divided into global rounds but some robots activate in a round and simultaneously execute their LCM cycle; (3) Asynchronous scheduler where there is no common notion of time among robots and all robots execute their LCM cycle independently.

Vision is an important factor in performing these tasks. In [1–4] infinite visibility has been used. But infinite visibility is not practically possible due to hardware limitations. Limited visibility is more practical. Under limited visibility, a robot can see up to a certain distance in a plane and up to a certain hop in discrete space. In our work, we consider *LUMI* model robots with 2 hop visibility range and 3 colors under a semi-synchronous scheduler. The robots agree on the two directions and their orientations, one which is parallel to rows of \mathcal{G} and another which is parallel to the columns of \mathcal{G} . Hence each robot can determine its four directions. In this work, we propose an *MIS* formation algorithm for a robot swarm, which is initially placed arbitrarily on the nodes of the grid. We show that the proposed algorithm forms *MIS* under a semi-synchronous scheduler using robots having only two hop visibility and a light that can take three distinct colors. The next section describes all relevant works and discusses the scope of our work.

1.1 Related Works and Our Contributions

Using swarm robotics various types of problems have been studied like exploration [4, 11], gathering [3, 6], dispersion [8–10], pattern formation [1, 2, 5] under different model. In [1–4] robots are considered to have infinite visibility. But infinite visibility is not practically possible due to hardware limitations. Limited visibility is more practical. Robots with limited visibility are called *myopic*

robots. Myopic robots have been used in [6, 7, 11, 14]. A lot of problems [1, 3, 4, 7, 9, 12, 13] have been explored under grid graph. *MIS* formation on a finite grid can be seen from two perspectives. One perspective is the deployment of robots through a door node. Another perspective is pattern formation. As of our knowledge, there is no algorithm for arbitrary pattern formation in a finite grid graph. To the best of our knowledge, there are only two reported work [7, 14] which considers *MIS* formation problem on a graph using an autonomous robot swarm. [7] have given an *MIS* filling algorithm using robots having light with three colors, 2 hop visibility for fully oriented finite grid under asynchronous scheduler. In another algorithm, they have solved the same problem using robots with seven light colors, and 3 hop visibility under an asynchronous scheduler but in an unoriented grid. [14] have given an *MIS* filling algorithm for arbitrary graph with one door node using $(\Delta+6)$ light color, 3 hop visibility, $O(\log(\Delta))$ bits of persistent storage under asynchronous scheduler. In another algorithm they have solved the same problem with $k(> 1)$ door nodes using $(\Delta+k+6)$ light color, 5 hop visibility, $O(\log(\Delta+k))$ bits of persistent storage under semi synchronous scheduler. Another set of works is [12, 13] which are remotely related to *MIS* formation problem. [13] solves the uniform scattering problem under an asynchronous scheduler and [12] solves the uniform scattering problem under a fully synchronous scheduler on a finite rectangular grid considering myopic robots. However, *MIS* formation can not be achieved by any special case or slight modification of these works.

Table 1: Comparison table

Work	Visibility range (hop)	Scheduler	Door number	Graph Topology	Internal Memory	Color number
1 st algorithm in [7]	2	ASync	1	oriented rectangular grid	None	3
2 nd algorithm in [7]	3	ASync	1	unoriented rectangular grid	None	7
1 st algorithm in [14]	3	ASync	1	Arbitrary connected Graph	$O(\log(\Delta))$	$\Delta+6$
2 nd algorithm in [14]	5	SSync	$k > 1$	Arbitrary connected Graph	$O(\log(\Delta+6))$	$\Delta+k+6$
Our Algorithm	2	SSync	None (Arbitrary initial deployment)	oriented rectangular grid	None	3

In this paper from the motivation of finding a robust but cost-effective coverage of a rectangular region, we give an algorithm to form an *MIS* pattern on a rectangular finite grid by luminous robots under a semi-synchronous scheduler. In contrast to [7, 14], our proposed algorithm does not use the door concept and allows to form of an *MIS* starting from any initial configuration. Thus, this work generalizes the initial condition of the work in [7, 14] for rectangular grid topology. Also, there can be practical scenarios where the door concept is not possible to implement. Suppose the robots are arbitrarily placed on the grid initially. If one wants to

convert it to a door concept scenario then all robots need to gather at a corner, which might not be possible if the robots are not point robots. One might argue that all initial positions of robots can be considered as different doors and compare it with the multi-door algorithm of [14] which works under a semi-synchronous scheduler. But compared with that, our algorithm uses only a constant memory. The proposed algorithm in our work uses robots having lights that can take only three colors. The multi-door algorithm in [14] uses 5 hop visibility for robots whereas our algorithm only uses two hop visibility. A comparison table Table 1 (In this table, Δ denotes the maximum degree of a graph) is presented to clarify the scope of this work.

Outline of the Paper. Section 2 discusses the model and provides the problem definition. Section 3 presents our proposed algorithm and also proves its correctness. Finally, the section 4 gives the concluding remarks and discusses the future scope of our work.

2 MODEL AND PROBLEM DEFINITION

We consider the robots equipped with motion actuators and visibility sensors. These robots move on a simple undirected connected graph $\mathcal{G} = (V, E)$, where V is a finite set of $p = m \times n$ nodes and E is a finite set of $q = (m - 1) \times n + m \times (n - 1)$ edges. m and n are positive integers greater than 1. Robots can stay on the nodes only. Robots can sense their surrounding nodes and can move through edges. We assume that \mathcal{G} is an $m \times n$ rectangular grid embedded on a plane, where m is the number of rows and n is the number of columns. We call the topmost row as 1^{st} row, then the second row from the top as 2^{nd} row, and so on. Similarly, we call the leftmost column as 1^{st} column, then the second column from the left as 2^{nd} column, and so on. We can think the grid as an $m \times n$ matrix, where the $(i, j)^{th}$ entry of the matrix represents the node on i^{th} row and j^{th} column of the grid. \mathcal{G} satisfies the following condition: there exists an order on the nodes of $V = \{v_1, v_2, v_3, \dots, v_p\}$, such that

- $\forall x \in \{1, 2, \dots, p\}, (x \neq 0 \pmod{n}) \implies \{v_x, v_{x+1}\} \in E$
- $\forall y \in \{1, 2, \dots, (m - 1) \times n\}, \{v_y, v_{y+n}\} \in E$.

We assume that the size of the rectangular grid is unknown to the robots. We consider the leftmost column, rightmost column, uppermost row, and lowermost row as the west boundary, east boundary, north boundary, and south boundary respectively.

Each robot on activation executes a look-compute-move (L-C-M) cycle. In the look phase, a robot takes a snapshot of its surrounding in its vicinity. In compute phase it runs an inbuilt algorithm taking the snapshot and its previous state (if the robot is not oblivious) as an input. Then it gets a color and a position as an output. In the move phase, the robot changes its color if needed and moves to its destination node or stays at the same node.

Scheduler: There are generally three types of schedulers, which are fully synchronous, semi-synchronous, and asynchronous. In a synchronous scheduler, the time is equally divided into different rounds. The robots activated in a round execute the L-C-M cycle and each phase of the L-C-M cycle is executed simultaneously by all the robots. That means, all the active robots in a round take their snapshot at the same moment, and, Compute phase and Move phase are considered to happen instantaneously. Under a fully synchronous scheduler, each robot gets activated and executes the

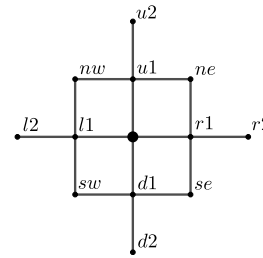

Figure 2: View of a robot with two hop visibility

L-C-M cycle in every round. Under semi synchronous scheduler a nonempty set of robots gets activated in a round. An adversary decides which robot gets activated in a round. In a fair adversarial scheduler, each robot gets activated infinitely often. Under an asynchronous scheduler, there is no common notion of time for the robots. Each robot independently gets activated and executes its L-C-M cycle. In this scheduler Compute phase and Move phase of robots take a significant amount of time. The time length of L-C-M cycles, Compute phases and Move Phases of robots may be different. Even the time length of two L-C-M cycles of one robot may be different. The gap between two consecutive L-C-M cycles or the time length of an L-C-M cycle of a robot is finite but can be unpredictably long. We consider the activation time and the time taken to complete an L-C-M cycle is determined by an adversary. In a fair adversarial scheduler, a robot gets activated infinitely often. Our work is under semi synchronous scheduler.

Visibility of robots : A robot can see all of its neighbour nodes within 2 hop distance. Thus a robot can see 13 nodes including its position. We denote the hop distance of visibility as ϕ .

The first left neighbour node, second left neighbour node, first upward neighbour node, second upward neighbour node, first right neighbour node, second right neighbour node, first downward neighbour node, second downward neighbour node, north-east neighbour node, north-west neighbour node, south-east neighbour node, south-west neighbour node of a robot are denoted by $l1, l2, u1, u2, r1, r2, d1, d2, ne, nw, se, sw$ respectively (See Figure 2).

Lights: Each robot has a light that can take three different colors. These colors are red, blue and green. The initial color of each robot is green. The blue color indicates that the robot wants to move but its desired path is stuck by other robots. The red color indicates that the robot has reached its final position and will not move further. Here onward we shall call a robot with color red (or blue or green) as red (or blue or green) robot.

Axis Agreement: All robots agree on the directions of the axis parallel to rows and the axis parallel to columns. Hence robots agree on the global notion of north, south, east, west, up, down, right, and left directions. Each robot can determine the four directions from a node.

Definition 2.1 (Maximum Independent Set). An independent set I of a graph \mathcal{G} is a set of nodes of \mathcal{G} such that no two nodes of that set are adjacent. A maximum independent set (MIS) of \mathcal{G} is an independent set of the largest possible size.

Consider an $m \times n$ rectangular grid \mathcal{G} where $m (\geq 2)$ is the number of rows and $n (\geq 2)$ is the number of columns present in the grid. We

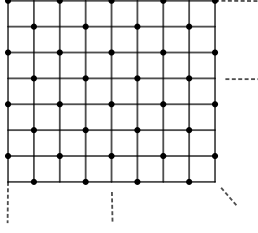

Figure 3: Black dots represent the nodes of the set S

give coordinates to the grid nodes. The coordinates of a grid node on i^{th} row and j^{th} column are (i, j) . We consider a set S of grid nodes having coordinates $\{(s, t) \in \{1, \dots, m\} \times \{1, \dots, n\} : s \equiv t \pmod{2}\}$. The nodes of the set S are depicted in the Figure 3. One can calculate that S contains $\lceil \frac{m \times n}{2} \rceil$ nodes. In next Proposition 2.2 we show that S is an MIS of \mathcal{G} .

PROPOSITION 2.2. *The set S of nodes described above forms an MIS of \mathcal{G} .*

PROOF. It is very easy to verify that no two nodes of S are adjacent, so S is an independent set of \mathcal{G} . If possible let there be an independent set of sizes more than $|S|$. Then there is an independent set S' of \mathcal{G} of size $p = |S| + 1$. Now we have two exhaustive cases; either mn is even or mn is odd.

Case-I: (mn is even) Without loss of generality we assume that n is even. In this case $p = \frac{mn}{2} + 1$. From pigeon hole principle there is at least one row which consist $\lceil \frac{p}{m} \rceil = \frac{n}{2} + 1$ nodes of S' . If a row consists $\frac{n}{2} + 1$ nodes of S' , then there will be at least two nodes of S' on that row that are adjacent to each other. This contradicts the fact that S' is an independent set.

Case-II: (mn is odd) In this case, m and n both are odd. Therefore $p = \frac{mn+1}{2} + 1$. Since S' is an independent set, so a row of \mathcal{G} can contain at most $\frac{n+1}{2}$ nodes of S' . We call the rows containing $\frac{n+1}{2}$ nodes of S' as a row of *type-A*. We call the rows containing less than $\frac{n+1}{2}$ nodes of S' as a row of *type-B*. Let there be k rows of *type-A*, then there are $m - k$ rows of *type-B*. Since S' is an independent set, so all rows cannot be of *type-A*. Therefore $m - k > 0$. Now, in total *type-A* rows contain $k \times \frac{n+1}{2}$ nodes of S' . Therefore $m - k$ rows of *type-B* contain remaining

$$\frac{mn+1}{2} + 1 - (k \times \frac{n+1}{2}) = \frac{(m-k)n+3-k}{2}$$

nodes of S' . Then from pigeon hole principle there is at least a row of *type-B* that contains

$$\lceil \frac{(m-k)n+3-k}{2(m-k)} \rceil > \frac{n-1}{2}$$

nodes of S' , which is a contradiction.

Hence there is no independent set of \mathcal{G} having a size more than $|S|$. Therefore S is an MIS of \mathcal{G} . \square

We define u_i as the number of nodes of S present in the i^{th} row of the grid. If n is even then $u_i = \frac{n}{2}$. For odd n , $u_i = \frac{n+1}{2}$ if i is odd and $u_i = \frac{n-1}{2}$ if i is even. We assume that initially $|S| = \lceil \frac{m \times n}{2} \rceil$ robots are present arbitrarily on different nodes of the rectangular

grid such that there can be at most one robot on a node of the rectangular grid. Next, we state the problem formally.

Definition 2.3 (MIS formation problem). Suppose a set of finite robots are placed arbitrarily at distinct nodes of a finite rectangular grid \mathcal{G} . The MIS formation problem requires the robots to occupy distinct nodes of \mathcal{G} and settle down avoiding collision such that the set of occupied nodes of \mathcal{G} is a maximum independent set of \mathcal{G} .

The next section provides a proposed algorithm that solves MIS formation problem.

3 MIS FORMATION ALGORITHM

This section provides an algorithm namely, MIS Formation Algorithm that claims to solve the MIS formation problem. Different views of a robot are depicted in different figures in this section. In the figures of this section onward green, blue and red color filled circles respectively represent green robot, blue robot and red robot. The black circle indicates a node that may or may not exist. If that node exists then it can be vacant or occupied by a robot. This means a robot can ignore black circle nodes in compute phase. The black cross indicates that the node does not exist. The black diamond indicates that the node exists. Initially, all robots are colored green.

Definition 3.1 (North-West Quadrant). Let a robot r_1 is at $(i, j)^{th}$ node of a grid. Then the nodes having coordinates $\{(x, y) : x \leq i, y \leq j\} \setminus \{(i, j)\}$ are called north-west quadrant of r_1 .

A green robot moves at left by maintaining at least 2 hop distance from its left robot until it reaches the west boundary. After reaching the west boundary it moves upward by keeping at least 2 hop distance from its upward robot. In this way, a robot will be fixed at the northwest corner node and will be fixed first. green robots move left by maintaining the necessary distance from their left robot until it reaches the east boundary or near a red robot (See Fig. 6).

Then it moves upward by maintaining the necessary distance from its upward robot until it reaches the north boundary or near a red robot (See Fig. 8).

Thus the robot reaches a suitable node from which it can see the necessary view to becoming red (See Fig. 9).

Definition 3.2 (Fixed robot). When a robot becomes red, it does not move any more according to the MIS Formation Algorithm 1. This robot is called a fixed robot.

If a green robot r_a sees that its $l1$ (if r_a is at north boundary) or $u1$ (if r_a is at west boundary) or both (if r_a is neither at north boundary nor at west boundary) neighbour nodes are occupied by red robots and r_a can not move upward or left then there are two possibilities.

Case-1: If $r1$ (if r_a is not at east boundary) or $d1$ (if r_a is at east boundary) neighbour node of r_a is vacant then it will move 1 hop right (if r_a is not at east boundary) or 1 hop down (if r_a is at east boundary) (See Fig. 10) or (See Fig. 11).

Case-2: If $r1$ (if r_a is not at east boundary) or $d1$ (if r_a is at east boundary) neighbour node of r_a is occupied by a robot then r_a will turn into blue indicating that it has been stuck and wants to

move right (if r_a is not at east boundary) or down (if r_a is at east boundary) but can not move (See Fig. 13).

Now if a green robot r_b sees its $l1$ neighbour node is occupied by a blue robot r_a then there are following cases.

Case-1: If $r1$ (if r_b is not at east boundary) neighbour node of r_b is vacant or $d1$ (if r_b is at east boundary) neighbour node of r_b is vacant then it will move 1 hop right (if r_b is not at east boundary) or 1 hop down (if r_b is at east boundary) (See Fig. 14) or (See Fig. 7).

Case-2: If $r1$ (if r_b is not at east boundary) neighbour node of r_b is not vacant or $d1$ (if r_b is at east boundary) neighbour node of r_b is not vacant.

Case-2.1: If $u1$ and $u2$ neighbour node of r_b is vacant then r_b will move upward by keeping necessary distance from its upward robot until it reaches north boundary or near a red robot (See Fig. 16).

Case-2.2: If $u1$ or $u2$ neighbour node of r_b is occupied by a non red robot then r_b will do nothing.

Case-2.3: If one of $u1$ and $u2$ neighbour node of r_b is occupied by a red robot and another is vacant then it will turn blue (See Fig. 17).

If a green robot r_d which is on the east boundary sees its $u1$ neighbour node is occupied by a blue robot r_c then there are following cases.

Case-1: $l1$ and $l2$ neighbour node of r_d both are vacant then r_d will move 1 hop left.

Case-2: Anyone between $l1$ and $l2$ neighbour node of r_d or both are non vacant.

Case-2.1: If $d1$ neighbour node of r_d is vacant then r_d will move 1 hop down (See Fig. 15).

Case-2.2: If $d1$ neighbour node of r_d occupied by a green robot then r_d will turn into blue (See Fig. 18).

Definition 3.3 (Blue Sequence). If a node or some consecutive nodes of a row or east boundary or both in a rectangular grid are occupied by blue robots then the $-$ or \rightarrow or $|$ like sequence of consecutive blue robots is called a blue sequence.

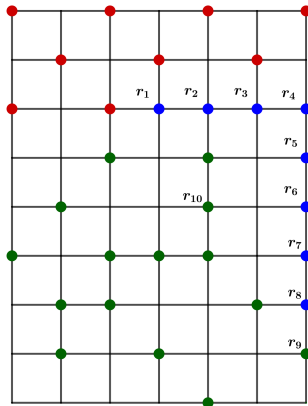

Figure 4: Blue Sequence and Adjacent green Robot

In Fig. 4 the robots $r_1, r_2, r_3, r_4, r_5, r_6, r_7, r_8$ forms the blue sequence.

A blue sequence can proceed till the $(m-1, n)^{th}$ node at most. If the $(m, n)^{th}$ node is occupied by some robot, that robot will never be blue since its $d1$ neighbour node does not exist and the existence

of $d1$ neighbour node is necessary to become blue for the robots present in the east boundary.

Definition 3.4 (Adjacent Green Robot). Consider the blue sequence will not proceed further. If the blue sequence ends before the east boundary then the green robot at the $r1$ neighbour node of the rightmost blue robot of the sequence and if the blue sequence continues through east boundary then the green robot at the $d1$ neighbour node of the downmost blue robot of the sequence present in the east boundary is called the adjacent green robot of the blue sequence.

In Fig. 4 r_9 is the adjacent green robot of the blue sequence.

Definition 3.5 (Predecessor Blue Robots). Consider a blue robot r_k of a blue sequence. All the robots which became blue in that blue sequence before the round in which r_k became blue, are called the predecessor blue robots of r_k in that blue sequence.

In Fig. 4 r_1, r_2, r_3, r_4 and r_5 are the predecessor blue robots of r_6 .

If a blue robot r_e which is not at the east boundary sees its $r1$ neighbour node is vacant then it turns green and moves 1 hop right (See Fig. 12).

If a blue robot r_e which is at the east boundary sees its $l1, l2$ and $d1$ neighbour nodes then there are following cases.

Case-1: Both $l1$ and $l2$ neighbour nodes of r_e are vacant then r_e turns green and move 1 hop left (See Fig. 19).

Case-2: Any one between $l1$ and $l2$ neighbour nodes of r_e is not vacant and its $d1$ neighbour node is vacant then it turns green and move 1 hop down (See Fig. 20).

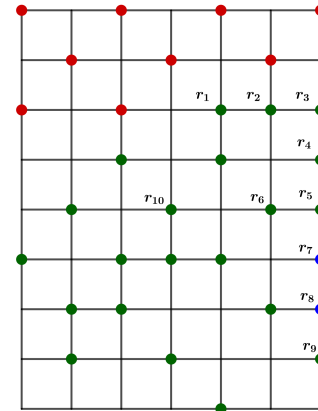

Figure 5: Tail and After 1 hop shifting

Definition 3.6 (Tail). If the blue sequence continues through east boundary and a blue robot of the sequence from the east boundary leaves the sequence by moving left then the remaining blue robots of the sequence below the leaving blue robot will be called tail.

In Fig. 5 r_7, r_8 is the tail after r_6 leaves the blue sequence.

Definition 3.7 (1 Hop Shifting). If the adjacent green robot or any robot of the blue sequence moves from its position then each of its predecessor blue robots moves 1 hop to fill the vacant node

and to make the starting node of the blue sequence vacant. This is called 1 hop shifting of the blue sequence.

In Fig. 5 1 hop shifting of the blue sequence of Fig. 4 has been done after the robot r_6 moves 1 hop left and makes its position vacant.

If a blue robot r_e which is at the east boundary sees its $u1$ neighbour node is vacant and $l1$ neighbour node is not occupied by a blue robot then it turns green (See Fig. 21).

If a blue robot r_e which is at the east boundary sees its $u1$ neighbour node is occupied by a red robot and $l1$ neighbour node is vacant then it turns green (See Fig. 21).

If a blue robot r_e which is at the east boundary sees its $u1$ neighbour node is occupied by a green robot then it turns green (See Fig. 21).

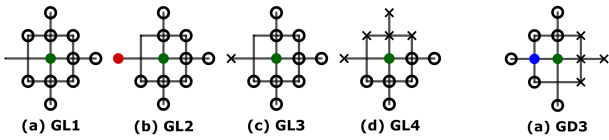

Figure 6

Figure 7

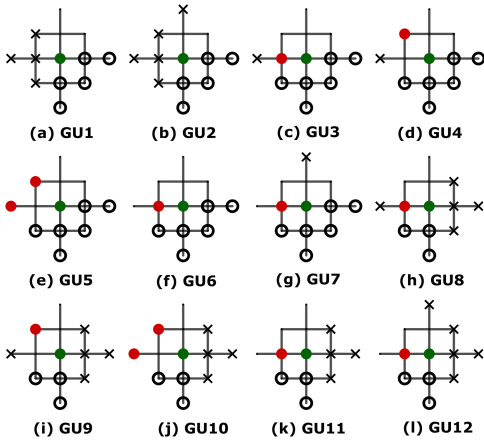

Figure 8

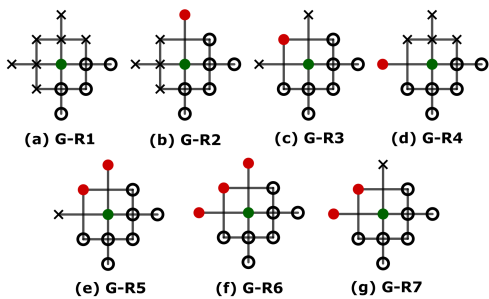

Figure 9

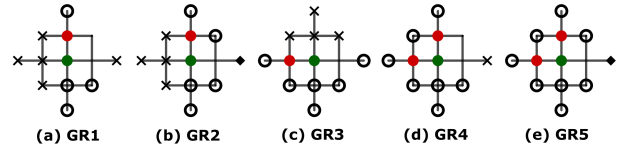

Figure 10

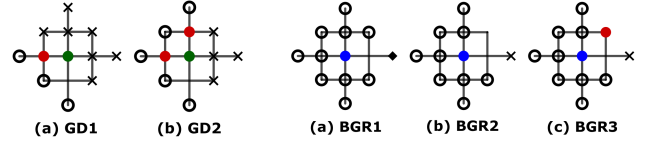

Figure 11

Figure 12

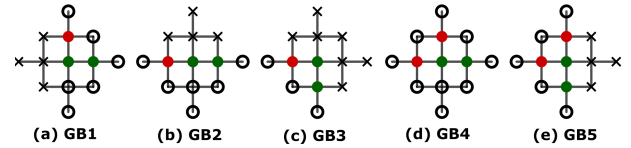

Figure 13

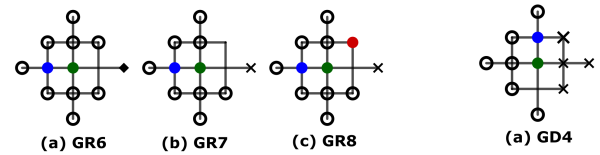

Figure 14

Figure 15

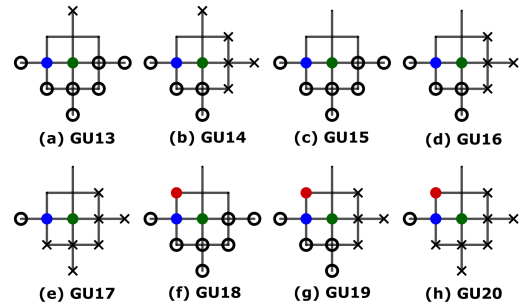

Figure 16

Now we define some sets of views.

$$G_1 = \{GL1, GL2, GL3, GL4\} \quad G_2 = \{GD1, GD2, GD3, GD4\}$$

$$G_3 = \{GR1, GR2, GR3, GR4, GR5, GR6, GR7, GR8\}$$

$$G_4 = \{GU1, GU2, GU3, GU4, GU5, GU6, GU7, GU8, GU9, GU10, GU11, GU12, GU13, GU14, GU15, GU16, GU17, GU18, GU19, GU20\}$$

$$G_5 = \{GB1, GB2, GB3, GB4, GB5, GB6, GB7, GB8, GB9, GB10, GB11, GB12, GB13, GB14\}$$

$$G_6 = \{G-R1, G-R2, G-R3, G-R4, G-R5, G-R6, G-R7\}$$

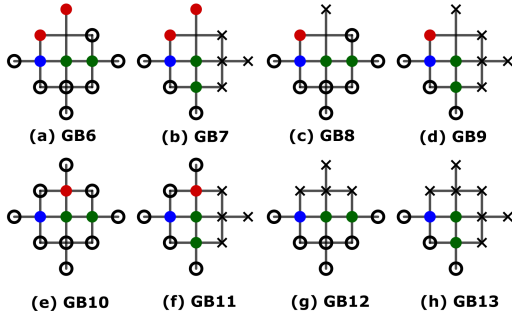

Figure 17

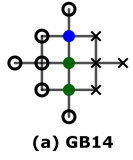

Figure 18

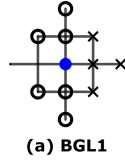

Figure 19

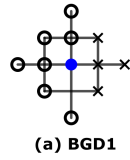

Figure 20

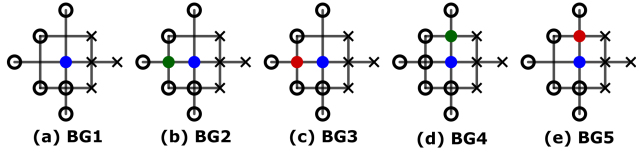

Figure 21

$$\begin{aligned}
 B_1 &= \{\mathbf{BGR1}, \mathbf{BGR2}, \mathbf{BGR3}\} & B_2 &= \{\mathbf{BGL1}\} \\
 B_3 &= \{\mathbf{BGD1}\} & B_4 &= \{\mathbf{BG1}, \mathbf{BG2}, \mathbf{BG3}, \mathbf{BG4}, \mathbf{BG5}\}
 \end{aligned}$$

3.1 Correctness Proofs

THEOREM 3.8. *There are no collisions of robots while executing the MJS Formation Algorithm.*

PROOF. There can be two types of collisions.

Type-1: There is a robot present already in a node and another robot comes to that node.

Type-2: More than one robot, each from a different node comes to a particular vacant node.

According to the MJS Formation Algorithm no robot moves to a node that is already occupied. So there is no collision of Type-1.

According to the MJS Formation Algorithm, there are four types of movement of a robot i.e. left move(\mathcal{L}), right move(\mathcal{R}), upward move(\mathcal{U}) and downward move(\mathcal{D}). Considering all possible combinations there can be six different collisions i.e. (\mathcal{LR}), (\mathcal{LU}), (\mathcal{LD}), (\mathcal{RU}), (\mathcal{RD}), (\mathcal{UD}).

(\mathcal{LR}): A robot will move left if its view belongs to G_1 or B_2 . From Fig. 6 and Fig. 19 it is clear that for (\mathcal{L}) movement of a robot r , $l1$ neighbour node of r will always remain vacant and $l2$ neighbour node of r is vacant or occupied by a red robot or does not exist.

Algorithm 1: MJS Formation

Data: Positions and colors of robots within 2 hop distance

Result: One color and one destination point

```

if col( $r$ ) is green then
  if view( $r$ )  $\in$   $G_1$  then
    | Move left
  else if view( $r$ )  $\in$   $G_2$  then
    | Move downward
  else if view( $r$ )  $\in$   $G_3$  then
    | Move right
  else if view( $r$ )  $\in$   $G_4$  then
    | Move upward
  else if view( $r$ )  $\in$   $G_5$  then
    | Change color to blue
  else if view( $r$ )  $\in$   $G_6$  then
    | Change color to red
  else
    | Do nothing
else if col( $r$ ) is blue then
  if view( $r$ )  $\in$   $B_1$  then
    | Change color to green and move right
  else if view( $r$ )  $\in$   $B_2$  then
    | Change color to green and move left
  else if view( $r$ )  $\in$   $B_3$  then
    | Change color to green and move downward
  else if view( $r$ )  $\in$   $B_4$  then
    | Change color to green
  else
    | Do nothing
else
  | Do nothing

```

There is no robot which will move to $l1$ neighbour node of r by (\mathcal{R}) movement. So there is no (\mathcal{LR}) collision.

(\mathcal{LU}): A robot will move upward if its view belongs to G_4 . From Fig. 16 and Fig. 8 it is clear that for (\mathcal{U}) movement of a robot r , ne neighbour node of r is vacant or does not exist. There is no robot which will move to $u1$ neighbour node of r by (\mathcal{L}) movement. So there is no (\mathcal{LU}) collision.

(\mathcal{LD}): A robot will move downward if its view belongs to G_2 or B_3 . From Fig. 20, Fig. 7, Fig. 15 and Fig. 11 it is clear that for (\mathcal{D}) movement of a robot r , se neighbour node of r does not exist. There is no robot which will move to $d1$ neighbour node of r by (\mathcal{L}) movement. So there is no (\mathcal{LD}) collision.

(\mathcal{RU}): A robot will move upward if its view belongs to G_4 . From Fig. 8 and Fig. 16 it is clear that for (\mathcal{U}) movement of a robot r , nw neighbour node of r is vacant or occupied by a red robot or does not exist. There is no robot which will move to $u1$ neighbour node of r by (\mathcal{R}) movement. So there is no (\mathcal{RU}) collision.

(\mathcal{RD}): A robot will move downward if its view belongs to G_2 or B_3 . From Fig. 20, Fig. 7, Fig. 15 and Fig. 11 it is clear that (\mathcal{D}) movement of a robot is possible through east boundary only. A robot will move right if its view belongs to G_3 or B_1 . From Fig. 14, Fig. 10 and Fig. 12 it is clear that for (\mathcal{R}) movement of a robot r , if $r1$ neighbour node of r is on east boundary then ne neighbour node of r is vacant or occupied by a red robot else $r1$ neighbour node of r is not on east boundary. There is no robot which will move to $r1$ neighbour node of r by (\mathcal{D}) movement. So there is no (\mathcal{RD}) collision.

(\mathcal{UD}): A robot will move upward if its view belongs to G_4 . From Fig. 16 and Fig. 8 it is clear that for (\mathcal{U}) movement of a robot r , $u1$ neighbour node of r is vacant and $u2$ neighbour node of r is vacant

or does not exist. There is no robot which will move to $u1$ neighbour node of r by (\mathcal{D}) movement. So there is no (\mathcal{UD}) collision. \square

LEMMA 3.9. *If all robots have turned its color to red then the set of robot occupied grid nodes forms an MIS of \mathcal{G} .*

PROOF. First we show that the set of robot occupied grid nodes is an independent set of \mathcal{G} . We show this by showing that no two red robots are adjacent. Opposite to our claim, let there be two adjacent red robots r_1 and r_2 . If r_1 and r_2 are on the same column then let r_2 be the robot below r_1 and if r_1 and r_2 are on the same row then let r_2 be the robot right to r_1 . Let r_1 and r_2 change its color to red in k_1^{th} and k_2^{th} round respectively. Now there can be two possibilities.

Case-I: ($k_1 \leq k_2$) Since red robots never move, so throughout k_2^{th} round the r_1 robot is at the $u1$ or $l1$ neighbour node of r_2 . According to our proposed algorithm, r_2 will change its color to red if it sees any view belongs to the set G_6 . But no view in G_6 allows the $u1$ or $l1$ neighbour node of r_2 to be occupied by a robot. So this leads to a contradiction.

Case-II: ($k_1 > k_2$) In this case r_2 becomes red and gets fixed before r_1 . Hence the $l2$, $u2$ and nw neighbours of r_2 must be occupied by red robots if these neighbour nodes exist and it sustains in k_1 round also (since red robots never move). If r_1 robot is at $u1$ (or, $l1$) neighbour node of r_2 , then $u1$ (or, $l1$) neighbour node of r_2 exists. Hence view of r_2 at k_2^{th} round must be one of **G-R2** (replace **G-R2** by **G-R4** for the case when r_1 is at $l1$ neighbour node of r_2), **G-R3**, **G-R5**, **G-R6** and **G-R7**. In all such views either $l1$ or $u1$ neighbour node of r_1 is occupied by a red robot. Hence r_1 would not change its color to red in k_1^{th} round, which is a contradiction.

Hence if all robots turn red then the robot occupied nodes form an independent set. Now the number of robots is $\lceil \frac{mn}{2} \rceil$ which is the maximum possible size of an independent set of \mathcal{G} . Since Theorem 3.8 gives that there is no collision of robots, so all the red robots must be at distinct grid nodes. So the number of robot occupied nodes after all robots turned red is also $\lceil \frac{mn}{2} \rceil$. Thus, the independent set formed by robot occupied grid nodes is an MIS. \square

LEMMA 3.10. *If a row consists three types of robots i.e. red, blue and green then the red robots will be at left, blue robots will be at middle and green robots will be at right of the row.*

PROOF. A green robot becomes red, when it sees its $l2$, nw , $u2$ neighbour nodes (if exist) are occupied by red robots and $l1$, $u1$ neighbour nodes (if exist) are vacant. So there cannot be any green or blue robot at left of a red robot. Thus red robots are at left of a row.

When a blue sequence starts then the $l1$ neighbour node (if exists) of the blue robot which became blue first, is occupied by a red robot. A blue sequence is a sequence of blue robots which are at consecutive nodes. So there is no green robot at the middle of a blue sequence.

Thus the red robots will be at left, blue robots will be at middle and green robots will be at right of the row. \square

LEMMA 3.11. *If there are $\lceil \frac{n}{2} \rceil - 2$ robots present in a row consists of $(n - 1)$ nodes, then after finite round $(n - 1)^{th}$ and $(n - 2)^{th}$ node will be vacant.*

PROOF. In a row the distance of a red robot from its immediate left or immediate right red robot is exactly 2 hop. In a row distance of a red robot from its immediate right blue robot is exactly 1 hop. In a row after finite round the distance of a green robot from its immediate left or immediate right green robot will be at most 2 hop since all green robots move left by keeping 2 hop distance. In a row distance of a blue robot which became blue last, from its immediate right green robot is exactly 1 hop. In a row distance of a blue robot from its immediate left or immediate right blue robot is exactly 1 hop. Thus by Lemma 3.10 in a row distance of a row from its immediate left or immediate right robot is at most 2 hop. Maximum possible number of robots is $\frac{n}{2} - 2$ (if n is even) or $\frac{n+1}{2} - 2$ (if n is odd). If possible we try to put the robots in such a way so that $(n - 1)^{th}$ and $(n - 2)^{th}$ node does not remain empty. If we put robots on even positioned nodes then i^{th} robot will be at $2i^{th}$ node. $(\frac{n}{2} - 2)^{th}$ robot will be at $(n - 4)^{th}$ node. $(\frac{n+1}{2} - 2)^{th}$ robot will be at $(n - 3)^{th}$ node. Thus in both cases $(n - 1)^{th}$ and $(n - 2)^{th}$ node will be vacant. \square

LEMMA 3.12. *Let r_1 be the left most non red robot in the topmost non red robot occupied row. Let r_1 be a part of a blue sequence and r_1 be the first robot which turned blue for any one view from the Fig. 13. If the blue sequence ends at $(m - 1, n)$ node then 1 hop shifting will be done.*

PROOF. If the blue sequence starts at k^{th} row, continues through east boundary and ends at $(m - 1, n)$ node then $1^{st}, 2^{nd}, \dots, i^{th}, \dots, (k - 1)^{th}$ row each contains u_i robots. k^{th} row contains more than u_k robots. $(k + 1)^{th}, (k + 2)^{th}, \dots, m^{th}$ row together will contain less than $u_{k+1} + u_{k+2} + \dots + u_m$ robots. There will be atleast one row (say p^{th} row) which will contain less than u_p robots. If more than one such row exists then consider the top most row (say l^{th} row) which contains less than u_l robots. If any robot comes from below row and makes u_l number robot in l^{th} row, then we shall consider below q^{th} row which contains less than u_q robot. If this continues since the number of rows is constant we must get such a row (say r^{th} row) where number of robots will be less than u_r and no robots will enter from below. Without loss of generality, we consider such row as l^{th} row. If n is odd then u_l is $\lceil \frac{n}{2} \rceil$ when l is odd and $\lceil \frac{n}{2} \rceil - 1$ when l is even. If n is even then u_l is $\lceil \frac{n}{2} \rceil$. If we consider l^{th} row except the east boundary node which is occupied by a blue robot or green robot then there are $(n - 1)$ nodes and atmost $\lceil \frac{n}{2} \rceil - 2$ robots. After finite round when all the robots of l^{th} row except the right most blue or green robot will be at atmost 2 hop distance from each other, $(l, n - 2)$ and $(l, n - 1)$ node will be vacant by Lemma 3.11. Then the right most robot of l^{th} row will move from (l, n) node to $(l, n - 1)$ node and 1 hop shifting will be done automatically. \square

THEOREM 3.13. *MIS Formation Algorithm forms maximum independent set after finite rounds without any collisions.*

PROOF. Consider the uppermost row which contains at least one green or blue robot. If there is no such row then every robot

present in the grid is red. Therefore by Lemma 3.9 the proof is done.

Let there exists a row (say k^{th} row) which contains at least one green or blue robot. Let r_1 be the left most non red robot on that row. r_1 can be green or blue. Note that all the robots present in the north-west quadrant of r_1 are red and they are fixed.

Case-1: r_1 is green.

r_1 continues moving left as long as it sees any views from **{GL1, GL2, GL3, GL4}** (Fig. 6). While r_1 is progressing left through the row if any green robot from below row move upwards and comes to the left of r_1 then we will consider the new robot as r_1 . If r_1 does not see any view from **{GL1, GL2, GL3, GL4}** (Fig. 6) then it must see any view from **{GB1, GB2, GB3, GB4, GB5, GD1, GD2, GR1, GR2, GR3, GR4, GR5, GU1, GU2, GU3, GU4, GU5, GU6, GU7, GU8, GU9, GU10, GU11, GU12, G-R1, G-R2, G-R3, G-R4, G-R5, G-R6, G-R7}** (Fig. 13, Fig. 11, Fig. 10, Fig. 8, Fig. 9). If r_1 sees any one view from **{GB1, GB2, GB3, GB4, GB5}** (Fig. 13) then it turns blue and goes to Case-2. If r_1 sees any one view from **{GD1, GD2}** (Fig. 11) then it will go to its $d1$ neighbour node. Now we may get a new r_1 since there may exists some non red robot at the left in the current row. Now r_1 will not move to its $d1$ neighbour node and will remain r_1 since it will not get any view from **{GD1, GD2}** (Fig. 11). If r_1 sees any one view from **{GR1, GR2, GR3, GR4, GR5}** (Fig. 10) then it will go to its $r1$ neighbour node. Now it will not see any view from **{GR1, GR2, GR3, GR4, GR5}** (Fig. 10) and **{GD1, GD2}** (Fig. 11). If r_1 sees any one view from **{G-R1, G-R2, G-R3, G-R4, G-R5, G-R6, G-R7}** (Fig. 9) then it turns red. Else r_1 will see any one view from **{GU1, GU2, GU3, GU4, GU5, GU6, GU7, GU8, GU9, GU10, GU11, GU12}** (Fig. 8) and continues moving upward until it sees any one view from **{G-R1, G-R2, G-R3, G-R4, G-R5, G-R6, G-R7}** (Fig. 9). Finally r_1 will see any one view from **{G-R1, G-R2, G-R3, G-R4, G-R5, G-R6, G-R7}** (Fig. 9) and will turn red.

Case-2: r_1 is blue.

A blue robot became blue as a part of a blue sequence. Now it is either a part of a blue sequence or a part of a tail. As r_1 is the left most non red robot in the topmost non red robot occupied row, there can be two cases.

Case-2.1: If r_1 is a part of a tail then r_1 will be at east boundary and the topmost blue robot of the tail. If we consider $l1$ and $u1$ neighbour nodes of r_1 then there can be four type of figures .

In these three types i.e. **{BG1, BG3, BG5}** (Fig. 21), at least one among $l1$ and $u1$ neighbour nodes of r_1 is not occupied by a red robot and r_1 will turn into green . The robot r_1 goes to Case-1 and this r_1 will never become blue as it was the upmost robot of a tail and all the robots which are at north-west quadrant of r_1 are red and at least one among $l1$ and $u1$ neighbour nodes of r_1 is not occupied by a red robot.

If both $l1$ and $u1$ neighbour nodes of r_1 are occupied by red robots then r_1 goes to Case 2.2 (similar to **{GB5}**) (Fig. 13).

Case-2.2: If r_1 is a part of a blue sequence then r_1 is the first robot which turned blue for any one view from the Fig. 13. The blue sequence can continue along the row and east boundary.

Case-2.2.1: If the blue sequence ends before $(m - 1, n)$ node 1 hop shifting will be done after the adjacent green robot moves from its node. 1 hop shifting would be done before it if any blue robot of the blue sequence from the east boundary moves left.

Case-2.2.2: If the blue sequence ends at $(m - 1, n)$ node 1 hop shifting will be done by Lemma 3.12.

Now r_1 will turn into green and goes to case-1. This r_1 will never become blue as its $l1$ or $u1$ neighbour node is vacant and all the robots which are at north-west quadrant of r_1 are red.

Selecting a non red robot we are making a non red robot into a red robot. Since the total number of robots is finite, after finite round all the robots will be red. Therefore by Lemma 3.9 the proof follows. \square

4 CONCLUSION

This work presents an algorithm that forms a Maximum Independent Set (MIS) on a finite rectangular grid \mathcal{G} by myopic robots. If the size of a maximum independent set of \mathcal{G} is k then initially k robots are placed arbitrarily on distinct nodes of \mathcal{G} . The robots are considered to be luminous and have a light that can take three distinct colors. We assume the robots agree on the global notion of north, south, east, and west direction. The robots have two hop visibility. The robots are controlled under an adversarial semi-synchronous scheduler. In construct to previous MIS formation algorithms the algorithm proposed in this work does not use the door concept. It allows the robots to form MIS from any arbitrary starting configuration. This generalizes the initial condition of the previous works for rectangular grid topology.

In this work, we assumed two visibility of robots, so as a future direction one can try proposing an MIS formation algorithm which only uses one hop visibility of robots. Further, it will be interesting to provide an algorithm for the same problem under an asynchronous scheduler.

REFERENCES

- [1] Kaustav Bose, Ranendu Adhikary, Manash Kumar Kundu, and Buddhadeb Sau. 2020. Arbitrary pattern formation on infinite grid by asynchronous oblivious robots. *Theoretical Computer Science* 815 (2020), 213–227.
- [2] Kaustav Bose, Manash Kumar Kundu, Ranendu Adhikary, and Buddhadeb Sau. 2021. Arbitrary pattern formation by asynchronous opaque robots with lights. *Theoretical Computer Science* 849 (2021), 138–158.
- [3] Gianlorenzo d'Angelo, Gabriele Di Stefano, Ralf Klasing, and Alfredo Navarra. 2016. Gathering of robots on anonymous grids and trees without multiplicity detection. *Theoretical Computer Science* 610 (2016), 158–168.
- [4] Stéphane Devismes, Anissa Lamani, Franck Petit, Pascal Raymond, and Sébastien Tixeuil. 2021. Terminating exploration of a grid by an optimal number of asynchronous oblivious robots. *Comput. J.* 64, 1 (2021), 132–154.
- [5] Paola Flocchini, Giuseppe Prencipe, Nicola Santoro, and Peter Widmayer. 2008. Arbitrary pattern formation by asynchronous, anonymous, oblivious robots. *Theoretical Computer Science* 407, 1-3 (2008), 412–447.
- [6] Sayaka Kamei, Anissa Lamani, Fukuhito Ooshita, Sébastien Tixeuil, and Koichi Wada. 2019. Gathering on rings for myopic asynchronous robots with lights. *arXiv preprint arXiv:1911.04757* (2019).
- [7] Sayaka Kamei and Sébastien Tixeuil. 2020. An Asynchronous Maximum Independent Set Algorithm by Myopic Luminous Robots on Grids. *arXiv preprint arXiv:2012.03399* (2020).
- [8] Ajay D Kshemkalyani, Anisur Rahaman Molla, and Gokarna Sharma. 2019. Fast dispersion of mobile robots on arbitrary graphs. In *International Symposium on Algorithms and Experiments for Sensor Systems, Wireless Networks and Distributed Robotics*. Springer, 23–40.
- [9] Ajay D Kshemkalyani, Anisur Rahaman Molla, and Gokarna Sharma. 2020. Dispersion of mobile robots on grids. In *International Workshop on Algorithms and Computation*. Springer, 183–197.
- [10] Ajay D Kshemkalyani, Anisur Rahaman Molla, and Gokarna Sharma. 2020. Efficient dispersion of mobile robots on dynamic graphs. In *2020 IEEE 40th International Conference on Distributed Computing Systems (ICDCS)*. IEEE, 732–742.
- [11] Shota Nagahama, Fukuhito Ooshita, and Michiko Inoue. 2019. Ring exploration of myopic luminous robots with visibility more than one. In *International Symposium on Stabilizing, Safety, and Security of Distributed Systems*. Springer, 256–271.

- [12] Pavan Poudel and Gokarna Sharma. 2019. Time-optimal uniform scattering in a grid. In *Proceedings of the 20th International Conference on Distributed Computing and Networking*. 228–237.
- [13] Pavan Poudel and Gokarna Sharma. 2020. Fast uniform scattering on a grid for asynchronous oblivious robots. In *International Symposium on Stabilizing, Safety, and Security of Distributed Systems*. Springer, 211–228.
- [14] Sai Vamshi Samala, Subhajit Pramanick, Debasish Pattanayak, and Partha Sarathi Mandal. 2021. Filling MIS Vertices by Myopic Luminous Robots. *CoRR* abs/2107.04885 (2021). arXiv:2107.04885 <https://arxiv.org/abs/2107.04885>