

An Enactivist-Inspired Mathematical Model of Cognition

Vadim Weinstein, Basak Sakcak, Steven M. LaValle*

June 14, 2022

Abstract

In this paper we start from the philosophical position in cognitive science known as enactivism. We formulate five basic enactivist tenets that we have carefully identified in the relevant literature as the main underlying principles of that philosophy. We then develop a mathematical framework to talk about cognitive systems (both artificial and natural) which complies with these enactivist tenets. In particular we pay attention that our mathematical modeling does not attribute contentful symbolic representations to the agents, and that the agent’s brain, body and environment are modeled in a way that makes them an inseparable part of a greater totality. The purpose is to create a mathematical foundation for cognition which is in line with enactivism. We see two main benefits of doing so: (1) It enables enactivist ideas to be more accessible for computer scientists, AI researchers, roboticists, cognitive scientists, and psychologists, and (2) it gives the philosophers a mathematical tool which can be used to clarify their notions and help with their debates.

Our main notion is that of a sensorimotor system which is a special case of a well studied notion of a transition system. We also consider related notions such as labeled transition systems and deterministic automata. We analyze a notion called *sufficiency* and show that it is a very good candidate for a foundational notion in the “mathematics of cognition from an enactivist perspective”. We demonstrate its importance by proving a uniqueness theorem about the minimal sufficient refinements (which correspond in some sense to an optimal attunement of an organism to its environment) and by showing that sufficiency corresponds to known notions such as sufficient history information spaces. In the end, we tie it all back to the enactivist tenets.

*This work was supported by a European Research Council Advanced Grant (ERC AdG, ILLUSIVE: Foundations of Perception Engineering, 101020977), Academy of Finland (projects PERCEPT 322637, CHiMP 342556), and Business Finland (project HUMOR 3656/31/2019). All authors are with the Center of Ubiquitous Computing, Faculty of Information Technology and Electrical Engineering, University of Oulu, Finland (e-mail: `firstname.lastname@oulu.fi`).

Contents

1	Introduction: Mathematizing Enactivism	3
2	Transition Systems and Sensorimotor Systems	6
2.1	Transition systems as a unifying concept	6
2.2	Information spaces and Filters	7
2.3	Sensorimotor systems	9
2.4	Quasifilters and quasipolicies	11
2.5	State-relabeled transition systems	12
2.6	Couplings of transition systems	14
2.7	Unconstrained and fully constrained SM-systems	16
2.8	Quotients of transition systems	17
3	Illustrative Examples of SM-Systems	18
4	Sufficient Refinements and Degree of Insufficiency	20
4.1	Sufficiency	21
4.2	Minimal sufficient refinements	25
4.3	Lattices of equivalence relations	25
4.4	Lattice of sufficient equivalence relations	27
4.5	Computing sufficient refinements	32
4.6	Sufficiency for coupled SM-systems	35
5	Discussion	35
	References	38

1 Introduction: Mathematizing Enactivism

The premise of this paper is to lay down a logical framework for analyzing agency in a novel way, inspired by enactivism. Classically, mathematical and logical models of cognition are in line with the cognitivist paradigm in that they rely on the notion of symbolic representation and do not emphasize embodiment or enactment (Newell & Simon, 1972; Fodor, 2008; Gallistel & King, 2009; Rescorla, 2016). Cognitivism presumes that the world possesses objective structure and the contentful information of this structure is acquired and represented by the cognitive agent. This aligns well with the classical model-theoretic paradigm. Given a first-order relational vocabulary L , an L -model is a tuple $\mathcal{M} = (M, R_0, \dots, R_k)$ where $R_i \subseteq M^{\#R_i}$ is a relation which corresponds to the relational symbol R_i . Here $\#R$ is the arity n of the relation R and $M^{\#R} = M^n$ is the set of n -tuples of elements of M which itself is just a set, as is common in model theory. The first-order language over the vocabulary L then describes relationships that can hold or not in the model. For example if R_0 and R_1 are unary relations, the formula $\exists x(R_0(x) \wedge R_1(x))$ says that there exists an element x which belongs to the interpretations of both relations R_0 and R_1 . In the cognitivist analogy, the agent possesses (“in its head”) formulas of the language and \mathcal{M} is the world or the environment of the agent. If the formulas possessed by the agent hold in \mathcal{M} , then the agent’s representation of the world is correct; otherwise, it is incorrect. Such view of cognitive agency is rejected by the enactivists either weakly or strongly depending on the branch of enactivism. For example, radical enactivism (Hutto & Myin, 2012, 2017) rejects this view strongly. Our question for this paper is: What would the mathematical logic of cognition look like, if even the radical enactivists were to accept it?

We do not take part in the cognitivist-enactivist, or the representationalist-antirepresentationalist debate (Pezzulo et al., 2011; O’Regan & Block, 2012; Gallagher, 2018; Fuchs, 2020). Rather, we take a somewhat extreme enactivist and antirepresentational view as our axiomatic starting point and as a theoretical explanatory target. Then we develop a mathematical theory that attempts to account for cognition in a way congruent with enactivism. Even though most forms of enactivism (even radical ones) have room for representation, it is not our main goal at the moment to bridge the gap between “basic minds” and “scaffolded minds”, to use terminology of (Hutto & Myin, 2017). Thus, in this terminology, we are going to explore a mathematical/logical model (only) of *basic minds*.

The following “axioms” we take as fundamentals for our work:

- (EA1) Embodiment. “From a third-person perspective the organism-environment is taken as the explanatory unit” (Gallagher, 2017). The environment, the body, and the brain are inseparable parts of the system they form by coupling; see Figure 1. They cannot be meaningfully understood in isolation from each other. “Mentality is in all cases concretely constituted by, and thus literally consists of, the extensive ways in which organisms interact with their environments, where the relevant ways of interacting involve, but are not exclusively restricted to, what goes on in brains.” (Embodiment Thesis (Hutto & Myin, 2012))
- (EA2) Groundedness. The brain does not “acquire” or “possess” contentful states, representations, or manipulate semantic information in any other way. “Mentality-constituting interactions are grounded in, shaped by, and explained by nothing more, or other, than the history of an organism’s previous interactions. Nothing other than its history of

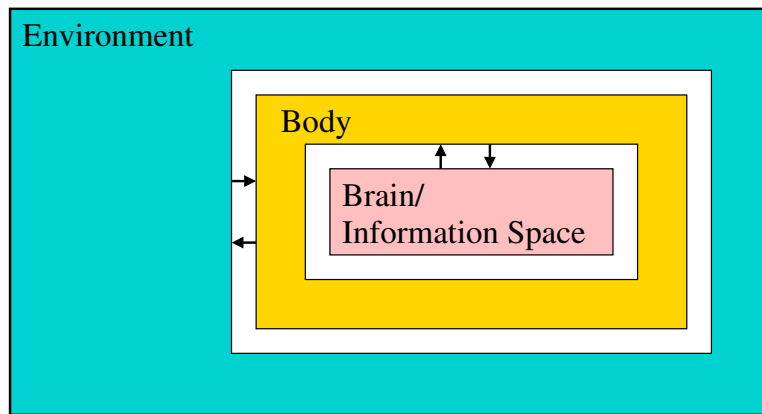

Figure 1: The environment, body, and brain will be modeled as inseparable parts of a coupled transition system.

active engaging structures or explains an organism’s current interactive tendencies.” (Developmental-Explanatory Thesis (Hutto & Myin, 2012)).

- (EA3) Emergence. The crucial properties of the brain-body-environment system from the point of view of cognition emerge from the embodiment, the brain-body-environment coupling, the situatedness, and the skills of the agent. The agent’s and the environment’s prior structure come together to facilitate new structure which emerges through the sensorimotor engagement. “[T]he mind and world arise together in enaction, [but] their manner of arising is not arbitrary” (i.e., structured) (Varela, Rosch, & Thompson, 1992)
- (EA4) Attunement. Agents differ in their ways of attunement and adaptation to their environments, and in the skills they have. A *skill* is a potential possibility to engage *reliably* in complex sensorimotor interactions with the environment. (Gallagher, 2017)
- (EA5) Perception. Sensing and perceiving are not the same thing. Perception arises from skillful sensorimotor activity. To perceive is to become better attuned to the environment. (O’Regan & Noë, 2001; Noë, 2004) “Perception and action, sensorium and motorium, are linked together as successively emergent and mutually selecting patterns”. (Varela et al., 1992).

The mathematics we use to capture those ideas is a mixture of known and new concepts from logic, theoretical robotics, (non-)deterministic automata and transition systems theory, Kripke model theory, team semantics, and dynamical systems. It will also build upon the *information spaces* framework, introduced in (LaValle, 2006) as a unified way to model sensing, actuation, and planning in robotics; the framework itself builds upon earlier ideas such as dynamic games with imperfect information (Başar & Olsder, 1995; von Neumann & Morgenstern, 1944), control with imperfect state information (Bertsekas, 2001; Kumar & Varaiya, 1986), knowledge states (Erdmann, 1993; Lozano-Pérez, Mason, & Taylor, 1984), perceptual equivalence classes (Donald & Jennings, 1991; Donald, 1995), maze and graph-exploring automata (Blum & Kozen, 1978; Fraigniaud, Ilcinkas, Peer, Pelc, & Peleg, 2005; Shannon, 1952), and belief spaces (Kaelbling, Littman, & Cassandra, 1998; Roy & Gordon, 2003).

Although information spaces refer to “information”, they are not directly related to Shannon’s *information theory* (Shannon, 1948), which came later than von Neumann’s use of information in the context of sequential game theory. Neither does “information” here refer to content-bearing information. One important intuition behind the information in information spaces is that more information corresponds to narrowing down the space of possibilities (for example of future sensorimotor interactions).

The main mathematical concept of this paper is a *sensorimotor system* (SM-system), which is a special case of a transition system. Sensorimotor systems can describe the body-brain system, the body-environment system as well as other parts of the brain-body-environment system. Given two SM-systems they can be *coupled* to produce another (third) SM-system. Mathematically, the coupling operation is akin to a direct product. Now we need a way to compare different ways in which the agent can be coupled to the environment. Classically, agents are compared by the number of “correct” statements that they make about the environment in which they are. Since our aim is to avoid representational talk, we do something else. Instead, we introduce several notions that describe the coupling of the agent and the environment from an outside perspective. The main notion is that of *sufficiency*. This notion does not compare “internal” models of the agent to “external” states of affairs. Rather it asks whether the way in which the agent engages in sensorimotor patterns is well structured. In some sense *sufficiency* compares the sensorimotor capacity of the agent *to itself* by asking whether the sensorimotor patterns (in a given environment) are a reliable predictor (from an outside perspective) of the future of the very same sensorimotor behaviour. We then introduce several related notions. The *degree of insufficiency* is a measure by which various agents can be compared in their coupling versatility (Def 4.11). *Minimal sufficient refinement* is a concept that can be used in the most vivid ways to illustrate how the sensorimotor interaction “enacts” properties of the brain-body-environment system. The notion of minimal sufficient refinement ties together mathematics of sensorimotor systems and the philosophical ideas of emergence, structural coupling and enactment of the “world we inhabit” (Varela et al., 1992, cf.); see Example 4.28. We prove the uniqueness of minimal sufficient refinements (Theorem 4.22) and point out their connection to the notions of bisimulation and sufficient information mappings. *Strategic sufficiency* is a mathematically more challenging concept, but has appealing properties in the philosophical and practical sense. A sensor mapping is strategically sufficient *for* some subset of the state space G , if that sensor can (in principle) be used by the agent to reach G . Again, any sensor mapping has minimal strategic refinements, but this time they are not unique. Different minimal refinements in this case can be thought of as different adaptations to the same environmental demands.

Mathematically, sufficiency is a relative concept to some known notions in theoretical computer science and robotics: that of *bisimulation* in automata and Kripke model theory (Goranko & Otto, 2007), and *sufficient information mappings* in information spaces theory (LaValle, 2006).

Minimal sufficient refinements lead to unique classifications of agent-environment states that “emerge” from the way in which the agent is coupled to the environment, not merely from the way the environment is structured on its own. Thus, the world is simultaneously objectively existing (from the global “god” perspective), but also “brought about” by the agent.

This should be enough to answer the two questions that, according to (Paolo, 2018), any embodied theory of cognition should be able to provide precise answers to: What is its conception of bodies? What central role do bodies play in this theory different from the roles they

play in traditional computationalism?

Section 2 introduces the basics of transition and SM-systems, their coupling, and other mathematical constructs such as quotients. Section 3 illustrates the introduced notions with detailed examples. Section 4 introduces the notion of sufficiency, sufficient refinements, and minimal sufficient refinements. We will prove the uniqueness theorem for the latter and illustrate the notions in a computational setting. We will explore the importance of sufficiency and related notions for the enactivist way of looking at cognitive organization. Finally, Section 5 ties the mathematics back to the philosophical premises.

2 Transition Systems and Sensorimotor Systems

At the most abstract level, the central concept for our mathematical theory is that of a *transition system*:

Definition 2.1. A *transition system* is a triple (X, U, T) where X is the *state space* (mathematically it is just a set), U is the set of names for outgoing transitions (another set), and $T \subseteq X \times U \times X$ is a ternary relation.

The intuitive interpretation of (X, U, T) is that it is possible to transition from the state $x_1 \in X$ to the state $x_2 \in X$ via $u \in U$ iff $(x_1, u, x_2) \in T$. We use the notation $x_1 \xrightarrow{u} x_2$ to mean that $(x_1, u, x_2) \in T$. Our notion of transition system is often called a *labeled* transition system because each potential transition has a name or label, $u \in U$. However, we drop the term “labeled” because in Section 2.5 we will introduce a version of transition systems in which the states are relabeled, thereby introducing a new kind of labeling. Note that when working with such transition systems, we are safely within the realm of the Developmental-Explanatory Thesis (EA2).

Definition 2.2. Let $\mathcal{X} = (X, U, T)$ and $\mathcal{X}' = (X', U', T')$ be transition systems. An *isomorphism* is a bijective function $f: X \rightarrow X'$ such that for all $x_1, x_2 \in X$ and $u \in U$ we have $(x_1, u, x_2) \in T \iff (f(x_1), u, f(x_2)) \in T'$. A *bisimulation* is a relation $R \subseteq X \times X'$ such that for all $(x_1, x'_1) \in R$, all $u \in U$ and all $x_2 \in X$, we have that if $(x_1, u, x_2) \in T$, then there exists $x'_2 \in X'$ with $(x'_1, u, x'_2) \in T'$ and $(x_2, x'_2) \in R$.

The notation $\mathcal{X} \cong \mathcal{X}'$ means that $\mathcal{X}, \mathcal{X}'$ are isomorphic, and $\mathcal{X} \sim \mathcal{X}'$ means that there is a bisimulation R such that $X = \text{dom}(R)$ and $X' = \text{ran}(R)$. We speak of *automorphism* and *autobisimulation*, if $\mathcal{X} = \mathcal{X}'$.

We are ready to make the first observation:

Proposition 2.3. *If $\mathcal{X} \cong \mathcal{X}'$, then $\mathcal{X} \sim \mathcal{X}'$.*

Proof. Let f be an isomorphism $f: X \rightarrow X'$. Then $R = \{(x_1, x_2) \in X \times X' \mid x_2 = f(x_1)\}$ is a bisimulation. \square

2.1 Transition systems as a unifying concept

There are several ways in which transition systems and their relatives appear in the literature relevant to us.

Examples 2.4. Here are some examples how transition systems are related to concepts that appear in relevant literature. Let (X, U, T) be a transition system.

1. Let $x_0 \in X$ and $F \subseteq X$. Let $\hat{T}: X \times U \rightarrow \mathcal{P}(X)$ be defined by $\hat{T}(x, u) = \{x_2 \in X \mid x_1 \xrightarrow{u} x_2\}$. Then (X, U, \hat{T}, x_0, F) is a *nondeterministic automaton*. If in addition X and U are finite, then it is a *nondeterministic finite automaton* (NFA).
2. Let $\tilde{T}: X \times X \rightarrow \mathcal{P}(U)$ be the function $\tilde{T}(x_1, x_2) = \{u \in U \mid x_1 \xrightarrow{u} x_2\}$. Then $\tilde{T}(x_1, x_2)$ is the set of all u that take x_1 to x_2 . Then, (X, \tilde{T}) is a labeled directed graph in which the labels are subsets of U . Another way to think of it is as a labeled directed multigraph: the multiplicity of the edge from x_1 to x_2 is $n = |\tilde{T}(x_1, x_2)|$ and these n edges are labeled by the labels from the set $\tilde{T}(x_1, x_2)$.
3. If for all $x_1 \in X$ and $u \in U$ there is a unique $x_2 \in X$ with $x_1 \xrightarrow{u} x_2$, let $\tau: X \times U \rightarrow X$ be the function defined such that $\tau(x_1, u) = x_2$ iff $x_1 \xrightarrow{u} x_2$. Let $x_0 \in X$ and $F \subseteq X$. Then (X, U, τ, x_0, F) is a *deterministic automaton*, and if X and U are finite, then it is a *deterministic finite automaton* (DFA). Without F , (X, U, τ, x_0) also satisfies the definition of the *temporal filter* of (LaValle, 2012, §4.2.3). In this case X is the *information space* or the *I-space* (usually denoted by \mathcal{I} instead of X), and U is the observation space (usually denoted by Y instead of U).

2.2 Information spaces and Filters

We can reformulate the notion of a *history information space* introduced by (LaValle, 2006) as follows. In this context, X is an external state space that characterizes the robot's configuration, velocity, and environment, U is an action space, f is a state transition mapping that produces a next state from a current state and action, h is a sensor mapping that maps states to observations, and Y is a sensor observation space. As in (LaValle, 2006), for each $x \in X$, let $\Psi(x)$ be a finite set of "nature sensing actions" and for each $x \in X$ and $u \in U$ let $\Theta(x, u)$ be a finite set of "nature actions". Let $X_\Psi = \{(x, \psi) \mid \psi \in \Psi(x)\}$ and let $h: X_\Psi \rightarrow Y$ be a "sensor mapping" where Y is a set called the "observation space". Let $X_\Theta = \{(x, u, \theta) \mid \theta \in \Theta(x, u)\}$ and let $f: X_\Theta \rightarrow X$ be the "transition function".

Definition 2.5. A *valid history I-state* for X, Ψ, Θ, f is a sequence $(u_0, y_0, \dots, u_{k-1}, y_{k-1})$ of length $2k$ for which there exist $\bar{x} = (x_0, \dots, x_{k-1})$, $\bar{\psi} = (\psi_0, \dots, \psi_{k-1})$ and $\bar{\theta} = (\theta_0, \dots, \theta_{k-2})$ such that for all $i < k$ we have

1. $\theta_i \in \Theta(x_i, u_i)$,
2. if $i < k - 1$, then $x_{i+1} = f(x_i, u_i, \theta_i)$,
3. $\psi_i \in \Psi(x_i)$,
4. $y_i = h(x_i, \psi_i)$.

In this case we say that $(u_0, y_0, \dots, u_{k-1}, y_{k-1})$ is *witnessed* by \bar{x} , $\bar{\psi}$ and $\bar{\theta}$.

Now let \mathcal{I} be the set of all valid paths for X, Ψ, Θ, f . For all $k \in \mathbb{N}$, all $\bar{x} \in X^{k-1}$, all $\bar{\psi} = (\psi_0, \dots, \psi_{k-1})$ and all $\bar{\theta} = (\theta_0, \dots, \theta_{k-2})$, let $\mathcal{I}^k(\bar{x}, \bar{\psi}, \bar{\theta})$ be the set of all valid paths $(u_0, y_0, \dots, u_{k-1}, y_{k-1})$ witnessed by \bar{x} , $\bar{\psi}$, and $\bar{\theta}$. Now let $T \subseteq \mathcal{I} \times (U \times Y) \times \mathcal{I}$ be defined by

$$T = \left\{ (\eta, (u, y), \eta') \mid \text{there exist } k \in \mathbb{N}, \bar{x} = (x_0, \dots, x_{k-1}), \bar{\psi} = (\psi_0, \dots, \psi_{k-1}), \right. \\ \left. \bar{\theta} = (\theta_0, \dots, \theta_{k-2}), \theta \in \Theta(x_{k-1}, u) \text{ and } \psi \in \Psi(f(x_{k-1}, u, \theta)) \right. \\ \left. \text{such that} \right. \\ \left. \eta \in \mathcal{I}^k(\bar{x}, \bar{\psi}, \bar{\theta}) \wedge \eta' \in \mathcal{I}^{k+1}(\bar{x}', \bar{\psi}', \bar{\theta}'), \right. \\ \left. \text{where } \bar{x}' = \bar{x} \frown (f(x_{k-1}, u, \theta)), \bar{\psi}' = \bar{\psi} \frown (\psi), \text{ and } \bar{\theta}' = \bar{\theta} \frown (\theta) \right\}.$$

Here, $x \frown y$ is the concatenation of sequences x and y . Then $(\mathcal{I}, U \times Y, T)$ is the *history I-space transition system*. In the terminology of (LaValle, 2006, Ch 11), the valid path $(u_0, y_0, \dots, u_{k-1}, y_{k-1})$

Suppose for each $x, y \in X$ there is at most one $u \in U$ with $x \xrightarrow{u} y$. Let

$$E_T = \{(x, y) \in X^2 \mid \exists u \in U (x \xrightarrow{u} y)\},$$

and let $l: E_T \rightarrow U$ be defined so that $l((x, y))$ is the unique u such that $x \xrightarrow{u} y$. Then (X, E_T, l, x_0) with $x_0 \in X$ is a passive I-state graph as in (O’Kane & Shell, 2017, Def 1).

Definition 2.6. Let $\mathcal{X} = (X, U, T)$ be a transition system. If for all $(x, u) \in X \times U$ there is a unique $y \in X$ with $(x, u, y) \in T$, then we denote the function $(x, u) \mapsto y$ by τ , and write (X, U, τ) instead of (X, U, T) . In this case we call \mathcal{X} an *automaton*. Note that usually in computer science literature an automaton is finite and also has an initial state and a set of accepting states, but we do not have those in our definition.

For automata we also use the notation $x * u = \tau(x, u)$ and if $\bar{u} = (u_0, \dots, u_{k-1})$, then $x * \bar{u}$ is defined by induction for $k > 1$ as follows: $x * (u_0, \dots, u_{k-1}) = (x * (u_0, \dots, u_{k-2})) * u_{k-1}$

Examples 2.7. Here are some more examples of how automata and transition systems can model agent-environment and related dynamics.

1. If (X, \cdot) is a group, $U \subseteq X$ is a set of generators, and $\tau(x, u) = x \cdot u$, then (X, U, τ) is an automaton. For example, consider the situation in which $X = \mathbb{Z} \times \mathbb{Z}$ and $U = \{a, b, a^{-1}, b^{-1}\}$ in which $a = (1, 0)$ and $b = (0, 1)$. Thus, X is presented with generators a, b , and relation $a \cdot b = b \cdot a$. This models an agent moving without rotation in an infinite 2D-grid and the agent can move left, right, up and down. There are no obstacles. The standard Cayley graph is equivalent to the graph based representation of the automaton.
2. Let U^* be the set of all finite sequences (“strings”) of elements of U . If $\bar{u} = (u_0, \dots, u_{k-1}) \in U^*$ and $u_k \in U$, we denote by $\bar{u} \frown u_k$ the *concatenation* $(u_0, \dots, u_{k-1}, u_k)$. If $\bar{u}_0, \bar{u}_1 \in U^*$, then $\bar{u}_0 \frown \bar{u}_1$ is similarly the concatenation of two strings. The operation of concatenation turns U^* into a monoid. Suppose $\tau: X \times U^* \rightarrow X$ is an action of the monoid U^* on X meaning that it satisfies $\tau(\tau(x, \bar{u}), \bar{u}') = \tau(x, \bar{u} \frown \bar{u}')$ and $\tau(x, \emptyset) = x$. Then the automaton (X, U, τ) is a discrete-time control system. A sequence of *controls* $\bar{u} = (u_0, \dots, u_{k-1})$ produces a unique *trajectory* (x_0, \dots, x_k) , given the initial state x_0 by induction: $x_{i+1} = \tau(x_i, u_i)$ for all $i < k$.

3. Consider an automaton (X, U, τ) in which U is a group, and τ is a group action of U on X . In some situations it can be natural to consider the set of motor-outputs of an agent to be a group: the neutral element is no motor-output at all, every motor-output has an “inverse” for which the effect is the opposite, or negating (say, moving right as opposed to moving left), the composition of movements is many movements applied consecutively. The action τ of U on X is then the realization of those motor-outputs in the environment. In realistic scenarios, however, this is not a good way to model the sensorimotor interaction because of the following reason. Suppose the agent has actions “left” and “right”, but it is standing next to an obstacle on its left. Then moving “left” will result in staying still (because of the obstacle), but moving “right” will result in actually moving right, if there is no obstacle at the right of the agent. In this situation the sequence “left-right” results in a different position of the agent than the sequence “right-left”, so if “left” and “right” are each other’s inverses in G , then the axioms of group action are violated.
4. Note that if $T = \emptyset$, then (X, U, T) is a transition system.
5. Let $X = \{0, 1\}^*$ as in (2), $U = \{0\}$, and $(x, 0, y) \in T$ if and only if $|y| = |x| + 1$, then (X, U, T) is a transition system, where $|x|$ is the length of the string x .
6. If (X, U, T) is a transition system and $E \subseteq X$ an equivalence relation, then $(X/E, U, T/E)$ is a transition system, where $X/E = \{[x]_E \mid x \in X\}$ and $T/E = \{([x]_E, u, [y]_E) \mid (x, u, y) \in T\}$, and $/$ denotes a quotient space; see Definition 2.33.

2.3 Sensorimotor systems

Next, we will define a *sensorimotor system*, which is a special case of a transition system. Following the tenet (EA1) that “environment is inseparable from the body which is inseparable from the brain”, our sensorimotor systems can model any part of the environment-body-brain coupling. The model that describes the environment differs from the one that describes the agent merely in the type of information it contains, but not in an essential mathematical way.

SM-systems can be thought of as a partial specification of (some part of) the brain-body-environment coupling. Physicalist determinism demands that under full specification¹ we are left with a deterministic system. A specification is partial when it leaves room for unknowns in some, or all, parts of the system.

Definition 2.8. A *sensorimotor system* (or *SM-system*) is a transition system (X, U, T) where $U = S \times M$ for some sets S and M , which we call in this context the *sensory set* and the *motor set*, respectively.

The interpretation is that if $x \xrightarrow{(s,m)} y$, then s is the sensation that either occurs at x , or along the transition to the next state y , and m the motor action which leads to the transition. We will show later how SM-systems can be connected together (Definition 2.22) to form coupled systems. Sometimes an SM-system is modeling a brain-body totality, and other times it is modeling body-environment totality. A coupling between these two will model the brain-body-environment totality. This is a flexible framework which enables enactivist-style analysis.

¹This means a full specification of the environment, the agent’s body, its brain, their coupling, as well as the initial states.

In fact the sensory and motor components can be decoupled which might be more natural in some cases. The following alternative definition shows how, and the following theorem shows that they can be used interchangeably.

Definition 2.9. An *asynchronous SM-system* is a transition system (X, U, T) such that there exist partitions $U = S \cup M$ and $X = X_s \cup X_m$ such that for all $(x, u, y) \in T$ we have

1. if $x \in X_s$, then $u \in S$,
2. if $x \in X_m$, then $u \in M$, and
3. $x \in X_m \iff y \in X_s$.

Thus, the state space of a sequential SM-system contains separate *sensory states* and *motor states*.

Definition 2.10. Suppose E is an equivalence relation on a set X . We say that a map $f: X \rightarrow X$ is *E-preserving* if for all $x, y \in X$, we have $xEy \iff f(x)Ef(y)$.

There is a natural correspondence between SM-systems and their asynchronous counterpart:

Theorem 2.11. *Let SM and aSM be the classes of SM-systems and asynchronous SM-systems respectively. There are functions $F: \text{SM} \rightarrow \text{aSM}$ and $G: \text{aSM} \rightarrow \text{SM}$ such that*

1. F and G are isomorphism and bisimulation preserving,
2. restricted to finite systems, F and G are polynomial-time computable, and restricted to the infinite ones they are Borel-functions in the sense of classical descriptive set theory (Kechris, 1994).

Proof. We will show the construction for F and G and leave the rest of the proof to the reader because it would go beyond the scope of the present paper. A reader familiar with the corresponding areas (computability, descriptive set theory) can readily verify (3) for the construction of F below.

Suppose $\mathcal{X} = (X, S \times M, T)$ is an SM-system. Let $X_s = X$ and $X_m = T$. Thus, for each transition in \mathcal{X} , we will have a motor state in $F(\mathcal{X})$. Define

$$T_0 = \{(x, s, t) \mid (\exists y, m)((x, (s, m), y) = t)\}$$

and

$$T_1 = \{(t, m, y) \mid (\exists x, s)((x, (s, m), y) = t)\}$$

be disjoint copies of X and define $F(\mathcal{X}) = (X_s \cup X_m, S \cup M, T_0 \cup T_1)$.

On the other hand, given $\mathcal{X} \in \text{aSM}$, $\mathcal{X} = (X_s \cup X_m, S \cup M, T)$, let $G(\mathcal{X}) = (X', S \times M, T')$ where $X' = X_s$ and $(x, (s, m), y) \in T'$ if and only if there exists $z \in X_m$ such that $(x, s, z) \in T$ and $(z, m, y) \in T$. \square

Another type of a system, which is in a similar way equivalent to a special case of an SM-system, is a state-labeled transition system which we will introduce next, and prove a similar theorem, Theorem 2.19.

2.4 Quasifilters and quasipolicies

The amount of information specified in a given SM-system depends on which part of the brain-body-environment system we are modeling. At one extreme, we specify the environment’s dynamics down to the small detail and leave the brain’s dynamics completely unspecified. In this case the SM-system will have only one sensation corresponding to each state and the transition to the next state will be completely determined by knowing the motor action. This is, in a sense, the environment’s perspective. At the other extreme, we specify the brain completely, but leave the environment unspecified. We “don’t know” which sensation comes next, but we “know” which motor actions are we going to apply. This is in a sense the perspective of the agent. The first extreme case is the perspective often taken in robotics and other engineering fields when either specifying a planning problem (Choset et al., 2005; Ghallab, Nau, & Traverso, 2004; O’Kane & LaValle, 2008), or designing a filter (Hager, 1990; LaValle, 2012; Särkkä, 2013; Thrun, Burgard, & Fox, 2005) (also known as sensor fusion). This is why we call SM-systems of that sort *quasifilters* (Definition 2.12). The other extreme is the perspective of a policy. The policy depends on sensory input, but the motor actions are determined (by the policy). This is why we call the SM-systems of the latter sort *quasipolicy*. The “quasi-” prefix is used because both are weaker and more general notions than those that appear in the literature; see Remarks 2.20 and 2.21.

Another way to look at this is the dichotomy between virtual reality and robotics. In virtual reality, scientists are designing the (virtual) environment for an agent whereas in robotics they are typically designing an agent for an environment. In the former case the agent is partially specified: the type of embodiment is known (S and M are known) and some types of patterns of embodiment are known (eye-hand coordination). However, the specific actions to be taken by the agents are left unspecified. The job of the designer is to specify the environment down to the smallest detail, so that every sequence of motor actions of the agent yields targeted sensory feedback. The VR-designer is designing a quasifilter constrained by the partial knowledge of the agent’s embodiment and internal dynamics. The case for the robot designer is the opposite. She has a partial specification of the robot’s intended environment and usually works with a complete specification of the robot’s mechanics. She is designing a quasipolicy. For VR-designers the agent is a black box; for roboticists the agent is a white box (Suomalainen, Nilles, & LaValle, 2020) (unless the task is to reverse engineer an unknown robot design). For the environment, the roles are reversed. A similar dichotomy can be seen between biology (in which the agent is a black box) and robotics (in which it is usually a white box).

Definition 2.12. Suppose that $(X, S \times M, T)$ is an SM-system with the property that for all $x_1 \in X$ there exists $s_{x_1} \in S$ such that for all $x_2 \in X$ and all $(s, m) \in S \times M$ we have that $x_1 \xrightarrow{(s,m)} x_2$ implies $s = s_{x_1}$. Then, $(X, S \times M, T)$ is a *quasifilter*.

In a quasifilter the sensory part of the outgoing edge is unique. The dual notion (quasipolicy) is when the motor part is unique:

Definition 2.13. Suppose that $(X, S \times M, T)$ is an SM-system with the property that for all $x \in X$ there exists $m_x \in M$ such that for all $y \in X$ and all $(s, m) \in S \times M$ we have that $x \xrightarrow{(s,m)} y$ implies $m = m_x$. Then, $(X, S \times M, T)$ is a *quasipolicy*.

Before explaining the connections between quasifilter and a filter and quasipolicy and a policy, let us define projections of the sensorimotor transition relation to “motor” and to “sensory”:

Definition 2.14. Given an SM-system $(X, S \times M, T)$, let

$$\begin{aligned} T_M &= \{(x, m, y) \in X \times M \times X \mid \exists s \in S(x, (s, m), y) \in T\} \\ T_S &= \{(x, s, y) \in X \times S \times X \mid \exists m \in M(x, (s, m), y) \in T\}. \end{aligned}$$

These are called the *motor* and the *sensory projections* respectively of the sensorimotor transition relation. They are also called the *motor transition relation* and the *sensory transition relation*, respectively. The corresponding transition systems (X, M, T_M) and (X, S, T_S) are called the *motor* and the *sensory projection systems*.

Definition 2.15. Given a transition system (X, U, T) , and $x \in X$, let $O_T(x) \subseteq U$ be defined as the set $O_T(x) = \{u \in U \mid (\exists y \in X)(x \xrightarrow{u} y)\}$. Combining this notation with the one introduced in Example 2.4(2), given $x, y \in X$, we have

$$O_T(x) = \bigcup_{y \in X} \tilde{T}(x, y).$$

For a transition relation $T \subseteq X \times (S \times M) \times X$, define its *transpose* by $T^t \subseteq X \times (S \times M) \times X$ such that $T^t = \{(x, (m, s), y) \mid (x, (s, m), y) \in T\}$. Note that $(T^t)^t = T$. For a subset of a Cartesian product $A \subseteq S \times M$, let A_1 be the projection to the first coordinate $A_1 = \{s \in S \mid (\exists m \in M)((s, m) \in A)\}$ and A_2 the projection to the second one: $A_2 = \{m \in M \mid (\exists s \in S)((s, m) \in A)\}$

Mathematically coupling of two transition systems is symmetric (see Theorem 2.24(3)), but from the cognitive perspective there is (usually) an asymmetry between the agent and the environment (which can be evident from some specific properties of the agent and of the environment). Because of the partial symmetry, many properties of an agent can dually be held by the environment and vice versa. The following proposition highlights the duality between quasipolicy and quasifilters: reversing the roles of the environment and the agent reverses the roles of a quasipolicy and a quasifilter.

Proposition 2.16. *For an SM-system $\mathcal{X} = (X, S \times M, T)$ the following are equivalent:*

1. \mathcal{X} is a quasifilter,
2. $\mathcal{X}^t = (X, S \times M, T^t)$ is a quasipolicy,
3. $O_{T_S} = (O_T(x))_2 = (O_{T^t}(x))_1$ is a singleton for each $x \in X$.

Similarly, \mathcal{X} is a quasipolicy if and only if $O_{T_M}(x) = (O_T(X))_1$ is a singleton for each $x \in X$.

Proof. A straightforward consequence of all the definitions. □

2.5 State-labeled transition systems

It will become convenient in the coming framework to assign labels to the states. The elements x of the state space X are already named; thus, our labeling can be more properly considered as a *relabeling* via a function $h : X \rightarrow L$, in which L is an arbitrary set of *labels*. This allows partitions to be naturally induced over X by the preimages of h . Intuitively, this will allow the state space X to be characterized at different levels of “resolution” or “granularity”. Thus, we have the following definition:

Definition 2.17. A *state-relabeled transition system* (or simply *labeled transition system*) is a quintuple (X, U, T, h, L) in which $h: X \rightarrow L$ is a labeling function and (X, U, T) is a transition system.

We think of *state-relabeled* to be a more descriptive term, but we shorten it in the remainder of this paper to being simply *labeled*.

Remark 2.18. In an analogy to Definition 2.6, a labeled transition system is a *labeled automaton*, if T happens to be a function; in other words, for all $(x, u) \in X \times U$ there is a unique $y \in X$ with $(x, u, y) \in T$. In this case we may denote this function $\tau: (x, u) \mapsto y$ and work with the labeled automaton (X, U, τ, h, L) . For example, the temporal filter in Section 2.1 is a labeled automaton.

The isomorphism and bisimulation relations are defined similarly as for transition systems, but in a label-preserving way.

One intended application of a labeled transition system (X, U, T, h, L) is that h is a sensor mapping, L is a set of sensor observations, and U is a set of actions. Thus, actions $u \in U$ allow the agent to transition between states in X while h tells us what the agent senses in each state. We intend to show that this can be seen as a special case of an SM-system by proving a theorem similar to Theorem 2.11, but stronger, namely these correspondences preserve isomorphism:

Lemma 2.19. *Let \mathcal{F} be the class of quasifilters, \mathcal{P} the class of quasipolicies, and \mathcal{L} the class of labeled systems. Then there are one-to-one maps*

$$\text{LTS}_{\mathcal{P}}: \mathcal{P} \rightarrow \mathcal{L} \text{ and } \text{LTS}_{\mathcal{F}}: \mathcal{F} \rightarrow \mathcal{L}$$

such that

1. $\text{LTS}_{\mathcal{P}}$ and $\text{LTS}_{\mathcal{F}}$ are isomorphism and bisimulation preserving,
2. restricted to finite systems, $\text{LTS}_{\mathcal{P}}$ and $\text{LTS}_{\mathcal{F}}$ are polynomial-time computable, and restricted to the infinite ones they are Borel-functions in the sense of classical descriptive set theory.

Proof. Again, we will only show the constructions of the functions and leave the rest of the proof to the reader. Let \mathcal{F} be the class of quasifilters, \mathcal{P} the class of quasipolicies, and \mathcal{L} the class of labeled transition systems. We will define bijections $\text{LTS}_{\mathcal{F}}: \mathcal{F} \rightarrow \mathcal{L}$ and $\text{LTS}_{\mathcal{P}}: \mathcal{P} \rightarrow \mathcal{L}$. The constructions are dual to each other. Suppose $\mathcal{X} = (X, S \times M, T)$ is a quasifilter. Let $h: X \rightarrow S$ be the function defined by $h: x \mapsto s_x$ where s_x is as in Definition 2.12. Now let $\text{LTS}_{\mathcal{F}}(\mathcal{X}) = (X, M, T_M, h, S)$. We use S here as the set of labels and h as the labeling function to emphasize that the natural interpretation here is that h is a sensor mapping.

Now suppose that $\mathcal{X} = (X, M, A, h, S)$, $A \subseteq X \times M \times X$, is a labeled transition system. Let T be defined by

$$T = \{(x, (h(x), m), y) \mid (x, m, y) \in A\} \subseteq X \times (S \times M) \times X.$$

Then $\mathcal{X}' = (X, S \times M, T)$ is an SM-system which is a quasifilter and in fact $\mathcal{X}' = \text{LTS}_{\mathcal{F}}^{-1}(\mathcal{X})$. We have now $\text{LTS}_{\mathcal{F}}^{-1}(\text{LTS}_{\mathcal{F}}(\mathcal{X})) = \mathcal{X}$ for any quasifilter \mathcal{X} and $\text{LTS}_{\mathcal{F}}(\text{LTS}_{\mathcal{F}}^{-1}(\mathcal{X}'))$ for any labeled transition system \mathcal{X}' . Similarly if $\mathcal{X} = (X, S \times M, T)$ is a quasipolicy, define $\text{LTS}_{\mathcal{P}}(\mathcal{X}) = (X, S, T_S, h, M)$ where $h(x) = m_x$ (see Definition 2.13). Analogously to the above we also have the inverse function $\text{LTS}_{\mathcal{P}}^{-1}$. We have found the needed one-to-one correspondences. \square

In the end of the proof above we reverse the roles of S and M , now M being the set of labels, because they are thought of as the “outputs” of the policy.

Remark 2.20. Let $\mathcal{X} = (X, S \times M, T)$ be a quasifilter and $\mathcal{X}' = \text{LTS}_F(\mathcal{X}) = (X, M, T_M, h, S)$ as in Lemma 2.19. Suppose further that for each $x, y \in X$ there is at most one $u \in U$ with $x \xrightarrow{u} y$. Let

$$E_T = \{(x, y) \in X^2 \mid \exists u \in U(x \xrightarrow{u} y)\},$$

Then (X, M, E_T, x_0) coincides with the definition of a filter (O’Kane & Shell, 2017, Def 3). If it is also an automaton, meaning that above we replace “at most one” by “exactly one”, then every sequence of motor actions (m_0, \dots, m_{k-1}) determines a unique resulting state $x_{k-1} \in X$. This is analogous, and can be proved in the same way, as the fact that each sequence of sensory data determines a unique resulting state in Remark 2.21 below.

Remark 2.21. Usually, a *policy* is a function which describes how an agent chooses actions based on past experience. Thus, if M is the set of motor commands and S is the set of sensations, a policy is a function $\pi: S^* \rightarrow M$ where S^* is the set of finite sequences of sensory “histories”; see for example (LaValle, 2006). Now, suppose that an SM-system $\mathcal{X} = (X, S \times M, T)$ is a quasipolicy in the sense of Definition 2.13 and let $x \mapsto m_x$ be as in that Definition. Assume further that \mathcal{X} is an automaton (Section 2.1) and let $\tau: X \times (S \times M) \rightarrow X$ be the corresponding transition function so that for all $x \in X$ and $(s, m) \in S \times M$ we have $(x, (s, m), \tau(x, (s, m))) \in T$. Let $x_0 \in X$ be an initial state. We will show how the pair (\mathcal{X}, x_0) defines a function $\pi: S^* \rightarrow M$ in a natural way. Let $\bar{s} = (s_0, \dots, s_{k-1}) \in S^k$ be a sequence of sensory data. If $k = 0$, and so $\bar{s} = () = \emptyset$, let $\pi(\bar{s}) = m_{x_0}$. If $k > 0$, assume that $\pi(s_0, \dots, s_{k-2})$ and x_{k-1} are both defined (induction hypothesis). Then let $x_k = \tau(x_{k-1}, (m_{x_{k-1}}, s_{k-1}))$ and $\pi(s_0, \dots, s_{k-2}, s_{k-1}) = m_{x_k}$. The idea is that because of the uniqueness of m_x , a sequence of sensory data determines (given an initial state) a unique path through the automaton \mathcal{X} .

2.6 Couplings of transition systems

The central concept of this work pertaining to all principles (EA1)–(EA5) is the coupling of SM-systems. We define coupling, however, for general transition systems with the understanding that our most interesting applications will be for SM-systems where $U_0 = U_1 = S \times M$.

Definition 2.22. Let $\mathcal{X}_0 = (X_0, U_0, T_0)$ and $\mathcal{X}_1 = (X_1, U_1, T_1)$ be two transition systems. The *coupled* system $\mathcal{X}_0 * \mathcal{X}_1$ is the transition system (X, U, T) defined as follows: $X = X_0 \times X_1$, $U = U_0 \cap U_1$, and

$$T = T_0 * T_1 = \{((x_0, x_1), u, (y_0, y_1)) \mid (x_0, u, y_0) \in T_0 \wedge (x_1, u, y_1) \in T_1\}.$$

Equivalently, for all $((x_0, x_1), (y_0, y_1)) \in (X_0 \times X_1)^2$ we have

$$\tilde{T}((x_0, y_0), (x_1, y_1)) = \tilde{T}_0(x_0, x_1) \cap \tilde{T}_1(y_0, y_1)$$

(recall the \tilde{T} notation from Example 2.4(2)).

Example 2.23. A simple example of coupling is illustrated in Figure 2.

The coupling is a product of sorts. If we think of one transition system as “the environment” and the other as “the agent”, then the coupling tells us about all possible ways in which the

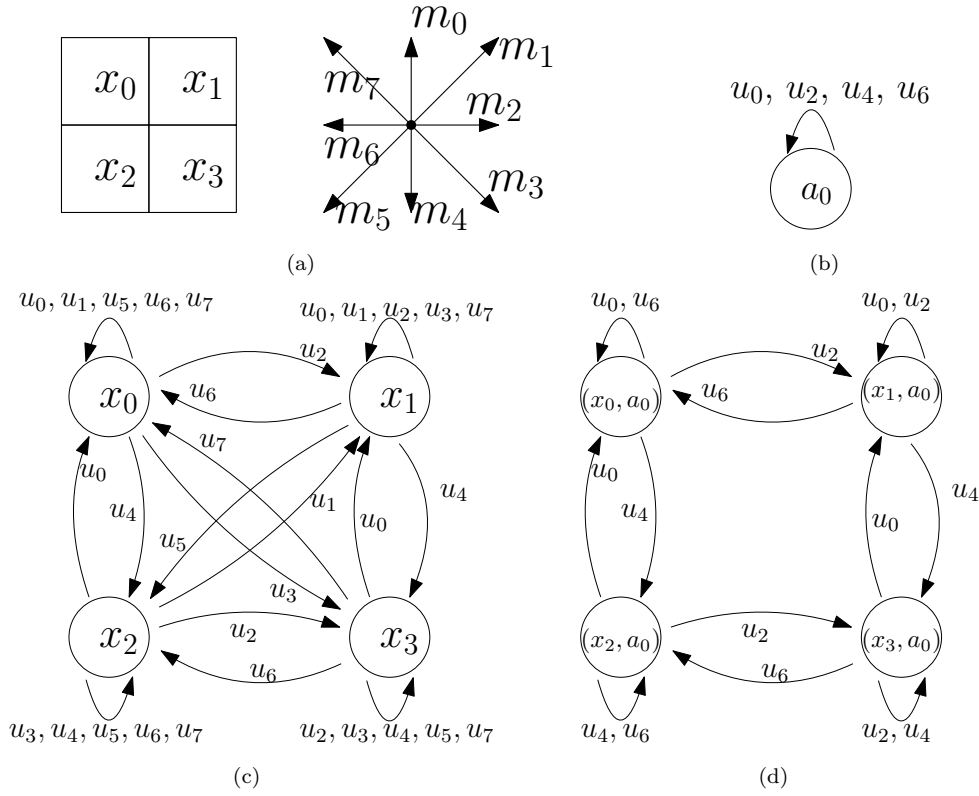

Figure 2: (a) States and actions for the transition system \mathcal{X}_0 that describes a 2-by-2 grid. 8 actions populating the set $M = \{m_0, \dots, m_7\}$ correspond to a move (to a neighbor cell if possible) either sideways or diagonally. Suppose S is a singleton such that $S = \{s\}$. Then, in the following, u_i corresponds to the transition $u_i = (m_i, s)$ for $i = 1, \dots, 7$. (b) Transition system \mathcal{X}_1 . (c) Transition system \mathcal{X}_0 . (d) The coupled system $\mathcal{X}_0 * \mathcal{X}_1$.

agent can engage with the environment. The fact that the state space of the coupled system is the product of the state spaces of the two initial systems reflects the fact that the coupled system includes information of “what would happen” if the environment was in any given state while the agent is in any given (“internal”) state.

We immediately prove the first theorem concerning coupling:

Theorem 2.24. *Suppose that $\mathcal{X}_i = (X_i, U_i, T_i)$ and $\mathcal{X}'_i = (X'_i, U'_i, T'_i)$ for $i \in \{0, 1\}$ are four SM-systems. Then the following hold:*

1. *If $\mathcal{X}_i \cong \mathcal{X}'_i$ for $i \in \{0, 1\}$, then $\mathcal{X}_0 * \mathcal{X}_1 \cong \mathcal{X}'_0 * \mathcal{X}'_1$.*
2. *If $\mathcal{X}_i \sim \mathcal{X}'_i$ for $i \in \{0, 1\}$, then $\mathcal{X}_0 * \mathcal{X}_1 \sim \mathcal{X}'_0 * \mathcal{X}'_1$.*
3. $\mathcal{X}_0 * \mathcal{X}_1 \cong \mathcal{X}_1 * \mathcal{X}_0$.

Proof. In this proof i always ranges over $\{0, 1\}$. Every time i appears below, we drop the phrase “for $i \in \{0, 1\}$ ”. For part 3 note that $(x, y) \mapsto (y, x)$ is an isomorphism. For part 1, if $f_i: \mathcal{X}_i \rightarrow \mathcal{X}'_i$ are isomorphism, let $g: (x, y) \mapsto (f_0(x), f_1(y))$. Then g is an isomorphism from $\mathcal{X}_0 * \mathcal{X}_1$ to $\mathcal{X}'_0 * \mathcal{X}'_1$. We leave the verification of these statements to the reader and proceed to prove part 2. Let R_i be the bisimulation witnessing $\mathcal{X}_i \sim \mathcal{X}'_i$. Let

$$R_0 * R_1 = \{((x_0, x_1), (x'_0, x'_1)) \in (X_0 \times X_1) \times (X'_0 \times X'_1) \mid (x_i, x'_i) \in R_i\}. \quad (1)$$

Let us show that $R = R_0 * R_1$ witnesses that $\mathcal{X}_0 * \mathcal{X}_1 \sim \mathcal{X}'_0 * \mathcal{X}'_1$. Suppose that $((x_0, x_1), (x'_0, x'_1)) \in R$, $u \in U_0 \cap U_1$ and $(y_0, y_1) \in X_0 \times X_1$. Suppose further that $(x_0, x_1) \xrightarrow{u} (y_0, y_1)$, meaning that

$$((x_0, x_1), u, (y_0, y_1)) \in T_0 * T_1.$$

Then by the definition of coupling we have that $(x_i, u, y_i) \in T_i$. By (1) we now have $(x_i, x'_i) \in R_i$. Since R_i is a bisimulation, there is $y'_i \in X'_i$ with $(y_i, y'_i) \in R_i$ and $(x'_i, u, y'_i) \in T_i$. By the definition of $T_0 * T_1$ we have now $((x'_0, x'_1), u, (y'_0, y'_1)) \in T_0 * T_1$, which completes the proof that R is a bisimulation. \square

Coupling provides an interesting way to compare SM-systems from the “point of view” of other SM-systems. For example, given an SM-system \mathcal{E} one can define an equivalence relation on SM-systems by saying that $\mathcal{I} \sim_E \mathcal{I}'$, if $\mathcal{E} * \mathcal{I} = \mathcal{E} * \mathcal{I}'$. If \mathcal{E} is the “environment” and $\mathcal{I}, \mathcal{I}'$ are “agents”, this is saying that the agents perform identically in this particular environment. Or vice versa, for a fixed \mathcal{I} , the relation $\mathcal{E} * \mathcal{I} = \mathcal{E}' * \mathcal{I}$ means that the environments are indistinguishable by the agent \mathcal{I} .

Remark 2.25. In the definition of coupling we see that the two SM-systems constrain each other. This is seen from the fact that in the definition we take intersections. For example, when an agent is coupled to an environment, it chooses certain actions from a large range of possibilities. In this way the agent structures its own world through the coupling (EA3). To make this notion further connect to enactivist paradigm, we invoke the dynamical systems approach to cognition (Schöner, 2008). An *attractor* in a transition system $\mathcal{X} = (X, U, T)$ is a set $A \subseteq X$ with the property that for all infinite sequences

$$x_0 \xrightarrow{u_0} x_1 \xrightarrow{u_1} \dots x_{k-1} \xrightarrow{u_{k-1}} x_k \xrightarrow{u_k} \dots$$

there are infinitely many indices n such that $x_n \in A$. There could be other possible definitions, such as “for all large enough n , $x_n \in A$ ”. For the present illustration purposes it is, however, irrelevant. It could be the case that $A \subseteq X$ is not an attractor of \mathcal{X} , but after coupling with $\mathcal{X}' = (X', U', T')$, $A \times X'$ may be an attractor of $\mathcal{X} * \mathcal{X}'$. Thus, if \mathcal{X} is the environment and \mathcal{X}' is the agent and A is a set of desirable environmental states, then we may say that the agent is well attuned to \mathcal{X} , if A was not initially an attractor, but in $\mathcal{X} * \mathcal{X}'$, then $A \times X'$ becomes one. It could also be that the agent needs to arrive to A while being in a certain type of an internal state $B \subseteq X'$, for example, if A is “food” and B is “hungry”. Then it is not enough that $A \times X'$ is an attractor, but it is imperative that $A \times B$ is one.

2.7 Unconstrained and fully constrained SM-systems

As we mentioned before, the information specified in an SM-system depends on which part of the brain-body-environment system we are modeling. In the extreme case we do not specify *anything*, except for the very minimal information. Consider a body of a robot for which the set of possible actions (or motor commands) is M and the set of possible sensor observations is S . Suppose that that is all we know about the robot. We do not know what kind of environment it is in and we do not know what kind of “brain” (a processor or an algorithm) it is equipped with. Thus we do not know of any constraints the robot may have in sensing or moving. We then model this robot as an *unconstrained* SM-system:

Definition 2.26. An SM-system $(X, S \times M, T)$ is called *unconstrained* iff for all $x \in X$, we have $O_T(x) = S \times M$; recall Definition 2.15.

Unconstrained systems have the role of a neutral element with respect to coupling (Proposition 2.29). We now show that given all unconstrained SM-systems with shared M and S are mutually bisimulation equivalent:

Proposition 2.27. *Suppose that $\mathcal{X} = (X, S \times M, T)$ and $\mathcal{X}' = (X', S \times M, T')$ are unconstrained systems. Then $\mathcal{X} \sim \mathcal{X}'$.*

Proof. Let $R = X \times X'$. We need to show that R is a bisimulation. In the definition of bisimulation, Definition 2.2, the conclusion of the implication that needs to be satisfied is “there exists $y' \in X'$ with $(x', u, y') \in T'$ and $(y, y') \in R$ ”. However, because both R and T' contain “everything”, this is trivially true as long as $X \times X'$ is non-empty. However, if it is empty, then the premise of that implication is false (no $(x, x') \in R$ exist); thus, the definition of bisimulation is again trivially satisfied. \square

Corollary 2.28. *The SM-system $\varepsilon = (\{0\}, \{0\} \times (S \times M) \times \{0\})$ is the unique, up to bisimulation, unconstrained system.*

Proposition 2.29. *Let ε be as in Corollary 2.28 and let $\mathcal{X} = (X, S \times M, T)$ be any SM-system. Then $\mathcal{X} * \varepsilon \cong \mathcal{X}$.*

Corollary 2.30. *If \mathcal{X} and \mathcal{X}' are SM-systems and \mathcal{X}' is unconstrained, then $\mathcal{X} * \mathcal{X}' \sim \mathcal{X}$.*

Proof. By Corollary 2.28 $\mathcal{X}' \sim \varepsilon$. So by Theorem 2.24 we have $\mathcal{X} * \mathcal{X}' \sim \mathcal{X} * \varepsilon$. However, by Proposition 2.29, $\mathcal{X} * \varepsilon \sim \mathcal{X}$; thus, $\mathcal{X} * \mathcal{X}' \sim \mathcal{X}$. \square

The opposite of an unconstrained system is a fully constrained one:

Definition 2.31. An SM-system $(X, S \times M, T)$ is *fully constrained* iff $T = \emptyset$.

Proposition 2.32. *Dually to the propositions above, we have that (1) all fully constrained systems are bisimulation equivalent to each other, (2) the simplest example being $\lambda = (\{0\}, S \times M, \emptyset)$, and (3) if $\mathcal{X} = (X, S \times M, T)$ is another SM-system, then $\mathcal{X} * \lambda \sim \lambda$.*

All transition systems are in some sense between the fully constrained and the unconstrained, these being the two theoretical extremes.

2.8 Quotients of transition systems

When considering labelings and their induced equivalence relations, it will be convenient to develop a notion of quotient systems, analogous to quotient spaces in topology. Suppose $\mathcal{X} = (X, U, T)$ is a transition system and E is an equivalence relation on X . We can then form a new transition system, called the *quotient* of \mathcal{X} by E in which the new states are E -equivalence classes and the transition relation is modified accordingly.

Definition 2.33. Suppose $\mathcal{X} = (X, U, T)$ and E are as above. Let $X/E = \{[x]_E \mid x \in X\}$, in which each $[x]_E$ is an equivalence class of states x under relation E , and $T/E = \{([x]_E, u, [y]_E) \mid (x, u, y) \in T\}$. Then $\mathcal{X}/E = (X/E, U, T/E)$ is the *quotient* of (X, U, T) by E .

Definition 2.34. Given any function $h: X \rightarrow L$, denote by E^h the inverse-image equivalence: $E^h = \{(x, y) \in X^2 \mid h(x) = h(y)\}$. We will denote the equivalence classes of E^h by $[x]_h$ instead of $[x]_{E^h}$ if no confusion is possible.

The equivalence relation E^h partitions X according to the preimages of h , as considered in the sensor lattice theory of (LaValle, 2019). The partition of X induced by h directly yields an quotient transition system by applying the previous two definitions:

Definition 2.35. Let $\mathcal{X} = (X, U, T)$ be a transition system and $h: X \rightarrow L$ be any mapping. Then define \mathcal{X}/h to be \mathcal{X}/E^h where we combine Definitions 2.34 and 2.33.

Proposition 2.36. *If h is one-to-one, then $\mathcal{X}/h \cong \mathcal{X}$.*

Proof. h is one-to-one if and only if E^h is equality, in which case it is straightforward to verify that the function $x \mapsto [x]_{E^h}$ is an isomorphism. \square

For $h: X \rightarrow L$, the transition system $(X/h, U, T/h)$ is essentially a new state space over the preimages of h . In this case \mathcal{X}/h is called the *derived information space* (as used in (LaValle, 2006)). More precisely:

Proposition 2.37. *Let $L' = \text{ran}(h) \subseteq L$. Define*

$$\begin{aligned} T' &= \{(l, u, l') \in L' \times U \times L' \mid (h^{-1}(l), u, h^{-1}(l')) \in T/h\} \\ &= \{(h(x), u, h(y)) \mid (x, u, y) \in T\}. \end{aligned}$$

Then $(X/h, U, T/h)$ is isomorphic to (L', U, T') via the isomorphism $f: [x]_{E^h} \mapsto h(x)$.

Proof. We now show that T' and f are well defined. For that note that by Definition 2.34 we have $[x]_h = [x]_{E^h} = h^{-1}(x)$, and for all $y \in [x]_h$ we have $h(y) = h(x)$. On the other hand, if $[y]_h \neq [x]_h$, then $h(y) \neq h(x)$ and so f is injective. It is surjective by the definition of S' . Finally, $([x]_h, u, [y]_h) \in T/h$ if and only if $(h^{-1}(h(x)), u, h^{-1}(h(y))) \in T/h$ if and only if $(h(x), u, h(y)) \in T$ (by the definition of T') if and only if $(f([x]_h), u, f([y]_h)) \in T'$ (by the definition of f). \square

3 Illustrative Examples of SM-Systems

We next illustrate how sensorimotor systems model body-environment, brain-body, and brain-body-environment couplings. Consider a body in a fully understood and specified deterministic environment. In this case the body-environment system will be modeled by a quasifilter, Definition 2.12. Instead of using the quasifilter definition, we work with a labeled transition system which, according to Proposition 2.19, is equivalent. According to the assumption of full specification, we will in fact work with labeled automata.

The body has a set M of possible motor actions each of which has a deterministic influence on the body-environment dynamics. Denote the set of body-environment states by E_0 . Whenever a motor action $m \in M$ is applied at a body-environment state $e \in E$, a new body-environment state $A(e, m) \in E$ is achieved. At each state $e \in E$ the body senses data $\sigma(e)$. Denote the set of sensations by S . In this way, the labeled automaton $\mathcal{E}_0 = (E, M, A, \sigma, S)$ models this body-environment system. This model is ambivalent towards the agent's internal dynamics, its

strategies, policies and so on, but not ambivalent towards its embodiment and its environment's structure. In fact, it characterizes them completely.

Alternatively, consider a brain in a body, and suppose that the brain is fully understood and deterministic (for example, perhaps it is designed by us), but we do not know which environment it is in. We model this by an SM-system which is a quasipolicy. Again, by the analogous considerations as above, we work directly an equivalent labeled automaton specification. Denote the set of internal states of the brain by I . The agent's internal state is a function of the sensations; therefore, let $B: I \times S \rightarrow I$ be a function (B stands for *brain*) that takes one internal state to another based on new sensory data. At each internal state, the agent produces a motor output which is an element of the set M ; therefore, let $\mu: I \rightarrow M$ be a function assigning a motor output to each internal state. Now, $\mathcal{I} = (I, S, B, \mu, M)$ is a labeled transition system modeling this agent. It is ambivalent towards the type of the environment the agent is in, but it is not ambivalent towards the agent's internal dynamics, policies, strategies and so on; in fact, it determines them completely.

Now, the coupling of the environment \mathcal{E} and the agent \mathcal{A} is the SM-system obtained as

$$\text{LTS}_F^{-1}(\mathcal{E}) * \text{LTS}_P^{-1}(\mathcal{A}).$$

The sensory and motor sets S and M capture the interface between the brain and the environment because they characterize the body (but not the *embodiment*).

Example 3.1. Consider an agent that has four motor outputs, called “up” (U), “down” (D), “left” (L), and “right” (R), and there is no sensor feedback (this defines the body). In Corollary 2.28 we gave a minimal example of an unconstrained SM-system. On the other extreme one can give large examples. For instance the free monoid generated by the set $M = \{U, D, L, R\}$.

Let X be the set of all possible finite strings in the four “letter” alphabet M , let $T = \{(x, m, y) \mid x \hat{\ } m = y\}$. “No sensor data” is equivalent to always having the same sensor data; thus, we can assume that $S = \{s_0\}$ is a singleton and the sensor mapping $h: X \rightarrow S$ is constant. The resulting unconstrained transition system $\mathcal{U} = (X, T, M, \sigma, S)$ can be represented by an infinite quaternary tree, shown in Figure 3(a).

Suppose that this body is situated in a 2×2 grid. The body can occupy one of the four grid's squares at a time, and when it applies one of the movements, it either moves correspondingly, or, if there is a wall blocking the movement, it doesn't. This defines the body-environment system. The set of states is now E and has four elements corresponding to all the possible positions of the body. The transition function $A: E \times M \rightarrow E$ tells where to move, and the rest is as above. The system $\mathcal{E} = (E, A, M, \sigma, S)$ is shown in Figure 3(b). Let us now look at the agent. Suppose that it applies the following policy: (1) In the beginning move left; (2) if the previous move was to the left, then move right, otherwise move left. This can be modeled with a two-state automaton $\mathcal{I} = (I, S, B, \mu, M)$ where $I = \{L, R\}$, $S = \{s_0\}$, $B(L, s_0) = R$, $B(R, s_0) = L$, $\mu(L) = l$ and $\mu(R) = r$. Now, the coupling $\text{LTS}_F^{-1}(\mathcal{E}) * \text{LTS}_P^{-1}(\mathcal{I})$ is an automaton that realizes the policy in the environment, as shown in Figure 4(a).

If the agent has a different embodiment in the same environment, then all of the automata will look different. Suppose that instead of the previous four actions, the agent has two: “rotate 90-degrees counterclockwise” (C), “forward one step” (F). Note that these are expressed in the local frame of the robot: It can either rotate relative to its current orientation, or it can move in the direction it is facing; the previous four actions were expressed as if in a global frame or the robot is incapable of rotation. Under the new embodiment, the unconstrained automaton with

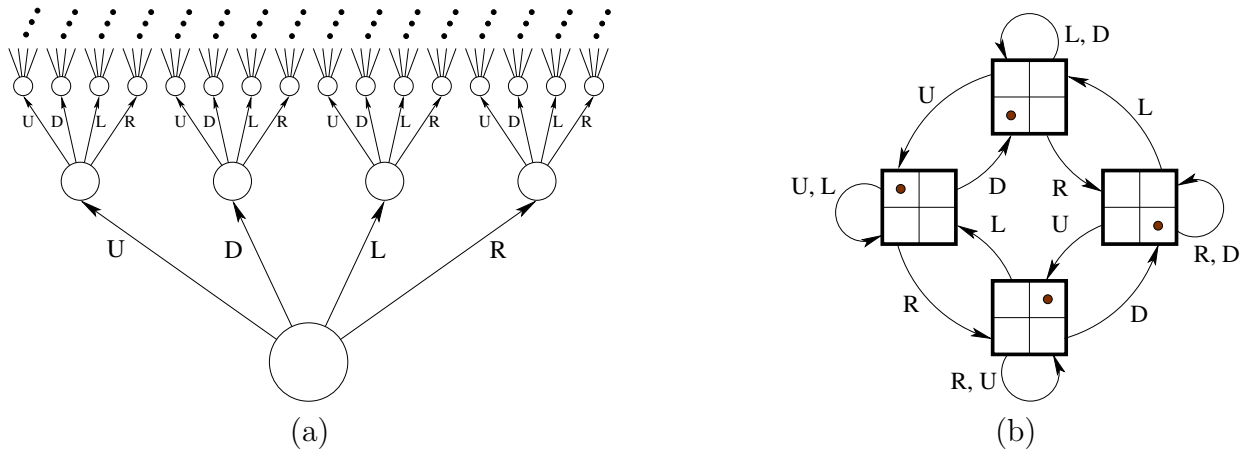

Figure 3: (a) Having motor commands and no sensory feedback leads to an infinite tree automaton. (b) Once the body is coupled with a 2×2 grid environment, a four-state automaton results.

no sensor feedback is an infinite *binary tree*, with every node having two outgoing edges, labeled C and F , respectively, instead of the quaternary infinite tree depicted on Figure 3(a). Instead of the four-state automaton of Figure 3, the automaton describing the environment transitions is a 16 state-automaton, because the orientation of the agent can now have four different values. See Figure 4(b). Finally the automaton describing the internal mechanics of the agent \mathcal{I} is a quasipolicy in these two actions, and finally, the coupling corresponds essentially to taking a path in the 16-state automaton above.

Note that there is a bisimulation between \mathcal{U} and \mathcal{E} which reflects the fact that from the point of view of an agent they are indistinguishable. This is natural because there is no sensory data, so from the agent's viewpoint it is unknowable whether or not it is embedded in an environment. A bisimulation is given as follows: Let $y_0 \in Y$ be the top-right corner and $x_0 \in X$ the root of the tree. Define $R \subseteq X \times Y$ be the minimal set satisfying the following conditions:

1. $(x_0, y_0) \in R$.
2. If $(x, y) \in R$ and $m \in M$, then $(T(x, m), U(y, m)) \in R$.

Example 3.2. The 16-state automaton of Example 3.1 has four automorphisms corresponding to the rotation of the environment by 90 degrees counterclockwise. Each of those automorphisms corresponds to an auto-bisimulation. Mirroring is not an automorphism because the agent's rotating action fixes the orientation of the automaton.

Example 3.3. Figure 5 shows an example of how an automaton with non-trivial sensing could look. Jumping a little bit ahead, it will be seen that the labeling provided by h in this figure is not sufficient (a notion introduced in Definition 4.2).

4 Sufficient Refinements and Degree of Insufficiency

This section presents the concept of *sufficiency*, which we present as the main glue between enactivist philosophy and mathematical understanding of cognition. In Section 4.1 we introduce

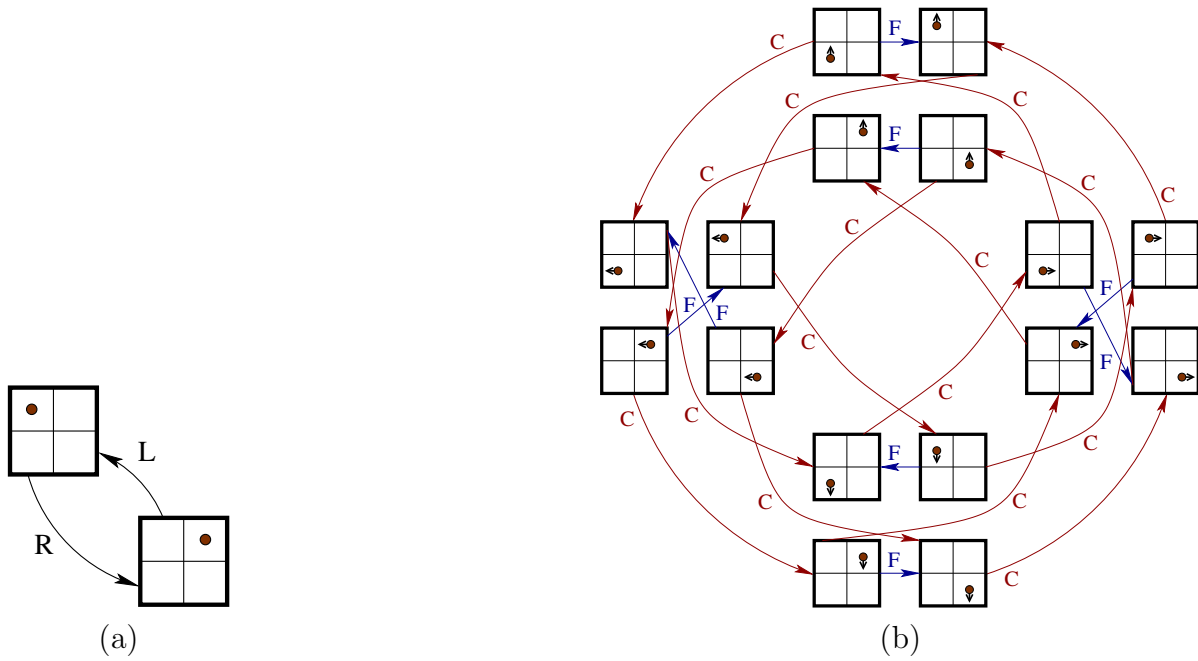

Figure 4: (a) A two-state automaton results from the realized policy. (b) If there are only two actions (rotate 90 degrees counterclockwise and going straight) then the second automaton has 16 states instead of four as in Figure 3(b).

the main concepts and explain its profound relevance to enactivist modeling and how it can be a precursor to the emergence of meaning from meaningless sensorimotor interactions. We also point out that there is an intricate relationship between this concept and the celebrated free energy principle from neuroscience, although we leave that discussion open. In Section 4.2 we introduce the notion of minimal sufficient refinements, prove a uniqueness result about them, and show how they are connected to the classical notions of bisimulation as well as derived information state spaces.

4.1 Sufficiency

Definition 4.1. Let (X, U, T) be a transition system and $E \subseteq X \times X$ an equivalence relation. We say that E is *sufficient* or *completely sufficient*, if for all $(x, y) \in E$ and all $u \in U$, if $(x, u, x') \in T$ and $(y, u, y') \in T$, then $(x', y') \in E$.

This means that if an agent cannot distinguish between states x and y , then there are no actions it could apply to later distinguish between them. To put it differently, if the states are indistinguishable by an instant sensory reading, then they are in fact indistinguishable even through sensorimotor interaction. This is related to the equivalence relation known as Myhill-Nerode congruence in automata theory.

The equivalence relation of indistinguishability in the context of sensorimotor interactions is at its simplest the consequence of indistinguishability by sensors. Thus, we define sufficiency for labelings or sensor mappings:

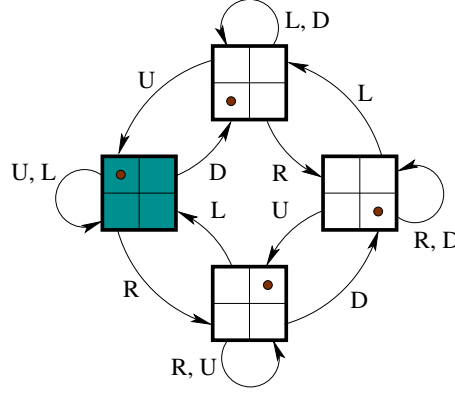

Figure 5: Consider the automaton \mathcal{E} of Figure 3(b) from Example 3.1, but assume that the agent can “smell” a different scent in the top-left corner. This can be modeled by having a two-element set $S = \{0, 1\}$ instead of a singleton, and $h: X \rightarrow \{0, 1\}$ such that $h(x) = 0$ iff x is not the top-left corner. The state with a scent is shaded.

Definition 4.2. A labeling $h: X \rightarrow L$ is called *sufficient* (or *completely sufficient*) iff for all $x, y, x', y' \in X$ and all $u \in U$, the following implication holds:

$$(h(x) = h(y) \wedge (x, u, x') \in T \wedge (y, u, y') \in T) \Rightarrow h(x') = h(y').$$

Proposition 4.3. If (X, U, τ) is an automaton, then $h: X \rightarrow L$ is sufficient if and only if for all $x, y \in X$ and all $u \in U$, we have that if $h(x) = h(y)$, then $h(\tau(x, u)) = h(\tau(y, u))$.

Proof. Checking the definitions. □

There is a connection with the classical notion of bisimulation in classical transition systems theory (recall Definition 2.2):

Proposition 4.4. An equivalence relation on a state space of an automaton (X, U, τ) is sufficient if and only if it is an autobisimulation.

Proof. Suppose $E \subseteq X$ is a bisimulation and let $x_1, x_2 \in X$ be such that $(x_1, x_2) \in E$ and let $u \in U$. Let $x'_1 = \tau(x_1, u)$. Since E is a bisimulation, there exists x'_2 such that $\tau(x_2, u) = x'_2$ and $(x'_1, x'_2) \in E$. But $\tau(x_2, u)$ is uniquely determined and so it follows that $(\tau(x'_1, u), \tau(x'_2, u)) \in E$. The other direction is left to the reader. □

Proposition 4.5 below is an important proposition on which the idea of derived I-spaces and combinatorial filters builds upon (LaValle, 2006, 2012; O’Kane & Shell, 2017), although as far as the authors are aware, in the literature, only the “if”-direction is mentioned. We say that a transition system (X, U, T) is *full*, if for all $x_1 \in X$ and all $u \in U$ there exists at least one $x_2 \in X$ with (x_1, u, x_2) .

Proposition 4.5. Suppose $\mathcal{X} = (X, U, T)$ is a transition system. Let $h: X \rightarrow L$ be a labeling. Then \mathcal{X}/h is an automaton if and only if \mathcal{X} is full and h is sufficient.

Proof. Suppose \mathcal{X}/h is an automaton. That means that T/h is a function with domain $X/h \times U$, so \mathcal{X}/h must be full. For sufficiency assume that $x_1, x_2 \in X$ and $u \in U$ are such that $h(x_1) = h(x_2)$, so in particular $[x_1]_h = [x_2]_h$. Suppose further that x'_1, x'_2 are such that $(x_1, u, x'_1), (x_2, u, x'_2) \in T$. We need to show that then $h(x'_1) = h(x'_2)$. We have $([x_1]_h, u, [x'_1]_h) \in T/h$ and $([x_2]_h, u, [x'_2]_h) \in T/h$. Since T/h is a function, and $[x_1]_h = [x_2]_h$, we must have $[x'_1]_h = [x'_2]_h$ which by definition means that $h(x'_1) = h(x'_2)$, so h is sufficient. For the other direction, suppose that h is sufficient and that \mathcal{X} is full. We want to show that for all $[x_1]_h \in X/h$ and $u \in U$ there is a unique $[x_2]_h \in X/h$ with $([x_1]_h, u, [x_2]_h) \in T/h$. Existence follows from fullness. For uniqueness and assume that

$$([x_1]_h, u, [x_2]_h), ([x_1]_h, u, [x'_2]_h) \in T/h \quad (2)$$

for some $x_1, x_2, x'_2 \in X$. Since they are chosen to arbitrarily, it is enough to show that $h(x_2) = h(x'_2)$, because this implies that $[x_2]_h = [x'_2]_h$ and so $[x]_h$ together with u uniquely determine the element $\xi = [x_2]_h = [x'_2]_h$ such that $([x_1]_h, u, \xi) \in T/h$. By (2) there must be $z_1, z'_1 \in [x_1]_h$ and $z_2 \in [x_2]_h, z'_2 \in [x'_2]_h$ such that $(z_1, u, z_2), (z'_1, u, z'_2) \in T$. Since $h(z_1) = h(z'_1)$ and h is sufficient, we have $h(z_2) = h(z'_2)$ and since $h(z_2) = h(x_2)$ and $h(z'_2) = h(x'_2)$ we have that $h(x_2) = h(x'_2)$ as needed. \square

The sufficiency of an information mapping was introduced in (LaValle, 2006, Ch 11), and is encompassed by a sufficient labeling in this paper. In the prior context, it has meant that the current sensory perception together with the next action determine the next sensory perception. The elegance with respect to our principle (EA2) is that sufficiency is *not* saying that the agent's internal state corresponds to the environment's state (as is in representational models). Nor is it saying that the agent *predicts* the next action. It is saying, rather, that the agent's current sensation together with a choice of a motor command *determine* the agent's next sensation; and this statement is true only as a statement made about the system from outside, not as a statement which would reside "in the agent". The sensation may carry no meaning at all "about" what is actually "out there". However, if the agent has found a way to be coupled to the environment in a sufficient way, then sensations *begin* to be *about* future sensation. In this way meaning emerges from sensorimotor patterns. This relates to (EA3) and somewhat touches on the topic of perception (EA5). Furthermore, the property of determining future outcomes is related to (EA4) because that is what *skill* is. There is no potential to *reliably* engage with the environment in complex sensorimotor interactions, if the sensations do not *reliably* follow certain historical patterns.

Thus, the notion of sufficiency is considered by us to be of fundamental importance for enactivist-inspired mathematical modeling of cognition. The violation of sufficiency means that the current sensation-action pair does not correlate with the future sensation, making it harder to be attuned to the environment. Having a different sensation following the same pattern can be seen as a primitive notion of a "surprise". This remarkably aligns with the predictive coding and the free energy principle from neuroscience (Rao & Ballard, 1999; Friston & Kiebel, 2009; Friston, 2010). Does the notion of sufficient labelings capture the same ideas in a more general way? This is an open question for further research.

A generalization of sufficiency is n -sufficiency, in which the data of n previous steps is needed to determine the next label. Here, we define an n -chain.

Definition 4.6. An n -chain in $\mathcal{X} = (X, U, T)$ is a sequence

$$c = (x_0, u_0, \dots, x_{n-1}, u_{n-1}, x_n) \in (X \times U)^n \times X$$

such that $x_i \xrightarrow{u} x_{i+1}$ for all $i < n$. If $n = 0$, then by convention $c = (x_n)$. Let $E \subseteq X \times X$ be an equivalence relation. Let $k < n$. We say that two n -chains $c = (x_0, u_0, \dots, x_{n-1}, u_{n-1}, x_n)$, $c' = (x'_0, u'_0, \dots, x'_{n-1}, u'_{n-1}, x'_n)$ are (T, E, k) -equivalent if for all $i < k$, we have $u_i = u'_i$ and $(x_i, x'_i) \in E$. An ∞ -chain is defined in the same way as n -chain, except the sequences are infinite, without the “last” x_n .

Definition 4.7. For a transition system $\mathcal{X} = (X, U, T)$, an equivalence relation E on X is called n -sufficient if there are no two (T, E, n) -equivalent n -chains

$$c = (x_0, u_0, \dots, x_{n-1}, u_{n-1}, x_n) \text{ and } c' = (x'_0, u'_0, \dots, x'_{n-1}, u'_{n-1}, x'_n)$$

such that $(x_n, x'_n) \notin E$. A labeling $h: X \rightarrow L$ is called n -sufficient if E^h is n -sufficient (Recall Definition 2.34).

Proposition 4.8. *An equivalence relation E is 0-sufficient if and only if there is only one E -equivalence class, and a labeling function h is 0-sufficient if and only if it is constant.*

Proof. The intuition is that if we can predict the future from “nothing”, it means that the future is always the same. Let us prove the first statement. The second statement then follows because E^h has exactly one equivalence class if and only if h is constant. Plugging in $n = 0$ into Definition 4.7, it says “...if there are no two $(T, E, 0)$ -equivalent 0-chains $(x_0), (x'_0)$ with $(x_0, x'_0) \notin E$ ”. However, the (T, E, n) -equivalence only concerns elements of the sequence before the n :th element, before 0:th in this case, which do not exist. Thus, all 0-chains are equivalent by definition. Hence, the definition of 0-sufficiency becomes “...if there are no two sequences $(x_0), (x'_0)$ with $(x_0, x'_0) \notin E$ ”. This amounts to saying that E has one equivalence class. \square

Proposition 4.9. *An equivalence relation E (resp. a labeling h) is sufficient if and only if it is 1-sufficient.*

Proof. 1-sufficiency says that for all 1-chains (x_0, u_0, x_1) and (x'_0, u_1, x'_1) , if x_0 and x'_0 are equivalent and $u_0 = u_1$, then x'_0 and x'_1 are equivalent which is exactly the definition of sufficiency. \square

Proposition 4.10. *Suppose $n < m$ are natural numbers. If a labeling h is n -sufficient, then it is m -sufficient. The same holds for equivalence relations.*

Proof. The intuition here is that “knowing more doesn’t hurt”. We prove the statement for equivalence relations. Suppose E is n -sufficient and $m > n$. Suppose to the contrary that E is not m -sufficient. This is witnessed by some m -chains

$$c = (x_0, u_0, \dots, x_{m-1}, u_{m-1}, x_m) \text{ and } c' = (x'_0, u'_0, \dots, x'_{m-1}, u'_{m-1}, x'_m)$$

which are (T, E, m) -equivalent and $(x_m, x'_m) \notin E$. Now define restrictions c_0 and c'_0 which are obtained from c and c' by ignoring all elements with indices less than $(m - n)$. Then c, c' are n -chains and are in fact (T, E, n) -equivalent. The last elements are still x_m and x'_m and $(x_m, x'_m) \notin E$, which means that c_0, c'_0 witness that E is not n -sufficient and contradicts our assumption. \square

This enables us to define the degree of insufficiency:

Definition 4.11. The *degree of insufficiency* of the labeled automaton $\mathcal{X} = (X, U, \tau, h, L)$ is defined to be the smallest n such that h is n -sufficient, if such n exists, and ∞ otherwise. Denote the degree of insufficiency of \mathcal{X} by $\text{degins}(\mathcal{X})$, or $\text{degins}(h)$ if only the labeling needs to be specified and \mathcal{X} is clear from the context.

The intuition is that the larger the degree of insufficiency of an environment \mathcal{X} , the harder it is for an agent to be attuned to it. We talk more about the connection between attunement and sufficiency in the following sections.

4.2 Minimal sufficient refinements

In this section we prove that the minimal sufficient refinements are always unique (Theorem 4.22). This will follow from a deeper result that the sufficient equivalence relations form a complete sublattice of the lattice of all equivalence relations. This does not hold for n -sufficient equivalence relations for $n > 1$ (Example 4.23). We will then explore how the minimal sufficient refinements can be thought of as an enactive perceptual construct that emerges from the body-environment, brain-body, and brain-body-environment dynamics.

Definition 4.12. An equivalence relation E is a *refinement* of equivalence relation E' , if $E \subseteq E'$, also denoted $E' \leq_r E$. A labeling function h is a refinement of a labeling function h' , if E^h is a refinement of $E^{h'}$.

An important interpretation of the concept of a refinement is that a better sensor provides the agent with more information about the environment.² Each sensor mapping h induces a partition of X via its preimages, and refinement applies in the usual set-theoretic sense to the partitions when comparing sensors mappings. If a sensor mapping h is a refinement of h' , then it enables the agent to react in a more refined way to nuances in the environment. Using the partial ordering given by refinements, we obtain the *sensor lattice* (LaValle, 2019), so let us diverge for a moment into the theory of lattices.

4.3 Lattices of equivalence relations

Let (L, \leq) be an ordered set. An *upper bound* of a subset L' is an element u such that $l \leq u$ for all $l \in L'$. It is a *least upper bound*, if it is an upper bound and $u \leq x$ for any other upper bound x of L' . If the least upper bound exists, then it is unique, for if u and u' are least upper bounds, then by definition we have $u \leq u'$ and $u' \leq u$. Symmetrically one defines the lower bound and the greatest lower bound which also turns out to be unique. In lattice theory, the least upper bound is often called *join* and the greatest lower bound is called *meet*.

Definition 4.13. A *lattice* is an ordered set (L, \leq) such that for any two elements $a, b \in L$ there is a join $j = a \vee b$ and a meet $m = a \wedge b$. We may denote a lattice as a quadruple (L, \leq, \wedge, \vee) where \wedge and \vee are the join and meet operations.

By induction one can show that in a lattice every finite subset has a join as well as a meet. A lattice is called *complete*, if this extends to all, not necessarily finite, subsets:

²Here we are not talking about contentful or semantic information, but merely about correlational information in the philosophical sense.

Definition 4.14. A lattice (L, \leq) is *complete*, if for all $L' \subseteq L$ there are a join $j = \bigvee L'$ and a meet $m = \bigwedge L'$.

A lattice (L, \leq, \wedge, \vee) is a *sublattice* of $(L', \leq', \wedge', \vee')$, if $L \subseteq L'$, for all $l_0, l_1 \in L$ we have

$$l_0 \leq l_1 \iff l_0 \leq' l_1,$$

and for all $L_0 \subseteq L$ we have that if $\bigwedge L_0$ exists, then $\bigwedge L_0 = \bigwedge' L_0$ and if $\bigvee L_0$ exists, then $\bigvee L_0 = \bigvee' L_0$. It is a *complete sublattice*, if (L, \leq) is a complete lattice.

Given a set non-empty $A \subseteq X^2$, the *equivalence relation generated by A*, denoted $\langle A \rangle$, is the smallest equivalence relation on X which contains all pairs that are in A , so

$$\langle A \rangle = \bigcap \{E \supseteq A \mid E \text{ is an equivalence relation on } X\},$$

or equivalently, $(x, x') \in \langle A \rangle$, iff there exist x_1, \dots, x_n such that the pairs

$$(x, x_1), (x_1, x_2), \dots, (x_{n-1}, x_n), (x_n, x')$$

are all in $A \cup A^T$ where $A^T = \{(x', x) \mid (x, x') \in A\}$.

Lemma 4.15. *If E is any equivalence relation such that $A \subseteq E$, then $\langle A \rangle \subseteq E$.*

Proof. Suppose $(x, x') \in \langle A \rangle$. Then there is a sequence of pairs

$$(x, x_1), (x_1, x_2), \dots, (x_{n-1}, x_n), (x_n, x')$$

that are all in $A \cup A^T$. Since $A \subseteq E$, also $A^T \subseteq E$ and so $A \cup A^T \subseteq E$, from which we see that all these pairs are in E . By transitivity of E , $(x, x') \in E$. \square

Definition 4.16. Let X be any set and let $\mathcal{E}(X)$ be the set of all equivalence relations on X . Then $(\mathcal{E}(X), \subseteq)$ is an ordered set. Given a set of equivalence relations $\mathcal{E} \subseteq \mathcal{E}(X)$, define

$$\bigwedge \mathcal{E} = \bigcap \mathcal{E} = \{(x_1, x_2) \in X^2 \mid (\forall E \in \mathcal{E})((x_1, x_2) \in E)\}$$

Then $\bigwedge \mathcal{E}$ is an equivalence relation such that $\bigwedge \mathcal{E} \subseteq E$ for all $E \in \mathcal{E}$, so it is a lower bound for \mathcal{E} . Define

$$\bigvee \mathcal{E} = \langle \bigcup \mathcal{E} \rangle = \bigcap \{E \supseteq \bigcup \mathcal{E} \mid E \text{ is an equivalence relation on } X\}.$$

Then $E \subseteq \bigvee \mathcal{E}$ for all $E \in \mathcal{E}$, so $\bigvee \mathcal{E}$ is an upper bound for \mathcal{E} .

Proposition 4.17. *Let $X, \mathcal{E}(X)$ and $\mathcal{E} \subseteq \mathcal{E}(X)$ be as above. Then $\bigvee \mathcal{E}$ and $\bigwedge \mathcal{E}$ are respectively the least upper bound and the greatest lower bound of \mathcal{E} . Consequently, $(\mathcal{E}(X), \subseteq)$ is a complete lattice.*

Proof. Suppose E_1 is a lower bound for \mathcal{E} . Then, by definition $E_1 \subseteq E$ for all $E \in \mathcal{E}$. But then $E_1 \subseteq \bigcap \mathcal{E}$, so $\bigwedge \mathcal{E}$ is the meet of \mathcal{E} .

Suppose E_0 is an upper bound for \mathcal{E} . Then, by definition $E \subseteq E_0$ for all $E \in \mathcal{E}$. But then $\bigcup \mathcal{E} \subseteq E_0$, and since E_0 is an equivalence relation, also $\langle \bigcup \mathcal{E} \rangle \subseteq E_0$. So $\bigvee \mathcal{E}$ is the join of \mathcal{E} . \square

4.4 Lattice of sufficient equivalence relations

We will prove in this section that if (X, U, τ) is an automaton, the sufficient equivalence relations form a complete sublattice of $(\mathcal{E}(X), \subseteq)$. Given an automaton $\mathcal{X} = (X, U, \tau)$, denote by $\mathcal{E}_{\text{suf}}^{U, \tau}(X) \subseteq \mathcal{E}(X)$ the set of sufficient equivalence relations on X . When U and τ are clear from the context, we write just $\mathcal{E}_{\text{suf}}(X) = \mathcal{E}_{\text{suf}}^{U, \tau}(X)$.

Theorem 4.18. *Suppose (X, U, τ) is an automaton and suppose that $\mathcal{E} \subseteq \mathcal{E}_{\text{suf}}(X)$ is a set of sufficient equivalence relations. Then $\bigwedge \mathcal{E}$ and $\bigvee \mathcal{E}$ are sufficient. Thus, $(\mathcal{E}_{\text{suf}}(X), \subseteq)$ is a complete sublattice of $(\mathcal{E}(X), \subseteq)$.*

Proof. For \bigwedge : Suppose $x, x' \in X$ are such that $(x, x') \in \bigwedge \mathcal{E}$ and $u \in U$. Since $\bigwedge \mathcal{E} = \bigcap \mathcal{E}$, we have that $(x, x') \in E$ for all $E \in \mathcal{E}$. Since all $E \in \mathcal{E}$ are sufficient, it follows that $(\tau(x, u), \tau(x', u)) \in E$ for all $E \in \mathcal{E}$, and so $(\tau(x, u), \tau(x', u)) \in \bigcap \mathcal{E} = \bigwedge \mathcal{E}$.

For \bigvee : Suppose $x, x' \in X$ are such that $(x, x') \in \bigvee \mathcal{E}$ and $u \in U$. By the definition of $\bigvee \mathcal{E}$ there exist $z_1, \dots, z_k \in X$ such that $x = z_1$, $x' = z_k$ and for all $i < k$ there is $E_i \in \mathcal{E}$ such that $(z_i, z_{i+1}) \in E_i$. By the sufficiency of each E_i , we have then that $(\tau(z_i, u), \tau(z_{i+1}, u)) \in E_i$ and so the sequence $\tau(z_1, u), \dots, \tau(z_k, u)$ witnesses that $(\tau(x, u), \tau(x', u)) \in \bigvee \mathcal{E}$. \square

Suppose that a labeling h is very important for an agent. For example, h could be “death or life”, or it could be relevant for a robot’s task. Suppose that h is not sufficient. The robot may want to find a sufficient refinement of h . Clearly a one-to-one h' would do. However, assume that the agent has to use resources for distinguishing between states; thus, the fewer distinctions the better. This motivates the following definition. Recall Definition 4.12 of refinements.

Definition 4.19. Let (X, U, T) be a transition system and $E_0 \subseteq X \times X$ an equivalence relation. A *minimal sufficient refinement* of E_0 is a sufficient equivalence relation E which is a refinement of E_0 such that there is no sufficient E' with $E_0 \leq_r E' <_r E$.

Given a labeling h_0 of a transition system (X, U, T) , a *minimal sufficient refinement* of h_0 is a labeling h such that E^h is a minimal sufficient refinement of E^{h_0} (recall Definition 2.34).

Example 4.20. Let $\mathcal{X} = (X, U, \tau)$ be an automaton where $X = \{0, 1\}^*$, $U = \{0, 1\}$ and $\tau(x, b) = x \frown b$ (concatenation of the binary string x with the bit b). Let $h(x) = 1$ if and only if the number of ones and the number of zeros in x are both prime; otherwise $h(x) = 0$. Then the only sufficient refinements of h are one-to-one.

Example 4.21. Let \mathcal{X} be as above and let $h: X \rightarrow \{0, 1\}$ be such that if $|x|$ is divisible by 3, then $h(x) = 1$; otherwise, $h(x) = 0$. Then h is not sufficient. Let $h': x \mapsto \{0, 1, 2\}$ be such that

$$h'(x) \equiv |x| \pmod{3}.$$

Then h' is a minimal sufficient refinement of h .

Theorem 4.22. *Consider an automaton $\mathcal{X} = (X, U, \tau)$ and let E_0 be an equivalence relation on X . Then a minimal sufficient refinement of E_0 exists and is unique.*

Proof. Let \mathcal{E} be the set of all sufficient equivalence relations $E \subseteq E_0$. Then \mathcal{E} is non-empty, because the identity-relation $\{(x_1, x_2) \in X^2 \mid x_1 = x_2\}$ is a sufficient refinement of E_0 . Let $E = \bigvee \mathcal{E}$. By Lemma 4.15 we have $E \subseteq E_0$, so E is a refinement of E_0 , and by Theorem 4.18 E is sufficient. On the other hand if E' is a sufficient refinement of E_0 , then $E' \in \mathcal{E}$ and so

$E' \subseteq E$, so E is $<_r$ -minimal. The same argument proves the uniqueness too: if E' is another minimal sufficient refinement of E_0 , then again $E' \in \mathcal{E}$ and so $E' \subseteq E$. But $E' \subsetneq E$ would contradict the minimality of E' , so we must have $E' = E$. \square

Theorem 4.22 fails, if “automaton” is replaced by “transition system”, or if “sufficient” is replaced by “ n -sufficient” for $n > 1$ (recall Definition 4.7)

Example 4.23 (Failure of uniqueness for n -sufficiency). Let $X = \{0, 1, 2, 3, 4, 5\}$, $U = \{u_0\}$ and

$$\tau(0, u_0) = 1, \tau(1, u_0) = 2, \tau(2, u_0) = 2,$$

and

$$\tau(3, u_0) = 4, \tau(4, u_0) = 5, \tau(5, u_0) = 5.$$

Let E_0 be an equivalence relation on X such that the equivalence classes are $\{0, 1, 3, 4\}$, $\{2\}$ and $\{5\}$. Then this relation is not 2-sufficient, because $(0, u_0, 1, u_0, 2)$ and $(3, u_0, 4, u_0, 5)$ are $(T, E_0, 2)$ -equivalent, but 2 and 5 are not E_0 -equivalent. Let $E_1, E_2 \subseteq E_0$ be an equivalence relation with equivalence classes as follows:

$$E_1 : \{0, 3\}, \{1, 4\}, \{2\}, \{5\},$$

$$E_2 : \{0, 4\}, \{1, 3\}, \{2\}, \{5\}.$$

Then E_1 and E_2 are refinements of E_0 . They are both 2-sufficient, because there doesn't exist any $(T, E_1, 1)$ or $(T, E_2, 1)$ equivalent 2-chains. They are also both \leq_r -minimal with this property which can be seen from the fact that they are actually \leq_r -minimal refinements of E_0 as equivalence relations (not only as sufficient ones).

Example 4.24 (Failure of uniqueness for transition systems). Let $X = \{0, 1, 2, 3, 4\}$, $U = \{u_0\}$ and $T = \{(0, u_0, 3), (2, u_0, 4)\}$. Let E_0 be the equivalence relation with the equivalence classes $\{0, 1, 2\}$, $\{3\}$ and $\{4\}$. Then E_0 is not sufficient, because $(0, 2) \in E_0$, but $(3, 4) \notin E_0$. Let E_1 and E_2 be the refinements of E_0 with the following equivalence classes:

$$E_1 : \{0, 1\}, \{2\}, \{3\}, \{4\},$$

$$E_2 : \{0\}, \{1, 2\}, \{3\}, \{4\}.$$

Now it is easy to see that both E_1 and E_2 are sufficient refinements of E_0 , and by a similar argument as in Example 4.23 they are both minimal. The reason why this is possible is the odd behaviour of the state 2 which doesn't have out-going connections. Such odd states are the reason why the decision problem “Does there exist a sufficient refinement with k equivalence classes?” is NP-complete for finite transition systems.

Remark. It is worth noting that Theorems 4.18 and 4.22 do not assume anything about the cardinality of X or of U , other structure on them (such as metric or topology) nor anything about the function τ or the relation E_0 . Keeping in mind potential applications in robotics, X and U could be, for instance, topological manifolds, and τ a continuous function, or X could be a closed subset of \mathbb{R}^n , U discrete and τ a measurable function, or any other combination of those. In each of those cases, the sublattice of sufficient equivalence relations is complete, as per Theorem 4.18, and every equivalence relation E_0 on X admits a unique minimal sufficient refinement as per Theorem 4.22.

Recall Definition 2.10 of an equivalence relation preserving function. We say that an equivalence relation E on X is *closed under f* : $X \rightarrow X$ if for all $x \in X$, we have $(x, f(x)) \in E$. If E is closed under f , then f is E -preserving: given $(x, x') \in E$, we have $(x, f(x)), (x', f(x')) \in E$, because E is closed under f . Now by transitivity of E we have $(f(x), f(x')) \in E$, so f is E -preserving.

Definition 4.25. Let $f: X \rightarrow X$ be a bijection. The induced *orbit equivalence relation* is the relation E_f on X defined by $(x, x') \in E_f \iff (\exists n \in \mathbb{Z})(f^n(x) = x')$, in which $f^n(x)$ is defined by induction as: $f^0(x) = x$, $f^{n+1}(x) = f(f^n(x))$, $f^{-1}(x) = f^{-1}(f^n(x))$.

Theorem 4.26. *If f is an automorphism of the automaton (X, U, τ) , then E_f is a sufficient equivalence relation.*

Proof. Suppose $(x, x') \in E_f$. Then there is n such that $x = f^n(x')$. Now

$$\tau(x, u) = \tau(f^n(x'), u) = f^n(\tau(x', u)).$$

The last equality follows from the fact that f is an automorphism. By definition, this means that $(\tau(x, u), \tau(x', u)) \in E_f$. \square

Theorem 4.27. *Let $\mathcal{X} = (X, U, \tau)$ be an automaton and E be an equivalence relation on X . Suppose $f: X \rightarrow X$ is an automorphism such that E is closed under f . Let E' be the minimal sufficient refinement of E . Then E' is closed under f and $E \leq_r E' \leq_r E_f$.*

Proof. Since E is closed under f , E_f is a refinement of E . By Theorem 4.26, E_f is also sufficient, so by \leq_r -minimality of E' , we have $E_f \subseteq E'$ which implies that E' is closed under f . \square

Example 4.28. Consider the environment which is a one-dimensional lattice of length five, $E = \{-2, -1, 0, 1, 2\}$, in which the corners “smell bad”; thus, we have a sensor mapping $h: E \rightarrow S$, $S = \{0, 1\}$ defined by $h(n) = 0 \iff |n| = 2$; see Figure 6(a). Consider two agents in this environment. Both are equipped with the same h sensor, but their action repertoires differ. Both have two possible actions. One has actions $L =$ “move left one space” and $R =$ “move right one space”, and the other one has actions $T =$ “turn 180 degrees” and $F =$ “go forward one space”. Let $M_0 = \{L, R\}$ and $M_1 = \{T, F\}$. Thus, these agents have a slight difference in embodiment. Although both of them can move to every square of the lattice in a very similar way (almost indistinguishable from the outside perspective), we will see that the differences in embodiment will be reflected in that the minimal sufficient refinements will produce non-equivalent “categorizations” of the environment. The structures that emerge from these two embodiments will be different.

First, we define the SM-systems that model these agents’ embodiments in E . The first agent does not have orientation. It can be in one of the five states, and the state space is $X_0 = E$. For the second agent, the effect of the F action depends on the orientation of the agent (pointing left or pointing right). Thus, there are ten different states the agent can be in, yielding $X_1 = E \times \{-1, 1\}$. The effects of motor outputs are specified completely (L means moving left, and so on), whereas the agent’s internal mechanisms are left completely open, so our systems will be quasifilters. According to Remark 2.18, we can work with a labeled automaton instead. Hence, let $\tau_0: X_0 \times M_0 \rightarrow X_0$ be defined by $\tau_0(x, L) = \max(x - 1, -2)$ and $\tau_0(x, R) = \min(x + 1, 2)$. For the other agent, let $\tau_1((x, b), T) = (x, -b)$ and $\tau_1((x, b), F) = (\min(\max(x + b, -2), 2), b)$. Now we have labeled automata $\mathcal{X}_0 = (X_0, M_0, \tau_0, h, S)$ and $\mathcal{X}_1 = (X_1, M_1, \tau_1, h, S)$.

It is not hard to see that the one-to-one map $h_0: X_0 \rightarrow \{-2, -1, 0, 1, 2\}$ with $h_0(x) = x$ is a sufficient refinement of h which is minimal (see Figure 7(a)). Thus, every state needs to be distinguished by the agent for it to be possible to determine the following sensation from the current one. The derived information space automaton \mathcal{X}_0/h_0 isomorphic to \mathcal{X}_0 (Proposition 2.36).

For the second automaton, consider the labeling $h_1: X_1 \rightarrow \{-2, -1, 0, 1, 2\}$ defined by $h_1(x, b) = b \cdot x$ (see Figure 7(b)).

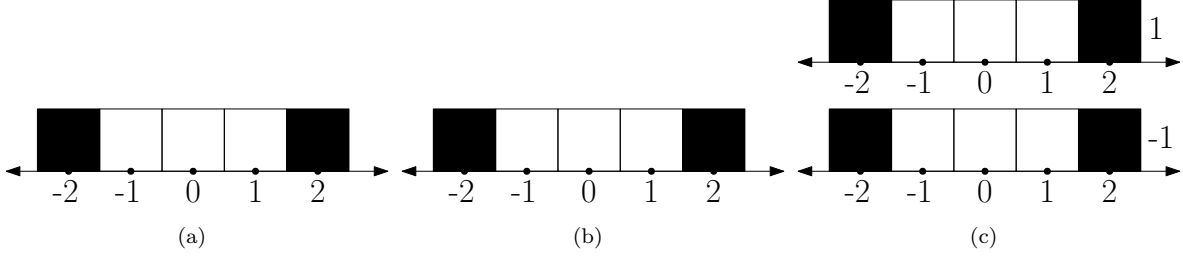

Figure 6: (a) One-dimensional lattice environment described in Example 4.28. (b) State space of the agent 0. (c) State space of the agent 1. The states for which the value of the sensor mapping is 0 are shown in black.

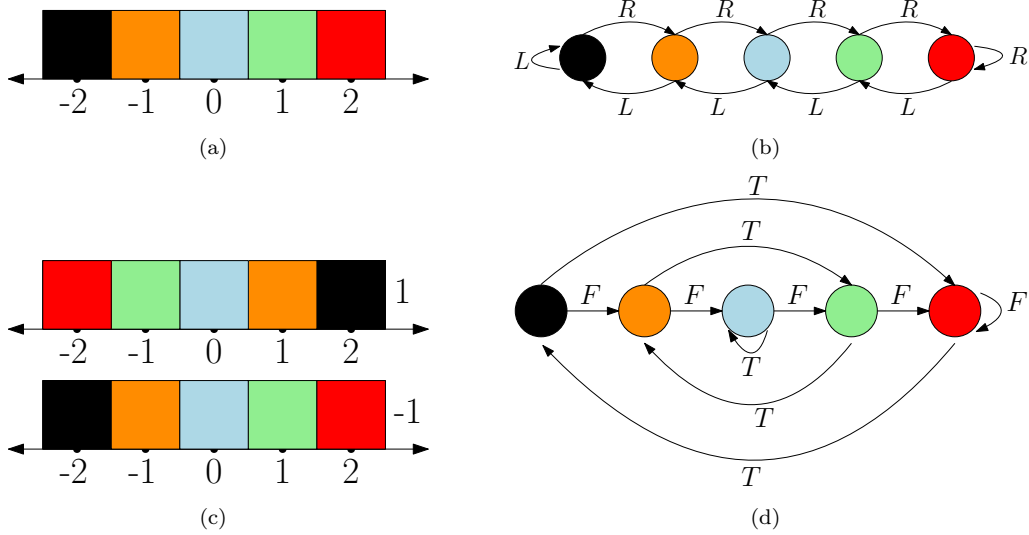

Figure 7: (a) State space of the agent 0 categorized by h_0 , states that belong to the same class are colored with the same color. (b) Resulting quotient \mathcal{X}_0/h_0 for the agent 0. (c) State space of the agent 1 categorized by h_1 , states that belong to the same class are colored with the same color. (d) Resulting quotient \mathcal{X}_1/h_1 for the agent 1.

Claim. h_1 is a minimal sufficient refinement of h in \mathcal{X}_1 .

Proof. We will show that the equivalence relation E^{h_1} is the minimal sufficient refinement of E^h (Definition 2.34). Let $f: X_1 \rightarrow X_1$ be defined by $f(x, b) = (-x, -b)$. Then f is an automorphism of \mathcal{X}_1 and $E_f = E^{h_1}$, so E^{h_1} is sufficient and any minimal sufficient refinement E of E^h must satisfy $E \leq_r E^h$.

In the base labeling h , moving forward from $(1, 1)$ results in a different sensation than moving forward from $(1, -1)$, so they must be E -non-equivalent. But then inductively this also applies to their neighbours $(0, 1)$ and $(0, -1)$ as well as $(2, 1)$ and $(2, -1)$ and so on. Thus E^{h_1} is in fact minimal. \square

Both minimal sufficient labelings, h_0 and h_1 have five values; thus, they categorize the environment into five distinct state-types. However, the resulting derived information spaces are different in the sense that the quotients \mathcal{X}_0/h_0 and \mathcal{X}_1/h_1 are not isomorphic; compare Figure 7(b) with Figure 7(d).

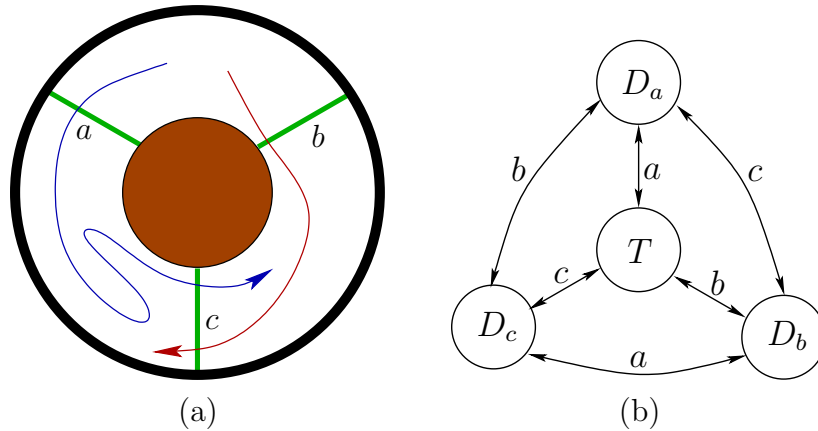

Figure 8: (a) Two point-sized independent bodies move along continuous paths in an annulus-shaped region in the plane. There are three sensor beams, a , b , and c . When each is crossed by a body, its corresponding symbol is observed. Based on receiving a string of observations, the task is to determine whether the two bodies are together in the same region, with no beam separating them. (b) The minimal filter as a transition system has only 4 states: T means that they are together, and D_x means that are in different regions but beam x separates them. Each transition is triggered by the observation when a body crosses a beam.

Example 4.29. Figure 8(a) shows a filtering example from (Tovar, Cohen, Bobadilla, Czarnowski, & LaValle, 2014). More complex versions have been studied more recently in (O’Kane & Shell, 2017), and are found through automaton minimization algorithms and some extensions. It can be shown that this example’s four-state derived information space depicted on Figure 8(b) corresponds to the unique minimal sufficient refinement of the the labeling that only distinguishes between “are in the same region” and “are not in the same region”. To see this, first note that this labeling is sufficient (since it can be represented as an automaton, this follows from Theorem 4.5). It follows from Theorem 4.22 that if this labeling is not minimal, then there is a minimal one which is strictly coarser, and so can be obtained by merging the states in the automaton of Figure 8(b). This is impossible: the state T cannot be merged with anything because it violates the base-labeling; if, say D_a and D_c , are merged, then transition a will lead to inconsistency as it can lead either to D_b (from D_c) or to T (from D_a). This proves that this derived information space is indeed minimal sufficient, and by Corollary 4.22 there are no others up to isomorphism.

4.5 Computing sufficient refinements

This section sketches some computational problems and presents computed examples. The problem of computing the minimal sufficient refinement in some cases reduces to classical deterministic finite automaton (DFA) minimization, and in other cases it becomes NP-hard (O’Kane & Shell, 2017).

Consider an automaton (X, M, τ) and a labeling function h_0 , and the corresponding labeled automaton described using the quintuple (X, M, τ, h_0, L) . Suppose that the automaton (X, M, τ) corresponds to that of an body-environment system. Hence, X corresponds to the states of this coupled system. Suppose h_0 is not sufficient and consider the problem of computing a (minimal) sufficient refinement of h_0 , that is, the coarsest refinement of h_0 that is sufficient.

Despite the uniqueness of the minimal sufficient refinement of h_0 (by Corollary 4.22), we can argue that the formulation of the problem, in particular, the input, can differ based on the level at which we are addressing the problem (for example, global perspective, agent perspective or something in between). Since the labeled automaton corresponding to an agent-environment coupling is described from a global perspective, the input to an algorithm that addresses the problem from this perspective is the labeled automaton $\mathcal{A} = (X, \tau, M, h_0, L)$ itself. Then, the problem is defined as given \mathcal{A} compute $\mathcal{A}' = (X, M, \tau, h, L)$ such that h is the minimal sufficient refinement of h_0 .

A special case of this problem from the global perspective occurs if the preimages of h_0 partition X in two classes which can be interpreted as the “accept” and “reject” states, for example, goal states at which the agent accomplishes a task and others. Furthermore, suppose that the initial state of the agent is known to be some $x_0 \in X$. Then, computing a minimal sufficient refinement becomes identical to minimization of a finite automaton, that is, given a DFA (X, M, τ, x_0, F) in which x_0 is the initial state and F is the set of accept states find (X', M, τ', x'_0, F') such that no DFA with fewer states recognizes the same language. Existing algorithms, for example (Hopcroft, 1971), can be used to compute a minimal automaton.

Here, we also consider this problem from the agent’s perspective for which the information about the environment states is obtained through its sensors, more generally, through a labeling function. Note that by agent’s perspective we do not necessarily imply that the agent is the one making the computation (or any computation) but it means that no further information can be gathered regarding the environment other than the actions taken and what is sensed by the agent. At this level we address the following problem; given a set M of actions, a domain X , and a labeling function h_0 defined on X , compute the minimal sufficient refinement of h_0 . The crux of the problem is that unlike the global perspective described above, the labeled automaton \mathcal{A} is not given, in particular, the state transitions are not known a priori. Instead, the information regarding the state transitions can only be obtained locally by means of applying actions and observing the outcomes, that is, through sensorimotor interactions. Hence, the current body-environment state is also not observable. To show that an algorithm exists to compute a sufficient refinement of h_0 at this level, we propose an iterative algorithm (Algorithm 1) that explores X through agent’s actions and sensations by keeping the history information state, that is, the history of actions and sensations (labels). We then show, by empirical results, that the sufficient refinement computed by Algorithm 1 is minimal for the selected problem.

The functioning of Algorithm 1 is as follows. Starting from an initial sensation $s_0 = h(x_0)$,

Algorithm 1

```

1: Input:  $h_0, l_0, M$ 
2: Initialize:  $H \leftarrow \emptyset, h \leftarrow h_0, s \leftarrow s_0$ 
3: for each step do
4:    $m \leftarrow \text{policy}(s)$ 
5:   apply action  $m$  and obtain resulting  $s'$ 
6:   add  $(s, m, s')$  to  $H$ 
7:   if  $\exists (s, m, s'') \in H$  such that  $s' \neq s''$  then
8:      $h \leftarrow \text{split}(h, s)$ 
9:   if there are labels that can be merged then
10:     $h \leftarrow \text{merge}(h, H, h_0)$ 
11:    $s \leftarrow s'$ 

```

the agent moves by taking an action³ given by the mapping policy : $L \rightarrow M$. Particularly, we used a fixed policy which samples an action m from a uniform distribution over M for each $s \in S$. In principle, any policy that ensures all states that are reachable from x_0 will be visited infinitely often should be enough. The history information state is implemented as a list, denoted by H , of triples (s, m, s') such that $s = h(x)$ and $s' = h(x')$ in which $x' = \tau(x, m)$. At each step, it is checked whether the current sensation is consistent with the history (Line 7). Current sensation is inconsistent with the history if there exists a triple (s, m, s'') in the history such that $s' \neq s''$. If it is not consistent then the label is split, which means that $h^{-1}(s)$ is partitioned into two parts P and Q . In particular, we apply a balanced random partitioning, that is, we select P and Q randomly from a uniform distribution over the partitions of $h^{-1}(s)$ that have two elements with balanced cardinalities. The labeling function is updated by a split operation as

$$h(x) := \begin{cases} s_Q & \text{if } x \in Q \\ s_P & \text{if } x \in P \\ h(x), & \text{otherwise.} \end{cases}$$

Recall that labels or subscripts do not carry any meaning from the agent's perspective.

Even a trivial strategy that splits the preimage of the label seen at each step would succeed computing a sufficient refinement. However, this would result in h being a one-to-one mapping. Hence, the finest possible refinement. Splitting only at the instances when an inconsistency is detected might reach a coarser refinement that is sufficient but there might be more equivalence classes than the ones induced by the minimal sufficient refinement of h_0 . Therefore, a merge operation is introduced (Line 10). Let s and s' be two distinct labels for which $\exists s'' \in h_0[X]$ such that $h^{-1}(s) \subseteq h_0^{-1}(s'')$ and $h^{-1}(s') \subseteq h_0^{-1}(s'')$. Let t denote a triple in H and let t_k , $k = 1, 2, 3$, denote the k^{th} element of that triple. Suppose $s' = s$, if there are at least N number of triples in H such that for each triple t , $(t_1, t_2) = (s, m)$ and $\forall m \in M$ and $\forall t, t' \in H$ such that $(t_1, t_2) = (t'_1, t'_2) = (s, m)$ it is true that $t_3 = t'_3$ then labels s and s' are merged. The merge procedure goes through all labels and updates h as

$$h(x) := \begin{cases} s & \text{if } h(x) \in \{s, s'\} \\ h(x) & \text{otherwise.} \end{cases}$$

³This can either be in a real environment or in a realistic simulation.

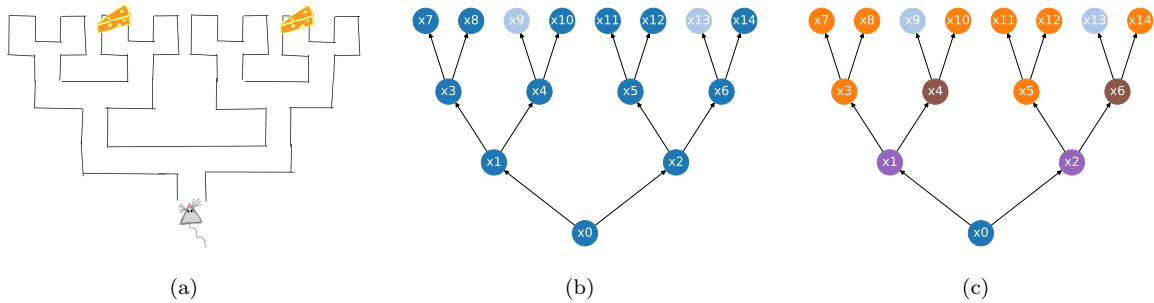

Figure 9: (a) Cheese maze defined in Example 4.30 (b) Labeled automaton with initial labeling h_0 corresponding to the cheese-maze example. (c) Minimal sufficient refinement of h_0 . Self-loops at the leaf nodes are not shown in the figure.

for each pair of labels s and s' that satisfies the aforementioned condition. Note that in principle, one can merge two labels regardless of the number of occurrences in the history. However, we noticed that this can result in oscillatory behaviour between split and merge operations especially for states that are reached less frequently. At present, we considered N as a tunable parameter and we know that it depends on the cardinality of the state space X such that larger the number of states, larger N should be. The problem of defining N as a function of the problem description remains open.

In the following, we present an illustrative example to show the practical implications of the previously introduced concepts in Section 4.2. In particular, we show how a simple algorithm like Algorithm 1 can be used by a computing unit which relies only on the sensorimotor interactions of an agent to further categorize the environment such that there are no inconsistencies in terms of the actions taken by the agent and the resulting sensations with respect to an initial categorization induced by h_0 .

Example 4.30. Consider an agent (a mouse) that is placed in a maze where certain paths lead to cheese and others do not (see Figure 4.5(a)). At each intersection the agent can go either left or right and it can not go back. Hence, at each step the agent takes one of the two actions; go right or go left. Figure 4.5(b) shows the corresponding automaton with 15 states describing the agent-environment system together with the initial labeling h_0 that partitions the state space into states in which the agent has reached a cheese (light blue) and others (dark blue). The initial state x_0 is when the agent is at the entrance of the maze. Once the end of the maze is reached (a leaf node) the state does not change regardless of which action is taken. After a predetermined number of steps the system reverts back to the initial state, similar to an episode in the reinforcement learning terminology (see, for example, (Sutton & Barto, 2018)). However, despite the system going back to the initial state the history information state still includes the prior actions and sensations. Figure 10 reports the updates of h , initialized at h_0 , by Algorithm 1 being run for 1000 steps. It converged to a final labeling h (Figure 10(r)), that is the minimal sufficient refinement of h_0 , in 435 steps. For 20 initializations of Algorithm 1 for the same problem, on average, it took 364 steps to converge to a minimal sufficient refinement of h_0 .

We have also applied the same algorithm to variations of this example with different depths of maze and different number of cheese and cheese placements (varying h_0). Empirical evidence

shows that the same algorithm was capable of consistently finding the minimal sufficient refinement of the initial labeling. However, it is likely that it might fail for more complicated problems, for example, when the number of actions are significantly larger. It remains an open problem finding a provably correct algorithm for computing the minimal sufficient refinement of h_0 from the agent’s perspective.

4.6 Sufficiency for coupled SM-systems

Section 2 introduced SM-systems, including the special class of quasifilters. We showed that quasifilters can be thought of as labeled transition systems, and we worked with such systems in Sections 4 and 4.5. Let us see how do the concepts introduced in those sections work for SM-systems. We also defined *coupling* of SM-systems (Definition 2.22), but we have not defined what it means for a coupling to be “good”. We will use sufficiency to approach this subject.

Let $\mathcal{E} = (E, (S \times M), T)$ and $\mathcal{I} = (I, S \times M, B)$ be SM-systems. We think intuitively of \mathcal{E} as “the environment” and \mathcal{I} as the “agent”, even though they share the set of sensorimotor parameters $S \times M$. When is the coupling $\mathcal{E} * \mathcal{I}$ “successful”? Given another $\mathcal{I}' = (I', S \times M, B')$, how can we compare \mathcal{I} and \mathcal{I}' in the context of \mathcal{E} ? The coupled system $\mathcal{E} * \mathcal{I}$ is not labeled; therefore, we cannot apply the definition of sufficiency. However, as soon as we apply some labeling to it, we can. There are many different ways to do it, intuitively corresponding to the “agent’s perspective”, the “environment’s perspective” and a “god’s perspective” (or “global perspective”).

The first one is the labeling $h: E \times I \rightarrow I$, which is the projection to the right coordinate, $h_I(e, i) = i$. The second one is the projection to the left coordinate $h_E(e, i) = i$, and the third one is the labeling of states by themselves, $h_G(e, i) = (e, i)$. Clearly, h_G is a refinement of both h_E and h_I . Yet another option is to use the sensory data as labelings, which is a coarser labeling than h_I . Or perhaps there was already a labeling $h: E \rightarrow S$ to begin with, so then we can ask about the property of $\hat{h}: E \times I \rightarrow S$ defined by $\hat{h}(e, i) = h(e)$. We focus on what we called the agent’s perspective, h_I , for the rest of this section.

Recall Definition 4.11 of the degree of insufficiency. Given SM-systems \mathcal{E} (environment) and \mathcal{I} (agent), we can ask what is the degree of insufficiency of h_I in $\mathcal{E} * \mathcal{I}$? The smaller the degree, the better the agent is attuned to the environment. This says something about the way in which the agent is adapted or attuned to the environment without attributing contentful states or representations to the agent in alignment with (EA2) and (EA4).

Let \mathcal{E} , \mathcal{I} , and \mathcal{I}' be SM-systems. When is $\text{degins}(\mathcal{E} * \mathcal{I}, h_I) < \text{degins}(\mathcal{E} * \mathcal{I}', h_{I'})$? Of course, if \mathcal{I} is fully constrained (Definition 2.31), then $\text{degins}(\mathcal{E} * \mathcal{I}) = \infty$. This corresponds to the agent never engaging in any sensorimotor interaction with the environment. No wonder that it can always “predict” the result of such passive existence. Assume, however, that there some constraints on the coupling. For example, we may demand that the agent must regularly visit states of some particular type to survive. Subject to such constrains, what can we say about $\text{degins}(\mathcal{E} * \mathcal{I})$? This seems to be a good preliminary notion⁴ of attunement.

5 Discussion

In the introduction we defined our basic enactivist tenets:

⁴Further research will indicate how much of this will be accepted by the most radical enactivists.

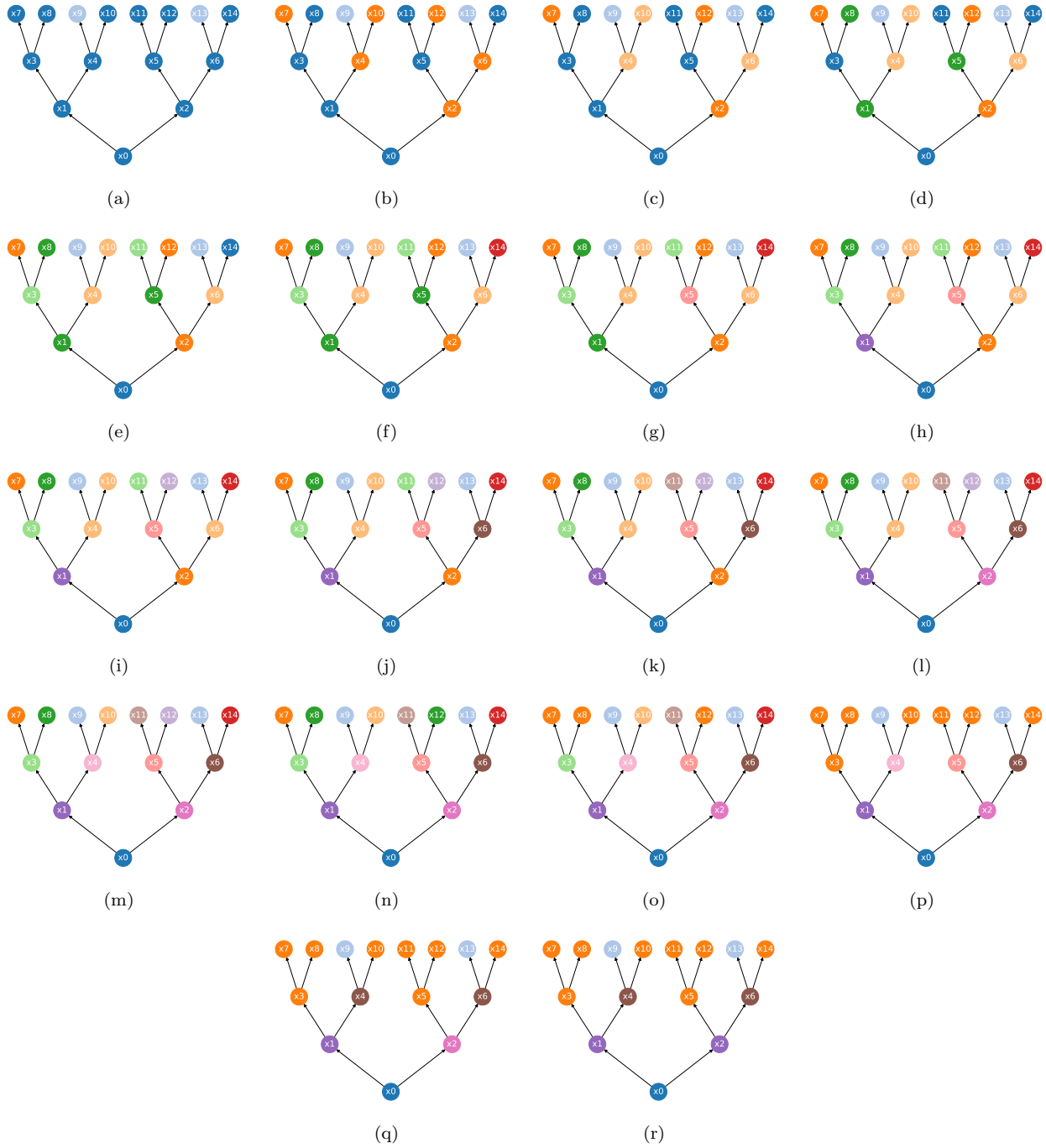

Figure 10: (a) Labeled automaton with labeling function $h = h_0$; same colored states belong to the same equivalence class. (b-q) Updating h by Algorithm 1 through splitting and merging of the labels. (r) Labeled automaton with the labeling function h that is the minimal sufficient refinement of h_0 .

- (EA1) Embodiment and the inseparability of the brain-body-environment system,
- (EA2) Grounding in sensorimotor interaction patterns, not in contentful representations.
- (EA3) Emergence from embodiment, enactment of the world,
- (EA4) Attunement, adaptation, and skill as possibilities to reliably engage in complicated patterns of activity with the environment.
- (EA5) Perception as sensorimotor skills.

We developed a model of sensorimotor systems and coupling for which the purpose is to account for cognition mathematically, but in congruence with the principles (EA1)–(EA5). The principle (EA1) is intrinsic in the ways SM-systems are supposed to model brain-body and body-environment dynamics. The central ingredient is the control set $S \times M$ in all of those systems which include “motor” and “sensory” part; it is *impossible* in our framework to model say the environment without acknowledging the way in which the body is *part of* it. The approach that the actions of an agent depend solely on the history of its sensorimotor interactions with the environment, our approach is well in the scope of (EA2). We do not assume any representational or symbolic content possessed by the SM-systems. We do not evaluate them by the “correctness” of their internal states, but rather by the ways in which they are, or can be, coupled to the environment and whether their sensory apparatus generates a sufficient sensor mapping or not. Coupling of SM-systems is defined so that two systems constrain each other. Thus, when an agent is coupled to the environment, they constrain each other, thereby creating new global properties of the body-environment system. The (EA3) tenet of emergence of global properties from local ones naturally arises in the framework through notions of coupling and sufficiency via sensorimotor activity, as well as the dynamical systems approach which was alluded in Remark 2.25 The principle (EA4) is mostly discussed in connection with minimal sufficient refinements. Given a labeling, or a categorization, or an equivalence relation on the state space, one can ask how well does this labeling “predict itself”. The interpretation of this labeling can be anything from a sensor mapping to the labeling of environmental states by the internal states of the agent which coincide with them (this is not representation, this is mere co-occurrence; see enactivist interpretation of the place cells in (Hutto & Myin, 2017) for comparison). A sufficient sensor mapping can be achieved in many different ways. In Section 4.5 we present a way in which the agent “develops” new sensors to be better attuned to the environment and in that way finds a sufficient sensor mapping. Another way for the agent would be to learn to act in a way that excludes “unpredictability”. Both are examples of situations where the agent “structures” its own body-environment reality and gains skill. Finally, perception (EA5) can be understood as sensorimotor patterns on a microlevel. Can the agent engage in a sensorimotor activity locally without making big moves, such as moving the eyes without moving the body? The result of such sensorimotor interaction is another labeling function on a macro level.

In this paper, we not only presented mathematical definitions, but proved a number of propositions and theorems about them. There would be (and we hope there will be!) much more of them, but they did not fit in this expository work for which the main purpose was to demonstrate the connection of the mathematics in question with the enactive philosophy of mind. We have already developed more concepts and theorems on top of this framework,

including notions of *degree of insufficiency*, *universal covers*, *hierarchies*, and *strategic sufficiency*, but these are omitted here due to space limitations. In other, more mathematical work, we plan to concentrate on working out mathematical and logical details of the proposed theory as well as applying the ideas to fundamental questions in robotics and autonomous systems, control theory, machine learning, and artificial intelligence.

References

- Başar, T., & Olsder, G. J. (1995). *Dynamic noncooperative game theory, 2nd ed.* London: Academic.
- Bertsekas, D. P. (2001). *Dynamic programming and optimal control, vol. i, 2nd ed.* Belmont, MA: Athena Scientific.
- Blum, M., & Kozen, D. (1978). On the power of the compass (or, why mazes are easier to search than graphs). In *Proceedings annual symposium on foundations of computer science* (p. 132-142).
- Chalopin, J., Das, S., Disser, Y., Mihalak, M., & Widmayer, P. (2013). Mapping simple polygons: How robots benefit from looking back. *Algorithmica*, 65(1), 43-59.
- Choset, H., Lynch, K. M., Hutchinson, S., Kantor, G., Burgard, W., Kavraki, L. E., & Thrun, S. (2005). *Principles of robot motion: Theory, algorithms, and implementations.* Cambridge, MA: MIT Press.
- Donald, B. R. (1995). On information invariants in robotics. *Artificial Intelligence Journal*, 72, 217-304.
- Donald, B. R., & Jennings, J. (1991). Sensor interpretation and task-directed planning using perceptual equivalence classes. In *Proc. int'l conf. on robotics and automation* (p. 190-197).
- Erdmann, M. A. (1993). Randomization for robot tasks: Using dynamic programming in the space of knowledge states. *Algorithmica*, 10, 248-291.
- Fodor, J. (2008). *Lot 2: The language of thought revisited.* OUP Oxford. Retrieved from <https://books.google.co.il/books?id=Gf0QJ2k7nHkC>
- Fraigniaud, P., Ilcinkas, D., Peer, G., Pelc, A., & Peleg, D. (2005, December). Graph exploration by a finite automaton. *Theoretical Computer Science*, 345(2-3), 331-344.
- Friston, K. (2010). The free-energy principle: a unified brain theory? *Nature Reviews Neuroscience*, 11(2), 127-138.
- Friston, K., & Kiebel, S. (2009). Predictive coding under the free-energy principle. *Philosophical Transactions of the Royal Society of London B: Biological Sciences*, 364(1521), 1211-1221.
- Fuchs, T. (2020). The circularity of the embodied mind. *Frontiers in Psychology*, 11, 1707. Retrieved from <https://www.frontiersin.org/article/10.3389/fpsyg.2020.01707> doi: 10.3389/fpsyg.2020.01707
- Gallagher, S. (2017). *Enactivist interventions: Rethinking the mind.* Oxford University Press.
- Gallagher, S. (2018). Decentering the brain: Embodied cognition and the critique of neurocentrism and narrow-minded philosophy of mind. *Constructivist Foundations*, 14(1).
- Gallistel, C. R., & King, A. (2009). *Memory and the computational brain.* Malden: Wiley-Blackwell.

- Ghallab, M., Nau, D., & Traverso, P. (2004). *Automated planning: Theory and practice*. San Francisco, CA: Morgan Kaufman.
- Goranko, V., & Otto, M. (2007). 5 model theory of modal logic. In P. Blackburn, J. Van Benthem, & F. Wolter (Eds.), *Handbook of modal logic* (Vol. 3, p. 249-329). Elsevier. doi: [https://doi.org/10.1016/S1570-2464\(07\)80008-5](https://doi.org/10.1016/S1570-2464(07)80008-5)
- Hager, G. D. (1990). *Task-directed sensor fusion and planning*. Boston, MA: Kluwer.
- Hatcher, A. (2002). *Algebraic topology*. Cambridge University Press.
- Hopcroft, J. (1971). An $n \log n$ algorithm for minimizing states in a finite automaton. In *Theory of machines and computations* (pp. 189–196). Elsevier.
- Huang, W. H., & Beevers, K. R. (2005). Loop closing in topological maps. In *Proc. int'l conf. on robotics and automation* (p. 4378-4383).
- Hutto, D. D., & Myin, E. (2012). *Radicalizing enactivism: Basic minds without content*. MIT Press.
- Hutto, D. D., & Myin, E. (2017). *Evolving enactivism*. MIT Press.
- Kaelbling, L. P., Littman, M. L., & Cassandra, A. R. (1998). Planning and acting in partially observable stochastic domains. *Artificial Intelligence Journal*, 101.
- Kechris, A. S. (1994). *Classical descriptive set theory* (Vol. 156). Springer-Verlag, Graduate Texts in Mathematics.
- Kumar, P. R., & Varaiya, P. (1986). *Stochastic systems*. Englewood Cliffs, NJ: Prentice-Hall.
- LaValle, S. M. (2006). *Planning algorithms*. Cambridge, U.K.: Cambridge University Press.
- LaValle, S. M. (2012). *Sensing and filtering: A fresh perspective based on preimages and information spaces* (Vol. 1:4). Delft, The Netherlands: Now Publishers.
- LaValle, S. M. (2019). Sensor lattices: Structures for comparing information feedback. In *Proc. IEEE/IFAC 12th international workshop on robot motion and control* (p. 239-246).
- Lozano-Pérez, T., Mason, M. T., & Taylor, R. H. (1984). Automatic synthesis of fine-motion strategies for robots. *International Journal of Robotics Research*, 3(1), 3-24.
- Newell, A., & Simon, H. A. (1972). *Human problem solving*. Prentice-Hall.
- Noë, A. (2004). *Action in perception*. MIT press.
- O’Kane, J. M., & LaValle, S. M. (2008). Comparing the power of robots. *The International Journal of Robotics Research*, 27(1), 5-23.
- O’Kane, J. M., & Shell, D. A. (2017). Concise planning and filtering: hardness and algorithms. *IEEE Transactions on Automation Science and Engineering*, 14(4), 1666-1681.
- O’Regan, J. K., & Noë, A. (2001). A sensorimotor account of vision and visual consciousness. *Behavioral and brain sciences*, 24(05), 939–973.
- O’Regan, J. K., & Block, N. (2012). Discussion of j. kevin o’reagan’s “why red doesn’t sound like a bell: Understanding the feel of consciousness”. *Review of Philosophy and Psychology*, 3(1), 89–108. doi: 10.1007/s13164-012-0090-7
- Paolo, E. A. D. (2018). The enactive conception of life. In A. Newen, L. de Bruin, & S. Gallagher (Eds.), *The oxford handbook of 4e cognition* (pp. 71–95). Oxford University Press.
- Pezzulo, G., Barsalou, L., Cangelosi, A., Fischer, M., Spivey, M., & McRae, K. (2011). The mechanics of embodiment: A dialog on embodiment and computational modeling. *Frontiers in Psychology*, 2, 5. doi: 10.3389/fpsyg.2011.00005
- Rao, R. P. N., & Ballard, D. H. (1999, jan). Predictive coding in the visual cortex: a functional interpretation of some extra-classical receptive-field effects. *Nature Neuroscience*, 2(1), 79–87.
- Rescorla, M. (2016). Bayesian sensorimotor psychology. *Mind and Language*, 31, 3-36.

- Roy, N., & Gordon, G. (2003). Exponential family PCA for belief compression in POMDPs. In *Proceedings neural information processing systems*.
- Schöner, G. (2008). Dynamical systems approaches to cognition. *Cambridge handbook of computational cognitive modeling*, 101–126.
- Shannon, C. E. (1948). A mathematical theory of communication. *The Bell Systems Technical Journal*, 27, 379-423.
- Shannon, C. E. (1952). Presentation of a maze-solving machine. In *Trans. of the 8th cybernetics conference* (p. 173-180). Josiah Macy, Jr., Foundation.
- Suomalainen, M., Nilles, A. Q., & LaValle, S. M. (2020). Virtual reality for robots. In *Ieee/rsj international conference on intelligent robots and systems* (p. 11458-11465).
- Sutton, R. S., & Barto, A. G. (2018). *Reinforcement learning: An introduction*. MIT press.
- Särkkä, S. (2013). *Bayesian filtering and smoothing*. Cambridge, U.K.: Cambridge University Press.
- Thrun, S., Burgard, W., & Fox, D. (2005). *Probabilistic robotics*. Cambridge, MA: MIT Press.
- Tovar, B., Cohen, F., Bobadilla, L., Czarnowski, J., & LaValle, S. M. (2014). Combinatorial filters: Sensor beams, obstacles, and possible paths. *ACM Transactions on Sensor Networks*, 10(3).
- Varela, F., Rosch, E., & Thompson, E. (1992). *The embodied mind: Cognitive science and human experience*. Cambridge, Massachusetts: MIT Press.
- von Neumann, J., & Morgenstern, O. (1944). *Theory of games and economic behavior*. Princeton, NJ: Princeton University Press.
- Väänänen, J. (2007). *Dependence logic*. New York, NY, USA: Cambridge University Press.