

Optimal Management of a Smart Port with Shore-Connection and Hydrogen Supplying by Stochastic Model Predictive Control

F. Conte

Campus Bio-Medico University of Rome
Faculty of Engineering
Via Alvaro del Portillo, 21
I-00128, Roma, Italy
f.conte@unicampus.it

F. D'Agostino, D. Kaza, S. Massucco, G. Natrella, F. Silvestro

University of Genoa
DITEN
Via all'Opera Pia 11 A
I-16145, Genova, Italy
federico.silvestro@unige.it

Abstract—The paper proposes an optimal management strategy for a Smart Port equipped with renewable generation and composed by an electrified quay, operating Cold-Ironing, and a Hydrogen-based quay, supplying Zero-Emission Ships. One Battery Energy Storage System and one Hydrogen Energy Storage System are used to manage renewable energy sources and to supply electric and hydrogen-fueled ships. A model predictive control based algorithm is designed to define the best economic strategy to be followed during operations. The control algorithm takes into account the uncertainties of renewable energy generation using stochastic optimization. The performance of the approach is tested on a potential future Smart Port equipped with wind and photovoltaic generation.

Index Terms—Smart Port, Hydrogen, Stochastic Model Predictive Control, Cold-Ironing, Multi-Energy Systems.

I. INTRODUCTION

The continuous increase of global warming due to pollution has raised the attention in improving the systems in the marine sector. Focusing to Europe, the maritime sector produced 138 million tons of CO₂ in 2018, which is more than 3% of the total CO₂ continental emissions [1]. Seagoing vessels are not the only contributors to air pollution since also ships moored at ports produce a significant portion of emissions [2]. Indeed, a ship moored at port requires a certain amount of energy to be self-sustained, which is today provided by on-board power stations, usually composed by a set of Diesel Generators (DGs).

An efficient way to reduce emissions at berth is to shut down the DGs and supply ships with a shore-connection. This operation, called Cold Ironing (CI), is recommended by the European Union in [3], where EU ports are required to provide facilities to enable its implementation by 2025.

Literature provides many assessments of the potentialities of CI. In [4] it is shown that CO₂ emissions can be reduced by CI in the range of 48% to 70%. In [5] it is assessed that CI may reduce CO₂ and NO_x emissions by 25% and 92%, respectively.

The environmental benefits of CI is leading ports to build shore-connection infrastructures. There are examples in US, Canada and Europe [6]. However, the adoption of CI is not very widespread due to the economic convenience of producing energy on board compared to purchasing energy from the electric market. To overcome this problem, many solutions have been proposed. In Europe, the first CI has been implemented in the port of Gothenburg (Sweden) [7]. Here, CI has been encouraged by applying an extra tax to all not CI users. In Italy, the decree [8] applied since 2020 a tax of 0.0005€/kWh for ships moored in ports equipped with on-board power systems with rated power above 35 kW.

In this context, this paper proposes an optimal management strategy for a smart port operating CI. The port is also a Multi-Energy System (MES), since it is provided with Renewable Energy Sources (RES) coupled with a Battery Energy Storage System (BESS) and performs hydrogen supplying. Indeed, an alternative way to reduce ship emissions, which is receiving particular attention [9], is to realize Zero-Emission Ships (ZE-Ships), where DGs are substituted by Fuel Cells (FCs). Therefore, the idea of this article is to supply ZE-Ships at berth with the hydrogen needed to produce self-sustaining energy. This hydrogen is self-produced in the smart port using the available RES (green hydrogen) by an Electrolyzer (Ely) that, together with a FC and a hydrogen storage, composes a Hydrogen Energy Storage System (HESS).

The management of this hypothetical future smart port, is realized by a stochastic Model Predictive Control (MPC) algorithm. Literature provides several uses of MPC in smart cities with Power to Gas (PtG) devices [10] or, in general, for MES [11]. The peculiarity of the proposed approach is that uncertainties of RES are considered to maximize the economical earning, dispatching the compensation of forecast errors to the available storage systems, *i.e.* BESS and HESS.

The rest of the paper is organized as follows. Section II describes the system model. Section III introduces the optimal management algorithm. Section IV details the study case.

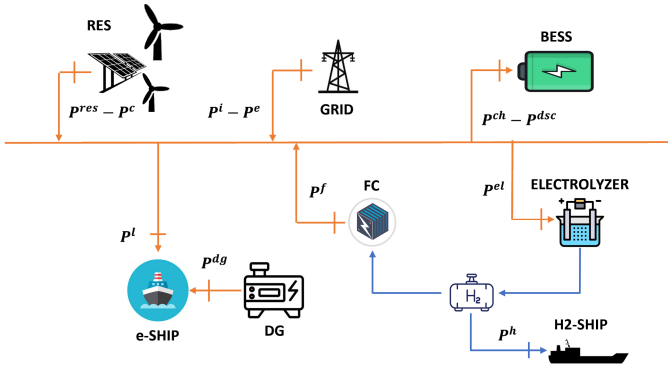

Figure 1. System architecture.

Section V provides simulation results. Section VI summarizes the paper conclusions.

II. SYSTEM MODEL

The schematic architecture of the considered system is reported in Figure 1. The port is composed by two quays: one is electrified to perform CI, one connecting ZE-Ships fueled by hydrogen. Ships connected to the electrified quay can eventually be completely or partially disconnected from the grid and satisfy their load with on-board DGs. The port is also equipped with a Photovoltaic (PV) plant, a Wind Farm (WF), one BESS, one HESS and a connection with the main grid. In the following, the models adopted for each system component is provided. In all models, t indicates discrete-time with a sampling time of 1 h and powers are considered as mean values within the sampling interval.

A. Connection with the main grid

During hour t , the port can import power P_t^i or export power P_t^e . Therefore, it results that

$$0 \leq P_t^i \leq \delta_t^g P_{max}^g, \quad (1)$$

$$0 \leq P_t^e \leq (1 - \delta_t^g) P_{max}^g, \quad (2)$$

where P_{max}^g is the rated power of the connection and δ_t^g is a binary variable.

B. BESS

The BESS is able to import or export power with the system according to its State of Charge (SoC). It results that

$$-P_{max}^b \leq P_t^b \leq P_{max}^b, \quad (3)$$

$$S_{t+1} = S_t + \frac{1}{E^b} P_t^b, \quad (4)$$

$$S_{min} \leq S_t \leq S_{max}, \quad (5)$$

where: P_t^b is the power exchanged by the BESS (assuming that positive values indicate power import); P_{max}^b is the BESS nominal power; S_t [p.u.] is the battery SoC; S_{min} and S_{max} are minimum and maximum SoCs to be respected for an optimal behaviour of the BESS; E^b [Wh] is the battery capacity.

C. HESS

In this paper, hydrogen quantity is measured as equivalent energy, according to the transformation $1 \text{ MWh} = 30 \text{ kg}$. Hydrogen storage is charged by the Ely and discharged by the demand of ZE-Ships and the consumption of the FC to regenerate electrical power. The Ely and the FC have a technical operation minimum when they are switched on and can work simultaneously. Therefore, the HESS can be represented by the following equations:

$$P_{min}^{el} \delta_t^{el} \leq P_t^{el} \leq P_{max}^{el} \delta_t^{el}, \quad (6)$$

$$P_{min}^f \delta_t^f \leq P_t^f \leq P_{max}^f \delta_t^f, \quad (7)$$

$$H_{t+1} = H_t + \frac{1}{E^h} \left(\eta^{el} P_t^{el} - \frac{P_t^f}{\eta^f} - P_t^h \right), \quad (8)$$

$$0 \leq H_t \leq 1, \quad (9)$$

where: P_t^{el} is the power consumed by the Ely; P_t^f is the power generated by the FC; P_t^h is the hydrogen required by ZE-Ships; P_{min}^{el} , P_{max}^{el} , P_{min}^f and P_{max}^f are their minimum and maximum power limits, respectively; H_t [p.u.] is the Hydrogen Level in the Storage (SoH); E^h [Wh] is HESS capacity; η^{el} and η^f are the efficiencies of Ely and FC, respectively; δ_t^{el} and δ_t^f are binary variables indicating the on/off status of Ely and FC, respectively.

D. Shore-Connection

The power required from ships connected to the electric quay is indicated with P_t^l . The power eventually generated by on-board DGs is indicated with P_t^{dg} and it must satisfy the following constraint:

$$0 \leq P_t^{dg} \leq P_t^l. \quad (10)$$

E. RES

The total power generated by RES is indicated with P_t^{res} , whereas P_t^c indicates the curtailment, which must be such that

$$0 \leq P_t^c \leq P_t^{res}. \quad (11)$$

F. Power Balance, Operational Costs and Available Data

During every hour t , the following power balance needs to be matched:

$$P_t^{res} + P_t^i + P_t^{dg} + P_t^f = P_t^l + P_t^e + P_t^b + P_t^{el} + P_t^c, \quad (12)$$

and the port economical earning is:

$$J_t = c_t^e P_t^e + c_t^{ci} (P_t^l - P_t^{dg}) + c_t^h P_t^h - c_t^i P_t^i - c_t^c P_t^c \quad (13)$$

where: c_t^i is the energy purchase price, c_t^e is the energy sell price; c_t^c is the RES curtailment penalty; c_t^{ci} is the tariff applied by the port to the ships in shore-connection; c_t^h is the tariff applied by the port to ZE-Ships for hydrogen. Curtailment penalty can be applied indirectly as loss of the RES self-consumption remuneration. Concerning c_t^{ci} , the hypothesis is that the use of on-board DGs is discouraged by taxes that makes their generation cost c^{dg} higher than the energy

purchase price. As a consequence, the port has the possibility to set $c_t^{ci} < c^{dg}$, making the activation of DG an eventual drawback, both for ships owners and for the port, which would lose an economical income equal to $c^{ci}P_t^{dg}$.

The general objective of this paper is to maximize the port economical earning, assuming that at hour t , given a time horizon T , the following data are available:

- a forecast profile of RES generation $\{\hat{P}_{t+k}^{res}\}_{k=0}^{T-1}$ with an associated confidence interval Δ_{t+k}^{res} , such that $|P_{t+k}^{res} - \hat{P}_{t+k}^{res}| \leq \Delta_{t+k}^{res}$;
- a scheduled profile of ZE-Ships hydrogen consumption $\{P_{t+k}^h\}_{k=0}^{T-1}$;
- a scheduled profile of the electrical load $\{P_{t+k}^l\}_{k=0}^{T-1}$;
- the current SoC S_t and SoH H_t ;
- all energy prices from time t to time $t + T - 1$.

III. OPTIMAL MANAGEMENT ALGORITHM

At hour t , we will indicate with $k = 0, 1, \dots, T - 1$ the time sequence $t, t + 1, \dots, t + T - 1$.

The uncertainties on the RES profile forecasts are represented as follows:

$$P_k^{res} = \hat{P}_k^{res} + \varepsilon_k, \quad \forall k \in [0, T - 1] \quad (14)$$

where the forecast error $\varepsilon_k = P_k^{res} - \hat{P}_k^{res}$ is supposed to be a normally distributed zero-mean white sequence with standard deviation $\sigma_k^{res} = \Delta_k^{res}/3$, so that $\mathbf{P}(|\varepsilon_k|) \leq 0.997$.

In order to keep always satisfied (12), we assume to split out the RES forecast error between BESS and the HESS. Therefore, the powers to be exchanged by BESS, Ely and FC are set as follows:

$$P_k^b = \hat{P}_k^b + \alpha_k^b \varepsilon_k \quad \forall k \in [0, T - 1], \quad (15)$$

$$P_k^{el} = \hat{P}_k^{el} + \alpha_k^{el} \varepsilon_k \quad \forall k \in [0, T - 1], \quad (16)$$

$$P_k^f = \hat{P}_k^f - \alpha_k^f \varepsilon_k \quad \forall k \in [0, T - 1], \quad (17)$$

where α_k^b , α_k^{el} and α_k^f are *participation factors*, which must satisfy the following conditions:

$$\alpha_k^b + \alpha_k^{el} + \alpha_k^f = 1 \quad \forall k \in [0, T - 1], \quad (18)$$

$$0 \leq \alpha_k^b \leq 1 \quad \forall k \in [0, T - 1], \quad (19)$$

$$0 \leq \alpha_k^{el} \leq \delta_k^{el} \quad \forall k \in [0, T - 1], \quad (20)$$

$$0 \leq \alpha_k^f \leq \delta_k^f \quad \forall k \in [0, T - 1]. \quad (21)$$

From (4), (8), and (15)–(17), it follows that P_k^b , P_k^{el} , P_k^f , S_k and H_k are normally distributed random variables:

$$P_k^\nu \sim \mathcal{N}(\hat{P}_k^\nu, \psi_k^\nu), \quad \nu = b, el, f \quad (22)$$

$$S_k \sim \mathcal{N}(\hat{S}_k, \psi_k^S), \quad H_k \sim \mathcal{N}(\hat{H}_k, \psi_k^H), \quad (23)$$

where, $\forall k \in [0, T - 1]$:

$$\psi_k^\nu = (\alpha_k^\nu \sigma_k^{res})^2, \quad \nu = b, el, f, \quad (24)$$

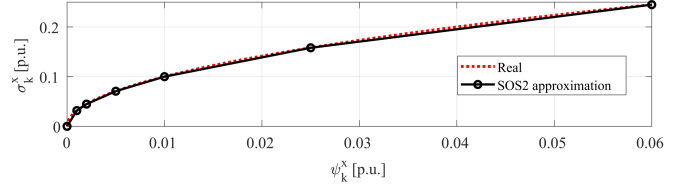

Figure 2. Piecewise linearization of the square root function applied to constraints (32) and (33)

and, $\forall k \in [1, T]$:

$$\hat{S}_k = S_0 + \frac{1}{E^b} \sum_{j=0}^{k-1} \hat{P}_j^b, \quad (25)$$

$$\hat{H}_k = H_0 + \frac{1}{E^h} \sum_{j=0}^{k-1} \left(\eta^{el} \hat{P}_j^{el} - \frac{\hat{P}_j^f}{\eta^f} - P_j^h \right), \quad (26)$$

$$\psi_k^S = \left(\frac{\eta^b}{E^b} \right)^2 \sum_{j=0}^{k-1} (\alpha_j^b \sigma_j^{res})^2, \quad (27)$$

$$\psi_k^H = \left(\frac{1}{E^h} \right)^2 \sum_{j=0}^{k-1} \left(\left(\eta^{el} \alpha_j^{el} + \frac{\alpha_j^f}{\eta^f} \right) \sigma_j^{res} \right)^2. \quad (28)$$

Equations (25)–(28) hold true under the assumption that forecasting error at hour k is independent of a forecasting error at hour $k' \neq k$, and considering that the initial SoC S_0 and SoH H_0 are available.

Random variables in (22)–(23) must satisfy constraints (3),(5)–(7) and (9). To deal with their randomness, chance constraints are introduced. For a generic normally distributed random variable $x \sim \mathcal{N}(\hat{x}, \sigma^2)$ the chance constraint:

$$\mathbf{P}(x \leq x \leq \bar{x}) \geq 1 - \beta \quad (29)$$

can be written with the following inequalities:

$$\hat{x} + \theta\sigma \leq \bar{x}, \quad -\hat{x} + \theta\sigma \leq x \quad (30)$$

where $\theta = \sqrt{2}\text{erf}^{-1}(1 - 2\beta)$ [12]. Therefore, we obtain that, $\forall k \in [0, T - 1]$:

$$\hat{P}_k^\nu + \theta \alpha_k^\nu \sigma_k^{res} \leq P_{max}^\nu, \quad -\hat{P}_k^\nu + \theta \alpha_k^\nu \sigma_k^{res} \leq P_{min}^\nu, \quad (31)$$

$$\hat{S}_k + \theta \sqrt{\psi_k^S} \leq S_{max}, \quad -\hat{S}_k + \theta \sqrt{\psi_k^S} \leq S_{min}, \quad (32)$$

$$\hat{H}_k + \theta \sqrt{\psi_k^H} \leq 1, \quad -\hat{H}_k + \theta \sqrt{\psi_k^H} \leq 0, \quad (33)$$

where $\nu = b, el, f$.

Constraints (32)–(33) are nonlinear and non-convex because of the presence of the square root function. To cope with this problem, a piecewise linearization is applied as reported in Figure 2. Such an approximation can be included in the optimization problem by introducing a set of binary variables or the so called Special Ordered Set of type 2 (SOS2) variables [13]. Details are not provided in this paper for space lacking.

The proposed optimal management algorithm is based in the MPC *receding horizon principle*, that consists in solving an optimization problem defined for a given time horizon at time t , applying the first element of the solution trajectories

and repeat the same at time $t + 1$. In our case, the optimization problem is formulated as follows:

$$\max_{\{X_k\}} \sum_{k=0}^{T-1} J_k \quad (34)$$

$$X_k = \left[P_k^i, P_k^e, P_k^{dg}, P_k^c, \hat{P}_k^b, \hat{P}_k^{el}, \hat{P}_k^f, \alpha_k^b, \alpha_k^{el}, \alpha_k^f \right]^T$$

subject to: (1)–(2), (10)–(12), (18)–(21), (25)–(28), (31)–(33).

The variables reported in vector X_k includes only the control variables to be applied to the system. Actually, also δ_k^g , δ_k^{el} and δ_k^f and SOS2 variables belong to X_k . Since (27)–(28) are quadratic with respect to α_k^b , α_k^{el} , and α_k^f , (34) results to be a Mixed Integer Quadratic-Constrained Problem (MIQCP).

IV. STUDY CASE

The considered study case is an hypothetical Smart Port located in the area of the Genova harbour in Italy. Table I reports the values assigned to model parameters. All components was sized using the software Hybrid Optimization of Multiple Energy Resources (HOMER) [14], which has the capability to simulate the various combination of technologies in a microgrid taking into account the shared energy and the costs of the system. The design was carried out by selecting among a set of sizes for each component, established by the user, and minimizing the Levelized Cost of Energy (LCOE).

The yearly electrical demand of a the shore-connection was defined based on [15], which provides an estimation of the total electrical load of roll-on roll-off passengers (Ro-Pax) ships moored at a quay in the Genova port, in 2019. The same was done to define yearly demand of hydrogen from ZE-Ships, using the aforementioned equivalence between hydrogen and electrical energy and assuming that they are equipped with on-board FCs with an efficiency of 60%. We assumed that only one Ro-Pax ship and one ZE-Ships Tanker at a time can be moored at the corresponding quay.

To size Wind and PV power plants, wind speed and solar irradiation in the area of Genova was taken from the NASA Prediction of Worldwide Energy Resource database [16]. To establish the maximal size of the PV power plant, we assumed the availability of an area of 123 800 m², estimated by Authority of the port system in [17], which, with an expected efficiency of 0.1 kW/m², returned a potential peak power of 12.38 MW. HOMER optimization returned a nominal power for the PV power plant of 4 MW and a nominal power for the WF of 11.34 MW, composed by 14 810 kW Wind Turbines. Efficiencies and potential sizes of BESS, FC, Ely, and HESS was taken from datasheets of available commercial devices.

V. SIMULATION RESULTS

To test the performance of the proposed control algorithm, one week has been simulated, using the data from the midnight of August 3rd to the midnight of August 11th, 2019. The adopted energy prices are reported in Table II. Notice that the price of hydrogen (c_t^h), which is hard to estimate for the future, has been set equal to the one of cold ironing c_t^{ci} . The

Table I
STUDY CASE PORT PARAMETERS.

Parameter	Symbol	Value
Main Grid Connection Nominal Power	P_{max}^g	16 MW
BESS Nominal Power	P_{max}^b	1 MW
BESS Capacity	E^b	2.5 MW h
BESS Round Trip Efficiency	η^b	95 %
HESS Capacity	E^h	2000 kg
HESS Nominal Load	–	19.95 kg/h
FC Nominal Power	P_{max}^f	0.25 MW
FC Technical Minimum	P_{min}^f	0.025 MW
FC Efficiency	η^f	60 %
Ely Nominal Power	P_{max}^{el}	1.5 MW
Ely Technical Minimum	P_{min}^{el}	0.15 MW
Ely Efficiency	η^{el}	70 %
Shore-Connection Nominal Power	–	11.96 MW
PV Plant Nominal Power	–	4 MW
WF Nominal Power	–	11.34 MW

Table II
SIMULATION SCENARIO: ENERGY PRICES.

	$c_t^i = 158.4 \text{ €/MWh}$	$c_t^e = 160 \text{ €/MWh}$	$c_t^{ci} = 165 \text{ €/MWh}$	$c_t^h = 165 \text{ €/MWh}$	
Exported energy price c_t^e					
Day/h	0 a.m. – 6 a.m.	7 a.m.	8 a.m. – 6 p.m.	7 p.m. – 10 p.m.	11 p.m.
Mon-Fri	51.97 €/MWh	62.23 €/MWh	75.83 €/MWh	62.23 €/MWh	51.97 €/MWh
Sat	51.97 €/MWh				51.97 €/MWh
Sun	51.97 €/MWh				

following control parameters have been set: $T = 12 \text{ h}$, $\beta = 0.05$, $S_{max} = 0.9 \text{ pu}$ and $S_{min} = 0.1 \text{ pu}$.

The RES forecast profiles has been taken from [16], whereas real profile has been computed using (14), with a resulting standard deviation $\sigma^{res} = 0.273 \text{ MW}$. The control algorithm has been implemented in MATLAB, integrated with General Algebraic Modeling System (GAMS) to write the optimization problem, solved by the SCIP solver.

Figures 3–7 show the obtained simulation results. Notice first that P_t^c and P_t^{dg} are not shown since they resulted to be always zero, meaning that no curtailment has been performed and the use of on-board DGs has been avoided. None of the constraints has been violated, meaning that both the electrical and the hydrogen loads have been fully satisfied. In Figure 4 we can observe how the algorithm has decided the contribution to the compensation of the RES forecast errors among BESS, FC and Ely and their power profiles in Figure 5 and Figure 6 we can observe the effect of these contributions, with a deviation of the real profile from the forecasted one.

We finally remark that the total earning obtained with the week operations has resulted to be equal to 45 641 €.

VI. CONCLUSIONS

A management strategy for economically optimizing the operational costs of a green multi-energy smart port performing cold-ironing and hydrogen supplying has been proposed. The control approach, based on MPC, takes into account the uncertainty of RES generation exploiting the two storage

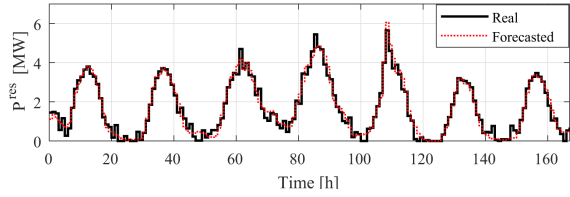

Figure 3. RES profiles

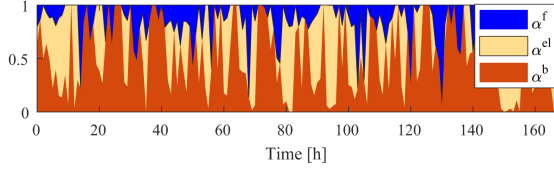

Figure 4. RES compensation participation factors profiles.

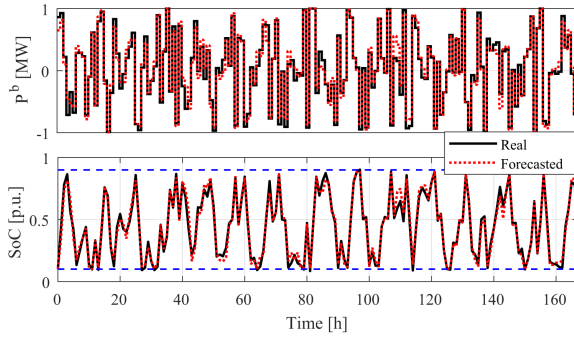

Figure 5. BESS exchanged power (top) and SoC (bottom).

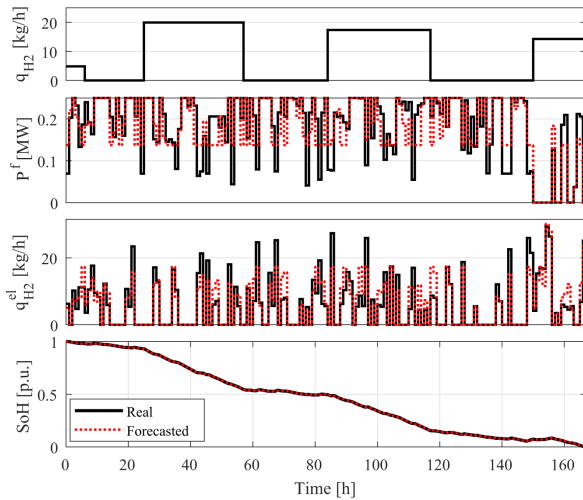

Figure 6. ZE-Ships Hydrogen load (top), power profiles of FC (mid-top) and Ely (mid-bottom), and SoH profile (bottom).

systems installed in the port: a battery and a hydrogen tank coupled with an electrolyzer and a fuel cell. Future works will consider different study cases to prove the robustness of the approach and its development, with an interaction of the proposed algorithm with a week- or month- ahead planning required especially for the hydrogen demand.

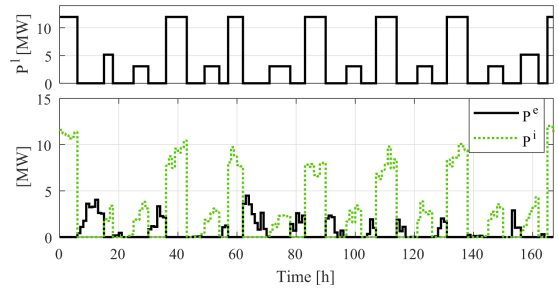

Figure 7. Electric ships load (top) and port import and export power profiles (bottom).

REFERENCES

- [1] Directorate-General for Climate Action, "2019 Annual Report on CO2 Emissions from Maritime Transport," European Commission, Tech. Rep., 2020.
- [2] J. Prousalidis, G. Antonopoulos, C. Patsios, A. Greig, and R. Bucknall, "Green shipping in emission controlled areas: Combining smart grids and cold ironing," *2014 International Conference on Electrical Machines (ICEM)*, Sep. 2014.
- [3] E. Commission, "Directive 2014/94/EU of the European Parliament and of the Council," *Official Journal of the European Union*.
- [4] F. D'Agostino, A. Fidigatti, E. Ragaini, and F. Silvestro, "Integration of shipboard microgrids within land distribution networks: Employing a ship microgrid to meet critical needs," *IEEE Electr. Mag.*, vol. 7, no. 4, pp. 69–80, 2019.
- [5] T. Zis, R. J. North, P. Angeloudis, W. Y. Ochieng, and M. G. H. Bell, "Evaluation of cold ironing and speed reduction policies to reduce ship emissions near and at ports," *Maritime Economics & Logistics*, vol. 16, no. 4, pp. 371–398, 2014.
- [6] J. Kumar, L. Kumpulainen, and K. Kauhaniemi, "Technical design aspects of harbour area grid for shore to ship power: State of the art and future solutions," *Int. J. of Elect. Pow. and Energy Syst.*, vol. 104, no. August 2018, pp. 840–852, 2019.
- [7] T. P. Zis, "Prospects of cold ironing as an emissions reduction option," *Transportation Research Part A: Policy and Practice*, vol. 119, pp. 82–95, 2019.
- [8] Italian Department of Justice, "Disposizioni urgenti in materia di proroga di termini legislativi, di organizzazione delle pubbliche amministrazioni, nonché di innovazione tecnologica." Jan 2019, [In Italian].
- [9] M. Banaei, J. Boudjadar, R. Ebrahimi, and H. Madsen, "Optimal control strategies of fuel cell/battery based zero-emission ships: A survey," in *47th Annual Conference of the IEEE Indust. Elect. Soc.*, Oct 2021.
- [10] D. Fischer, F. Kaufmann, O. Selinger-Lutz, and C. Voglstätter, "Power-to-gas in a smart city context - influence of network restrictions and possible solutions using on-site storage and model predictive controls," *Int. J. Hydrogen Energy*, vol. 43, pp. 9483–9494, 2018.
- [11] X. Guo, Z. Bao, and W. Yan, "Stochastic model predictive control based scheduling optimization of multi-energy system considering hybrid CHPs and EVs," *Applied Sciences*, vol. 9, p. 356, Jan 2019.
- [12] F. Conte, S. Massucco, G.-P. Schiapparelli, and F. Silvestro, "Day-ahead and intra-day planning of integrated bess-pv systems providing frequency regulation," *IEEE Trans. Sustain. Energy*, vol. 11, no. 3, pp. 1797–1806, 2020.
- [13] F. Conte, F. D'Agostino, P. Pongiglione, M. Saviozzi, and F. Silvestro, "Mixed-integer algorithm for optimal dispatch of integrated pv-storage systems," *IEEE Trans. Ind. Appl.*, vol. 55, no. 1, pp. 238–247, 2019.
- [14] "Hybrid Optimization of Multiple Energy Resources." [Online]. Available: <https://www.homerenergy.com/>
- [15] F. D'Agostino, D. Kaza, P. Schiapparelli, S. Federico, C. Bossi, and F. Colzi, "Assessment of the potential shore to ship load demand: the italian scenario," *IEEE PES General Meeting*, pp.1-5, 2021.
- [16] NASA Prediction of Worldwide Energy Resources. NASA. Accessed Nov. 05, 2021. [Online]. Available: <https://power.larc.nasa.gov/data-access-viewer/>
- [17] Autorita' di Sistema Portuale del Mar Ligure Occidentale, "Documento di pianificazione energetico ambientale del sistema portuale del mar ligure occidentale [In Italian]," Dec 2019.