

THE BALANCED SUPERELLIPTIC MAPPING CLASS GROUPS ARE GENERATED BY THREE ELEMENTS

GENKI OMORI

ABSTRACT. The balanced superelliptic mapping class group is the normalizer of the transformation group of the balanced superelliptic covering in the mapping class group of the total surface. We prove that the balanced superelliptic mapping class groups with either one marked point, one boundary component, or no marked points and boundary are generated by three elements. To prove this, we also show that its liftable mapping class groups are also generated by three elements. These generating sets are minimal except for several no marked points and boundary cases.

1. INTRODUCTION

Let Σ_g be a connected closed oriented surface of genus $g \geq 0$. For subsets A and B of Σ_g ($g \geq 0$), the *mapping class group* $\text{Mod}(\Sigma_g; A, B)$ of the tuple (Σ_g, A, B) is the group of isotopy classes of orientation-preserving self-homeomorphisms on Σ_g which preserve A setwise and B pointwise. When A is a set of n points and B is a disjoint union of b disks such that A and B have no intersections, we denote the mapping class group by $\text{Mod}_{g,n}^b$. We denote simply $\text{Mod}_g^b = \text{Mod}_{g,0}^b$, $\text{Mod}_{g,n} = \text{Mod}_{g,n}^0$, and $\text{Mod}_g = \text{Mod}_{g,0}^0$.

Dehn [4] proved that $\text{Mod}_{g,n}^b$ is generated by Dehn twists. After that small finite generating sets for Mod_g by Dehn twists were given by Lickorish [14] and Humphries [11], and finite presentations for $\text{Mod}_{g,n}^b$ were given by Gervais [6] for $g \geq 1$ and $n = 0$ and by Labruere-Paris [13] for $g \geq 1$ and $b \geq 1$. Generators of these presentations for $n = 0, 1$ are consist of Dehn twists. In [11], Humphries also proved that Mod_g does not generated by at most $2g$ Dehn twists and his generating set is minimal in generating sets for Mod_g which consist of Dehn twists.

As a study of more smaller generating set for the mapping class group, Wajnryb [17] proved that Mod_g^b is generated by two elements for $g \geq 1$ and $b \in \{0, 1\}$. Since Mod_g^b is not a cyclic group, this Wajnryb's generating set is minimal. After that, Korkmaz [12] proved that Mod_g^b is generated by two elements whose one element is a Dehn twist for $g \geq 1$ and $b \in \{0, 1\}$. Monden [15] showed that $\text{Mod}_{g,n}$ is generated by two elements for $g \geq 3$ and $n \geq 0$, and this generating set is also minimal.

For integers $n \geq 1$ and $k \geq 2$ with $g = n(k - 1)$, the *balanced superelliptic covering map* $p = p_{g,k}: \Sigma_g \rightarrow \Sigma_0$ is a branched covering map with $2n + 2$ branch points $p_1, p_2, \dots, p_{2n+2} \in \Sigma_0$, their unique preimages $\tilde{p}_1, \tilde{p}_2, \dots, \tilde{p}_{2n+2} \in \Sigma_g$, and the covering transformation group generated by the *balanced superelliptic rotation* $\zeta = \zeta_{g,k}$ of order k (precisely defined in Section 2.1 and see Figure 1). When $k = 2$, $\zeta = \zeta_{g,2}$ coincides with the hyperelliptic involution, and for $k \geq 3$, the balanced superelliptic covering space was introduced by Ghaswala and Winarski [9].

Date: June 7, 2022.

2010 *Mathematics Subject Classification.* 57S05, 57M07, 57M05, 20F05.

Let D be a disk on $\Sigma_0 - \{p_1, p_2, \dots, p_{2n+1}\}$ whose interior includes the point p_{2n+2} and \tilde{D} the preimage of D with respect to p . Then, denote by Σ_g^1 for $g \geq 1$ the complement of the interior of \tilde{D} in Σ_g . For $g = n(k-1) \geq 1$, an orientation-preserving self-homeomorphism φ on Σ_g (resp. on Σ_g^1 whose restriction to $\partial\Sigma_g^1$ is the identity map) is *symmetric* for $\zeta = \zeta_{g,k}$ if $\varphi \langle \zeta \rangle \varphi^{-1} = \langle \zeta \rangle$ (resp. $\varphi \langle \zeta|_{\Sigma_g^1} \rangle \varphi^{-1} = \langle \zeta|_{\Sigma_g^1} \rangle$). We abuse notation and denote simply $\zeta|_{\Sigma_g^1} = \zeta$. We regard $\text{Mod}_{g,1}$ and Mod_g^1 as the groups $\text{Mod}(\Sigma_g; \{\tilde{p}_{2n+2}\}, \emptyset)$ and $\text{Mod}(\Sigma_g; \emptyset, \tilde{D})$, respectively. The *balanced superelliptic mapping class group* (or *symmetric mapping class group*) $\text{SMod}_{g;k}$ (resp. $\text{SMod}_{g,*;k}$ and $\text{SMod}_{g;k}^1$) is the subgroup of Mod_g (resp. $\text{Mod}_{g,1}$ and Mod_g^1) which consists of elements represented by symmetric homeomorphisms. Birman and Hilden [3] showed that $\text{SMod}_{g;k}$ (resp. $\text{SMod}_{g,*;k}$ and $\text{SMod}_{g;k}^1$) coincides with the group of symmetric isotopy classes of symmetric homeomorphisms on Σ_g (resp. $(\Sigma_g, \tilde{p}_{2n+2})$ and Σ_g^1).

We denote by Σ_0^1 the complement of the interior of D in Σ_0 . An orientation-preserving self-homeomorphism φ on Σ_0 (resp. on Σ_0^1 whose restriction to $\partial\Sigma_0^1$ is the identity map) is *liftable* with respect to $p = p_{g,k}$ if there exists an orientation-preserving self-homeomorphism $\tilde{\varphi}$ on Σ_g (resp. on Σ_g^1 whose restriction to $\partial\Sigma_g^1$ is the identity map) such that $p \circ \tilde{\varphi} = \varphi \circ p$ (resp. $p|_{\Sigma_g^1} \circ \tilde{\varphi} = \varphi \circ p|_{\Sigma_g^1}$), namely, the following diagrams commute:

$$\begin{array}{ccc} \Sigma_g & \xrightarrow{\tilde{\varphi}} & \Sigma_g \\ p \downarrow & \circlearrowleft & \downarrow p \\ \Sigma_0 & \xrightarrow{\varphi} & \Sigma_0, \end{array} \quad \begin{array}{ccc} \Sigma_g^1 & \xrightarrow{\tilde{\varphi}} & \Sigma_g^1 \\ p|_{\Sigma_g^1} \downarrow & \circlearrowleft & \downarrow p|_{\Sigma_g^1} \\ \Sigma_0^1 & \xrightarrow{\varphi} & \Sigma_0^1. \end{array}$$

Put $\mathcal{B} = \{p_1, p_2, \dots, p_{2n+2}\}$. We regard $\text{Mod}_{0,2n+2}$ and $\text{Mod}_{0,2n+1}^1$ as the groups $\text{Mod}(\Sigma_0; \mathcal{B}, \emptyset)$ and $\text{Mod}(\Sigma_0; \mathcal{B} - \{p_{2n+2}\}, D)$, respectively, and denote by $\text{Mod}_{0,2n+2;*}$ the group $\text{Mod}(\Sigma_0; \mathcal{B} - \{p_{2n+2}\}, \{p_{2n+2}\})$. The *liftable mapping class group* $\text{LMod}_{2n+2;k}$ (resp. $\text{LMod}_{2n+2,*;k}$ and $\text{LMod}_{2n+1;k}^1$) is the subgroup of $\text{Mod}_{0,2n+2}$ (resp. $\text{Mod}_{0,2n+2;*}$ and $\text{Mod}_{0,2n+1}^1$) which consists of elements represented by liftable homomorphisms. Birman and Hilden [2] proved that $\text{LMod}_{2n+1;k}^1$ is isomorphic to $\text{SMod}_{g;k}^1$ and $\text{LMod}_{2n+2;k}$ (resp. $\text{LMod}_{2n+2,*;k}$) is isomorphic to the quotient of $\text{SMod}_{g;k}$ (resp. $\text{SMod}_{g,*;k}$) by $\langle \zeta \rangle$.

When $k = 2$, $\zeta = \zeta_{g,2}$ is the hyperelliptic involution and corresponding symmetric mapping class groups are called the hyperelliptic mapping class groups. In this case, $\text{LMod}_{2n+2;2}$ (resp. $\text{LMod}_{2n+2,*;2}$ and $\text{LMod}_{2n+1;2}^1$) is equal to $\text{Mod}_{0,2n+2}$ (resp. $\text{Mod}_{0,2n+2;*}$ and $\text{Mod}_{0,2n+1}^1$) and a finite presentation for $\text{SMod}_{g;2}$ was given by Birman and Hilden [1]. Stukow [16] gave a minimal generating set for $\text{SMod}_{g;2}$ by two torsion elements.

When $k \geq 3$, Ghaswala and Winarski [9] proved that $\text{LMod}_{2n+2;k}$ is a proper subgroup of $\text{Mod}_{0,2n+2}$. They also gave a finite presentation for $\text{LMod}_{2n+2;k}$ in [8]. By Lemma 3.6 in [8] and Lemmas 4.2 and 4.4 in [10], we show that the group $\text{LMod}_{2n+2,*;k}$ (resp. $\text{LMod}_{2n+1;k}^1$) is also a proper subgroup of $\text{Mod}_{0,2n+2;*}$ (resp. $\text{Mod}_{0,2n+1}^1$) for $k \geq 3$ and also show that $\text{LMod}_{2n+2;k} = \text{LMod}_{2n+2;l}$, $\text{LMod}_{2n+2,*;k} = \text{LMod}_{2n+2,*;l}$, and $\text{LMod}_{2n+1;k}^1 = \text{LMod}_{2n+1;l}^1$ for $l > k \geq 3$. Hence we omit “ k ” in the notation of the liftable mapping class groups for $k \geq 3$ (i.e. we express $\text{LMod}_{2n+2;k} = \text{LMod}_{2n+2}$, $\text{LMod}_{2n+2,*;k} = \text{LMod}_{2n+2,*}$, and

$\text{LMod}_{2n+1;k}^1 = \text{LMod}_{2n+1}^1$ for $k \geq 3$). Hirose and the author [10] gave another finite presentation for LMod_{2n+2} and finite presentations for the groups $\text{LMod}_{2n+2,*}$, LMod_{2n+1}^1 , $\text{SMod}_{g;k}$, $\text{SMod}_{g,*;k}$, and $\text{SMod}_{g;k}^1$.

The main theorems in this paper are as follows.

Theorem 1.1. $\text{LMod}_{2n+2,*}$ and LMod_{2n+1}^1 for $n \geq 2$ and LMod_{2n+2} for $n \geq 1$ are generated by three elements. $\text{LMod}_{4,*}$ and LMod_3^1 are generated by two elements.

Theorem 1.2. Assume that $n \geq 1$ and $k \geq 3$ with $g = n(k-1)$. Then, $\text{SMod}_{g,*;k}$ and $\text{SMod}_{g;k}^1$ for $n \geq 2$ and $\text{SMod}_{g;k}$ for $n \geq 1$ are generated by three elements. $\text{SMod}_{g,*;k}$ and $\text{SMod}_{g;k}^1$ for $n = 1$ are generated by two elements.

Theorems 1.1 and 1.2 are proved in Sections 3 and 4. Theorems 1.1 and 1.2 for $n = 1$ is immediately obtained from Corollaries 5.4 and 6.13 in [10]. The integral first homology group $H_1(G)$ of a group G is isomorphic to the abelianization of G . By Theorem 1.1 in [7] and Theorems 1.1 and 1.2 in [10], the integral first homology groups of the liftable mapping class groups and the balanced superelliptic mapping class groups are as follows:

Theorem 1.3 (Theorem 1.1 in [7] and Theorem 1.1 in [10]). For $n \geq 1$,

$$\begin{aligned} (1) \quad H_1(\text{LMod}_{2n+2}) &\cong \begin{cases} \mathbb{Z} \oplus \mathbb{Z}_2 \oplus \mathbb{Z}_2 & \text{if } n \text{ is odd,} \\ \mathbb{Z} \oplus \mathbb{Z}_2 & \text{if } n \text{ is even,} \end{cases} \\ (2) \quad H_1(\text{LMod}_{2n+2,*}) &\cong \begin{cases} \mathbb{Z} \oplus \mathbb{Z}_2 & \text{if } n = 1, \\ \mathbb{Z}^2 \oplus \mathbb{Z}_n & \text{if } n \geq 2 \text{ is even,} \\ \mathbb{Z}^2 \oplus \mathbb{Z}_{2n} & \text{if } n \geq 3 \text{ is odd,} \end{cases} \\ (3) \quad H_1(\text{LMod}_{2n+1}^1) &\cong \begin{cases} \mathbb{Z}^2 & \text{if } n = 1, \\ \mathbb{Z}^3 & \text{if } n \geq 2. \end{cases} \end{aligned}$$

Theorem 1.4 (Theorem 1.2 in [10]). For $n \geq 1$ and $k \geq 3$ with $g = n(k-1)$,

$$\begin{aligned} (1) \quad H_1(\text{SMod}_{g;k}) &\cong \begin{cases} \mathbb{Z} \oplus \mathbb{Z}_2 \oplus \mathbb{Z}_2 & \text{if } n \geq 1 \text{ is odd and } k \text{ is odd,} \\ \mathbb{Z} \oplus \mathbb{Z}_2 \oplus \mathbb{Z}_4 & \text{if } n \geq 1 \text{ is odd and } k \text{ is even,} \\ \mathbb{Z} \oplus \mathbb{Z}_2 & \text{if } n \geq 2 \text{ is even,} \end{cases} \\ (2) \quad H_1(\text{SMod}_{g,*;k}) &\cong \begin{cases} \mathbb{Z} \oplus \mathbb{Z}_{2k} & \text{if } n = 1, \\ \mathbb{Z}^2 \oplus \mathbb{Z}_{kn} & \text{if } n \geq 2 \text{ is even,} \\ \mathbb{Z}^2 \oplus \mathbb{Z}_{2kn} & \text{if } n \geq 3 \text{ is odd,} \end{cases} \\ (3) \quad H_1(\text{SMod}_{g;k}^1) &\cong \begin{cases} \mathbb{Z}^2 & \text{if } n = 1, \\ \mathbb{Z}^3 & \text{if } n \geq 2. \end{cases} \end{aligned}$$

For a group G , the minimal number of generators for $H_1(G)$ gives a lower bound of the minimal number of generators for G . By Theorems 1.3 and 1.4, we can show that the generating sets in Theorem 1.1 or 1.2 are minimal except for the cases that LMod_{2n+2} for even n and $\text{SMod}_{g;k}$ for even n .

2. PRELIMINARIES

2.1. The balanced superelliptic covering space. In this section, we review the definition of the balanced superelliptic covering space from Section 2.1 in [10]. For integers $n \geq 1$ and $k \geq 2$ with $g = n(k-1)$, we describe the surface Σ_g as follows. We take the unit 2-sphere $S^2 = S(1)$ in \mathbb{R}^3 and n mutually disjoint parallel copies $S(2), S(3), \dots, S(n+1)$ of $S(1)$ by translations along the x -axis such that

$$\max(S(i) \cap (\mathbb{R} \times \{0\} \times \{0\})) < \min(S(i+1) \cap (\mathbb{R} \times \{0\} \times \{0\}))$$

for $1 \leq i \leq n$ (see Figure 1). Let ζ be the $(-\frac{2\pi}{k})$ -rotation of \mathbb{R}^3 on the x -axis. Then we remove $2k$ disjoint open disks in $S(i)$ for $2 \leq i \leq n$ and k disjoint open disks in

$S(i)$ for $i \in \{1, n+1\}$ which are setwisely preserved by the action of ζ , and connect k boundary components of the punctured $S(i)$ and ones of the punctured $S(i+1)$ by k annuli such that the union of the k annuli is preserved by the action of ζ for each $1 \leq i \leq n$ as in Figure 1. Since the union of the punctured $S(1) \cup S(2) \cup \dots \cup S(n+1)$ and the attached $n \times k$ annuli is homeomorphic to $\Sigma_{g=n(k-1)}$, we regard this union as Σ_g .

By the construction above, the action of ζ on \mathbb{R}^3 induces the action on Σ_g , the quotient space $\Sigma_g / \langle \zeta \rangle$ is homeomorphic to Σ_0 , and the quotient map $p = p_{g,k}: \Sigma_g \rightarrow \Sigma_0$ is a branched covering map with $2n+2$ branch points in Σ_0 . We call the branched covering map $p: \Sigma_g \rightarrow \Sigma_0$ the *balanced superelliptic covering map*. Denote by $\tilde{p}_1, \tilde{p}_2, \dots, \tilde{p}_{2n+2} \in \Sigma_g$ the fixed points of ζ such that $\tilde{p}_i < \tilde{p}_{i+1}$ in $\mathbb{R} = \mathbb{R} \times \{0\} \times \{0\}$ for $1 \leq i \leq 2n+1$, by $p_i \in \Sigma_0$ for $1 \leq i \leq 2n+2$ the image of \tilde{p}_i by p (i.e. $p_1, p_2, \dots, p_{2n+2} \in \Sigma_0$ are branch points of p), and by \mathcal{B} the set of the branch points $p_1, p_2, \dots, p_{2n+2}$. Let D be a 2-disk in $(\Sigma_0 - \mathcal{B}) \cup \{p_{2n+2}\}$ whose interior includes the point p_{2n+2} and \tilde{D} the preimage of D with respect to p . Denote by Σ_g^1 the complement of interior of \tilde{D} in Σ_g and by Σ_0^1 the complement of interior of D in Σ_0 . Then we also call the restriction $p|_{\Sigma_g^1}: \Sigma_g^1 \rightarrow \Sigma_0^1$ the balanced superelliptic covering map and we denote simply $p|_{\Sigma_g^1} = p$.

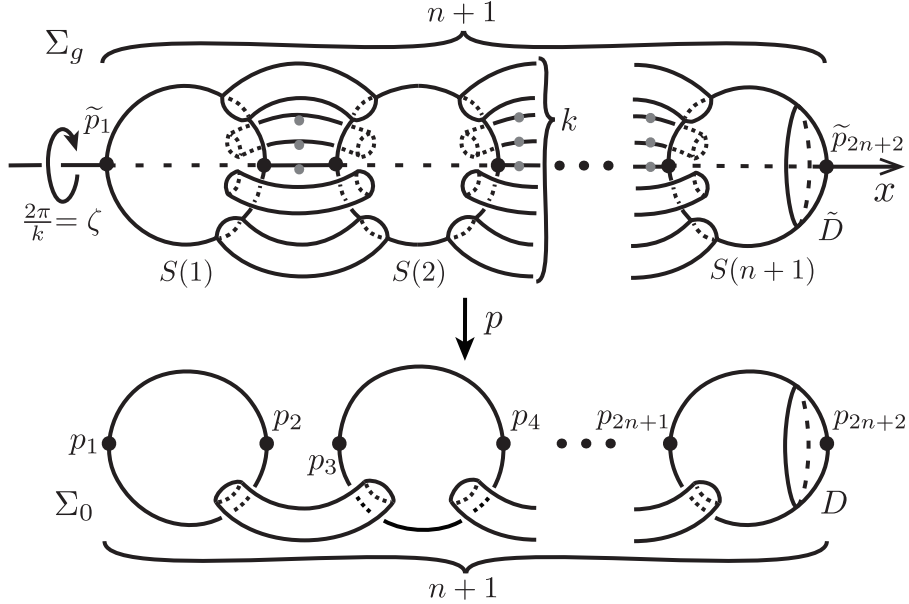

FIGURE 1. The balanced superelliptic covering map $p = p_{g,k}: \Sigma_g \rightarrow \Sigma_0$.

2.2. Lifiable elements for the balanced superelliptic covering map. In this section, we introduce some liftable homeomorphisms on Σ_0 for the balanced superelliptic covering map $p = p_{g,k}$ for $k \geq 3$ from Section 2.2 in [10]. Let l_i ($1 \leq i \leq n+1$) be an oriented simple arc on Σ_0 whose endpoints are p_i and p_{i+1} as in Figure 2. Put $L = l_1 \cup l_2 \cup \dots \cup l_{n+1}$. The isotopy class of a homeomorphism φ on Σ_0 (resp. Σ_0^1) relative to \mathcal{B} (resp. $(\mathcal{B} - \{p_{2n+2}\}) \cup \partial \Sigma_0^1$) is determined by the isotopy class of the image of L (resp. $L \cap \Sigma_0^1$) by φ relative to \mathcal{B} (resp. $(\mathcal{B} - \{p_{2n+2}\}) \cup \partial \Sigma_0^1$). We

identify Σ_0 with the surface on the lower side in Figure 2 by some homeomorphism of Σ_0 .

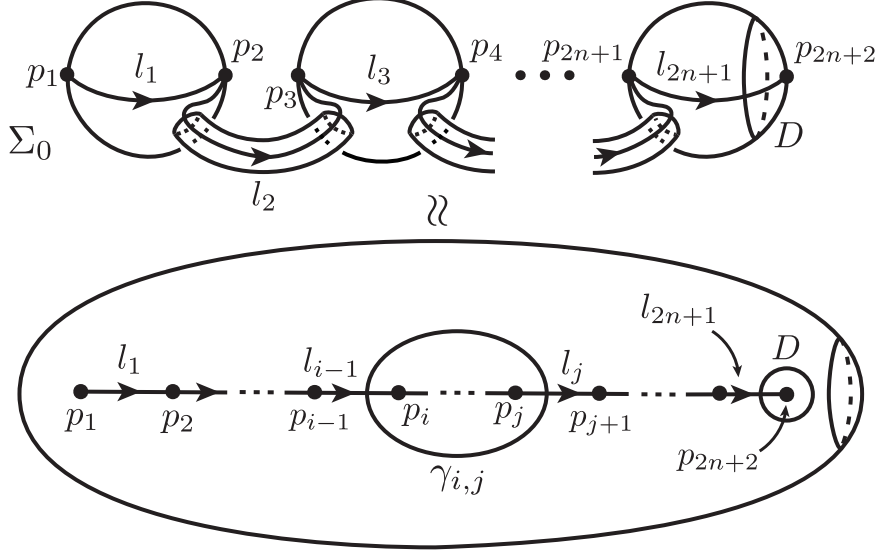

FIGURE 2. A natural homeomorphism of Σ_0 , arcs $l_1, l_2, \dots, l_{2n+1}$, and a simple closed curve $\gamma_{i,j}$ on Σ_0 for $1 \leq i < j \leq 2n + 2$.

Let σ_i for $1 \leq i \leq 2n + 1$ be a self-homeomorphism on Σ_0 which is described as the result of anticlockwise half-rotation of l_i in the regular neighborhood of l_i in Σ_0 as in Figure 3. σ_i is called the *half-twist* along l_i . As a well-known result, $\text{Mod}_{0,2n+2}$ is generated by $\sigma_1, \sigma_2, \dots, \sigma_{2n+1}$ (see for instance Section 9.1.4 in [5]). Since $\text{Mod}_{0,2n+2}$ naturally acts on \mathcal{B} , we have the surjective homomorphism

$$\Psi: \text{Mod}_{0,2n+2} \rightarrow S_{2n+2}$$

given by $\Psi(\sigma_i) = (i \ i + 1)$, where S_{2n+2} is the symmetric group of degree $2n + 2$.

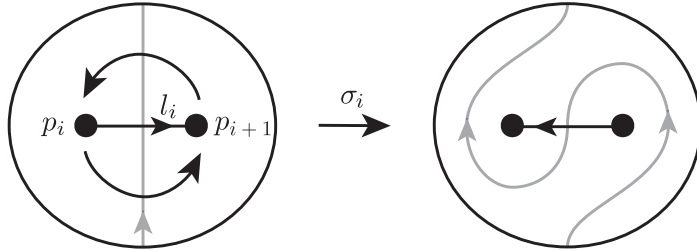

FIGURE 3. The half-twist σ_i for $1 \leq i \leq 2n + 1$.

Put $\mathcal{B}_o = \{p_1, p_3, \dots, p_{2n+1}\}$ and $\mathcal{B}_e = \{p_2, p_4, \dots, p_{2n+2}\}$. An element σ in S_{2n+2} is *parity-preserving* if $\sigma(\mathcal{B}_o) = \mathcal{B}_o$, and is *parity-reversing* if $\sigma(\mathcal{B}_o) = \mathcal{B}_e$. An element f in $\text{Mod}_{0,2n+2}$ is *parity-preserving* (resp. *parity-reversing*) if $\Psi(f)$ is *parity-preserving* (resp. *parity-reversing*). Let W_{2n+2} be the subgroup of S_{2n+2} which consists of parity-preserving or parity-reversing elements, S_{n+1}^o (resp. S_{n+1}^e) the subgroup of S_{2n+2} which consists of elements whose restriction to \mathcal{B}_e (resp. \mathcal{B}_o) is the identity map. Note that S_{n+1}^o (resp. S_{n+1}^e) is a subgroup of W_{2n+2} ,

isomorphic to S_{n+1} , and generated by transpositions $(1\ 3), (3\ 5), \dots, (2n-1\ 2n+1)$ (resp. $(2\ 4), (4\ 6), \dots, (2n\ 2n+2)$). Then we have the following exact sequence:

$$(2.1) \quad 1 \longrightarrow S_{n+1}^o \times S_{n+1}^e \longrightarrow W_{2n+2} \xrightarrow{\pi} \mathbb{Z}_2 \longrightarrow 1,$$

where the homomorphism $\pi: W_{2n+2} \rightarrow \mathbb{Z}_2$ is defined by $\pi(\sigma) = 0$ if σ is parity-preserving and $\pi(\sigma) = 1$ if σ is parity-reversing. Ghaswala and Winarski [8] proved the following lemma.

Lemma 2.1 (Lemma 3.6 in [8]). *Let LMod_{2n+2} be the liftable mapping class group for the balanced superelliptic covering map $p_{g,k}$ for $n \geq 1$ and $k \geq 3$ with $g = n(k-1)$. Then we have*

$$\text{LMod}_{2n+2} = \Psi^{-1}(W_{2n+2}).$$

Lemma 2.1 implies that a mapping class $f \in \text{Mod}_{0,2n+2}$ lifts with respect to $p_{g,k}$ if and only if f is parity-preserving or parity-reversing (in particular, when $k \geq 3$, the liftability of a homeomorphism on Σ_0 or Σ_0^1 does not depend on k). The *pure mapping class group* $\text{PMod}_{0,2n+2}$ is the kernel of the homomorphism $\Psi: \text{Mod}_{0,2n+2} \rightarrow S_{2n+2}$. Since all elements in $\text{PMod}_{0,2n+2}$ is parity-preserving, $\text{PMod}_{0,2n+2}$ is a subgroup of LMod_{2n+2} and we have the following exact sequence:

$$(2.2) \quad 1 \longrightarrow \text{PMod}_{0,2n+2} \longrightarrow \text{LMod}_{2n+2} \xrightarrow{\Psi} W_{2n+2} \longrightarrow 1.$$

For mapping classes $[\varphi]$ and $[\psi]$, $[\psi][\varphi]$ means $[\psi \circ \varphi]$, i.e. $[\varphi]$ apply first, and we often abuse notation and denote a homeomorphism and its isotopy class by the same symbol. We will introduce some explicit liftable elements as follows.

The Dehn twist $t_{i,j}$. For a simple closed curve γ on Σ_g ($g \geq 0$), we denote by t_γ the right-handed Dehn twist along γ . Let $\gamma_{i,j}$ for $1 \leq i < j \leq 2n+2$ be a simple closed curve on $\Sigma_0 - (\mathcal{B} \cup D)$ such that $\gamma_{i,j}$ surrounds the $j-i+1$ points p_i, p_{i+1}, \dots, p_j as in Figure 2. We have $\gamma_{i,2n+2} = \gamma_{1,i-1}$ for $i \geq 3$ as an isotopy class of a curve. Then we define $t_{i,j} = t_{\gamma_{i,j}}$ for $1 \leq i < j \leq 2n+2$. Note that $t_{1,2n+1} = t_{1,2n+2} = t_{2,2n+2} = 1$ and $t_{i,2n+2} = t_{1,i-1}$ for $i \geq 3$ in $\text{Mod}_{0,2n+2}$. Since the Dehn twist $t_{i,j}$ preserves \mathcal{B} pointwise, i.e. $t_{i,j}$ lies in $\text{PMod}_{0,2n+2}$, $t_{i,j}$ lifts with respect to p by Lemma 2.1.

The half-rotation h_i . Let \mathcal{N} be a regular neighborhood of $l_i \cup l_{i+1}$ in $(\Sigma_0 - \mathcal{B}) \cup \{p_i, p_{i+1}, p_{i+2}\}$ for $1 \leq i \leq 2n$. \mathcal{N} is homeomorphic to a 2-disk. Then we denote by h_i the self-homeomorphism on Σ_0 which is described as the result of anticlockwise half-rotation of $l_i \cup l_{i+1}$ in \mathcal{N} as in Figure 4. Note that $h_i = \sigma_i \sigma_{i+1} \sigma_i$ for $1 \leq i \leq 2n$. Since $\Psi(h_i) = (i\ i+2)$ for $1 \leq i \leq 2n$, the mapping class h_i is parity-preserving. Thus, by Lemma 2.1, h_i lifts with respect to p .

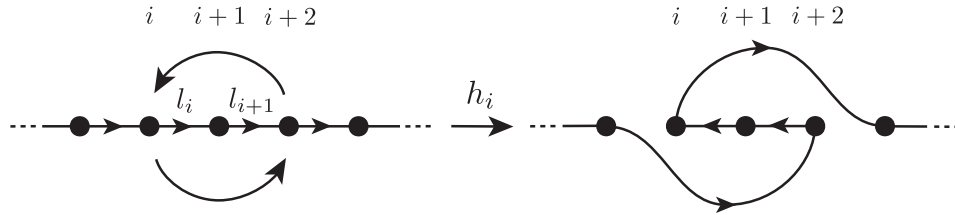

FIGURE 4. The mapping class h_i for $1 \leq i \leq 2n$ on Σ_0 .

The *parity-reversing element* r_1 . Let r_1 be the self-homeomorphism on Σ_0 which is described as the result of the $\frac{2\pi}{2n+2}$ -rotation on Σ_0 as in Figure 5. We see that $r_1(l_i) = l_{i+1}$ for $1 \leq i \leq 2n$, the order of r_1 is $2n+2$, and $\Psi(r_1) = (1\ 2)(2\ 3)\cdots(2n+1\ 2n+2)$. Thus r_1 is parity-reversing and lifts with respect to p by Lemma 2.1.

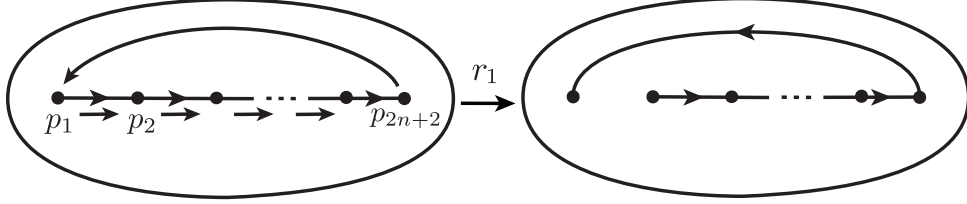

FIGURE 5. The mapping class r_1 on Σ_0 .

The *parity-reversing element* r . Let r be the self-homeomorphism on Σ_0 which is described as the result of the π -rotation of Σ_0 on the axis as in Figure 6. We see that $r(l_i) = l_{2n+2-i}^{-1}$ for $1 \leq i \leq 2n+1$ and $\Psi(r) = (1\ 2n+2)(2\ 2n+1)\cdots(n+1\ n+2)$. Thus r is parity-reversing and lifts with respect to p by Lemma 2.1.

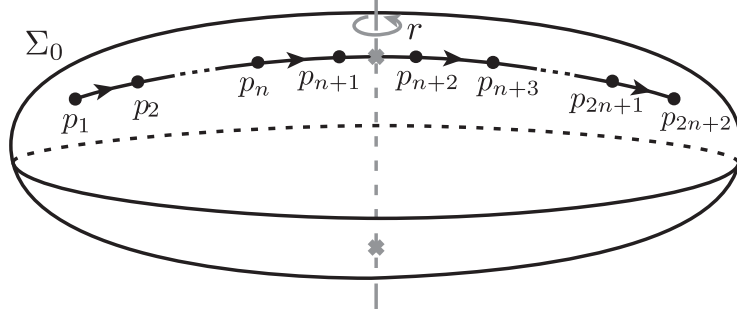

FIGURE 6. The mapping class r on Σ_0 .

We have the following lemma.

Lemma 2.2. For $n \geq 1$, put

$$F = \begin{cases} h_1^{-1} & \text{for } n = 1, \\ (h_1^{-1}h_2^{-1}\cdots h_{2n-2}^{-1})(h_1^{-1}h_2^{-1}\cdots h_{2n-4}^{-1})\cdots(h_1^{-1}h_2^{-1})h_{2n-1}^{-1}\cdots h_3^{-1}h_1^{-1} & \text{for } n \geq 2. \\ t_{2n,2n+1}^{n-1}\cdots t_{6,7}^2 t_{4,5} & \text{for } n \geq 2. \end{cases}$$

Then, the relation $r_1 = rF$ holds in LMod_{2n+2} .

Proof. Since r is an involution and the isotopy class of a homeomorphism φ on Σ_0 relative to \mathcal{B} is determined by the isotopy class of the image $\varphi(L)$ relative to \mathcal{B} , we will prove that $F^{-1}rr_1(l_i) = l_i$ for $1 \leq i \leq 2n+1$ relative to \mathcal{B} . The images $r_1(L)$ and $rr_1(L)$ are described as on the second and third steps in Figure 7. When $n = 1$, we clearly show that $F^{-1}rr_1(l_i) = h_1rr_1(l_i) = l_i$ for $1 \leq i \leq 2n+1$ relative to \mathcal{B} .

Assume that $n \geq 2$. Put $F_i = t_{2i+1,2i+2}^{-i}h_{2i}\cdots h_2h_1$ for $1 \leq i \leq n-1$. By applying $F_1\cdots F_{n-2}F_{n-1} = (t_{3,4}^{-1}h_2h_1)\cdots(t_{2n-3,2n-2}^{-(n-2)}h_{2n-4}\cdots h_2h_1)(t_{2n-1,2n}^{-(n-1)}h_{2n-2}\cdots h_2h_1)$ to $rr_1(L)$ inductively, we have the image $F_1\cdots F_{n-2}F_{n-1}rr_1(L)$ as on the sixth step in Figure 7. Finally, by applying $h_1h_3\cdots h_{2n-1}$ to this image, we show that

$h_1 h_3 \cdots h_{2n-1} F_1 \cdots F_{n-2} F_{n-1} r r_1(l_i) = l_i$ for $1 \leq i \leq 2n+1$ as on the bottom in Figure 7. Since $t_{i,i+1}$ for $1 \leq i \leq 2n+1$ commutes with h_j for $j \notin \{i-2, i-1, i, i+1\}$ and the relation $h_i t_{i,i+1} = t_{i+1,i+2} h_i$ for $1 \leq i \leq 2n$ holds in LMod_{2n+2} , we have

$$\begin{aligned}
& h_1 h_3 \cdots h_{2n-1} F_1 \cdots F_{n-2} F_{n-1} \\
= & h_1 h_3 \cdots h_{2n-1} \\
& \cdot \underbrace{(t_{3,4}^{-1} h_2 h_1)}_{\leftarrow} \cdots \underbrace{(t_{2n-3,2n-2}^{-(n-2)} h_{2n-4} \cdots h_2 h_1)}_{\leftarrow} \underbrace{(t_{2n-1,2n}^{-(n-1)} h_{2n-2} \cdots h_2 h_1)}_{\leftarrow} \\
\stackrel{\text{COMM}}{=} & h_1 \underbrace{h_3 t_{3,4}^{-1}}_{\leftarrow} \cdots \underbrace{h_{2n-3} t_{2n-3,2n-2}^{-(n-2)}}_{\leftarrow} \underbrace{h_{2n-1} t_{2n-1,2n}^{-(n-1)}}_{\leftarrow} \\
& \cdot (h_2 h_1) \cdots (h_{2n-4} \cdots h_2 h_1) (h_{2n-2} \cdots h_2 h_1) \\
= & h_1 \underbrace{t_{4,5}^{-1} h_3}_{\leftarrow} \cdots \underbrace{h_{2n-5} t_{2n-2,2n-1}^{-(n-2)}}_{\leftarrow} \underbrace{h_{2n-3} t_{2n,2n+1}^{-(n-1)}}_{\leftarrow} h_{2n-1} \\
& \cdot (h_2 h_1) \cdots (h_{2n-4} \cdots h_2 h_1) (h_{2n-2} \cdots h_2 h_1) \\
\stackrel{\text{COMM}}{=} & t_{4,5}^{-1} \cdots t_{2n-2,2n-1}^{-(n-2)} t_{2n,2n+1}^{-(n-1)} h_1 h_3 \cdots h_{2n-1} \\
& \cdot (h_2 h_1) \cdots (h_{2n-4} \cdots h_2 h_1) (h_{2n-2} \cdots h_2 h_1) \\
= & F^{-1},
\end{aligned}$$

where $A \stackrel{\text{COMM}}{=} B$ means that B is obtained from A by commutative relations and “ $A_1 \xrightarrow{\rightarrow} A_2$ ” (resp. “ $A_1 \xleftarrow{\leftarrow} A_2$ ”) means that deforming the word $A_1 A A_2$ by moving A right (resp. left). Thus we have $F^{-1} r r_1(l_i) = h_1 h_3 \cdots h_{2n-1} F_1 \cdots F_{n-2} F_{n-1} r r_1(l_i) = l_i$ for $1 \leq i \leq 2n+1$ and

$$F^{-1} r r_1 = 1 \iff r_1 = r F$$

in LMod_{2n+2} . Therefore, we have completed the proof of Lemma 2.2. \square

We can regard a mapping class in $\text{Mod}_{0,2n+2}$ which has a representative fixing D pointwise as an element in $\text{Mod}_{0,2n+1}^1$. Hence we also regard the mapping classes $t_{i,i+1}$ for $1 \leq i \leq 2n+1$ and h_i for $1 \leq i \leq 2n-1$ as elements in $\text{Mod}_{0,2n+1}^1$.

2.3. Explicit lifts of liftable elements for the balanced superelliptic covering map. In this section, from Section 6.1 in [10], we review explicit lifts of liftable elements for the balanced superelliptic covering map $p = p_{g,k}: \Sigma_g \rightarrow \Sigma_0$ which are introduced in Section 2.2. Throughout this section, we assume that $g = n(k-1)$ for $n \geq 1$ and $k \geq 3$.

Let \tilde{l}_i^l for $1 \leq i \leq 2n+1$ and $1 \leq l \leq k$ be a lift of l_i with respect to p such that $\zeta(\tilde{l}_i^l) = \tilde{l}_i^{l+1}$ for $1 \leq l \leq k-1$ and $\zeta(\tilde{l}_i^k) = \tilde{l}_i^1$. We consider a homeomorphism of Σ_g as in Figure 8 and identify Σ_g with the surface as on the lower side in Figure 8.

A simple closed curve γ on $\Sigma_0 - \mathcal{B}$ lifts with respect to p if there exists a simple closed curve $\tilde{\gamma}$ on $\Sigma_g - p^{-1}(\mathcal{B})$ such that the restriction $p|_{\tilde{\gamma}}: \tilde{\gamma} \rightarrow \gamma$ is bijective. By Lemma 3.3 in [8], a simple closed curve γ on $\Sigma_0 - \mathcal{B}$ lifts with respect to p if and only if the algebraic intersection number of γ and $l_1 \cup l_3 \cup \cdots \cup l_{2n+1}$ is zero mod k . Hence the simple closed curve $\gamma_{i,i+1}$ on Σ_0 for $1 \leq i \leq 2n+1$ (see Figure 2) lifts with respect to p . By the information of intersections of $\gamma_{i,i+1}$ and each l_j ($1 \leq j \leq 2n+1$), we can show that a lift of $\gamma_{i,i+1}$ for $1 \leq i \leq 2n+1$ with respect to p by the simple closed curve γ_i^l on Σ_g for $1 \leq l \leq k$ as in Figure 9 (precisely, see before Lemma 6.4 in [10]).

Put $\tilde{t}_{i,i+1} = t_{\gamma_i^1} t_{\gamma_i^2} \cdots t_{\gamma_i^k}$ for $1 \leq i \leq 2n+1$. By Lemma 6.4 in [10], we have the following lemma.

Lemma 2.3. *For $1 \leq i \leq 2n+1$, $\tilde{t}_{i,i+1}$ is a lift of $t_{i,i+1}$ with respect to p .*

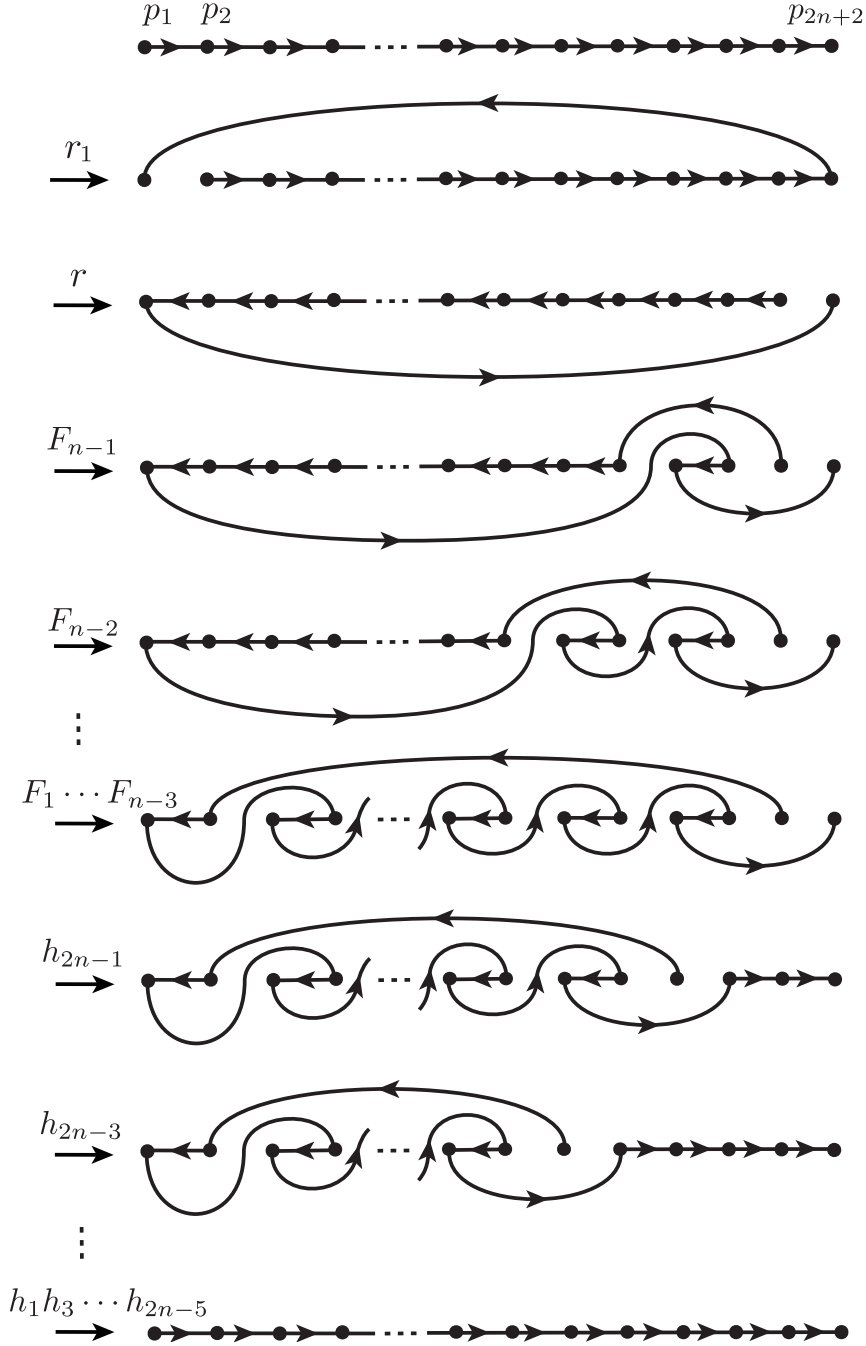
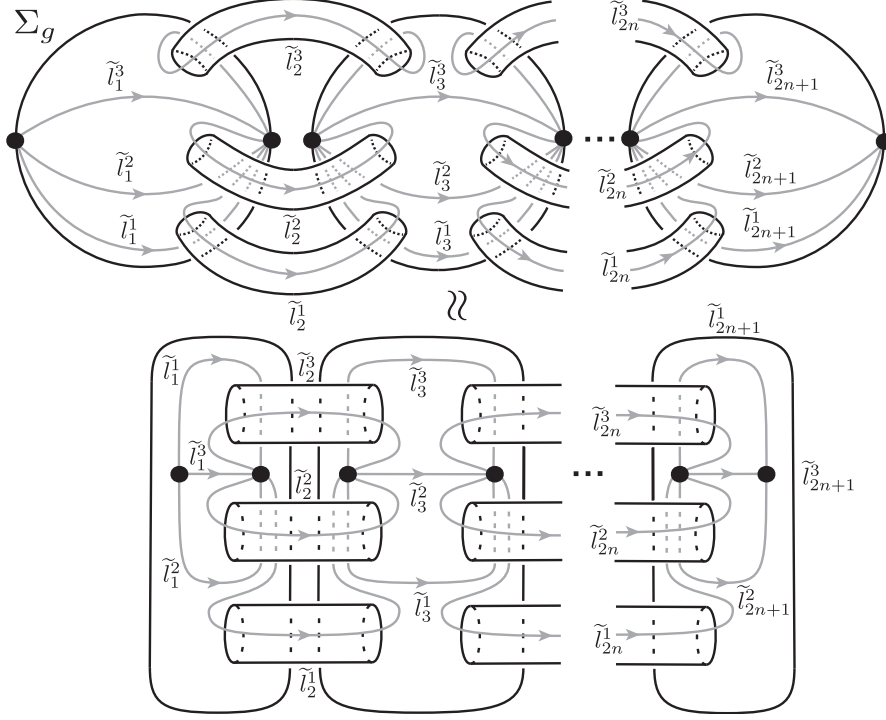
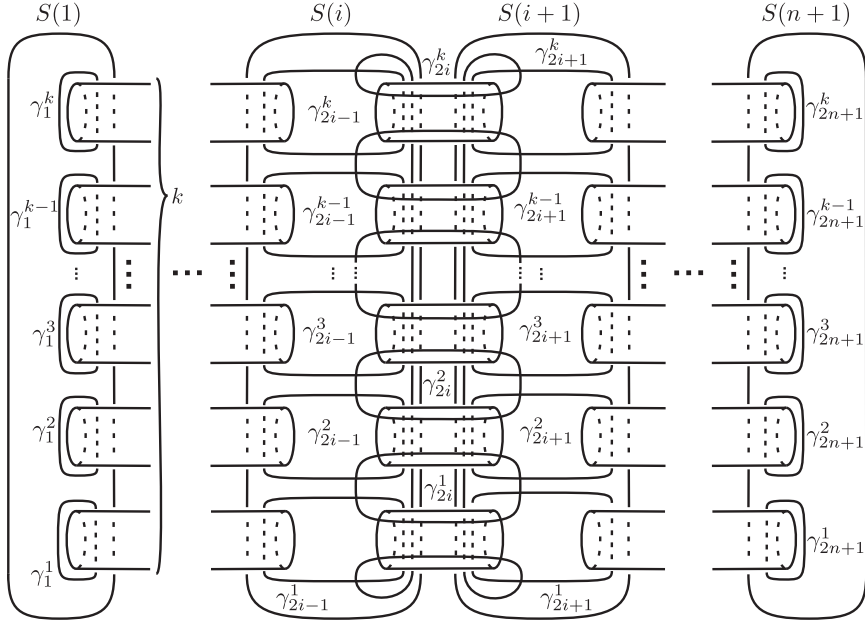

FIGURE 7. The proof of $h_1 h_3 \cdots h_{2n-1} F_1 \cdots F_{n-2} F_{n-1} r r_1(l_i) = l_i$ for $1 \leq i \leq 2n + 1$.

Put $\tilde{h}_i = t_{\gamma_i^1} t_{\gamma_{i+1}^1} t_{\gamma_i^2} t_{\gamma_{i+1}^2} \cdots t_{\gamma_i^{k-1}} t_{\gamma_{i+1}^{k-1}} t_{\gamma_i^k}$ for odd $1 \leq i \leq 2n - 1$ and $\tilde{h}_i = t_{\gamma_i^k} t_{\gamma_{i+1}^k} t_{\gamma_i^{k-1}} t_{\gamma_{i+1}^{k-1}} \cdots t_{\gamma_i^2} t_{\gamma_{i+1}^2} t_{\gamma_i^1}$ for even $2 \leq i \leq 2n$. Then, by Lemma 6.6 in [10], we have the following lemma.

Lemma 2.4. For $1 \leq i \leq 2n$, \tilde{h}_i is a lift of h_i with respect to p .

FIGURE 8. A natural homeomorphism of Σ_g when $k = 3$.FIGURE 9. Simple closed curves γ_i^l on Σ_g for $1 \leq i \leq 2n+1$ and $1 \leq l \leq k$.

Let \tilde{r} be a homeomorphism on Σ_g which satisfies $\tilde{r}(\tilde{l}_{2i-1}^l) = (\tilde{l}_{2n-2i+3}^{k-l+2})^{-1}$ for $1 \leq i \leq n+1$ and $2 \leq l \leq k$ and $\tilde{r}(\tilde{l}_{2i}^l) = (\tilde{l}_{2n-2i+2}^{k-l+1})^{-1}$ for $1 \leq i \leq n$ and $1 \leq l \leq k$. Remark that \tilde{r} is uniquely determined up to isotopy and is described as the result

of the π -rotation of Σ_g as in Figure 10. The rotation axis of \tilde{r} intersects with Σ_g at two points in $S(\frac{n+1}{2})$ for odd n , at two points in the handle intersecting with $\tilde{l}_{n+1}^{\frac{k+1}{2}}$ for even n and odd k , and at no points for even n and k . In actuality, the arc $\tilde{l}_{n+1}^{\frac{k+1}{2}}$ in the case of even n and odd k must intersect with the rotation axis of \tilde{r} , however, we describe $\tilde{l}_{n+1}^{\frac{k+1}{2}}$ in Figure 10 as a parallel arc of $\tilde{l}_{n+1}^{\frac{k+1}{2}}$ to see well. Since $r(l_i) = l_{2n-i+2}^{-1}$ for $1 \leq i \leq 2n+1$, \tilde{r} is a lift of r with respect to p .

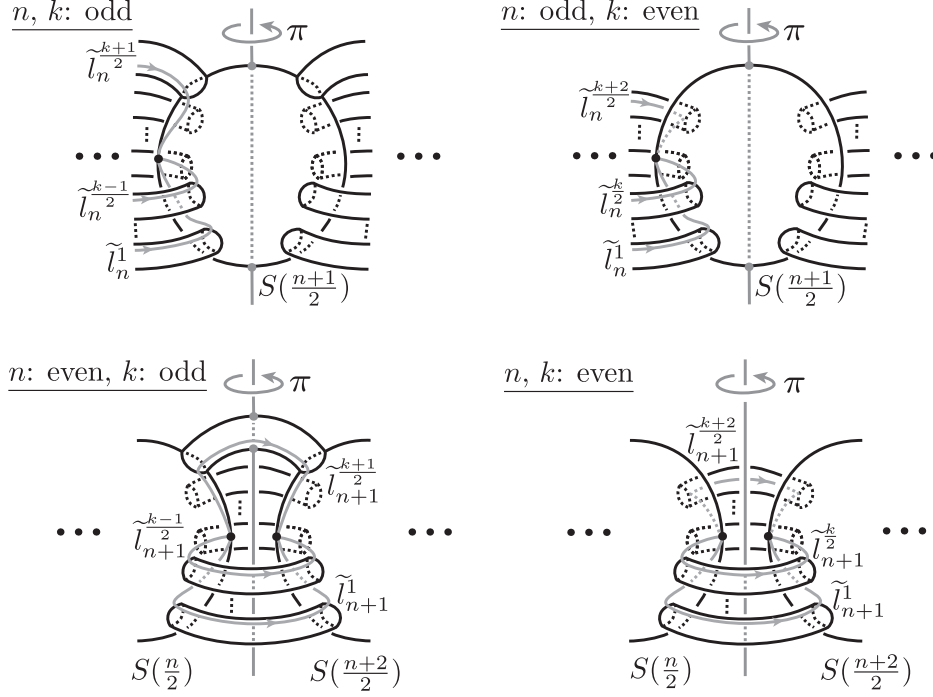

FIGURE 10. A lift \tilde{r} of r with respect to p .

Put $\tilde{r}_1 = \tilde{r}(\tilde{h}_1^{-1}\tilde{h}_2^{-1}\cdots\tilde{h}_{2n-2}^{-1})(\tilde{h}_1^{-1}\tilde{h}_2^{-1}\cdots\tilde{h}_{2n-4}^{-1})\cdots(\tilde{h}_1^{-1}\tilde{h}_2^{-1})\tilde{h}_{2n-1}^{-1}\cdots\tilde{h}_3^{-1}\tilde{h}_1^{-1} \cdot \tilde{t}_{2n,2n+1}^{-1}\cdots\tilde{t}_{6,7}^2\tilde{t}_{4,5}$ for $n \geq 2$ and $\tilde{r}_1 = \tilde{r}\tilde{h}_1^{-1}$ for $n = 1$. By Lemmas 2.2, 2.3, and 2.4 and the fact that \tilde{r} is a lift of r with respect to p , we have the following lemma.

Lemma 2.5. \tilde{r}_1 is a lift of r_1 with respect to p .

3. SMALL GENERATING SETS FOR LIFTABLE MAPPING CLASS GROUPS

Theorem 1.1 follows from the next proposition.

Proposition 3.1. (1) For $n \geq 1$, LMod_{2n+2} is generated by h_1 , $t_{1,2}$, and r_1 .
 (2) For $n \geq 2$, $\text{LMod}_{2n+2,*}$ and LMod_{2n+1}^1 are generated by h_1 , h_2 , and $h_{2n-1}\cdots h_2h_1t_{1,2}$.
 (3) $\text{LMod}_{4,*}$ and LMod_3^1 are generated by h_1 and $t_{1,2}$.

We remark that Proposition 3.1 for $\text{LMod}_{4,*}$ or LMod_3^1 is immediately obtained from Corollary 5.4 in [10] (see also Lemma 3.3). By Proposition 3.1, we can see that LMod_{2n+2} is generated by two infinite order elements and one torsion element with order $2n+2$. In this section, we will prove Theorem 1.1 by showing Proposition 3.1.

3.1. Proof of the main theorem for \mathbf{LMod}_{2n+2} . In this section, we will prove Proposition 3.1 for \mathbf{LMod}_{2n+2} . First, we prove the following lemma.

Lemma 3.2. *For $n \geq 1$ and any parity-reversing element $r' \in \mathbf{LMod}_{2n+2}$, \mathbf{LMod}_{2n+2} is generated by h_i for $1 \leq i \leq 2n$, $t_{1,2}$, and r' .*

Proof. Let $r' \in \mathbf{LMod}_{2n+2}$ be a parity-reversing element and G a subgroup of \mathbf{LMod}_{2n+2} which is generated by h_i for $1 \leq i \leq 2n$, $t_{1,2}$, and r' . Recall that we have the surjective homomorphism $\Psi: \mathbf{LMod}_{2n+2} \rightarrow W_{2n+2}$ by Lemma 2.1 and $\Psi(h_i) = (i \ i+2)$ for $1 \leq i \leq 2n$. Since $S_{n+1}^o \times S_{n+1}^e$ is generated by $(i \ i+2)$ for $1 \leq i \leq 2n$ (for precise definition, see before Lemma 2.1), by the exact sequence (2.1), W_{2n+2} is generated by $\Psi(h_i)$ for $1 \leq i \leq 2n$ and $\Psi(r')$. By Proposition 3.1 in [10], $\mathbf{PMod}_{0,2n+2}$ is generated by $t_{i,j}$ for $1 \leq i < j \leq 2n+1$ with $(i, j) \neq (1, 2n+1)$. Thus, by the exact sequence (2.2), \mathbf{LMod}_{2n+2} is generated by h_i for $1 \leq i \leq 2n$, $t_{i,j}$ for $1 \leq i < j \leq 2n+1$ with $(i, j) \neq (1, 2n+1)$, and r' . It is enough for completing the proof of Lemma 3.2 to prove that $t_{i,j} \in G$ for $(i, j) \neq (1, 2)$.

By the relation (2) (a) of Theorem 5.3 in [10], we have the relation $h_i t_{i,i+1} h_i^{-1} = t_{i+1,i+2}$ for $1 \leq i \leq 2n$. Thus we have $t_{i,i+1} \in G$ for $2 \leq i \leq 2n$. By the relation (4) (a) of Theorem 5.3 in [10], we have the relations

$$t_{i,j} = \begin{cases} h_i^2 & \text{for } j-i=2, \\ t_{j-1,j}^{-\frac{j-i-3}{2}} \cdots t_{i+2,i+3}^{-\frac{j-i-3}{2}} t_{i,i+1}^{-\frac{j-i-3}{2}} (h_{j-2} \cdots h_{i+1} h_i)^{\frac{j-i+1}{2}} & \\ \text{for } 2n-1 \geq j-i \geq 3 \text{ is odd,} & \\ t_{j-2,j-1}^{-\frac{j-i-2}{2}} \cdots t_{i+2,i+3}^{-\frac{j-i-2}{2}} t_{i,i+1}^{-\frac{j-i-2}{2}} h_{j-2} \cdots h_{i+2} h_i h_i h_{i+2} \cdots h_{j-2} & \\ \cdot (h_{j-3} \cdots h_{i+1} h_i)^{\frac{j-i}{2}} & \text{for } 2n \geq j-i \geq 4 \text{ is even.} \end{cases}$$

Therefore, we have $t_{i,j} \in G$ for $j-i \geq 2$ and have completed the proof of Lemma 3.2. \square

Proof of Proposition 3.1 for \mathbf{LMod}_{2n+2} . Let G be a subgroup of \mathbf{LMod}_{2n+2} which is generated by h_1 , $t_{1,2}$, and r_1 . Since r_1 is a parity reversing element, by Lemma 3.2, \mathbf{LMod}_{2n+2} is generated by h_i for $1 \leq i \leq 2n$, $t_{1,2}$, and r_1 . Hence it is enough for completing the proof of Proposition 3.1 to prove that $h_i \in G$ for $2 \leq i \leq 2n$.

By the definition of r_1 , we have $r_1(l_i \cup l_{i+1}) = l_{i+1} \cup l_{i+2}$ for $1 \leq i \leq 2n-1$. Thus we have $r_1 h_i r_1^{-1} = h_{i+1}$ for $1 \leq i \leq 2n-1$ and $h_i \in G$ for $2 \leq i \leq 2n$. Therefore we have completed the proof of Proposition 3.1. \square

3.2. Proofs of the main theorem for $\mathbf{LMod}_{2n+2,*}$ and \mathbf{LMod}_{2n+1}^1 . In this section, we will prove Proposition 3.1 for $\mathbf{LMod}_{2n+2,*}$ and \mathbf{LMod}_{2n+1}^1 . By Corollary 5.4 in [10], we have the following lemma.

Lemma 3.3 (Corollary 5.4 in [10]). *For $n \geq 1$, $\mathbf{LMod}_{2n+2,*}$ and \mathbf{LMod}_{2n+1}^1 are generated by $h_1, h_2, \dots, h_{2n-1}$, and $t_{1,2}$.*

To prove Proposition 3.1 for $\mathbf{LMod}_{2n+2,*}$ and \mathbf{LMod}_{2n+1}^1 , we prepare the following lemma.

Lemma 3.4. *For $n \geq 2$ and $1 \leq i \leq 2n-3$, the relation*

$$(h_{2n-1} \cdots h_2 h_1 t_{1,2})^{-1} h_i (h_{2n-1} \cdots h_2 h_1 t_{1,2}) = h_{i+2}$$

holds in $\mathbf{LMod}_{2n+2,}$ and \mathbf{LMod}_{2n+1}^1 .*

Proof. First, since we can check that $h_i^{-1} h_{i+1}^{-1} h_{i+2}^{-1} (l_i \cup l_{i+1}) = l_{i+2} \cup l_{i+3}$ for $1 \leq i \leq 2n-3$, we have $h_i^{-1} h_{i+1}^{-1} h_{i+2}^{-1} h_i h_{i+2} h_{i+1} h_i = h_{i+2}$ for $1 \leq i \leq 2n-3$ (that is equivalent to the relation (2) (c) of Theorem 5.1 in [10]). Thus we have

$$t_{1,2}^{-1} h_1^{-1} h_2^{-1} \cdots h_{i+2}^{-1} h_{i+3}^{-1} \cdots h_{2n-1}^{-1} \cdot h_i \cdot \underbrace{h_{2n-1} \cdots h_{i+3}}_{\leftarrow} h_{i+2} \cdots h_2 h_1 t_{1,2}$$

$$\begin{aligned}
 & \stackrel{\text{COMM}}{=} t_{1,2}^{-1} h_1^{-1} h_2^{-1} \cdots h_{i-1}^{-1} h_i^{-1} h_{i+1}^{-1} h_{i+2}^{-1} \cdot h_i \cdot h_{i+2} h_{i+1} h_i h_{i-1} \cdots h_2 h_1 t_{1,2} \\
 & = t_{1,2}^{-1} h_1^{-1} h_2^{-1} \cdots h_{i-1}^{-1} \underbrace{h_{i+2} h_{i+1} h_i h_{i-1}}_{\leftarrow} \cdots h_2 h_1 t_{1,2} \\
 & \stackrel{\text{COMM}}{=} h_{i+2}.
 \end{aligned}$$

Therefore, we have completed the proof of Lemma 3.4. \square

Proof of Proposition 3.1 for $\text{LMod}_{2n+2,}$ and LMod_{2n+1}^1 .* Since Theorem 1.1 for $\text{LMod}_{2n+2,*}$ and LMod_{2n+1}^1 when $n = 1$ is obtained from Lemma 3.3, we assume that $n \geq 2$. We will prove Proposition 3.1 for $\text{LMod}_{2n+2,*}$ (for the case of LMod_{2n+1}^1 , we can prove by a similar argument below). Let G be a subgroup of $\text{LMod}_{2n+2,*}$ which is generated by h_1, h_2 , and $h_{2n-1} \cdots h_2 h_1 t_{1,2}$. By Lemma 3.3, $\text{LMod}_{2n+2,*}$ is generated by h_i for $1 \leq i \leq 2n - 1$ and $t_{1,2}$. Hence it is enough for completing the proof of Proposition 3.1 for $\text{LMod}_{2n+2,*}$ to prove that $h_i \in G$ for $3 \leq i \leq 2n$ and $t_{1,2} \in G$.

Since the relation $(h_{2n-1} \cdots h_2 h_1 t_{1,2})^{-1} h_i (h_{2n-1} \cdots h_2 h_1 t_{1,2}) = h_{i+2}$ holds in $\text{LMod}_{2n+2,*}$ for $1 \leq i \leq 2n - 3$ by Lemma 3.4, we have $h_i \in G$ for $3 \leq i \leq 2n - 1$. Hence h_i lies in G for any $1 \leq i \leq 2n - 1$, we have

$$t_{1,2} = h_1^{-1} h_2^{-1} \cdots h_{2n-1}^{-1} \cdot (h_{2n-1} \cdots h_2 h_1 t_{1,2}) \in G.$$

Therefore we have completed the proof of Proposition 3.1. \square

4. SMALL GENERATING SETS FOR BALANCED SUPERELLIPTIC MAPPING CLASS GROUPS

Throughout this section, we assume that $g = n(k - 1)$ for $n \geq 1$ and $k \geq 3$. From Section 2.3, we recall that

- $\tilde{t}_{i,i+1} = t_{\gamma_i^1} t_{\gamma_i^2} \cdots t_{\gamma_i^k}$ for $1 \leq i \leq 2n + 1$,
- $\tilde{h}_i = t_{\gamma_i^1} t_{\gamma_{i+1}^1} t_{\gamma_i^2} t_{\gamma_{i+1}^2} \cdots t_{\gamma_i^{k-1}} t_{\gamma_{i+1}^{k-1}} t_{\gamma_i^k}$ for odd $1 \leq i \leq 2n - 1$,
- $\tilde{h}_i = t_{\gamma_i^k} t_{\gamma_{i+1}^k} t_{\gamma_i^{k-1}} t_{\gamma_{i+1}^{k-1}} \cdots t_{\gamma_i^2} t_{\gamma_{i+1}^2} t_{\gamma_i^1}$ for even $2 \leq i \leq 2n$ (see Figure 9),
- $\tilde{r}_1 = \tilde{r}(\tilde{h}_1^{-1} \tilde{h}_2^{-1} \cdots \tilde{h}_{2n-2}^{-1})(\tilde{h}_1^{-1} \tilde{h}_2^{-1} \cdots \tilde{h}_{2n-4}^{-1}) \cdots (\tilde{h}_1^{-1} \tilde{h}_2^{-1}) \tilde{h}_{2n-1}^{-1} \cdots \tilde{h}_3^{-1} \tilde{h}_1^{-1} \tilde{t}_{2n,2n+1}^{-1} \cdots \tilde{t}_{6,7}^2 \tilde{t}_{4,5}$ for $n \geq 2$,
- $\tilde{r}_1 = \tilde{r} \tilde{h}_1^{-1}$ for $n = 1$.

In this section, we will prove Theorem 1.2 by showing the following proposition.

Proposition 4.1. *For $n \geq 2$ and $k \geq 3$ with $g = n(k - 1)$,*

- (1) $\text{SMod}_{g;k}$ is generated by $\tilde{h}_1, \tilde{t}_{1,2}$, and \tilde{r}_1 ,
- (2) $\text{SMod}_{g,*;k}$ and $\text{SMod}_{g;k}^1$ are generated by \tilde{h}_1, \tilde{h}_2 , and $\tilde{h}_{2n-1} \cdots \tilde{h}_2 \tilde{h}_1 \tilde{t}_{1,2}$ when $n \geq 2$,
- (3) $\text{SMod}_{g,*;k}$ and $\text{SMod}_{g;k}^1$ are generated by \tilde{h}_1 and $\tilde{t}_{1,2}$.

Let $\theta: \text{SMod}_{g;k} \rightarrow \text{LMod}_{2n+2}$ be the surjective homomorphism with the kernel $\langle \zeta \rangle$ which is obtained from the Birman-Hilden correspondence [2], namely θ is defined as follows: for $f \in \text{SMod}_{g;k}$ and a symmetric representative $\varphi \in f$ for ζ , we define $\hat{\varphi}: \Sigma_0 \rightarrow \Sigma_0$ by $\hat{\varphi}(x) = p(\varphi(\tilde{x}))$ for some $\tilde{x} \in p^{-1}(x)$. Then $\theta(f) = [\hat{\varphi}] \in \text{LMod}_{2n+2}$. As a similar construction, we have an isomorphism $\theta^1: \text{SMod}_{g;k}^1 \rightarrow \text{LMod}_{2n+1}^1$ by Birman and Hilden [2].

Proof of Proposition 4.1 for $\text{SMod}_{g,;k}$ and $\text{SMod}_{g;k}^1$.* When $n = 1$, Proposition 4.1 for $\text{SMod}_{g,*;k}$ and $\text{SMod}_{g;k}^1$ is obtained from Corollary 6.13 in [10]. Assume that $n \geq 2$. Since $\tilde{t}_{i,i+1}$ for $1 \leq i \leq 2n + 1$ and \tilde{h}_i for $1 \leq i \leq 2n - 1$ are lifts of $t_{i,i+1}$ and h_i with respect to p by Lemmas 2.3 and 2.4, respectively, Proposition 4.1

for $\text{SMod}_{g,k}^1$ is immediately obtained from Proposition 3.1 for LMod_{2n+1}^1 and the isomorphism θ^1 . The inclusion $\tilde{\nu}: \Sigma_g^1 \hookrightarrow \Sigma_g = \Sigma_g^1 \cup \tilde{D}$ induces the surjective homomorphism $\tilde{\nu}_*: \text{Mod}_g^1 \rightarrow \text{Mod}_{g,1}$ by extending homeomorphisms by the identity map on \tilde{D} . The homomorphism $\tilde{\nu}_*$ is called the *capping homomorphism*. By Lemma 4.9 in [10], we have $\tilde{\nu}_*(\text{SMod}_{g,k}^1) = \text{SMod}_{g,*,k}$. Since we have $\tilde{\nu}_*(\tilde{t}_{i,i+1}) = \tilde{t}_{i,i+1}$ for $1 \leq i \leq 2n+1$ and $\tilde{\nu}_*(\tilde{h}_i) = \tilde{h}_i$ for $1 \leq i \leq 2n-1$ by the definitions, $\text{SMod}_{g,*,k}$ is also generated by \tilde{h}_1, \tilde{h}_2 , and $\tilde{h}_{2n-1} \cdots \tilde{h}_2 \tilde{h}_1 \tilde{t}_{1,2}$. Therefore, we have completed the proof of Proposition 4.1 for $\text{SMod}_{g,*,k}$ and $\text{SMod}_{g,k}^1$. \square

To prove Proposition 4.1 for $\text{SMod}_{g,k}$, we prepare the following lemmas.

Lemma 4.2. *The relation*

$$\tilde{r}_1 \tilde{t}_{i,i+1} \tilde{r}_1^{-1} = \tilde{t}_{i+1,i+2}$$

for $1 \leq i \leq 2n$ holds in $\text{SMod}_{g,k}$.

Proof. By the definition of $\tilde{t}_{i,i+1}$ and conjugation relations, we have

$$\tilde{r}_1 \tilde{t}_{i,i+1} \tilde{r}_1^{-1} = \tilde{r}_1 t_{\gamma_i^1} t_{\gamma_i^2} \cdots t_{\gamma_i^k} \tilde{r}_1^{-1} = t_{\tilde{r}_1(\gamma_i^1)} t_{\tilde{r}_1(\gamma_i^2)} \cdots t_{\tilde{r}_1(\gamma_i^k)}$$

for $1 \leq i \leq 2n$. Since \tilde{r}_1 is a lift of r_1 by Lemma 2.5 and γ_i^l for $1 \leq l \leq k$ is a lift of $\gamma_{i,i+1}$ with respect to p , the simple closed curve $\tilde{r}_1(\gamma_i^l)$ for $1 \leq l \leq k$ is also a lift of $r_1(\gamma_{i,i+1}) = \gamma_{i+1,i+2}$ with respect to p . Hence we have $\{\tilde{r}_1(\gamma_i^1), \tilde{r}_1(\gamma_i^2), \dots, \tilde{r}_1(\gamma_i^k)\} = \{\gamma_{i+1}^1, \gamma_{i+1}^2, \dots, \gamma_{i+1}^k\}$ and

$$t_{\tilde{r}_1(\gamma_i^1)} t_{\tilde{r}_1(\gamma_i^2)} \cdots t_{\tilde{r}_1(\gamma_i^k)} = t_{\gamma_{i+1}^1} t_{\gamma_{i+1}^2} \cdots t_{\gamma_{i+1}^k} = \tilde{t}_{i+1,i+2}$$

in $\text{SMod}_{g,k}$. Therefore, we have completed the proof of Lemma 4.2. \square

Lemma 4.3. *The relation*

$$\tilde{r}_1 \tilde{h}_i \tilde{r}_1^{-1} = \tilde{h}_{i+1}$$

for $1 \leq i \leq 2n-1$ holds in $\text{SMod}_{g,k}$.

Proof. When $n=1$, we have

$$\begin{aligned} \tilde{r}_1(\gamma_1^l) &= \tilde{r}_1 \tilde{h}_1^{-1}(\gamma_1^l) = \tilde{r}_1(t_{\gamma_1^k}^{-1} t_{\gamma_2^{k-1}}^{-1} t_{\gamma_1^{k-1}}^{-1} \cdots t_{\gamma_2^2}^{-1} t_{\gamma_1^2}^{-1} t_{\gamma_2^1}^{-1} t_{\gamma_1^1}^{-1}(\gamma_1^l)) \\ &= \tilde{r}_1(\gamma_2^{l-1}) = \gamma_2^{k-l+1} \end{aligned}$$

for $2 \leq l \leq k$. Similarly, when $n=1$, we have $\tilde{r}_1(\gamma_1^1) = \gamma_2^k$ and $\tilde{r}_1(\gamma_2^l) = \gamma_3^{k-l-1}$ for $1 \leq l \leq k$. Thus, we have

$$\begin{aligned} \tilde{r}_1 \tilde{h}_1 \tilde{r}_1^{-1} &= \tilde{r}_1 t_{\gamma_1^1} t_{\gamma_2^1} t_{\gamma_1^2} t_{\gamma_2^2} \cdots t_{\gamma_1^{k-1}} t_{\gamma_2^{k-1}} t_{\gamma_1^k} \tilde{r}_1^{-1} \\ &= t_{\tilde{r}_1(\gamma_1^1)} t_{\tilde{r}_1(\gamma_2^1)} t_{\tilde{r}_1(\gamma_1^2)} t_{\tilde{r}_1(\gamma_2^2)} \cdots t_{\tilde{r}_1(\gamma_1^{k-1})} t_{\tilde{r}_1(\gamma_2^{k-1})} t_{\tilde{r}_1(\gamma_1^k)} \\ &= t_{\gamma_2^k} t_{\gamma_3^k} t_{\gamma_2^{k-1}} t_{\gamma_3^{k-1}} \cdots t_{\gamma_2^2} t_{\gamma_3^2} t_{\gamma_2^1} \\ &= \tilde{h}_2. \end{aligned}$$

Thus Lemma 4.3 holds for $n=1$.

Assume that $n \geq 2$ and $1 \leq i \leq 2n+1$ is odd. Then, we have $\tilde{h}_i = t_{\gamma_i^1} t_{\gamma_{i+1}^1} t_{\gamma_i^2} t_{\gamma_{i+1}^2} \cdots t_{\gamma_i^{k-1}} t_{\gamma_{i+1}^{k-1}} t_{\gamma_i^k}$. A collection (c_1, c_2, \dots, c_m) of simple closed curves c_1, c_2, \dots, c_m on Σ_g is a m -chain on Σ_g if c_i transversely intersects with c_{i+1} at one point for $1 \leq i \leq m-1$ and c_i is disjoint from c_j for $j \notin \{i-1, i, i+1\}$. Since \tilde{r}_1 is a homeomorphism and $(\gamma_i^1, \gamma_{i+1}^1, \gamma_i^2, \gamma_{i+1}^2, \dots, \gamma_i^{k-1}, \gamma_{i+1}^{k-1}, \gamma_i^k)$ is a $(2k-1)$ -chain on Σ_g , the collection $(\tilde{r}_1(\gamma_i^1), \tilde{r}_1(\gamma_{i+1}^1), \tilde{r}_1(\gamma_i^2), \tilde{r}_1(\gamma_{i+1}^2), \dots, \tilde{r}_1(\gamma_i^{k-1}), \tilde{r}_1(\gamma_{i+1}^{k-1}), \tilde{r}_1(\gamma_i^k))$ is also a $(2k-1)$ -chain on Σ_g . Put $\mathcal{C}_i = \{\gamma_i^1, \gamma_{i+1}^2, \dots, \gamma_i^k\}$ for $1 \leq i \leq 2n+1$. Since $\{\tilde{r}_1(\gamma_i^1), \tilde{r}_1(\gamma_i^2), \dots, \tilde{r}_1(\gamma_i^k)\} = \mathcal{C}_{i+1}$ for

$1 \leq i \leq 2n$ by an argument in the proof of Lemma 4.2, we have $(\tilde{r}_1(\gamma_i^1), \tilde{r}_1(\gamma_{i+1}^1), \tilde{r}_1(\gamma_i^2), \tilde{r}_1(\gamma_{i+1}^2), \dots, \tilde{r}_1(\gamma_i^{k-1}), \tilde{r}_1(\gamma_{i+1}^{k-1}), \tilde{r}_1(\gamma_i^k)) \in \mathcal{C}_{i+1} \times \mathcal{C}_{i+2} \times \mathcal{C}_{i+1} \times \mathcal{C}_{i+2} \times \dots \times \mathcal{C}_{i+1} \times \mathcal{C}_{i+2} \times \mathcal{C}_{i+1}$.

Since \tilde{h}_i and \tilde{r}_1 have symmetric representative for ζ , the product

$$\tilde{r}_1 \tilde{h}_i \tilde{r}_1^{-1} = t_{\tilde{r}_1(\gamma_i^1)} t_{\tilde{r}_1(\gamma_{i+1}^1)} t_{\tilde{r}_1(\gamma_i^2)} t_{\tilde{r}_1(\gamma_{i+1}^2)} \cdots t_{\tilde{r}_1(\gamma_i^{k-1})} t_{\tilde{r}_1(\gamma_{i+1}^{k-1})} t_{\tilde{r}_1(\gamma_i^k)}$$

also has a symmetric representative for ζ , namely, there exists an integer $1 \leq l' \leq k-1$ such that $(\tilde{r}_1 \tilde{h}_i \tilde{r}_1^{-1}) \zeta (\tilde{r}_1 \tilde{h}_i \tilde{r}_1^{-1})^{-1} = \zeta^{l'}$ in $\text{SMod}_{g;k}$. Since $n \geq 2$, for $1 \leq l \leq k$, we have $\tilde{r}_1 \tilde{h}_i \tilde{r}_1^{-1}(\gamma_1^l) = \gamma_1^l$ or $\tilde{r}_1 \tilde{h}_i \tilde{r}_1^{-1}(\gamma_{2n+1}^l) = \gamma_{2n+1}^l$ with orientations. Hence, for $1 \leq l \leq k$, we also have $\zeta^{l'}(\gamma_1^l) = (\tilde{r}_1 \tilde{h}_i \tilde{r}_1^{-1}) \zeta (\tilde{r}_1 \tilde{h}_i \tilde{r}_1^{-1})^{-1}(\gamma_1^l) = \zeta(\gamma_1^l)$ or $\zeta^{l'}(\gamma_{2n+1}^l) = (\tilde{r}_1 \tilde{h}_i \tilde{r}_1^{-1}) \zeta (\tilde{r}_1 \tilde{h}_i \tilde{r}_1^{-1})^{-1}(\gamma_{2n+1}^l) = \zeta(\gamma_{2n+1}^l)$ with orientations. Thus, $l' = 1$ and $\tilde{r}_1 \tilde{h}_i \tilde{r}_1^{-1}$ commutes with ζ .

If $\tilde{r}_1 \tilde{h}_i \tilde{r}_1^{-1} = t_{\gamma_{i+1}^{l'}} t_{\gamma_{i+2}^{l'+1}} t_{\gamma_{i+1}^{l'+1}} \cdots t_{\gamma_{i+2}^{l'+k-2}} t_{\gamma_{i+1}^{l'+k-2}} t_{\gamma_{i+2}^{l'+k-1}} t_{\gamma_{i+1}^{l'+k-1}}$ for $1 \leq i \leq 2n-1$ and some $1 \leq l' \leq k$, where we consider the indices $l', l'+1, \dots, l'+k-1 \pmod k$, then $\tilde{r}_1 \tilde{h}_i \tilde{r}_1^{-1}$ does not commute with ζ . In fact, it is necessarily for the coincidence of $\zeta t_{\gamma_{i+1}^{l'}} t_{\gamma_{i+2}^{l'+1}} t_{\gamma_{i+1}^{l'+1}} \cdots t_{\gamma_{i+2}^{l'+k-2}} t_{\gamma_{i+1}^{l'+k-2}} t_{\gamma_{i+2}^{l'+k-1}} t_{\gamma_{i+1}^{l'+k-1}} \zeta^{-1} = t_{\gamma_{i+1}^{l'+1}} t_{\gamma_{i+2}^{l'+2}} t_{\gamma_{i+1}^{l'+2}} \cdots t_{\gamma_{i+2}^{l'+k-1}} t_{\gamma_{i+1}^{l'+k-1}} t_{\gamma_{i+2}^{l'+k}} t_{\gamma_{i+1}^{l'+k}}$ and $t_{\gamma_{i+1}^{l'}} t_{\gamma_{i+2}^{l'+1}} t_{\gamma_{i+1}^{l'+1}} \cdots t_{\gamma_{i+2}^{l'+k-2}} t_{\gamma_{i+1}^{l'+k-2}} t_{\gamma_{i+2}^{l'+k-1}} t_{\gamma_{i+1}^{l'+k-1}}$ to hold the relation

$$\begin{aligned} & (t_{\gamma_{i+1}^{l'+1}} t_{\gamma_{i+2}^{l'+2}} t_{\gamma_{i+1}^{l'+2}} \cdots t_{\gamma_{i+2}^{l'+k-1}} t_{\gamma_{i+1}^{l'+k-1}}) t_{\gamma_{i+2}^{l'+k}} t_{\gamma_{i+1}^{l'+k}} (t_{\gamma_{i+1}^{l'+1}} t_{\gamma_{i+2}^{l'+2}} t_{\gamma_{i+1}^{l'+2}} \cdots t_{\gamma_{i+2}^{l'+k-1}} t_{\gamma_{i+1}^{l'+k-1}})^{-1} \\ &= t_{\gamma_{i+1}^{l'}} t_{\gamma_{i+2}^{l'+1}} \end{aligned}$$

in $\text{SMod}_{g;k}$. However, this relation does not hold in $\text{SMod}_{g;k}$. Thus, we have $\tilde{r}_1 \tilde{h}_i \tilde{r}_1^{-1} = t_{\gamma_{i+1}^{l'+k-1}} t_{\gamma_{i+2}^{l'+k-1}} t_{\gamma_{i+1}^{l'+k-2}} t_{\gamma_{i+2}^{l'+k-2}} \cdots t_{\gamma_{i+1}^{l'+1}} t_{\gamma_{i+2}^{l'+1}} t_{\gamma_{i+1}^{l'+1}}$ for some $1 \leq l' \leq k$, where we consider the indices $l', l'+1, \dots, l'+k-1 \pmod k$. Since we have the relation

$$\begin{aligned} & (t_{\gamma_{i+1}^{l'+k-2}} t_{\gamma_{i+2}^{l'+k-2}} \cdots t_{\gamma_{i+1}^{l'+1}} t_{\gamma_{i+2}^{l'+1}} t_{\gamma_{i+1}^{l'+1}})^{-1} t_{\gamma_{i+1}^{l'+k-1}} t_{\gamma_{i+2}^{l'+k-1}} (t_{\gamma_{i+1}^{l'+k-2}} t_{\gamma_{i+2}^{l'+k-2}} \cdots t_{\gamma_{i+1}^{l'+1}} t_{\gamma_{i+2}^{l'+1}} t_{\gamma_{i+1}^{l'+1}}) \\ &= t_{\gamma_{i+2}^{l'+1}} t_{\gamma_{i+1}^{l'+1}} \end{aligned}$$

in $\text{SMod}_{g;k}$, by using this relation inductively, we have

$$\begin{aligned} \tilde{r}_1 \tilde{h}_i \tilde{r}_1^{-1} &= t_{\gamma_{i+1}^{l'+k-1}} t_{\gamma_{i+2}^{l'+k-1}} t_{\gamma_{i+1}^{l'+k-2}} t_{\gamma_{i+2}^{l'+k-2}} \cdots t_{\gamma_{i+1}^{l'+1}} t_{\gamma_{i+2}^{l'+1}} t_{\gamma_{i+1}^{l'+1}} \\ &= t_{\gamma_{i+1}^k} t_{\gamma_{i+2}^k} t_{\gamma_{i+1}^{k-1}} t_{\gamma_{i+2}^{k-1}} \cdots t_{\gamma_{i+1}^2} t_{\gamma_{i+2}^2} t_{\gamma_{i+1}^1} \\ &= \tilde{h}_{i+1}. \end{aligned}$$

Thus the relation in Lemma 4.3 for odd $1 \leq i \leq 2n-1$ holds in $\text{SMod}_{g;k}$. By an argument similar to the odd i and $n \geq 2$ case, we can show that the relation in Lemma 4.3 for even $2 \leq i \leq 2n-2$ and $n \geq 2$ also holds in $\text{SMod}_{g;k}$. Therefore we have completed the proof of Lemma 4.3. \square

By Lemma 4.6 in [10], the forgetful homomorphism $\mathcal{F}: \text{SMod}_{g,*,k} \rightarrow \text{SMod}_{g;k}$ which is defined by the correspondence $[\varphi] \mapsto [\varphi]$ is injective. Hence we regard $\text{SMod}_{g,*,k}$ as a subgroup of $\text{SMod}_{g;k}$. Recall that we have the surjective homomorphism $\tilde{\iota}_*: \text{SMod}_{g,k}^1 \rightarrow \text{SMod}_{g,*,k}$ defined in the proof of Proposition 4.1 for $\text{SMod}_{g,*,k}$ and $\text{SMod}_{g,k}^1$.

Proof of Proposition 4.1 for $\text{SMod}_{g,k}$. From the Birman-Hilden correspondence [2], we have the following exact sequence:

$$1 \longrightarrow \langle \zeta \rangle \longrightarrow \text{SMod}_{g,k} \xrightarrow{\theta} \text{LMod}_{2n+2} \longrightarrow 1.$$

Since LMod_{2n+2} is generated by h_1 , $t_{1,2}$, and r_1 for $n \geq 1$ by Proposition 3.1 and \tilde{h}_1 , $\tilde{t}_{1,2}$, and \tilde{r}_1 are lifts of h_1 , $t_{1,2}$, and r_1 with respect to p by Lemmas 2.3, 2.4, and 2.5, respectively, $\text{SMod}_{g;k}$ is generated by \tilde{h}_1 , $\tilde{t}_{1,2}$, \tilde{r}_1 , and ζ by the exact sequence above. It is enough for completing the proof of Proposition 4.1 to prove that ζ is a product of \tilde{h}_1 , $\tilde{t}_{1,2}$, and \tilde{r}_1 .

Let ζ' be a self-homeomorphism on Σ_g which is described as a result of a $(-\frac{2\pi}{k})$ -rotation of $\Sigma_g^1 \subset \Sigma_g$ fixing the disk \tilde{D} pointwise (for instance, in the case of $k = 3$, ζ' is a $(-\frac{2\pi}{3})$ -rotation as on the top in Figure 11). Since the restriction of ζ' to \tilde{D} is identity, we regard ζ' as an element in $\text{SMod}_{g;k}^1$. The isotopy class of a self-homeomorphism on Σ_0 (resp. Σ_g) relative to $D \cup \mathcal{B}$ (resp. \tilde{D}) is determined by the isotopy class of the image of L (resp. $\tilde{L} = p^{-1}(L)$) relative to $D \cup \mathcal{B}$ (resp. \tilde{D}). Since we can show that $p(\zeta'(\tilde{L}))$ is isotopic to $t_{\partial D}(L)$ relative to $D \cup \mathcal{B}$ (in the case $k = 3$, see Figure 11), ζ' is a lift of $t_{\partial D} = t_{1,2n+1}$ with respect to p .

By the relations (4) (a) of Theorems 5.1 and 6.10 in [10], we have

$$t_{1,2n+1} = t_{2n-1,2n}^{-n+1} \cdots t_{3,4}^{-n+1} t_{1,2}^{-n+1} h_{2n-1} \cdots h_3 h_1 h_1 h_3 \cdots h_{2n-1} (h_{2n-2} \cdots h_2 h_1)^n$$

in LMod_{2n+1}^1 and its lift

$$\zeta' = \tilde{t}_{2n-1,2n}^{-n+1} \cdots \tilde{t}_{3,4}^{-n+1} \tilde{t}_{1,2}^{-n+1} \tilde{h}_{2n-1} \cdots \tilde{h}_3 \tilde{h}_1 \tilde{h}_1 \tilde{h}_3 \cdots \tilde{h}_{2n-1} (\tilde{h}_{2n-2} \cdots \tilde{h}_2 \tilde{h}_1)^n$$

in $\text{SMod}_{g;k}^1$. By the definition of ζ' , we have $\tilde{t}_*(\zeta') = \zeta$ clearly. Thus we have

$$\zeta = \tilde{t}_{2n-1,2n}^{-n+1} \cdots \tilde{t}_{3,4}^{-n+1} \tilde{t}_{1,2}^{-n+1} \tilde{h}_{2n-1} \cdots \tilde{h}_3 \tilde{h}_1 \tilde{h}_1 \tilde{h}_3 \cdots \tilde{h}_{2n-1} (\tilde{h}_{2n-2} \cdots \tilde{h}_2 \tilde{h}_1)^n$$

in $\text{SMod}_{g;k}$. By Lemmas 4.2 and 4.2, we have the relations $\tilde{h}_i = \tilde{r}_1^{i-1} \tilde{h}_1 \tilde{r}_1^{-(i-1)}$ for $2 \leq i \leq 2n-1$ and $\tilde{t}_{i,i+1} = \tilde{r}_1^{i-1} \tilde{t}_{1,2} \tilde{r}_1^{-(i-1)}$ for $2 \leq i \leq 2n-1$. Therefore ζ is a product of \tilde{h}_1 , $\tilde{t}_{1,2}$, and \tilde{r}_1 and we have completed the proof of Proposition 4.1. \square

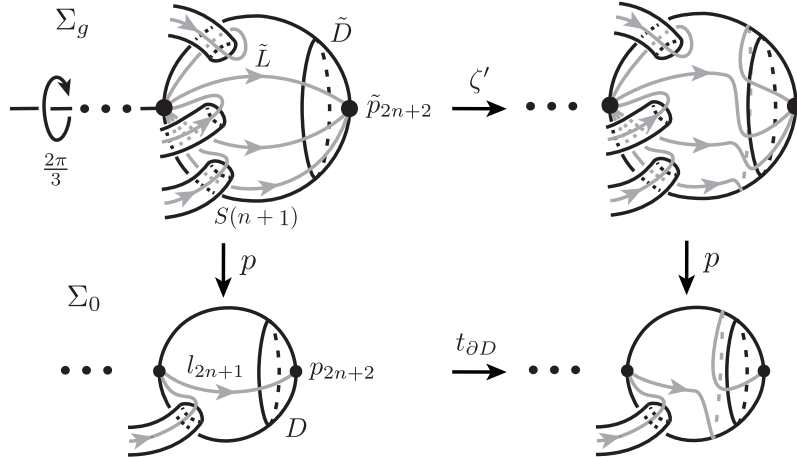

FIGURE 11. The images of L by $t_{\partial D}$ and of \tilde{L} by ζ' for $k = 3$.

Acknowledgement: The author would like to express his gratitude to Susumu Hirose, for his encouragement and helpful advices. The author was supported by JSPS KAKENHI Grant Numbers JP19K23409 and 21K13794.

REFERENCES

- [1] J. S. Birman, H. M. Hilden, *On the mapping class groups of closed surfaces as covering spaces*, Advances in the Theory of Riemann Surfaces (Proc. Conf., Stony Brook, N.Y., 1969), Ann. of Math. Studies 66, Princeton Univ. Press, Princeton, N.J., 81–115, 1971.
- [2] J. S. Birman, H. M. Hilden, *Lifting and projecting homeomorphisms*, Arch. Math. (Basel) **23** (1972), 428–434.
- [3] J. S. Birman, H. M. Hilden, *On isotopies of homeomorphisms of Riemann surfaces*, Ann. of Math. (2) **97** (1973), 424–439.
- [4] M. Dehn, *Die Gruppe der Abbildungsklassen*, Acta Math. **69** (1938), 135–206.
- [5] B. Farb, D. Margalit, *A primer on mapping class groups*, Princeton University Press, Princeton, NJ, 2012.
- [6] S. Gervais, *A finite presentation of the mapping class group of a punctured surface*, Topology **40** (2001), no. 4, 703–725.
- [7] T. Ghaswala, R. R. Winarski, *The liftable mapping class group of balanced superelliptic covers*, arXiv:1604.03908.
- [8] T. Ghaswala, R. R. Winarski, *The liftable mapping class group of balanced superelliptic covers*, New York J. Math. **23** (2017), 133–164.
- [9] T. Ghaswala, R. R. Winarski, *Lifting homeomorphisms and cyclic branched covers of spheres*, Michigan Math. J. **66** (2017), no. 4, 885–890.
- [10] S. Hirose, G. Omori, *Finite presentations for the balanced superelliptic mapping class groups*, arXiv:2203.13413.
- [11] S. P. Humphries, *Generators for the mapping class group*, Topology of low-dimensional manifolds (Proc. Second Sussex Conf., Chelwood Gate, 1977), pp. 44–47, Lecture Notes in Math., 722, Springer, Berlin, 1979.
- [12] M. Korkmaz, *Generating the surface mapping class group by two elements*, Trans. Amer. Math. Soc. **357** (2005), no. 8, 3299–3310.
- [13] C. Labruère and L. Paris, *Presentations for the punctured mapping class groups in terms of Artin groups*, Algebr. Geom. Topol. **1** (2001), 73–114.
- [14] W. B. R. Lickorish, *A finite set of generators for the homeotopy group of a 2-manifold*, Proc. Camb. Philos. Soc. **60** (1964), 769–778.
- [15] N. Monden, *On minimal generating sets for the mapping class group of a punctured surface*, arXiv: 2103.01525.
- [16] M. Stukow, *Small torsion generating sets for hyperelliptic mapping class groups*, Topology Appl. **145** (2004), no. 1-3, 83–90.
- [17] B. Wajnryb, *Mapping class group of a surface is generated by two elements*, Topology **35** (1996), no. 2, 377–383.

(GENKI OMORI) DEPARTMENT OF MATHEMATICS, FACULTY OF SCIENCE AND TECHNOLOGY,
 TOKYO UNIVERSITY OF SCIENCE, 2641 YAMAZAKI, NODA-SHI, CHIBA, 278-8510 JAPAN
Email address: omori_genki@ma.noda.tus.ac.jp