

Forcing constellations of Cichoń’s diagram by using the Tukey order

Miguel A. Cardona¹ and Diego A. Mejía²

¹Institute of Discrete Mathematics and Geometry, TU Wien.

²Faculty of Sciences, Shizuoka University.

Abstract

We use known finite support iteration techniques to present various examples of models where several cardinal characteristics of Cichoń’s diagram are pairwise different. We show some simple examples forcing the left-hand side of Cichoń’s diagram, and present the technique of restriction to models to force Cichoń’s maximum (original from Goldstern, Kellner, Shelah and the second author). We focus on how the values forced in all the constellations are obtained via the Tukey order.

Introduction

Let \mathcal{I} be an ideal of subsets of X such that $\{x\} \in \mathcal{I}$ for all $x \in X$. We define *cardinal characteristics associated with \mathcal{I}* by:

Additivity of \mathcal{I} : $\text{add}(\mathcal{I}) = \min\{|\mathcal{J}| : \mathcal{J} \subseteq \mathcal{I}, \bigcup \mathcal{J} \notin \mathcal{I}\}$.

Covering of \mathcal{I} : $\text{cov}(\mathcal{I}) = \min\{|\mathcal{J}| : \mathcal{J} \subseteq \mathcal{I}, \bigcup \mathcal{J} = X\}$.

Uniformity of \mathcal{I} : $\text{non}(\mathcal{I}) = \min\{|A| : A \subseteq X, A \notin \mathcal{I}\}$.

Cofinality of \mathcal{I} : $\text{cof}(\mathcal{I}) = \min\{|\mathcal{J}| : \mathcal{J} \subseteq \mathcal{I}, \forall A \in \mathcal{I} \exists B \in \mathcal{J} : A \subseteq B\}$.

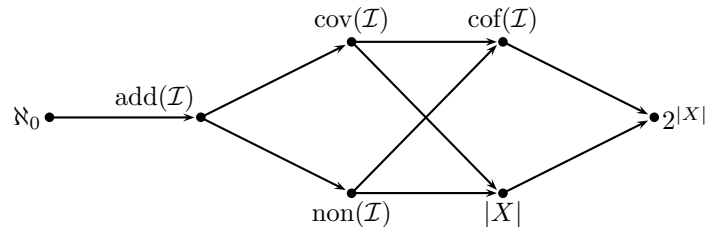

Figure 1: Diagram of the cardinal characteristics associated with \mathcal{I} . An arrow $\mathfrak{x} \rightarrow \mathfrak{y}$ means that (provably in ZFC) $\mathfrak{x} \leq \mathfrak{y}$.

Figure 1 shows the natural inequalities between the cardinal characteristics associated with \mathcal{I} . These cardinals have been studied intensively for \mathcal{M} and \mathcal{N} (see e.g. [BJ95, Bla10]), which denote the σ -ideal first category subsets of \mathbb{R} and the σ -ideal of Lebesgue null subsets of \mathbb{R} , respectively. We denote, as usual, $\mathfrak{c} := 2^{\aleph_0} = |\mathbb{R}|$, and recall that \aleph_1 is the smallest uncountable cardinal.

For $f, g \in \omega^\omega$ we write

$$f \leq^* g \text{ (which is read } f \text{ is dominated by } g) \text{ iff } \exists m \forall n \geq m: f(n) \leq g(n).$$

In addition, we define

The *bounding number* $\mathfrak{b} = \min\{|F| : F \subseteq \omega^\omega \text{ and } \neg \exists y \in \omega^\omega \forall x \in F: x \leq^* y\}$, and

the *dominating number* $\mathfrak{d} = \min\{|D| : D \subseteq \omega^\omega \text{ and } \forall x \in \omega^\omega \exists y \in D: x \leq^* y\}$.

The relationship between these cardinals is best illustrated by *Cichoń's diagram* (see Figure 2), which is one of the most important diagrams in set theory of the reals and has been a relevant object of study since the decade of the 1980's. It is well-known that this diagram is *complete* in the sense that no other inequality can be proved between two cardinal characteristics there. See e.g. [BJ95] for a complete survey about this diagram and its completeness.

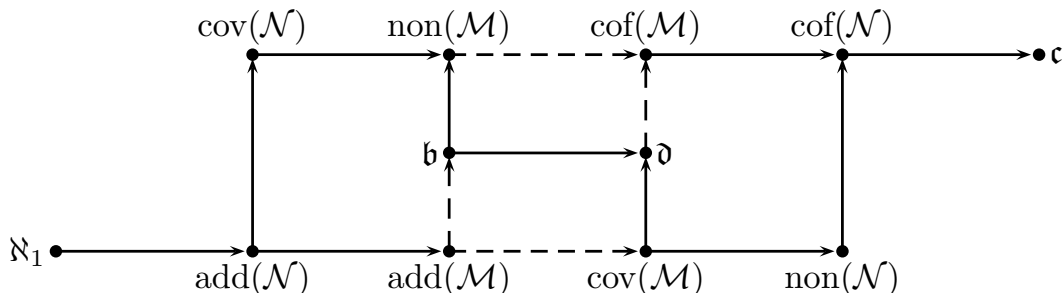

Figure 2: Cichoń's diagram. The arrows mean \leq and dotted arrows represent $\text{add}(\mathcal{M}) = \min\{\mathfrak{b}, \text{cov}(\mathcal{M})\}$ and $\text{cof}(\mathcal{M}) = \max\{\mathfrak{d}, \text{non}(\mathcal{M})\}$.

In the context of this diagram, a natural question arises:

Is it consistent that all the cardinals in Figure 2 (with the exception of the dependent values $\text{add}(\mathcal{M})$ and $\text{cof}(\mathcal{M})$) are pairwise different?

It turns out that the answer to this question is positive and was proved by Goldstern, Kellner and Shelah [GKS19], who used four strongly compact cardinals to obtain the consistency of Cichoń's diagram divided into 10 different values, situation known as *Cichoń's maximum*. In this same direction. This was improved by Brendle and the authors [BCM21] who used only three strongly compact cardinals; finally, Goldstern, Kellner, Shelah and the second author [GKMS21] proved that no large cardinals are needed for the consistency of Cichoń's maximum.

The previously cited work occurs in the context of finite support (FS) iterations of ccc posets. In fact, when calculating the values of the cardinals in Cichoń's diagram in generic extensions, Tukey connections appear implicitly. This appears a bit more explicitly in [GKS19, GKMS21] with the notions of COB (Cone of bounds) and LCU (linear cofinally unbounded), but still the full power of the Tukey connections remained unexplored.

To complement this last part, this work summarizes some of the techniques required to force Cichoń's maximum, but making the role of the Tukey order very explicit. This allows to reformulate all technical results and main theorems in a very beautiful and concise way.

1 Relational systems and cardinal characteristics

Many cardinal characteristics of the continuum and their relations can be represented by relational systems as follows. This presentation is based on [Voj93, Bar10, Bla10].

Definition 1.1. We say that $\mathbf{R} = \langle X, Y, \sqsubset \rangle$ is a *relational system* if it consists of two non-empty sets X and Y and a relation \sqsubset .

- (1) A set $F \subseteq X$ is *\mathbf{R} -bounded* if $\exists y \in Y \forall x \in F: x \sqsubset y$.
- (2) A set $E \subseteq Y$ is *\mathbf{R} -dominating* if $\forall x \in X \exists y \in E: x \sqsubset y$.

We associate two cardinal characteristics with this relational system \mathbf{R} :

$$\mathfrak{b}(\mathbf{R}) := \min\{|F| : F \subseteq X \text{ is } \mathbf{R}\text{-unbounded}\} \text{ the } \textit{unbounding number of } \mathbf{R}, \text{ and}$$

$$\mathfrak{d}(\mathbf{R}) := \min\{|D| : D \subseteq Y \text{ is } \mathbf{R}\text{-dominating}\} \text{ the } \textit{dominating number of } \mathbf{R}.$$

A very representative general example of relational systems is given by directed preorders.

Definition 1.2. We say that $\langle S, \leq_S \rangle$ is a *directed preorder* if it is a preorder (i.e. \leq_S is a reflexive and transitive relation on S) such that

$$\forall x, y \in S \exists z \in S: x \leq_S z \text{ and } y \leq_S z.$$

A directed preorder $\langle S, \leq_S \rangle$ is seen as the relational system $S = \langle S, S, \leq_S \rangle$, and their associated cardinal characteristics are denoted by $\mathfrak{b}(S)$ and $\mathfrak{d}(S)$. The cardinal $\mathfrak{d}(S)$ is actually the *cofinality of S* , typically denoted by $\text{cof}(S)$ or $\text{cf}(S)$.

Fact 1.3. *If a directed preorder S has no maximum element then $\mathfrak{b}(S)$ is infinite and regular, and $\mathfrak{b}(S) \leq \text{cf}(\mathfrak{d}(S)) \leq \mathfrak{d}(S) \leq |S|$. Even more, if L is a linear order without maximum then $\mathfrak{b}(L) = \mathfrak{d}(L) = \text{cof}(L)$.*

The following list of examples are relevant for the main results of this paper.

Example 1.4. Consider $\omega^\omega = \langle \omega^\omega, \leq^* \rangle$, which is a directed preorder. The cardinal characteristics $\mathfrak{b} := \mathfrak{b}(\omega^\omega)$ and $\mathfrak{d} := \mathfrak{d}(\omega^\omega)$ are the well-known *bounding number* and *dominating number*, respectively.

Example 1.5. For any ideal \mathcal{I} on X , we consider the following relational systems.

- (1) $\mathcal{I} := \langle \mathcal{I}, \subseteq \rangle$ is a directed partial order. Note that $\mathfrak{b}(\mathcal{I}) = \text{add}(\mathcal{I})$ and $\mathfrak{d}(\mathcal{I}) = \text{cof}(\mathcal{I})$.
- (2) $\mathbf{C}_{\mathcal{I}} := \langle X, \mathcal{I}, \in \rangle$. Note that $\mathfrak{b}(\mathbf{C}_{\mathcal{I}}) = \text{non}(\mathcal{I})$ and $\mathfrak{d}(\mathbf{C}_{\mathcal{I}}) = \text{cov}(\mathcal{I})$.

Example 1.6. Let θ be an infinite cardinal and X a set of size $\geq \theta$. Then $[X]^{<\theta}$ is an ideal. We look at its associated cardinal characteristics.

Its additivity and uniformity numbers are easy to determine:

$$\text{add}([X]^{<\theta}) = \text{cf}(\theta) \text{ and } \text{non}([X]^{<\theta}) = \theta.$$

For the covering number, we obtain

$$\text{cov}([X]^{<\theta}) = \begin{cases} |X| & \text{if } |X| > \theta, \\ \text{cf}(\theta) & \text{if } |X| = \theta. \end{cases}$$

Therefore $\text{cov}([X]^{<\theta}) = |X|$ whenever θ is regular, which is our case of interest.

The cofinality number is more interesting. Under Shelah's Strong Hypothesis¹ it follows that

$$\text{cof}([X]^{<\theta}) = \begin{cases} |X| & \text{if } \text{cf}(|X|) \geq \theta, \\ |X|^+ & \text{otherwise.} \end{cases}$$

In ZFC, we have $\text{cof}([X]^{<\theta}) = |X|$ whenever $|X|^{<\theta} = |X|$, which is our case of interest.

Inequalities between cardinal characteristics associated with relational systems can be determined by the dual of a relational system and also via Tukey connections, which we introduce below.

Definition 1.7. If $\mathbf{R} = \langle X, Y, \sqsubset \rangle$ is a relational system, then its *dual relational system* is defined by $\mathbf{R}^\perp := \langle Y, X, \sqsubset^\perp \rangle$ where $y \sqsubset^\perp x$ if $\neg(x \sqsubset y)$.

Fact 1.8. Let $\mathbf{R} = \langle X, Y, \sqsubset \rangle$ be a relational system.

- (a) $(\mathbf{R}^\perp)^\perp = \mathbf{R}$.
- (b) The notions of \mathbf{R}^\perp -dominating set and \mathbf{R} -unbounded set are equivalent.
- (c) The notions of \mathbf{R}^\perp -unbounded set and \mathbf{R} -dominating set are equivalent.
- (d) $\mathfrak{d}(\mathbf{R}^\perp) = \mathfrak{b}(\mathbf{R})$ and $\mathfrak{b}(\mathbf{R}^\perp) = \mathfrak{d}(\mathbf{R})$.

Definition 1.9. Let $\mathbf{R} = \langle X, Y, \sqsubset \rangle$ and $\mathbf{R}' = \langle X', Y', \sqsubset' \rangle$ be relational systems. We say that $(\Psi_-, \Psi_+): \mathbf{R} \rightarrow \mathbf{R}'$ is a *Tukey connection from \mathbf{R} into \mathbf{R}'* if $\Psi_-: X \rightarrow X'$ and $\Psi_+: Y' \rightarrow Y$ are functions such that

$$\forall x \in X \forall y' \in Y': \Psi_1(x) \sqsubset' y' \Rightarrow x \sqsubset \Psi_2(y').$$

The *Tukey order* between relational systems is defined by $\mathbf{R} \leq_{\text{T}} \mathbf{R}'$ iff there is a Tukey connection from \mathbf{R} into \mathbf{R}' . *Tukey equivalence* is defined by $\mathbf{R} \cong_{\text{T}} \mathbf{R}'$ iff $\mathbf{R} \leq_{\text{T}} \mathbf{R}'$ and $\mathbf{R}' \leq_{\text{T}} \mathbf{R}$.

¹The failure of this hypothesis requires large cardinals.

Fact 1.10. Assume that $\mathbf{R} = \langle X, Y, \sqsubset \rangle$ and $\mathbf{R}' = \langle X', Y', \sqsubset' \rangle$ are relational systems and that $(\Psi_-, \Psi_+): \mathbf{R} \rightarrow \mathbf{R}'$ is a Tukey connection.

- (a) If $D' \subseteq Y'$ is \mathbf{R}' -dominating, then $\Psi_+[D']$ is \mathbf{R} -dominating.
- (b) $(\Psi_+, \Psi_-): (\mathbf{R}')^\perp \rightarrow \mathbf{R}^\perp$ is a Tukey connection.
- (c) If $E \subseteq X$ is \mathbf{R} -unbounded then $\Psi_-[E]$ is \mathbf{R}' -unbounded.

Corollary 1.11. (a) $\mathbf{R} \leq_T \mathbf{R}'$ implies $(\mathbf{R}')^\perp \leq_T \mathbf{R}^\perp$.

- (b) $\mathbf{R} \leq_T \mathbf{R}'$ implies $\mathfrak{b}(\mathbf{R}') \leq \mathfrak{b}(\mathbf{R})$ and $\mathfrak{d}(\mathbf{R}) \leq \mathfrak{d}(\mathbf{R}')$.
- (c) $\mathbf{R} \cong_T \mathbf{R}'$ implies $\mathfrak{b}(\mathbf{R}') = \mathfrak{b}(\mathbf{R})$ and $\mathfrak{d}(\mathbf{R}) = \mathfrak{d}(\mathbf{R}')$.

Example 1.12. The diagram in Figure 1 can be expressed in terms of the Tukey order since $\mathbf{C}_{\mathcal{I}} \leq_T \mathcal{I}$ and $\mathbf{C}_{\mathcal{I}}^\perp \leq_T \mathcal{I}$.

Example 1.13. If $\theta' \leq \theta$ are infinite cardinals, and $\theta \leq |X| \leq |X'|$, then $\mathbf{C}_{[X]^{<\theta}} \leq_T \mathbf{C}_{[X']^{<\theta'}}$. On the other hand, for any regular cardinal μ , $\mathbf{C}_{[\mu]^{<\mu}} \cong_T [\mu]^{<\mu} \cong_T \mu$, so $\text{add}([\mu]^{<\mu}) = \text{cof}([\mu]^{<\mu}) = \mu$. As a consequence:

Fact 1.14. Assume that $\theta \leq \lambda$ are infinite cardinals. Then, for any regular $\mu \in [\theta, \lambda]$, $\mu \leq_T \mathbf{C}_{[\lambda]^{<\theta}}$.

In fact, the inequalities in Cichoń's diagram (Figure 2) are obtained via the Tukey connections illustrated in Figure 3.

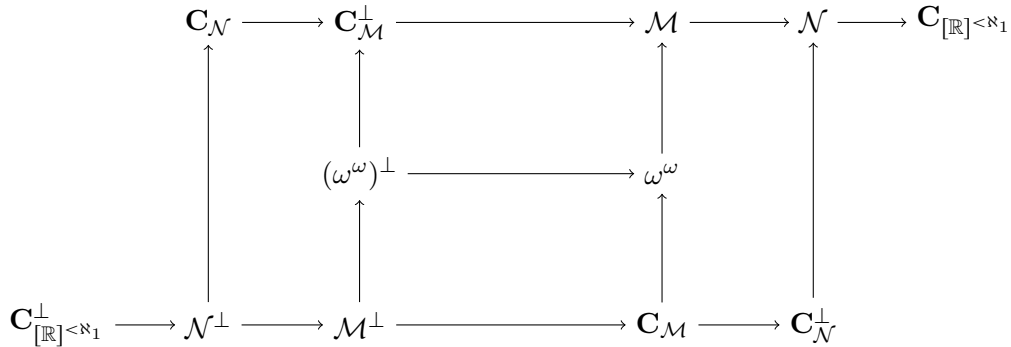

Figure 3: Cichoń's diagram via Tukey connections. Any arrow represents a Tukey connection in the given direction.

In this paper, when we force a value of a cardinal characteristic via ccc posets, we actually force Tukey connections with relational systems of the form $\mathbf{C}_{[\lambda]^{<\theta}}$ and $[\lambda]^{<\theta}$ for some cardinals $\theta \leq \lambda$ with θ uncountable regular. For instance, if \mathbf{R} is a relational system and we force $\mathbf{R} \cong_T \mathbf{C}_{[\lambda]^{<\theta}}$, then we obtain $\mathfrak{b}(\mathbf{R}) = \text{non}([\lambda]^{<\theta}) = \theta$ and $\mathfrak{d}(\mathbf{R}) = \text{cov}([\lambda]^{<\theta}) = \lambda$. In the case when $\lambda^{<\theta} = \lambda$, we obtain the same values when forcing $\mathbf{R} \cong_T [\lambda]^{<\theta}$, also because of the following result.

Lemma 1.15. If θ is a regular cardinal and $|X|^{<\theta} = |X|$, then $\mathbf{C}_{[X]^{<\theta}} \cong_T [X]^{<\theta}$.

Proof. The relation \leq_T is immediate from [Example 1.12](#). For the converse, since $Z := [X]^{<\theta}$ has the same size as X , we get $\mathbf{C}_{[Z]^{<\theta}} \cong_T \mathbf{C}_{[X]^{<\theta}}$ and $[Z]^{<\theta} \cong_T [X]^{<\theta}$ by using a bijection from X into Z , so it is enough to show that $[X]^{<\theta} \leq_T \mathbf{C}_{[Z]^{<\theta}}$. The Tukey connection is given by the identity map from $[X]^{<\theta}$ into Z , and by the map $\Psi_+ : [Z]^{<\theta} \rightarrow [X]^{<\theta}$ defined by $\Psi_+(A) := \bigcup A$. \square

Motivated by the previous explanation, we look at characterizations of the Tukey order between $\mathbf{C}_{[X]^{<\theta}}$ and other relational systems.

Lemma 1.16. *Let θ be an infinite cardinal, I a set of size $\geq \theta$ and let $\mathbf{R} = \langle X, Y, \sqsubset \rangle$ be a relational system. Then:*

(a) *If $|X| \geq \theta$, then $\mathbf{R} \leq_T \mathbf{C}_{[X]^{<\theta}}$ iff $\forall A \in [X]^{<\theta} \exists y_A \in Y \forall x \in A: x \sqsubset y_A$, i.e. any subset of X of size $< \theta$ is \mathbf{R} -bounded.*

In this case, when θ is regular, $\theta \leq \mathfrak{b}(\mathbf{R})$ and $\mathfrak{d}(\mathbf{R}) \leq |X|$.

(b) *$\mathbf{C}_{[I]^{<\theta}} \leq_T \mathbf{R}$ iff $\exists \langle x_i : i \in I \rangle \subseteq X \forall y \in Y: |\{i \in I : x_i \sqsubset y\}| < \theta$.*

In this case, when θ is regular, $\mathfrak{b}(\mathbf{R}) \leq \theta$ and $|I| \leq \mathfrak{d}(\mathbf{R})$.

Proof. (a): The implication from right to left is immediate by using the maps $x \mapsto x$ (identity on X) and $A \mapsto y_A$ as a Tukey connection. For the converse, assume $\mathbf{R} \leq_T \mathbf{C}_{[X]^{<\theta}}$, i.e., there is a Tukey connection $(F, G) : \mathbf{R} \rightarrow \mathbf{C}_{[X]^{<\theta}}$. For $A \in [X]^{<\theta}$, $y_A := G(F[A])$ is as desired. The latter part uses [Example 1.6](#).

(b): The implication from right to left follows by using the maps $i \mapsto x_i$ and $y \mapsto \{i \in I : x_i \sqsubset y\}$. To see the converse, assume that $(F, G) : \mathbf{C}_{[I]^{<\theta}} \rightarrow \mathbf{R}$ is a Tukey connection. For $i \in I$, let $x_i := F(i)$, so $\{i \in I : x_i \sqsubset y\} \subseteq G(y)$ and $|G(y)| < \theta$. \square

When forcing constellations of Cichoń's diagram via ccc posets, we look at simpler characterizations of the relational systems of its cardinals by coding with reals.

Definition 1.17. We say that $\mathbf{R} = \langle X, Y, \sqsubset \rangle$ is a *definable relational system of the reals* if both X and Y are non-empty and analytic in Polish spaces Z and W , respectively, and \sqsubset is analytic in $Z \times W$.

Remark 1.18. In the previous definition indicates that any definable relational system is Tukey equivalent to a relational system of the form $\langle \omega^\omega, \omega^\omega, \sqsubset \rangle$ for some analytic relation \sqsubset on ω^ω . Indeed, if \mathbf{R} is as in [Definition 1.17](#), then Tukey connections are obtained by some Borel isomorphism from ω^ω onto Z .

To characterize the relational systems of Cichoń's diagram, we use relational systems with better definitions.

Definition 1.19. We say that $\mathbf{R} = \langle X, Y, \sqsubset \rangle$ is a *Polish relational system (Prs)* if the following is satisfied:

(i) X is a perfect Polish space,

- (ii) Y is a non-empty analytic subspace of some Polish space Z and
- (iii) $\sqsubset \cap (X \times Z) = \bigcup_{n < \omega} \sqsubset_n$ where $\langle \sqsubset_n \rangle_{n < \omega}$ is some increasing sequence of closed subsets of $X \times Z$ such that $(\sqsubset_n)^y = \{x \in X : x \sqsubset_n y\}$ is closed nowhere dense for any $n < \omega$ and $y \in Y$.

By (iii), we obtain:

Fact 1.20. *If \mathbf{R} is a Prs then $\langle X, \mathcal{M}(X), \in \rangle \leq_T \mathbf{R}$. Therefore, $\mathfrak{b}(\mathbf{R}) \leq \text{non}(\mathcal{M})$ and $\text{cov}(\mathcal{M}) \leq \mathfrak{d}(\mathbf{R})$.*

Example 1.21. The following are Prs that describe the cardinal characteristics of Ci-choń's diagram.

- (1) Define the relational system $\mathbf{Mg} := \langle 2^\omega, \Xi, \in^\bullet \rangle$ where

$$\Xi := \{f: 2^{<\omega} \rightarrow 2^{<\omega} : \forall s \in 2^{<\omega} : s \subseteq f(s)\}$$

and $x \in^\bullet f$ iff $|\{s \in 2^{<\omega} : x \supseteq f(s)\}| < \aleph_0$. This is a Prs and $\mathbf{Mg} \cong_T \mathbf{C}_{\mathcal{M}}$. Hence $\mathfrak{b}(\mathbf{Mg}) = \text{non}(\mathcal{M})$ and $\mathfrak{d}(\mathbf{Mg}) = \text{cov}(\mathcal{M})$.

- (2) The relational system $\omega^\omega := \langle \omega^\omega, \omega^\omega, \leq^* \rangle$ is already Polish.

- (3) Define $\Omega_n := \{a \in [2^{<\omega}]^{<\aleph_0} : \mathbf{Lb}_2(\bigcup_{s \in a} [s]) \leq 2^{-n}\}$ (endowed with the discrete topology) where \mathbf{Lb}_2 is the Lebesgue measure on 2^ω . Put $\Omega := \prod_{n < \omega} \Omega_n$ with the product topology, which is a perfect Polish space. For every $x \in \Omega$ denote $N_x^* := \bigcap_{n < \omega} \bigcup_{s \in x(n)} [s]$, which is clearly a Borel null set in 2^ω .

Define the Prs $\mathbf{Cn} := \langle \Omega, 2^\omega, \sqsubset \rangle$ where $x \sqsubset z$ iff $z \notin N_x^*$. Recall that any null set in 2^ω is a subset of N_x^* for some $x \in \Omega$, so $\mathbf{Cn} \cong_T \mathbf{C}_{\mathcal{N}}^\perp$. Hence, $\mathfrak{b}(\mathbf{Cn}) = \text{cov}(\mathcal{N})$ and $\mathfrak{d}(\mathbf{Cn}) = \text{non}(\mathcal{N})$.

- (4) For each $k < \omega$ let $\text{id}^k: \omega \rightarrow \omega$ such that $\text{id}^k(i) = i^k$ for all $i < \omega$, and $\mathcal{H} := \{\text{id}^{k+1} : k < \omega\}$. Let $\mathbf{Lc}^* := \langle \omega^\omega, \mathcal{S}(\omega, \mathcal{H}), \in^* \rangle$ be the Polish relational system where

$$\mathcal{S}(\omega, \mathcal{H}) := \{\varphi: \omega \rightarrow [\omega]^{<\aleph_0} : \exists h \in \mathcal{H} \forall i < \omega : |\varphi(i)| \leq h(i)\}$$

and $x \in \varphi$ iff $x(i) \in \varphi(i)$ for all but finitely many i . As consequence of [Bar10], $\mathbf{Lc}^* \cong_T \mathcal{N}$, so $\mathfrak{b}(\mathbf{Lc}^*) = \text{add}(\mathcal{N})$ and $\mathfrak{d}(\mathbf{Lc}^*) = \text{cof}(\mathcal{N})$.

To conclude this section, we review products of relational systems.

Definition 1.22. Let $\mathbf{R} = \langle X, Y, \sqsubset \rangle$ and $\mathbf{R}' = \langle X', Y', \sqsubset' \rangle$ be relational systems. Define the relational system $\mathbf{R} \times \mathbf{R}' := \langle X \times X', Y \times Y', \sqsubset_\times \rangle$ by

$$(x, x') \sqsubset_\times (y, y') \Leftrightarrow x \sqsubset y \text{ and } x' \sqsubset' y'.$$

Fact 1.23. *For relational systems \mathbf{R} and \mathbf{R}' :*

- (a) $\mathbf{R} \leq_T \mathbf{R} \times \mathbf{R}'$ and $\mathbf{R}' \leq_T \mathbf{R} \times \mathbf{R}'$.
- (b) $\mathfrak{b}(\mathbf{R} \times \mathbf{R}') = \min\{\mathfrak{b}(\mathbf{R}), \mathfrak{b}(\mathbf{R}')\}$ and $\max\{\mathfrak{d}(\mathbf{R}), \mathfrak{d}(\mathbf{R}')\} \leq \mathfrak{d}(\mathbf{R} \times \mathbf{R}') \leq \mathfrak{d}(\mathbf{R}) \cdot \mathfrak{d}(\mathbf{R}')$.
- (c) *If S and S' are directed preorders, then so is $S \times S'$.*

In Section 5 we use relational systems of the form $\Lambda := \prod_{i < n} \nu_i$ for limit ordinals ν_i and $n < \omega$. Note that $\mathfrak{b}(\Lambda) = \min\{\text{cf}(\nu_i) : i < n\}$ and $\mathfrak{d}(\Lambda) = \max\{\text{cf}(\nu_i) : i < n\}$.

2 Forcing and Tukey connections

We present general results illustrating the effect of FS iterations of ccc posets on the cardinal characteristics associated with a definable relational system of the reals. More concretely, if \mathbf{R} is such a relational system, we show how to force statements of the form $\mathbf{R} \leq_T \mathbf{C}_{[I]^{<\theta}}$ and $\mathbf{C}_{[I]^{<\theta}} \leq_T \mathbf{R}$.

We start by looking at special types of generic reals.

Definition 2.1. Let $\mathbf{R} = \langle X, Y, \sqsubset \rangle$ be a relational system and let M be a set (commonly a model).

- (1) Say that $y \in Y$ is \mathbf{R} -dominating over M if $\forall x \in X \cap M: x \sqsubset y$.
- (2) Say that x is \mathbf{R} -unbounded over M if it is \mathbf{R}^\perp -dominating over M , that is, $\forall y \in Y \cap M: \neg(x \sqsubset y)$.

Example 2.2. The following are examples of very typical Suslin ccc forcing notions and the type of dominating (or unbounded) reals they add over the ground model. For precise definitions, see e.g. [BJ95].

- (1) Cohen reals are precisely the $\mathbf{C}_{\mathcal{M}}$ -unbounded reals, which are precisely the \mathbf{Mg} -unbounded reals in the context of 2^ω . We denote Cohen forcing by \mathbf{C} .
- (2) Random reals are precisely the $\mathbf{C}_{\mathcal{N}}$ -unbounded reals, which are precisely the \mathbf{Cn}^\perp -dominating reals. We denote random forcing by \mathbf{B} .
- (3) The eventually different real forcing \mathbf{E} adds a $\mathbf{C}_{\mathcal{M}}$ -dominating real in ω^ω , which can be transformed into a \mathbf{Mg} -dominating real (in 2^ω).
- (4) Hechler forcing \mathbf{D} adds an ω^ω -dominating real (usually called *dominating real*).
- (5) LOC adds an \mathbf{Lc}^* -dominating real, which also adds an \mathcal{N} -dominating real.

Definition 2.3. Let ν be an ordinal. An iteration $\langle \mathbb{P}_\xi, \dot{\mathbb{Q}}_\xi : \xi < \nu \rangle$ has *finite support* (FS for short) if

- (i) $\xi < \delta \leq \nu \Rightarrow \mathbb{P}_\xi \leq \mathbb{P}_\delta$,
- (ii) $\mathbb{P}_{\xi+1} = \mathbb{P}_\xi * \dot{\mathbb{Q}}_\xi$, and
- (iii) $\mathbb{P}_\delta = \bigcup_{\xi < \delta} \mathbb{P}_\xi$ for all limit $\delta \leq \nu$.

We usually denote $V_\xi := V^{\mathbb{P}^\xi}$ for all $\xi \leq \nu$.

It is important to have a reasonably good picture of a FS iteration before plunging into technical facts, see [Figure 4](#).

Remark 2.4. For limit $\delta \leq \nu$, $V_\delta \neq \bigcup_{\xi < \delta} V_\xi$ in general.

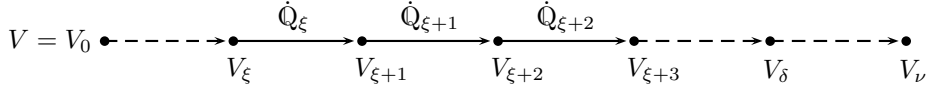

Figure 4: FS iteration of length ν .

Below, we state some well-known facts (most of them without proofs) for FS iterations of forcing notions. The following lemma states that, in FS iterations of certain forcing notions (e.g. ccc forcing notions), no new reals are added at limit stages of uncountable cofinality, a result which will be used often in forthcoming results.

Lemma 2.5. *Let θ be a regular uncountable cardinal. If $\langle \mathbb{P}_\xi, \dot{Q}_\xi : \xi < \nu \rangle$ is a FS iteration of θ -cc posets, i.e. $\Vdash_{\mathbb{P}_\xi} \dot{Q}_\xi$ is θ -cc for all $\xi < \nu$, then \mathbb{P}_ν is θ -cc.*

If, in addition, $\text{cf}(\nu) \geq \theta$, then $\omega^\omega \cap V_\nu = \omega^\omega \cap \bigcup_{\xi < \nu} V_\xi$.

FS iterations add Cohen reals, which is sometimes considered as a limitation of the method.

Lemma 2.6. *Assume that $\mathbb{P}_\nu = \langle \mathbb{P}_\xi, \dot{Q}_\xi : \xi < \nu \rangle$ is a FS iteration of non-trivial posets. If $\xi < \nu$ and ν is limit, then \mathbb{P}_ν adds a Cohen real over V_ξ .*

Corollary 2.7. *Let ν be a limit ordinal of uncountable cofinality and let $\mathbb{P}_\nu = \langle \mathbb{P}_\xi, \dot{Q}_\xi : \xi < \nu \rangle$ be a FS iteration of non-trivial $\text{cf}(\nu)$ -posets. Then \mathbb{P}_ν forces $\nu \leq_{\mathbf{T}} \mathbf{Mg}$. In particular, \mathbb{P}_ν forces $\text{non}(\mathcal{M}) \leq \text{cf}(\nu) \leq \text{cov}(\mathcal{M})$.*

Proof. Since $L \cong_{\mathbf{T}} \nu$ for any cofinal subset L of ν , it is enough to show that $L^* \leq_{\mathbf{T}} \mathbf{C}_{\mathcal{M}}$ where L^* is the set of limit ordinals smaller than ν . For each $i \in L^*$ let $c_i \in V_{i+\omega}$ be a Cohen real over V_i (which exists by Lemma 2.6). Then the Tukey connection is given by the maps $i \mapsto c_i$ and $B \mapsto j_B$, the latter defined by: whenever B is a Borel meager set of reals, $j_B \in L^*$ is chosen such that B is coded in V_{j_B} (which exists by Lemma 2.5). \square

One starting point to force a statement of the form $\mathbf{C}_{[I]^{<\omega}} \leq_{\mathbf{T}} \mathbf{R}$ is the following result.

Fact 2.8. *Let \mathbf{C}_I be the poset that adds Cohen reals indexed by I . If I is uncountable then \mathbf{C}_I forces $\mathbf{C}_{[I]^{<\aleph_1}} \leq_{\mathbf{T}} \mathbf{Mg}$.*

Proof. Apply Lemma 1.16 (b) to the sequence $\langle c_i : i \in I \rangle$ of Cohen reals added by \mathbf{C}_I . \square

The following results illustrates the effect of adding cofinally many \mathbf{R} -dominating reals along a FS iteration.

Lemma 2.9. *Let \mathbf{R} be a definable relational system of the reals, and let ν be a limit ordinal of uncountable cofinality. If $\mathbb{P}_\nu = \langle \mathbb{P}_\xi, \dot{Q}_\xi : \xi < \nu \rangle$ is a FS iteration of $\text{cf}(\nu)$ -cc posets that adds \mathbf{R} -dominating reals cofinally often, then \mathbb{P}_ν forces $\mathbf{R} \leq_{\mathbf{T}} \nu$.*

In addition, if \mathbf{R} is a Prs and all iterands are non-trivial, then \mathbb{P}_ν forces $\mathbf{R} \cong_{\mathbf{T}} \mathbf{Mg} \cong_{\mathbf{T}} \nu$. In particular, \mathbb{P}_ν forces $\mathfrak{b}(\mathbf{R}) = \mathfrak{d}(\mathbf{R}) = \text{non}(\mathcal{M}) = \text{cov}(\mathcal{M}) = \text{cf}(\nu)$.

Proof. Let L be the set of $\xi < \nu$ such that $\dot{\mathbb{Q}}_\xi$ add an \mathbf{R} -dominating real over V_ξ . Since L is cofinal in ν , $L \cong_{\mathbf{T}} \nu$. We show that, in V_ν , $\mathbf{R} \leq_{\mathbf{T}} L$. Consider the maps $F: X^{V_\nu} \rightarrow L$ such that $x \in V_{F(x)}$, and $G: L \rightarrow Y^{V_\nu}$ such that $G(\xi)$ is \mathbf{R} -dominating over V_ξ . Clearly, (F, G) is a Tukey connection.

The second part follows from [Fact 1.20](#) and [Corollary 2.7](#). \square

In most of the cases, we force a Tukey connection between a definable relational system of the reals and some relational system R fixed in the ground model. To calculate the cardinal characteristics in the extension, we need to know when $\mathfrak{b}(R)$ and $\mathfrak{d}(R)$ stay the same in generic extensions.

Lemma 2.10. *Let $\theta > \aleph_0$ be a regular cardinal and let $R = \langle A, B, \sqsubset \rangle$ be a relational system.*

(a) *If $V \models \mathfrak{d}(R) \geq \theta$ then, in any θ -cc generic extension of V , $\mathfrak{d}(R) = \mathfrak{d}(R)^V$.*

(b) *If $V \models \mathfrak{b}(R) \geq \theta$ then, in any θ -cc generic extension of V , $\mathfrak{b}(R) = \mathfrak{b}(R)^V$.*

Here, R is considered as the same object in both V and in the generic extension (not an interpretation).

Proof. We show (a) (note that (b) follows by (a) applied to R^\perp). In V , assume that $\lambda := \mathfrak{d}(R) \geq \theta$ and that $D \subseteq B$ is an R -dominating family of size λ . Let W be a θ -cc generic extension of V . In W , it is clear that D is R -dominating, so $\mathfrak{d}(R)^W \leq \lambda$. Now assume, in W , that $E \subseteq B$ has size $< \lambda$. Since W is a θ -cc generic extension of V and $\lambda \geq \theta$, we can find $E' \in V$ of size $< \lambda$ such that $E \subseteq E' \subseteq B$. In V , $|E'| < \lambda = \mathfrak{d}(R)$, so E' is not R -dominating, hence there is some $x \in X$ which is R -unbounded over E' . It is clear that, in W , x is R -unbounded over E . This concludes that $\mathfrak{d}(R)^W \geq \lambda$. \square

In our applications, R will be a directed set like $[X]^{<\theta} \cap V$, or a relational system of the form $\mathbf{C}_{[X]^{<\theta} \cap V}$. In terms of Tukey equivalence, this will be the same as looking at $[X]^{<\theta}$ and $\mathbf{C}_{[X]^{<\theta}}$, respectively, in the generic extension.

Lemma 2.11. *Let $\theta > \aleph_0$ be a regular cardinal and assume $|X| \geq \theta$. Then, in any θ -cc generic extension, $[X]^{<\theta} \cong_{\mathbf{T}} [X]^{<\theta} \cap V$ and $\mathbf{C}_{[X]^{<\theta}} \cong_{\mathbf{T}} \mathbf{C}_{[X]^{<\theta} \cap V}$. Moreover, $\text{add}([X]^{<\theta}) = \text{add}([X]^{<\theta})^V$, likewise for the other cardinal characteristics associated with the ideal $[X]^{<\theta}$.*

Proof. This follows because, in any θ -cc generic extension of V , any member of $A \in [X]^{<\theta}$ is contained in some member of $[X]^{<\theta} \cap V$. The “moreover” is a consequence of [Lemma 2.10](#) applied to $[X]^{<\theta} \cap V$ and $\mathbf{C}_{[X]^{<\theta} \cap V}$. \square

The following result is a general criteria to force statements of the form $\mathbf{R} \leq_{\mathbf{T}} \mathbf{C}_{[X]^{<\theta}}$.

Theorem 2.12. *Let $\mathbf{R} = \langle X, Y, \sqsubset \rangle$ be a definable relational system of the reals, θ an uncountable regular cardinal, and let $\mathbb{P}_\nu = \langle \mathbb{P}_\xi, \dot{\mathbb{Q}}_\xi : \xi < \nu \rangle$ be a FS iteration of θ -cc posets with $\text{cf}(\nu) \geq \theta$. Assume that, for all $\xi < \nu$ and any $A \in [X]^{<\theta} \cap V_\xi$, there is some $\eta \geq \xi$ such that $\dot{\mathbb{Q}}_\eta$ adds an \mathbf{R} -dominating real over A . Then \mathbb{P}_ν forces $\mathbf{R} \leq_{\mathbf{T}} \mathbf{C}_{[X]^{<\theta}} \cong_{\mathbf{T}} \mathbf{C}_{[X]^{<\theta} \cap V} \leq_{\mathbf{T}} [X]^{<\theta} \cong_{\mathbf{T}} [X]^{<\theta}$, in particular, $\theta \leq \mathfrak{b}(\mathbf{R})$ and $\mathfrak{d}(\mathbf{R}) \leq |X| = \mathfrak{c}$.*

Proof. In V_ν : for $A \in [X]^{<\theta}$ we have that $A \in V_\xi$ for some $\xi < \nu$, so it is \mathbf{R} -bounded by the hypothesis. Hence $\mathbf{R} \leq_{\mathbf{T}} \mathbf{C}_{[X]^{<\theta}}$ by [Lemma 1.16](#). The rest follows by [Example 1.12](#) and [Lemma 2.11](#). \square

Remark 2.13. In connection with the theorem above, [\[GKS19\]](#) defines the following property:

$\text{COB}(\mathbf{R}, \mathbb{P}, \lambda, \vartheta)$ states that there are a directed preorder S of size ν and with $\mathfrak{b}(S) \geq \lambda$, and a sequence $\langle \dot{y}_s : s \in S \rangle$ of \mathbb{P} -names of members of Y such that, for every \mathbb{P} -name \dot{x} of a member of X , there exists an $s_{\dot{x}} \in S$ such that, for all $t \geq_S s_{\dot{x}}$, $\Vdash \dot{x} \sqsubset \dot{y}_t$.

This property implies that there exist a directed preorder S in the ground model such that $\lambda \leq \mathfrak{b}(S)$, $\mathfrak{d}(S) \leq \vartheta$ and $\Vdash_{\mathbb{P}} \mathbf{R} \leq_{\mathbf{T}} S$. Even more, equivalence holds when \mathbb{P} is λ -cc and λ is uncountable regular.

We conclude this section with general results to force statements of the form $\mathbf{C}_{[I]^{<\mu}} \leq_{\mathbf{T}} \mathbf{R}$. For this purpose, we restrict to Polish relational systems and use Judah's and Shelah's [\[JS90\]](#) and Brendle's [\[Bre91\]](#) preservation theory.

Definition 2.14. Let $\mathbf{R} = \langle X, Y, \sqsubset \rangle$ be a Prs and let θ be an infinite cardinal. A poset \mathbb{P} is θ - \mathbf{R} -good if, for any \mathbb{P} -name \dot{h} for a member of Y , there is a non-empty set $H \subseteq Y$ (in the ground model) of size $< \theta$ such that, for any $x \in X$, if x is \mathbf{R} -unbounded over H then $\Vdash x \not\sqsubset \dot{h}$.

We say that \mathbb{P} is \mathbf{R} -good if it is \aleph_1 - \mathbf{R} -good.

Good posets allow us to preserve the Tukey order as follows.

Lemma 2.15. *Let θ be regular uncountable, and let \mathbf{R} be a Prs. Assume that \mathbb{P} is a θ -cc θ - \mathbf{R} -good poset. If μ is a cardinal, $\text{cf}(\mu) \geq \theta$, $|I| \geq \mu$ and $\mathbf{C}_{[I]^{<\mu}} \leq_{\mathbf{T}} \mathbf{R}$, then \mathbb{P} forces that $\mathbf{C}_{[I]^{<\mu}} \leq_{\mathbf{T}} \mathbf{R}$.*

Proof. Choose a sequence $\langle x_i : i \in I \rangle$ as in [Lemma 1.16](#) (b). We show that \mathbb{P} forces $|\{i \in I : x_i \sqsubset y\}| < \mu$ for all $y \in Y$. Let \dot{y} be a \mathbb{P} -name of a member of Y and choose H as in [Definition 2.14](#). Let $B := \bigcup_{y' \in H} \{i \in I : x_i \sqsubset y'\}$, so $|B| < \mu$. Since \mathbb{P} forces $x_i \sqsubset \dot{y} \Rightarrow i \in B$, then \mathbb{P} forces $|\{i \in I : x_i \sqsubset \dot{y}\}| < \mu$. \square

We now present some examples of good posets. A general one is:

Lemma 2.16. *If $\theta \geq \aleph_1$ regular and $|\mathbb{P}| < \theta$, then \mathbb{P} is θ - \mathbf{R} -good. In particular, Cohen forcing is \mathbf{R} -good.*

Proof. See e.g. [\[Mej13, Lemma 4\]](#). \square

Example 2.17. We indicate the type of posets that are good for the Prs of Cichoń's diagram, namely, those of [Example 1.21](#).

- (1) Miller [\[Mil81\]](#) showed that \mathbb{E} is ω^ω -good. Also, random forcing is ω^ω -good. More generally, any μ -Fr-linked poset is μ^+ - \mathbf{D} -good (see [\[Mej19, BCM21\]](#) for details).

- (2) Any μ -centered poset is μ^+ -**Cn**-good (see e.g. [Bre91]). In particular, \mathbb{E} and \mathbb{D} are **Cn**-good.
- (3) Any μ -centered poset is μ^+ -**Lc***-good (see [Bre91, JS90]), so, in particular, \mathbb{E} and \mathbb{D} are **Lc***-good.

Besides, Kamburelis [Kam89] showed that any Boolean algebra with a sfam (strict finitely additive measure) is **Lc***-good. In particular, any subalgebra of random forcing is **Lc***-good.

Good posets are preserved along FS iterations as follows.

Theorem 2.18. *Any FS iteration of θ -cc θ -**R**-good posets is again θ -**R**-good, when θ is regular uncountable.*

Proof. See e.g. [CM19, Thm. 4.15]. □

As a consequence, we get the following main result.

Theorem 2.19 (Fuchino and the second author). *Let θ be an uncountable regular cardinal. If $\mathbb{P} = \langle \mathbb{P}_\xi, \mathbb{Q}_\xi : \xi < \nu \rangle$ is a FS iteration of θ -cc θ -**R**-good posets, and $\nu \geq \theta$, then \mathbb{P} forces $\mathbf{C}_{[\nu]^{<\theta}} \leq_{\mathbf{T}} \mathbf{R}$.*

In particular, \mathbb{P} forces $\vartheta \leq_{\mathbf{T}} \mathbf{R}$ for any regular $\theta \leq \vartheta \leq |\nu|$.

Proof. We only prove the particular case when $\nu = \lambda + \delta$ where $\lambda := |\nu|$ and $\dot{\mathbb{Q}}_\xi = \mathbf{C}$ for all $\xi < \lambda$. By Fact 2.8, \mathbb{P}_λ forces $\mathbf{C}_{[\nu]^{<\aleph_1}} \leq_{\mathbf{T}} \mathbf{Mg}$, which implies $\mathbf{C}_{[\nu]^{<\theta}} \leq_{\mathbf{T}} \mathbf{R}$ by Example 1.13 and Fact 1.20. Since the remaining of the iteration is θ -cc and θ -**R**-good, by Lemma 2.15 \mathbb{P} forces $\mathbf{C}_{[\nu]^{<\theta}} \leq_{\mathbf{T}} \mathbf{R}$.

The “in particular” follows by Fact 1.14. □

Remark 2.20. In connection with the previous result, [GKS19] defines the following property when ϑ is a limit ordinal:²

$\text{EUB}(\mathbf{R}, \mathbb{P}, \vartheta)$ states that there is a sequence $\langle \dot{x}_\alpha : \alpha < \vartheta \rangle$ of \mathbb{P} -names of members of X such that, for every \mathbb{P} -name \dot{y} of a member of Y , there exists an $\alpha_{\dot{y}} < \vartheta$ such that $\forall \beta \geq \alpha_{\dot{y}} : \Vdash \neg(\dot{x}_\beta \sqsubset \dot{y})$.

This property is equivalent to $\text{COB}(\mathbf{R}^\perp, \mathbb{P}, \text{cf}(\vartheta), \text{cf}(\vartheta))$, so it implies $\Vdash \vartheta \leq_{\mathbf{T}} \mathbf{R}$ (see Remark 2.13). In fact, equivalence holds when \mathbb{P} is $\text{cf}(\vartheta)$ -cc.

3 Applications to the left side

This section is dedicated to forcing many values in Cichoń’s diagram, particularly for the left side, by applying the methods of the previous sections.

From now on, we denote the Prs introduced in Example 1.21 by $\mathbf{R}_1 := \mathbf{Lc}^* \cong_{\mathbf{T}} \mathcal{N}$, $\mathbf{R}_2 := \mathbf{Cn} \cong_{\mathbf{T}} \mathbf{C}_{\mathcal{N}}^\perp$, $\mathbf{R}_3 := \omega^\omega$, and $\mathbf{R}_4 := \mathbf{Mg} \cong_{\mathbf{T}} \mathbf{C}_{\mathcal{M}}$.

²The original notation is LCU. The notation EUB (eventually unbounded) comes from [Bre22].

3.1 Warming up

In this section, we present the effect on Cichoń's diagram after the FS iteration of the posets of [Example 2.2](#). We fix a cardinal $\lambda = \aleph_0$.

Cohen forcing

After iterating Cohen forcing λ -many times, we obtain \mathbb{C}_λ . This forces $\lambda = \mathfrak{c}$ and, by [Fact 2.8](#), $\mathbb{C}_{[\lambda]^{<\aleph_1}} \leq_T \mathbf{R}_4$. On the other hand $\mathbf{R}_1 \leq_T \mathbb{C}_{[\mathbb{R}]^{<\aleph_1}} \cong_T \mathbb{C}_{[\lambda]^{<\aleph_1}}$ (see [Figure 3](#)). Therefore, \mathbb{C}_λ forces $\mathbf{R}_i \cong_T \mathbb{C}_{[\lambda]^{<\aleph_1}}$ for all $1 \leq i \leq 4$. In particular, it forces the constellation of [Figure 5](#).

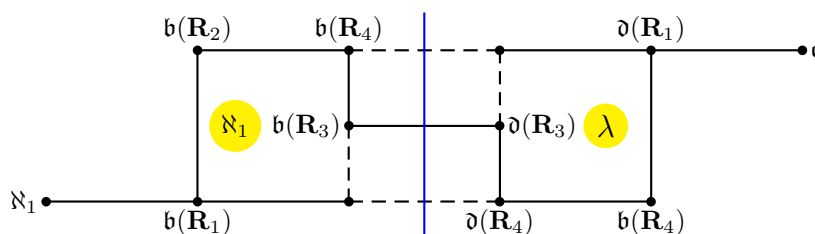

Figure 5: Cichoń's diagram constellation in Cohen's model.

Random forcing

Let \mathbb{P} be the FS iteration of \mathbb{B} of length λ . Then \mathbb{P} forces

- (i) $\mathbf{R}_2 \cong_T \mathbf{R}_4 \cong_T \lambda$, hence $\text{cov}(\mathcal{N}) = \text{non}(\mathcal{M}) = \text{cov}(\mathcal{M}) = \text{non}(\mathcal{N}) = \text{cf}(\lambda)$; and
- (ii) $\mathbf{R}_1 \cong_T \mathbf{R}_3 \cong_T \mathbb{C}_{[\lambda]^{<\aleph_1}} \cong_T \mathbb{C}_{[\mathbb{R}]^{<\aleph_1}}$, hence $\text{add}(\mathcal{N}) = \mathfrak{b} = \aleph_1$ and $\mathfrak{d} = \text{cof}(\mathcal{N}) = \mathfrak{c} = \lambda$.

In particular, when λ is regular, \mathbb{P} forces [Figure 6](#).

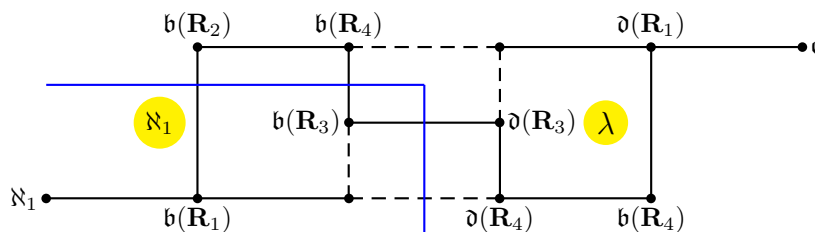

Figure 6: Constellation of Cichoń's diagram after a FS iteration of random forcing of length λ regular.

Indeed, (i) follows by [Lemma 2.9](#), while (ii) follows by [Example 2.17](#) (1) and by [Theorem 2.19](#), also because \mathbb{P} forces $\mathfrak{c} = \lambda$.

Eventually different reals forcing

Let \mathbb{P} be the FS iteration of \mathbb{E} of length λ . Then \mathbb{P} forces

- (i) $\mathbf{R}_4 \cong_{\mathbb{T}} \lambda$, so $\text{non}(\mathcal{M}) = \text{cov}(\mathcal{M}) = \text{cf}(\lambda)$; and
- (ii) $\mathbf{R}_i \cong_{\mathbb{T}} \mathbf{C}_{[\lambda]^{<\aleph_1}} \cong_{\mathbb{T}} \mathbf{C}_{[\mathbb{R}]^{<\aleph_1}}$ for $1 \leq i \leq 3$, hence $\text{cov}(\mathcal{N}) = \mathfrak{b} = \aleph_1$ and $\mathfrak{d} = \text{non}(\mathcal{N}) = \mathfrak{c} = \lambda$.

In particular, when λ is regular, \mathbb{P} forces [Figure 7](#).

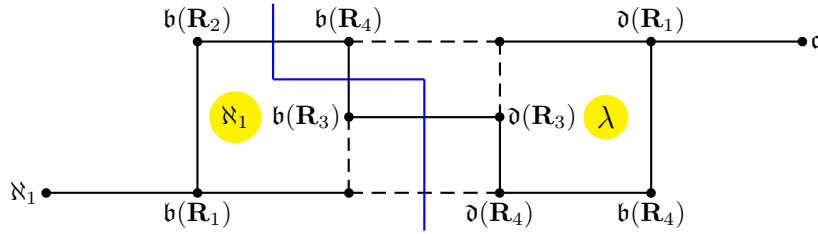

Figure 7: Constellation of Cichoń's diagram after a FS iteration of \mathbb{E} of length λ regular.

Hechler forcing

Let \mathbb{P} be the FS iteration of \mathbb{D} of length λ . Then \mathbb{P} forces

- (i) $\mathbf{R}_3 \cong_{\mathbb{T}} \mathbf{R}_4 \cong_{\mathbb{T}} \lambda$, so $\text{add}(\mathcal{M}) = \text{cof}(\mathcal{M}) = \text{cf}(\lambda)$; and
- (ii) $\mathbf{R}_1 \cong_{\mathbb{T}} \mathbf{R}_2 \cong_{\mathbb{T}} \mathbf{C}_{[\lambda]^{<\aleph_1}} \cong_{\mathbb{T}} \mathbf{C}_{[\mathbb{R}]^{<\aleph_1}}$.

In particular, when λ is regular, \mathbb{P} forces [Figure 8](#).

Localization forcing

Let \mathbb{P} be a FS iteration of $\mathbb{L}\text{OC}$ of length λ . Then \mathbb{P} forces $\mathfrak{c} = \lambda$ and $\mathbf{R}_1 \cong_{\mathbb{T}} \lambda$, hence $\text{add}(\mathcal{N}) = \text{cof}(\mathcal{N}) = \text{cf}(\lambda)$. In particular, when λ is regular, \mathbb{P} forces [Figure 9](#).

3.2 More values

We now present examples of more different values in Cichoń's diagram. All the results cited from [\[Mej13\]](#) are due to Brendle.

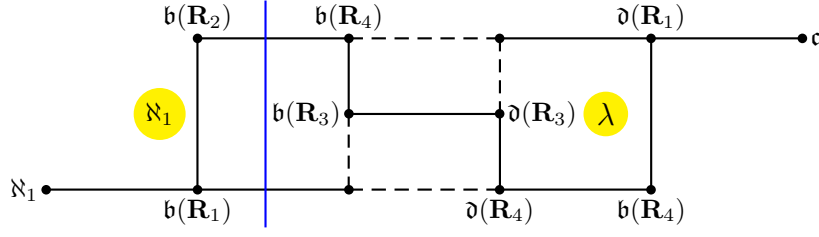

Figure 8: Constellation of Cichoń's diagram in Hechler's model when λ is regular.

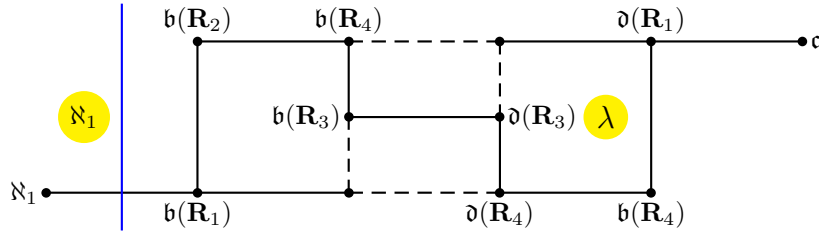

Figure 9: Constellation of Cichoń's diagram after a FS iteration of LOC of length λ regular.

Theorem 3.1 ([Mej13, Theorem 3]). *If $\aleph_1 \leq \lambda_1 \leq \lambda_2 \leq \lambda_3 \leq \lambda_4$ are regular cardinals and $\lambda_5 \geq \lambda_4$ is a cardinal such that $\lambda_5^{<\lambda_3} = \lambda_5$, then there is a ccc poset forcing, for $1 \leq i \leq 3$,*

- (a) $\mathbf{R}_i \cong_{\mathbb{T}} \mathbf{C}_{[\lambda_5]^{<\lambda_i}} \cong_{\mathbb{T}} [\lambda_5]^{<\lambda_i}$; and
- (b) $\mathbf{R}_4 \cong_{\mathbb{T}} \lambda_4$.

In particular, we obtain the consistency of Figure 10.

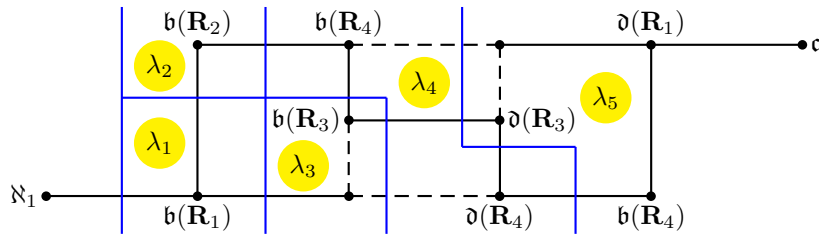

Figure 10: Six values in Cichoń's diagram.

Proof. We shall perform a FS iteration $\mathbb{P} = \langle \mathbb{P}_\xi, \dot{\mathbb{Q}}_\xi : \xi < \nu \rangle$ of length $\nu := \lambda_5 \lambda_4$ (ordinal product) as follows. Fix a partition $\langle C_i : 1 \leq i \leq 3 \rangle$ of $\lambda_5 \setminus \{0\}$ where each set has size λ_5 . For each $\rho < \lambda_4$ denote $\eta_\rho := \lambda_5 \rho$. We define the iteration at each $\xi = \eta_\rho + \varepsilon$ for $\rho < \lambda_4$ and $\varepsilon < \lambda_5$ as follows (see Figure 11):

$$\dot{\mathbb{Q}}_\xi := \begin{cases} \dot{\mathbb{E}} & \text{if } \varepsilon = 0, \\ \text{LOC}^{\dot{N}_\xi} & \text{if } \varepsilon \in C_1, \\ \mathbb{B}^{\dot{N}_\xi} & \text{if } \varepsilon \in C_2, \\ \mathbb{D}^{\dot{N}_\xi} & \text{if } \varepsilon \in C_3, \end{cases}$$

where \dot{N}_ξ is a \mathbb{P}_ξ -name of a transitive model of ZFC of size $< \lambda_i$ when $\varepsilon \in C_i$.

Additionally, by a book-keeping argument, we make sure that all such models N_ξ are constructed such that, for any $\rho < \lambda_4$:

- (i) if $A \in V_{\eta_\rho}$ is a subset of ω^ω of size $< \lambda_1$, then there is some $\varepsilon \in C_1$ such that $A \subseteq N_{\eta_\rho + \varepsilon}$;
- (ii) if $A \in V_{\eta_\rho}$ is a subset of Ω of size $< \lambda_2$, then there is some $\varepsilon \in C_2$ such that $A \subseteq N_{\eta_\rho + \varepsilon}$; and
- (iii) if $A \in V_{\eta_\rho}$ is a subset of ω^ω of size $< \lambda_3$, then there is some $\varepsilon \in C_3$ such that $A \subseteq N_{\eta_\rho + \varepsilon}$.

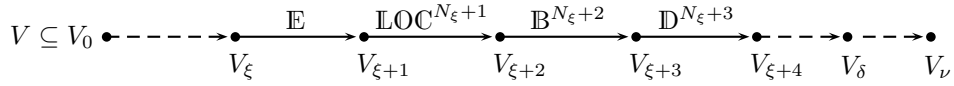

Figure 11: A FS iteration of length ν of ccc partial orders, going through \mathbb{E} cofinally often, as well as through all subforcings of localization forcing of size $< \lambda_1$, all subforcings of random forcing of size $< \lambda_2$, and all subforcings of Hechler forcing of size $< \lambda_3$.

We prove that \mathbb{P} is as required. Clearly, \mathbb{P} forces $\mathfrak{c} = |\nu| = \lambda_5$.

Fix $1 \leq i \leq 3$. Note that all iterands are λ_i - \mathbf{R}_i -good (see Lemma 2.16 and Example 2.17), hence, by Theorem 2.19, \mathbb{P} forces $\mathbf{C}_{[\nu]^{< \lambda_i}} \leq_{\mathbf{T}} \mathbf{R}_i$. On the other hand, \mathbb{P} forces $\mathbf{R} \leq_{\mathbf{T}} \mathbf{C}_{[\mathbb{R}]^{< \lambda_i}}$ by Theorem 2.12. Therefore, since $|\mathbf{R}| = |\nu| = \lambda_5$, we conclude (a).

Finally, since $\text{cf}(\nu) = \lambda_4$, by Lemma 2.9 \mathbb{P} forces $\mathbf{R}_4 \cong_{\mathbf{T}} \lambda_4$. \square

Theorem 3.2 ([Mej13, Theorem 2]). *If $\aleph_1 \leq \lambda_1 \leq \lambda_2 \leq \lambda_3$ are regular cardinals and $\lambda_4 \geq \lambda_3$ is a cardinal such that $\lambda_4^{< \lambda_3} = \lambda_4$, then there is a ccc poset forcing, for $1 \leq i \leq 3$,*

- (i) $\mathbf{R}_i \cong_{\mathbf{T}} \mathbf{C}_{[\lambda_4]^{< \lambda_i}} \cong_{\mathbf{T}} [\lambda_4]^{< \lambda_i}$; and
- (ii) $\mathbf{R}_4 \cong_{\mathbf{T}} \mathbf{R}_3 \cong_{\mathbf{T}} \mathbf{C}_{[\lambda_4]^{< \lambda_3}} \cong_{\mathbf{T}} [\lambda_4]^{< \lambda_3}$.

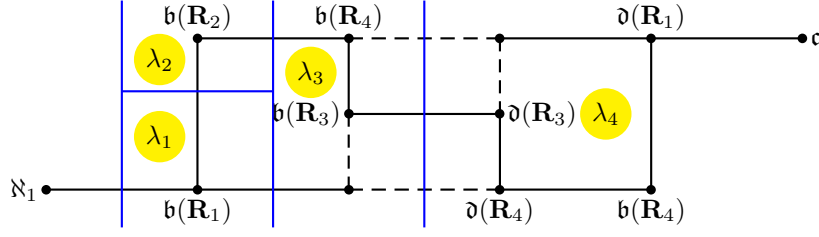

Figure 12: Five values in Cichoń's diagram.

In particular, we obtain the consistency of [Figure 12](#).

Proof. Perform a FS iteration $\mathbb{P} = \langle \mathbb{P}_\xi, \dot{Q}_\xi : \xi < \lambda_4 \rangle$ as follows. Fix a partition $\langle C_i : 1 \leq i \leq 3 \rangle$ of λ_4 into cofinal subsets of size λ_4 . For each $\xi < \lambda_5$ define:

$$\dot{Q}_\xi := \begin{cases} \text{LOC}^{\dot{N}_\xi} & \text{if } \xi \in C_1, \\ \mathbb{B}^{\dot{N}_\xi} & \text{if } \xi \in C_2, \\ \mathbb{D}^{\dot{N}_\xi} & \text{if } \xi \in C_3, \end{cases}$$

where \dot{N}_ξ is a \mathbb{P}_ξ -name of a transitive model of ZFC of size $< \lambda_i$ when $\xi \in C_i$. Additionally, by a book-keeping argument, we make sure that all such models N_ξ are constructed such that conditions similar to (i)–(iii) of the proof of [Theorem 3.1](#) are satisfied. Concretely, if we denote $\mathbf{R}_i := \langle X_i, Y_i, \sqsubset^i \rangle$, we guarantee that, for any $\xi < \lambda$ and $A \subseteq X_i^{V_\xi}$ of size $< \lambda_i$, there is some $\eta \geq \xi$ in C_i such that $A \subseteq N_\eta$. Then, \mathbb{P} is as required. \square

Theorem 3.3 ([\[Mej13, Theorem 4\]](#)). *If $\aleph_1 \leq \lambda_1 \leq \lambda_2 \leq \lambda_3$ are regular cardinals and $\lambda_4 \geq \lambda_3$ is a cardinal such that $\lambda_4^{< \lambda_2} = \lambda_4$, then there is a ccc poset forcing*

- (i) $\mathbf{R}_1 \cong_{\text{T}} \mathbf{C}_{[\lambda_4]^{< \lambda_1}} \cong_{\text{T}} [\lambda_4]^{< \lambda_1}$, $\mathbf{R}_3 \cong_{\text{T}} \mathbf{C}_{[\lambda_4]^{< \lambda_2}} \cong_{\text{T}} [\lambda_4]^{< \lambda_2}$, and
- (ii) $\mathbf{R}_2 \cong_{\text{T}} \mathbf{R}_4 \cong_{\text{T}} \lambda_3$.

In particular, we obtain the consistency of [Figure 13](#).

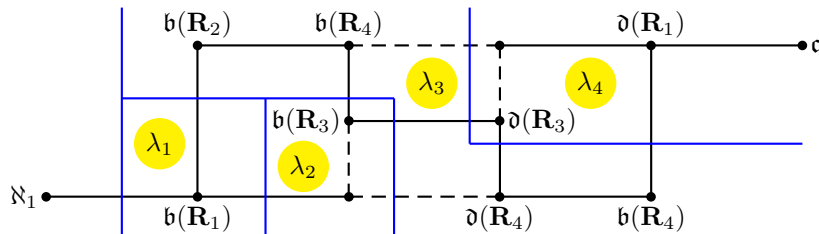

Figure 13: Five values in Cichoń's diagram.

Proof. Perform a FS iteration $\langle \mathbb{P}_\xi, \dot{\mathbb{Q}}_\xi : \xi < \nu \rangle$ of length $\nu := \lambda_4 \lambda_3$ as follows. Fix a partition $\langle C_i : 1 \leq i \leq 3 \rangle$ of $\lambda_4 \setminus \{0\}$ into cofinal subsets of size λ_4 . For each $\rho < \lambda_3$ denote $\eta_\rho := \lambda_4 \rho$. We define the iteration at each $\xi = \eta_\rho + \varepsilon$ for $\rho < \lambda_3$ and $\varepsilon < \lambda_4$ as follows:

$$\dot{\mathbb{Q}}_\xi := \begin{cases} \text{LOC}^{\dot{N}_\xi} & \text{if } \varepsilon \in C_1, \\ \mathbb{D}^{\dot{N}_\xi} & \text{if } \varepsilon \in C_2, \\ \dot{\mathbb{B}} & \text{if } \varepsilon \in C_3, \end{cases}$$

where \dot{N}_ξ is a \mathbb{P}_ξ -name of a transitive model of ZFC of size $< \lambda_i$ when $\varepsilon \in C_i$. We use book-keeping as in (i)–(iii) of [Theorem 3.1](#). The poset \mathbb{P} is as required. \square

Theorem 3.4 ([\[Mej13, Theorem 5\]](#)). *If $\aleph_1 \leq \lambda_1 \leq \lambda_2 \leq \lambda_3$ are regular cardinals and $\lambda_4 \geq \lambda_3$ is a cardinal such that $\lambda_4^{< \lambda_2} = \lambda_4$, then there is a ccc poset forcing, for $1 \leq i \leq 2$*

(i) $\mathbf{R}_i \cong_{\text{T}} \mathbf{C}_{[\lambda_4]^{< \lambda_i}} \cong_{\text{T}} [\lambda_4]^{< \lambda_i}$; and

(ii) $\mathbf{R}_3 \cong_{\text{T}} \mathbf{R}_4 \cong_{\text{T}} \lambda_3$.

In particular, we obtain the consistency of [Figure 14](#).

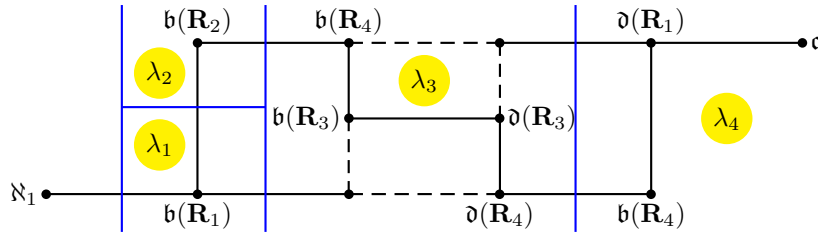

Figure 14: Five values in Cichoń's diagram.

Proof. Perform a FS iteration $\mathbb{P} = \langle \mathbb{P}_\xi, \dot{\mathbb{Q}}_\xi : \xi < \nu \rangle$ of length $\nu := \lambda_4 \lambda_3$ as follows. Consider the same preparation as in the proof of [Theorem 3.3](#). Using book-keeping as in previous proofs, we define the iteration at each $\xi = \eta_\rho + \varepsilon$ for $\rho < \lambda_3$ and $\varepsilon < \lambda_4$ as follows:

$$\dot{\mathbb{Q}}_\xi := \begin{cases} \text{LOC}^{\dot{N}_\xi} & \text{if } \varepsilon \in C_1, \\ \mathbb{B}^{\dot{N}_\xi} & \text{if } \varepsilon \in C_2, \\ \dot{\mathbb{D}} & \text{if } \varepsilon \in C_3, \end{cases}$$

where \dot{N}_ξ is a \mathbb{P}_ξ -name of a transitive model of ZFC of size $< \lambda_i$ when $\varepsilon \in C_i$. \square

We conclude this section by presenting three important results of the left-hand side of Cichoń's digram, which uses sophisticated techniques such as finitely additive measures as well as ultrafilters along FS iterations, and ultrafilters along matrix iterations.

Theorem 3.5 ([GMS16, GKS19]). Let $\lambda_1 \leq \lambda_2 \leq \lambda_3 = \lambda_3^{<\lambda_3} \leq \lambda_4$ be uncountable regular cardinals, and assume that $\lambda_4 < \lambda_5^{<\lambda_4}$ and λ_4 is \aleph_1 -inaccessible.³ Then there is a ccc poset that forces $\mathfrak{c} = \lambda_5$ and $\mathbf{R}_i \cong_{\mathbb{T}} \mathbf{C}_{[\lambda_5]^{<\lambda_i}} \cong_{\mathbb{T}} [\lambda_5]^{<\lambda_i} \cong_{\mathbb{T}} [\lambda_5]^{<\lambda_i} \cap V$ for all $1 \leq i \leq 4$. In particular, it forces the constellation in Figure 15.

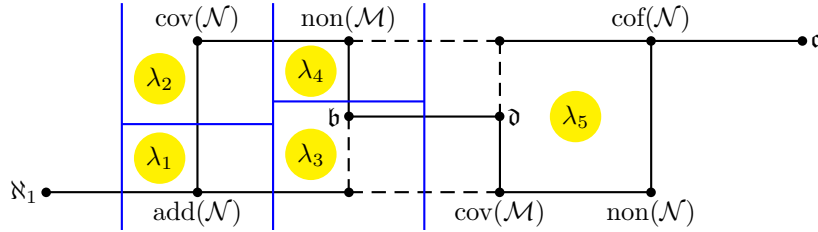

Figure 15: The left side of Cichoń's diagram.

Theorem 3.6 ([KST19]). Let $\lambda_1 \leq \lambda_2 = \lambda_2^{<\lambda_2} \leq \lambda_3 \leq \lambda_4$ be regular cardinals, and assume that λ_3 and λ_4 are \aleph_1 -inaccessible, and $\lambda_5 = \lambda_5^{<\lambda_4} > \lambda_4$. Then there is a ccc poset that forces $\mathfrak{c} = \lambda_5$, $\mathbf{R}_i \cong_{\mathbb{T}} [\lambda_5]^{<\lambda_i} \cap V$ for $i = 1, 4$, $\mathbf{R}_2 \cong_{\mathbb{T}} [\lambda_5]^{<\lambda_3} \cap V$ and $\mathbf{R}_3 \cong_{\mathbb{T}} [\lambda_5]^{<\lambda_2} \cap V$. In particular, it forces the constellation in Figure 16.

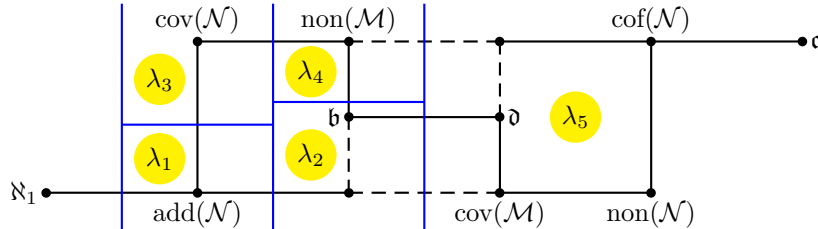

Figure 16: Alternative left side of Cichoń's diagram.

Theorem 3.7 ([BCM21]). Let $\lambda_0 \leq \lambda_1 \leq \lambda_2 \leq \lambda_3 \leq \lambda_4 \leq \lambda_5$ be uncountable regular cardinals and let $\lambda_6 \geq \lambda_5$ be a cardinal such that $\lambda_6^{<\lambda_3} = \lambda_6$, then there is a ccc poset that forces

- (a) $\mathbf{R}_i \cong_{\mathbb{T}} \mathbf{C}_{[\lambda_6]^{<\lambda_i} \cap V} \cong_{\mathbb{T}} [\lambda_6]^{<\lambda_i} \cap V$ for $1 \leq i \leq 3$, and
- (b) $\lambda_4 \leq_{\mathbb{T}} \mathbf{R}_4$, $\lambda_5 \leq_{\mathbb{T}} \mathbf{R}_4$ and $\mathbf{R}_4 \leq_{\mathbb{T}} \lambda_5 \times \lambda_4$.

In particular, it forces the constellation in Figure 17.

³A cardinal λ is θ -inaccessible if $\mu^\nu < \lambda$ for any $\mu < \lambda$ and $\nu < \theta$.

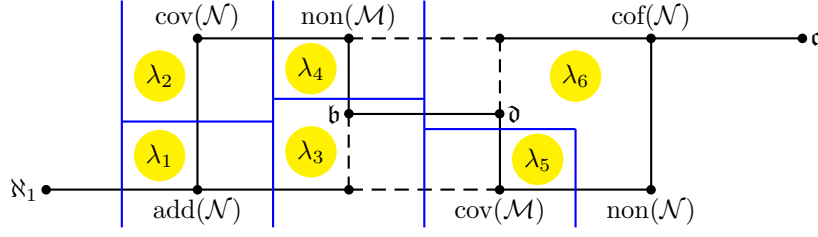

Figure 17: Seven values in Cichoń's digram.

We remark that, in [Theorem 3.7](#), we cannot force $\mathbf{R}_4 \cong_T \mathbf{C}_{[\lambda_5]^{<\lambda_4}}$ because, in the ground model, $\mathbf{C}_{[\lambda_5]^{<\lambda_4}} \not\leq_T \lambda_5 \times \lambda_4$ in the case when $\lambda_4 < \lambda_5$. To see this, note that if $\langle (a_i, b_i) : i < \lambda_5 \rangle \subseteq \lambda_5 \times \lambda_4$, then there is some $L \subseteq \lambda_5$ of size λ_5 such that the sequence $\langle b_i : i \in L \rangle$ is constant with value some $b < \lambda_4$. Then, it is possible to find some $a < \lambda_5$ such that $\{i \in L : (a_i, b_i) \leq (a, b)\}$ has size $\geq \lambda_4$, so we conclude that there is no Tukey connection by [Lemma 1.16](#) (b). On the other hand, we can say that $\mathbf{R}_4 \leq_T \mathbf{C}_{[\lambda_5]^{<\lambda_4 \cap V}}$ because, in the ground model, $\lambda_5 \times \lambda_4 \leq_T \mathbf{C}_{[\lambda_5 \times \lambda_4]^{<\lambda_4}}$.

4 Restriction to submodels

We present the general theory of intersection of posets with σ -closed models. This is the main tool in [\[GKMS21\]](#) to force Cichoń's maximum without using large cardinals. In this section we do not only review this method, but we analyze its effect on the Tukey order. For this section, we fix:

- (F1) a ccc poset \mathbb{P} ;
- (F2) a definable relational system $\mathbf{R} = \langle X, Y, \sqsubset \rangle$ of the reals, here wlog $X = Y = \omega^\omega$; and
- (F3) a large enough regular cardinal χ such that $\mathbb{P} \in H_\chi$, and H_χ contains all the parameters defining \mathbf{R} .

Definition 4.1. A model $N \leq H_\chi$ is $<\kappa$ -closed if $N^{<\kappa} \subseteq N$. We write σ -closed for $<\aleph_1$ -closed.

When intersecting a ccc poset with a σ -closed model, we obtain a completely embedded subforcing.

Lemma 4.2. *If $N \leq H_\chi$ is σ -closed and $\mathbb{P} \in N$, then $\mathbb{P} \cap N \leq \mathbb{P}$.*

Semantically, there is a correspondence between some $\mathbb{P} \cap N$ -names a \mathbb{P} -names belonging to N , and we can also have a correspondence for the forcing relation for some formulas.

Fact 4.3. *If $\kappa > \aleph_0$ is regular and N is $<\kappa$ closed then there is a one-to-one correspondence between:*

(i) \mathbb{P} -names $\tau \in N$ and

(ii) $\mathbb{P} \cap N$ -names σ

of members of H_κ (in particular, reals). Thus, if G is \mathbb{P} -generic over V then $N[G] \cap H_\kappa^{V[G]} = H_\kappa^{V[G \cap N]}$.

Corollary 4.4. *For absolute $\varphi(\bar{x})$ (e.g. Borel on the reals) if $p \in \mathbb{P} \cap N$ and $\bar{\tau} \in N$ is a finite sequence of \mathbb{P} -names of members of H_κ , then*

$$p \Vdash_{\mathbb{P}} \varphi(\bar{\tau}) \Leftrightarrow p \Vdash_{\mathbb{P} \cap N} \varphi(\bar{\sigma}).$$

The following result illustrates the main motivation to intersect ccc posets with σ -closed models, since it affects the Tukey relations forced by the posets.

Lemma 4.5. *Let $N \leq H_\chi$ be σ -closed and let $K = \langle A, B, \triangleleft \rangle$ be a relational system. Assume that \mathbb{P} , K and the parameters of \mathbf{R} are in N .*

(a) *If $\mathbb{P} \Vdash \mathbf{R} \leq_{\mathbf{T}} K$ then $\mathbb{P} \cap N \Vdash \mathbf{R} \leq_{\mathbf{T}} K \cap N$ where $K \cap N := \langle A \cap N, B \cap N, \triangleleft \rangle$.*

(b) *If $\mathbb{P} \Vdash K \leq_{\mathbf{T}} \mathbf{R}$ then $\mathbb{P} \cap N \Vdash K \cap N \leq_{\mathbf{T}} \mathbf{R}$.*

Proof. (a): Find a sequence $\langle \dot{y}_j : j \in B \rangle \in N$ of \mathbb{P} -names of members of ω^ω such that

$$\Vdash_{\mathbb{P}} \forall x \in \omega^\omega \exists i_x \in A \forall j \in B : i_x \triangleleft j \Rightarrow x \sqsubset \dot{y}_j.$$

For $j \in B \cap N$, \dot{y}_j can be seen as a $\mathbb{P} \cap N$ -name of a member of ω^ω .

We claim that $\Vdash_{\mathbb{P} \cap N} \forall x \in \omega^\omega \exists i_x \in A \cap N \forall j \in B \cap N : i_x \triangleleft j \Rightarrow x \sqsubset \dot{y}_j$. Let $p \in \mathbb{P} \cap N$ and let \dot{x} be a $\mathbb{P} \cap N$ -name of a real. Then $\dot{x} \in N$ and

$$N \models p \Vdash_{\mathbb{P}} \exists i_{\dot{x}} \in A \forall j \in B : i_{\dot{x}} \triangleleft j \Rightarrow \dot{x} \sqsubset \dot{y}_j.$$

Find $q \leq p$ in N and $i_{\dot{x}} \in A \cap N$ such that

$$\forall j \in B \cap N : i_{\dot{x}} \triangleleft j \Rightarrow N \models q \Vdash_{\mathbb{P}} \dot{x} \sqsubset \dot{y}_j.$$

But $N \models q \Vdash_{\mathbb{P}} \dot{x} \sqsubset \dot{y}_j \Leftrightarrow q \Vdash_{\mathbb{P}} \dot{x} \sqsubset \dot{y}_j \Leftrightarrow q \Vdash_{\mathbb{P} \cap N} \dot{x} \sqsubset \dot{y}_j$. Thus $\langle \dot{y}_j : j \in B \cap N \rangle$ witnesses $\mathbb{P} \cap N \Vdash \mathbf{R} \leq_{\mathbf{T}} K \cap N$.

(b): If $\mathbb{P} \Vdash K \leq_{\mathbf{T}} \mathbf{R}$ then $\mathbb{P} \Vdash \mathbf{R}^\perp \leq_{\mathbf{T}} K^\perp$. Although \mathbf{R} is not as in [Definition 1.17](#), the relation \sqsubset is absolute enough to prove $\mathbb{P} \Vdash \mathbf{R}^\perp \leq_{\mathbf{T}} K^\perp \cap N$ as in (a). Note that $K^\perp \cap N = \langle B \cap N, A \cap N, \triangleleft \rangle = (K \cap N)^\perp$, so we can conclude that $\mathbb{P} \cap N \Vdash K \cap N \leq_{\mathbf{T}} \mathbf{R}$. \square

As a consequence, if $\mathbb{P} \Vdash \mathbf{R} \cong_{\mathbf{T}} K$ then $\mathbb{P} \cap N \Vdash \mathbf{R} \cong_{\mathbf{T}} K \cap N$. Hence, to know the values that $\mathbb{P} \cap N$ force to $\mathfrak{b}(\mathbf{R})$ and $\mathfrak{d}(\mathbf{R})$, we need to calculate the cardinal characteristics of the relational system $K \cap N$ (recall [Lemma 2.10](#)), or find natural Tukey equivalent relational systems. The theory developed from now on has the purpose to understand $K \cap N$ in some specific contexts. In the applications, K is often a directed preorder.

Fact 4.6. Let $N \leq H_\chi$ be σ -closed and let $K = \langle A, B, \triangleleft \rangle \in N$ be a relational system.

(a) $\mathfrak{b}(K \cap N) \leq |\mathfrak{b}(K) \cap N|$ and $\mathfrak{d}(K \cap N) \leq |\mathfrak{d}(K) \cap N|$.

(b) If N is $<\kappa$ -closed then $\mathfrak{b}(K \cap N) \geq \min\{\mathfrak{b}(K), \kappa\}$. In particular, if N is $<\mathfrak{b}(K)$ -closed then $\mathfrak{b}(K \cap N) = \mathfrak{b}(K)$.

(c) Property (b) holds for the \mathfrak{d} -numbers.

(d) If $S \in N$ is a directed preorder and $\mathfrak{d}(S) \subseteq N$, then $S \cap N \cong_{\mathbf{T}} S$.

Proof. (a) Find $f \in N$, $f: \mathfrak{d}(K) \rightarrow B$ where $f[\mathfrak{d}(K)]$ is K -dominating. So $\{f(\alpha) : \alpha \in \mathfrak{d}(K) \cap N\} \subseteq B \cap N$ is $K \cap N$ -dominating. Thus $\mathfrak{d}(K \cap N) \leq |\mathfrak{d}(K) \cap N|$. The inequality of the \mathfrak{b} -number follows by applying the previous to K^\perp .

(b): If $F \subseteq A \cap N$ has size $< \min\{\mathfrak{b}(S), \kappa\}$ then $F \in N$ and $N \models \exists y \in B \forall x \in F: x \triangleleft y$, so such a y can be found in $B \cap N$.

(c): Apply (b) to K^\perp .

(d): If $\mathfrak{d}(S) \subseteq N$ then $f[\mathfrak{d}(S)] \subseteq N$ where f is as in (a), so $S \cap N$ is cofinal in S and $S \cap N \cong_{\mathbf{T}} S$. \square

Figure 18 illustrates the situation of Fact 4.6 when $K = S$ is a directed poset, $\delta_N := \min\{\delta \in \mathbf{On} : \delta \notin N\}$ and $|N| < \delta_N$ (the latter will hold in our applications).

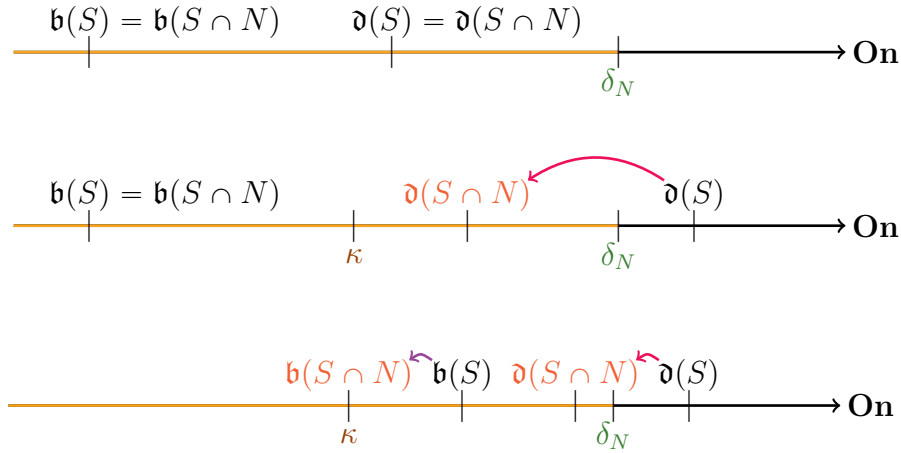

Figure 18: Effect on $\mathfrak{b}(S)$ and $\mathfrak{d}(S)$ after intersecting with N as in Fact 4.6 when $|N| < \delta_N$ and $S = K$ is a directed preorder. The situation on the top corresponds to (d), where the cardinal characteristics do not change; the middle corresponds to (b), where $\mathfrak{b}(S \cap N) = \mathfrak{b}(S)$ but $\mathfrak{d}(S \cap N)$ gets smaller; and the situation at the bottom indicates that $\mathfrak{d}(S \cap N)$ gets smaller and that $\mathfrak{b}(S \cap N)$ may become smaller.

The effect on the relational systems depends very much on the structure of the model. We look at models constructed from directed systems of models, as follows.

Definition 4.7. Let κ and θ be infinite cardinals, κ uncountable regular, and let T be a directed partial order without maximum. A sequence $\bar{N} := \langle N_t : t \in T \rangle$ of elementary submodels of H_χ is a (T, κ, θ) -directed system if, for all $t \in T$:

- (1) N_t is $<\kappa$ -closed and $|N_t| = \theta$;
- (2) if $t \leq t'$ in T then $N_t \subseteq N_{t'}$;
- (3) $\theta \cup \{\theta, T\} \subseteq N_t$.

In this context, we usually denote $N := \bigcup_{t \in T} N_t$. Clearly $N \leq H_\chi$.

Fact 4.8. *If $\bar{N} := \langle N_t : t \in T \rangle$ is a (T, κ, θ) -directed system then:*

- (a) $\theta^{<\kappa} = \theta$ (so $\kappa \leq \theta$).
- (b) N is $<\min\{\kappa, \mathfrak{b}(T)\}$ -closed.
- (c) $\theta \leq |N| \leq \theta \cdot \mathfrak{d}(T)$.

Proof. To see (c) note that, if $T' \subseteq T$ witnesses $\mathfrak{d}(T)$, then $N = \bigcup_{t \in T'} N_t$. □

In our applications $|T| \leq \theta$, in which case (c) implies $|N| = \theta$.

The remaining results in this section are the main tools to understand $K \cap N$ when N is obtained from a directed system.

Lemma 4.9. *Let $\bar{N} = \langle N_t : t \in T \rangle$ be a (T, κ, θ) -directed system. If $K = \langle A, B, \triangleleft \rangle$ is a relational system, $K \in N$, and*

- (\heartsuit) $A \cap N_t$ is $K \cap N$ -bounded for all $t \in T$,

then $K \cap N \leq_T T$.

Proof. Define $f: A \cap N \rightarrow T$ such that $i \in A \cap N_{f(i)}$ for $i \in A \cap N$, and define $g: T \rightarrow B \cap N$ such that $\forall i \in A \cap N_t: i \triangleleft g(t)$ (by (\heartsuit)). If $f(i) \leq_T t$ then $i \in A \cap N_{f(i)} \subseteq A \cap N_t$, so $i \triangleleft g(t)$. □

Fact 4.10. *In Lemma 4.9, we must have $\mathfrak{b}(K) > \theta$.*

Proof. Since $K \in N$, $\exists t \in T: K \in N_t$, so we can find a witness $F \in N_t$ of $\mathfrak{b}(K)$. If $|F| = \mathfrak{b}(S) \leq \theta$ then $F \subseteq A \cap N_t$ (because $\theta \subseteq N_t$), so $A \cap N_t$ is unbounded, which contradicts (\heartsuit). □

Fact 4.11. *If $\mathfrak{b}(K) > \theta$ and $N_t \in N$ for all $t \in T$, then (\heartsuit) follows.*

Corollary 4.12. *Under the assumptions of Lemma 4.9, if in addition $S = K$ is a directed preorder without maximum and T is a linear order, then $S \cap N \cong_T T$.*

Proof. Consider the functions f and g from the proof of [Lemma 4.9](#). Since S does not have a maximum, we can even define g such that $i <_S g(t)$ for all $i \in S \cap N_t$. Thus, $(g, f): T \rightarrow S \cap N$ is a Tukey connection: if $g(t) \leq_S j$ in $S \cap N$, then $\forall i \in S \cap N_t: i <_S j$, so $j \notin N_t$, hence $t <_T f(j)$. \square

[Figure 19](#) illustrates the situation of [Lemma 4.9](#) when $K = S$ is a directed preorder and $|T| \leq \theta$ (so $|\delta_N| = |N| = \theta$), while [Figure 20](#) illustrates [Corollary 4.12](#).

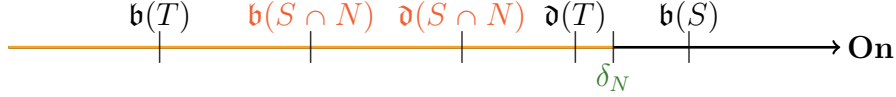

Figure 19: When $K = S$ is a directed preorder and $|T| \leq \theta$, according to [Lemma 4.9](#) $S \cap N \leq_T T$, so the cardinal characteristics associated with $S \cap N$ lie between those associated with T .

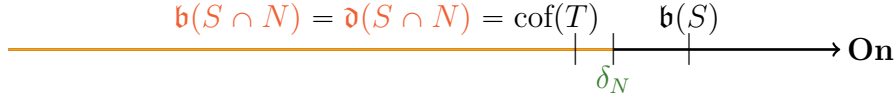

Figure 20: In the situation of [Corollary 4.12](#) (when $|T| \leq \theta$), $S \cap N \cong_T T$, so the cardinal characteristics associated with $S \cap N$ collapse to $\text{cof}(T)$.

We finish with a result about the intersection of a directed system of models with a chain of models.

Lemma 4.13. *Let $\bar{N}^0 = \langle N_t^k : t \in T \rangle$ be a (T, κ^0, θ^0) -directed system, and let $\bar{N}^1 := \langle N_\alpha^1 : \alpha < \lambda \rangle$ be a $(\lambda, \kappa^1, \theta^1)$ -directed system with λ a limit ordinal. Assume:*

- (i) $\bar{N}^0 \in N_0^1$ and $\theta^1 < \kappa^0$ (which implies $\kappa^1 \leq \theta^1 < \kappa^0 \leq \theta^0$),
- (ii) $N_\alpha^1 \in N^1$ for all $\alpha < \lambda$, and
- (iii) $T \subseteq N_0^1$ (which implies $|T| \leq \theta_1$).

Then:

(a) $\bar{N} := \langle N_\eta : \eta \in \Lambda \rangle$ is a $(\Lambda, \kappa^1, \theta^1)$ -directed system, where

- $\Lambda := T \times \lambda$,
- $N_\eta := N_{\eta(0)}^0 \cap N_{\eta(1)}^1$ for $\eta \in \Lambda$. Hence, $N = N^0 \cap N^1$.

(b) If $K = \langle A, B, \triangleleft \rangle \in N^0 \cap N_0^1$ is a relational system and $\mathfrak{b}(K) > \theta^1$ then $K \cap N \leq_T \Lambda$. In particular $\min\{\mathfrak{b}(T), \text{cf}(\lambda)\} \leq \mathfrak{b}(K \cap N)$ and $\mathfrak{d}(K \cap N) \leq \max\{\mathfrak{d}(T), \text{cf}(\lambda)\}$.

Proof. (a): Fix $\eta \in \Lambda$. Note that $N_\eta \leq H_\chi$ because $N_{\eta(0)}^0, N_{\eta(1)}^1 \leq H_\chi$ and $N_{\eta(0)}^0 \in N_{\eta(1)}^1$ by (i) and (iii). On the other hand, since $N_{\eta(0)}^0 \in N_{\eta(1)}^1$ and $|N_{\eta(0)}^0| = \theta^0$, we get

$|N_{\eta(0)}^0 \cap N_{\eta(1)}^1| = |\theta^0 \cap N_{\eta(0)}^1| = \theta^1$. Clearly, N_η is $<\kappa^1$ -closed, so we can easily conclude that \bar{N} is a $(\Lambda, \kappa^1, \theta^1)$ -directed system. Note that $N := \bigcup_{\eta \in \Lambda} N_\eta = N^0 \cap N^1$.

(b): Let $\eta \in \Lambda$, wlog $K \in N_{\eta(0)}^0$ (by increasing $\eta(0)$). Since $\mathfrak{b}(K \cap N_{\eta(0)}^0) \geq \min\{\mathfrak{b}(K), \kappa_0\} > \theta^1$ by [Fact 4.6](#) (b) and (i), and $A \cap N_\eta \in N^1$ (by (ii)) has size $\leq \theta^1$,

$$N^1 \models \exists y \in B \cap N_{\eta(0)}^0 \forall x \in A \cap N_\eta: x \triangleleft y,$$

so we can pick such $y \in B \cap N_{\eta(0)}^0 \cap N^1 \subseteq N$. Hence (\heartsuit) of [Lemma 4.9](#) holds, thus $K \cap N \leq_{\mathbb{T}} \Lambda$. \square

5 Cichoń's maximum

We fix cardinals ordered as in [Figure 21](#), all of them regular with the possible exception of λ^c . Applying [Theorem 3.5](#), we first construct a ccc poset \mathbb{P} forcing $\mathfrak{c} = \theta_\infty$ and the constellation at the top with Tukey connections, namely, $\mathbf{R}_i \cong_{\mathbb{T}} S_i$ for all $1 \leq i \leq 4$, where $S_i := [\theta_\infty]^{<\theta_i} \cap V$ is a directed partial order.

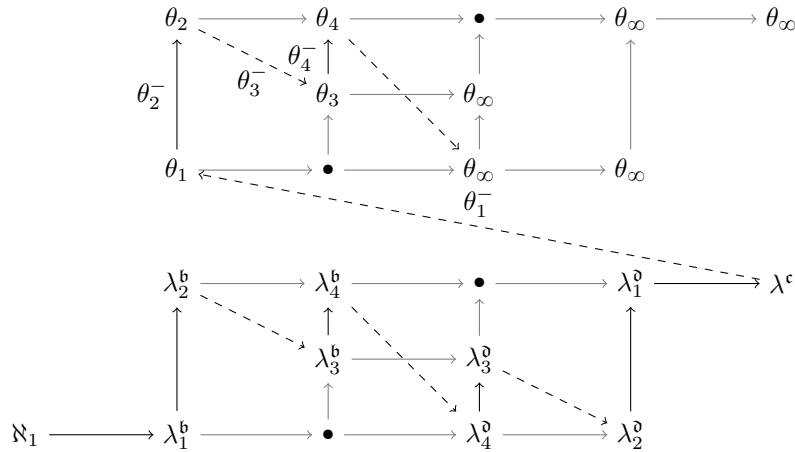

Figure 21: Strategy to force Cichoń's maximum: we construct a ccc poset \mathbb{P} forcing the constellation at the top, and find a σ -closed model N such that $\mathbb{P} \cap N$ forces the constellation at the bottom.

Afterwards, we apply the theory of [Section 4](#) to construct a σ -closed $N \leq H_\chi$, where χ is chosen regular large enough, such that $\mathbb{P} \cap N$ forces the Cichoń's maximum constellation at the bottom. By [Lemma 4.5](#) we obtain that $\mathbb{P} \cap N$ forces $\mathbf{R}_i \cong_{\mathbb{T}} S_i \cap N$, so we need to construct N such that $\mathfrak{b}(S_i \cap N) = \lambda_i^b$ and $\mathfrak{d}(S_i \cap N) = \lambda_i^d$. We will have $|N| = \lambda^c$, so $\mathbb{P} \cap N$ will force that $\mathfrak{c} = \lambda^c$.

The strategy is to construct several chains of elementary submodels of H_χ and intersect them. To proceed, we fix the following assumptions and conventions:

(H1) Cardinals ordered as in [Figure 21](#), non-decreasing up to λ^c and increasing from there.

(H2) With the possible exception of λ^c , all cardinals are regular. But we assume $(\lambda^c)^{\aleph_0} = \lambda^c$.

(H3) The cardinals θ_i ($1 \leq i \leq 4$) and θ_∞ satisfy the hypothesis of [Theorem 3.5](#).

(H4) For every $1 \leq i \leq 4$, $\theta_i^{\theta_i^-} = \theta_i$ and $(\theta_i^-)^{<\theta_i^-} = \theta_i^-$.

(H5) All models from now on contain as elements all the cardinals in [\(H1\)](#).

(H6) Every new model contains, as elements, all the chains of models previously defined.

More concretely, we prove:

Theorem 5.1. *Under assumptions [\(H1\)](#)–[\(H4\)](#), there is a ccc poset forcing, for $1 \leq i \leq 4$:*

- (a) $\mathbf{R}_i \leq_{\mathbf{T}} \prod_{j=i}^4 \lambda_j^{\mathfrak{d}} \times \lambda_j^{\mathfrak{b}}$,
- (b) $\lambda_j^{\mathfrak{b}} \leq_{\mathbf{T}} \mathbf{R}_i$ and $\lambda_j^{\mathfrak{d}} \leq_{\mathbf{T}} \mathbf{R}_i$ when $i \leq j \leq 4$, and
- (c) $\mathfrak{c} = \lambda^c$.

We present two proofs. The first one is a short compact proof, and the second is the argument step by step, showing how cardinal characteristics are modified.

Proof (compact version). By [\(H3\)](#), find a ccc poset \mathbb{P} as in [Theorem 3.5](#), i.e. forcing $\mathfrak{c} = \theta_\infty$ and $\mathbb{R}_i \cong_{\mathbf{T}} S_i$ for all $1 \leq i \leq 4$. On the other hand, we have Tukey relations of regular cardinals with S_i and the values of its associated cardinal characteristics as in [Table 1](#).

i	(regular) $\theta \leq_{\mathbf{T}} S_i$	$\mathfrak{b}(S_i)$	$\mathfrak{d}(S_i)$
4	$[\theta_4, \theta_\infty]$	θ_4	θ_∞
3	$[\theta_3, \theta_\infty]$	θ_3	θ_∞
2	$[\theta_2, \theta_\infty]$	θ_2	θ_∞
1	$[\theta_1, \theta_\infty]$	θ_1	θ_∞

Table 1: Values of the cardinal characteristics of S_i and Tukey connections from regular cardinals (consequence of [Fact 1.14](#)).

By downwards recursion on $1 \leq i \leq 4$, we construct chains of models $\bar{N}_i^{\mathfrak{d}} := \langle N_{i,\alpha}^{\mathfrak{d}} : \alpha < \lambda_i^{\mathfrak{d}} \rangle$ and $\bar{N}_i^{\mathfrak{b}} := \langle N_{i,\alpha}^{\mathfrak{b}} : \alpha < \lambda_i^{\mathfrak{b}} \rangle$ satisfying:

- (i) $\bar{N}_i^{\mathfrak{d}}$ is a $(\lambda_i^{\mathfrak{d}}, (\theta_i^-)^+, \theta_i)$ -directed system;
- (ii) $\bar{N}_i^{\mathfrak{b}}$ is a $(\lambda_i^{\mathfrak{b}}, \theta_i^-, \theta_i^-)$ -directed system;
- (iii) each $N_{i,\alpha}^{\mathfrak{d}}$ contains, as elements: the cardinals of [Figure 21](#), \mathbb{P} , $\langle N_{i,\xi}^{\mathfrak{d}} : \xi < \alpha \rangle$, and the sequences $\bar{N}_j^{\mathfrak{d}}$ and $\bar{N}_j^{\mathfrak{b}}$ for all $i < j \leq 4$;
- (iv) each $N_{i,\alpha}^{\mathfrak{b}}$ contains, as elements: the cardinals of [Figure 21](#), \mathbb{P} , $\langle N_{i,\xi}^{\mathfrak{b}} : \xi < \alpha \rangle$, and the sequences $\bar{N}_i^{\mathfrak{d}}$, $\bar{N}_j^{\mathfrak{d}}$ and $\bar{N}_j^{\mathfrak{b}}$ for all $i < j \leq 4$.

Assumptions (H2) and (H4) are what allow the construction of the models. Note that (iii) and (iv) obey (H5) and (H6), and these imply that the models contain, as elements, S_i and the parameters of the definition of \mathbf{R}_i for all $1 \leq i \leq 4$.

Finally, let $N^c \leq H_\chi$ be a σ -closed model of size λ^c containing, as elements, everything we have so far (this is possible because $(\lambda^c)^{\aleph_0} = \lambda^c$, see (H2)). We let $N := N^c \cap \bigcap_{j=1}^4 N_j^\partial \cap N_j^b$, and show that $\mathbb{P} \cap N$ is as desired. To show (a) and (b), note that $\mathbb{P} \cap N$ forces $\mathbf{R}_i \cong_{\mathbb{T}} S_i \cap N$ for all $1 \leq i \leq 4$, hence it is enough to show that

$$(a') \quad S_i \cap N \leq_{\mathbb{T}} \Lambda_i := \prod_{j=i}^4 \lambda_j^\partial \times \lambda_j^b, \text{ and}$$

$$(b') \quad \lambda_j^b \leq_{\mathbb{T}} S_i \cap N \text{ and } \lambda_j^\partial \leq_{\mathbb{T}} S_i \cap N \text{ when } i \leq j \leq 4.$$

Item (c) follows because $|\mathbb{P} \cap N| = \lambda^c$.

(a'): Let $\Lambda'_i := \lambda_i^\partial \times \prod_{j=i+1}^4 \lambda_j^\partial \times \lambda_j^b$ (when $i = 4$, just let $\Lambda'_4 := \lambda_4^\partial$), which is a relational system. As in the proof of Lemma 4.13 (a), the intersection of the chain of models \bar{N}_i^∂ with \bar{N}_j^∂ and \bar{N}_j^b for all $i < j \leq 4$ yields a $(\Lambda'_i, (\theta_i^-)^+, \theta_i)$ directed system \bar{N}'_i . Since $\mathfrak{b}(S_i) = \theta_i > \theta_i^-$, by Lemma 4.13 applied to $\bar{N}^0 = \bar{N}'_i$ and $\bar{N}^1 = \bar{N}_i^b$, we obtain a $(\Lambda_i, \theta_i^-, \theta_i^-)$ -directed system \bar{N}_i such that $S_i \cap N_i \leq_{\mathbb{T}} \Lambda_i$ where $N_i = \bigcap_{j=i}^4 N_i^\partial \cap N_i^b$.

Now, by regressive induction on $1 \leq j < i$, we show that $S_i \cap N_j \cong_{\mathbb{T}} S_i \cap N_i$. Assume we have the result for $j+1$ (which we showed for $j+1 = i$). Since $\mathfrak{d}(S_i \cap N_{j+1}) \leq \mathfrak{d}(\Lambda_i) = \lambda_i^\partial \subseteq N_j^\partial$, by Fact 4.6 (d) we obtain $S_i \cap N_{j+1} \cap N_j^\partial \cong_{\mathbb{T}} S_i \cap N_{j+1} \cong_{\mathbb{T}} S_i \cap N_i$. For the same reason, we get $S_i \cap N_j = S_i \cap N_{j+1} \cap N_j^\partial \cap N_j^b \cong_{\mathbb{T}} S_i \cap N_{j+1} \cap N_j^\partial \cong_{\mathbb{T}} S_i \cap N_i$.

Finally, by applying Fact 4.6 (d), we conclude $S_i \cap N = S_i \cap N_1 \cap N^c \cong_{\mathbb{T}} S_i \cap N_1 \cong_{\mathbb{T}} S_i \cap N_i \leq_{\mathbb{T}} \Lambda_i$.

(b'): For $1 \leq j \leq 4$ we consider \bar{N}'_j and \bar{N}_j as defined in the previous argument. Fix $i \leq j \leq 4$. We have that $\theta_j \leq_{\mathbb{T}} S_i$ and $\theta_{j+1}^- \leq_{\mathbb{T}} S_i$ (denote $\theta_5^- := \theta_\infty$), which imply $\theta_j \cap N \leq_{\mathbb{T}} S_i \cap N$ and $\theta_{j+1}^- \cap N \leq_{\mathbb{T}} S_i \cap N$. So it is enough to show that $\theta_j \cap N \cong_{\mathbb{T}} \lambda_i^b$ and $\theta_{j+1}^- \cap N \cong_{\mathbb{T}} \lambda_j^\partial$.

Since $\theta_\infty > \theta_4 = |N_4^\partial|$, by Corollary 4.12 applied to \bar{N}_4^∂ we get $\theta_\infty \cap N_4^\partial \cong_{\mathbb{T}} \lambda_4^\partial$, showing $\theta_{j+1}^- \cap N_j^\partial \cong_{\mathbb{T}} \lambda_j^\partial$ for $j = 4$; in the case $j < 4$, since $\theta_{j+1}^- = |N_{j+1}^\partial|$, we get $\theta_{j+1}^- \cap N_{j+1} \cong_{\mathbb{T}} \theta_{j+1}^-$ by Fact 4.6 (d) (even equality holds), but $|N_j^\partial| = \theta_j < \theta_{j+1}^-$, so Corollary 4.12 applied to \bar{N}_j^∂ implies $\theta_{j+1}^- \cap N_j^\partial \cong_{\mathbb{T}} \lambda_j^\partial$.

Back to $j \leq 4$: since $\theta_j = |N'_j|$ we have $\theta_j \cap N'_j \cong_{\mathbb{T}} \theta_j$ by Fact 4.6 (d) (even equality holds). Now $\theta_j > \theta_j^- = |N_j^b|$, so by Corollary 4.12 applied to \bar{N}_j^b we obtain $\theta_j \cap N_j \cong_{\mathbb{T}} \lambda_j^b$. On the other hand, $\theta_{j+1}^- \cap N_j \cong_{\mathbb{T}} \theta_{j+1}^- \cap N'_j \cong_{\mathbb{T}} \lambda_j^\partial$ by Fact 4.6 (d). Now, using Fact 4.6 (d), it is easy to show by decreasing recursion on $1 \leq k < j$ that $\theta_j \cap N_k \cong_{\mathbb{T}} \lambda_j^b$ and $\theta_{j+1}^- \cap N_k \cong_{\mathbb{T}} \lambda_j^\partial$. For the same reason, $\theta_j \cap N = \theta_j \cap N_1 \cap N^c \cong_{\mathbb{T}} \theta_j \cap N_1 \cong_{\mathbb{T}} \lambda_j^b$ and $\theta_{j+1}^- \cap N \cong_{\mathbb{T}} \lambda_j^\partial$. \square

We now explain what occurs step by step when intersecting with the chain of models in the previous proof. By Theorem 3.5 we obtain a ccc poset \mathbb{P} that forces $\mathbb{R}_i \cong_{\mathbb{T}} S_i$ for all $1 \leq i \leq 4$. Recall Table 1 about the values obtained for S_i .

Step 1.1. Construct a $(\lambda_4^\partial, (\theta_4^-)^+, \theta_4)$ -directed system $\bar{N}_4^\partial := \langle N_{4,\alpha}^\partial : \alpha < \lambda_4^\partial \rangle$ such that $N_{4,\alpha}^\partial \in N_{4,\alpha+1}^\partial$ (using $\theta_4^{\theta_4^-} = \theta_4$). Thus N_4^∂ is $<\lambda_4^\partial$ -closed and $\mathbb{P}_4^\partial := \mathbb{P} \cap N_4^\partial$ forces

$\mathbf{R}_i \cong_{\mathbf{T}} S_i^{4,\mathfrak{d}} := S_4 \cap N_4^{\mathfrak{d}}$ (by [Lemma 4.5](#)). So the values forced to $\mathfrak{b}(\mathbf{R}_i)$ and $\mathfrak{d}(\mathbf{R}_i)$ are according to [Table 2](#).

i	(regular) $\theta \leq_{\mathbf{T}} S_i^{4,\mathfrak{d}}$	$\mathfrak{b}(S_i^{4,\mathfrak{d}})$	$\mathfrak{d}(S_i^{4,\mathfrak{d}})$
4	$\theta_4, \lambda_4^{\mathfrak{d}}$	$\lambda_4^{\mathfrak{d}}$	θ_4
3	$[\theta_3, \theta_4], \lambda_4^{\mathfrak{d}}$	$\lambda_4^{\mathfrak{d}}$	θ_4
2	$[\theta_2, \theta_4], \lambda_4^{\mathfrak{d}}$	$\lambda_4^{\mathfrak{d}}$	θ_4
1	$[\theta_1, \theta_4], \lambda_4^{\mathfrak{d}}$	$\lambda_4^{\mathfrak{d}}$	θ_4

Table 2: Values of the cardinal characteristics of $S_i^{4,\mathfrak{d}}$ and Tukey connections from regular cardinals.

To prove the values in [Table 2](#), by [Fact 4.6](#) (b) note that $\mathfrak{b}(S_i^{4,\mathfrak{d}}) \geq \min\{\mathfrak{b}(S_i), \lambda_4^{\mathfrak{d}}\} = \lambda_4^{\mathfrak{d}}$. On the other hand, since $\theta_{\infty} > \theta_4$, by [Corollary 4.12](#) we obtain $\theta_{\infty} \cap N_4^{\mathfrak{d}} \cong_{\mathbf{T}} \lambda_4^{\mathfrak{d}}$, so $\theta_{\infty} \leq_{\mathbf{T}} S_i$ implies $\lambda_4^{\mathfrak{d}} \cong_{\mathbf{T}} \theta_{\infty} \cap N_4^{\mathfrak{d}} \leq_{\mathbf{T}} S_i^{4,\mathfrak{d}}$. Therefore, $\mathfrak{b}(S_i^{4,\mathfrak{d}}) = \lambda_4^{\mathfrak{d}}$.

By [Fact 4.6](#) (d), for any regular $\theta \leq \theta_4 = |N_4^{\mathfrak{d}}|$, we obtain $\theta \cap N_4^{\mathfrak{d}} \cong_{\mathbf{T}} \theta$, so $\theta \leq_{\mathbf{T}} S_i$ implies $\theta \leq_{\mathbf{T}} S_i \cap N_4^{\mathfrak{d}} = S_i^{4,\mathfrak{d}}$. In particular, for $\theta = \theta_4$, we obtain $\theta_4 \leq \mathfrak{d}(S_i^{4,\mathfrak{d}})$. The converse inequality holds by [Fact 4.6](#) (a) as $\mathfrak{d}(S_i \cap N_4^{\mathfrak{d}}) \leq |\mathfrak{d}(S_i) \cap N_4^{\mathfrak{d}}| = \theta_4$.

Step 1.2. Construct a $(\lambda_4^{\mathfrak{b}}, \theta_4^-, \theta_4^-)$ -directed system $\bar{N}_4^{\mathfrak{b}} := \langle N_{4,\alpha}^{\mathfrak{b}} : \alpha < \lambda_4^{\mathfrak{b}} \rangle$ such that $N_{4,\alpha}^{\mathfrak{b}} \in N_{4,\alpha+1}^{\mathfrak{b}}$ (using $(\theta_4^-)^{<\theta_4^-} = \theta_4^-$). Thus, $N_4^{\mathfrak{b}}$ is $<\lambda_4^{\mathfrak{b}}$ -closed and $\mathbb{P}_4^{\mathfrak{b}} := \mathbb{P}_4^{\mathfrak{d}} \cap N_4^{\mathfrak{b}}$ forces $\mathbf{R}_i \cong_{\mathbf{T}} S_i^{4,\mathfrak{b}} := S_i^{4,\mathfrak{d}} \cap N_4^{\mathfrak{b}}$. The values of the cardinals of $S_i^{4,\mathfrak{b}}$ are displayed in [Table 3](#).

i	(regular) $\theta \leq_{\mathbf{T}} S_i^{4,\mathfrak{b}}$	$\mathfrak{b}(S_i^{4,\mathfrak{b}})$	$\mathfrak{d}(S_i^{4,\mathfrak{b}})$
4	$\lambda_4^{\mathfrak{b}}, \lambda_4^{\mathfrak{d}}$	$\lambda_4^{\mathfrak{b}}$	$\lambda_4^{\mathfrak{d}}$
3	$[\theta_3, \theta_4^-], \lambda_4^{\mathfrak{b}}, \lambda_4^{\mathfrak{d}}$	$\lambda_4^{\mathfrak{b}}$	θ_4^-
2	$[\theta_2, \theta_4^-], \lambda_4^{\mathfrak{b}}, \lambda_4^{\mathfrak{d}}$	$\lambda_4^{\mathfrak{b}}$	θ_4^-
1	$[\theta_1, \theta_4^-], \lambda_4^{\mathfrak{b}}, \lambda_4^{\mathfrak{d}}$	$\lambda_4^{\mathfrak{b}}$	θ_4^-

Table 3: Values of the cardinal characteristics of $S_i^{4,\mathfrak{b}}$ and Tukey connections from regular cardinals.

Note that $\mathfrak{b}(S_i^{4,\mathfrak{b}}) \geq \min\{\mathfrak{b}(S_i^{4,\mathfrak{d}}), \lambda_4^{\mathfrak{b}}\} = \lambda_4^{\mathfrak{b}}$ by [Fact 4.6](#) (b). On the other hand, since $\theta_4 > \theta_4^-$, by [Corollary 4.12](#) we obtain $\theta_4 \cap N_4^{\mathfrak{b}} \cong_{\mathbf{T}} \lambda_4^{\mathfrak{b}}$, so $\theta_4 \leq_{\mathbf{T}} S_i^{4,\mathfrak{d}}$ implies $\lambda_4^{\mathfrak{b}} \cong_{\mathbf{T}} \theta_4 \cap N_4^{\mathfrak{b}} \leq_{\mathbf{T}} S_i^{4,\mathfrak{b}}$. Therefore, $\mathfrak{b}(S_i^{4,\mathfrak{b}}) = \lambda_4^{\mathfrak{b}}$.

By [Fact 4.6](#) (d), for any regular $\theta \leq \theta_4^- = |N_4^{\mathfrak{b}}|$, we obtain $\theta \cap N_4^{\mathfrak{b}} \cong_{\mathbf{T}} \theta$, so $\theta \leq_{\mathbf{T}} S_i^{4,\mathfrak{d}}$ implies $\theta \leq_{\mathbf{T}} S_i^{4,\mathfrak{d}} \cap N_4^{\mathfrak{b}} = S_i^{4,\mathfrak{b}}$. In particular, for $\theta = \lambda_4^{\mathfrak{d}}$ we obtain $\lambda_4^{\mathfrak{d}} \leq \mathfrak{d}(S_i^{4,\mathfrak{b}})$, and for $i \leq 3$ and $\theta = \theta_4^-$, we obtain $\theta_4^- \leq \mathfrak{d}(S_i^{4,\mathfrak{b}})$. The converse inequality holds by [Fact 4.6](#) (a) as $\mathfrak{d}(S_i^{4,\mathfrak{d}} \cap N_4^{\mathfrak{b}}) \leq |\mathfrak{d}(S_i^{4,\mathfrak{d}}) \cap N_4^{\mathfrak{b}}| = \theta_4^-$.

It remains to show that $\mathfrak{d}(S_4^{4,\mathfrak{d}}) \leq \lambda_4^{\mathfrak{d}}$. Note that the hypothesis of [Lemma 4.13](#) holds for $\bar{N}^0 = \bar{N}_4^{\mathfrak{d}}$ and $\bar{N}^1 = \bar{N}_4^{\mathfrak{b}}$, so, since $\mathfrak{b}(S_4) = \theta_4 > \theta_4^-$, we conclude that $S_4^{\mathfrak{b}} = S_4 \cap N_4^{\mathfrak{d}} \cap N_4^{\mathfrak{b}} \leq_{\mathbf{T}} \lambda_4^{\mathfrak{d}} \times \lambda_4^{\mathfrak{b}}$. Therefore $\lambda_4^{\mathfrak{b}} \leq \mathfrak{b}(S_4^{\mathfrak{b}}) \leq \mathfrak{d}(S_4^{\mathfrak{b}}) \leq \lambda_4^{\mathfrak{d}}$.

Step 2.1. Construct a $(\lambda_3^{\mathfrak{d}}, (\theta_3^-)^+, \theta_3)$ -directed system $\bar{N}_3^{\mathfrak{d}} := \langle N_{3,\alpha}^{\mathfrak{d}} : \alpha < \lambda_3^{\mathfrak{d}} \rangle$ such that

$N_{3,\alpha}^\partial \in N_{3,\alpha+1}^\partial$ (using $\theta_3^{\theta_3^-} = \theta_3$). Thus N_3^∂ is $<\lambda_3^\partial$ -closed and $\mathbb{P}_3^\partial := \mathbb{P}_4^b \cap N_3^\partial$ forces $\mathbf{R}_i \cong_{\mathbb{T}} S_i^{3,\partial} := S_i^{4,b} \cap N_3^\partial$. The values of the cardinals of $S_i^{3,\partial}$ are displayed in [Table 4](#).

i	(regular) $\theta \leq_{\mathbb{T}} S_i^{3,\partial}$	$\mathfrak{b}(S_i^{3,\partial})$	$\mathfrak{d}(S_i^{3,\partial})$
4	$\lambda_4^b, \lambda_4^\partial$	λ_4^b	λ_4^∂
3	$\theta_3, \lambda_4^b, \lambda_4^\partial, \lambda_3^\partial$	λ_4^b	θ_3
2	$[\theta_2, \theta_3], \lambda_4^b, \lambda_4^\partial, \lambda_3^\partial$	λ_4^b	θ_3
1	$[\theta_1, \theta_3], \lambda_4^b, \lambda_4^\partial, \lambda_3^\partial$	λ_4^b	θ_3

Table 4: Values of the cardinal characteristics of $S_i^{3,\partial}$ and Tukey connections from regular cardinals.

The values for $1 \leq i \leq 3$ are calculated similarly to Steps 1.1 and 1.2, so we only explain the values for $i = 4$. Since $\mathfrak{d}(S_4^{4,b}) = \lambda_4^\partial < \theta_3 = |N_3^\partial|$, by [Fact 4.6](#) (d) we obtain $S_4^{3,\partial} \cong_{\mathbb{T}} S_4^{4,b}$, so the values of the cardinal characteristics stay the same.

Step 2.2. Construct a $(\lambda_3^b, \theta_3^-, \theta_3^-)$ -directed system $\bar{N}_3^b := \langle N_{3,\alpha}^b : \alpha < \lambda_3^b \rangle$ such that $N_{3,\alpha}^b \in N_{3,\alpha+1}^b$ (using $(\theta_3^-)^{<\theta_3^-} = \theta_3^-$). Thus N_3^b is $<\lambda_3^b$ -closed and $\mathbb{P}_3^b := \mathbb{P}_3^\partial \cap N_3^b$ forces $\mathbf{R}_i \cong_{\mathbb{T}} S_i^{3,b} := S_i^{3,\partial} \cap N_3^b$. The values of the cardinals of $S_i^{3,b}$ are displayed in [Table 5](#).

i	(regular) $\theta \leq_{\mathbb{T}} S_i^{3,b}$	$\mathfrak{b}(S_i^{3,b})$	$\mathfrak{d}(S_i^{3,b})$
4	$\lambda_4^b, \lambda_4^\partial$	λ_4^b	λ_4^∂
3	$\lambda_3^b, \lambda_4^b, \lambda_4^\partial, \lambda_3^\partial$	λ_3^b	λ_3^∂
2	$[\theta_2, \theta_3^-], \lambda_3^b, \lambda_4^b, \lambda_4^\partial, \lambda_3^\partial$	λ_3^b	θ_3^-
1	$[\theta_1, \theta_3^-], \lambda_3^b, \lambda_4^b, \lambda_4^\partial, \lambda_3^\partial$	λ_3^b	θ_3^-

Table 5: Values of the cardinal characteristics of $S_i^{3,b}$ and Tukey connections from regular cardinals.

This is similar to Steps 1.2 and 2.1, but $\mathfrak{d}(S_3^{3,b}) \leq \lambda_3^\partial$ needs more details. As in the proof of [Lemma 4.13](#), $N_4^\partial \cap N_4^b \cap N_3^\partial$ is obtained by a $(\lambda_3^\partial \times \lambda_4^b \times \lambda_4^\partial, (\theta_3^-)^+, \theta_3^-)$ -directed system \bar{N}'_3 . So we apply [Lemma 4.13](#) to $\bar{N}^0 = \bar{N}'_3$ and $\bar{N}^1 = \bar{N}_3^b$ to obtain $S_3^{3,b} \leq_{\mathbb{T}} \prod_{j=3}^4 \lambda_j^\partial \times \lambda_j^b$.

We proceed in the same fashion for the remaining steps.

Step 3.1 Construct a $(\lambda_2^\partial, (\theta_2^-)^+, \theta_2^-)$ -directed system $\bar{N}_2^\partial := \langle N_{2,\alpha}^\partial : \alpha < \lambda_2^\partial \rangle$ such that $N_{2,\alpha}^\partial \in N_{2,\alpha+1}^\partial$ (using $\theta_2^{\theta_2^-} = \theta_2$). Thus N_2^∂ is $<\lambda_2^\partial$ -closed and $\mathbb{P}_2^\partial := \mathbb{P}_3^b \cap N_2^\partial$ forces $\mathbf{R}_i \cong_{\mathbb{T}} S_i^{2,\partial} := S_i^{3,b} \cap N_2^\partial$. The values of the cardinals of $S_i^{2,\partial}$ are displayed in [Table 6](#).

Step 3.2. Construct a $(\lambda_2^b, \theta_2^-, \theta_2^-)$ -directed system $\bar{N}_2^b := \langle N_{2,\alpha}^b : \alpha < \lambda_2^b \rangle$ such that $N_{2,\alpha}^b \in N_{2,\alpha+1}^b$ (using $(\theta_2^-)^{<\theta_2^-} = \theta_2^-$). Thus N_2^b is $<\lambda_2^b$ -closed and $\mathbb{P}_2^b := \mathbb{P}_2^\partial \cap N_2^b$ forces $\mathbf{R}_i \cong_{\mathbb{T}} S_i^{2,b} := S_i^{2,\partial} \cap N_2^b$. The values of the cardinals of $S_i^{2,b}$ are displayed in [Table 7](#), in particular, we obtain $S_2^{2,b} \leq_{\mathbb{T}} \prod_{j=2}^4 \lambda_j^\partial \times \lambda_j^b$.

i	(regular) $\theta \leq_T S_i^{2,\mathfrak{d}}$	$\mathfrak{b}(S_i^{2,\mathfrak{d}})$	$\mathfrak{d}(S_i^{2,\mathfrak{d}})$
4	$\lambda_4^b, \lambda_4^{\mathfrak{d}}$	λ_4^b	$\lambda_4^{\mathfrak{d}}$
3	$\lambda_3^b, \lambda_4^b, \lambda_4^{\mathfrak{d}}, \lambda_3^{\mathfrak{d}}$	λ_3^b	$\lambda_3^{\mathfrak{d}}$
2	$\theta_2, \lambda_3^b, \lambda_4^b, \lambda_4^{\mathfrak{d}}, \lambda_3^{\mathfrak{d}}, \lambda_2^{\mathfrak{d}}$	λ_3^b	θ_2
1	$[\theta_1, \theta_2], \lambda_3^b, \lambda_4^b, \lambda_4^{\mathfrak{d}}, \lambda_3^{\mathfrak{d}}, \lambda_2^{\mathfrak{d}}$	λ_3^b	θ_2

Table 6: Values of the cardinal characteristics of $S_i^{2,\mathfrak{d}}$ and Tukey connections from regular cardinals.

i	(regular) $\theta \leq_T \mathbf{R}_i$	$\mathfrak{b}(S_i^{2,\mathfrak{b}})$	$\mathfrak{d}(S_i^{2,\mathfrak{b}})$
4	$\lambda_4^b, \lambda_4^{\mathfrak{d}}$	λ_4^b	$\lambda_4^{\mathfrak{d}}$
3	$\lambda_3^b, \lambda_4^b, \lambda_4^{\mathfrak{d}}, \lambda_3^{\mathfrak{d}}$	λ_3^b	$\lambda_3^{\mathfrak{d}}$
2	$\lambda_2^b, \lambda_3^b, \lambda_4^b, \lambda_4^{\mathfrak{d}}, \lambda_3^{\mathfrak{d}}, \lambda_2^{\mathfrak{d}}$	λ_2^b	$\lambda_2^{\mathfrak{d}}$
1	$[\theta_1, \theta_2^-], \lambda_2^b, \lambda_3^b, \lambda_4^b, \lambda_4^{\mathfrak{d}}, \lambda_3^{\mathfrak{d}}, \lambda_2^{\mathfrak{d}}$	λ_2^b	θ_2^-

Table 7: Values of the cardinal characteristics of $S_i^{2,\mathfrak{b}}$ and Tukey connections from regular cardinals.

Step 4.1. Construct a $(\lambda_1^{\mathfrak{d}}, (\theta_1^-)^+, \theta_1)$ -directed system $\bar{N}_1^{\mathfrak{d}} := \langle N_{1,\alpha}^{\mathfrak{d}} : \alpha < \lambda_1^{\mathfrak{d}} \rangle$ such that $N_{1,\alpha}^{\mathfrak{d}} \in N_{1,\alpha+1}^{\mathfrak{d}}$ (using $\theta_1^{\theta_1^-} = \theta_1$). Thus $N_1^{\mathfrak{d}}$ is $<\lambda_1^{\mathfrak{d}}$ -closed and $\mathbb{P}_1^{\mathfrak{d}} := \mathbb{P}_2^{\mathfrak{d}} \cap N_1^{\mathfrak{d}}$ forces $\mathbf{R}_i \cong_T S_i^{1,\mathfrak{d}} := S_i^{2,\mathfrak{b}} \cap N_1^{\mathfrak{d}}$. The values of the cardinals of $S_i^{1,\mathfrak{d}}$ are displayed in Table 8.

i	(regular) $\theta \leq_T \mathbf{R}_i$	$\mathfrak{b}(S_i^{1,\mathfrak{d}})$	$\mathfrak{d}(S_i^{1,\mathfrak{d}})$
4	$\lambda_4^b, \lambda_4^{\mathfrak{d}}$	λ_4^b	$\lambda_4^{\mathfrak{d}}$
3	$\lambda_3^b, \lambda_4^b, \lambda_4^{\mathfrak{d}}, \lambda_3^{\mathfrak{d}}$	λ_3^b	$\lambda_3^{\mathfrak{d}}$
2	$\lambda_2^b, \lambda_3^b, \lambda_4^b, \lambda_4^{\mathfrak{d}}, \lambda_3^{\mathfrak{d}}, \lambda_2^{\mathfrak{d}}$	λ_2^b	$\lambda_2^{\mathfrak{d}}$
1	$\theta_1, \lambda_2^b, \lambda_3^b, \lambda_4^b, \lambda_4^{\mathfrak{d}}, \lambda_3^{\mathfrak{d}}, \lambda_2^{\mathfrak{d}}, \lambda_1^{\mathfrak{d}}$	λ_2^b	θ_1

Table 8: Values of the cardinal characteristics of $S_i^{1,\mathfrak{d}}$ and Tukey connections from regular cardinals.

Step 4.2 Construct a $(\lambda_1^{\mathfrak{b}}, \theta_1^-, \theta_1^-)$ -directed system $\bar{N}_1^{\mathfrak{b}} := \langle N_{1,\alpha}^{\mathfrak{b}} : \alpha < \lambda_1^{\mathfrak{b}} \rangle$ such that $N_{1,\alpha}^{\mathfrak{b}} \in N_{1,\alpha+1}^{\mathfrak{b}}$ (using $(\theta_1^-)^{\theta_1^-} = \theta_1^-$). Thus $N_1^{\mathfrak{b}}$ is $<\lambda_1^{\mathfrak{b}}$ -closed and $\mathbb{P}_1^{\mathfrak{b}} := \mathbb{P}_1^{\mathfrak{d}} \cap N_1^{\mathfrak{b}}$ forces $\mathbf{R}_i \cong_T S_i^{1,\mathfrak{b}} := S_i^{1,\mathfrak{d}} \cap N_1^{\mathfrak{b}}$. The values of the cardinals of $S_i^{1,\mathfrak{b}}$ are displayed in Table 9, in particular, we obtain $S_1^{1,\mathfrak{b}} \leq_T \prod_{j=1}^4 \lambda_j^{\mathfrak{d}} \times \lambda_j^{\mathfrak{b}}$.

Final step. Let $N^{\mathfrak{c}} \leq H_{\chi}$ be σ -closed such that $|N^{\mathfrak{c}}| = \lambda^{\mathfrak{c}} \subseteq N^{\mathfrak{c}}$ (using $(\lambda^{\mathfrak{c}})^{\aleph_0} = \lambda^{\mathfrak{c}}$). Then $\mathbb{Q} := \mathbb{P}_1^{\mathfrak{b}} \cap N^{\mathfrak{c}}$ forces $\mathbf{R}_i \cong_T S_i^{\mathfrak{c}} := S_i^{1,\mathfrak{b}} \cap N^{\mathfrak{c}}$ and $\mathfrak{c} = \lambda^{\mathfrak{c}}$. By Fact 4.6 (d), the values in Table 9 are still valid for $S_i^{\mathfrak{c}}$. Then $N := N^{\mathfrak{c}} \cap \bigcap_{j=1}^4 N_j^{\mathfrak{d}} \cap N_j^{\mathfrak{b}}$ is as desired, and $\mathbb{Q} = \mathbb{P} \cap N$.

i	(regular) $\theta \leq_{\mathbb{T}} \mathbf{R}_i$	$\mathfrak{b}(S_i^{1,\mathfrak{b}})$	$\mathfrak{d}(S_i^{1,\mathfrak{b}})$
4	$\lambda_4^{\mathfrak{b}}, \lambda_4^{\mathfrak{d}}$	$\lambda_4^{\mathfrak{b}}$	$\lambda_4^{\mathfrak{d}}$
3	$\lambda_3^{\mathfrak{b}}, \lambda_4^{\mathfrak{b}}, \lambda_4^{\mathfrak{d}}, \lambda_3^{\mathfrak{d}}$	$\lambda_3^{\mathfrak{b}}$	$\lambda_3^{\mathfrak{d}}$
2	$\lambda_2^{\mathfrak{b}}, \lambda_3^{\mathfrak{b}}, \lambda_4^{\mathfrak{b}}, \lambda_4^{\mathfrak{d}}, \lambda_3^{\mathfrak{d}}, \lambda_2^{\mathfrak{d}}$	$\lambda_2^{\mathfrak{b}}$	$\lambda_2^{\mathfrak{d}}$
1	$\lambda_1^{\mathfrak{b}}, \lambda_2^{\mathfrak{b}}, \lambda_3^{\mathfrak{b}}, \lambda_4^{\mathfrak{b}}, \lambda_4^{\mathfrak{d}}, \lambda_3^{\mathfrak{d}}, \lambda_2^{\mathfrak{d}}, \lambda_1^{\mathfrak{d}}$	$\lambda_1^{\mathfrak{b}}$	$\lambda_1^{\mathfrak{d}}$

Table 9: Values of the cardinal characteristics of $S_i^{1,\mathfrak{b}}$ and Tukey connections from regular cardinals.

6 Discussion

In our Cichoń’s maximum result we get Tukey connections with products of ordinals, but it is unclear whether we actually have Tukey equivalence.

Question 6.1. *Can we force Tukey equivalence in [Theorem 5.1](#) (a)?*

Similarly, in [Theorem 3.7](#) (b), it is unclear whether we can force $\mathbf{R}_4 \cong_{\mathbb{T}} \lambda_5 \times \lambda_4$.

Recall that, in [Corollary 2.7](#), we showed that the method of FS iterations restrict us to constellations of Cichoń’s diagram where $\text{non}(\mathcal{M}) \leq \text{cov}(\mathcal{M})$. There are four instances of Cichoń’s maximum under this condition: the one proved in [Theorem 5.1](#), the one in [Figure 22](#) (after applying the same arguments in [Section 5](#) to the forcing from [Theorem 3.6](#)), and the two addressed in the following open question.

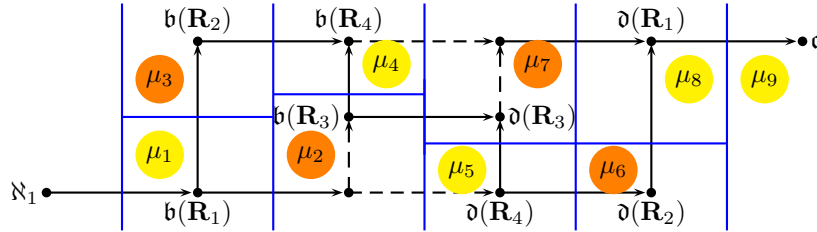

Figure 22: Another instance of Cichoń’s maximum proved consistent with ZFC. Here $\mu_i < \mu_j$ whenever $i < j$.

Question 6.2. *When $\mu_i < \mu_j$ for $i < j$, are the constellations of [Figure 23](#) consistent with ZFC?*

On the other hand, no instance of Cichoń’s maximum with $\text{cov}(\mathcal{M}) < \text{non}(\mathcal{M})$ has been proved consistent so far.

We finish with some remarks about forcing singular values in Cichoń’s diagram. In the models presented in this paper only \mathfrak{c} can be singular, but there are some models with two singular values [[Mej19](#)]. There are also some instances of Cichoń’s maximum with two singular values, but their consistency use large cardinals [[GKMS22](#)]. The latter reference also presents interesting constellations in the random model.

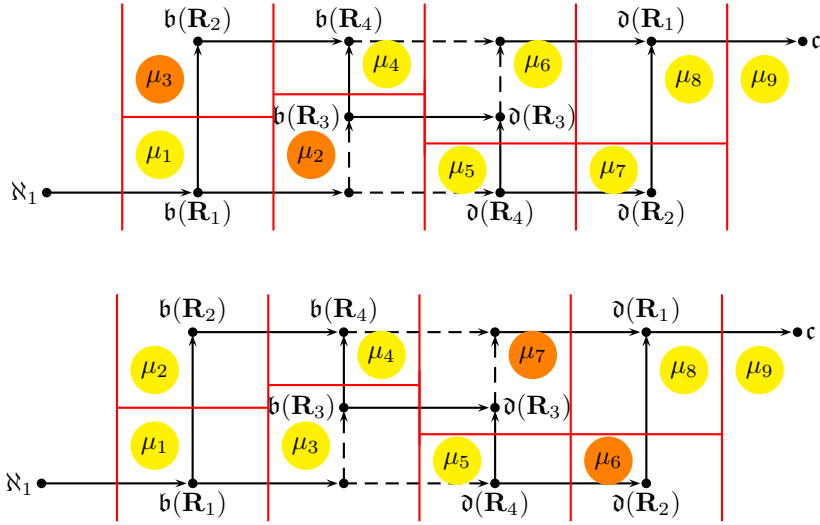

Figure 23: Instances of Cichoń’s maximum in the context of $\text{non}(\mathcal{M}) \leq \text{cov}(\mathcal{M})$ that have not been proved consistent with ZFC.

Recently, Goldstern, Kellner, Shelah and the second author proved, using large cardinals, the consistency of Cichoń’s maximum with the five cardinals on the right side possibly singular. Concretely, with the notation of [Theorem 5.1](#), it is forced $\mathbf{R}_i \cong_{\mathbb{T}} [\lambda_i^{\mathfrak{d}}]^{<\lambda_i^{\mathfrak{b}}}$ for $1 \leq i \leq 4$ by allowing $\lambda_i^{\mathfrak{d}}$ to be singular. However, it is still unknown how to adapt the methods of [Section 4](#) and [5](#) to prove this result (without using large cardinals).

Acknowledgments

This paper was developed for the conference proceedings corresponding to the second virtual RIMS Set Theory Workshop “Recent Developments in Set Theory of the Reals” that Professor Masaru Kada organized in October 2021. The authors are very thankful to Professor Kada for letting them participate in such wonderful workshop, and the second author is grateful for his invitation to talk about the methods presented in the second part of this paper.

The first author is supported by the Austrian Science Fund (FWF) P30666 and the DOC Fellowship of the Austrian Academy of Sciences at the Institute of Discrete Mathematics and Geometry, TU Wien; the second author is supported by the Grant-in-Aid for Early Career Scientists 18K13448, Japan Society for the Promotion of Science.

This work is also supported by the Research Institute for Mathematical Sciences, an International Joint Usage/Research Center located in Kyoto University.

References

- [Bar10] Tomek Bartoszyński. Invariants of measure and category. In *Handbook of set theory. Vols. 1, 2, 3*, pages 491–555. Springer, Dordrecht, 2010.

- [BCM21] Jörg Brendle, Miguel A. Cardona, and Diego A. Mejía. Filter-linkedness and its effect on preservation of cardinal characteristics. *Ann. Pure Appl. Logic*, 172(1):102856, 2021.
- [BJ95] Tomek Bartoszyński and Haim Judah. *Set Theory: On the Structure of the Real Line*. A K Peters, Wellesley, MA, 1995.
- [Bla10] Andreas Blass. Combinatorial cardinal characteristics of the continuum. In *Handbook of set theory. Vols. 1, 2, 3*, pages 395–489. Springer, Dordrecht, 2010.
- [Bre91] Jörg Brendle. Larger cardinals in Cichoń’s diagram. *J. Symbolic Logic*, 56(3):795–810, 1991.
- [Bre22] Jörg Brendle. Modern forcing techniques related to finite support iteration: Ultrapowers, templates, and submodels. [arXiv:2101.11494\[math.LO\]](https://arxiv.org/abs/2101.11494), 2022.
- [CM19] Miguel Antonio Cardona and Diego Alejandro Mejía. On Cardinal Characteristics of Yorioka Ideals. *Math. Log. Q.*, 65(2):170–199, 2019.
- [GKMS21] Martin Goldstern, Jakob Kellner, Diego Alejandro Mejía, and Saharon Shelah. Cichoń’s maximum without large cardinals. *J. Eur. Math. Soc. (JEMS)*, 2021. online first, [doi:10.4171/JEMS/1178](https://doi.org/10.4171/JEMS/1178).
- [GKMS22] Martin Goldstern, Jakob Kellner, Diego Alejandro Mejía, and Saharon Shelah. Controlling classical cardinal characteristics while collapsing cardinals. *Colloq. Math.*, 2022. accepted, [arXiv:1904.02617\[math.LO\]](https://arxiv.org/abs/1904.02617).
- [GKS19] Martin Goldstern, Jakob Kellner, and Saharon Shelah. Cichoń’s maximum. *Ann. of Math. (2)*, 190(1):113–143, 2019.
- [GMS16] Martin Goldstern, Diego Alejandro Mejía, and Saharon Shelah. The left side of Cichoń’s diagram. *Proc. Amer. Math. Soc.*, 144(9):4025–4042, 2016.
- [JS90] Haim Judah and Saharon Shelah. The Kunen-Miller chart (Lebesgue measure, the Baire property, Laver reals and preservation theorems for forcing). *J. Symbolic Logic*, 55(3):909–927, 1990.
- [Kam89] Anastasis Kamburelis. Iterations of Boolean algebras with measure. *Arch. Math. Logic*, 29(1):21–28, 1989.
- [KST19] Jakob Kellner, Saharon Shelah, and Anda R. Tănăsie. Another ordering of the ten cardinal characteristics in Cichoń’s diagram. *Comment. Math. Univ. Carolin.*, 60(1):61–95, 2019.
- [Mej13] Diego Alejandro Mejía. Matrix iterations and Cichoń’s diagram. *Arch. Math. Logic*, 52(3-4):261–278, 2013.
- [Mej19] Diego A. Mejía. Matrix iterations with vertical support restrictions. In Byunghan Kim, Jörg Brendle, Gyesik Lee, Fenrong Liu, R Ramanujam, Shashi M Srivastava, Akito Tsuboi, and Liang Yu, editors, *Proceedings of the 14th and 15th Asian Logic Conferences*, pages 213–248. World Sci. Publ., 2019.
- [Mil81] Arnold W. Miller. Some properties of measure and category. *Trans. Amer. Math. Soc.*, 266(1):93–114, 1981.

- [Voj93] Peter Vojtáš. Generalized Galois-Tukey-connections between explicit relations on classical objects of real analysis. In *Set theory of the reals (Ramat Gan, 1991)*, volume 6 of *Israel Math. Conf. Proc.*, pages 619–643. Bar-Ilan Univ., Ramat Gan, 1993.

Institute of Discrete Mathematics and Geometry
TU Wien
Wiedner Hauptstrasse 8–10/104, A-1040 Wien
AUSTRIA
E-mail address: miguel.montoya@tuwien.ac.at

Creative Science Course (Mathematics), Faculty of Science
Shizuoka University
836 Ohya, Suruga-ku, Shizuoka 422-8529
JAPAN
E-mail address: diego.mejia@shizuoka.ac.jp