

Quasiprobability fluctuation theorem behind the spread of quantum information

Kun Zhang¹ and Jin Wang^{1,2,*}

¹*Department of Chemistry, Stony Brook university, Stony Brook, New York 11794, USA*

²*Department of Physics and Astronomy, Stony Brook university, Stony Brook, New York 11794, USA*

(Dated: February 16, 2022)

Information spreads in time evolution. For example, correlations dissipate when the correlated system locally couples to a third party, such as the environment. This simple but important fact is known as the quantum data-processing inequality. Here we theoretically reveal the quantum fluctuation theorem behind the quantum informational inequality. The fluctuation theorem quantitatively predicts the statistics of such process. To fully capture the quantum nature, the fluctuation theorem established here is extended to the quasiprobability regime. We also experimentally apply a interference-based method to measure the amplitudes composing the quasiprobability and verify our established fluctuation theorem on the IBM quantum computers.

I. INTRODUCTION

Information plays more and more important roles in almost all respects of physics. Understanding the dynamics of quantum information is a vital task, which has applications in many different research subjects, such as quantum computation [1], quantum communication [2], quantum thermodynamics [3] as well as the information paradox in black holes [4]. In the general cases, the dynamics of quantum information can only be qualitatively described by the informational inequalities. For example, the quantum data-processing inequalities states that the nonlocal information can not increase under the local physical operations [5]. To be specific, the amount of correlations between the system (denoted as S) and a reference (denoted as R) can only decrease if the system interacts with the environment (denoted as E) locally, with the condition that there are no initial correlations between SR and E. See Fig. 1 for the diagrammatic illustration.

In a different context, since the work by Jarzynski [6] and Crooks [7], the qualitative description of the second law of thermodynamics (non-negativity of the entropy production) generalizes to a quantitative statement valid for arbitrary nonequilibrium process, known as the fluctuation theorem [8]. The inequality of the second law of thermodynamics is rephrased to an equality, which describes the distribution of entropy production. At the same time, quantum mechanics and thermodynamics are merging, and the quantum versions of fluctuation theorem are also established [9]. Meanwhile, quantum information plays more and more important roles in the study of quantum thermodynamics, far beyond the Maxwell demon model [10–12]. Not only the information is identified as a resource, but also the arrow of time is interpreted as the information spreading, or more specifically, the spreading of information from the system to the environment [3]. Therefore the quantum fluctuation theorem also stochastically describes the dynamics of correlations

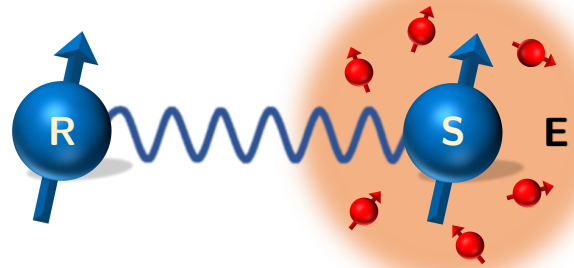

FIG. 1. Initially the system S is correlated with the reference R. After the system locally interacts with a third party, denoted as the environment E, the correlation between the system and the reference can only decrease if there is no initial correlations between SR and E.

between the system and the environment.

However, there is always a tension between the quantum mechanics and the classical stochastic or probabilistic description. The most famous one is Bell's theorem [13]. To partially resolve the issue, quantum fluctuation theorems are commonly founded in a initial-classical and final-classical manners, in which measurements are performed at both initial and final points (the two-point measurement scheme) [9, 14]. However, such scheme can only describe the case where the initial state has no correlations (between the system and the environment or within the subsystems). Therefore it is not suitable to characterize the dynamics of quantum information. Different resolutions have been proposed [15–19]. On the other hand, quasiprobability has a long history in the studying of quantum dynamics [20]. Only recently, the quasiprobability plays a role in the study of quantum thermodynamics [17, 21, 22].

In our work, we establish the fluctuation theorem behind the quantum data-processing inequality, where its statistics is described by the quasiprobability. The inequality is reformulated to an equality. Our results show that the fluctuation theorem is an universal description

* jin.wang.1@stonybrook.edu

behind the informational inequality, which is beyond the context of thermodynamics. Although quasiprobability may be hard to measure directly, there are several indirect methods, such as by the weak measurement [20]. We apply a interference-based method to measure the amplitudes on quantum computers [23], which indirectly give the quasiprobability trajectory of the dynamics. Error mitigation schemes specified for measuring the amplitude and the quasiprobability are designed. We unambiguously demonstrate the quasiprobability fluctuation theorem based on the dynamics of three qubits.

II. THEORY

Consider a general tripartite setup, which includes the system (S), the reference (R) and the environment (E). Initially, the system and the reference are correlated, where the initial state is denoted as ρ_{SR} . The amount of correlation is quantified by the mutual information $\mathcal{I}(S; R)_\rho = \mathcal{S}(\rho_S) + \mathcal{S}(\rho_R) - \mathcal{S}(\rho_{SR})$ with the von-Neumann entropy $\mathcal{S}(\rho) = -\text{Tr}\rho \ln(\rho)$. Both classical and quantum correlations are counted in $\mathcal{I}(S; R)_\rho$.

Assume that the system locally interacts with the environment via a unitary evolution, namely $\rho'_{SE} = U_{SE}(\rho_S \otimes \rho_E)U_{SE}^\dagger$. We use the superscript prime to label variables related to the final state. The initial state of the system and environment is assumed to be factorized. Therefore the correlation between the system and the environment can only increase after the evolution. On the other side, the correlation between the system and the reference is preserved in the way $\mathcal{I}(R; S)_\rho = \mathcal{I}(R; SE)_{\rho'}$. In other words, the information stored between the system and the reference spreads to the environment. The consequence is that the information between the system and the reference decreases, which gives

$$\Delta\mathcal{I}(S; R) \geq 0, \quad (1)$$

with $\Delta\mathcal{I}(S; R) = \mathcal{I}(S; R)_\rho - \mathcal{I}(S; R)_{\rho'}$. Without any possible confusions, we simplify the notation as $\Delta\mathcal{I} \equiv \Delta\mathcal{I}(S; R)$ in the following. The above inequality is called quantum data-processing inequality [5]. It follows the intuition since local operations can not increase the non-local information. Since we assume the factorized initial state between the system and the environment, which guarantees the satisfaction of quantum data-processing inequality [24]. The proof of classical data-processing inequality is quiet simple. Without a close analog between the classical and quantum information, the data-processing inequality also magically holds in the quantum case. The proof of quantum data-processing inequality is highly nontrivial, which usually invokes the strong subadditivity of von-Neumann entropy [25]. The decreased mutual information $\Delta\mathcal{I}$ is also equal to the final state conditional mutual information between the environment and the reference (conditioned on the system), which bounds the fidelity to recover the initial state from the final state

[26, 27]. Therefore, the information loss is related to ir-retrodictability [28–30].

The quantum correlation between the system and the reference always flows to the environment because there is no initial correlation between the system and the environment. It resembles the heat flowing from the high temperature to low temperature reservoirs. If the thermodynamic quantity, such as heat, has a fluctuation theorem [31], do we also have a fluctuation theorem behind the spread of information? We answer this question affirmatively.

First, we set some notations. Denote the probability distribution of the correlated state ρ_{RS} as p_l , given by the decomposition $\rho_{RS} = \sum_l p_l \Pi_l$ with the nonlocal eigenoperator $\Pi_l = |l\rangle_{RS}\langle l|$ (projector of the eigenstate). When we look at the system and reference separately, we have $\rho_R = \sum_r p_r \Pi_r$ and $\rho_s = \sum_s p_s \Pi_s$ with the eigenstates $|r\rangle_R$ and $|s\rangle_S$ respectively. Quantum correlation would forbid the joint distribution of p_l and p_s (or p_r), because of the noncommutativity between Π_l and Π_s (or Π_r). In analog to the stochastic mutual information (the unaveraged mutual information) [32], define the stochastic quantum mutual information as $\iota(S; R)_\rho = \ln p_l - \ln p_s - \ln p_r$ [15, 18]. Similarly, the stochastic quantum mutual information of the final state ρ'_{SR} is $\iota(S; R)_{\rho'} = \ln p_{l'} - \ln p_{s'} - \ln p_{r'}$. Since the reference is untouched by the evolution U_{SR} , we do not expect a different distribution $p_{r'}$ from p_r , which gives $p_r = p_{r'}$ with $r = r'$. But the global distributions p_l and $p_{l'}$ would be different, since the correlation between S and R changes. The stochastic quantity behind the quantum mutual information change $\Delta\mathcal{I}(S; R)$ is $\Delta\iota(S; R) = \iota(S; R)_\rho - \iota(S; R)_{\rho'}$, with the expression

$$\Delta\iota(S; R) = \ln\left(\frac{p_l}{p_s p_r}\right) - \ln\left(\frac{p_{l'}}{p_{s'} p_{r'}}\right). \quad (2)$$

Without any possible confusion, we simplify the notation as $\Delta\iota \equiv \Delta\iota(S; R)$ in the following. Our starting point is to view the stochastic mutual information change $\Delta\iota$ as a stochastic entropy production. In stochastic thermodynamics, taking the average over all possible trajectories would give the average entropy production, which is always positive [3]. Then the next step is to find the trajectories of the stochastic mutual information change $\Delta\iota$.

Both classical and quantum fluctuation theorems are founded by probabilistic trajectories. However, quantum mechanics rejects the classical stochastic description, known as the temporal Bell inequalities or the Leggett-Garg inequalities [33]. Recently, more researches have studied the quasiprobabilistic description of quantum thermodynamic processes which includes quantum coherence and quantum correlation [17, 21, 22]. Inspired from the quasiprobability in the study of quantum chaos [23, 34], we consider the following quasiprobability trajectory

$$\mathcal{Q}[\zeta] \equiv \text{ReTr}\left(U_{SR}^\dagger \Pi_{l'n'} \Pi_{r's'} U_{SR} \Pi_{rs} \Pi_{ln} \rho_{RSE}\right), \quad (3)$$

with the stochastic variables $\zeta = \{r, s, l, n, r', s', l', n'\}$. The projector Π_n is given by the eigenstate of the environment, namely $\rho_E = \sum_n p_n \Pi_n$. We adopt the simplified notations $\Pi_{r,s} = \Pi_r \otimes \Pi_s$. Note that the initial state is factorized $\rho_{RSE} = \rho_{RS} \otimes \rho_E$. We only consider the real part of quasiprobability, where its imaginary part has its own interests in quantum dynamics [35].

It is easy to see that quasiprobability $\mathcal{Q}[\zeta]$ is properly normalized, i.e., $\sum_{\zeta} \mathcal{Q}[\zeta] = 1$. However, it is not a valid probability because its range is not bounded between 0 and 1. The out-of-range quasiprobability is the signature of quantum interference [20]. The global operator, such as Π_l , is intertwined with the local operator, such as Π_r and Π_s . When we marginalize the variables in terms of local or global operators, the quasiprobability returns back to a valid probability, which is exactly the probabilistic trajectories studied in quantum fluctuation theorem. For example, we have

$$\mathcal{P}[\gamma] \equiv \sum_{l, l', r, r'} \mathcal{Q}[\zeta] = |\langle s' n' | U_{SR} | s n \rangle|^2 p_s p_n, \quad (4)$$

which describes a probabilistic distribution of the initial and final states (in terms of the system and the environment). Here $\mathcal{P}[\gamma]$ is commonly applied to the study of quantum fluctuation theorem of the entropy production [3]. Therefore the quasiprobability trajectory can also properly describe the original quantum fluctuation theorems. For more discussions, see the Method section.

The quasiprobability is not directly measurable. However, it is not merely a mathematical artifice. Quasiprobability describes the weak measurement, where the system is probed indirectly. More specifically, the system is weakly coupled to the measurement apparatus, then the apparatus is measured. The weak measurement scheme can also be applied to measure $\mathcal{Q}[\zeta]$, where the two-point weak measurement is applied.

Firstly, we can verify that averaging the stochastic mutual information change $\Delta\mathcal{I}$ over the quasiprobability trajectory $\mathcal{Q}[\zeta]$ gives rise to

$$\langle \Delta\mathcal{I} \rangle_{\mathcal{Q}[\zeta]} = \Delta\mathcal{I}. \quad (5)$$

Here the bracket means the average $\langle \cdot \rangle_{\mathcal{Q}[\zeta]} = \sum_{\zeta} \mathcal{Q}[\zeta] \langle \cdot \rangle$. Then our main result is the following quasiprobability fluctuation theorem

$$\langle e^{-\Delta\mathcal{I}} \rangle_{\mathcal{Q}[\zeta]} = 1. \quad (6)$$

It takes the exact same form of the quantum fluctuation theorem, while the difference is the quasiprobability applied to the trajectory. We present the derivations of Eqs. (5) and (6) in the Method section. The positivity of the averaged stochastic entities, such as the stochastic entropy production, over the probability trajectory simply reflect the positivity of the relative entropy [3]. However, the positivity of the averaged stochastic mutual information change over the quasiprobability trajectory

is beyond any classical statistical inequality. Statistical analysis can be carried out on the traditional fluctuation theorem [36]. It would be interesting to explore along the same line for the quasiprobability fluctuation theorem.

In the small dissipation regime, expanding to the second order, we get an informational fluctuation-dissipation relation

$$\langle (\Delta\mathcal{I} - \Delta\mathcal{I})^2 \rangle_{\mathcal{Q}[\zeta]} = 2\Delta\mathcal{I} + \mathcal{O}(\Delta\mathcal{I}^3), \quad (7)$$

where the left-hand side is the variance of the stochastic mutual information change and the right-hand side represents the degree of the information decay. The quasiprobability fluctuation theorem in Eq. (6) provides much more statistical descriptions on the information spreading than the quantum data-processing inequality.

In the thermodynamic context, the fluctuation theorem regarding to the classical information dissipation firstly appeared in [37]. It characterizes the extra thermodynamic cost in the Maxwell's demon model. Later, the dissipative mutual information is studied in quantum cases, within the framework of two-point measurement scheme [38]. The issue of the two-point measurement scheme is the measurement performed initially would kill the quantum correlation, therefore only classical correlation is left.

When we look closer on the fluctuation theorem in Eq. (6), there are hidden fluctuation theorems, which have the form $\langle e^{-\Delta\mathcal{I}} \rangle_{\mathcal{Q}[\zeta]/\mathcal{P}[\gamma]} = 1$. The average is done on the conditional quasiprobability $\mathcal{Q}[\zeta]/\mathcal{P}[\gamma]$ (assuming $\mathcal{P}[\gamma]$ is nonzero), where $\mathcal{P}[\gamma]$ is a valid probability given in Eq. (4). The conditional quasiprobability $\mathcal{Q}[\zeta]/\mathcal{P}[\gamma]$ also gives the detailed fluctuation theorem. More details can be found in the Method section.

There is an ambiguity of the operator order in $\mathcal{Q}[\zeta]$, since operator Π_l does not commute with Π_r or Π_s in general cases. However, there is no restriction on choosing a specific order to give the quasiprobability fluctuation theorem, even for their combinations. For simplicity, here we only focus on this specific order. See the Method section for more discussions.

III. EXPERIMENT

Quantum fluctuation theorems have been verified on many different platforms as well as different methods [39–44]. Cloud quantum computers provide a unique platform to study the quantum phenomena. Quantum fluctuation theorems have also been studied on quantum computers recently [45]. Quasiprobability fluctuation theorem presented above does not limit to the size of the environment or types of the system-environment interaction. In the following, we consider the dynamics of three qubits and verify the corresponding fluctuation theorem through the IBM quantum computers [46].

Suppose that the system, the reference and the environment are all one qubit respectively. We consider the initial correlation between the system and the reference

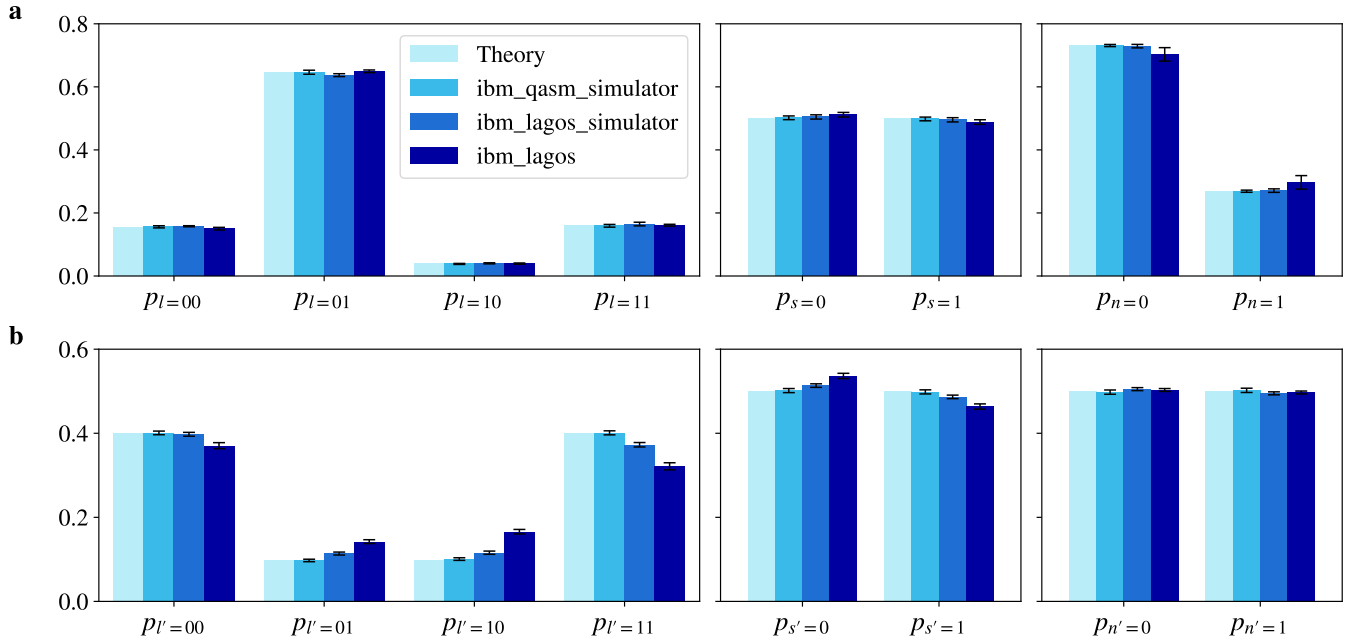

FIG. 2. (a) Initial and (b) final statistics of the joint states ρ_{RSE} and ρ'_{RSE} measured on IBM quantum computer `ibm_lagos`. The `ibm_qasm_simulator` and `ibm_lagos_simulator` are provided by Qiskit, which classically simulates the quantum computers without and with the noises. The probabilities are estimated based on 8192 shots of the circuits. The standard deviation is given by 10×8192 shots of the circuits.

as a full rank Bell-diagonal state, which has four Bell states as the eigenstates, i.e., $\rho_{RS} = \sum_l p_l |\psi(l)\rangle\langle\psi(l)|$ with the four Bell states $|\psi(l)\rangle$. Bell-diagonal states can be easily prepared on quantum computers with the help of two ancillary qubits [47]. We randomly generalize the distribution p_l then perform the Bell measurements on the initial state. The reference qubit is chosen as thermal: $\rho_R = p_{n=0}|0\rangle_R\langle 0| + p_{n=1}|1\rangle_R\langle 1|$ with $p_{n=0} = 1/(1 + e^{-\beta})$ and $p_{n=1} = 1/(1 + e^{\beta})$. Here β is the effective temperature. Statistics of local state ρ_S , ρ_R and ρ_E are separately measured. In Fig. 2, we present the theoretical results, simulation results (classical simulator of quantum computer with or without noises) and the results from quantum processor `ibm_lagos`.

We consider the interaction between the system qubit and the environment qubit as $U_{SE} = |0\rangle_S\langle 0| \otimes \mathbb{1}_E + |1\rangle_S\langle 1| \otimes Y_E$ with the single-qubit gate $Y = |0\rangle\langle 1| - |1\rangle\langle 0|$. The two-qubit operation U_{SE} has the maximal entangling power, which would disentangle the initial quantum correlation between the system and the reference. Therefore, the eigenvectors of ρ'_{RS} are the same as the local eigenvectors of ρ'_R and ρ'_S . Similar with the initial state, we measure the statistics of the final state. The results are shown in Fig. 2.

In our example, the quasiprobability $\mathcal{Q}[\zeta]$ has the equivalent expression

$$\mathcal{Q}[\zeta] = \langle\psi(l)n|U_{SE}^\dagger|r's'n'\rangle\langle s'n'|U_{SE}|sn\rangle\langle rs|\psi(l)\rangle p_l p_n, \quad (8)$$

with the short notation $|\psi(l)n\rangle = |\psi(l)\rangle \otimes |n\rangle$. Al-

though sequential weak measurements can be applied to infer the value of $\mathcal{Q}[\zeta]$, it is still challenging on quantum computers for the precise control. We follow an interference-based method [23] to measure the amplitudes $\langle\psi(l)n|U_{SE}|r's'n'\rangle$, $\langle s'n'|U_{SE}|sn\rangle$ and $\langle rs|\psi(l)\rangle$ separately. See Fig. 3 for the experimental results on measuring the amplitudes. More details on the experimental setup and the corresponding quantum circuits can be found in the Method section.

Now we can assemble together the stochastic mutual information change $\Delta\iota$ with the quasiprobability $\mathcal{Q}[\zeta]$ to verify the fluctuation theorem. The fluctuation theorem $\langle e^{-\Delta\iota} \rangle_{\mathcal{Q}[\zeta]/\mathcal{P}[\gamma]} = 1$ is based on the conditional quasiprobability $\mathcal{Q}[\zeta]/\mathcal{P}[\gamma]$. For each variable γ which gives a nonzero $\mathcal{P}[\gamma]$, we have a fluctuation relation. The experimental results are presented in Fig. 4. Results from the quantum computer are little deviated from the noisy or noiseless simulation results, which imply that the deviations are from the imperfect operations of near-term quantum computers.

IV. CONCLUSIONS AND DISCUSSIONS

In this paper, we establish the fluctuation theorem behind the spread of quantum information. Our results are not limited to specific systems or interactions between the system and the environment. We generalize the quantum fluctuation theorem into the regime given by the

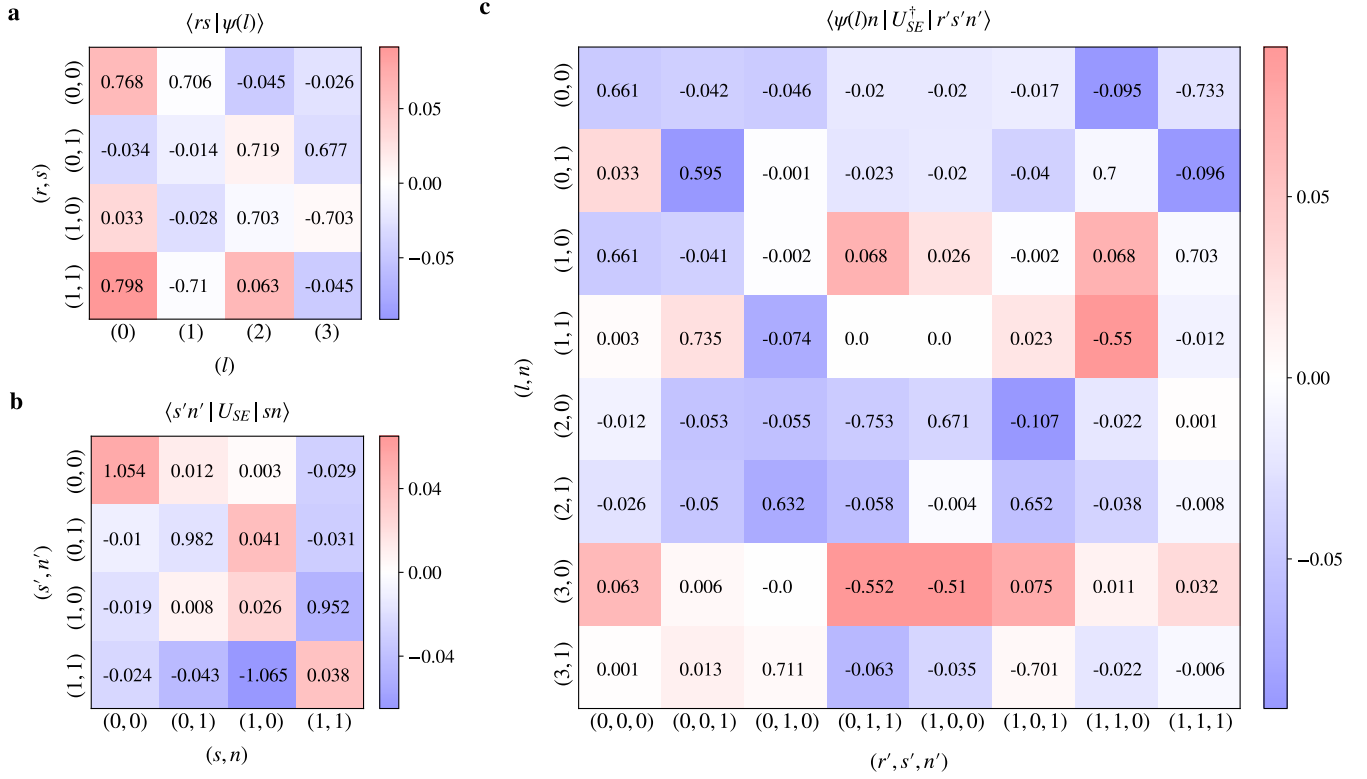

FIG. 3. The amplitudes (a) $\langle rs | \psi(l) \rangle$, (b) $\langle s'n' | U_{SE} | sn \rangle$ and (c) $\langle \psi(l)n | U_{SE}^\dagger | r's'n' \rangle$ measured on IBM quantum processor `ibm_lagos`. The values are averaged on 10×8192 shots of the circuits. The color represents the deviations from the theoretical values.

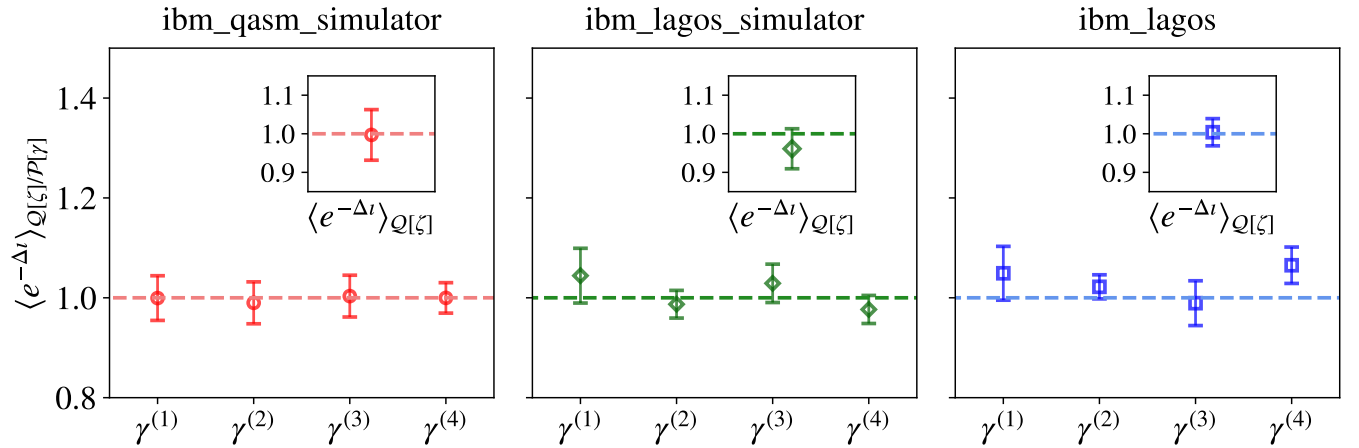

FIG. 4. Verified quasiprobability fluctuation theorem on IBM quantum processor `ibm_lagos`. The processors `ibm_qasm_simulator` and `ibm_lagos_simulator` are provided by Qiskit, which classically simulates the quantum computers without and with the noises. The standard deviation is given by 10×8192 shots of the circuits. The conditional stochastic variables $\gamma = \{s, n, s'n'\}$ have the values $\gamma^{(1)} = \{0, 0, 0, 0\}$, $\gamma^{(2)} = \{1, 0, 0, 1\}$, $\gamma^{(3)} = \{0, 1, 1, 0\}$ and $\gamma^{(4)} = \{1, 1, 1, 1\}$.

quasiprobabilities, which fully capture the quantum dynamics. The fluctuation theorem predicts the statistics of quantum information processing, such as the informational fluctuation-dissipation relation. We have also experimentally verified the quasiprobability fluctuation

theorem on IBM quantum computers. Our study opens the door of research on stochastic quantum information, which provides novel insights on the dynamics of quantum information.

Independently, the fluctuation theorem of the mono-

tonicity of quantum relative entropy (another form of the quantum data-processing inequality) was proposed in [17]. Quasiprobability trajectories were also applied. It would be interesting to clarify the relations between their fluctuation theorems and our work.

Although the negative quasiprobability rejects the Jensen's inequality $\langle e^x \rangle \geq e^{\langle x \rangle}$, but the quantum data-processing inequality still holds. There are hidden con-

straints on the quantum mechanical quasiprobability distributions, which guarantee the Jensen's inequality $\langle e^x \rangle \geq e^{\langle x \rangle}$ including the negative quasiprobabilities. When the quantum data-processing inequality breaks, whether the quasiprobability fluctuation theorem can capture the anomalous flow of quantum information is an open question. It is related to the non-Markovian dynamics. Attempts have been made recently [48].

-
- [1] M. A. Nielsen and I. L. Chuang, *Quantum Computation and Quantum Information: 10th Anniversary Edition* (2010).
- [2] M. M. Wilde, From Classical to Quantum Shannon Theory, arXiv:1106.1445 [quant-ph] 10.1017/9781316809976.001 (2017), arXiv:1106.1445 [quant-ph].
- [3] G. T. Landi and M. Paternostro, Irreversible entropy production: From classical to quantum, *Reviews of Modern Physics* **93**, 035008 (2021).
- [4] A. Almheiri, T. Hartman, J. Maldacena, E. Shaghoulian, and A. Tajdini, The entropy of Hawking radiation, *Reviews of Modern Physics* **93**, 035002 (2021).
- [5] B. Schumacher and M. A. Nielsen, Quantum data processing and error correction, *Physical Review A* **54**, 2629 (1996).
- [6] C. Jarzynski, Nonequilibrium Equality for Free Energy Differences, *Physical Review Letters* **78**, 2690 (1997).
- [7] G. E. Crooks, Nonequilibrium Measurements of Free Energy Differences for Microscopically Reversible Markovian Systems, *Journal of Statistical Physics* **90**, 1481 (1998).
- [8] M. Esposito, U. Harbola, and S. Mukamel, Nonequilibrium fluctuations, fluctuation theorems, and counting statistics in quantum systems, *Reviews of Modern Physics* **81**, 1665 (2009).
- [9] M. Campisi, P. Hänggi, and P. Talkner, Colloquium: Quantum fluctuation relations: Foundations and applications, *Reviews of Modern Physics* **83**, 771 (2011).
- [10] K. Maruyama, F. Nori, and V. Vedral, Colloquium: The physics of Maxwell's demon and information, *Reviews of Modern Physics* **81**, 1 (2009).
- [11] J. Goold, M. Huber, A. Riera, L. del Rio, and P. Skrzypczyk, The role of quantum information in thermodynamics—a topical review, *Journal of Physics A: Mathematical and Theoretical* **49**, 143001 (2016).
- [12] S. Deffner and S. Campbell, Quantum Thermodynamics: An introduction to the thermodynamics of quantum information, arXiv:1907.01596 [cond-mat, physics:quant-ph] (2019), arXiv:1907.01596 [cond-mat, physics:quant-ph].
- [13] J. S. Bell, On the einstein podolsky rosen paradox, *Physics Physique Fizika* **1**, 195 (1964).
- [14] H. Tasaki, Jarzynski relations for quantum systems and some applications, arXiv preprint cond-mat/0009244 (2000), arXiv:cond-mat/0009244.
- [15] J. J. Park, S. W. Kim, and V. Vedral, Fluctuation Theorem for Arbitrary Quantum Bipartite Systems, arXiv:1705.01750 [quant-ph] (2017), arXiv:1705.01750 [quant-ph].
- [16] J. Åberg, Fully Quantum Fluctuation Theorems, *Physical Review X* **8**, 011019 (2018).
- [17] H. Kwon and M. S. Kim, Fluctuation Theorems for a Quantum Channel, *Physical Review X* **9**, 031029 (2019).
- [18] K. Micadei, G. T. Landi, and E. Lutz, Quantum Fluctuation Theorems beyond Two-Point Measurements, *Physical Review Letters* **124**, 090602 (2020).
- [19] A. Sone, Y.-X. Liu, and P. Cappellaro, Quantum Jarzynski Equality in Open Quantum Systems from the One-Time Measurement Scheme, *Physical Review Letters* **125**, 060602 (2020).
- [20] J. Dressel, Weak values as interference phenomena, *Physical Review A* **91**, 032116 (2015).
- [21] M. Lostaglio, Quantum Fluctuation Theorems, Contextuality, and Work Quasiprobabilities, *Physical Review Letters* **120**, 040602 (2018).
- [22] A. Levy and M. Lostaglio, Quasiprobability Distribution for Heat Fluctuations in the Quantum Regime, *PRX Quantum* **1**, 010309 (2020).
- [23] N. Yunger Halpern, Jarzynski-like equality for the out-of-time-ordered correlator, *Physical Review A* **95**, 012120 (2017).
- [24] F. Buscemi, Complete Positivity, Markovianity, and the Quantum Data-Processing Inequality, in the Presence of Initial System-Environment Correlations, *Physical Review Letters* **113**, 140502 (2014).
- [25] E. H. Lieb and M. B. Ruskai, Proof of the strong subadditivity of quantum-mechanical entropy, *Journal of Mathematical Physics* **14**, 1938 (1973).
- [26] O. Fawzi and R. Renner, Quantum Conditional Mutual Information and Approximate Markov Chains, *Communications in Mathematical Physics* **340**, 575 (2015).
- [27] F. G. S. L. Brandão, A. W. Harrow, J. Oppenheim, and S. Strelchuk, Quantum Conditional Mutual Information, Reconstructed States, and State Redistribution, *Physical Review Letters* **115**, 050501 (2015).
- [28] S. Watanabe, Symmetry of Physical Laws. Part III. Prediction and Retrodiction, *Reviews of Modern Physics* **27**, 179 (1955).
- [29] C. C. Aw, F. Buscemi, and V. Scarani, Fluctuation Theorems with Retrodiction rather than Reverse Processes, *AVS Quantum Science* **3**, 045601 (2021), arXiv:2106.08589.
- [30] F. Buscemi and V. Scarani, Fluctuation theorems from Bayesian retrodiction, *Physical Review E* **103**, 052111 (2021).
- [31] C. Jarzynski and D. K. Wójcik, Classical and Quantum Fluctuation Theorems for Heat Exchange, *Physical Review Letters* **92**, 230602 (2004).
- [32] J. M. R. Parrondo, J. M. Horowitz, and T. Sagawa, Thermodynamics of information, *Nature Physics* **11**, 131 (2015).

- [33] C. Emary, N. Lambert, and F. Nori, Leggett–Garg inequalities, *Reports on Progress in Physics* **77**, 016001 (2013).
- [34] N. Yunger Halpern, B. Swingle, and J. Dressel, Quasiprobability behind the out-of-time-ordered correlator, *Physical Review A* **97**, 042105 (2018).
- [35] J. Dressel and A. N. Jordan, Significance of the imaginary part of the weak value, *Physical Review A* **85**, 012107 (2012).
- [36] N. Merhav and Y. Kafri, Statistical properties of entropy production derived from fluctuation theorems, *Journal of Statistical Mechanics: Theory and Experiment* **2010**, P12022 (2010).
- [37] Q. Zeng and J. Wang, New fluctuation theorems on Maxwell’s demon, *Science Advances* **7**, eabf1807 (2021).
- [38] K. Zhang, X. Wang, Q. Zeng, and J. Wang, Conditional entropy production and quantum fluctuation theorem of dissipative information, arXiv:2105.06419 [cond-mat, physics:quant-ph] (2021), arXiv:2105.06419 [cond-mat, physics:quant-ph].
- [39] R. Dorner, S. R. Clark, L. Heaney, R. Fazio, J. Goold, and V. Vedral, Extracting Quantum Work Statistics and Fluctuation Theorems by Single-Qubit Interferometry, *Physical Review Letters* **110**, 230601 (2013).
- [40] T. B. Batalhão, A. M. Souza, L. Mazzola, R. Aucaise, R. S. Sarthour, I. S. Oliveira, J. Goold, G. De Chiara, M. Paternostro, and R. M. Serra, Experimental Reconstruction of Work Distribution and Study of Fluctuation Relations in a Closed Quantum System, *Physical Review Letters* **113**, 140601 (2014).
- [41] S. An, J.-N. Zhang, M. Um, D. Lv, Y. Lu, J. Zhang, Z.-Q. Yin, H. T. Quan, and K. Kim, Experimental test of the quantum Jarzynski equality with a trapped-ion system, *Nature Physics* **11**, 193 (2015).
- [42] F. Cerisola, Y. Margalit, S. Machluf, A. J. Roncaglia, J. P. Paz, and R. Folman, Using a quantum work meter to test non-equilibrium fluctuation theorems, *Nature Communications* **8**, 1241 (2017).
- [43] Y. Masuyama, K. Funo, Y. Murashita, A. Noguchi, S. Kono, Y. Tabuchi, R. Yamazaki, M. Ueda, and Y. Nakamura, Information-to-work conversion by Maxwell’s demon in a superconducting circuit quantum electrodynamical system, *Nature Communications* **9**, 1291 (2018).
- [44] K. Micadei, J. P. S. Peterson, A. M. Souza, R. S. Sarthour, I. S. Oliveira, G. T. Landi, R. M. Serra, and E. Lutz, Experimental Validation of Fully Quantum Fluctuation Theorems Using Dynamic Bayesian Networks, *Physical Review Letters* **127**, 180603 (2021).
- [45] A. Solfanelli, A. Santini, and M. Campisi, Experimental Verification of Fluctuation Relations with a Quantum Computer, *PRX Quantum* **2**, 030353 (2021).
- [46] IBM Quantum, <https://quantum-computing.ibm.com/> (2022).
- [47] M. B. Pozzobom and J. Maziero, Preparing tunable Bell-diagonal states on a quantum computer, *Quantum Information Processing* **18**, 142 (2019).
- [48] Z. Huang, Fluctuation Theorems for multitime processes, arXiv:2201.08691 [cond-mat, physics:quant-ph] (2022), arXiv:2201.08691 [cond-mat, physics:quant-ph].
- [49] D. Maslov, Advantages of using relative-phase Toffoli gates with an application to multiple control Toffoli optimization, *Physical Review A* **93**, 022311 (2016).

ACKNOWLEDGMENTS

We acknowledge the access to advanced services provided by the IBM Quantum Researchers Program. In this paper we used `ibm_lagos`, which is one of the IBM Quantum Canary Processors. The authors thank Vladimir Korepin, Xuanhua Wang, Qian Zeng, Wei Wu, Wufu Shi, He Wang and Hong Wang for helpful discussions.

METHODS

Theory

Averaged mutual information change

The quasiprobability trajectory $\mathcal{Q}[\zeta]$ reduces to the probability trajectory $\mathcal{P}[\gamma]$ after marginalizing the stochastic variables $\{l, l', r, r'\}$, shown in Eq. (4). The trajectory $\mathcal{P}[\gamma]$ appears in the ordinary quantum fluctuation theorem within the two-point measurement scheme [3]. Consider the stochastic entropy production of the system, given by $\sigma_S = \ln p_s + \ln p_n - \ln p_{s'} - \ln p_{n'}$. One can easily find that the averaged entropy production over the trajectory $\mathcal{P}[\gamma]$ is

$$\langle \sigma_S \rangle_{\mathcal{P}[\gamma]} = \mathcal{I}(S; E)_{\rho'}. \quad (9)$$

Different stochastic quantity can give the different averaged quantity. Here we set the stochastic entropy production σ_S which gives the mutual information between the system and the environment established on the final state.

The quasiprobability trajectory $\mathcal{Q}[\zeta]$ has another way to reduce to the probability trajectory. Marginalizing the stochastic variables $\{s, s', r, r'\}$ gives

$$\begin{aligned} \mathcal{P}'[\tau] &\equiv \sum_{s, s', r, r'} \mathcal{Q}[\zeta] \\ &= |\langle l' n' | U_{SR} | l n \rangle|^2 p_l p_n, \end{aligned} \quad (10)$$

with $\tau = \{l, l', n, n'\}$. We can consider the stochastic entropy production of the combined system and reference, given by $\sigma_{SR} = \ln p_l + \ln p_n - \ln p_{l'} - \ln p_{n'}$. Then the corresponding averaged entropy production over the trajectory $\mathcal{P}'[\tau]$ is

$$\langle \sigma_{SR} \rangle_{\mathcal{P}'[\tau]} = \mathcal{I}(SR; E)_{\rho'}. \quad (11)$$

Physically, the stochastic entropy production σ_S (σ_{SR}) characterizes the correlation between the system (system plus the reference) and the environment as irreversibility.

The stochastic mutual information change $\Delta\iota$ given in Eq. (2) is also the difference between σ_{SR} and σ_S , namely $\Delta\iota = \sigma_{SR} - \sigma_S$ (with $r = r'$). Taking the average over

the quasiprobability trajectory $\mathcal{Q}[\zeta]$, we have

$$\begin{aligned} \langle \Delta \iota \rangle_{\mathcal{Q}[\zeta]} &= \sum_{\tau} \sum_{s, s', r, r'} \mathcal{Q}[\zeta] \sigma_{SR} - \sum_{\gamma} \sum_{l, l', r, r'} \mathcal{Q}[\zeta] \sigma_S \\ &= \sum_{\tau} \mathcal{P}'[\tau] \sigma_{SR} - \sum_{\gamma} \mathcal{P}[\gamma] \sigma_S, \end{aligned} \quad (12)$$

where the marginalizing relations (4) and (10) have been applied to the second line. Based on the averaged quantities in Eqs. (9) and (11), we find $\langle \Delta \iota \rangle_{\mathcal{Q}[\zeta]} = \mathcal{I}(SR; E)_{\rho'} - \mathcal{I}(S; E)_{\rho'}$, which is also equal to $\langle \Delta \iota \rangle_{\mathcal{Q}[\zeta]} = \mathcal{I}(S; E)_{\rho} - \mathcal{I}(S; E)_{\rho'}$, since the initial correlation is preserved given by $\mathcal{I}(S; E)_{\rho} = \mathcal{I}(SR; E)_{\rho'}$. Then we prove that the averaged stochastic mutual information change $\Delta \iota$ equals to $\Delta \mathcal{I}(S; R)$.

Proof of the quasiprobability fluctuation theorem

The integral fluctuation theorem relies on the normalization of a corresponding retrodiction trajectory (also commonly known as the backward process) [29, 30]. Therefore the choice of retrodiction process is subjective. Similar in our quasiprobability fluctuation theorem, the integral version is established on the normalization of the quantum retrodiction trajectory, which is given by the conditional quasiprobability (quasiprobability conditioned on a probability).

Corresponding to the forward quasiprobability trajectory $\mathcal{Q}[\zeta]$ defined in Eq. (3), we consider the retrodiction quasiprobability trajectory

$$\tilde{\mathcal{Q}}[\zeta] = \text{ReTr} \left(U_{SR} \Pi_{ln} \Pi_{rs} U_{SR}^{\dagger} \Pi_{r's'} \Pi_{l'n'} \rho'_{RS} \otimes \rho'_E \right), \quad (13)$$

where the initial state is set as the factorized final state of the system plus the reference and the environment. Similarly to the relation (4), marginalizing the variables $\{l, l', r, r'\}$ gives the probability

$$\begin{aligned} \tilde{\mathcal{P}}[\gamma] &\equiv \sum_{l, l', r, r'} \tilde{\mathcal{Q}}[\zeta] \\ &= |\langle sn | U_{SR}^{\dagger} | s'n' \rangle|^2 p_{s'} p_{n'}, \end{aligned} \quad (14)$$

where $p_{s'}$ and $p_{n'}$ are the eigenvalue distributions of ρ'_S and ρ'_E respectively.

After some algebra, we can establish the relation

$$\frac{\mathcal{Q}[\zeta]}{\mathcal{P}[\gamma]} e^{-\Delta \iota} = \frac{\tilde{\mathcal{Q}}[\zeta]}{\tilde{\mathcal{P}}[\gamma]}, \quad (15)$$

where the ratio between the conditional forward quasiprobability trajectory $\mathcal{Q}[\zeta]/\mathcal{P}[\gamma]$ and the conditional retrodiction quasiprobability trajectory $\tilde{\mathcal{Q}}[\zeta]/\tilde{\mathcal{P}}[\gamma]$ is given by $e^{-\Delta \iota}$. Their ratio is exponential scaled with the stochastic mutual information change $\Delta \iota$, which is in the form of the detailed fluctuation theorem. Here the probabilistic distribution has been generalized to the conditional quasiprobability distribution.

The conditional quasiprobability trajectories are properly normalized

$$\sum_{\zeta/\gamma} \frac{\mathcal{Q}[\zeta]}{\mathcal{P}[\gamma]} = \sum_{\zeta/\gamma} \frac{\tilde{\mathcal{Q}}[\zeta]}{\tilde{\mathcal{P}}[\gamma]} = 1. \quad (16)$$

Then we have the quasiprobability fluctuation theorem given by the conditional quasiprobability trajectory

$$\langle e^{-\Delta \iota} \rangle_{\mathcal{Q}[\zeta]/\mathcal{P}[\gamma]} = \sum_{\zeta/\gamma} \frac{\tilde{\mathcal{Q}}[\zeta]}{\tilde{\mathcal{P}}[\gamma]} = 1. \quad (17)$$

Moreover, the unconditional quasiprobability trajectory also gives the integral fluctuation theorem

$$\langle e^{-\Delta \iota} \rangle_{\mathcal{Q}[\zeta]} = \sum_{\gamma} \mathcal{P}[\gamma] \sum_{\zeta/\gamma} \frac{\tilde{\mathcal{Q}}[\zeta]}{\tilde{\mathcal{P}}[\gamma]} = 1, \quad (18)$$

which is guaranteed by the normalization of $\mathcal{P}[\gamma]$.

Different ordering of projectors in $\mathcal{Q}[\zeta]$ does not jeopardize the validation of the quasiprobability fluctuation theorem, as long as the ordering of projectors in $\tilde{\mathcal{Q}}[\zeta]$ is correspondingly changed and the relation (15) holds. Besides the averaged relation (5) does not require specific orderings of projectors in $\mathcal{Q}[\zeta]$, since the marginalized relations (4) and (10) eliminate the uncommuted operators.

In addition to the new quasiprobability fluctuation theorem revealed above, the quasiprobability trajectory $\mathcal{Q}[\zeta]$ also smoothly generalize the quantum fluctuation theorem of the entropy productions σ_S and σ_{SR} . Specifically, we have

$$\langle e^{-\sigma_S} \rangle_{\mathcal{Q}[\zeta]} = \langle e^{-\sigma_{SR}} \rangle_{\mathcal{Q}[\zeta]} = 1. \quad (19)$$

We can simply have the proof by applying the marginalizing rules shown in Eqs. (4) and (10). Then the above quasiprobability fluctuation theorems reduce to the well-known quantum fluctuation theorems given by the two-point measurement trajectories [3].

Experiment

Initial and final states distributions

The Bell-diagonal state (between the system qubit and the reference qubit) can be easily prepared on quantum computers, where two ancillary qubits are required [47]. The corresponding quantum circuit is

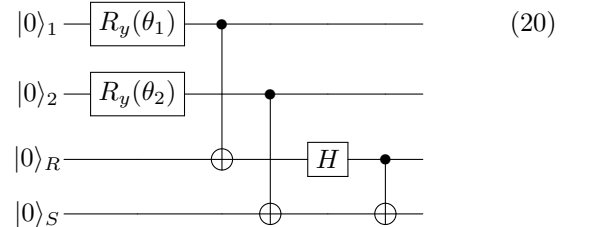

where qubits 1 and 2 are ancillary qubits. Here $R_y(\theta)$ is the rotation gate on y -axis and H is the Hadamard gate [1]. The CNOT operation applying on the ancillary qubit 1 (2) and the R (S) qubit gives the mixed state of R (S) qubit. The latter Hadamard gate and CNOT gate transform the product states to the Bell states. Measuring the RS qubits on Bell basis (which is also the eigenbasis of the RS qubits), we have the probabilities

$$\begin{aligned} p_{l=0} &= \cos^2\left(\frac{\theta_1}{2}\right) \cos^2\left(\frac{\theta_2}{2}\right), \\ p_{l=1} &= \sin^2\left(\frac{\theta_1}{2}\right) \cos^2\left(\frac{\theta_2}{2}\right), \\ p_{l=2} &= \cos^2\left(\frac{\theta_1}{2}\right) \sin^2\left(\frac{\theta_2}{2}\right), \\ p_{l=3} &= \sin^2\left(\frac{\theta_1}{2}\right) \sin^2\left(\frac{\theta_2}{2}\right). \end{aligned} \quad (21)$$

Then local computational basis measurement or the Bell measurement on SR can reveal the initial distribution of ρ_{SR} . In our experiments, we randomly choose the initial distribution, where the angles are set as $\theta_1 = 0.7098\pi$ and $\theta_2 = 1.7059\pi$. It is easy to verify that the Bell-diagonal state generated by the above two angles are entangled.

The thermal qubit (in the computational basis) can be prepared with one ancillary qubit by the circuit

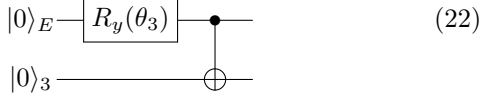

where qubit 3 is ancillary. The angle θ_3 is determined by the effective temperature β , namely $\theta_3 = 2 \arctan(e^\beta)$.

We set the unitary interaction between the system and environment qubits as the controlled gate $U_{SE} = |0\rangle_S\langle 0| \otimes \mathbb{1}_E + |1\rangle_S\langle 1| \otimes Y_E$, which can be decomposed as one CNOT gate and one CZ gate. Although we can choose the interaction between the system and the environment qubits arbitrarily, choosing the specific U_{SE} interaction is to take the advantage that the controlled U_{SE} gate, given by $|0\rangle\langle 0| \otimes \mathbb{1}_{SE} + |1\rangle\langle 1| \otimes U_{SE}$, is the simplest three-qubit controlled gate to be realized on the IBM quantum computers [49]. The controlled U_{SE} gate is required to measure the quasiprobability trajectory.

Combined with the initial state setup, the final state is given by the circuit

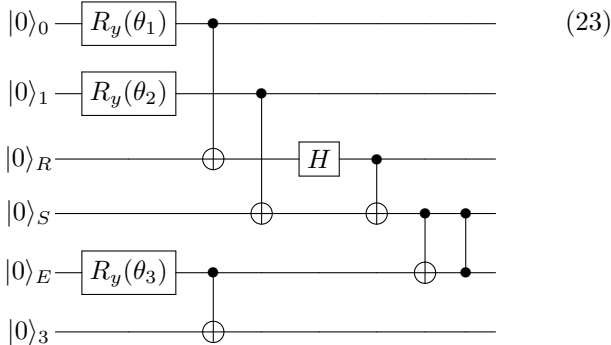

Measuring the qubits R, S, and E in the computational basis can reveal the statistics of the final state. Note that the final state ρ'_{RS} is no longer entangled (but classically correlated).

Measuring the quasiprobability trajectory

The quasiprobability trajectory $\mathcal{Q}[\zeta]$ given in Eq. (8) is the multiplication of three amplitudes and the distribution of the initial state. The amplitude can be measured in a interference-based manner, reported in [23]. Suppose that we want to measure the amplitude $\langle f|U|f\rangle$ in terms of the unitary evolution U . Firstly, we prepare the state $|\psi_{t_0}\rangle = (|0\rangle + |1\rangle)|f\rangle/\sqrt{2}$, where the first qubit provides the superposition for interference. Then perform the controlled U -gate where the first qubit is the control, which gives $|\psi_{t_1}\rangle = (|0\rangle|f\rangle + |1\rangle U|f\rangle)/\sqrt{2}$. After that, the single-qubit gate $R_y(\theta)$ is applied to the first qubit, which gives $|\psi_{t_2}\rangle = (R_y(\theta)|0\rangle|f\rangle + R_y(\theta)|1\rangle U|f\rangle)/\sqrt{2}$. Then the probability that the state $|\psi_{t_2}\rangle$ is projected on $|0\rangle|f\rangle$ is $P(0, f) = |\langle 0|f\rangle\langle\psi_{t_2}|^2$, which is equal to

$$P(0, f) = \frac{1}{2} \left(\cos^2\left(\frac{\theta}{2}\right) + \sin^2\left(\frac{\theta}{2}\right) |\langle f|U|f\rangle|^2 - \sin(\theta) \text{Re}\langle f|U|f\rangle \right). \quad (24)$$

And the measured result $|1\rangle|f\rangle$ has the probability

$$P(1, f) = \frac{1}{2} \left(\sin^2\left(\frac{\theta}{2}\right) + \cos^2\left(\frac{\theta}{2}\right) |\langle f|U|f\rangle|^2 + \sin(\theta) \text{Re}\langle f|U|f\rangle \right). \quad (25)$$

Knowing the probabilities $P(0, f)$ (or $P(1, f)$) and $|\langle f|U|f\rangle|^2$, one can infer the amplitude $\text{Re}\langle f|U|f\rangle$. The imaginary part of $\langle f|U|f\rangle$ can be similarly measured by replacing the single-qubit gate $R_y(\theta)$ with $R_x(\theta)$.

Converting the above scheme to the quantum circuit model, we have

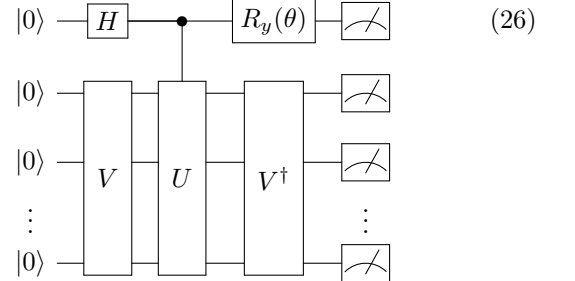

The first qubit is the ancillary qubit providing the space for interference. Here V is the operation preparing the state $|f\rangle$. If the state $|f\rangle$ is not in the computational basis, then the unitary operation V^\dagger is required in order to project on $|f\rangle$. If we need to measure the amplitude $\langle f|U|f'\rangle$, then additional unitary operations are required to transform $|f'\rangle$ to $|f\rangle$. In our

example, measuring the amplitudes $\langle s'n'|U_{SE}|sn\rangle$ and $\langle rs|\psi(l)\rangle$ needs three qubits, while measuring the amplitude $\langle \psi(l)n|U_{SE}|r's'n'\rangle$ requires four qubits.

There is a free parameter θ in the above scheme. Based on Eqs. (24) and (25), we can solve the amplitude $\text{Re}\langle f|U|f\rangle$ as the function of the angle θ and the probabilities $P(0, f)$ and $P(1, f)$ (assuming $\sin\theta \neq 0$), given by

$$\text{Re}\langle f|U|f\rangle = \tan\left(\frac{\theta}{2}\right)P(1, f) - \cot\left(\frac{\theta}{2}\right)P(0, f) + \cot\theta. \quad (27)$$

The state-of-art quantum computers are still very noisy. Therefore the measured probabilities $P(0, f)$ and $P(1, f)$ are likely deviated from the theoretical values. However, if the deviation can be predicted, then choosing the appropriate angles θ can still give the accurate amplitude $\text{Re}\langle f|U|f\rangle$. In other words, the noisy deviations in $P(0, f)$ and $P(1, f)$ are cancelled with each other in Eq. (27). We exploit such error mitigation schemes in our experiments. The angles are decided by the noisy simulation results. Qiskit includes the noisy simulation custom for each quantum processor, where the noises are predicted based on the benchmarked metrics of quantum computers. A systematical study on the above error

mitigation scheme for measuring the amplitudes will be addressed in the future.

Experimental setups

We conduct all the experiments on the IBM quantum processor `ibm_lagos`, through the access of IBM Quantum Researchers Program. The quantum computer `ibm_lagos` is a seven-qubit quantum computer with the quantum volume 32. The typical metrics of `ibm_lagos` are the following: the average CNOT errors: 1.092e-2; the average readout errors: 1.197e-2; the average T1 time: 144.52 us; the average T2 time: 103.14 us. The experiments are completed in two months due to the limited monthly allocation of running hours. Therefore the metrics of `ibm_lagos` changed in time. Both the circuits on measuring the initial or final state distribution and the quasiprobability trajectories are submitted with 8192 shots. Then the probabilities are estimated by the distribution of 8192 outputs. The standard deviations are obtained via repeating 10 times of the circuits with 8192 shots.