

Arrival time for the fastest among N switching stochastic particles

S. Toste¹, D. Holcman¹

¹ *Group of Data Modeling, Computational Biology, IBENS, Ecole Normale Supérieure-PSL, France*

We study the first arrival time for the fastest among N Brownian particles that can switch between two states inside a finite interval. The switching is modeled as a two-state Markov chain and particles can only escape in state 1. We estimate the fastest arrival time by solving asymptotically the Fokker-Planck equations for three different initial distributions: uniformly distributed, delta-Dirac and long-tail decay. The derived formulas reveal that the fastest particle avoid switching when the switching rates are much smaller than the diffusion time scale. The present results are compared to stochastic simulations revealing the range of validity of the derived formulas. Finally, we discuss some applications in cell biology.

1. INTRODUCTION

Key chemical reactions occurring in cells, depend on the arrival of the first molecules to small targets [24]. This is case for a large class of agonist molecules arriving to a gated channel located on the cell membrane [25]. Upon arrival of the first ones, channels open and thus it is not necessarily to study the dynamics of the rest of the agonist population in the process of activation. This example shows that the statistics of the fastest arrival time is a key event in revealing the time scale of channel activation.

The process of escape for the fastest is often studied as an extreme statistical event [4, 7?], where Brownian particles have to find a narrow window, which represents a small fraction of the explored space. Interestingly, the probability distribution function and the mean time for the fastest, $\bar{\tau}^N$, can be computed explicitly [7, 11, 12, 23? ? ?]. Interestingly, the asymptotic formula for the mean of the fastest depends on the initial distribution [14].

We study here the extreme statistic properties for an ensemble of Brownian particles that can switch between two states characterized by two diffusion coefficient D_1 and D_2 , as shown by Fig. 1A. The particles can only escape in state 1. Our goal is to compute the distribution and the mean arrival times for the fastest (MFAT) depending on the initial distribution. We shall consider four different initial distributions (Fig. 1B). Fig. 1C shows a realization of a switching Brownian particle escaping in state 1 only is.

The manuscript is organized as follows: Section 2 presents the stochastic model. In section 3, we develop the method to compute asymptotic solutions for two initial conditions and different diffusion coefficients. In section 4, we study the case where particles are uniformly distributed in an interval. In section 5, we present the distribution of arrival times for a long-tail initial distribution. In the final section, we discuss applications of the present results to elementary signaling in cell biology.

2. STOCHASTIC MODEL

In the present model, we consider N identical independently distributed Brownian particles that can switch at Poissonian random time between two states as described by

$$1 \xrightleftharpoons[\mu]{\lambda} 2, \quad (1)$$

with rates λ and μ . The particles can escape only in state 1. The stochastic equation for the position $x(t, i)$ in state i of the particle is given for $i, j = 1, 2$ by

$$x(t + \Delta t, i) = \begin{cases} x(t, i) + \sqrt{2D_i}\Delta w_i(t) & \text{w.p } 1 - k_{ij}\Delta t + o(\Delta t) \\ x(t, j) & \text{w.p } k_{ij}\Delta t + o(\Delta t), i \neq j \end{cases}, \quad (2)$$

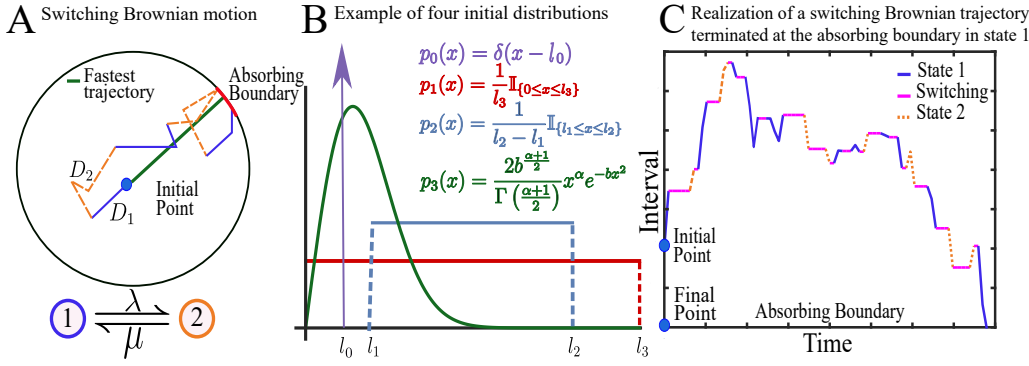

FIG. 1: **Schematic figure for switching Brownian dynamics.** **A.** Example of two switching Brownian motions with two states inside a disk with a narrow absorbing boundary. The particle can escape only in state 1. The fastest trajectory (green) should move in the shortest path and be in state 1 at the absorbing boundary for escape. **B.** Four initial distributions **C.** Realization of Brownian trajectories starting at $x = 2$ and absorbed at $x = 0$.

where $w_i(t)$ ($i = 1, 2$) are independent standard Brownian motions, $\Delta w_i(t) = w_i(t + \Delta t) - w_i(t)$, and k_{ij} are the transition rates from state i to j . The transition probability density function $p(x, i, t|y, s, j)$ of the trajectory $x(t, i)$ with the initial condition $x(s, j) = x$, is the limit as $\Delta t \rightarrow 0$ of the integral equations

$$p(x, i, t + \Delta t|y, j, s) = \frac{1 - k_{ij}\Delta t}{\sqrt{2\pi D_i \Delta t}} \int_{\Omega} p(z, i, t|y, j, s) \exp\left\{-\frac{|x-z|^2}{2D_i \Delta t}\right\} dz$$

$$+ k_{ji}\Delta t p(x, l, t|y, j, s) + o(\Delta t) \quad \text{for } i, j, l = 1, 2, i \neq j.$$
(3)

In the present case, we shall use the notation $k_{12} = \lambda$, $k_{21} = \mu$, and $p(x, 1, t|y, 0) = p_1(x, t)$ and $p(x, 2, t|y, 0) = p_2(x, t)$. In the limit $\Delta t \rightarrow 0$, the backward system of Kolmogorov equation is given by [19?]

$$\frac{\partial p_1}{\partial t}(x, t) = D_1 \frac{\partial^2 p_1}{\partial x^2}(x, t) - \lambda p_1(x, t) + \mu p_2(x, t)$$

$$\frac{\partial p_2}{\partial t}(x, t) = D_2 \frac{\partial^2 p_2}{\partial x^2}(x, t) - \mu p_2(x, t) + \lambda p_1(x, t).$$
(4)

Our goal is to find an explicit solution in the domain $[0, +\infty)$, with the boundary conditions

$$p_1(0, t) = 0$$

$$\frac{\partial p_2}{\partial x}(0, t) = 0.$$
(5)

When the particle starts in state 1 at point $y > 0$, the initial conditions are given by

$$p_1(x, 0) = \delta(x - y)$$

$$p_2(x, 0) = 0.$$
(6)

We impose the normalization condition

$$\int_0^\infty p_1(x, 0) + p_2(x, 0) dx = 1.$$
(7)

When the particle starts in state 2 at point $y > 0$, the associated initial conditions are

$$\begin{aligned} p_1(x, 0) &= 0 \\ p_2(x, 0) &= \delta(x - y). \end{aligned} \quad (8)$$

3. EXPLICIT SOLUTION WHEN THE BROWNIAN PARTICLES START IN STATE 1

To solve system (4-6), we use the Laplace's transform in the time domain

$$\begin{aligned} \mathcal{L}(p_1(x, t)) &= \hat{p}_1(x, q) = \int_0^\infty p_1(x, t) \cdot e^{-qt} dt \\ \mathcal{L}(p_2(x, t)) &= \hat{p}_2(x, q) = \int_0^\infty p_2(x, t) \cdot e^{-qt} dt, \end{aligned}$$

to get the system of two ordinary differential equations

$$D_1 \hat{p}_1''(x, q) - (\lambda + q) \hat{p}_1(x, q) + \mu \hat{p}_2(x, q) + \delta(x - y) = 0 \quad (9)$$

$$D_2 \hat{p}_2''(x, q) - (\mu + q) \hat{p}_2(x, q) + \lambda \hat{p}_1(x, q) = 0. \quad (10)$$

3.1. Particles start in state 1 and $D_2 = 0$

From equation (10), when $D_2 = 0$, we have the relation

$$\hat{p}_2(x, q) = \frac{\lambda}{q + \mu} \hat{p}_1(x, q). \quad (11)$$

Replacing this relation in equation (9), we get

$$\hat{p}_1''(x, q) - \frac{q(q + \theta)}{D_1(q + \mu)} \hat{p}_1(x, q) = -\frac{\delta(x - y)}{D_1}, \quad (12)$$

where $\theta = \lambda + \mu$. We find the general solution of equation (12), by considering the solution G of homogeneous ordinary differential equation

$$\frac{d^2 G}{dx^2} - \frac{q(q + \theta)}{D_1(q + \mu)} G = 0.$$

The roots of the associated polynomial are

$$w_{1,2} = \pm \sqrt{\frac{q(q + \theta)}{D_1(q + \mu)}}, \quad (13)$$

and the general solution is

$$G(x, q) = A e^{w_1 \cdot |x-y|} + B e^{w_2 \cdot |x-y|}, \quad (14)$$

with $A, B \in \mathbb{R}$. We are interested in the function that satisfies the condition

$$\frac{\partial G_+}{\partial x}(y, q) - \frac{\partial G_-}{\partial x}(y, q) = -\frac{1}{D_1}.$$

Thus A and B satisfy the relation

$$2(A - B)\sqrt{\frac{q(q + \theta)}{D_1(q + \mu)}} = -\frac{1}{D_1}.$$

We can write the solution in the following form:

$$G(x, q) = \left(B - \sqrt{\frac{q + \mu}{4D_1q(q + \theta)}} \right) e^{w_1 \cdot |x-y|} + B e^{w_2 \cdot |x-y|}.$$

Since the solution is bounded, we impose $A = 0$, thus

$$\hat{p}_1(x, q) = \sqrt{\frac{q + \mu}{4D_1q(q + \theta)}} \exp \left\{ -\sqrt{\frac{q(q + \theta)}{D_1(q + \mu)}} \right\}.$$

To satisfy the boundary conditions $\hat{p}_1(0, q) = 0$, we finally get

$$\hat{p}_1(x, q) = \sqrt{\frac{q + \mu}{4D_1q(q + \theta)}} \left(\exp \left\{ -\sqrt{\frac{q(q + \theta)}{D_1(q + \mu)}} |x - y| \right\} - \exp \left\{ -\sqrt{\frac{q(q + \theta)}{D_1(q + \mu)}} |x + y| \right\} \right).$$

From relation (11) we obtain

$$\hat{p}_2(x, q) = \frac{\lambda}{q + \mu} \sqrt{\frac{q + \mu}{4D_1q(q + \theta)}} \left(\exp \left\{ -\sqrt{\frac{q(q + \theta)}{D_1(q + \mu)}} |x - y| \right\} + \exp \left\{ -\sqrt{\frac{q(q + \theta)}{D_1(q + \mu)}} |x + y| \right\} \right).$$

The Laplace Transform of the survival probability is given by

$$\hat{S}(q) = \int_{\Omega} (\hat{p}_1(x, q) + \hat{p}_2(x, q)) dx = \frac{1}{q} - \frac{q + \mu}{q(q + \theta)} \exp \left\{ -\sqrt{\frac{q(q + \theta)}{D_1(q + \mu)}} y \right\}.$$

Using a Taylor expansion for q large, we have

$$\begin{aligned} \hat{S}(q) &= \frac{1}{q} - \frac{\exp \left\{ -\sqrt{\frac{q}{D_1}} y \right\}}{q} + \lambda \frac{\exp \left\{ -\sqrt{\frac{q}{D_1}} y \right\}}{q^2} + \lambda y \frac{\exp \left\{ -\sqrt{\frac{q}{D_1}} y \right\}}{q \cdot \sqrt{4D_1q}} \\ &+ O \left(\frac{\exp \left\{ -\sqrt{\frac{q}{D_1}} y \right\}}{q^2} \right). \end{aligned}$$

Applying then, the Inverse Laplace Transform, we have for t small, the approximation

$$\begin{aligned} S(t) &\approx 1 - \operatorname{erfc} \left(\frac{y}{\sqrt{4D_1t}} \right) + \lambda t \cdot \operatorname{erfc} \left(\frac{y}{\sqrt{4D_1t}} \right) \\ &\approx 1 - \sqrt{4D_1t} \frac{\exp \left\{ -\frac{y^2}{4D_1t} \right\}}{y\sqrt{\pi}}. \end{aligned} \tag{15}$$

This leads for large N , following [5],

$$\begin{aligned} \bar{\tau}^N &= \int_0^{\infty} [S(t)]^N dt \approx \int_0^{\infty} \exp \left\{ \log \left\{ 1 - e^{-\frac{y^2}{4D_1t}} \frac{\sqrt{4D_1t}}{y\sqrt{\pi}} \right\}^N \right\} dt \\ &\approx_N \frac{y^2}{4D_1 \cdot \log \left(\frac{N}{\sqrt{\pi}} \right)}. \end{aligned} \tag{16}$$

The distribution for the first arrival time in the case of t small is

$$\begin{aligned} Pr\{\tau^1 = t\} &= -\frac{d}{dt}S^N(t) \approx -\frac{d}{dt}\left[\exp\left\{-\frac{\sqrt{4D_1tN}}{y\sqrt{\pi}}e^{-\frac{y^2}{4D_1t}}\frac{\sqrt{4D_1tN}}{y\sqrt{\pi}}\right\}\right] \\ &= \frac{N(\sqrt{4D_1t})}{y\sqrt{\pi}}\exp\left\{-\frac{y^2}{4D_1t}\right\}\exp\left\{-\frac{\sqrt{4D_1tN}}{y\sqrt{\pi}}e^{-\frac{y^2}{4D_1t}}\right\}\left[\frac{y^2}{4D_1t^2} + \frac{1}{2t}\right]. \end{aligned} \quad (17)$$

This result is similar to the one when the particles do not switch [5]. When we consider

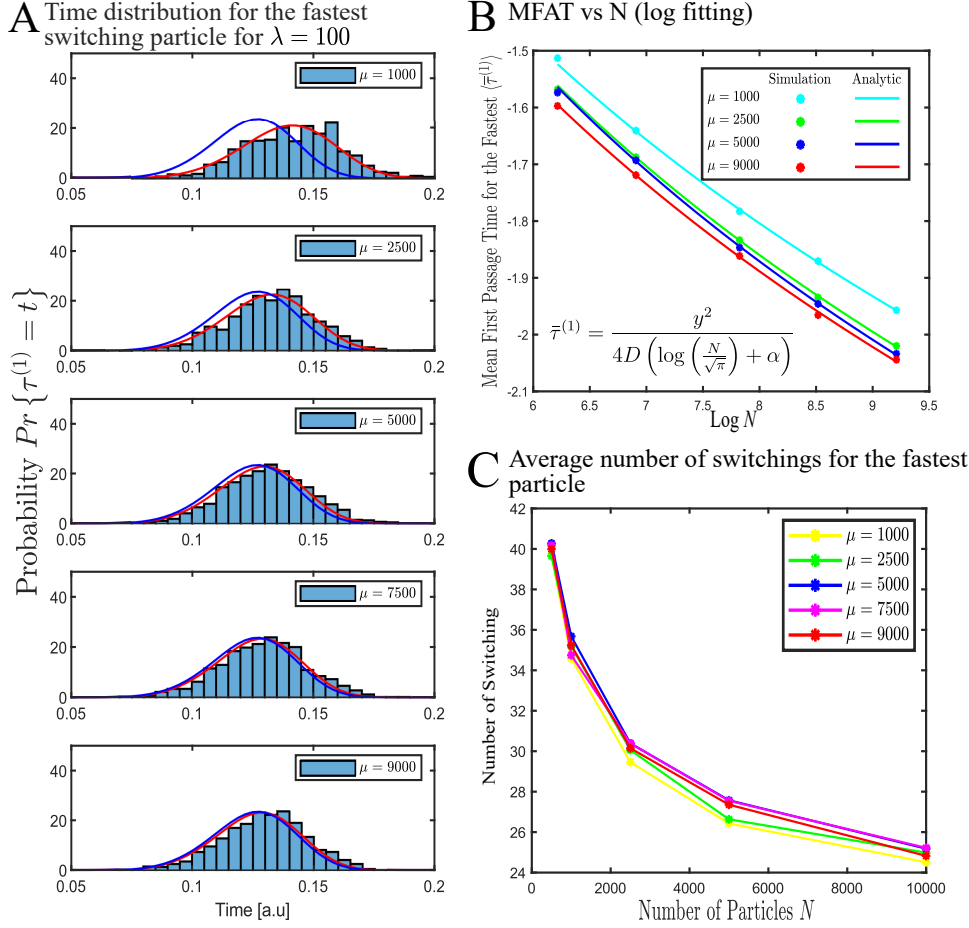

FIG. 2: **Mean fastest arrival time vs the number of particles N .** **A.** Distribution of the arrival time $\bar{\tau}^N$: analytical short-time formula (blue) and analytical long-time formula (red) vs stochastic simulations (blue histogram) for particles starting at position $y = 2$ for $N = 10000$ with 1000 runs. **B.** MFAT vs N for the stochastic simulations (colored disks) and the asymptotic formulas (continuous lines) (equation 18) for different values of $\mu = [1000, 2500, 5000, 7500, 9000]$ and $\lambda = 100$ plotted in Log-Log scale. An optimal fit gives $\alpha = [-1.334, -0.9959, -0.9292, -0.8275, -0.8109]$. **C.** Mean number of switching for the fastest particles.

large switching rates, the distribution for the first arrival time is given by the inverse of the

long-time expansion of the Laplace's transform.

$$\begin{aligned} Pr \{ \tau^1 = t \} &= -\frac{d}{dt} S^N(t) \approx -\frac{d}{dt} \left[\exp \left\{ -\frac{\sqrt{4D_1 t} N \mu^{\frac{3}{2}}}{y \theta^{\frac{3}{2}} \sqrt{\pi}} e^{-\frac{y^2 \theta}{4D_1 \mu t}} \frac{\sqrt{4D_1 t} N}{y \sqrt{\pi}} \right\} \right] \\ &= \frac{N \mu^{\frac{3}{2}} (\sqrt{4D_1 t})}{y \theta^{\frac{3}{2}} \sqrt{\pi}} \exp \left\{ -\frac{y^2 \theta}{4D_1 \mu t} \right\} \times \exp \left\{ -\frac{\sqrt{4D_1 t} N \mu^{\frac{3}{2}}}{y \theta^{\frac{3}{2}} \sqrt{\pi}} e^{-\frac{y^2 \theta}{4D_1 \mu t}} \right\} \left[\frac{y^2 \theta}{4D_1 \mu t^2} + \frac{1}{2t} \right] \end{aligned} \quad (18)$$

To conclude we find that the fastest particle does not switch to the state 2 and escapes in state 1.

To evaluate the range of validity of the present formula, we decided to compare the asymptotic distributions with stochastic simulations. We generated trajectories until they reach the origin and selected the fastest one. Fig. 2 shows the statistics for the simulation of a switching process, starting in state 1 with diffusion coefficients $D_1 = 1$ and $D_2 = 0$. We use for the initial number of particles $N = [500, 1000, 2500, 5000, 10000]$ with a time step $\Delta t = 0.0001$. The switching rates are $\lambda = 100$ and $\mu = [1000, 2500, 5000, 7500, 9000]$. We obtain a good agreement between the long-time expression for the distribution (equation 18) of the arrival time and the stochastic simulations (Fig. 2A). We further confirm the decay of the MFAT vs N . We use a shift α in formula 16 to correct for possible switching: indeed the fastest particle should not switch when it starts in state 1. Indeed, we report a large number of switching (Fig. 2C) for the fastest particles. Interestingly, this number seems not to depend on the switching rate μ . In addition, it is unclear to us when the asymptotic limit is achieved and large should be N so the number of switching read a few unit.

3.2. Particles start in state 1 and $D_2 \neq 0$

From equation (10), we obtain that

$$\hat{p}_1(x, q) = \frac{(\mu + q)}{\lambda} \hat{p}_2(x, q) - \frac{D_2}{\lambda} \hat{p}_2''(x, q),$$

which can be reduced to a system of order 4

$$\hat{p}_2^{(iv)} - \left[\frac{\lambda + q}{D_1} + \frac{\mu + q}{D_2} \right] \hat{p}_2'' + \left[\frac{(\lambda + q)(\mu + q) - \lambda \mu}{D_1 D_2} \right] \hat{p}_2 = \frac{\lambda}{D_1 D_2} \delta_y. \quad (19)$$

The solution G of the homogeneous equation is

$$\frac{d^4 G}{dx^4} - a \frac{d^2 G}{dx^2} + b G = 0,$$

where $a = \frac{\lambda + q}{D_1} + \frac{\mu + q}{D_2}$ and $b = \frac{(\lambda + q)(\mu + q) - \lambda \mu}{D_1 D_2}$. The roots of the associated polynomial are

$$w_i = \pm \frac{\sqrt{a \pm \sqrt{a^2 - 4b}}}{\sqrt{2}} \quad i = \overline{1, 4}, \quad (20)$$

they are real as

$$a^2 - 4b = q^2 \left(\frac{1}{D_1} - \frac{1}{D_2} \right)^2 + 2q \left(\frac{1}{D_1} - \frac{1}{D_2} \right) \left(\frac{\lambda}{D_1} - \frac{\mu}{D_2} \right) + \left(\frac{\lambda}{D_1} + \frac{\mu}{D_2} \right)^2,$$

and this polynomial in q is always positive as the coefficient of q^2 is positive and the discriminant is non positive

$$Disc = -16 \frac{\lambda \mu}{D_1 D_2} \left(\frac{1}{D_1} - \frac{1}{D_2} \right)^2.$$

We have $\sqrt{a^2 - 4b} \geq 0$. Since $b > 0$ we obtain that $a - \sqrt{a^2 - 4b} > 0$, and $\sqrt{a \pm \sqrt{a^2 - 4b}} \in \mathbb{R}$. The general solution of equation (19) is of the form

$$G(x, q) = Ae^{w_1 \cdot |x-y|} + Be^{w_2 \cdot |x-y|} + Ce^{w_3 \cdot |x-y|} + De^{w_4 \cdot |x-y|}, \quad (21)$$

with $A, B, C, D \in \mathbb{R}$. The solution is understood in the Distributions sense (19). Using the ensemble of smooth compact support $f(x)$ with \mathbb{R} such that

$$\varphi^{(iv)} - a\varphi'' + b\varphi = f,$$

we shall compute $\int_{\mathbb{R}} G \cdot f dx$. Integrating by parts and using the fact that the derivatives of G until order 2 are continuous in \mathbb{R} , we get

$$\begin{aligned} \int_{\mathbb{R}} G \cdot f dx &= \int_{\mathbb{R}} G \cdot (\varphi^{(iv)} - a\varphi'' + b\varphi) dx = \varphi(y) \left(\frac{d^3 G_+(y)}{dx^3} - \frac{d^3 G_-(y)}{dx^3} \right) \\ &= \varphi(y) (2Aw_1^3 + 2Bw_2^3 + 2Cw_3^3 + 2Dw_4^3). \end{aligned}$$

If we choose A, B, C and D such that $2Aw_1^3 + 2Bw_2^3 + 2Cw_3^3 + 2Dw_4^3 = \frac{\lambda}{D_1 D_2}$, we got

$$\begin{aligned} \int_{\mathbb{R}} G \cdot f dx &= \langle G, \varphi^{(iv)} - a\varphi'' + b\varphi \rangle = \langle G^{(iv)} - aG'' + bG, \varphi \rangle \\ &= \frac{\lambda}{D_1 D_2} \varphi(y) = \langle \frac{\lambda}{D_1 D_2} \delta(x-y), \varphi \rangle. \end{aligned}$$

Then,

$$\begin{aligned} \langle G^{(iv)} - aG'' + bG, \varphi \rangle &= \langle \frac{\lambda}{D_1 D_2} \delta(x-y), \varphi \rangle \\ G^{(iv)} - aG'' + bG &= \frac{\lambda}{D_1 D_2} \delta(x-y). \end{aligned}$$

Using the previous condition for G be a solution in the sense of Distributions

$$2Aw_1^3 + 2Bw_2^3 + 2Cw_3^3 + 2Dw_4^3 = \frac{\lambda}{D_1 D_2},$$

and the condition coming from the fact that all derivatives until order 2 are continuous

$$2Aw_1 + 2Bw_2 + 2Cw_3 + 2Dw_4 = 0,$$

we can write the solution in the following form

$$\begin{aligned} G(x, q) &= - \left(\frac{Bw_2 + Cw_3 + Dw_4}{w_1} \right) \cdot e^{w_1|x-y|} + B \cdot e^{w_2|x-y|} \\ &+ \left(\frac{\lambda}{2D_1 D_2 w_3 (w_3^2 - w_1^2)} - \frac{2Bw_2 (w_2^2 - w_1^2)}{2w_3 (w_3^2 - w_1^2)} - \frac{2Dw_4 (w_4^2 - w_1^2)}{2w_3 (w_3^2 - w_1^2)} \right) \cdot e^{w_3|x-y|} \\ &+ D \cdot e^{w_4|x-y|}. \end{aligned}$$

Since the solution is bounded, we obtain that $A = C = 0$, and this leads to

$$B = \frac{\lambda}{2D_1 D_2 w_2 (w_2^2 - w_4^2)}, \quad D = \frac{\lambda}{2D_1 D_2 w_4 (w_4^2 - w_2^2)},$$

and the solution is

$$\hat{p}_2(x, q) = \frac{\lambda}{2D_1 D_2 w_2 (w_2^2 - w_4^2)} \cdot e^{w_2|x-y|} + \frac{\lambda}{2D_1 D_2 w_4 (w_4^2 - w_2^2)} \cdot e^{w_4|x-y|}.$$

Finally, the boundary conditions leads to

$$\begin{aligned}\hat{p}_2(x, q) &= \frac{\lambda}{2D_1D_2w_2(w_2^2 - w_4^2)} \cdot \left(e^{w_2|x-y|} + e^{w_2|x+y|} \right) \\ &+ \frac{\lambda}{2D_1D_2w_4(w_4^2 - w_2^2)} \cdot \left(e^{w_4|x-y|} + e^{w_4|x+y|} \right).\end{aligned}\quad (22)$$

Using the other boundary relation (10), we find that

$$\hat{p}_1(x, q) = \frac{(\mu + q - D_2w_2^2)}{2D_1D_2w_2(w_2^2 - w_4^2)} \cdot e^{w_2|x-y|} + \frac{(\mu + q - D_2w_4^2)}{2D_1D_2w_4(w_4^2 - w_2^2)} \cdot e^{w_4|x-y|},$$

and using the boundary conditions $\hat{p}_1(0, q) = 0$, we get

$$\begin{aligned}\hat{p}_1(x, q) &= \frac{(\mu + q - D_2w_2^2)}{2D_1D_2w_2(w_2^2 - w_4^2)} \cdot \left(e^{w_2|x-y|} - e^{w_2|x+y|} \right) \\ &+ \frac{(\mu + q - D_2w_4^2)}{2D_1D_2w_4(w_4^2 - w_2^2)} \cdot \left(e^{w_4|x-y|} - e^{w_4|x+y|} \right),\end{aligned}\quad (23)$$

where

$$w_{2,4} = -\frac{\sqrt{\frac{\lambda+q}{D_1} + \frac{\mu+q}{D_2} \pm \sqrt{q^2 \left(\frac{1}{D_1} - \frac{1}{D_2} \right)^2 + 2q \left(\frac{1}{D_1} - \frac{1}{D_2} \right) \left(\frac{\lambda}{D_1} - \frac{\mu}{D_2} \right) + \left(\frac{\lambda}{D_1} + \frac{\mu}{D_2} \right)^2}}}{\sqrt{2}}\quad (24)$$

We shall now use the inverse Laplace's Transform to recover the solution for short time asymptotic.

3.2.1. Particles start in state 1 with the same diffusion coefficient $D_1 = D_2 = D$.

In the present case, the roots are

$$w_2 = -\sqrt{\frac{q + \lambda + \mu}{D}}, \quad w_4 = -\sqrt{\frac{q}{D}},\quad (25)$$

and the solutions

$$\begin{aligned}\hat{p}_1(x, q) &= \frac{\lambda}{2\theta\sqrt{D}\sqrt{q+\theta}} \left(e^{-\sqrt{\frac{q+\theta}{D}}|x-y|} - e^{-\sqrt{\frac{q+\theta}{D}}|x+y|} \right) \\ &+ \frac{\mu}{2\theta\sqrt{D}\sqrt{q}} \left(e^{-\sqrt{\frac{q}{D}}|x-y|} - e^{-\sqrt{\frac{q}{D}}|x+y|} \right), \\ \hat{p}_2(x, q) &= -\frac{\lambda}{2\theta\sqrt{D}\sqrt{q+\theta}} \left(e^{-\sqrt{\frac{q+\theta}{D}}|x-y|} + e^{-\sqrt{\frac{q+\theta}{D}}|x+y|} \right) \\ &+ \frac{\lambda}{2\theta\sqrt{D}\sqrt{q}} \left(e^{-\sqrt{\frac{q}{D}}|x-y|} + e^{-\sqrt{\frac{q}{D}}|x+y|} \right),\end{aligned}$$

where $\theta = \lambda + \mu$.

The Laplace Transform of the survival probability is

$$\begin{aligned}\hat{S}(q) &= \int_{\Omega} (\hat{p}_1(x, q) + \hat{p}_2(x, q)) dx \\ &= \int_0^{\infty} \left(\frac{1}{\sqrt{4Dq}} e^{-\sqrt{\frac{q}{D}}|x-y|} + \frac{\lambda - \mu}{\theta\sqrt{4Dq}} e^{-\sqrt{\frac{q}{D}}|x+y|} - \frac{\lambda}{\theta\sqrt{D}\sqrt{q+\theta}} e^{-\sqrt{\frac{q+\theta}{D}}|x+y|} \right) dx,\end{aligned}$$

and using the integrals

- $\int_0^\infty e^{-|x-y|\frac{\sqrt{q}}{\sqrt{D}}} dx = \frac{\sqrt{4D}}{\sqrt{q}} \left(2 - e^{-y\frac{\sqrt{q}}{\sqrt{D}}} \right)$
- $\int_0^\infty e^{-|x+y|\frac{\sqrt{q}}{\sqrt{D}}} dx = \frac{\sqrt{D}}{\sqrt{q}} e^{-y\frac{\sqrt{q}}{\sqrt{D}}},$

we get,

$$\hat{S}(q) = \frac{1}{q} - \frac{\mu}{\theta} \frac{e^{-y\frac{\sqrt{q}}{\sqrt{D}}}}{q} - \frac{\lambda}{\theta} \frac{e^{-y\frac{\sqrt{q+\theta}}{\sqrt{D}}}}{q+\theta}.$$

The q large expansion leads to the survival probability

$$\hat{S}(q) = \frac{1}{q} - \frac{e^{-y\frac{\sqrt{q}}{\sqrt{D}}}}{q} + \lambda \frac{e^{-y\frac{\sqrt{q}}{\sqrt{D}}}}{q} \left(\frac{1}{q} + \frac{y}{\sqrt{4Dq}} \right) + O\left(\frac{e^{-y\frac{\sqrt{q}}{\sqrt{D}}}}{q^{\frac{5}{2}}} \right). \quad (26)$$

Thus the Inverse Laplace's Transform gives

$$\begin{aligned} S(t) &\approx \mathcal{L}^{-1}\left(\frac{1}{q}\right) - \mathcal{L}^{-1}\left(\frac{e^{-y\frac{\sqrt{q}}{\sqrt{D}}}}{q}\right) \approx 1 - \operatorname{erfc}\left[\frac{y}{\sqrt{4Dt}}\right] \\ &\approx 1 - \frac{e^{-\frac{y^2}{4Dt}} \sqrt{4Dt}}{y\sqrt{\pi}}. \end{aligned} \quad (27)$$

We obtain, thus [5]

$$\begin{aligned} \bar{\tau}^N &= \int_0^\infty [S(t)]^N dt \approx \int_0^\infty \exp\left\{\log\left\{1 - e^{-\frac{y^2}{4Dt}} \frac{\sqrt{4Dt}}{y\sqrt{\pi}}\right\}^N\right\} dt \\ &\approx \frac{y^2}{4D \cdot \log\left(\frac{N}{\sqrt{\pi}}\right)}. \end{aligned} \quad (28)$$

We conclude that the fastest arriving particle does not switch between states, but escape in state 1, avoiding to change state.

3.2.2. *Particles start in state 1 and the diffusion coefficients satisfy $D_1 \neq D_2$*

When the diffusion coefficients differ for each state, we will use the Laplace's transform on the solutions of system (9, 10), which will be given by (23) and (22). To compute the

Laplace transform of the survival probability, we start with

$$\begin{aligned}
\hat{S}(q) &= \int_0^\infty (\hat{p}_1(x, q) + \hat{p}_2(x, q)) dx \\
&= \frac{(\mu + q - D_2 w_2^2)}{2D_1 D_2 w_2 (w_2^2 - w_4^2)} \int_0^\infty (e^{w_2|x-y|} - e^{w_2|x+y|}) dx \\
&+ \frac{(\mu + q - D_2 w_4^2)}{2D_1 D_2 w_4 (w_4^2 - w_2^2)} \int_0^\infty (e^{w_4|x-y|} - e^{w_4|x+y|}) dx \\
&+ \frac{\lambda}{2D_1 D_2 w_2 (w_2^2 - w_4^2)} \int_0^\infty (e^{w_2|x-y|} + e^{w_2|x+y|}) dx \\
&+ \frac{\lambda}{2D_1 D_2 w_4 (w_4^2 - w_2^2)} \int_0^\infty (e^{w_4|x-y|} + e^{w_4|x+y|}) dx \\
&= -\frac{(\mu + q - D_2 w_2^2)}{D_1 D_2 w_2^2 (w_2^2 - w_4^2)} (1 - e^{w_2 y}) - \frac{(\mu + q - D_2 w_4^2)}{D_1 D_2 w_4^2 (w_4^2 - w_2^2)} (1 - e^{w_4 y}) \\
&- \frac{\lambda}{D_1 D_2 w_2^2 (w_2^2 - w_4^2)} - \frac{\lambda}{D_1 D_2 w_4^2 (w_4^2 - w_2^2)} \\
&= \frac{1}{q} + T_1(q) - T_2(q), \tag{29}
\end{aligned}$$

where w_2 and w_4 are given by formula (24) and

$$T_1(q) = \frac{\mu + q - D_2 w_2^2}{D_1 D_2 w_2^2 (w_2^2 - w_4^2)} e^{w_2 y}, \quad T_2(q) = \frac{\mu + q - D_2 w_4^2}{D_1 D_2 w_4^2 (w_4^2 - w_2^2)} e^{w_4 y}. \tag{30}$$

Using the notations $\alpha = \frac{\lambda}{D_1} + \frac{\mu}{D_2}$, $\beta = \frac{1}{D_1} - \frac{1}{D_2}$, $\gamma = \frac{\lambda}{D_1} - \frac{\mu}{D_2}$ and $\eta = \frac{1}{D_1} + \frac{1}{D_2}$, we can rewrite $T_1(q)$ and $T_2(q)$ as

$$\begin{aligned}
T_1(q) &= -\frac{1}{D_1 \beta q} \exp \left\{ -\sqrt{\frac{\eta q}{2}} y \sqrt{1 + \frac{\alpha \beta}{\beta \eta q} + \frac{\beta}{\eta} \text{sign}(\beta)} \sqrt{1 + \frac{2\gamma}{\beta q} + \frac{\alpha^2}{\beta^2 q^2}} \right. \\
&+ \ln \left(1 + \frac{\gamma}{\beta q} + \text{sign}(\beta) \sqrt{1 + \frac{2\gamma}{\beta q} + \frac{\alpha^2}{\beta^2 q^2}} \right) \\
&\left. - \ln \left(1 + \frac{2\gamma}{\beta q} + \frac{\alpha^2}{\beta^2 q^2} + \left(\frac{\eta}{\beta} + \frac{\alpha}{\beta q} \right) \text{sign}(\beta) \sqrt{1 + \frac{2\gamma}{\beta q} + \frac{\alpha^2}{\beta^2 q^2}} \right) \right\}, \\
T_2(q) &= \frac{1}{D_1 \beta q} \exp \left\{ -\sqrt{\frac{\eta q}{2}} y \sqrt{1 + \frac{\alpha \beta}{\beta \eta q} - \frac{\beta}{\eta} \text{sign}(\beta)} \sqrt{1 + \frac{2\gamma}{\beta q} + \frac{\alpha^2}{\beta^2 q^2}} \right. \\
&+ \ln \left(1 + \frac{\gamma}{\beta q} - \text{sign}(\beta) \sqrt{1 + \frac{2\gamma}{\beta q} + \frac{\alpha^2}{\beta^2 q^2}} \right) \\
&\left. - \ln \left(1 + \frac{2\gamma}{\beta q} + \frac{\alpha^2}{\beta^2 q^2} - \left(\frac{\eta}{\beta} + \frac{\alpha}{\beta q} \right) \text{sign}(\beta) \sqrt{1 + \frac{2\gamma}{\beta q} + \frac{\alpha^2}{\beta^2 q^2}} \right) \right\}.
\end{aligned}$$

Expanding $T_1(q)$ and $T_2(q)$ for q large, we have

$$\begin{aligned} \hat{S}(q) &= \frac{1}{q} - \frac{1}{D_1 q} \cdot \frac{\text{sign}(\beta) + 1}{\beta + \eta \cdot \text{sign}(\beta)} \exp \left\{ -\sqrt{\frac{(\eta + \beta \text{sign}(\beta))q}{2}} y \right\} \\ &\quad - \frac{1}{D_1 q} \cdot \frac{\text{sign}(\beta) - 1}{\eta \cdot \text{sign}(\beta) - \beta} \exp \left\{ -\sqrt{\frac{(\eta - \beta \text{sign}(\beta))q}{2}} y \right\} \\ &\quad + \frac{(1 + \text{sign}(\beta)) \left(1 + \frac{1}{2} \sqrt{\frac{(\eta + \beta \text{sign}(\beta))q}{2}} y \right) (\alpha + \gamma \cdot \text{sign}(\beta))}{D_1 (\eta + \beta \text{sign}(\beta)) (\beta + \eta \cdot \text{sign}(\beta)) q^2} \exp \left\{ -\sqrt{\frac{(\eta + \beta \text{sign}(\beta))q}{2}} y \right\} \\ &\quad + \frac{(\text{sign}(\beta) - 1) \left(1 + \frac{1}{2} \sqrt{\frac{(\eta - \beta \text{sign}(\beta))q}{2}} y \right) (\alpha - \gamma \cdot \text{sign}(\beta))}{D_1 (\beta \text{sign}(\beta) - \eta) (\beta - \eta \cdot \text{sign}(\beta)) q^2} \exp \left\{ -\sqrt{\frac{(\eta - \beta \text{sign}(\beta))q}{2}} y \right\} \\ &\quad + O \left(\frac{\exp \left\{ -\sqrt{\frac{(\eta + \beta \text{sign}(\beta))q}{2}} y \right\} + \exp \left\{ -\sqrt{\frac{(\eta - \beta \text{sign}(\beta))q}{2}} y \right\}}{q^2} \right), \end{aligned}$$

and for both cases, $\text{sign}(\beta) = 1$ or $\text{sign}(\beta) = -1$, we have,

$$\hat{S}(q) \approx \frac{1}{q} - \frac{e^{-y\sqrt{\frac{q}{D_1}}}}{q} + \lambda \frac{e^{-y\frac{\sqrt{q}}{\sqrt{D_1}}}}{q} \left(\frac{1}{q} + \frac{y}{\sqrt{4D_1 q}} \right) + O \left(\frac{e^{-y\frac{\sqrt{q}}{\sqrt{D_1}}}}{q^{\frac{5}{2}}} \right). \quad (31)$$

This is,

$$\begin{aligned} S(t) &\approx \mathcal{L}^{-1} \left(\frac{1}{q} \right) - \mathcal{L}^{-1} \left(\frac{e^{-y\frac{\sqrt{q}}{\sqrt{D_1}}}}{q} \right) \approx 1 - \text{erfc} \left[\frac{y}{\sqrt{4D_1 t}} \right] \\ &\approx 1 - \frac{e^{-\frac{y^2}{4D_1 t}} \sqrt{4D_1 t}}{y\sqrt{\pi}}. \end{aligned} \quad (32)$$

To conclude, we obtain the same result as the case where the particles have the same diffusion coefficient (expansion (26) for $D_1 = D_2$). Finally, we obtain for the mean time of the fastest the formula

$$\begin{aligned} \bar{\tau}^N &= \int_0^\infty [S(t)]^N dt \approx \int_0^\infty \exp \left\{ \log \left\{ 1 - e^{-\frac{y^2}{4D_1 t}} \frac{\sqrt{4D_1 t}}{y\sqrt{\pi}} \right\}^N \right\} dt \\ &\approx \frac{y^2}{4D_1 \cdot \log \left(\frac{N}{\sqrt{\pi}} \right)}. \end{aligned} \quad (33)$$

3.3. Particles start in state 2

We start with the system (4) for which the boundary conditions are given by (5) and the initial conditions by (8):

$$\begin{aligned} p_1(x, 0) &= 0 \\ p_2(x, 0) &= \delta(x - y). \end{aligned}$$

The particles start in state 2 at point $y > 0$. To determine the distribution of arrival time, we use Laplace's Transform in time to get

$$D_1 \hat{p}_1''(x, q) - (\lambda + q) \hat{p}_1(x, q) + \mu \hat{p}_2(x, q) = 0 \quad (34)$$

$$D_2 \hat{p}_2''(x, q) - (\mu + q) \hat{p}_2(x, q) + \lambda \hat{p}_1(x, q) + \delta(x - y) = 0. \quad (35)$$

From equation (34) we have a relation between $\hat{p}_2(x, q)$ and $\hat{p}_1(x, q)$

$$\hat{p}_2(x, q) = \frac{q + \lambda}{\mu} \hat{p}_1(x, q) - \frac{D_1}{\mu} \hat{p}_1''(x, q),$$

and replacing this in the system we get

$$\hat{p}_1^{(iv)} - \left[\frac{q + \lambda}{D_1} + \frac{q + \mu}{D_2} \right] \hat{p}_1'' + \left[\frac{(q + \lambda)(q + \mu) - \lambda\mu}{D_1 D_2} \right] \hat{p}_1 = \frac{\mu}{D_1 D_2} \delta_y. \quad (36)$$

This equation has the same homogeneous part as equation (19), thus we need to impose

$$2Aw_1^3 + 2Bw_2^3 + 2Cw_3^3 + 2Dw_4^3 = \frac{\mu}{D_1 D_2},$$

for have the solution in the sense of Distributions, where w_i with $i = \overline{1, 4}$, are the roots of equation (24). Also, all derivatives until second order must be continuous, then

$$2Aw_1 + 2Bw_2 + 2Cw_3 + 2Dw_4 = 0.$$

Since the solution is bounded, we obtain that $A = C = 0$, and this leads to a solution in the form

$$\hat{p}_1(x, q) = \frac{\mu}{2D_1 D_2 w_2 (w_2^2 - w_4^2)} \cdot e^{w_2|x-y|} + \frac{\mu}{2D_1 D_2 w_4 (w_4^2 - w_2^2)} \cdot e^{w_4|x-y|}.$$

Finally, the boundary conditions imposes that

$$\begin{aligned} \hat{p}_1(x, q) &= \frac{\mu}{2D_1 D_2 w_2 (w_2^2 - w_4^2)} \cdot \left(e^{w_2|x-y|} - e^{w_2|x+y|} \right) \\ &+ \frac{\mu}{2D_1 D_2 w_4 (w_4^2 - w_2^2)} \cdot \left(e^{w_4|x-y|} - e^{w_4|x+y|} \right). \end{aligned} \quad (37)$$

Then, from relation (34) we obtain

$$\begin{aligned} \hat{p}_2(x, q) &= \frac{(\lambda + q - D_1 w_2^2)}{2D_1 D_2 w_2 (w_2^2 - w_4^2)} \cdot \left(e^{w_2|x-y|} + e^{w_2|x+y|} \right) \\ &+ \frac{(\lambda + q - D_1 w_4^2)}{2D_1 D_2 w_4 (w_4^2 - w_2^2)} \cdot \left(e^{w_4|x-y|} + e^{w_4|x+y|} \right). \end{aligned} \quad (38)$$

We shall apply then, the inverse Laplace's Transform to recover the solution for short-time asymptotics.

3.4. Solution when the particle start in state 2 for $D_1 = D_2 = D$.

In this case we have the same roots in the form (25) and the solutions

$$\begin{aligned}\hat{p}_1(x, q) &= \frac{\mu}{\theta\sqrt{4Dq}} \left(e^{-\sqrt{\frac{q}{D}}|x-y|} - e^{-\sqrt{\frac{q}{D}}|x+y|} \right) \\ &\quad - \frac{\mu}{\theta\sqrt{4D}\sqrt{q+\theta}} \left(e^{-\sqrt{\frac{q+\theta}{D}}|x-y|} - e^{-\sqrt{\frac{q+\theta}{D}}|x+y|} \right), \\ \hat{p}_2(x, q) &= \frac{\mu}{\theta\sqrt{4D}\sqrt{q+\theta}} \left(e^{-\sqrt{\frac{q+\theta}{D}}|x-y|} + e^{-\sqrt{\frac{q+\theta}{D}}|x+y|} \right) \\ &\quad + \frac{\lambda}{\theta\sqrt{4Dq}} \left(e^{-\sqrt{\frac{q}{D}}|x-y|} + e^{-\sqrt{\frac{q}{D}}|x+y|} \right).\end{aligned}$$

The Laplace transform of the survival probability is

$$\begin{aligned}\hat{S}(q) &= \int_{\Omega} (\hat{p}_1(x, q) + \hat{p}_2(x, q)) dx \\ &= \int_0^{\infty} \left(\frac{1}{\sqrt{4Dq}} e^{-\sqrt{\frac{q}{D}}|x-y|} + \frac{\lambda-\mu}{\theta\sqrt{4Dq}} e^{-\sqrt{\frac{q}{D}}|x+y|} + \frac{2\mu}{\theta\sqrt{4D}\sqrt{q+\theta}} e^{-\sqrt{\frac{q+\theta}{D}}|x+y|} \right) dx,\end{aligned}$$

and this leads to

$$\hat{S}(q) = \frac{1}{q} - \frac{\mu}{\lambda+\mu} \frac{e^{-y\sqrt{\frac{q}{D}}}}{q} + \frac{\mu}{\lambda+\mu} \frac{e^{-y\sqrt{\frac{q+\theta}{D}}}}{q+\theta}.$$

Making the expansion for q large, we obtain

$$\begin{aligned}\hat{S}(q) &= \frac{1}{q} - \mu \frac{e^{-y\sqrt{\frac{q}{D}}}}{q} \left(\frac{1}{q} + \frac{y}{\sqrt{4Dq}} \right) \\ &\quad + \frac{\mu\theta}{8Dq^3} e^{-y\sqrt{\frac{q}{D}}} \left(qy^2 + D \left(8 + 5\sqrt{\frac{q}{D}}y \right) \right) + O \left(\frac{e^{-y\sqrt{\frac{q}{D}}}}{q^3} \right).\end{aligned}\quad (39)$$

Applying the inverse Laplace's Transform, we have

$$\begin{aligned}S(t) &\approx \mathcal{L}^{-1} \left(\frac{1}{q} \right) - \mu \mathcal{L}^{-1} \left(\frac{e^{-y\sqrt{\frac{q}{D}}}}{2q^2} + y \frac{e^{-y\sqrt{\frac{q}{D}}}}{\sqrt{4Dqq}} \right) \approx 1 - \mu t \cdot \operatorname{erfc} \left[\frac{y}{\sqrt{4Dt}} \right] \\ &\approx 1 - \mu t \frac{e^{-\frac{y^2}{4Dt}} \sqrt{4Dt}}{y\sqrt{\pi}}.\end{aligned}\quad (40)$$

Considering the second order term in the expansion, we have

$$S(t) \approx 1 - \mu t \left(1 - \frac{(\lambda+\mu)}{2} t \right) \frac{e^{-\frac{y^2}{4Dt}} \sqrt{4Dt}}{y\sqrt{\pi}}.$$

Thus, using the asymptotic computation of [5], we obtain

$$\begin{aligned}\bar{\tau}^N &= \int_0^{\infty} [S(t)]^N dt \approx \int_0^{\infty} \exp \left\{ \log \left\{ 1 - \mu t \cdot e^{-\frac{y^2}{4Dt}} \frac{\sqrt{4Dt}}{y\sqrt{\pi}} \right\}^N \right\} dt \\ &\approx \frac{y^2}{4D \cdot \log \left(\frac{N}{\sqrt{\pi}} \cdot \mu \frac{y^2}{4D} \right)}.\end{aligned}\quad (41)$$

To conclude, this result shows that the fastest particle switch only once before escape.

3.5. Particles start in state 2 with $D_1 \neq D_2$

When the two diffusion coefficients are different, the general solution of system (35, 34) is given by equations (37) and (38). Laplace's transform of the survival probability leads to

$$\begin{aligned}
\hat{S}(q) &= \int_0^\infty (\hat{p}_1(x, q) + \hat{p}_2(x, q)) dx \\
&= \frac{\mu}{2D_1D_2w_2(w_2^2 - w_4^2)} \int_0^\infty (e^{w_2|x-y|} - e^{w_2|x+y|}) dx \\
&+ \frac{\mu}{2D_1D_2w_4(w_4^2 - w_2^2)} \int_0^\infty (e^{w_4|x-y|} - e^{w_4|x+y|}) dx \\
&+ \frac{\lambda + q - D_1w_2^2}{2D_1D_2w_2(w_2^2 - w_4^2)} \int_0^\infty (e^{w_2|x-y|} + e^{w_2|x+y|}) dx \\
&+ \frac{\lambda + q - D_1w_4^2}{2D_1D_2w_4(w_4^2 - w_2^2)} \int_0^\infty (e^{w_4|x-y|} + e^{w_4|x+y|}) dx \\
&= -\frac{\mu}{D_1D_2w_2^2(w_2^2 - w_4^2)} (1 - e^{w_2y}) - \frac{\mu}{D_1D_2w_4^2(w_4^2 - w_2^2)} (1 - e^{w_4y}) \\
&- \frac{\lambda + q - D_1w_2^2}{D_1D_2w_2^2(w_2^2 - w_4^2)} - \frac{\lambda + q - D_1w_4^2}{D_1D_2w_4^2(w_4^2 - w_2^2)} \\
&= \frac{1}{q} + T_3(q) - T_4(q),
\end{aligned}$$

where w_2 and w_4 are given by the formula (24), and

$$T_3(q) = \frac{\mu}{D_1D_2w_2^2(w_2^2 - w_4^2)} e^{w_2y}, \quad T_4(q) = \frac{\mu}{D_1D_2w_4^2(w_4^2 - w_2^2)} e^{w_4y}. \quad (42)$$

Rewriting $\alpha = \frac{\lambda}{D_1} + \frac{\mu}{D_2}$, $\beta = \frac{1}{D_1} - \frac{1}{D_2}$, $\gamma = \frac{\lambda}{D_1} - \frac{\mu}{D_2}$ and $\eta = \frac{1}{D_1} + \frac{1}{D_2}$, and working in $T_3(q)$ and $T_4(q)$, we obtain

$$\begin{aligned}
T_3(q) &= \frac{2\mu}{D_1D_2\beta^2q^2} \exp \left\{ -\sqrt{\frac{\eta q}{2}} y \sqrt{1 + \frac{\alpha\beta}{\beta\eta q} + \frac{\beta}{\eta} \text{sign}(\beta) \sqrt{1 + \frac{2\gamma}{\beta q} + \frac{\alpha^2}{\beta^2q^2}}} \right. \\
&\quad \left. - \ln \left(1 + \frac{2\gamma}{\beta q} + \frac{\alpha^2}{\beta^2q^2} + \left(\frac{\eta}{\beta} + \frac{\alpha}{\beta q} \right) \text{sign}(\beta) \sqrt{1 + \frac{2\gamma}{\beta q} + \frac{\alpha^2}{\beta^2q^2}} \right) \right\}, \\
T_4(q) &= \frac{2\mu}{D_1D_2\beta^2q^2} \exp \left\{ -\sqrt{\frac{\eta q}{2}} y \sqrt{1 + \frac{\alpha\beta}{\beta\eta q} - \frac{\beta}{\eta} \text{sign}(\beta) \sqrt{1 + \frac{2\gamma}{\beta q} + \frac{\alpha^2}{\beta^2q^2}}} \right. \\
&\quad \left. - \ln \left(1 + \frac{2\gamma}{\beta q} + \frac{\alpha^2}{\beta^2q^2} - \left(\frac{\eta}{\beta} + \frac{\alpha}{\beta q} \right) \text{sign}(\beta) \sqrt{1 + \frac{2\gamma}{\beta q} + \frac{\alpha^2}{\beta^2q^2}} \right) \right\}.
\end{aligned}$$

Expanding $T_3(q)$ and $T_4(q)$ for q large, we obtain for the survival probability

$$\begin{aligned}
\hat{S}(q) &= \frac{1}{q} - \frac{D_2\mu}{D_2 - D_1} \frac{\exp \left\{ -\sqrt{\frac{q}{D_2}} y \right\}}{q^2} + \frac{D_1\mu}{D_2 - D_1} \frac{\exp \left\{ -\sqrt{\frac{q}{D_1}} y \right\}}{q^2} \\
&+ O \left(\frac{\exp \left\{ -\sqrt{\frac{q}{D_1}} y \right\}}{q^{\frac{5}{2}}} + \frac{\exp \left\{ -\sqrt{\frac{q}{D_2}} y \right\}}{q^{\frac{5}{2}}} \right), \quad (43)
\end{aligned}$$

when $\text{sign}(\beta) = 1$ ($D_2 > D_1$). Expression (43) contains two exponentially small terms, making the inversion difficult. In the limit D_1 close to D_2 , we use the expansion $D_2 = D_1(1 + \varepsilon)$ and studying the limit when ε goes to zero in equation (43). We have

$$\hat{S}_\varepsilon(q) \approx \frac{1}{q} - \frac{\mu}{q^2} \left[\exp \left\{ -\sqrt{\frac{q}{D_1(1+\varepsilon)}} y \right\} + \frac{\exp \left\{ -\sqrt{\frac{q}{D_1(1+\varepsilon)}} y \right\} - \exp \left\{ -\sqrt{\frac{q}{D_1}} y \right\}}{\varepsilon} \right].$$

A Taylor expansion in ε and εq leads to

$$\hat{S}_\varepsilon(q) = \frac{1}{q} - \frac{\mu}{q^2} \exp \left\{ -\sqrt{\frac{q}{D_1}} y \right\} \left[1 + \sqrt{\frac{q}{4D_1}} y \right] + O(\varepsilon) + O(\varepsilon q).$$

When $\varepsilon \rightarrow 0$, the survival probability $\hat{S}_\varepsilon(q)$ converges to $\hat{S}_0(q)$ corresponding to the solution for $D_1 = D_2$, defined by equation (40). However, the convergence is not uniform in t in the interval $[0, \infty[$, preventing us to use this expansion to estimate the MFAT for this case. Thus to leading order, using that

$$\lim_{D_2 \rightarrow D_1} \text{Pr} \{t_1 > t\} \approx 1 - \mu t \frac{e^{-\frac{y^2}{4D_1 t}} \sqrt{4D_1 t}}{y\sqrt{\pi}},$$

we obtain the asymptotic formula for $N \gg 1$

$$\begin{aligned} \bar{\tau}_\varepsilon^N &= \int_0^\infty [S(t)]^N dt \approx \int_0^\infty \exp \left\{ \log \left\{ 1 - \mu \frac{e^{-\frac{y^2}{4D_1 t}} \sqrt{4D_1 t}}{y\sqrt{\pi}} \right\}^N \right\} dt \\ &\approx \frac{y^2}{4D_1 \cdot \log \left(\frac{N}{\sqrt{\pi}} \cdot \mu \frac{y^2}{4D_1} \right) + A_\varepsilon}, \end{aligned} \quad (44)$$

where $A_\varepsilon = A_0 + \varepsilon A_1 + \dots$, and A_k are constants. To conclude, to leading order in ε , the MFAT for the case when $D_1 \neq D_2$ is similar to the case $D_1 = D_2$.

When $\text{sign}(\beta) = -1$ (when $D_1 > D_2$), we obtain a similar expansion with the Laplace's transform of the survival probability

$$\begin{aligned} \hat{S}(q) &= \frac{1}{q} - \frac{D_1 \mu}{D_1 - D_2} \frac{\exp \left\{ -\sqrt{\frac{q}{D_1}} y \right\}}{q^2} + \frac{D_2 \mu}{D_1 - D_2} \frac{\exp \left\{ -\sqrt{\frac{q}{D_2}} y \right\}}{q^2} \\ &+ \frac{\mu^2 y \sqrt{D_1}}{2(D_1 - D_2)} \frac{\exp \left\{ -\sqrt{\frac{q}{D_1}} y \right\}}{q^{\frac{5}{2}}} - \frac{\mu^2 y \sqrt{D_2}}{2(D_1 - D_2)} \frac{\exp \left\{ -\sqrt{\frac{q}{D_2}} y \right\}}{q^{\frac{5}{2}}} \\ &+ \frac{\mu D_1^2}{(D_1 - D_2)} \left(\frac{\mu}{D_1 D_2} + \frac{\lambda}{D_1 D_2} - \frac{2\lambda}{D_1^2} \right) \frac{\exp \left\{ -\sqrt{\frac{q}{D_1}} y \right\}}{q^3} \\ &- \frac{\mu D_2^2}{(D_1 - D_2)} \left(\frac{\mu}{D_1 D_2} + \frac{\lambda}{D_1 D_2} - \frac{2\mu}{D_2^2} \right) \frac{\exp \left\{ -\sqrt{\frac{q}{D_2}} y \right\}}{q^3} \\ &+ O \left(\frac{\exp \left\{ -\sqrt{\frac{q}{D_1}} y \right\}}{q^3} + \frac{\exp \left\{ -\sqrt{\frac{q}{D_2}} y \right\}}{q^3} \right). \end{aligned} \quad (45)$$

The expression (45) also contains two exponentially small terms. It is however possible to recover the case when $D_1 = D_2$, as we studied previously, by making the expansion

$D_1 = D_2(1 + \varepsilon)$ and studying the limit when ε goes to zero in equation (45). In that case, we have

$$\hat{S}(q) \approx \frac{1}{q} - \frac{\mu}{q^2} \left[\exp \left\{ -\sqrt{\frac{q}{D_2(1+\varepsilon)}} y \right\} + \frac{\exp \left\{ -\sqrt{\frac{q}{D_2(1+\varepsilon)}} y \right\} - \exp \left\{ -\sqrt{\frac{q}{D_2}} y \right\}}{\varepsilon} \right].$$

A Taylor expansion in ε and εq leads to

$$\hat{S}_\varepsilon(q) = \frac{1}{q} - \frac{\mu}{q^2} \exp \left\{ -\sqrt{\frac{q}{D_2}} y \right\} \left[1 + \sqrt{\frac{q}{4D_2}} y \right] + O(\varepsilon) + O(\varepsilon q).$$

When $\varepsilon \rightarrow 0$, the survival probability $\hat{S}_\varepsilon(q)$ converges to $\hat{S}_0(q)$ (equation (40)) corresponding to the solution for $D_1 = D_2$. Thus, working as we did before, we have the limit

$$\lim_{D_1 \rightarrow D_2} Pr \{t_1 > t\} \approx 1 - \mu \frac{e^{-\frac{y^2}{4D_2 t}} \sqrt{4D_2 t}}{y\sqrt{\pi}}.$$

Thus to leading order, we obtain the asymptotic formula when the number of particle is large $N \gg 1$ [?]

$$\begin{aligned} \bar{\tau}_\varepsilon^N &= \int_0^\infty [S(t)]^N dt \approx \int_0^\infty \exp \left\{ \log \left\{ 1 - \mu \frac{e^{-\frac{y^2}{4D_2 t}} \sqrt{4D_2 t}}{y\sqrt{\pi}} \right\}^N \right\} dt \\ &\approx \frac{y^2}{4D_2 \cdot \log \left(\frac{N}{\sqrt{\pi}} \cdot \mu \frac{y^2}{4D_2} \right) + A_\varepsilon}, \end{aligned} \quad (46)$$

where we have used the expansion $A_\varepsilon = A_0 + \varepsilon A_1 + \dots$, and A_k are constants. To conclude, we obtain an asymptotic formula for the MFAT when D_1 is close to D_2 , showing that it depends on the diffusion coefficient D_1 and the switching rate μ .

4. PARTICLES ARE INITIALLY UNIFORMLY DISTRIBUTED IN AN INTERVAL

We now consider equation (4) in the domain $\Omega = [0, +\infty)$ with the boundary condition (5), and a uniform initial distribution in the interval $[0, y_0]$. When particles start in state 1, the initial condition is

$$\begin{aligned} p_1(x, 0) &= \frac{1}{y_0} \mathbb{I}_{\{x \in [0, y_0]\}} \\ p_2(x, 0) &= 0, \end{aligned} \quad (47)$$

and

$$\begin{aligned} p_1(x, 0) &= 0 \\ p_2(x, 0) &= \frac{1}{y_0} \mathbb{I}_{\{x \in [0, y_0]\}}. \end{aligned} \quad (48)$$

when they start in state 2. We impose the normalization condition

$$\int_0^\infty p_1(x, 0) + p_2(x, 0) dx = 1.$$

4.1. Particles start in state 1

This system (19) is now linear with the indicator function as a non-homogeneous term

$$\hat{p}_2^{(iv)} - \left[\frac{\lambda + q}{D_1} + \frac{\mu + q}{D_2} \right] \hat{p}_2'' + \left[\frac{(\lambda + q)(\mu + q) - \lambda\mu}{D_1 D_2} \right] \hat{p}_2 = \frac{\lambda}{y_0 D_1 D_2} \mathbb{I}_{\{x \in [0, y_0]\}}. \quad (49)$$

The solution of equation (49) is obtained by the convolution between the non-homogeneous function and the solution obtained with the Dirac-delta function. When $D_1 = D_2 = D$, from expansion (26), we get for the survival probability,

$$\hat{S}(q) \approx \frac{1}{y_0} \int_0^{y_0} \left(\frac{1}{q} - \frac{e^{-y\sqrt{\frac{q}{D}}}}{q} \right) dy \approx \frac{1}{q} - \frac{\sqrt{D}}{y_0 q^{\frac{3}{2}}} \left(1 - e^{-y_0 \sqrt{\frac{q}{D}}} \right) \approx \frac{1}{q} - \frac{\sqrt{D}}{y_0 q^{\frac{3}{2}}}.$$

The inverse Laplace leads to the short-time asymptotic,

$$S(t) \approx 1 - \frac{\sqrt{4Dt}}{y_0 \sqrt{\pi}}, \quad (50)$$

and

$$\begin{aligned} \bar{\tau}^N &= \int_0^\infty [S(t)]^N dt \approx \int_0^\infty \exp \left\{ \log \left\{ 1 - \frac{\sqrt{4Dt}}{y_0 \sqrt{\pi}} \right\}^N \right\} dt \\ &\approx \frac{y_0^2 \pi}{2DN^2}. \end{aligned} \quad (51)$$

When $D_1 \neq D_2$, we obtain from (29, 30) the Laplace's Transform of the survival probability given by the formula

$$\begin{aligned} \hat{S}(q) &= \frac{1}{y_0} \int_0^{y_0} \left(\frac{1}{q} + \frac{(q + \mu - D_2 w_2^2) e^{w_2 y}}{D_1 D_2 w_2^2 (w_2^2 - w_4^2)} - \frac{(q + \mu - D_2 w_4^2) e^{w_4 y}}{D_1 D_2 w_4^2 (w_2^2 - w_4^2)} \right) dy \\ &= \frac{1}{q} - \frac{(q + \mu - D_2 w_2^2)}{y_0 D_1 D_2 w_2^3 (w_2^2 - w_4^2)} + \frac{(q + \mu - D_2 w_4^2)}{D_1 D_2 w_4^3 (w_2^2 - w_4^2)} \\ &\quad + \frac{(q + \mu - D_2 w_2^2) e^{w_2 y_0}}{D_1 D_2 w_2^3 (w_2^2 - w_4^2)} - \frac{(q + \mu - D_2 w_4^2) e^{w_4 y_0}}{D_1 D_2 w_4^3 (w_2^2 - w_4^2)}, \end{aligned}$$

and for q large, the leading order comes from the term

$$\hat{S}(q) \approx \frac{1}{q} - \frac{(q + \mu - D_2 w_2^2)}{y_0 D_1 D_2 w_2^3 (w_2^2 - w_4^2)} + \frac{(q + \mu - D_2 w_4^2)}{D_1 D_2 w_4^3 (w_2^2 - w_4^2)},$$

due to the exponentially decaying terms. Using the notation $T_5(q) = -\frac{(q + \mu - D_2 w_2^2)}{y_0 D_1 D_2 w_2^3 (w_2^2 - w_4^2)}$ and

$T_6(q) = \frac{(q + \mu - D_2 w_4^2)}{D_1 D_2 w_4^3 (w_2^2 - w_4^2)}$, and the expansion for q large, we have

$$\begin{aligned} T_5(q) &\approx -\frac{\sqrt{2}}{y_0 D_1} \frac{1 + \text{sign}(\beta)}{\left(\sqrt{\beta \cdot \text{sign}(\beta)} + \eta \right)^3} q^{\frac{3}{2}}, \\ T_6(q) &\approx \frac{\sqrt{2}}{y_0 D_1} \frac{\text{sign}(\beta) - 1}{\left(\sqrt{\eta - \beta \cdot \text{sign}(\beta)} \right)^3} q^{\frac{3}{2}}. \end{aligned}$$

In both cases, when $\text{sign}(\beta) = 1$ or $\text{sign}(\beta) = -1$, we obtain

$$\hat{S}(q) \approx \frac{1}{q} - \frac{\sqrt{D_1}}{y_0 q^{\frac{3}{2}}},$$

leading to an expansion for the survival probability

$$S(t) \approx 1 - \frac{\sqrt{4D_1 t}}{y_0 \sqrt{\pi}}, \quad (52)$$

and the asymptotic formula for the MFAT

$$\begin{aligned} \bar{\tau}^N &= \int_0^\infty [S(t)]^N dt \approx \int_0^\infty \exp \left\{ \log \left\{ 1 - \frac{\sqrt{4D_1 t}}{y_0 \sqrt{\pi}} \right\}^N \right\} dt \\ &\approx \frac{y_0^2 \pi}{2D_1 N^2}. \end{aligned} \quad (53)$$

4.2. Particles start in state 2

When we have the condition $D_1 = D_2$, the Laplace's transform of the survival probability is given by the formula

$$\begin{aligned} \hat{S}(q) &\approx \frac{1}{y_0} \int_0^{y_0} \left(\frac{1}{q} - \frac{\mu e^{-y\sqrt{\frac{q}{D}}}}{q} \left(\frac{1}{q} + \frac{y}{\sqrt{4Dq}} \right) \right) dy \\ &\approx \frac{1}{q} - \frac{3\mu\sqrt{D}}{2y_0 q^{\frac{5}{2}}}. \end{aligned} \quad (54)$$

Thus, we have to leading order the formula

$$\begin{aligned} \bar{\tau}^N &= \int_0^\infty [S(t)]^N dt \approx \int_0^\infty \exp \left\{ \log \left\{ 1 - \frac{\mu t \sqrt{4D_1 t}}{y_0 \sqrt{\pi}} \right\}^N \right\} dt \\ &\approx \left(\frac{\sqrt{\pi} y_0}{\mu \sqrt{4DN}} \right)^{\frac{2}{3}} \Gamma \left(\frac{5}{3} \right). \end{aligned} \quad (55)$$

where Γ is the Gamma function. When $D_1 \neq D_2$, the Laplace's transform applied to the survival probability is given by the convolution

$$\begin{aligned} \hat{S}(q) &= \frac{1}{y_0} \int_0^{y_0} \left[\frac{1}{q} + \frac{\mu e^{w_2 y}}{D_1 D_2 w_2^2 (w_2^2 - w_4^2)} - \frac{\mu e^{w_4 y}}{D_1 D_2 w_4^2 (w_2^2 - w_4^2)} \right] dy \\ &\approx \frac{1}{q} - \frac{\mu}{y_0 D_1 D_2 w_2^3 (w_2^2 - w_4^2)} + \frac{\mu}{y_0 D_1 D_2 w_4^3 (w_2^2 - w_4^2)} \\ &= \frac{1}{q} + T_7(q) + T_8(q), \end{aligned}$$

where $T_7(q) = -\frac{\mu}{y_0 D_1 D_2 w_2^3 (w_2^2 - w_4^2)}$ and $T_8(q) = \frac{\mu}{y_0 D_1 D_2 w_4^3 (w_2^2 - w_4^2)}$. Using the expansion for q large in $T_7(q)$ and $T_8(q)$, we obtain

$$T_7(q) \approx \frac{2\sqrt{2}\mu}{y_0 D_1 D_2 |\beta| (\eta + |\beta|)^{\frac{3}{2}} q^{\frac{5}{2}}}, \quad \text{and} \quad T_8(q) \approx \frac{2\sqrt{2}\mu}{y_0 D_1 D_2 |\beta| (\eta - |\beta|)^{\frac{3}{2}} q^{\frac{5}{2}}},$$

with β, η defined as in the section 3.3.5.

When $\beta > 0$, we get

$$\hat{S}(q) = \frac{1}{q} - \frac{\mu D_2^{\frac{3}{2}}}{y_0(D_2 - D_1)q^{\frac{5}{2}}} + \frac{\mu D_1^{\frac{3}{2}}}{y_0(D_2 - D_1)q^{\frac{5}{2}}}. \quad (56)$$

In the limit $D_2 = D_1(1 + \varepsilon)$, an expansion in ε leads to

$$\begin{aligned} \hat{S}_\varepsilon(q) &\approx \frac{1}{q} - \frac{\mu}{y_0 q^{\frac{5}{2}}} \frac{D_1^{\frac{3}{2}}(1 + \varepsilon)^{\frac{3}{2}} - D_1^{\frac{3}{2}}}{D_1 \varepsilon} \\ &\approx \frac{1}{q} - \frac{3\mu\sqrt{D_1}}{2y_0 q^{\frac{5}{2}}} - \frac{\mu\sqrt{D_1}}{y_0 q^{\frac{5}{2}}} \left(\sum_{n=1}^{\infty} \binom{\frac{3}{2}}{n+1} \varepsilon^n \right). \end{aligned} \quad (57)$$

When $\varepsilon \rightarrow 0$, the survival probability $\hat{S}_\varepsilon(q)$ converges to $\hat{S}_0(q)$ corresponding to the solution when $D_1 = D_2$, given by equation (54). Thus to leading order, using that

$$\lim_{D_2 \rightarrow D_1} Pr \{t_1 > t\} \approx 1 - \mu t \frac{\sqrt{4D_1 t}}{y_0 \sqrt{\pi}},$$

we obtain the asymptotic formula for $N \gg 1$

$$\begin{aligned} \bar{\tau}_\varepsilon^N &= \int_0^\infty [S(t)]^N dt \approx \int_0^\infty \exp \left\{ \log \left\{ 1 - \frac{\mu t \sqrt{4D_1 t}}{y_0 \sqrt{\pi}} \right\}^N \right\} dt \\ &\approx \Gamma \left(\frac{5}{3} \right) \left(\frac{y_0 \sqrt{\pi}}{\mu \sqrt{4D_1}} \right)^{\frac{2}{3}} \frac{1}{N^{\frac{2}{3}} + A_\varepsilon}, \end{aligned} \quad (58)$$

where $A_\varepsilon = A_0 + \varepsilon A_1 + \dots$, and A_k are constants as before.

When $\beta < 0$, we have then,

$$\hat{S}(q) = \frac{1}{q} - \frac{\mu D_1^{\frac{3}{2}}}{y_0(D_1 - D_2)q^{\frac{5}{2}}} + \frac{\mu D_2^{\frac{3}{2}}}{y_0(D_1 - D_2)q^{\frac{5}{2}}}. \quad (59)$$

Making now, $D_1 = D_2(1 + \varepsilon)$ and expanding in ε , we have

$$\begin{aligned} \hat{S}_\varepsilon(q) &\approx \frac{1}{q} - \frac{\mu}{y_0 q^{\frac{5}{2}}} \frac{D_2^{\frac{3}{2}}(1 + \varepsilon)^{\frac{3}{2}} - D_2^{\frac{3}{2}}}{D_2 \varepsilon} \\ &\approx \frac{1}{q} - \frac{3\mu\sqrt{D_2}}{2y_0 q^{\frac{5}{2}}} - \frac{\mu\sqrt{D_2}}{y_0 q^{\frac{5}{2}}} \left(\sum_{n=1}^{\infty} \binom{\frac{3}{2}}{n+1} \varepsilon^n \right). \end{aligned} \quad (60)$$

When $\varepsilon \rightarrow 0$, the survival probability $\hat{S}_\varepsilon(q)$ converges to $\hat{S}_0(q)$, corresponding to the solution when $D_1 = D_2$, given by the equation (54). For the same reasons as above, to leading order, using that

$$\lim_{D_1 \rightarrow D_2} Pr \{t_1 > t\} \approx 1 - \mu t \frac{\sqrt{4D_2 t}}{y_0 \sqrt{\pi}},$$

we obtain the asymptotic formula for $N \gg 1$

$$\begin{aligned} \bar{\tau}_\varepsilon^N &= \int_0^\infty [S(t)]^N dt \approx \int_0^\infty \exp \left\{ \log \left\{ 1 - \frac{\mu t \sqrt{4D_2 t}}{y_0 \sqrt{\pi}} \right\}^N \right\} dt \\ &\approx \Gamma \left(\frac{5}{3} \right) \left(\frac{y_0 \sqrt{\pi}}{\mu \sqrt{4D_2}} \right)^{\frac{2}{3}} \frac{1}{N^{\frac{2}{3}} + A_\varepsilon}, \end{aligned} \quad (61)$$

where $A_\varepsilon = A_0 + \varepsilon A_1 + \dots$, and A_k are constants. To conclude, to leading order, we obtain a formula for the MFAT when D_1 is close to D_2 when the initial condition starts in $[0, y_0]$.

4.3. Particles start in state 1 uniformly distributed in $[y_1 > 0, y_2]$

Considering now the initial condition $p_1(x, 0) = \frac{1}{y_2 - y_1} \mathbb{I}_{\{x \in [y_1, y_2]\}}$, when the particles start in state 1, we obtain the Laplace's transform of the survival probability given by the formula

$$\begin{aligned} \hat{S}(q) &= \frac{1}{q} + \frac{(q + \mu - D_2 w_2^2)(e^{w_2 y_2} - e^{w_2 y_1})}{(y_2 - y_1) D_1 D_2 w_2^3 (w_2^2 - w_4^2)} - \frac{(q + \mu - D_2 w_4^2)(e^{w_4 y_2} - e^{w_4 y_1})}{D_1 D_2 w_4^3 (w_2^2 - w_4^2)} \\ &= \frac{1}{q} + T_9(q) + T_{10}(q), \end{aligned}$$

where $T_9(q) = \frac{(q + \mu - D_2 w_2^2)(e^{w_2 y_2} - e^{w_2 y_1})}{(y_2 - y_1) D_1 D_2 w_2^3 (w_2^2 - w_4^2)}$ and $T_{10}(q) = -\frac{(q + \mu - D_2 w_4^2)(e^{w_4 y_2} - e^{w_4 y_1})}{D_1 D_2 w_4^3 (w_2^2 - w_4^2)}$. And using a Taylor expansion for q large,

$$\begin{aligned} T_9(q) &\approx \frac{\sqrt{2}(\text{sign}(b) + 1)}{D_1(y_2 - y_1)(\eta + |\beta|)^{\frac{3}{2}} q^{\frac{3}{2}}} \left(\exp \left\{ -\sqrt{\frac{(\eta + |\beta|)q}{2}} y_2 \right\} - \exp \left\{ -\sqrt{\frac{(\eta + |\beta|)q}{2}} y_1 \right\} \right), \\ T_{10}(q) &\approx \frac{\sqrt{2}(-\text{sign}(\beta) + 1)}{D_1(y_2 - y_1)(\eta - |\beta|)^{\frac{3}{2}} q^{\frac{3}{2}}} \left(\exp \left\{ -\sqrt{\frac{(\eta - |\beta|)q}{2}} y_2 \right\} - \exp \left\{ -\sqrt{\frac{(\eta - |\beta|)q}{2}} y_1 \right\} \right). \end{aligned}$$

Then, for both cases, $\text{sign}(\beta) = 1$ or $\text{sign}(\beta) = -1$, we have

$$\hat{S}(q) = \frac{1}{q} - \frac{\sqrt{D_1}}{(y_2 - y_1) q^{\frac{3}{2}}} \left(\exp \left\{ -\sqrt{\frac{q}{D_1}} y_1 \right\} - \exp \left\{ -\sqrt{\frac{q}{D_1}} y_2 \right\} \right). \quad (62)$$

Then, if we make $y_2 = y_1(1 + \varepsilon)$, we have,

$$\hat{S}_\varepsilon(q) = \frac{1}{q} - \frac{\sqrt{D_1}}{y_1 \varepsilon q^{\frac{3}{2}}} \exp \left\{ -\sqrt{\frac{q}{D_1}} y_1 \right\} \left(1 - \exp \left\{ -\sqrt{\frac{q}{D_1}} y_1 \varepsilon \right\} \right), \quad (63)$$

and using the expansion in ε

$$\hat{S}_\varepsilon(q) = \frac{1}{q} - \frac{\exp \left\{ -\sqrt{\frac{q}{D_1}} y_1 \right\}}{q} + \frac{\exp \left\{ -\sqrt{\frac{q}{D_1}} y_1 \right\}}{q} \sum_{n=1}^{\infty} \left(-\sqrt{\frac{q}{D_1}} y_1 \varepsilon \right)^n. \quad (64)$$

When $\varepsilon \rightarrow 0$, the survival probability $S_\varepsilon(t)$ converges to $S_0(t)$ corresponding to an initial condition for the Dirac delta function at position $y_1 > 0$. Once more, to leading order, using that

$$\lim_{y_2 \rightarrow y_1} Pr \{t_1 > t\} \approx 1 - \frac{\sqrt{4D_1 t}}{\sqrt{\pi}} \left[\frac{e^{-\frac{y_1^2}{4D_1 t}}}{y_1} \right],$$

we obtain to leading order the asymptotic formula for $N \gg 1$

$$\begin{aligned} \bar{\tau}_\varepsilon^N &= \int_0^\infty [S(t)]^N dt \approx \int_0^\infty \exp \left\{ \log \left\{ 1 - \frac{\sqrt{4D_1 t}}{\sqrt{\pi}} \left[\frac{e^{-\frac{y_1^2}{4D_1 t}}}{y_1} \right] \right\}^N \right\} dt \\ &\approx \frac{y_1^2}{4D_1 \log \left(\frac{N}{\sqrt{\pi}} \right) + A_\varepsilon}, \end{aligned} \quad (65)$$

where $A_\varepsilon = A_0 + \varepsilon A_1 + \dots$, and A_k are constants. Here y_1 is the shortest distance to the absorbing boundary.

4.4. Particles start in state 2 uniformly distributed in $[y_1, y_2]$

In the case where the particles follows the initial condition $p_2(x, 0) = \frac{1}{y_2 - y_1} \mathbb{I}_{\{x \in [y_1, y_2]\}}$, but starts in state 2 the Laplace's transform of the survival probability given by the formula

$$\begin{aligned} \hat{S}(q) &= \frac{1}{(y_2 - y_1)} \int_{y_1}^{y_2} \left(\frac{1}{q} + \frac{\mu e^{w_2 y}}{D_1 D_2 w_2^2 (w_2^2 - w_4^2)} - \frac{\mu e^{w_4 y}}{D_1 D_2 w_4^2 (w_2^2 - w_4^2)} \right) dy \\ &= \frac{1}{q} + \frac{\mu (e^{w_2 y_2} - e^{w_2 y_1})}{D_1 D_2 w_2^3 (w_2^2 - w_4^2)} - \frac{\mu (e^{w_4 y_2} - e^{w_4 y_1})}{D_1 D_2 w_4^3 (w_2^2 - w_4^2)} \\ &= \frac{1}{q} + T_{11}(q) + T_{12}(q), \end{aligned} \quad (66)$$

where $T_{11}(q) = \frac{\mu(e^{w_2 y_2} - e^{w_2 y_1})}{D_1 D_2 w_2^3 (w_2^2 - w_4^2)}$ and $T_{12}(q) = -\frac{\mu(e^{w_4 y_2} - e^{w_4 y_1})}{D_1 D_2 w_4^3 (w_2^2 - w_4^2)}$, and making the Taylor expansion for q large, for $T_{11}(q)$ and $T_{12}(q)$, we get

$$\begin{aligned} T_{11}(q) &\approx -\frac{2\sqrt{2}\mu}{(y_2 - y_1)D_1 D_2 |\beta| (\eta + |\beta|)^{\frac{3}{2}} q^{\frac{5}{2}}} \left(\exp \left\{ -\sqrt{\frac{(\eta + |\beta|)q}{2}} y_2 \right\} - \exp \left\{ -\sqrt{\frac{(\eta + |\beta|)q}{2}} y_1 \right\} \right), \\ T_{12}(q) &\approx \frac{2\sqrt{2}\mu}{(y_2 - y_1)D_1 D_2 |\beta| (\eta - |\beta|)^{\frac{3}{2}} q^{\frac{5}{2}}} \left(\exp \left\{ -\sqrt{\frac{(\eta - |\beta|)q}{2}} y_2 \right\} - \exp \left\{ -\sqrt{\frac{(\eta - |\beta|)q}{2}} y_1 \right\} \right). \end{aligned}$$

Then, for $\text{sign}(\beta) = 1$, we have the expansion for the Laplace transform of the survival probability

$$\begin{aligned} \hat{S}(q) &= \frac{1}{q} - \frac{\mu D_2^{\frac{3}{2}}}{(y_2 - y_1)(D_2 - D_1)q^{\frac{5}{2}}} \left(\exp \left\{ -\sqrt{\frac{q}{D_2}} y_1 \right\} - \exp \left\{ -\sqrt{\frac{q}{D_2}} y_2 \right\} \right) \\ &\quad + \frac{\mu D_1^{\frac{3}{2}}}{(y_2 - y_1)(D_2 - D_1)q^{\frac{5}{2}}} \left(\exp \left\{ -\sqrt{\frac{q}{D_1}} y_1 \right\} - \exp \left\{ -\sqrt{\frac{q}{D_1}} y_2 \right\} \right), \end{aligned} \quad (67)$$

and making $y_2 = y_1(1 + \varepsilon)$, we have

$$\begin{aligned} \hat{S}_\varepsilon(q) &= \frac{1}{q} - \frac{\mu D_2^{\frac{3}{2}}}{y_1 \varepsilon (D_2 - D_1) q^{\frac{5}{2}}} \exp \left\{ -\sqrt{\frac{q}{D_2}} y_1 \right\} \left(1 - \exp \left\{ -\sqrt{\frac{q}{D_2}} y_1 \varepsilon \right\} \right) \\ &\quad + \frac{\mu D_1^{\frac{3}{2}}}{y_1 \varepsilon (D_2 - D_1) q^{\frac{5}{2}}} \exp \left\{ -\sqrt{\frac{q}{D_1}} y_1 \right\} \left(1 - \exp \left\{ -\sqrt{\frac{q}{D_1}} y_1 \varepsilon \right\} \right). \end{aligned} \quad (68)$$

Then, using the Taylor expansion of the exponential functions we have

$$\begin{aligned} \hat{S}_\varepsilon(q) &= \frac{1}{q} - \frac{\mu D_2}{(D_2 - D_1)q^2} \exp \left\{ -\sqrt{\frac{q}{D_2}} y_1 \right\} + \frac{\mu D_2}{(D_2 - D_1)q^2} \exp \left\{ -\sqrt{\frac{q}{D_2}} y_1 \right\} \sum_{n=1}^{\infty} \left(-\sqrt{\frac{q}{D_2}} y_1 \varepsilon \right)^n \\ &\quad + \frac{\mu D_1}{(D_2 - D_1)q^2} \exp \left\{ -\sqrt{\frac{q}{D_1}} y_1 \right\} - \frac{\mu D_1}{(D_2 - D_1)q^2} \exp \left\{ -\sqrt{\frac{q}{D_1}} y_1 \right\} \sum_{n=1}^{\infty} \left(-\sqrt{\frac{q}{D_1}} y_1 \varepsilon \right)^n. \end{aligned}$$

When $\varepsilon \rightarrow 0$, the survival probability $S_\varepsilon(t)$ converges to $S_0(t)$ corresponding to an initial condition for the Dirac delta function at position y_1 for $D_1 \neq D_2$. Thus to leading order, using that

$$\lim_{\substack{y_2 \rightarrow y_1, \\ D_2 \rightarrow D_1}} Pr \{t_1 > t\} \approx 1 - \frac{\mu t \sqrt{4D_1 t}}{\sqrt{\pi}} \left[\frac{e^{-\frac{y_1^2}{4D_1 t}}}{y_1} \right],$$

we obtain to leading order the asymptotic formula for $N \gg 1$

$$\begin{aligned} \bar{\tau}_\varepsilon^N &= \int_0^\infty [S(t)]^N dt \approx \int_0^\infty \exp \left\{ \log \left\{ 1 - \frac{\mu t \sqrt{4D_1 t}}{\sqrt{\pi}} \left[\frac{e^{-\frac{y_1^2}{4D_1 t}}}{y_1} \right] \right\}^N \right\} dt \\ &\approx \frac{y_1^2}{4D_1 \cdot \log \left(\frac{N}{\sqrt{\pi}} \cdot \mu \frac{y_1^2}{4D_1} \right) + A_\varepsilon}, \end{aligned} \quad (69)$$

where $A_\varepsilon = A_0 + \varepsilon A_1 + \dots$, where A_k are constants. When $\text{sign}(\beta) = -1$, we have the expansion for the Laplace transform of the survival probability

$$\begin{aligned} \hat{S}(q) &= \frac{1}{q} - \frac{\mu D_1^{\frac{3}{2}}}{(y_2 - y_1)(D_1 - D_2)q^{\frac{5}{2}}} \left(\exp \left\{ -\sqrt{\frac{q}{D_1}} y_1 \right\} - \exp \left\{ -\sqrt{\frac{q}{D_1}} y_2 \right\} \right) \\ &+ \frac{\mu D_2^{\frac{3}{2}}}{(y_2 - y_1)(D_1 - D_2)q^{\frac{5}{2}}} \left(\exp \left\{ -\sqrt{\frac{q}{D_2}} y_1 \right\} - \exp \left\{ -\sqrt{\frac{q}{D_2}} y_2 \right\} \right), \end{aligned} \quad (70)$$

and making $y_2 = y_1(1 + \varepsilon)$, we have

$$\begin{aligned} \hat{S}_\varepsilon(q) &= \frac{1}{q} - \frac{\mu D_1^{\frac{3}{2}}}{y_1 \varepsilon (D_1 - D_2) q^{\frac{5}{2}}} \exp \left\{ -\sqrt{\frac{q}{D_1}} y_1 \right\} \left(1 - \exp \left\{ -\sqrt{\frac{q}{D_1}} y_1 \varepsilon \right\} \right) \\ &+ \frac{\mu D_2^{\frac{3}{2}}}{y_1 \varepsilon (D_1 - D_2) q^{\frac{5}{2}}} \exp \left\{ -\sqrt{\frac{q}{D_2}} y_1 \right\} \left(1 - \exp \left\{ -\sqrt{\frac{q}{D_2}} y_1 \varepsilon \right\} \right). \end{aligned} \quad (71)$$

Then, using the Taylor expansion of the exponential functions we have

$$\begin{aligned} \hat{S}_\varepsilon(q) &= \frac{1}{q} - \frac{\mu D_1}{(D_1 - D_2)q^2} \exp \left\{ -\sqrt{\frac{q}{D_1}} y_1 \right\} + \frac{\mu D_1}{(D_1 - D_2)q^2} \exp \left\{ -\sqrt{\frac{q}{D_1}} y_1 \right\} \sum_{n=1}^\infty \left(-\sqrt{\frac{q}{D_1}} y_1 \varepsilon \right)^n \\ &+ \frac{\mu D_2}{(D_1 - D_2)q^2} \exp \left\{ -\sqrt{\frac{q}{D_2}} y_1 \right\} - \frac{\mu D_2}{(D_1 - D_2)q^2} \exp \left\{ -\sqrt{\frac{q}{D_2}} y_1 \right\} \sum_{n=1}^\infty \left(-\sqrt{\frac{q}{D_2}} y_1 \varepsilon \right)^n. \end{aligned}$$

When $\varepsilon \rightarrow 0$, the survival probability $S_\varepsilon(t)$ converges to $S_0(t)$ corresponding to an initial condition for the Dirac delta function at position y_1 for $D_1 \neq D_2$. Using the same reasoning as above, to leading order, using that

$$\lim_{\substack{y_2 \rightarrow y_1, \\ D_1 \rightarrow D_2}} Pr \{t_1 > t\} \approx 1 - \frac{\mu t \sqrt{4D_2 t}}{\sqrt{\pi}} \left[\frac{e^{-\frac{y_1^2}{4D_2 t}}}{y_1} \right],$$

we obtain the asymptotic formula for $N \gg 1$

$$\begin{aligned} \bar{\tau}_\varepsilon^N &= \int_0^\infty [S(t)]^N dt \approx \int_0^\infty \exp \left\{ \log \left\{ 1 - \frac{\mu t \sqrt{4D_2 t}}{\sqrt{\pi}} \left[\frac{e^{-\frac{y_1^2}{4D_2 t}}}{y_1} \right] \right\}^N \right\} dt \\ &\approx \frac{y_1^2}{4D_2 \cdot \log \left(\frac{N}{\sqrt{\pi}} \cdot \mu \frac{y_1^2}{4D_2} \right) + A_\varepsilon}, \end{aligned} \quad (72)$$

where $A_\varepsilon = A_0 + \varepsilon A_1 + \dots$, where A_k are constants. To conclude, when $y_1 > 0$, this point correspond to the shortest distance to the absorbing boundary. To leading order, the MFAT is then the same as the one we found for a Dirac delta at $y_1 > 0$ and $D_1 = D_2$.

5. INITIAL DISTRIBUTION WITH A LONG TAIL

5.1. Particles start in state 1

We shall study the MFAT when the initial distribution of particles is given by

$$\begin{aligned} p_1(x, 0) &= \frac{2b^{\frac{1+\alpha}{2}}}{\Gamma\left(\frac{1+\alpha}{2}\right)} x^\alpha \exp\{-bx^2\} \\ p_2(x, 0) &= 0. \end{aligned} \quad (73)$$

The survival probability for the switching case is given by the following expression

$$\begin{aligned} \hat{S}(q) &= \frac{2b^{\frac{1+\alpha}{2}}}{\Gamma\left(\frac{1+\alpha}{2}\right)} \int_0^\infty \left[\frac{1}{q} + \frac{(\mu + q - D_2 w_2^2) e^{w_2 y}}{D_1 D_2 w_2^2 (w_2^2 - w_4^2)} - \frac{(\mu + q - D_2 w_4^2) e^{w_4 y}}{D_1 D_2 w_4^2 (w_2^2 - w_4^2)} \right] y^\alpha \exp\{-bx^2\} \\ &= \frac{1}{q} - \frac{\Gamma(1+\alpha) (\mu + q - D_2 w_2^2)}{\Gamma\left(\frac{1+\alpha}{2}\right) 2^{1+\alpha} b^{\frac{1}{2}} D_1 D_2 w_2 (w_2^2 - w_4^2)} \text{HypergeometricU} \left[1 + \frac{\alpha}{2}, \frac{3}{2}, \frac{w_2^2}{4b} \right] \\ &+ \frac{\Gamma(1+\alpha) (\mu + q - D_2 w_4^2)}{\Gamma\left(\frac{1+\alpha}{2}\right) 2^{1+\alpha} b^{\frac{1}{2}} D_1 D_2 w_4 (w_2^2 - w_4^2)} \text{HypergeometricU} \left[1 + \frac{\alpha}{2}, \frac{3}{2}, \frac{w_4^2}{4b} \right], \end{aligned} \quad (74)$$

where, $\text{HypergeometricU}(a, b, z)$ is the confluent hypergeometric function $U(a, b, z)$. Using the large q expansion, we have

$$\hat{S}(q) \approx \frac{1}{q} - \frac{\Gamma(1+\alpha)}{D_1 \Gamma\left(\frac{1+\alpha}{2}\right)} \left[\frac{2}{bq} \right]^{\frac{3+\alpha}{2}} \left[\frac{\text{sign}(\beta) + 1}{(\eta + |\beta|)^{\frac{3+\alpha}{2}}} - \frac{\text{sign}(\beta) - 1}{(\eta - |\beta|)^{\frac{3+\alpha}{2}}} \right].$$

In both cases, when $\text{sign}(\beta) = 1$ or $\text{sign}(\beta) = -1$, we have

$$\hat{S}(q) = \frac{1}{q} - \frac{2\Gamma(1+\alpha) D_1^{\frac{1+\alpha}{2}}}{\Gamma\left(\frac{1+\alpha}{2}\right) (bq)^{\frac{3+\alpha}{2}}}. \quad (75)$$

Thus the inverse Laplace leads to

$$S(t) \approx 1 - \frac{2\Gamma(1+\alpha) D_1^{\frac{1+\alpha}{2}}}{\Gamma\left(\frac{1+\alpha}{2}\right) \Gamma\left(\frac{3+\alpha}{2}\right) b^{\frac{3+\alpha}{2}}} t^{\frac{1+\alpha}{2}}, \quad (76)$$

Thus following the steps described in the previous section, we obtain that the mean time for the fastest is given by

$$\begin{aligned} \bar{\tau}^N &= \int_0^\infty [S(t)]^N dt \approx \int_0^\infty \exp \left\{ \log \left\{ 1 - \frac{2\Gamma(1+\alpha) D_1^{\frac{1+\alpha}{2}}}{\Gamma\left(\frac{1+\alpha}{2}\right) \Gamma\left(\frac{3+\alpha}{2}\right) b^{\frac{3+\alpha}{2}}} t^{\frac{1+\alpha}{2}} \right\}^N \right\} dt \\ &\approx \left[\frac{\Gamma\left(\frac{1+\alpha}{2}\right) \Gamma\left(\frac{3+\alpha}{2}\right)}{\Gamma(1+\alpha) N} \right]^{\frac{2}{1+\alpha}} \frac{b^{\frac{3+\alpha}{2}} \Gamma\left(\frac{3+\alpha}{2}\right)}{4^{\frac{1}{1+\alpha}} D_1}. \end{aligned} \quad (77)$$

5.2. Particles start in state 2

The particles are initially distributed in state 2

$$\begin{aligned} p_1(x, 0) &= 0 \\ p_2(x, 0) &= \frac{2b^{\frac{1+\alpha}{2}}}{\Gamma\left(\frac{1+\alpha}{2}\right)} x^\alpha \exp\{-bx^2\}. \end{aligned} \quad (78)$$

The Laplace transform of the survival probability when $D_1 = D_2 = D$ is given by

$$\begin{aligned}\hat{S}(q) &= \frac{2b^{\frac{1+\alpha}{2}}}{\Gamma\left(\frac{1+\alpha}{2}\right)} \int_0^\infty \left[\frac{1}{q} - \frac{\mu e^{-y\sqrt{\frac{q}{D}}}}{\theta q} + \frac{\mu e^{-y\sqrt{\frac{q+\theta}{D}}}}{\theta(q+\theta)} \right] y^\alpha \exp\{-bx^2\} \\ &= \frac{1}{q} - \frac{2^{-(1+\alpha)} b^{-\frac{1}{2}} \mu \Gamma(1+\alpha)}{\Gamma\left(\frac{1+\alpha}{2}\right) \sqrt{D}} \left[\frac{1}{\sqrt{q}} \text{HypergeometricU} \left[1 + \frac{\alpha}{2}, \frac{3}{2}, \frac{q}{4bD} \right] \right. \\ &\quad \left. - \frac{1}{\sqrt{q+\theta}} \text{HypergeometricU} \left[1 + \frac{\alpha}{2}, \frac{3}{2}, \frac{q+\theta}{4bD} \right] \right].\end{aligned}\quad (79)$$

where, $\text{HypergeometricU}(a, b, z)$ is the confluent hypergeometric function $U(a, b, z)$ and $\theta = \lambda + \mu$. In the large q expansion, we have

$$\hat{S}(q) \approx \frac{1}{q} - \frac{(bD)^{\frac{1+\alpha}{2}} \mu(3+\alpha)\Gamma(1+\alpha)}{\Gamma\left(\frac{1+\alpha}{2}\right) q^{\frac{5+\alpha}{2}}}, \quad (80)$$

leading to

$$S(t) \approx 1 - \frac{(bD)^{\frac{1+\alpha}{2}} \mu(3+\alpha)\Gamma(1+\alpha)}{\Gamma\left(\frac{1+\alpha}{2}\right) \Gamma\left(\frac{5+\alpha}{2}\right)} t^{\frac{3+\alpha}{2}}, \quad (81)$$

and

$$\begin{aligned}\bar{\tau}^N &= \int_0^\infty [S(t)]^N dt \approx \int_0^\infty \exp \left\{ \log \left\{ 1 - \frac{(bD)^{\frac{1+\alpha}{2}} \mu(3+\alpha)\Gamma(1+\alpha)}{\Gamma\left(\frac{1+\alpha}{2}\right) \Gamma\left(\frac{5+\alpha}{2}\right)} t^{\frac{3+\alpha}{2}} \right\}^N \right\} dt \\ &\approx \left[\frac{\Gamma\left(\frac{1+\alpha}{2}\right) \Gamma\left(\frac{5+\alpha}{2}\right)}{\mu(3+\alpha)\Gamma(1+\alpha)N} \right]^{\frac{2}{3+\alpha}} \frac{\Gamma\left(\frac{5+\alpha}{3+\alpha}\right)}{(bD)^{\frac{1+\alpha}{3+\alpha}}}.\end{aligned}\quad (82)$$

This decay for the mean first arrival time of the fastest particle for N large, shows a single switch before escapes. When $D_1 \neq D_2$, the Laplace transform of the survival probability gives

$$\begin{aligned}\hat{S}(q) &= \frac{2b^{\frac{1+\alpha}{2}}}{\Gamma\left(\frac{1+\alpha}{2}\right)} \int_0^\infty \left[\frac{1}{q} + \frac{\mu e^{w_2 y}}{D_1 D_2 w_2^2 (w_2^2 - w_4^2)} - \frac{\mu e^{w_4 y}}{D_1 D_2 w_4^2 (w_2^2 - w_4^2)} \right] y^\alpha \exp\{-bx^2\} \\ &= \frac{1}{q} + \frac{2^{-(1+\alpha)} b^{-\frac{1}{2}} \mu \Gamma(1+\alpha)}{\Gamma\left(\frac{1+\alpha}{2}\right) D_1 D_2 (w_2^2 - w_4^2)} \left[-\frac{1}{w_2} \text{HypergeometricU} \left[1 + \frac{\alpha}{2}, \frac{3}{2}, \frac{w_2^2}{4b} \right] \right. \\ &\quad \left. + \frac{1}{w_4} \text{HypergeometricU} \left[1 + \frac{\alpha}{2}, \frac{3}{2}, \frac{w_4^2}{4b} \right] \right].\end{aligned}\quad (83)$$

Then, making the expansion for q large, we can have the approximation for the survival probability

$$\hat{S}(q) \approx \frac{1}{q} - \frac{2\mu\Gamma(1+\alpha)}{2^{-\frac{3+\alpha}{2}} b^{-\frac{1+\alpha}{2}} \Gamma\left(\frac{1+\alpha}{2}\right) D_1 D_2 |\beta| q^{\frac{5+\alpha}{2}}} \left[\frac{1}{(\eta - |\beta|)^{\frac{3+\alpha}{2}}} - \frac{1}{(\eta + |\beta|)^{\frac{3+\alpha}{2}}} \right], \quad (84)$$

leading to

$$\hat{S}(q) \approx \frac{1}{q} - \frac{2\mu\Gamma(1+\alpha)}{b^{-\frac{1+\alpha}{2}} \Gamma\left(\frac{1+\alpha}{2}\right) (D_2 - D_1) q^{\frac{5+\alpha}{2}}} \left[D_2^{\frac{3+\alpha}{2}} - D_1^{\frac{3+\alpha}{2}} \right] \quad (85)$$

when $\text{sing}(\beta) = 1$. For $D_2 = D_1(1 + \varepsilon)$, we have

$$\hat{S}_\varepsilon(q) \approx \frac{1}{q} - \frac{2\mu\Gamma(1+\alpha)b^{\frac{1+\alpha}{2}}D_1^{\frac{3+\alpha}{2}}}{\Gamma\left(\frac{1+\alpha}{2}\right)D_1\varepsilon q^{\frac{5+\alpha}{2}}}\left[(1+\varepsilon)^{\frac{3+\alpha}{2}} - 1\right],$$

and expanding the above expression in ε , we have

$$\hat{S}_\varepsilon(q) \approx \frac{1}{q} - \frac{\mu(3+\alpha)\Gamma(1+\alpha)b^{\frac{1+\alpha}{2}}D_1^{\frac{1+\alpha}{2}}}{\Gamma\left(\frac{1+\alpha}{2}\right)q^{\frac{5+\alpha}{2}}} - \frac{2\mu\Gamma(1+\alpha)b^{\frac{1+\alpha}{2}}D_1^{\frac{1+\alpha}{2}}}{\Gamma\left(\frac{1+\alpha}{2}\right)q^{\frac{5+\alpha}{2}}}\sum_{n=1}^{\infty}\binom{\frac{3+\alpha}{2}}{n+1}\varepsilon^n.$$

When $\varepsilon \rightarrow 0$, the survival probability $S_\varepsilon(t)$ converges to $S_0(t)$ corresponding to an initial condition with a long tail for $D_1 = D_2$. Using the same reasoning as we did before, to leading order, using that

$$\lim_{D_2 \rightarrow D_1} Pr\{t_1 > t\} \approx 1 - \frac{(bD_1)^{\frac{1+\alpha}{2}}\mu(3+\alpha)\Gamma(1+\alpha)}{\Gamma\left(\frac{1+\alpha}{2}\right)\Gamma\left(\frac{5+\alpha}{2}\right)}t^{\frac{3+\alpha}{2}},$$

we obtain to leading order the asymptotic formula for $N \gg 1$

$$\begin{aligned} \bar{\tau}_\varepsilon^N &= \int_0^\infty [S(t)]^N dt \approx \int_0^\infty \exp\left\{\log\left\{1 - \frac{(bD_1)^{\frac{1+\alpha}{2}}\mu(3+\alpha)\Gamma(1+\alpha)}{\Gamma\left(\frac{1+\alpha}{2}\right)\Gamma\left(\frac{5+\alpha}{2}\right)}t^{\frac{3+\alpha}{2}}\right\}^N\right\} dt \\ &\approx \left[\frac{\Gamma\left(\frac{1+\alpha}{2}\right)\Gamma\left(\frac{5+\alpha}{2}\right)}{\mu(3+\alpha)\Gamma(1+\alpha)}\right]^{\frac{2}{3+\alpha}} \frac{\Gamma\left(\frac{5+\alpha}{3+\alpha}\right)}{(bD_1)^{\frac{1+\alpha}{3+\alpha}} N^{\frac{2}{3+\alpha}} + A_\varepsilon}, \end{aligned} \quad (86)$$

where $A_\varepsilon = A_0 + \varepsilon A_1 + \dots$, where A_k are constants. To conclude, to leading order in ε , the MFAT when the initial distribution with a long tail and different diffusion coefficients starting in state 2 is similar to the case $D_1 = D_2$. When $\text{sing}(\beta) = -1$ we have the expression for the survival probability

$$\hat{S}(q) \approx \frac{1}{q} - \frac{2\mu\Gamma(1+\alpha)}{b^{-\frac{1+\alpha}{2}}\Gamma\left(\frac{1+\alpha}{2}\right)(D_1 - D_2)q^{\frac{5+\alpha}{2}}}\left[D_1^{\frac{3+\alpha}{2}} - D_2^{\frac{3+\alpha}{2}}\right]. \quad (87)$$

Making $D_1 = D_2(1 + \varepsilon)$, we have

$$\hat{S}_\varepsilon(q) \approx \frac{1}{q} - \frac{2\mu\Gamma(1+\alpha)b^{\frac{1+\alpha}{2}}D_2^{\frac{3+\alpha}{2}}}{\Gamma\left(\frac{1+\alpha}{2}\right)D_2\varepsilon q^{\frac{5+\alpha}{2}}}\left[(1+\varepsilon)^{\frac{3+\alpha}{2}} - 1\right],$$

and expanding the above expression in ε , we have

$$\hat{S}_\varepsilon(q) \approx \frac{1}{q} - \frac{\mu(3+\alpha)\Gamma(1+\alpha)b^{\frac{1+\alpha}{2}}D_2^{\frac{1+\alpha}{2}}}{\Gamma\left(\frac{1+\alpha}{2}\right)q^{\frac{5+\alpha}{2}}} - \frac{2\mu\Gamma(1+\alpha)b^{\frac{1+\alpha}{2}}D_2^{\frac{1+\alpha}{2}}}{\Gamma\left(\frac{1+\alpha}{2}\right)q^{\frac{5+\alpha}{2}}}\sum_{n=1}^{\infty}\binom{\frac{3+\alpha}{2}}{n+1}\varepsilon^n.$$

When $\varepsilon \rightarrow 0$, the survival probability $S_\varepsilon(t)$ converges to $S_0(t)$ corresponding to an initial condition with a long tail for $D_1 = D_2$. Thus to leading order, using that

$$\lim_{D_1 \rightarrow D_2} Pr\{t_1 > t\} \approx 1 - \frac{(bD_2)^{\frac{1+\alpha}{2}}\mu(3+\alpha)\Gamma(1+\alpha)}{\Gamma\left(\frac{1+\alpha}{2}\right)\Gamma\left(\frac{5+\alpha}{2}\right)}t^{\frac{3+\alpha}{2}},$$

we obtain for $N \gg 1$

$$\begin{aligned} \bar{\tau}_\varepsilon^N &= \int_0^\infty [S(t)]^N dt \approx \int_0^\infty \exp\left\{\log\left\{1 - \frac{(bD_2)^{\frac{1+\alpha}{2}}\mu(3+\alpha)\Gamma(1+\alpha)}{\Gamma\left(\frac{1+\alpha}{2}\right)\Gamma\left(\frac{5+\alpha}{2}\right)}t^{\frac{3+\alpha}{2}}\right\}^N\right\} dt \\ &\approx \left[\frac{\Gamma\left(\frac{1+\alpha}{2}\right)\Gamma\left(\frac{5+\alpha}{2}\right)}{\mu(3+\alpha)\Gamma(1+\alpha)}\right]^{\frac{2}{3+\alpha}} \frac{\Gamma\left(\frac{5+\alpha}{3+\alpha}\right)}{(bD_2)^{\frac{1+\alpha}{3+\alpha}} N^{\frac{2}{3+\alpha}} + A_\varepsilon}, \end{aligned} \quad (88)$$

where $A_\varepsilon = A_0 + \varepsilon A_1 + \dots$, where A_k are constants. To conclude, the MFAT for an initial distribution with a long tail and different diffusion coefficients starting in state 2 is similar to the case $D_1 = D_2$.

6. DISCUSSION AND CONCLUDING REMARKS

In the present manuscript, we have obtained several asymptotic formulas (16, 33, 41, 51, 55, 77, 82) for the mean time the fastest Brownian particles that can switch between two states escape from half a line. These formulas are associated with different initial distribution and whether the particle start all in state 1 or 2: in the present model, particles escape only in state 1. Depending on the initial distribution, we found a decay in $\frac{1}{\log N}$ when the initial distribution does not intersect the target location. However, when $p_0(x)$ intersects the absorbing boundary, we obtain an algebraic decay with $N \frac{1}{N^\alpha}$.

When the particles start in state 1, where escape is possible, the MFAT is similar to the formulas for the non-switching case. The main different occurs when particles start in state 2 where they can not escape and thus they need to switch at least once. We expect more interesting result when the diffusion coefficient in state 2 is much faster than in 1: in that case, the fastest particles should switch to state 2, diffuse faster than in state 1 and then switch back to state 1 in order to escape. A formal derivation of this result remains to be found.

These extreme statistics formulas are relevant in the context of fast molecular signaling in cell biology. This approach can be used to compute the time of activation by diffusing molecules crossing a region where switching is possible. The activation is a MFAT and depends on the main parameters, involving the geometrical organization of the domain, the initial distribution of the molecules and the specific dynamics of the particles (diffusion, switching and/or other stochastic dynamics). There are ubiquitous examples where par-

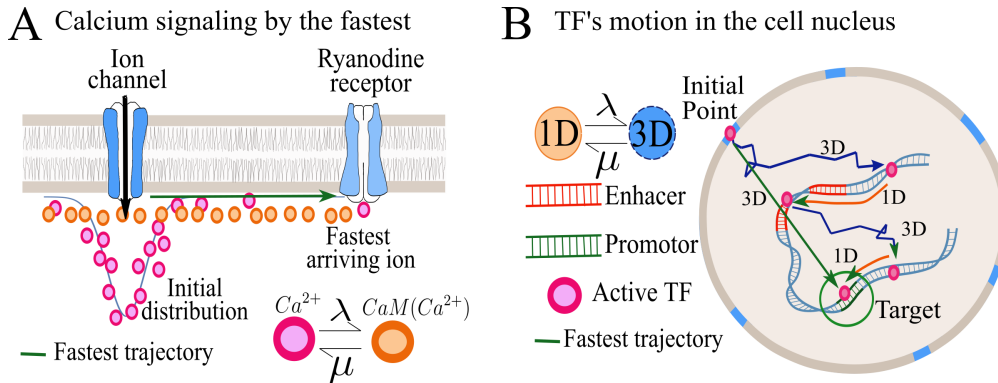

FIG. 3: **Application of the MFAT.** **A.** Example of Calcium ions entering through a ionic Channel. These ions can switch states between free Ca^{2+} or bound to calmodulin CaM , occurring diffusion. This binding interfer with a fast activation of the Ryanodine receptor [23]. **B.** Example of a transcription factor TF moving randomly inside a cell nucleus, alternating between 1d and 3d diffusion. The time for the first TF to activate an enhancer falls into the class of MFAT.

ticles such as molecules, transcription factors TFs have to switch between different states before arriving to a small target site. For example, when particles are injected slowly in a domain, an extended initial distribution can build up, leading to a long-tail distribution. This distribution could be approximated by a Gaussian or any other related distribution with an algebraic decay, especially when the motion can be modeled as anomalous diffusion [31]. For example, calcium ions enter in less than a few milliseconds inside a dendrite or

neuronal synapses through few channels located on the membrane, as shown in Fig. 3A. When channels are closed again, the calcium concentration has already spread over the domain. These calcium ions can also change their state due to possible chemical reactions. One classical example is the interaction between Calcium ions and calmodulin molecules *CaM*. Calcium signaling in dendritic spines, is often mediated by the fastest arriving calcium ion to Ryanodine receptors. During this fast process, the fastest calcium ion do not bind to a *CaM* molecule, as it would lead to a much longer arrival time compared to the one observed experimentally [33]. This result can be explained by the present theory, showing that the fast particles do not switch.

Another example is the case of a transcription factor *TF*, the motion of which can be described as Brownian inside the cell nucleus. TFs can alternate motion between a 1D sliding along the DNA and a 3D motion inside the nucleus cell (Fig. 3B), with diffusion coefficients $D_1 \neq D_2$ and Poissonian rates λ and μ . Although a lot of the literature was dedicated to the case of a single TF [34], it is possible that the fastest TF arrives to the promoter site directly without switching, a scenario that should be further studied.

6.1. Author contribution statement

All authors contributed equally to the paper.

-
- [1] G. H. Weiss, K. E. Shuler, and K. Lindenberg, “Order statistics for first passage times in diffusion processes,” *J. Stat. Phys.*, vol. 31, pp. 255–278, 1983.
 - [2] C. Mejía-Monasterio, G. Oshanin, and G. Schehr, “First passages for a search by a swarm of independent random searchers,” *Journal of Statistical Mechanics: Theory and Experiment*, vol. 2011, no. 06, p. P06022, 2011.
 - [3] A. Godec and R. Metzler, “First passage time distribution in heterogeneity controlled kinetics: going beyond the mean first passage time,” *Scientific reports*, vol. 6, no. 1, pp. 1–11, 2016.
 - [4] A. J. Bray, S. N. Majumdar, and G. Schehr, “Persistence and first-passage properties in nonequilibrium systems,” *Advances in Physics*, vol. 62, no. 3, pp. 225–361, 2013.
 - [5] K. Basnayake, Z. Schuss, and D. Holcman, “Asymptotic formulas for extreme statistics of escape times in 1, 2 and 3-dimensions,” *Journal of Nonlinear Science*, Sep 2018.
 - [6] J. B. Madrid and S. D. Lawley, “Competition between slow and fast regimes for extreme first passage times of diffusion,” *J. Phys. A*, vol. 53, no. 33, pp. 335002, 32, 2020.
 - [7] G. Schehr and S. N. Majumdar, “Exact record and order statistics of random walks via first-passage ideas,” in *First-Passage Phenomena and Their Applications*, pp. 226–251, World Scientific, 2014.
 - [8] S. D. Lawley, “Distribution of extreme first passage times of diffusion,” *J. Math. Biol.*, vol. 80, no. 7, pp. 2301–2325, 2020.
 - [9] S. D. Lawley, “Extreme first-passage times for random walks on networks,” *Phys. Rev. E*, vol. 102, no. 6, pp. 062118, 14, 2020.
 - [10] R. Metzler, S. Redner, and G. Oshanin, *First-passage phenomena and their applications*, vol. 35. World Scientific, 2014.
 - [11] S. N. Majumdar, A. Pal, and G. Schehr, “Extreme value statistics of correlated random variables: a pedagogical review,” *Physics Reports*, vol. 840, pp. 1–32, 2020.
 - [12] D. Grebenkov, R. Metzler, and G. Oshanin, “From single-particle stochastic kinetics to macroscopic reaction rates: fastest first-passage time of n random walkers,” *New Journal of Physics*, 2020.
 - [13] S. D. Lawley and J. B. Madrid, “A probabilistic approach to extreme statistics of brownian escape times in dimensions 1, 2, and 3,” *Journal of Nonlinear Science*, vol. 30, no. 3, pp. 1207–1227, 2020.
 - [14] S. Toste and D. Holcman, “Asymptotics for the fastest among n stochastics particles: role of an extended initial distribution and an additional drift component,” *Journal of Physics A: Mathematical and Theoretical*, 2021.

- [15] A. Godec and R. Metzler, “First passage time statistics for two-channel diffusion,” *Journal of Physics A: Mathematical and Theoretical*, vol. 50, no. 8, p. 084001, 2017.
- [16] D. S. Grebenkov, “A unifying approach to first-passage time distributions in diffusing diffusivity and switching diffusion models,” *Journal of Physics A: Mathematical and Theoretical*, vol. 52, no. 17, p. 174001, 2019.
- [17] K. Lindenberg, R. Metzler, and G. Oshanin, *Chemical Kinetics: Beyond the Textbook*. World Scientific Publishing Europe Ltd, 2019.
- [18] T. Lu, T. Shen, C. Zong, J. Hastly, and P. G. Wolynes, “Statistics of cellular signal transduction as a race to the nucleus by multiple random walkers in compartment/phosphorylation space,” *Proceedings of the National Academy of Sciences*, vol. 103, no. 45, pp. 16752–16757, 2006.
- [19] J. Reingruber and D. Holcman, “Gated narrow escape time for molecular signaling,” *Physical review letters*, vol. 103, no. 14, p. 148102, 2009.
- [20] H. S. Carslaw and J. C. Jaeger, “Conduction of heat in solids,” tech. rep., Clarendon Press,, 1959.
- [21] B. Meerson and S. Redner, “Mortality, redundancy, and diversity in stochastic search,” *Physical review letters*, vol. 114, no. 19, p. 198101, 2015.
- [22] Z. Schuss, K. Basnayake, and D. Holcman, “Redundancy principle and the role of extreme statistics in molecular and cellular biology,” *Physics of life reviews*, 2019.
- [23] K. Basnayake and D. Holcman, “Fastest among equals: a novel paradigm in biology. reply to comments: Redundancy principle and the role of extreme statistics in molecular and cellular biology,” *PhLRv*, vol. 28, pp. 96–99, 2019.
- [24] B. Alberts, D. Bray, K. Hopkin, A. D. Johnson, J. Lewis, M. Raff, K. Roberts, and P. Walter, *Essential cell biology*. Garland Science, 2015.
- [25] B. Hille, “Ionic channels in excitable membranes. current problems and biophysical approaches,” *Biophysical Journal*, vol. 22, no. 2, pp. 283–294, 1978.
- [26] Y. A. Makhnovskii, A. M. Berezhkovskii, S.-Y. Sheu, D.-Y. Yang, J. Kuo, and S. H. Lin, “Stochastic gating influence on the kinetics of diffusion-limited reactions,” *The Journal of chemical physics*, vol. 108, no. 3, pp. 971–983, 1998.
- [27] K. Roberts, B. Alberts, A. Johnson, P. Walter, and T. Hunt, “Molecular biology of the cell,” *New York: Garland Science*, vol. 32, no. 2, 2002.
- [28] A. Szabo, D. Shoup, S. H. Northrup, and J. A. McCammon, “Stochastically gated diffusion-influenced reactions,” *The Journal of Chemical Physics*, vol. 77, no. 9, pp. 4484–4493, 1982.
- [29] D. A. Potoyan and P. G. Wolynes, “Stochastic dynamics of genetic broadcasting networks,” *Physical Review E*, vol. 96, no. 5, p. 052305, 2017.
- [30] C. Dieball, D. Krapf, M. Weiss, and A. Godec, “Scattering fingerprints of two-state dynamics,” *New Journal of Physics*, 2022.
- [31] R. Metzler and J. Klafter, “The random walk’s guide to anomalous diffusion: a fractional dynamics approach,” *Phys. Rep.*, vol. 339, no. 1, pp. 1 – 77, 2000.
- [32] D. X. Keller, K. M. Franks, T. M. Bartol Jr, and T. J. Sejnowski, “Calmodulin activation by calcium transients in the postsynaptic density of dendritic spines,” *PLoS One*, vol. 3, no. 4, p. e2045, 2008.
- [33] K. Basnayake, D. Mazaud, A. Bemelmans, N. Rouach, E. Korkotian, and D. Holcman, “Fast calcium transients in dendritic spines driven by extreme statistics,” *PLoS biology*, vol. 17, no. 6, 2019.
- [34] J. Reingruber and D. Holcman, “Transcription factor search for a dna promoter in a three-state model.,” *Phys Rev E*, vol. 84, p. 020901, 2011.

A Distribution time for the fastest particle among 10000

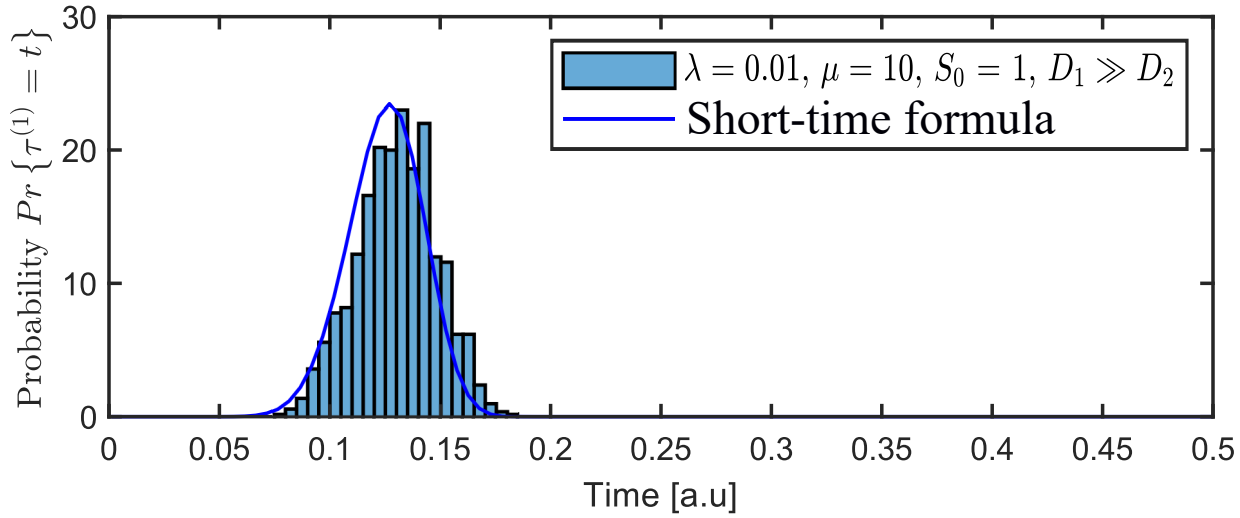

B MFAT vs N

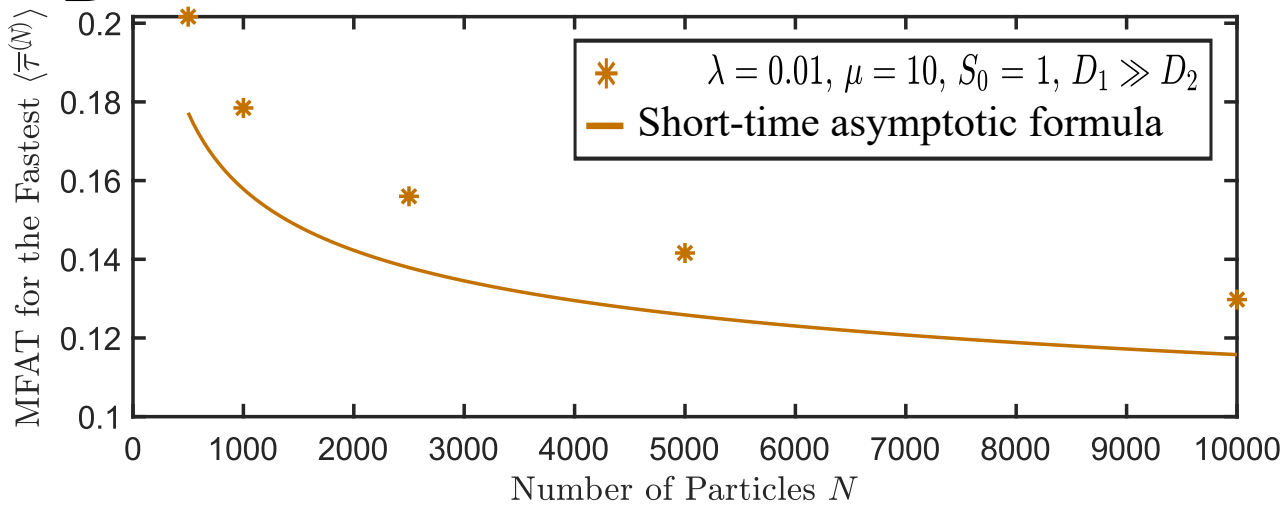

C Mean number of switching vs N

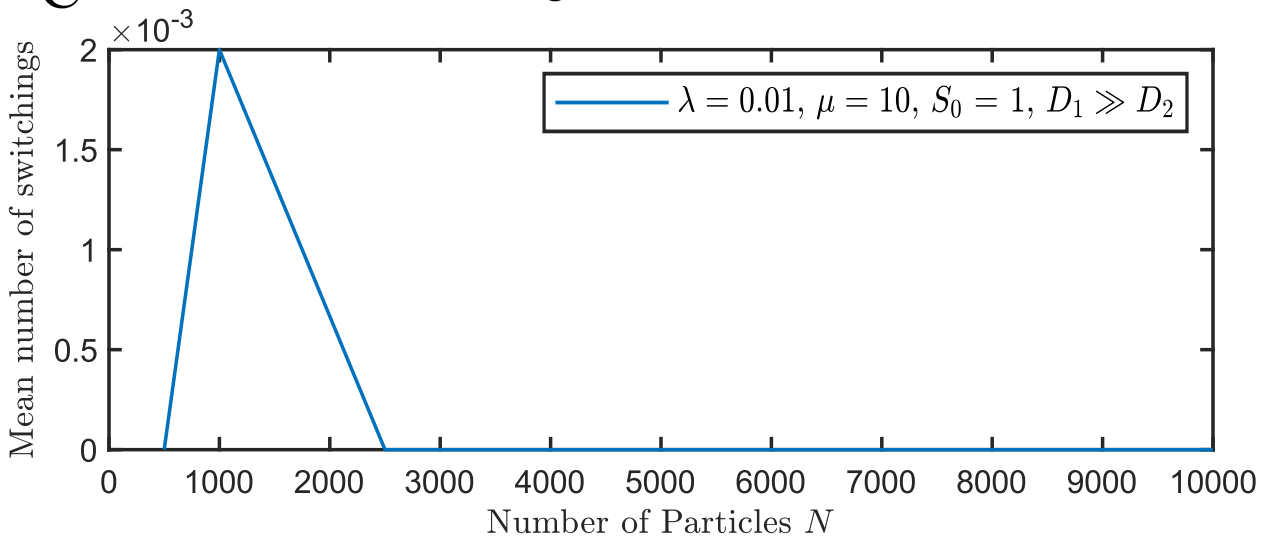

A Distribution time for the fastest particle among 10000

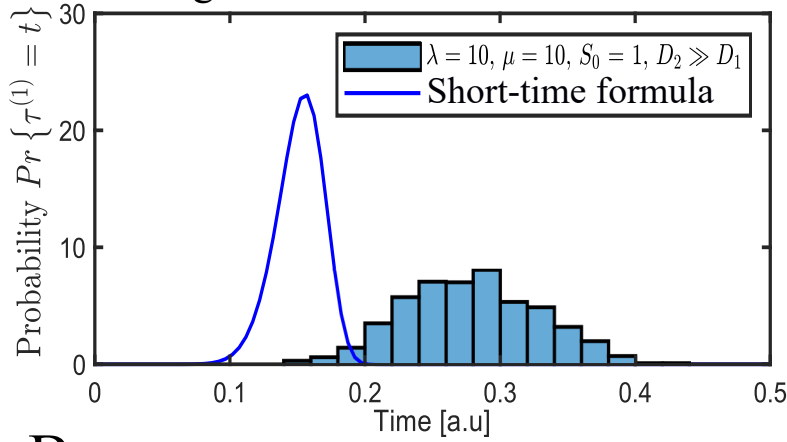

B MFAT vs N

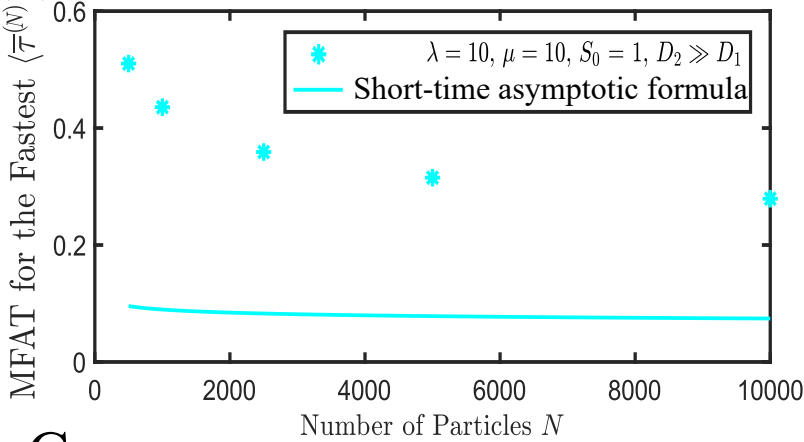

C Mean number of switching vs N

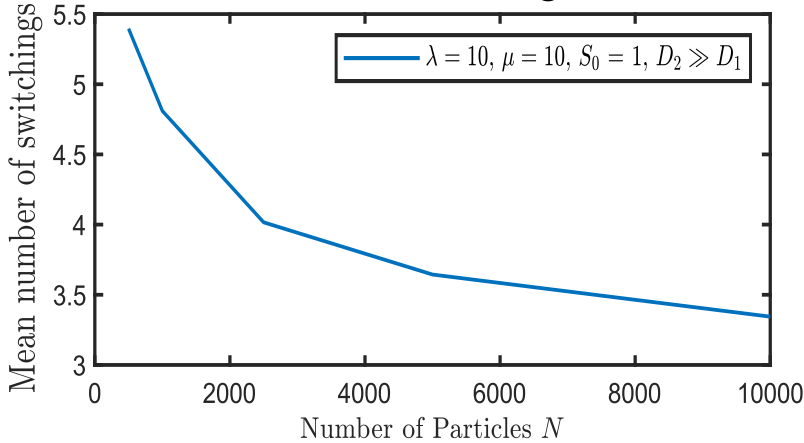

D Distribution of the switching instants

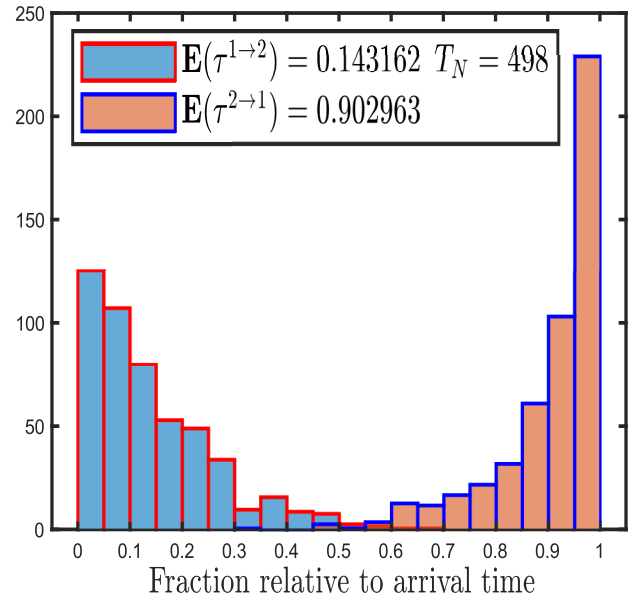

E Arrival times with a representation of the switching instants

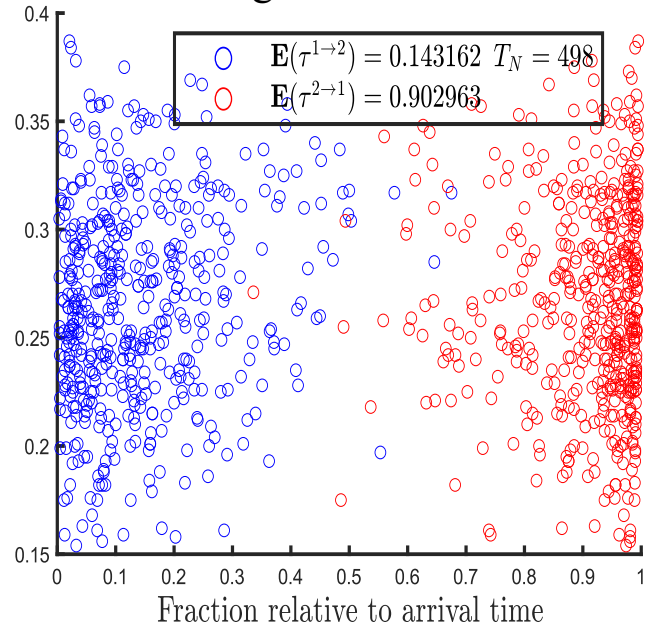

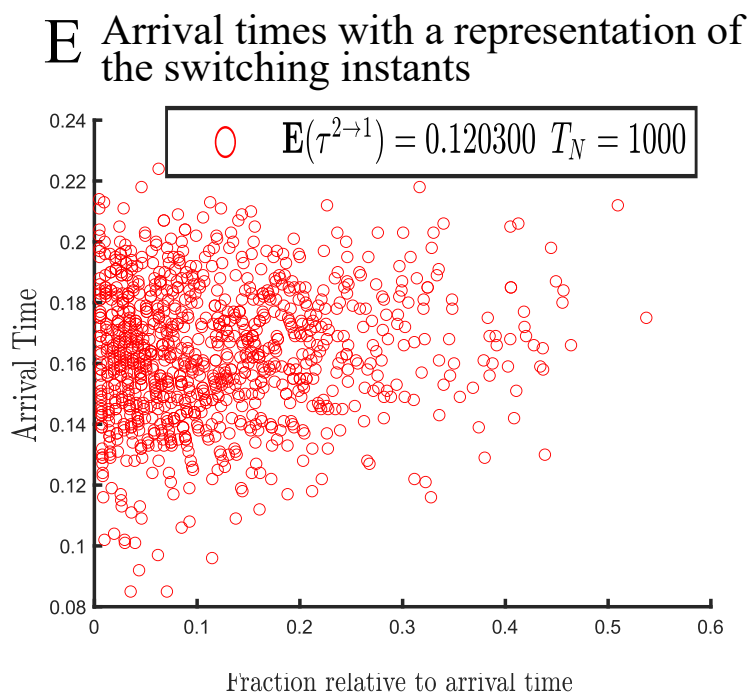
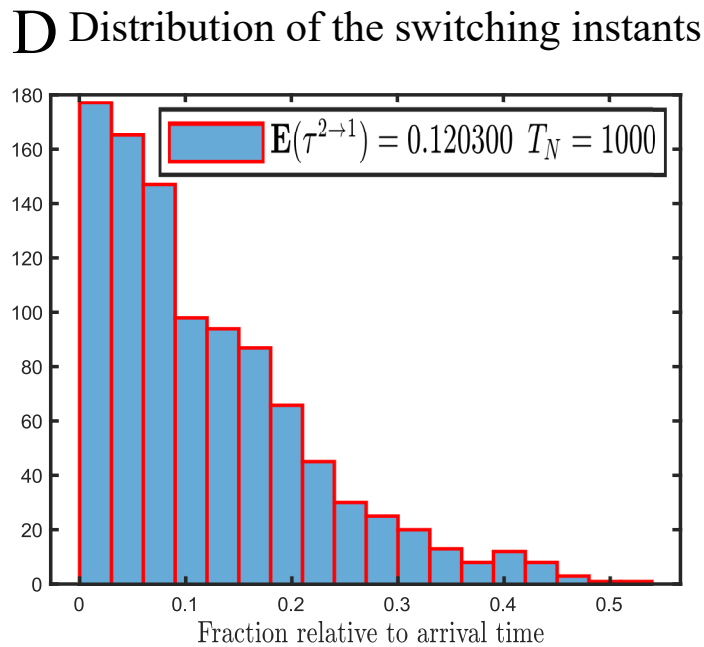
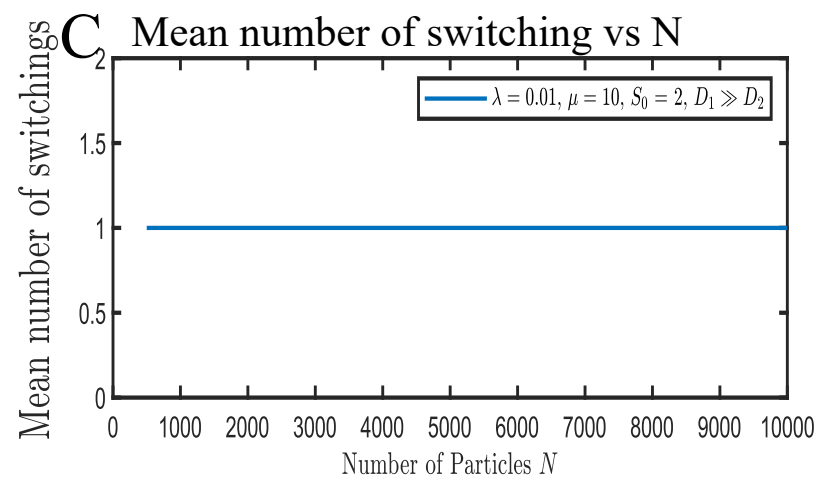
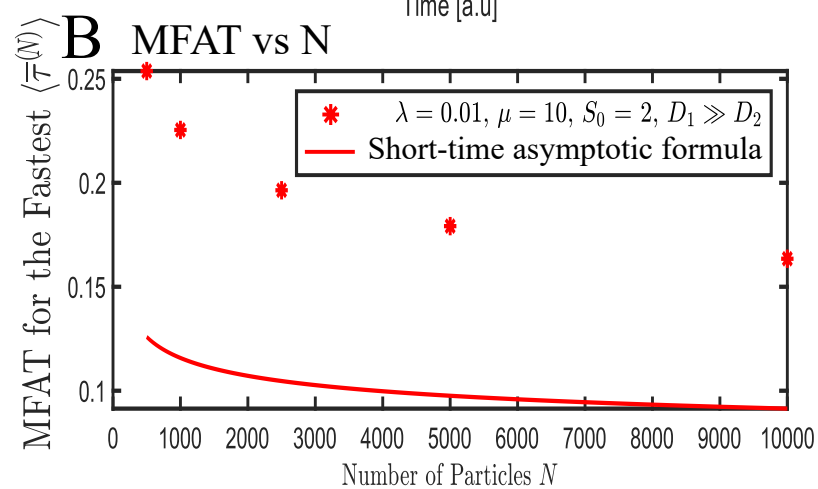
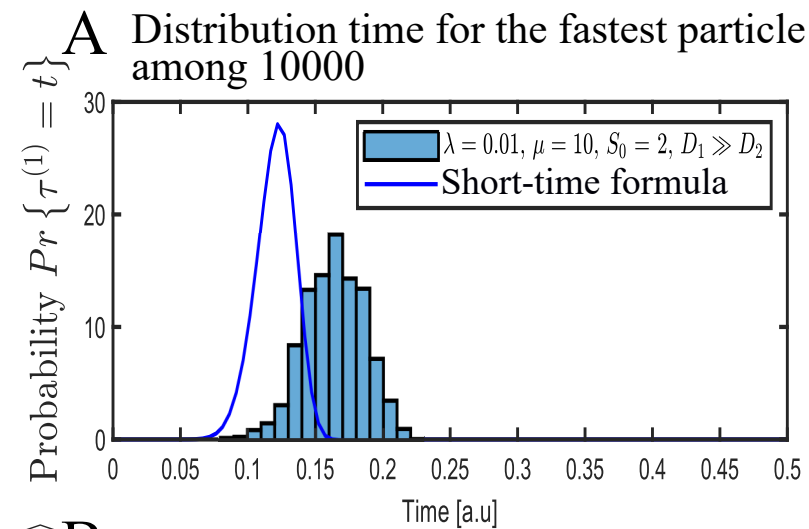

A Distribution time for the fastest particle among 10000

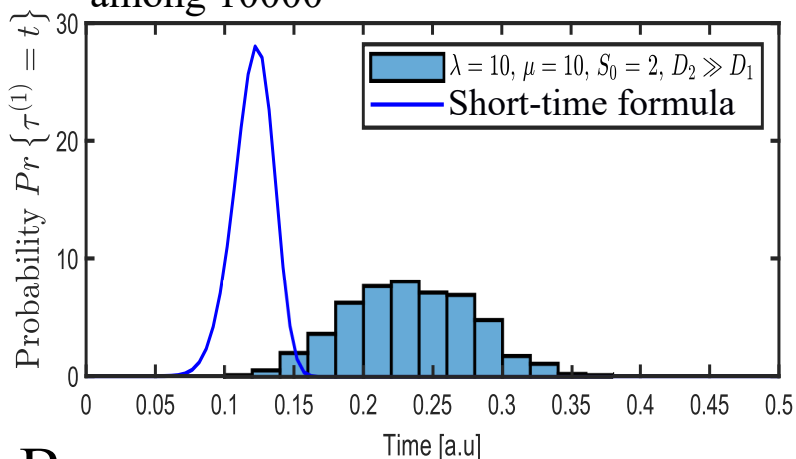

B MFAT vs N

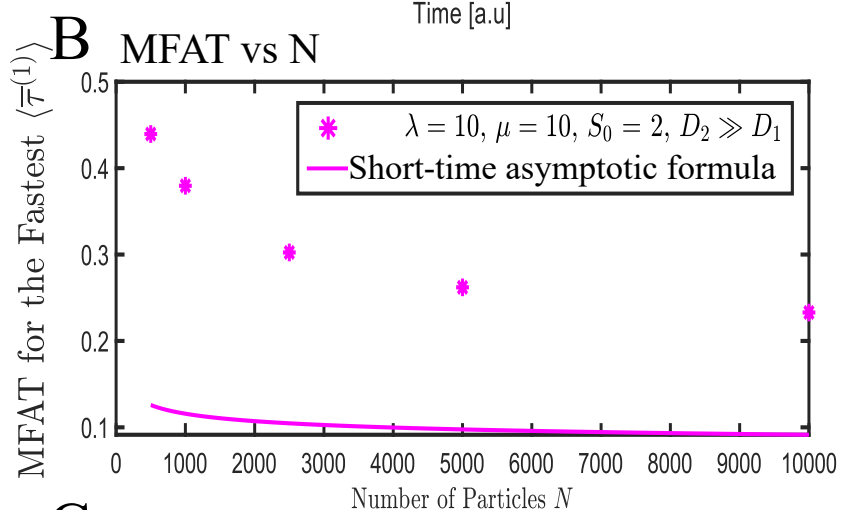

C Mean number of switchings vs N

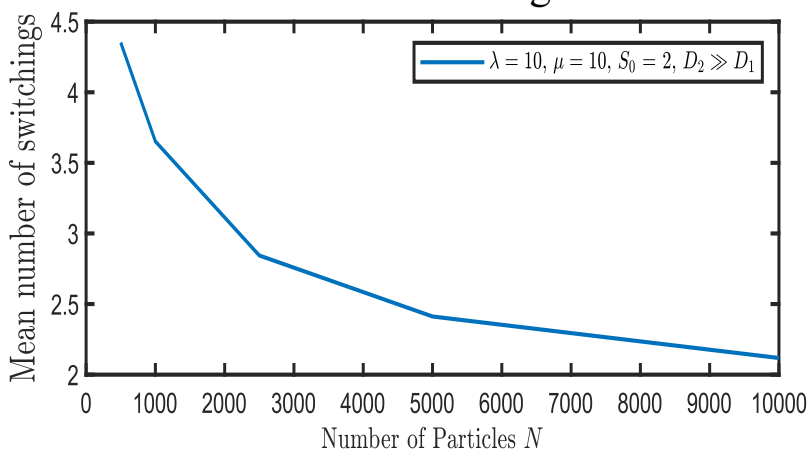

D Distribution of the switching instants

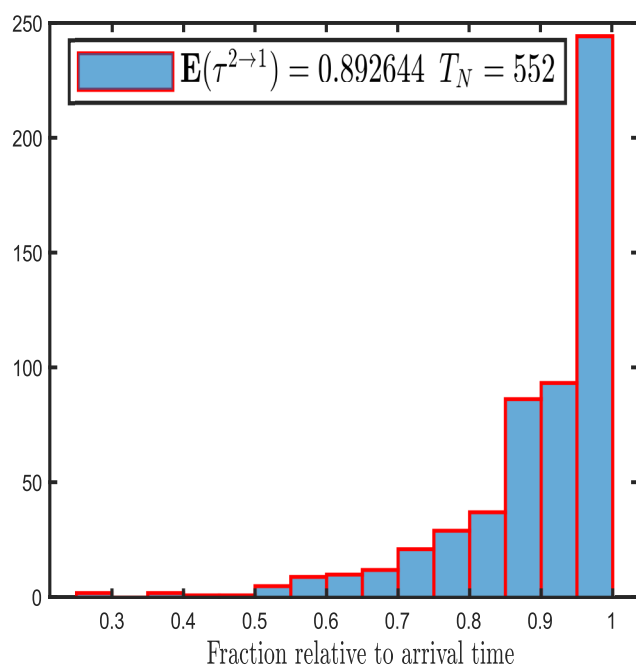

E Arrival times with a representation of the switching instants

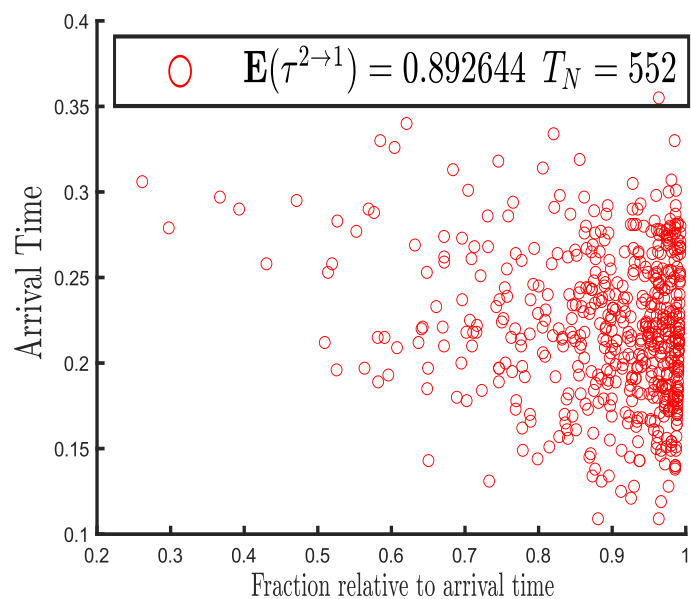

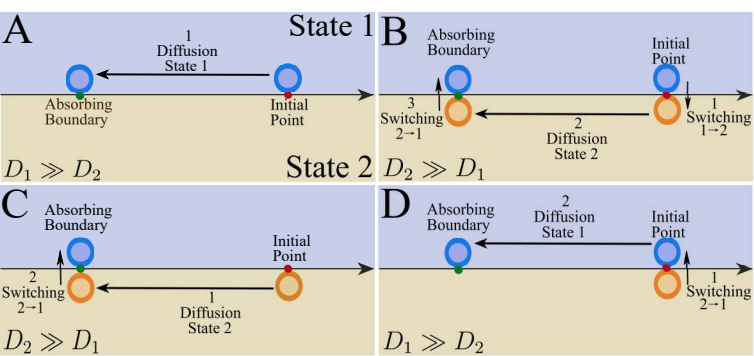

A Switching Brownian motion

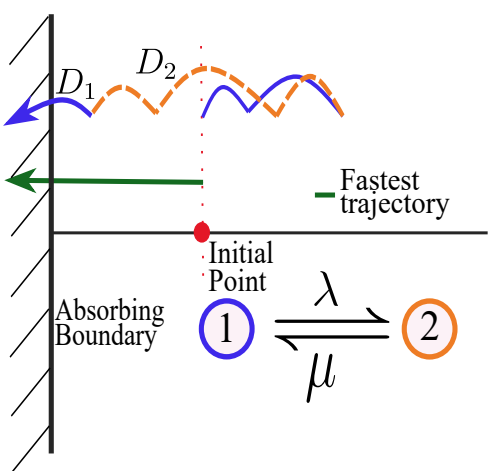

B Example of four initial distributions

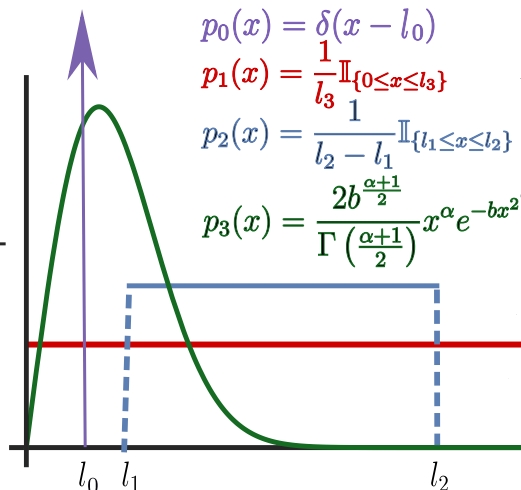

C Realization of a switching Brownian trajectory terminated at the absorbing boundary in state 1

