

L^1 Full Groups of Flows

François Le Maître

Konstantin Slutsky

Author address:

UNIVERSITÉ PARIS CITÉ AND SORBONNE UNIVERSITÉ, CNRS, IMJ-PRG,
F-75013 PARIS, FRANCE

Email address: francois.le-maitre@imj-prg.fr

DEPARTMENT OF MATHEMATICS, IOWA STATE UNIVERSITY, 411 MORRILL
ROAD, AMES, IA 50011

Email address: kslutsky@gmail.com

Contents

Chapter 1. Introduction	1
1.1. Main results	1
1.2. Preliminaries	4
Chapter 2. L^1 full groups of Polish group actions	7
2.1. L^1 spaces with values in metric spaces	7
2.2. L^1 full groups of Polish normed group actions	9
2.3. L^1 full groups and quasi-metric structures	13
2.4. Embedding L^1 isometrically in L^1 full groups	13
2.5. Stability under the first return map	14
Chapter 3. Polish finitely full groups	17
3.1. Polish full and finitely full groups	17
3.2. Derived subgroup and symmetric subgroup	19
3.3. Topological simplicity of the symmetric group	22
3.4. Maximal norms on the derived subgroup	25
Chapter 4. Full groups of locally compact group actions	27
4.1. Dense subgroups in L^1 full groups	27
4.2. Orbital transformations	31
4.3. The Hopf decomposition of elements of the full group	34
4.4. L^1 full groups and L^1 orbit equivalence	36
Chapter 5. Derived L^1 full groups for locally compact amenable groups	39
5.1. Dense chain of subgroups	39
5.2. Whirly amenability	41
5.3. Topological generators	43
Chapter 6. The index map for L^1 full groups of flows	47
6.1. Self commensurating automorphisms of a subset	47
6.2. The commensurating automorphism group	49
6.3. Index map on L^1 full groups of \mathbb{R} -flows	49
Chapter 7. Orbitwise ergodic bounded elements of full groups	53
Chapter 8. Conservative and intermitted transformations	59
Chapter 9. Dissipative and monotone transformations	67
9.1. Orbit limits and monotone transformations	67
9.2. Arrival and departure sets	69
9.3. Coherent modifications	71
9.4. Periodic approximations	74

Chapter 10. Conclusions	79
10.1. Topological ranks of L^1 full groups	79
10.2. Katznelson's conjugation theorem	80
10.3. L^1 orbit equivalence implies flip Kakutani equivalence	83
10.4. Maximality of the L^1 norm and geometry	86
Appendix A. Normed groups	89
A.1. Norms on groups	89
A.2. Maximal norms	90
Appendix B. Hopf decomposition	91
Appendix C. Actions of locally compact Polish groups	93
C.1. Disintegration of measure	93
C.2. Tessellations	96
C.3. Ergodic decomposition	99
Appendix D. Conditional measures	101
D.1. Conditional expectations	101
D.2. Conditional measures	102
D.3. Conditional measures and full groups	103
D.4. Aperiodicity	104
Bibliography	107

Abstract

We introduce the concept of an L^1 full group associated with a measure-preserving action of a Polish normed group on a standard probability space. Such groups are shown to carry a natural separable complete metric, and are thus Polish. Our construction generalizes L^1 full groups of actions of discrete groups, which have been studied recently by the first author.

We show that under minor assumptions on the actions, topological derived subgroups of L^1 full groups are topologically simple and — when the acting group is locally compact and amenable — are whirly amenable and generically two-generated. L^1 full groups of actions of compactly generated locally compact Polish groups are shown to remember the L^1 orbit equivalence class of the action.

For measure-preserving actions of the real line (also often called measure-preserving flows), the topological derived subgroup of an L^1 full group is shown to coincide with the kernel of the index map, which implies that L^1 full groups of free measure-preserving flows are topologically finitely generated if and only if the flow admits finitely many ergodic components. The latter is in a striking contrast to the case of \mathbb{Z} -actions, where the number of topological generators is controlled by the entropy of the action.

We also study the coarse geometry of the L^1 full groups. The L^1 norm on the derived subgroup of the L^1 full group of an aperiodic action of a locally compact amenable group is proved to be maximal in the sense of Rosendal. For measure-preserving flows, this holds for the L^1 norm on all of the L^1 full group.

2020 *Mathematics Subject Classification*. Primary 37A10, 37A15; Secondary 37A05, 37A20.

François Le Maître's research was partially supported by the ANR project AGRUME (ANR-17-CE40-0026), the ANR Project AODynG (ANR-19-CE40-0008) and the IdEx Université de Paris (ANR-18-IDEX-0001).

Konstantin Slutsky's research was partially supported by the ANR project AGRUME (ANR-17-CE40-0026) and NSF Grant DMS-2153981.

Introduction

Full groups were introduced by H. Dye [Dye59] in the framework of measure-preserving actions of countable groups as measurable analogues of unitary groups of von Neumann algebras, by mimicking the fact that the latter are stable under countable cutting and pasting of partial isometries. These Polish groups have since been recognized as important invariants as they encode the induced partition of the space into orbits. A similar viewpoint applies in the setup of minimal homeomorphisms on the Cantor space [GPS99], where likewise the full groups are responsible for the orbit equivalence class of the action.

Full groups are defined to consist of transformations which act by a permutation on each orbit. When the action is free, one can associate with an element h of the full group a cocycle defined by the equation $h(x) = \rho_h(x) \cdot x$. From the point of view of topological dynamics, it is natural to consider the subgroup of those h for which the cocycle map is continuous, which is the defining condition for the so-called topological full groups. The latter has a much tighter control of the action, and encodes minimal homeomorphisms of the Cantor space up to flip-conjugacy (see [GPS99]).

A celebrated result of H. Dye states that all ergodic \mathbb{Z} -actions produce the same partition up to isomorphism, and hence the associated full groups are all isomorphic. The first named author has been motivated by the above to seek for the analog of topological full groups in the context of ergodic theory, which was achieved in [LM18] by imposing integrability conditions on the cocycle. In particular, he introduced L^1 full groups of measure-preserving ergodic transformations, and showed based on the result of R. M. Belinskaja [Bel68] that they also determine the action up to flip-conjugacy. Unlike in the context of Cantor dynamics, these L^1 full groups are uncountable, but they carry a natural Polish topology.

In this work, we widen the concept of an L^1 full group and associate such an object with any measure-preserving Borel action of a Polish normed group (the reader may consult Appendix A for a concise reminder about group norms). Quasi-isometric compatible norms will result in the same L^1 full groups, so actions of Polish boundedly generated groups have canonical L^1 full groups associated with them based on to the work of C. Rosendal [Ros22]. Our study also parallels the generalization of the full group construction introduced by A. Carderi and the first named author in [CLM16], where full groups were defined for Borel measure-preserving actions of Polish groups.

1.1. Main results

Let G be a Polish group with a compatible norm $\|\cdot\|$ and consider a Borel measure-preserving action $G \curvearrowright X$ on a standard probability space (X, μ) . The group action defines an orbit equivalence relation \mathcal{R}_G by declaring points $x_1, x_2 \in X$

equivalent whenever $G \cdot x_1 = G \cdot x_2$. The norm induces a metric onto each \mathcal{R}_G -class via $D(x_1, x_2) = \inf_{g \in G} \{\|g\| : gx_1 = x_2\}$. Following [CLM16], a **full group** of the action is denoted by $[\mathcal{R}_G]$ and is defined as the collection of all measure-preserving $T \in \text{Aut}(X, \mu)$ that satisfy $x\mathcal{R}_G Tx$ for all $x \in X$. The L^1 **full group** $[G \curvearrowright X]_1$ is given by those $T \in [\mathcal{R}_G]$ for which the map $X \ni x \mapsto D(x, Tx)$ is integrable. This defines a subgroup of $[\mathcal{R}_G]$, and we show in Theorem 2.10 that these groups are Polish in the topology of the norm $\|T\| = \int_X D(x, Tx) d\mu(x)$. The strategy of establishing this statement is analogous to that of [CLM18], where the Polish topology for full groups $[\mathcal{R}_G]$ was defined.

It is a general and well-known phenomenon in the study of all kinds and variants of full groups that their structure is usually best understood through the derived subgroups. Our setup is no exception.

THEOREM 1. *The topological derived group of any aperiodic L^1 full group is equal to the closed subgroup generated by involutions.*

The argument needed for Theorem 1 is quite robust. We extract the idea used in [LM18], isolate the class of finitely full groups, and show that under mild assumptions on the action, Theorem 1 holds for such groups. We provide these arguments in Section 3 and in Corollary 3.15 in particular. Alongside we mention Corollary 3.21 which implies that L^1 full groups of ergodic actions are topologically simple.

For the rest of our results we narrow down the generality of the acting groups, and consider *locally compact* Polish normed groups. In Chapter 4, we show that if $H < G$ is a dense subgroup of a locally compact Polish normed group G then $[H \curvearrowright X]_1$ is dense in $[G \curvearrowright X]_1$. In fact, we prove a considerably stronger statement by showing that for each $T \in [G \curvearrowright X]$ and $\epsilon > 0$ there is $S \in [H \curvearrowright X]$ such that $\text{ess sup}_{x \in X} D(Tx, Sx) < \epsilon$.

Recall that a topological group is **amenable** if all of its continuous actions on compact spaces preserve some Radon probability measure, and that it is **whirly amenable** if it is amenable and moreover every invariant Radon measure is supported on the set of fixed points. The following is a combination of Theorem 5.8 and Corollary 5.10.

THEOREM 2. *Let $G \curvearrowright X$ be a measure-preserving action of a locally compact Polish normed group. Consider the following three statements:*

- (1) G is amenable;
- (2) the topological derived group $D([G \curvearrowright X]_1)$ is whirly amenable.
- (3) the L^1 full group $[G \curvearrowright X]_1$ is amenable;

The implications (1) \implies (2) \implies (3) always hold. If G is unimodular and the action is free, then the three statements above are all equivalent.

When the acting group is amenable and orbits of the action are uncountable, we are able to compute the topological rank of the derived L^1 full groups — that is, the minimal number of elements needed to generate a dense subgroup. Theorem 5.19 contains a stronger version of the following.

THEOREM 3. *Let $G \curvearrowright X$ be a measure-preserving action of an amenable locally compact Polish normed group on a standard probability space (X, μ) . If all orbits of the action are uncountable, then the topological rank of the derived L^1 full group $D([G \curvearrowright X]_1)$ is equal to 2.*

It is instructive to contrast the situation with the actions of finitely generated groups, where finiteness of the topological rank of the derived L^1 full group is equivalent to finiteness of the Rokhlin entropy of the action [LM21].

Our most refined understanding of L^1 full groups is achieved for free actions of \mathbb{R} , which are known as **flows**. All the results we described so far are valid for all compatible norms on the acting group. When it comes to the actions of \mathbb{R} , however, we consider only the standard Euclidean norm on it. Just like the actions of \mathbb{Z} , flows give rise to an important homomorphism, known as the **index map**. Assuming the flow is ergodic, the index map can be described most easily as $[\mathbb{R} \curvearrowright X]_1 \ni T \mapsto \int_X |\rho_T| d\mu$, where ρ_T is the cocycle of T . Chapter 6 is devoted to the analysis of the index map for general \mathbb{R} -flows.

The most technically challenging result of our work is summarized in Theorem 10.1, which identifies the derived L^1 full group of a flow with the kernel of the index map, and describes the abelianization of $[\mathbb{R} \curvearrowright X]_1$.

THEOREM 4. *Let \mathcal{F} be a measure-preserving flow on (X, μ) . The kernel of the index map is equal to the derived L^1 full group of the flow, and the topological abelianization of $[\mathcal{F}]_1$ is \mathbb{R} .*

Theorem 4 parallels the known results for \mathbb{Z} -actions from [LM18]. The structure of its proof, however, has an important difference. We rely crucially on the fact that each element of the full group acts in a measure-preserving manner on each orbit. This allows us to use Hopf's decomposition (described in Appendix B) in order to separate any given element $T \in [\mathbb{R} \curvearrowright X]_1$ into two parts — recurrent and dissipative. If the acting group were discrete, the recurrent part would reduce to periodic orbits only. This is not at all the case for non-discrete groups, hence we need a new machinery to understand non-periodic recurrent transformations. To cope with this, we introduce the concept of an **intermittent** transformation, which plays the central role in Chapter 8, and which we hope will find other applications.

Theorems 3 and 4 can be combined to obtain estimates for the topological rank of the whole L^1 full groups of flows, which is the content of Proposition 10.3.

THEOREM 5. *Let \mathcal{F} be a free measure-preserving flow on a standard probability space (X, μ) . The topological rank $\text{rk}([\mathcal{F}]_1)$ is finite if and only if the flow has finitely many ergodic components. Moreover, if \mathcal{F} has exactly n ergodic components then*

$$n + 1 \leq \text{rk}([\mathcal{F}]_1) \leq n + 3.$$

In particular, the topological rank of the L^1 full group of an ergodic flow is equal to either 2, 3 or 4. We conjecture that it is always equal to 2, and more generally that the topological rank of the L^1 full group of any measure-preserving flow is equal to $n + 1$ where n is the number of ergodic components.

Our work connects to the notion of L^1 orbit equivalence, an intermediate notion between orbit equivalence and conjugacy. It can be traced back to the work of R. M. Belinskaja [Bel68] but recently attracted more attention. Stated in our framework, two flows are L^1 orbit equivalent if they can be conjugated so that the first flow is contained in the L^1 full group of the second and vice versa. A symmetric version of Belinskaja's theorem is that ergodic \mathbb{Z} -actions are L^1 orbit equivalent if and only if they are flip conjugate. It is very natural to wonder whether this amazing result has a version for flows. Our Theorem 10.14 implies the following.

THEOREM 6. *If two measure-preserving ergodic flows are L^1 orbit equivalent, then they admit some cross-sections whose induced transformations¹ are flip-conjugate.*

We do not know whether the above result is optimal, that is, whether having flip-conjugate cross-sections implies L^1 orbit equivalence, but it seems unlikely. It is tempting to think that the correct analogue of Belinskaja’s theorem would be a positive answer to the following question.

QUESTION 1.1. *Let \mathcal{F}_1 and \mathcal{F}_2 be free ergodic measure-preserving flows which are L^1 orbit equivalent. Is it true that there is $\alpha \in \mathbb{R}^*$ such that \mathcal{F}_1 and $\mathcal{F}_2 \circ m_\alpha$ are isomorphic, where m_α denotes the multiplication by α ?*

Let us also mention that Theorem 6 implies that there are uncountably many L^1 full groups of ergodic free measure-preserving flows up to (topological) group isomorphism (see Corollary 10.16 and the paragraph right after its proof).

Finally, we also investigate the coarse geometry of the L^1 full groups. We establish that the L^1 norm is maximal (in the sense of C. Rosendal [Ros22], see also Appendix A.2) on the derived subgroup of an L^1 full group of an aperiodic measure-preserving action of any locally compact amenable Polish group (Theorem 5.5). For the measure-preserving flows, the L^1 norm is, in fact, maximal on the whole full group (Theorem 10.18).

1.2. Preliminaries

1.2.1. Ergodic theory. Our work belongs to the field of ergodic theory, which means that all the constructions are defined and results are proven up to null sets. On a number of occasions, we allow ourselves to deviate from the pedantic accuracy and write “for all $x \dots$ ” when we really ought to say “for almost all $x \dots$ ”, etc. The only part where certain care needs to be exercised in this regard appears in Chapter 2. We define L^1 full groups for *Borel* measure-preserving actions of Polish normed groups, and we need a genuine action on the space X for these to make sense just as in [CLM16]. Boolean actions (also called near actions) of general Polish groups do not admit realizations in general [GTW05], and even when they do, it could happen that different realizations yield different full groups. This subtlety disappears once we move our attention to locally compact group actions, which is the case for Chapter 4 and onwards. All Boolean actions of locally compact Polish groups admit Borel realizations which are all conjugate up to measure zero (and hence have the same full group), so null sets can be neglected just as they always are in ergodic theory.

By a **standard probability space** we mean the unique (up to isomorphism) separable atomless measure space (X, μ) with $\mu(X) = 1$, i.e., the unit interval $[0, 1]$ with the Lebesgue measure. A few times in Chapter 5 and Appendix C.1 we refer to a **standard Lebesgue space**, by which we mean a separable finite measure space, $\mu(X) < \infty$, thus in contrast to the notion of the standard probability space allowing atoms and omitting the normalization requirement. We denote by $\text{Aut}(X, \mu)$ the group of all measure-preserving bijections of (X, μ) up to measure zero. This is a Polish group for the **weak topology**, defined by $T_n \rightarrow T$ if and only if for all

¹We refer the reader to Definition 10.11 and the paragraph that follows it for details on the measure-preserving transformation one associates to a cross-section.

$A \subseteq X$ Borel, $\mu(T_n(A) \Delta T(A)) \rightarrow 0$. The weak topology is a Polish group topology, see [Kec10, Sec. 1]. Given $T \in \text{Aut}(X, \mu)$, its **support** is the set

$$\text{supp } T = \{x \in X : T(x) \neq x\}.$$

A measure-preserving bijection T is called **periodic** when almost all its orbits are finite. Periodicity implies the existence of a **fundamental domain** A for T , namely a measurable set which intersects every T -orbit at exactly one point. Since the ambient measure μ is finite, the existence of a fundamental domain actually characterizes periodicity.

1.2.2. Orbit equivalence relations. Any group action $G \curvearrowright X$ induces the orbit equivalence relation $\mathcal{R}_{G \curvearrowright X}$, where two points $x, y \in X$ are $\mathcal{R}_{G \curvearrowright X}$ -equivalent whenever $G \cdot x = G \cdot y$. We will usually write this equivalence relation simply as \mathcal{R}_G for brevity. For the actions $\mathbb{Z} \curvearrowright X$ generated by an automorphism $T \in \text{Aut}(X, \mu)$, we denote the corresponding orbit equivalence relation by \mathcal{R}_T . For clarity, we may sometimes want to name a measure-preserving action as α and write $G \overset{\alpha}{\curvearrowright} X$. Then for all $g \in G$ we denote by $\alpha(g)$ the measure-preserving transformation of (X, μ) induced by the action of g .

We encounter various equivalence relations throughout this monograph. An equivalence class of a point $x \in X$ under the relation \mathcal{R} is denoted by $[x]_{\mathcal{R}}$ and the **saturation** of a set $A \subseteq X$ is denoted by $[A]_{\mathcal{R}}$ and is defined to be the union of \mathcal{R} -equivalence classes of the elements of A : $[A]_{\mathcal{R}} = \bigcup_{x \in A} [x]_{\mathcal{R}}$. In particular, $[x]_{\mathcal{R}_T}$ is the orbit of x under the action of T . The reader may notice that the notation for a saturation $[A]_{\mathcal{R}}$ resembles that for the full group of an action $[G \curvearrowright X]$ (see Chapter 2). Both notations are standard, and we hope that confusion will not arise, as it applies to objects of different nature — sets and actions, respectively.

1.2.3. Actions of locally compact groups. Consider a measure-preserving action of a locally compact Polish (equivalently, second-countable) group G on a standard Lebesgue space (X, μ) . A **complete section** for the action is a measurable set $\mathcal{C} \subseteq X$ that intersects almost every orbit, i.e., $\mu(X \setminus G \cdot \mathcal{C}) = 0$. A **cross-section** is a complete section $\mathcal{C} \subseteq X$ such that for some non-empty neighborhood of the identity $U \subseteq G$ we have $Uc \cap Uc' = \emptyset$ whenever $c, c' \in \mathcal{C}$ are distinct. When the need to mention such a neighborhood U explicitly arises, we say that \mathcal{C} is a **U -lacunary** cross-section.

With any cross-section \mathcal{C} one associates a decomposition of the phase space known as the Voronoi tessellation. Slightly more generally, Appendix C.2 defines the concept of a tessellation over a cross-section, which corresponds to a set $\mathcal{W} \subseteq \mathcal{C} \times X$ for which the fibers $\mathcal{W}_c = \{x \in X : (c, x) \in \mathcal{W}\}$, $c \in \mathcal{C}$, partition the phase space. Every tessellation \mathcal{W} gives rise to an equivalence relation $\mathcal{R}_{\mathcal{W}}$, where points $x, y \in X$ are deemed equivalent whenever they belong to the same fiber \mathcal{W}_c , and to the projection map $\pi_{\mathcal{W}} : X \rightarrow \mathcal{C}$ that associates with each $x \in X$ the unique $c \in \mathcal{C}$ which fiber \mathcal{W}_c the point x belongs to, and is therefore defined by the condition $(\pi_{\mathcal{W}}(x), x) \in \mathcal{W}$ for all $x \in X$.

When the action $G \curvearrowright X$ is free, each orbit $G \cdot x$ can be identified with the acting group. Such a correspondence $g \mapsto gx$ depends on the choice of the anchor point x within the orbit, but suffices to transfer structures invariant under right translations from the group G onto the orbits of the action. For instance, if the acting group is locally compact, then a right-invariant Haar measure λ can be pushed onto orbits by setting $\lambda_x(A) = \{g \in G : gx \in A\}$ as discussed in Section 4.2.

Freeness of the action $G \curvearrowright X$ gives rise to the **cocycle map** $\rho : \mathcal{R}_{G \curvearrowright X} \rightarrow G$ which is well-defined by the condition $\rho(x, y) \cdot x = y$. Elements of the full group $[G \curvearrowright X]$ are characterized as measure-preserving transformations $T \in \text{Aut}(X, \mu)$ such that $(T(x), x) \in \mathcal{R}_{G \curvearrowright X}$ for all $x \in X$. With each $T \in [G \curvearrowright X]$ one may therefore associate the map $\rho_T : X \rightarrow G$, also known as the **cocycle map**, and defined by $\rho_T(x) = \rho(x, Tx)$. Both the context and the notation will clarify which cocycle map is being referred to.

All these concepts appear prominently in the chapters which deal with free measure-preserving flows, that is actions of \mathbb{R} on the standard probability space. We use the additive notation for such actions: $\mathbb{R} \times X \ni (x, r) \mapsto x + r \in X$. The group \mathbb{R} carries a natural linear order which is invariant under the group operation and can therefore be transferred onto orbits. More specifically, given a free measure-preserving flow $\mathbb{R} \curvearrowright X$ we use the notation $x < y$ whenever x and y belong to the same orbit and $y = x + r$ for some $r > 0$. Every cross-section \mathcal{C} of a free flow intersects each orbit in a bi-infinite fashion — each $c \in \mathcal{C}$ has a unique successor and a unique predecessor in the order of the orbit. One therefore has a bijection $\sigma_{\mathcal{C}} : \mathcal{C} \rightarrow \mathcal{C}$, called the **the first return map** or **the induced map**, which sends $c \in \mathcal{C}$ to the next element of the cross-section within the same orbit. We also make use of the gap function that measures the lengths of intervals of the cross-section, i.e., $\text{gap}_{\mathcal{C}}(c) = \rho(c, \sigma_{\mathcal{C}}(c))$.

There is also a canonical tessellation associated with a cross-section \mathcal{C} which partitions each orbit into intervals between adjacent points of \mathcal{C} and is given by $\mathcal{W}_{\mathcal{C}} = \{(c, x) \in \mathcal{C} \times X : c \leq x < \sigma_{\mathcal{C}}(c)\}$. The associated equivalence relation $\mathcal{R}_{\mathcal{W}_{\mathcal{C}}}$ is denoted simply by $\mathcal{R}_{\mathcal{C}}$ and groups points $(x, y) \in \mathcal{R}_{\mathbb{R} \curvearrowright X}$ which belong to the same interval of the tessellation, $\pi_{\mathcal{C}}(x) = \pi_{\mathcal{C}}(y)$. The $\mathcal{R}_{\mathcal{C}}$ -equivalence class of $x \in X$ is equal to $[x]_{\mathcal{R}_{\mathcal{C}}} = \pi_{\mathcal{C}}(x) + [0, \text{gap}_{\mathcal{C}}(\pi_{\mathcal{C}}(x))]$.

Often enough we need to restrict sets and functions to an $\mathcal{R}_{\mathcal{C}}$ -class. Since such a need arises very frequently, especially in Chapter 9, we adopt the following shorthand notations. Given a set $A \subseteq X$ and a point $c \in \mathcal{C}$ the intersection $A \cap [c]_{\mathcal{R}_{\mathcal{C}}}$ is denoted simply by $A(c)$. Likewise, $\lambda_c^{\mathcal{W}_{\mathcal{C}}}(A)$ stands for $\lambda(\{r \in \mathbb{R} : c+r \in A \cap [c]_{\mathcal{R}_{\mathcal{C}}}\})$ and corresponds to the Lebesgue measure of the set $A \cap [c]_{\mathcal{R}_{\mathcal{C}}}$. Moreover, $\lambda_c^{\mathcal{W}_{\mathcal{C}}}(A)$ will usually be shortened to $\lambda_c^{\mathcal{C}}(A)$, when the tessellation is clear from the context.

CHAPTER 2

L^1 full groups of Polish group actions

We begin by defining the key notion of interest for our work, namely the L^1 full groups of measure-preserving Borel actions of Polish normed groups on a standard probability space. Admittedly, the overall focus will be on actions of locally compact groups, and flows in particular. Nonetheless, the concept of an L^1 full group can be introduced for actions of arbitrary Polish normed groups, and we therefore begin with this level of generality.

2.1. L^1 spaces with values in metric spaces

By a **Polish metric space** we mean a separable complete metric space.

DEFINITION 2.1. Let (X, μ) be a standard probability space, let (Y, d_Y) be a Polish metric space, and let $\hat{e} : X \rightarrow Y$ be a measurable function. We define the \hat{e} -**pointed L^1 space** $L^1_{\hat{e}}(X, Y)$ as the metric space of measurable functions $f : X \rightarrow Y$ such that $\int_X d_Y(\hat{e}(x), f(x)) d\mu(x) < +\infty$, equipped with the metric

$$\tilde{d}_Y(f_1, f_2) = \int_X d_Y(f_1(x), f_2(x)) d\mu(x),$$

which is finite by the triangle inequality using the function \hat{e} as the middle point.

PROPOSITION 2.2. *Let (X, μ) be a standard probability space and (Y, d_Y) be a Polish metric space. $(L^1_{\hat{e}}(X, Y), \tilde{d}_Y)$ is a Polish metric space for any measurable function $\hat{e} : X \rightarrow Y$.*

PROOF. The argument follows closely the classical proof that $(L^1(X, \mathbb{R}), \tilde{d}_{\mathbb{R}})$ is a Polish metric space. To check completeness, let us pick a Cauchy sequence $(f_n)_{n \in \mathbb{N}}$ in $L^1_{\hat{e}}(X, Y)$. Without loss of generality we may assume that $\tilde{d}_Y(f_n, f_{n+1}) < 2^{-n}$, $n \in \mathbb{N}$. Consider the sets $A_n = \{x \in X : d_Y(f_n(x), f_{n+1}(x)) \geq 1/n^2\}$, $n \geq 1$. Chebyshev's inequality shows that $\mu(A_n) \leq n^2 2^{-n}$, whence $\sum_n \mu(A_n) < \infty$. The Borel–Cantelli lemma implies that $(f_n(x))_{n \in \mathbb{N}}$ is pointwise Cauchy for almost every $x \in X$. Since (Y, d_Y) is complete, the pointwise limit of $(f_n)_{n \in \mathbb{N}}$ exists, and we denote it by $f : X \rightarrow Y$. Define functions $h_n, h : X \rightarrow \mathbb{R}^{\geq 0}$ by

$$h_n(x) = \sum_{i < n} d_Y(f_i(x), f_{i+1}(x)), \quad h(x) = \sum_{i \in \mathbb{N}} d_Y(f_i(x), f_{i+1}(x)) = \lim_{n \rightarrow \infty} h_n(x),$$

and note that $h \in L^1(X, \mathbb{R})$ by Fatou's lemma. Finally, we conclude that

$$\begin{aligned} \tilde{d}_Y(f_n, f) &= \int_X d_Y(f_n(x), f(x)) d\mu(x) \leq \int_X \sum_{k=n}^{\infty} d_Y(f_k(x), f_{k+1}(x)) d\mu(x) \\ &= \int_X (h(x) - h_n(x)) d\mu(x) \rightarrow 0, \end{aligned}$$

where the last convergence follows from Lebesgue's dominated convergence theorem.

To verify separability, pick a countable dense set $D \subseteq Y$ and note that the subspace of maps taking values in D is \tilde{d}_Y -dense (in fact, this subspace is dense in the much stronger *sup* metric). It then follows that the set of functions that take only finitely many values (all of which are elements of D) is still dense. Finally, one uses a dense countable subalgebra of the measure algebra on X and further restricts this subspace to the functions that are measurable with respect to the chosen subalgebra. The resulting countable collection is dense in $L_{\hat{e}}^1(X, Y)$. \square

The group of measure-preserving automorphisms $\text{Aut}(X, \mu)$ has a natural action by composition on $L_{\hat{e}}^1(X, Y)$, i.e., $(T \cdot f)(x) = f(T^{-1}x)$. Note that every automorphism acts by an isometry.

PROPOSITION 2.3. *Let (X, μ) be a standard probability space, (Y, d_Y) be a Polish metric space, and $\hat{e} : X \rightarrow Y$ be a measurable function. The action of $\text{Aut}(X, \mu)$ on $L_{\hat{e}}^1(X, Y)$ is continuous.*

PROOF. The argument mirrors the one in [CLM16, Prop. 2.9(1)]. Given sequences $T_n \rightarrow T$ and $f_n \rightarrow f$ we need to show that $T_n \cdot f_n \rightarrow T \cdot f$. Since the action is by isometries,

$$\tilde{d}_Y(T_n \cdot f_n, T \cdot f) = \tilde{d}_Y(f_n, T_n^{-1}T \cdot f) \leq \tilde{d}_Y(f_n, f) + \tilde{d}_Y(f, T_n^{-1}T \cdot f).$$

It therefore suffices to show that for any $f \in L_{\hat{e}}^1(X, Y)$ and any convergent sequence of automorphisms $T_n \rightarrow T$ one has $\tilde{d}_Y(f, T_n^{-1} \circ T \cdot f) \rightarrow 0$ as $n \rightarrow \infty$. The latter is enough to check for functions that take only finitely many values since those are dense in $L_{\hat{e}}^1(X, Y)$. Suppose f is such a step function over a partition $X = \bigsqcup_{i=1}^m A_i$. Convergence $T_n \rightarrow T$ implies $\mu(T_n^{-1}T(A_i) \Delta A_i) \rightarrow 0$ for all $1 \leq i \leq m$, which easily yields $\tilde{d}_Y(f, T_n^{-1}T \cdot f) \rightarrow 0$. \square

When Y is a Polish group, there is a natural choice of the function \hat{e} , namely the constant function $\hat{e}(x) = e$, where e is the identity element of the group. We therefore simplify the notation in this case and write $L^1(X, Y)$, omitting the subscript \hat{e} .

Recall that a **Polish normed group** is a Polish group together with a compatible norm on it (see Appendix A.1). In particular, if $(G, \|\cdot\|)$ is a Polish normed group, there is a canonical choice of a complete metric on G , namely

$$d_G(u, v) = (\|u^{-1}v\| + \|vu^{-1}\|)/2.$$

The corresponding space $L^1(X, G)$ is Polish by Proposition 2.2. Moreover, it is a Polish group under pointwise operations.

PROPOSITION 2.4. *Let $(G, \|\cdot\|)$ be a Polish normed group, and let $G \curvearrowright X$ be a Borel measure-preserving action on a standard probability space. The space $L^1(X, G)$ is a Polish normed group under the pointwise operations, $(f \cdot g)(x) = f(x)g(x)$, $f^{-1}(x) = f(x)^{-1}$, and the norm $\|f\|_1^{L^1(X, G)} = \int_X \|f(x)\| d\mu(x)$.*

PROOF. The space $L^1(X, G)$ can equivalently be defined as the collection of all measurable functions $f : X \rightarrow G$ with finite norm, $\|f\|_1^{L^1(X, G)} < \infty$. Using the

properties of the norm $\|\cdot\|$ on G ,

$$\begin{aligned} \|fg\|_1^{L^1(X,G)} &= \int_X \|f(x)g(x)\| d\mu(x) \leq \int_X (\|f(x)\| + \|g(x)\|) d\mu(x) \\ &= \|f\|_1^{L^1(X,G)} + \|g\|_1^{L^1(X,G)}, \\ \|f^{-1}\|_1^{L^1(X,G)} &= \int_X \|f(x)^{-1}\| d\mu(x) \leq \int_X \|f(x)\| d\mu(x) = \|f\|_1^{L^1(X,G)}. \end{aligned}$$

Hence, $L^1(X, G)$ is closed under the group operations and $\|\cdot\|_1^{L^1(X,G)}$ is a group norm on it.

To show that group operations are continuous, it suffices to check that for any $g \in L^1(X, G)$ and any sequence $f_n \in L^1(X, G)$, $n \in \mathbb{N}$, converging to zero, $\|f_n\|_1^{L^1(X,G)} \rightarrow 0$, there is a subsequence $(f_{n_k})_k$ such that $\|gf_{n_k}g^{-1}\|_1^{L^1(X,G)} \rightarrow 0$ as $k \rightarrow \infty$ (see, for instance, [BO10, Thm 3.4 and Lem. 3.5]).

Since f_n converges to 0 in $L^1(X, G)$, we may pass to a subsequence $(f_{n_k})_k$ such that $\|f_{n_k}(x)\| \rightarrow 0$ for almost all $x \in X$. Let $M = \max_k \{\|f_{n_k}\|_1^{L^1(X,G)}\}$ and note that for all k

$$\int_X \|g(x)f_{n_k}(x)g(x)^{-1}\| d\mu(x) \leq \int_X (2\|g(x)\| + \|f_{n_k}(x)\|) d\mu(x) \leq 2\|g\|_1^{L^1(X,G)} + M.$$

It remains to apply Lebesgue's dominated convergence theorem to the sequence $gf_{n_k}g^{-1}$, $k \in \mathbb{N}$, concluding that $\|gf_{n_k}g^{-1}\|_1^{L^1(X,G)} \rightarrow 0$. \square

2.2. L^1 full groups of Polish normed group actions

Let $(G, \|\cdot\|)$ be a Polish normed group, and let $G \curvearrowright X$ be a measure-preserving Borel action on a standard probability space (X, μ) . Let also $\mathcal{R}_G \subseteq X \times X$ denote the equivalence relation induced by this action, namely

$$\mathcal{R}_G = \{(x, g \cdot x) : x \in X, g \in G\}.$$

The norm induces a metric on each \mathcal{R}_G -equivalence class via

$$(2.1) \quad D(x, y) = \inf_{u \in G} \{\|u\| : ux = y\} \text{ for } (x, y) \in \mathcal{R}_G.$$

Properties of the metric are straightforward except, possibly, for the implication $D(x, y) = 0 \implies x = y$. To justify the latter, let $u_n \in G$, $n \in \mathbb{N}$, be a sequence such that $u_n \rightarrow e$ and $u_n x = y$. Elements $u_n^{-1}u_0$, $n \in \mathbb{N}$, belong to the stabilizer of x . By Miller's theorem [Mil77], stabilizers of all points are closed, whence $u_0 = \lim_n u_n^{-1}u_0$ fixes x . Thus $u_0 x = x$, and $x = y$ as claimed.

A. Carderi and the first named author introduced in [CLM16] orbit full groups of Borel measure-preserving Polish group actions on standard probability spaces, which we will simply call full groups. Given such an action $G \curvearrowright X$, they define the **full group of the action** $[G \curvearrowright X]$ to consist of those measure-preserving transformations $T \in \text{Aut}(X, \mu)$ that preserve the equivalence classes of \mathcal{R}_G :

$$[G \curvearrowright X] = \{T \in \text{Aut}(X, \mu) : \forall x \in X (x, T(x)) \in \mathcal{R}_G\}.$$

They showed that full groups are Polish with respect to the natural topology of convergence in measure.

Suppose that the acting group G is furthermore endowed with a compatible norm, which therefore induces a metric D on the equivalence classes of \mathcal{R}_G . We define a subgroup of $[G \curvearrowright X]$ that consists of those automorphisms T for which

the map $x \mapsto D(x, Tx)$ is integrable. Such a subgroup, we argue in this section, also carries a natural Polish topology.

DEFINITION 2.5. Let $G \curvearrowright X$ be a Borel measure-preserving action of a Polish normed group $(G, \|\cdot\|)$ on a standard probability space X ; let $D : \mathcal{R}_G \rightarrow \mathbb{R}^{\geq 0}$ be the associated metric on the orbits of the action. The L^1 norm of an automorphism $T \in [G \curvearrowright X]$ is denoted by $\|T\|_1$ and is defined by the integral $\|T\|_1 = \int_X D(x, Tx) d\mu(x)$. In general, many elements of the full group will have an infinite norm, and the L^1 **full group** of the action consists of the automorphisms for which the norm is finite: $[G \curvearrowright X]_1 = \{T \in [G \curvearrowright X] : \|T\|_1 < \infty\}$.

Elements of $[G \curvearrowright X]_1$ form a group under the composition, as can readily be verified using the triangle inequality for D and the fact that transformations are measure-preserving. Likewise, it is straightforward to check that $\|\cdot\|$ is indeed a norm on $[G \curvearrowright X]_1$. Our goal is to prove that the topology of the norm $\|\cdot\|_1$ on $[G \curvearrowright X]_1$ is a Polish topology. Mimicking the approach taken in [CLM16], we provide a different definition of the L^1 full group, where Polishness of the topology will be readily obtainable, and then argue that the two constructions are isometrically isomorphic.

REMARK 2.6. The notion of L^1 full groups, discussed here, encompasses full groups from [CLM16], since the latter corresponds to the case when G is equipped with a compatible *bounded* norm.

We recall some basic facts from [CLM16]. $L^0(X, G)$ denotes the space of measurable functions $f : X \rightarrow G$; this space is Polish with respect to the topology of convergence in measure. One can endow the X with a Polish topology such that the evaluation map $\Phi : L^0(X, G) \rightarrow L^0(X, X)$, given by $\Phi(f)(x) = f(x) \cdot x$, becomes continuous.

REMARK 2.7. In [CLM16], the possibility of making Φ continuous is obtained by appealing to the remarkable but difficult result of H. Becker and A. S. Kechris, which states that every Borel G -action has a continuous model [BK96, Thm. 5.2.1]. Let us point out that one can also derive this from the easier fact that every Borel G -action can be Borel embedded into a continuous G -action on a Polish compact space (see, for instance, [BK96, Thm. 2.6.6]), as we can endow the latter with the push-forward measure and work with it instead.

Let the set $\text{PF} \subseteq L^0(X, G)$ be the preimage of $\text{Aut}(X, \mu)$ under Φ :

$$\text{PF} = \{f \in L^0(X, G) : \Phi(f) \in \text{Aut}(X, \mu)\}.$$

Since $\text{Aut}(X, \mu)$ is a G_δ subset of $L^0(X, X)$ (see [CLM16, Prop. 2.9] and the remark after it), PF is G_δ in $L^0(X, G)$, hence Polish in the induced topology. The group operations can be pulled from $\text{Aut}(X, \mu)$ onto PF (cf. [CLM16, p. 91]) as follows: for $f, g \in \text{PF}$ and $x \in X$ define the multiplication via $(f * g)(x) = f(\Phi(g)(x))g(x)$ and the inverse¹ by $\text{inv}(f)(x) = f(\Phi(f)^{-1}(x))^{-1}$. These operations turn PF into a Polish group and $\Phi : \text{PF} \rightarrow \text{Aut}(X, \mu)$ into a continuous homomorphism.

The space $L^1(X, G)$ admits a natural inclusion $\iota : L^1(X, G) \hookrightarrow L^0(X, G)$, which is continuous, as can be seen by noting that the equivalent metric $d'_G = \min\{1, d_G\}$

¹The symbol f^{-1} has already been used in the definition of the pointwise inverse on all of $L^1(X, G)$. We introduce a different operation here, hence the slightly unusual choice of the symbol to denote the inverse operation.

on G generates the convergence in measure topology on $L^0(X, G)$ (see [CLM16, Prop. 2.7]), and $\tilde{d}_G(f, g) \geq \tilde{d}'_G(f, g)$ for all $f, g \in L^1(X, G)$. Set $\text{PF}^1 = \iota^{-1}(\text{PF})$, which we endow with the topology induced from $L^1(X, G)$. Since $L^1(X, G)$ is a subset of $L^0(X, G)$, we may omit the inclusion map ι when convenient.

PROPOSITION 2.8. *PF^1 is a Polish group with the multiplication $(f, g) \mapsto (f * g)$ and the inverse $f \mapsto \text{inv}(f)$. The function $f \mapsto \|f\|_1^{L^1(X, G)}$ is a compatible group norm on PF^1 and $\Phi \circ \iota \upharpoonright_{\text{PF}^1}: \text{PF}^1 \rightarrow \text{Aut}(X, \mu)$ is a continuous homomorphism.*

PROOF. First of all, we need to show that these operations are well-defined in the sense that functions $f * g$ and $\text{inv}(f)$ belong to $L^1(X, G)$ whenever so do their arguments. To this end observe that for $f, g \in \text{PF}^1$

$$\begin{aligned} \|f * g\|_1^{L^1(X, G)} &= \int_X \|f(\Phi(g)(x))g(x)\| \, d\mu(x) \\ &\leq \int_X \|f(\Phi(g)(x))\| \, d\mu(x) + \int_X \|g(x)\| \, d\mu(x). \end{aligned}$$

Now note that since $\Phi(g)$ is measure-preserving, we have

$$\int_X \|f(\Phi(g)(x))\| \, d\mu(x) = \int_X \|f(x)\| \, d\mu(x),$$

and therefore

$$\|f * g\|_1^{L^1(X, G)} \leq \int_X \|f(x)\| \, d\mu(x) + \int_X \|g(x)\| \, d\mu(x) = \|f\|_1^{L^1(X, G)} + \|g\|_1^{L^1(X, G)}.$$

In particular, $f * g \in L^1(X, G)$, and thus PF^1 is closed under the multiplication. Similarly, $\Phi(f) \in \text{Aut}(X, \mu)$ implies

$$\begin{aligned} \|\text{inv}(f)\|_1^{L^1(X, G)} &= \int_X \|f(\Phi(f)^{-1}(x))^{-1}\| \, d\mu(x) \\ &= \int_X \|f(x)^{-1}\| \, d\mu(x) = \|f\|_1^{L^1(X, G)}. \end{aligned}$$

Thus PF^1 is also closed under taking inverses. Since these operations define a group structure on PF , it follows that PF^1 is an (abstract) subgroup of PF . Note that we have also established that $\|\cdot\|_1^{L^1(X, G)}$ is a group norm on PF^1 . The multiplication and the operation of taking the inverse are continuous in the topology of $L^1(X, G)$, which is a consequence of the continuity of $\Phi \circ \iota$ coupled with Propositions 2.3 and 2.4. Since PF^1 is a G_δ subset of $L^1(X, G)$, we conclude that it is a Polish group in the topology induced by the norm $\|\cdot\|_1^{L^1(X, G)}$. \square

Let $K \trianglelefteq \text{PF}^1$ denote the kernel of $\Phi \circ \iota \upharpoonright_{\text{PF}^1}$, and let $\|\cdot\|_1^{\text{PF}^1/K}$ denote the quotient norm induced by $\|\cdot\|_1^{L^1(X, G)}$ (see Proposition A.3 regarding the properties of the quotient norm). The factor group $(\text{PF}^1/K, \|\cdot\|_1^{\text{PF}^1/K})$ is evidently a Polish normed group, and it turns out to be isometrically isomorphic to the L^1 full group introduced in Definition 2.5 as we will now see. Let $\tilde{\Phi}: \text{PF}^1/K \rightarrow \text{Aut}(X, \mu)$ denote the homomorphism induced by $\Phi \circ \iota \upharpoonright_{\text{PF}^1}$ onto the factor group.

PROPOSITION 2.9. *The homomorphism $\tilde{\Phi}: \text{PF}^1/K \rightarrow \text{Aut}(X, \mu)$ establishes an isometric isomorphism between $(\text{PF}^1/K, \|\cdot\|_1^{\text{PF}^1/K})$ and $([G \curvearrowright X]_1, \|\cdot\|_1)$.*

PROOF. We begin by showing that $\|gK\|_1^{\text{PF}^1/K} = \|\tilde{\Phi}(gK)\|_1$ holds for any $gK \in \text{PF}^1/K$. By the definition of the quotient norm,

$$\|gK\|_1^{\text{PF}^1/K} = \inf_{k \in K} \int_X \|g(x)k(x)\| d\mu(x).$$

For any fixed $k \in K$, we have $g(x)k(x) \cdot x = g(x) \cdot x$, and therefore

$$D(x, g(x) \cdot x) \leq \|g(x)k(x)\| \quad \text{for almost every } x \in X.$$

This readily implies the inequality $\|\tilde{\Phi}(gK)\|_1 \leq \|gK\|_1^{\text{PF}^1/K}$. For the other direction, let $\epsilon > 0$ and consider the set

$$\{(x, u) \in X \times G : g(x) \cdot x = u \cdot x \text{ and } \|u\| \leq D(x, g(x) \cdot x) + \epsilon\}.$$

Using Jankov-von Neumann uniformization theorem, one may pick a measurable map $g_0 : X \rightarrow G$ that satisfies $g_0(x) \cdot x = g(x) \cdot x$ and $\|g_0(x)\| \leq D(x, g(x) \cdot x) + \epsilon$ for almost all $x \in X$. Since $x \mapsto g(x)^{-1}g_0(x) \in K$, we have

$$\begin{aligned} \|\tilde{\Phi}(gK)\|_1 &= \int_X D(x, g(x) \cdot x) d\mu(x) \\ &\geq \int_X \|g(x)g(x)^{-1}g_0(x)\| d\mu(x) - \epsilon \\ &\geq \|gK\|_1^{\text{PF}^1/K} - \epsilon. \end{aligned}$$

As ϵ is an arbitrary positive real, we conclude that $\|gK\|_1^{\text{PF}^1/K} = \|\tilde{\Phi}(gK)\|_1$.

It remains to check that $\tilde{\Phi}$ is surjective. For an automorphism $T \in [G \curvearrowright X]_1$, consider the set

$$\{(x, u) \in X \times G : Tx = u \cdot x \text{ and } \|u\| \leq D(x, Tx) + 1\}.$$

Applying the Jankov-von Neumann uniformization theorem once again we get a map $g \in L^0(X, G)$ such that $\tilde{\Phi}(g) = T$ and $\|g(x)\| \leq D(x, Tx) + 1$. The latter inequality together with the assumption that $T \in [G \curvearrowright X]_1$ easily imply that $g \in L^1(X, G)$ and thus $gK \in \text{PF}^1/K$ is the preimage of T under $\tilde{\Phi}$. \square

Results discussed thus far can be summarized as follows.

THEOREM 2.10. *Let $G \curvearrowright X$ be a Borel measure-preserving action of a Polish normed group $(G, \|\cdot\|)$ on a standard probability space. The L^1 full group $[G \curvearrowright X]_1$ is a Polish normed group relative to the norm $\|T\|_1 = \int_X D(x, Tx) d\mu(x)$.*

REMARK 2.11. When the acting group is finitely generated and equipped with the word length metric with respect to the finite generating set, it can be shown that the left-invariant metric induced by the norm on the L^1 full group is complete (see [LM18, Prop. 3.4 and 3.5] and the remark thereafter for a more general statement). Nevertheless, generally L^1 full groups do not admit compatible complete left-invariant metrics, i.e., they are not necessarily CLI groups. For instance, if $G = \mathbb{R}$ is acting by rotation on the circle, the L^1 full group of the action is all of $\text{Aut}(\mathbb{S}^1, \lambda)$, which is not CLI.

Let us point out a possibility to generalize our framework. Given a standard probability space (X, μ) , consider an extended Borel metric D on X , i.e., a Borel metric that is allowed to take the value $+\infty$ (Eq. (2.1) provides such an example). Note that the relation $D(x, y) < +\infty$ is an equivalence relation. One can now define

the L^1 full group of D in complete analogy with Definition 2.5 as the group of all $T \in \text{Aut}(X, \mu)$ whose norm $\|T\|_D = \int_X D(x, T(x)) d\mu(x)$ is finite.

QUESTION 2.12. *Suppose that D restricts to a complete separable metric on each equivalence class $\{y \in X : D(x, y) < +\infty\}$, $x \in X$. Is the L^1 full group of D Polish in the topology of the norm $\|\cdot\|_D$?*

2.3. L^1 full groups and quasi-metric structures

When viewed as a normed group, the L^1 full group $[G \curvearrowright X]_1$ depends on the choice of a compatible norm on G . The topological structure on $[G \curvearrowright X]_1$, however, depends only on the quasi-metric structure of the acting group. Recall that two norms $\|\cdot\|$ and $\|\cdot\|'$ on a Polish group G are **quasi-isometric** if there exists a constant $C > 0$ such that for all $g \in G$,

$$\frac{1}{C}\|g\| - C \leq \|g\|' \leq C\|g\| + C.$$

LEMMA 2.13. *Let $\|\cdot\|$ and $\|\cdot\|'$ be two quasi-isometric compatible norms on a Polish group G , and let $G \curvearrowright (X, \mu)$ be a Borel measure-preserving action on a standard probability space. The L^1 full groups associated with the two norms are equal as topological groups.*

PROOF. The quasi-isometry condition implies that a function $f : X \rightarrow G$ satisfies $\int_X \|f(x)\| d\mu(x) < +\infty$ if and only if $\int_X \|f(x)\|' d\mu(x) < +\infty$. In particular, the L^1 full groups associated with these norms are equal as abstract groups.

Both topologies make the inclusion of $[G \curvearrowright X]_1$ into $\text{Aut}(X, \mu)$ continuous by Proposition 2.8, and, in particular, the inclusion map is Borel. Since injective images of Borel sets by Borel maps are Borel (see, for example, [Kec95, Thm. 15.1]), it follows that both topologies induce the same Borel structure on $[G \curvearrowright X]_1$, which also coincides with the one induced by the weak topology on $\text{Aut}(X, \mu)$. A standard automatic continuity result (originally due to S. Banach [Ban32, Thm. 4 p. 23]) then yields equality of the two topologies (see also the second paragraph following [BK96, Lem. 1.2.6]). \square

When a Polish group G admits a canonical choice of the quasi-metric structure, L^1 full groups $[G \curvearrowright X]_1$ are unambiguously defined as topological groups without the need to choose any particular norm on G . This is the case for *boundedly generated* Polish groups—the class of groups identified and studied by C. Rosendal in his treatise [Ros22]. Appendix A.2 provides a succinct review of the concept of maximal norms on boundedly generated Polish groups.

An example of this situation is given by $G = \mathbb{R}$, where the usual Euclidean norm is maximal in the sense of Definition A.5.

REMARK 2.14. We will see in the last chapter that the natural L^1 norm on the L^1 full groups of \mathbb{R} -actions is *maximal* so that it defines a quasi-metric structure which is canonically associated with the topological group structure.

2.4. Embedding L^1 isometrically in L^1 full groups

We now show a general result on the geometry of L^1 full groups endowed with the L^1 norm $\|\cdot\|_1$, which says that they are quite big.

Given a σ -finite measured space $(X, \mathcal{B}, \lambda)$, denote by $\text{MAlg}_f(X, \lambda)$ the space of all finite measure subsets $B \in \mathcal{B}$ identified up to measure zero and endowed with the metric $d_\lambda(B_1, B_2) = \lambda(B_1 \triangle B_2)$.

PROPOSITION 2.15. *Let $(G, \|\cdot\|)$ be a Polish normed group acting by measure-preserving transformations on a standard probability space (X, μ) . If*

$$[G \curvearrowright X]_1 \neq [G \curvearrowright X],$$

then the metric space $(\text{MAlg}_f(\mathbb{R}, \lambda), d_\lambda)$ embeds isometrically into the L^1 full group of $G \curvearrowright X$ endowed with its L^1 metric, and hence so does $L^1(X, \mu, \mathbb{R})$.

PROOF. Since $[G \curvearrowright X]$ is a full group, any of its elements can be written as a product of three involutions belonging to $[G \curvearrowright X]$ by [Ryz85]. By assumption, $[G \curvearrowright X]_1 \neq [G \curvearrowright X]$ so there must be an involution $U \in [G \curvearrowright X]$ which does not belong to $[G \curvearrowright X]_1$. Denote by \mathcal{B}_U the σ -algebra on $\text{supp } U$ consisting of U -invariant sets, endowed with the measure given by $\lambda_U(A) = \|U_A\|_1$. Since $\text{supp } U = \bigcup_n \{x \in \text{supp } U : D(x, U(x)) \leq n\}$, the measure λ_U is σ -finite. Also, λ_U is non-atomic, because so is μ , and infinite, because $U \notin [G \curvearrowright X]_1$. There is only one σ -finite standard atomless infinite measured space up to isomorphism (namely $(\mathbb{R}, \mathcal{B}(\mathbb{R}), \lambda)$) so we conclude that $(\text{MAlg}_f(\text{supp } U, \lambda_U), d_{\lambda_U})$ is isometric to $(\text{MAlg}_f(\mathbb{R}, \lambda), d_\lambda)$. Composing this isometry with $A \mapsto U_A$, we get the desired isometric embedding $(\text{MAlg}_f(\mathbb{R}, \lambda), d_\lambda) \rightarrow [G \curvearrowright X]_1$.

Finally, we observe that $L^1(X, \mu, \mathbb{R})$ can be embedded into $\text{MAlg}_f(X \times \mathbb{R}, \mu \otimes \lambda)$ by taking a function f to its epigraph, namely the set of all $(x, y) \in X \times \mathbb{R}$ such that $f(x) \leq y \leq 0$ or $0 \leq y \leq f(x)$. Since there is again only one infinite σ -finite standard atomless measured space and $(X \times \mathbb{R}, \mu \otimes \lambda)$ is such a space, we get an isometric embedding $L^1(X, \mu, \mathbb{R}) \rightarrow \text{MAlg}_f(\mathbb{R}, \lambda)$ as wanted. \square

REMARK 2.16. Full groups of actions of Polish groups are always coarsely bounded. In fact, they are coarsely bounded even as discrete groups², which is a result due to M. Droste, W. C. Holland and G. Ulbrich [DHU08] (see also [Mil04, Section I.8] for a more general statement which encompasses the non-ergodic case). In particular, the above result is actually a sharp dichotomy: every L^1 full group of a Polish normed group action is either coarsely bounded, or it contains an isometric copy of $L^1(X, \mu, \mathbb{R})$.

REMARK 2.17. Since \mathbb{R}^n endowed with the ℓ^1 norm embeds isometrically into $L^1(X, \mu, \mathbb{R})$, Proposition 2.15 significantly improves [LM21, Prop. 6.9].

2.5. Stability under the first return map

Some of the basic properties of L^1 full groups are discussed—in the wider generality of induction friendly finitely full groups—in Chapter 3. The often-used fundamental fact is the closure of L^1 full groups under taking the induced maps, which is a generalization of [LM18, Prop. 3.6]. We formulate this in Proposition 2.18.

Let $T \in \text{Aut}(X, \mu)$ be a measure-preserving transformation. Recall that for a measurable subset $A \subseteq X$, the **induced map** T_A is supported on A and is defined to be $T^n(x)$ for $x \in A$ where $n \geq 1$ is the smallest integer such that $T^n(x) \in A$. By the Poincaré recurrence theorem, such a map yields a well-defined measure-preserving transformation.

²Being coarsely bounded as a discrete group is also called the Bergman property.

PROPOSITION 2.18. *Let $G \curvearrowright X$ be a Borel measure-preserving action of a Polish normed group $(G, \|\cdot\|)$. For any element $T \in [G \curvearrowright X]_1$ and any measurable set $A \subseteq X$, the induced transformation T_A belongs to $[G \curvearrowright X]_1$ and moreover $\|T_A\|_1 \leq \|T\|_1$.*

PROOF. For $n \geq 1$, let A_n be the set of elements of A whose return time is equal to n ; note that $X = \bigsqcup_{n \geq 1} \bigsqcup_{i=0}^{n-1} T^i(A_n)$. Let as before $D : \mathcal{R}_G \rightarrow \mathbb{R}^{\geq 0}$ be the metric induced by the group norm $\|\cdot\|$ on the orbits of the action. To estimate the value of $\|T_A\|_1$, observe that

$$\begin{aligned} \|T_A\|_1 &= \int_X D(x, T_A x) d\mu(x) = \sum_{n=1}^{\infty} \int_{A_n} D(x, T_A x) d\mu(x) \\ &= \sum_{n=1}^{\infty} \int_{A_n} D(x, T^n x) d\mu(x). \end{aligned}$$

Using the triangle inequality, we get

$$\begin{aligned} \|T_A\|_1 &\leq \sum_{n=1}^{\infty} \sum_{i=0}^{n-1} \int_{A_n} D(T^i x, T^{i+1} x) d\mu(x) \\ &= \sum_{n=1}^{\infty} \sum_{i=0}^{n-1} \int_{T^i(A_n)} D(x, T x) d(\mu \circ T^{-i})(x) \\ \therefore T \text{ preserves } \mu &= \sum_{n=1}^{\infty} \sum_{i=0}^{n-1} \int_{T^i(A_n)} D(x, T x) d\mu(x) = \int_X D(x, T x) d\mu(x) = \|T\|_1. \end{aligned}$$

Thus $T_A \in [G \curvearrowright X]_1$ and $\|T_A\|_1 \leq \|T\|_1$ as claimed. \square

CHAPTER 3

Polish finitely full groups

The main object of our investigation in this work are L^1 full groups of Borel measure-preserving actions of Polish normed groups. Some results, however, are valid in the more general context of what we call Polish finitely full groups. It encompasses L^1 full groups and allows us to put some of the proofs on topological simplicity and on maximal norms from [LM18, LM21] in a unified and broadened context.

Starting with a Polish finitely full group as defined in Section 3.1, we construct in Section 3.2 a natural closed subgroup of the latter which we call the symmetric subgroup, analogous to V. Nekrashevych's symmetric and alternating topological full groups [Nek19]. We show that this closed subgroup coincides with the closure of the derived group under a mild hypothesis, satisfied by L^1 full groups, which we call induction friendliness. Section 3.3 is devoted to the study of closed normal subgroups of the symmetric subgroup: we show that they correspond to invariant sets, a fact which easily yields topological simplicity when the ambient Polish finitely full group is ergodic. Finally, in Section 3.4 we provide a condition normed induction friendly Polish finitely full groups which guarantees maximality on the symmetric subgroup in the sense of C. Rosendal (a brief reminder of the relevant notions is given in Appendix A.2).

3.1. Polish full and finitely full groups

H. Dye defined a subgroup $\mathbb{G} \leq \text{Aut}(X, \mu)$ as being **full** when it is stable under the cutting and pasting of its elements along a *countable partition*: given any partition $(A_n)_n$ of X and any sequence $(g_n)_n$ such that the family $(g_n(A_n))_n$ also partitions X , the element $T \in \text{Aut}(X, \mu)$ obtained as the reunion over $n \in \mathbb{N}$ of the restrictions $g_n \upharpoonright_{A_n}$ belongs to \mathbb{G} . In particular, the group $\text{Aut}(X, \mu)$ itself is full.

Given any $\mathbb{G} \leq \text{Aut}(X, \mu)$, the group obtained by cutting and pasting elements of \mathbb{G} along countable partitions is the smallest full subgroup containing \mathbb{G} . We denote it by $[\mathbb{G}]$ and call it the **full group generated** by \mathbb{G} .

Recall that the uniform topology on $\text{Aut}(X, \mu)$ is the topology induced by the uniform metric d_u defined by

$$d_u(T_1, T_2) = \mu(\{x \in X : T_1x \neq T_2x\}).$$

The following can essentially be traced back to H. Dye [Dye59, Lem. 5.4].

PROPOSITION 3.1. *The metric d_u is complete on any full group \mathbb{G} , and it is separable if and only if the full group is generated by a countable group.*

PROOF. Suppose that $(T_n)_n$ is a Cauchy sequence in the full group \mathbb{G} . Taking a subsequence, we may assume that $d_u(T_n, T_{n+1}) < 2^{-n}$ for all n . By the Borel-Cantelli lemma, for almost every $x \in X$ there is some $N \in \mathbb{N}$ such that $T_nx = T_Nx$

for all $n \geq N$. Let $Tx = T_Nx$ for such $N = N(x)$, and note that T is a measure-preserving bijection¹ and $d_u(T_n, T) \leq 2^{-n+1}$. By construction, T is obtained by cutting and pasting the elements T_n of \mathbb{G} along a countable partition so $T \in \mathbb{G}$, since \mathbb{G} is full.

Suppose \mathbb{G} is separable and let Γ be a countable dense subgroup. The group $[\Gamma]$ is a countably generated full group which is dense in \mathbb{G} , so $\mathbb{G} = [\Gamma]$ by completeness. The converse is obtained by noting that if Γ generates \mathbb{G} , then one can view \mathbb{G} as the full group of the equivalence relation generated by a realization of the action of Γ on (X, μ) , which is d_u -separable by [Kec10, Prop. 3.2]. \square

The L^1 full groups that we are considering are not full in the sense of H. Dye unless the norm on the acting Polish group is bounded, a case which was considered earlier in [CLM16]. They nevertheless satisfy the following weaker property.

DEFINITION 3.2. A group $\mathbb{G} \leq \text{Aut}(X, \mu)$ of measure-preserving transformations is **finitely full** if for any partition $X = A_1 \sqcup \dots \sqcup A_n$ and $g_1, \dots, g_n \in \mathbb{G}$ such that the sets g_1A_1, \dots, g_nA_n also partition X , the element $T \in \text{Aut}(X, \mu)$ obtained as the reunion over $i \in \{1, \dots, n\}$ of the restrictions $g_i \upharpoonright_{A_i}$ belongs to \mathbb{G} .

We have the following useful relationship between fullness and finite fullness.

PROPOSITION 3.3. *The d_u -closure of any finitely full group \mathbb{G} is equal to the full group $[\mathbb{G}]$ generated by \mathbb{G} . Moreover, every element $T \in [\mathbb{G}]$ is a limit of elements of \mathbb{G} whose support is contained in the support of T .*

PROOF. Since full groups are d_u -closed and using the definition of fullness, it suffices to show that every element $T \in [\mathbb{G}]$ is a limit of elements of \mathbb{G} that belong to the full group generated by T .

Since every $T \in [\mathbb{G}]$ is a product of three involutions in $[T]^2$ [Ryz85], it suffices to show that every involution in $[\mathbb{G}]$ is a limit of elements of \mathbb{G} whose support is contained in the support of that involution. Let U be such an involution, let $(A_n)_n$ be a partition of X , and let $(g_n)_n$ in \mathbb{G} be such that $Ux = g_nx$ for all $x \in A_n$. Pick a fundamental domain B for U , i.e., $B \cap U(B) = \emptyset$ and $\text{supp } U = B \cup U(B)$. If $B_n = A_n \cap B$, then $Ux = g_nx$ for all $x \in B_n$, and, since U is an involution, $Ux = g_n^{-1}x$ for all $x \in U(B_n)$. Let

$$U_nx = \begin{cases} Ux & \text{if } x \in \bigcup_{m \leq n} (B_m \cup U(B_m)), \\ x & \text{otherwise.} \end{cases}$$

Clearly $U_n \in \mathbb{G}$, since \mathbb{G} is finitely full. Furthermore, $U_n \rightarrow U$ uniformly and $\text{supp } U_n \subseteq \text{supp } U$ by construction, which finishes the proof. \square

Consider a finitely full group \mathbb{G} which is a Borel subset of $\text{Aut}(X, \mu)$ and therefore inherits the structure of a standard Borel space. If \mathbb{G} is Polishable, i.e., if it admits a Polish group topology compatible with the Borel structure, then such topology is necessarily unique and must refine the weak topology inherited from $\text{Aut}(X, \mu)$ (standard automatic continuity results can be found, for instance, in [BK96, Sec. 1.6]). We refer to such Polishable groups \mathbb{G} endowed with their unique Polish group topology refining the weak topology as **Polish finitely full**

¹This also follows from the fact due to P. Halmos [Hal17] that $\text{Aut}(X, \mu)$ is d_u -complete.

²In fact, we only need the much easier fact that every element is a limit of products of two involutions from its full group, which follows by combining Theorem 3.3 and Sublemma 4.3 from [Kec10].

groups. In this monograph, our motivating example for introducing this class is of course L^1 full groups.

For any subgroup $G \leq \text{Aut}(X, \mu)$, there is the smallest finitely full group containing G . Note that if $H \leq \text{Aut}(X, \mu)$ is a finite group, then the finitely full group it generates coincides with the full group it generates. This, in particular, applies to the group generated by a periodic transformation with bounded periods.

PROPOSITION 3.4. *Suppose \mathbb{G} is a Polish finitely full group, and $U \in \mathbb{G}$ is a periodic transformation with bounded periods. The topology induced by \mathbb{G} on the full group of U is equal to the uniform topology.*

PROOF. The weak and the uniform topologies on $[U]$ coincide since U is periodic. We already mentioned that the topology of \mathbb{G} refines the weak topology. Since $[U]$ is Polish in the uniform topology, by the automatic continuity [BK96, Thm. 1.2.6], the topology induced by \mathbb{G} on the full group of U is refined by the uniform topology. Hence the uniform topology and the topology induced from \mathbb{G} onto $[U]$ must coincide. \square

We conclude this preliminary discussion with a definition of aperiodicity which applies to arbitrary subgroups of $\text{Aut}(X, \mu)$. Such a notion was already worked out by H. Dye [Dye59, Sec. 2] when he introduced type II subgroups. An equivalent version which suffices for our purposes is as follows.

DEFINITION 3.5. A subgroup $G \leq \text{Aut}(X, \mu)$ is **aperiodic** if it admits a countable weakly dense subgroup whose action on (X, μ) has no finite orbits.

It can be checked that for an aperiodic $G \leq \text{Aut}(X, \mu)$, every countable weakly dense subgroup has infinite orbits almost surely. Further discussion of aperiodicity can be found in Appendix D.4.

3.2. Derived subgroup and symmetric subgroup

Our goal in this section is to identify when the closed derived subgroup of a Polish finitely full group is topologically generated by involutions. We start by noting that aperiodic finitely full groups admit many involutions in the sense of [Fre04, p. 384]:

LEMMA 3.6. *Let \mathbb{G} be a finitely full aperiodic group. For every measurable nontrivial $A \subseteq X$, there is a nontrivial involution $g \in \mathbb{G}$ whose support is contained in A .*

PROOF. By Lemma D.13, there is an involution $T \in [\mathbb{G}]$ whose support is equal to A . By the moreover part of Proposition 3.3, T is the d_u -limit of $g_n \in \mathbb{G}$ supported in A . In particular, one of the g_n 's is nontrivial and $g = g_n$ satisfies the statement of the lemma. \square

The first and the second items of the following definition constitute analogues of V. Nekrashevych's symmetric and alternating topological full groups [Nek19], respectively. In the setup of L^1 full groups, however, these notions coincide, as we will see shortly.

DEFINITION 3.7. Given a Polish finitely full group \mathbb{G} , we let

- $\mathfrak{S}(\mathbb{G})$ be the closed subgroup of \mathbb{G} generated by involutions, which we call the **symmetric subgroup of \mathbb{G}** .

- $\mathfrak{A}(\mathbb{G})$ be the closed subgroup of \mathbb{G} generated by 3-cycles, i.e., generated by periodic transformations whose non-trivial orbits have size 3.
- $D(\mathbb{G})$ be the closed subgroup generated by commutators (also known as the **topological derived subgroup**).

All these groups are closed normal subgroups of \mathbb{G} , and $\mathfrak{A}(\mathbb{G}) \leq \mathfrak{S}(\mathbb{G}) \cap D(\mathbb{G})$ because every 3-cycle is a commutator of two involutions from its full group.

PROPOSITION 3.8. $\mathfrak{A}(\mathbb{G}) = \mathfrak{S}(\mathbb{G})$ for any aperiodic finitely full group \mathbb{G} .

PROOF. We need to show that every involution is a limit of products of 3-cycles. Let $U \in \mathbb{G}$ be an involution, and let D denote its fundamental domain; thus $\text{supp } U = D \sqcup U(D)$. By Lemma D.13, one can find an involution $V \in [\mathbb{G}]$ whose support is equal to D . Since \mathbb{G} is finitely full, we may write D as an increasing union $D = \bigcup_n D_n$, $D_n \subseteq D_{n+1}$, where each D_n is V -invariant, and for every $n \in \mathbb{N}$ the transformation V_n induced by V on D_n belongs to the group \mathbb{G} itself. Let U_n denote the restriction of U onto $D_n \sqcup U(D_n)$ and note that $U_n \rightarrow U$ in the uniform topology, and hence also in the topology of \mathbb{G} by Proposition 3.4. Our plan is to use the following permutation identity

$$(3.1) \quad (12)(34) = (12)(23)(24)(23) = (123)(423),$$

where U_n corresponds to $(12)(34)$, V_n to (13) , and $U_n V_n U_n$ corresponds to (24) . To this end, let C_n be a fundamental domain for V_n , put $W_n = U \upharpoonright_{C_n \sqcup U(C_n)}$ (which corresponds to the involution (12)), and, at last, set $S_n = W_n V_n W_n$ (corresponding to $(23) = (12)(13)(12)$). Figure 3.1 illustrates the relations between these sets and transformations.

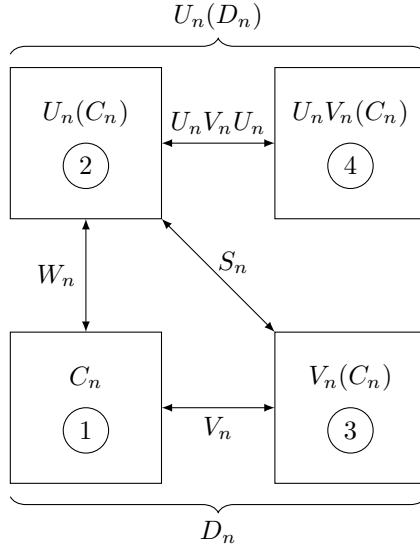

FIGURE 3.1. Involution U_n is a products of 3-cycles via $(12)(34) = (123)(234)$.

Equation (3.1) translates into $U_n = (W_n S_n)((U_n V_n U_n) S_n)$, so U_n is a product of two 3-cycles, hence it belongs to $\mathfrak{A}(\mathbb{G})$. Since by construction $U_n \rightarrow U$, we conclude that $U \in \mathfrak{A}(\mathbb{G})$. \square

We do not know whether $\mathfrak{A}(\mathbb{G}) = D(\mathbb{G})$ holds for all finitely full groups, but here is a convenient sufficient condition.

DEFINITION 3.9. A Polish finitely full group \mathbb{G} is called **induction friendly** if it is stable under taking induced transformations and, furthermore, whenever $T \in \mathbb{G}$ and $(A_n)_n$ is an increasing sequence of T -invariant sets such that $\bigcup_n A_n = A$, then $T_{A_n} \rightarrow T_A$.

In the above definition, we require stability under taking the induced transformations and so T_{A_n} always belongs to \mathbb{G} . However, for T -invariant A_n , $T_{A_n} \in \mathbb{G}$ is already a consequence of \mathbb{G} being finitely full.

Observe that L^1 full groups of measure-preserving actions of Polish normed groups are finitely full and also induction friendly. Indeed, finite fullness follows from a straightforward computation, while induction friendliness is a direct consequence of Proposition 2.18 and Lebesgue dominated convergence theorem.

LEMMA 3.10. *In an induction friendly Polish finitely full group \mathbb{G} , every periodic element belongs to $\mathfrak{S}(\mathbb{G})$.*

PROOF. Suppose T is periodic. For $n \in \mathbb{N}$, let A_n be the set of $x \in X$ whose T -orbit has cardinality at most n . Each A_n is T -invariant and $\bigcup_n A_n = X$. Moreover, T_{A_n} is periodic, so it can be written as a product of two involutions from its full group, and since \mathbb{G} is finitely full and the periods of T_{A_n} are bounded, these two involutions belong to \mathbb{G} . The conclusion follows from induction friendliness and convergence $T_{A_n} \rightarrow T$. \square

LEMMA 3.11. *Let \mathbb{G} be an induction friendly Polish finitely full group, $T \in \mathbb{G}$ and $F \subseteq X$ be the aperiodic part of T , i.e.,*

$$F = \{x \in X : T^k x \neq x \text{ for all } k \neq 0\}.$$

For any $A \subseteq X$ such that $F \subseteq \bigcup_{k \in \mathbb{Z}} T^k(A)$ one has $T_A \mathfrak{S}(\mathbb{G}) = T \mathfrak{S}(\mathbb{G})$.

PROOF. Since $F \subseteq \bigcup_{k \in \mathbb{Z}} T^k(A)$, the transformation $T^{-1}T_A$ is periodic and therefore belongs to $\mathfrak{S}(\mathbb{G})$ by Lemma 3.10. Hence

$$T \mathfrak{S}(\mathbb{G}) = TT^{-1}T_A \mathfrak{S}(\mathbb{G}) = T_A \mathfrak{S}(\mathbb{G}). \quad \square$$

REMARK 3.12. Usefulness of the above lemma stems from the following simple observation. If T, T', U, U' satisfy $T \mathfrak{S}(\mathbb{G}) = T' \mathfrak{S}(\mathbb{G})$ and $U \mathfrak{S}(\mathbb{G}) = U' \mathfrak{S}(\mathbb{G})$, then $[T, U] \in \mathfrak{S}(\mathbb{G})$ if and only if $[T', U'] \in \mathfrak{S}(\mathbb{G})$. In particular, for A as in Lemma 3.11, $[T, U] \in \mathfrak{S}(\mathbb{G})$ whenever $[T_A, U] \in \mathfrak{S}(\mathbb{G})$. This fact is used in the proof of the next lemma.

LEMMA 3.13. *Suppose \mathbb{G} is an induction friendly Polish finitely full group. If $T, U \in \mathbb{G}$ are aperiodic on their supports, then $[T, U] \in \mathfrak{S}(\mathbb{G})$.*

PROOF. Let C be a cross-section for the restriction of \mathcal{R}_T onto $\text{supp } T$. In other words, $C \subseteq X$ is a measurable set satisfying $\bigcup_{i \in \mathbb{Z}} T^i(C) = \text{supp } T$. The induced transformation $U_{X \setminus C}$ commutes with T_C , since their supports are disjoint. We would be done if $\text{supp } U \subseteq \bigcup_{i \in \mathbb{Z}} U^i(X \setminus C)$. Indeed, in this case $T \mathfrak{S}(\mathbb{G}) = T_C \mathfrak{S}(\mathbb{G})$, $U \mathfrak{S}(\mathbb{G}) = U_{X \setminus C} \mathfrak{S}(\mathbb{G})$ by Lemma 3.11 and $[T_C, U_{X \setminus C}]$ is trivial, hence $[T, U] \in \mathfrak{S}(\mathbb{G})$.

Motivated by this observation, we argue as follows. Pick a vanishing nested sequence $(C_n)_{n \in \mathbb{N}}$ of cross-sections for $\mathcal{R}_T \upharpoonright_{\text{supp } T}$, i.e., $C_n \supseteq C_{n+1}$, $\bigcup_{k \in \mathbb{Z}} T^k(C_n) =$

$\text{supp } T$ for all $n \in \mathbb{N}$, and $\bigcap_{n \in \mathbb{N}} C_n = \emptyset$ (see also Lemma D.11). Such a sequence of cross-sections exists since T is assumed to be aperiodic on its support. Define inductively sets B'_n , $n \in \mathbb{N}$, by setting $B'_0 = X \setminus C_0$, and letting B'_n be the part of $X \setminus C_n$ that does not belong to the U -saturation of any B'_k , $k < n$,

$$B'_n = (X \setminus C_n) \setminus \bigcup_{k < n} \bigcup_{i \in \mathbb{Z}} U^i(B'_k).$$

By construction, saturations under U of the sets B'_n are pairwise disjoint, and the saturation of their union is the whole space, $\bigcup_{i \in \mathbb{Z}} U^i(\bigcup_{n \in \mathbb{N}} B'_n) = X$, because sets C_n vanish.

Let $B_n = \bigsqcup_{k < n} B'_k$, $B = \bigsqcup_{k \in \mathbb{N}} B'_k$, and note that $U_{B_n}, U_B \in \mathbb{G}$, and $U_{B_k} \rightarrow U_B$ by the induction friendliness of \mathbb{G} . By construction, transformations T_{C_n} and U_{B_n} have disjoint supports for each n and, therefore, commute. Since all sets C_n are cross-sections for $\mathcal{R}_T \upharpoonright_{\text{supp } T}$, one has $[T, U_{B_n}] \in \mathfrak{S}(\mathbb{G})$ by Lemma 3.11 and Remark 3.12. Taking the limit as $n \rightarrow \infty$, this yields $[T, U_B] \in \mathfrak{S}(\mathbb{G})$. Finally, the U -saturation of B is all of X , we use Lemma 3.11 and Remark 3.12 once again to conclude that $[T, U] \in \mathfrak{S}(\mathbb{G})$, as claimed. \square

PROPOSITION 3.14. *If \mathbb{G} is an aperiodic induction friendly Polish finitely full group, then $\mathfrak{S}(\mathbb{G}) = D(\mathbb{G})$.*

PROOF. Inclusion $\mathfrak{A}(\mathbb{G}) \leq D(\mathbb{G})$ holds for any Polish finitely full group and Proposition 3.8 gives $\mathfrak{S}(\mathbb{G}) \leq D(\mathbb{G})$. We therefore concentrate on proving the reverse inclusion: given $T, U \in \mathbb{G}$, we need to check that $[T, U] \in \mathfrak{S}(\mathbb{G})$. Let F_T and F_U be the aperiodic parts of T and U respectively, so that $T\mathfrak{S}(\mathbb{G}) = T_{F_T}\mathfrak{S}(\mathbb{G})$, $U\mathfrak{S}(\mathbb{G}) = U_{F_U}\mathfrak{S}(\mathbb{G})$ by Lemma 3.11. By construction, T_{F_T} and U_{F_U} are aperiodic on their supports and therefore $[T_{F_T}, U_{F_U}] \in \mathfrak{S}(\mathbb{G})$ by Lemma 3.13. It remains to use Remark 3.12 to conclude that necessarily $[T, U] \in \mathfrak{S}(\mathbb{G})$, as needed. \square

COROLLARY 3.15. *Let G be a Polish normed group, and let $G \curvearrowright X$ be an aperiodic Borel measure-preserving action on a standard probability space (X, μ) . The three subgroups of $[G \curvearrowright X]_1$ introduced in Definition 3.7 coincide:*

$$D([G \curvearrowright X]_1) = \mathfrak{A}([G \curvearrowright X]_1) = \mathfrak{S}([G \curvearrowright X]_1).$$

Moreover, they are all equal to the closure of the group generated by periodic elements of $[G \curvearrowright X]_1$.

PROOF. The equality $D([G \curvearrowright X]_1) = \mathfrak{A}([G \curvearrowright X]_1) = \mathfrak{S}([G \curvearrowright X]_1)$ follows immediately from Propositions 3.8 and 3.14, since $[G \curvearrowright X]_1$ is both finitely full and induction friendly. All these groups are equal to the closure of the group generated by periodic elements of $[G \curvearrowright X]_1$ in view of Lemma 3.10 and the fact that this group obviously contains $\mathfrak{S}([G \curvearrowright X]_1)$. \square

3.3. Topological simplicity of the symmetric group

We now move on to showing that symmetric subgroups of ergodic Polish finitely full groups are always topologically simple. Our argument abstracts from [LM18, Sec. 3.4]. In particular, we rely on conditional measures associated with subgroups of $\text{Aut}(X, \mu)$, whose construction and basic properties are recalled in Appendix D.

LEMMA 3.16. *Let \mathbb{G} be an aperiodic Polish finitely full group, let $U, V \in \mathbb{G}$ be two involutions whose supports are disjoint and have the same \mathbb{G} -conditional*

measure. Then U and V are approximately conjugate in $\mathfrak{S}(\mathbb{G})$, i.e., there are $T_n \in \mathfrak{S}(\mathbb{G})$ such that $T_n U T_n^{-1} \rightarrow V$.

PROOF. Let A (resp. B) be a fundamental domain of the restriction of U (resp. V) to its support. Then $\mu_{\mathbb{G}}(A) = \mu_{\mathbb{G}}(B)$ and there is an involution $T \in [\mathbb{G}]$ such that $T(A) = B$.

Since \mathbb{G} is finitely full, there is an increasing sequence $(A_n)_n$ of subsets of A such that the involutions T'_n induced by T on $A_n \cup U(A_n)$ belong to \mathbb{G} , and $\bigcup_n A_n = A$. Let $B_n = T(A_n) = T'_n(A_n)$ and define involutions $T_n \in \mathbb{G}$ which almost conjugate U to V as follows. For $x \in X$, let

$$T_n x = \begin{cases} Tx & \text{if } x \in A_n \sqcup B_n \\ VTUx & \text{if } x \in U(A_n) \\ UTVx & \text{if } x \in V(B_n) \\ x & \text{otherwise.} \end{cases}$$

For all $n \in \mathbb{N}$ and all $x \in X$, an easy calculation yields that:

- if $x \in (A \cup U(A)) \setminus (A_n \cup U(A_n))$, then $T_n U T_n x = Ux$;
- if $x \in B_n \cup V(B_n)$, then $T_n U T_n x = Vx$;
- and $T_n U T_n x = x$ in all other cases.

In particular, $d_u(T_n U T_n, V) \rightarrow 0$ and Proposition 3.4, applied to the full group of the involution UV (which contains both U and V), guarantees that $T_n U T_n \rightarrow V$. \square

LEMMA 3.17. *Let \mathbb{G} be an aperiodic Polish finitely full group, let $U \in \mathbb{G}$ be an involution, and let A be a U -invariant subset contained in $\text{supp } U$. Suppose that there exists an involution $V \in \mathbb{G}$ such that $V(A)$ is disjoint from $\text{supp } U$. Then for all \mathbb{G} -invariant functions $f \leq 2\mu_{\mathbb{G}}(A)$, there is an involution $W \in \mathbb{G}$ such that $UWUW$ is an involution whose support has \mathbb{G} -conditional measure f .*

PROOF. Let $B \subseteq A$ be a fundamental domain for the restriction of U to A and note that $\mu_{\mathbb{G}}(B) = \mu_{\mathbb{G}}(A)/2$. By Maharam's lemma (Theorem D.12), there is $C \subseteq B$ such that $\mu_{\mathbb{G}}(C) = f/4$. The set $D = C \sqcup U(C)$ is U -invariant and satisfies $\mu_{\mathbb{G}}(D) = f/2$. Consider the involution $W \in \mathbb{G}$ defined by

$$Wx = \begin{cases} Vx & \text{if } x \in D \sqcup V(D) \\ x & \text{otherwise.} \end{cases}$$

A straightforward computation shows that $UWUW$ is an involution which coincides with U on D , with VUV on $V(D)$, and is trivial elsewhere. Hence the support of $UWUW$ is equal to $D \sqcup V(D)$, and has \mathbb{G} -conditional measure f . \square

PROPOSITION 3.18. *Let \mathbb{G} be an aperiodic Polish finitely full group, let $T \in \mathbb{G}$, and let A denote the \mathbb{G} -saturation of $\text{supp } T$. The closed subgroup of \mathbb{G} generated by the $\mathfrak{S}(\mathbb{G})$ -conjugates of T contains $\mathfrak{S}(\mathbb{G})_A$.*

PROOF. Let the closed subgroup of \mathbb{G} generated by the $\mathfrak{S}(\mathbb{G})$ -conjugates of T be denoted by G . We can find $B \subseteq \text{supp } T$ whose T -translates cover $\text{supp } T$ and which satisfies $B \cap T(B) = \emptyset$. Since T -translates of B cover $\text{supp } T$, we conclude that the \mathbb{G} -translates of B cover A , and so $\mu_{\mathbb{G}}(B)(x) > 0$ for all $x \in A$. By Maharam's lemma (Theorem D.12), we can find $C \subseteq B$ whose \mathbb{G} -conditional measure is everywhere less than $1/4$, and is strictly positive on A . Let $D = C \sqcup T(C)$ and take $V \in [\mathbb{G}]$ to be an involution such that $V(C \sqcup T(C))$ is disjoint from $C \sqcup T(C)$.

Let $W \in [\mathbb{G}]$ be an involution such that $\text{supp } W = C$. Using the facts that \mathbb{G} is finitely full, that $T \in \mathbb{G}$ and that $V, W \in [\mathbb{G}]$, one can find an increasing sequence $(C_n)_n$ of W -invariant subsets of C such that $\bigcup_n C_n = C$ and for each $n \in \mathbb{N}$ both $W_{C_n} \in \mathbb{G}$ and $V_{C_n \sqcup T(C_n) \sqcup V(C_n \sqcup T(C_n))} \in \mathbb{G}$. Transformations $W_{C_n} T W_{C_n} T^{-1}$ belong to G , and are, in fact, involutions whose support is equal to $C_n \sqcup T(C_n)$ and has conditional measure at most $2\mu_{\mathbb{G}}(C) \leq 1/2$. Let us define for brevity

$$\tilde{U}_n = W_{C_n} T W_{C_n} T^{-1} \in G \text{ and } \tilde{V}_n = V_{C_n \sqcup T(C_n) \sqcup V(C_n \sqcup T(C_n))} \in \mathbb{G}.$$

For every $n \in \mathbb{N}$, let A_n denote the \mathbb{G} -saturation of C_n . Note that $A = \bigcup_n A_n$ and the union is increasing. Every involution supported on A is thus the uniform limit of the involutions it induces on A_n 's. By Proposition 3.4, it therefore suffices to show that G contains all the involutions which are supported on some A_n .

Let U be an involution U supported on some A_n . Let D be a fundamental domain for the restriction of U to its support. Using Maharam's lemma repeatedly, we can partition D into a countable family $(D_k)_k$ such that

$$(3.2) \quad \mu_{\mathbb{G}}(D_k) \leq \mu_{\mathbb{G}}(\text{supp } \tilde{U}_n)/2 \quad \text{for all } k \in \mathbb{N}.$$

If we let $E_k = D_k \sqcup U(D_k)$, the sequence $(E_k)_k$ forms a partition of $\text{supp } U$ into U -invariant sets. In particular, $U = \lim_k \prod_{i=0}^k U_{E_i}$ in the uniform topology and therefore in the topology of \mathbb{G} as well by Proposition 3.4. Moreover, the support of U_{E_k} has \mathbb{G} -conditional measure at most $\mu_{\mathbb{G}}(\text{supp } \tilde{U}_n)$ by Eq. (3.2). The set $\tilde{V}_n(\text{supp } \tilde{U}_n)$ is disjoint from $\text{supp } \tilde{U}_n$ by construction. Lemma 3.17 applies and provides an involution in G whose support has the same conditional measure as that of U_{E_k} . Lemma 3.16 shows that each U_{E_k} belongs to G and therefore also $U \in G$, as needed. \square

THEOREM 3.19. *Let $\mathbb{G} \leq \text{Aut}(X, \mu)$ be an aperiodic Polish finitely full group. For any closed normal subgroup $N \leq \mathfrak{S}(\mathbb{G})$ there is a unique \mathbb{G} -invariant set A such that $N = \mathfrak{S}(\mathbb{G})_A$.*

PROOF. First, observe that for \mathbb{G} -invariant A_1 and A_2 , any involution $U \in \mathbb{G}$ supported in $A_1 \cup A_2$ decomposes into the product of one involution supported in A_1 , and one supported in A_2 . It follows that the closed group generated by $\mathfrak{S}(\mathbb{G})_{A_1} \cup \mathfrak{S}(\mathbb{G})_{A_2}$ is equal to $\mathfrak{S}(\mathbb{G})_{A_1 \cup A_2}$. Also, by Proposition 3.4, whenever $(A_n)_n$ is an increasing sequence of \mathbb{G} -invariant sets, one has

$$\overline{\bigcup_n \mathfrak{S}(\mathbb{G})_{A_n}} = \mathfrak{S}(\mathbb{G})_{\bigcup_n A_n}.$$

The set $\{A \in \text{MAIlg}(X, \mu) : A \text{ is } \mathbb{G}\text{-invariant and } \mathfrak{S}(\mathbb{G})_A \leq N\}$ is thus directed and is closed under the countable unions. It therefore admits a unique maximum element, which is the set A we seek. Indeed, $\mathfrak{S}(\mathbb{G})_A \leq N$, and the reverse inclusion is a direct consequence of Proposition 3.18.

It remains to argue that the set A satisfying $N = \mathfrak{S}(\mathbb{G})_A$ is unique. Suppose towards a contradiction that $\mathfrak{S}(\mathbb{G})_{A_1} = \mathfrak{S}(\mathbb{G})_{A_2}$ for $A_1 \neq A_2$. By symmetry, we may assume that $\mu(A_1 \setminus A_2) > 0$. Lemma 3.6 provides an involution $V \in \mathbb{G}$ whose support is nontrivial and is contained in $A_1 \setminus A_2$, thus $V \in \mathfrak{S}(\mathbb{G})_{A_1}$ but $V \notin \mathfrak{S}(\mathbb{G})_{A_2}$, contradicting $\mathfrak{S}(\mathbb{G})_{A_1} = \mathfrak{S}(\mathbb{G})_{A_2}$. \square

COROLLARY 3.20. *Let $\mathbb{G} \leq \text{Aut}(X, \mu)$ be an aperiodic Polish finitely full group. The group $\mathfrak{S}(\mathbb{G})$ is topologically simple if and only if \mathbb{G} is ergodic.*

PROOF. If \mathbb{G} is ergodic, then $\mathfrak{S}(\mathbb{G})$ is topologically simple by Theorem 3.19. Conversely, suppose that \mathbb{G} is not ergodic and let $A \subseteq X$ be a \mathbb{G} -invariant set with $\mu(A) \notin \{0, 1\}$. Then $\mathfrak{S}(\mathbb{G})_A$ is a normal subgroup of \mathbb{G} which is neither trivial nor equal to $\mathfrak{S}(\mathbb{G})$ as a consequence of Lemma 3.6 applied to A and its complement. \square

Specifying the corollary above to L^1 full groups and using Corollary 3.15, we obtain the following result.

COROLLARY 3.21. *Let G be a Polish normed group, and let $G \curvearrowright X$ be an aperiodic Borel measure-preserving action on a standard probability space (X, μ) . The topological derived subgroup of the L^1 full group of the action is topologically simple if and only if the action is ergodic.*

3.4. Maximal norms on the derived subgroup

The purpose of this section is to establish sufficient conditions for a norm on the derived subgroup of an induction friendly Polish finitely full group to be maximal in the sense of Section 2.3. Our argument follows closely the one given in [LM21, Sec. 6.2] for amenable graphings. The main application of Proposition 3.24 will be given in Theorem 5.5, but we hope that the setup of this section can be useful in other contexts, such as φ -integrable full groups [CJMT22].

DEFINITION 3.22. A norm $\|\cdot\|$ on a subgroup $\mathbb{G} \leq \text{Aut}(X, \mu)$ is **additive** if $\|TS\| = \|T\| + \|S\|$ for all $T, S \in \mathbb{G}$ with disjoint supports.

The following lemma parallels [LM21, Lem. 6.4] and is the key to showing that the norm on the derived subgroup is both coarsely proper and large-scale geodesic.

LEMMA 3.23. *Let $\mathbb{G} \leq \text{Aut}(X, \mu)$ be a finitely full Polish group, and suppose that $\|\cdot\|$ is a compatible additive norm on \mathbb{G} . For any periodic $U \in \mathbb{G}$ with bounded periods and for every $n \in \mathbb{N}$, there are periodic elements $U_1, \dots, U_n \in \mathbb{G}$ such that*

$$U = U_1 \cdots U_n \text{ and } \|U_i\| = \frac{\|U\|}{n} \text{ for every } 1 \leq i \leq n.$$

PROOF. Let $M = \|U\|$ and $A \subseteq X$ be a fundamental domain for U . We may identify A with the interval $[0, \mu(A)]$ endowed with the Lebesgue measure. Put $A_t = [0, t] \cap A$, $0 \leq t \leq \mu(A)$, and let $B_t = \bigcup_{n \in \mathbb{Z}} U^n(A_t)$ be the U -saturation of A_t . Note that $U_{B_t} \in \mathbb{G}$ for all $t \in [0, \mu(A)]$ since B_t is U -invariant and \mathbb{G} is finitely full, and that $t \mapsto B_t$ is continuous.

The map $[0, \mu(A)] \ni t \mapsto U_{B_t} \in [U] \subseteq \mathbb{G}$ is thus continuous with respect to the uniform topology on $[U]$, and therefore also with respect to the topology of \mathbb{G} by Proposition 3.4. Whence the function $\psi : [0, \mu(A)] \rightarrow \mathbb{R}$ given by $\psi(t) = \|U_{B_t}\|$ is also continuous.

We have $\psi(0) = 0$ and $\psi(\mu(A)) = M$, so the intermediate value theorem yields existence of reals $0 = t_0 < t_1 < \cdots < t_{n-1} < t_n = \mu(A)$ such that $\psi(t_i) = \frac{iM}{n}$ for all $i \in \{0, \dots, n\}$. Set $C_i = B_{t_i} \setminus B_{t_{i-1}}$ for $i \in \{1, \dots, n\}$. By construction, each C_i is U -invariant and $X = \bigsqcup_{i=1}^n C_i$. Putting $U_i = U_{A_i}$, we get $U = \prod_{i=1}^n U_i$. Finally for each $i \in \{1, \dots, n\}$ the equality $C_i = B_{t_i} \setminus B_{t_{i-1}}$ and additivity of the norm gives

$$\psi(t_i) = \|U_{B_{t_i}}\| = \|U_i U_{B_{t_{i-1}}}\| = \|U_i\| + \|U_{B_{t_{i-1}}}\| = \|U_i\| + \psi(t_{i-1}),$$

hence $\|U_i\| = \frac{\|U\|}{n}$ for all $i \leq n$, as needed. \square

PROPOSITION 3.24. *Let $\mathbb{G} \leq \text{Aut}(X, \mu)$ be an induction friendly Polish finitely full group and let $\|\cdot\|$ be a compatible additive norm on it. If the set of periodic elements is dense in $D(\mathbb{G})$, then $\|\cdot\|$ is a maximal norm on $D(\mathbb{G})$.*

PROOF. In view of Proposition A.10, it suffices to show that $\|\cdot\|$ is both large-scale geodesic (see Definition A.8) and coarsely proper (see Definition A.9). Note that induction friendliness yields density in $D(\mathbb{G})$ of periodic automorphisms with bounded periods.

To see that $\|\cdot\|$ is large-scale geodesic (with constant $K = 2$), let us take a non-trivial $T \in D(\mathbb{G})$ and pick a periodic $U \in D(\mathbb{G})$ with bounded periods such that $\|TU^{-1}\| < \min\{2, \|T\|/2\}$. Note that

$$(3.3) \quad \|U\| = \|U^{-1}\| = \|T^{-1}TU^{-1}\| \leq \|T^{-1}\| + \|TU^{-1}\| \leq 3\|T\|/2$$

Fix $n \in \mathbb{N}$ large enough to ensure $\frac{3\|T\|}{2n} \leq 2$. By Lemma 3.23, we may decompose U into a product of n elements U_1, \dots, U_n each of norm at most $\frac{3\|T\|}{2n} \leq 2$. Therefore

$$T = (TU^{-1}) \cdot U_1 \cdots U_n,$$

where TU^{-1} and each of U_i , $1 \leq i \leq n$, has norm at most 2 and, in view of Eq. (3.3),

$$\|TU^{-1}\| + \sum_{i=1}^n \|U_i\| \leq \frac{\|T\|}{2} + \|U\| \leq 2\|T\|,$$

thus concluding the proof that $\|\cdot\|$ is large-scale geodesic.

We now show that $\|\cdot\|$ is coarsely proper. Fix $\epsilon > 0$ and $R > 0$. Let $n \in \mathbb{N}$ be so large that $n\epsilon \geq R + \epsilon$. Then every element $T \in D(\mathbb{G})$ of norm at most R is a product of $n + 1$ elements of norm at most ϵ , namely one element TU^{-1} of norm at most ϵ , where U is periodic with bounded periods as provided by density, and $U = U_1 \cdots U_n$, where each U_i has norm at most $\frac{R+\epsilon}{n} \leq \epsilon$ as per Lemma 3.23. Thus $\|\cdot\|$ is both coarsely proper and large-scale geodesic, and hence is maximal by Proposition A.10. \square

REMARK 3.25. We do not have an example of an induction friendly Polish finitely full group \mathbb{G} such that the periodic elements are not dense in $D(\mathbb{G})$. We suspect that such groups do exist, for instance when \mathbb{G} is the L^1 full group of a free action of the free group on 2 generators.

Full groups of locally compact group actions

In this chapter, we narrow down the generality of the narrative and focus on actions of *locally compact* Polish groups, or equivalently, of locally compact second-countable groups. Such restrictions enlarge our toolbox in a number of ways. For instance, all locally compact Polish group actions admit cross-sections to which the so-called Voronoi tessellations can be associated. We use this to show in Section 4.1 a natural density result for subsets of L^1 full groups defined from dense subsets of the acting group (Theorem 4.2 and Corollary 4.3). For reader's convenience, Appendix C.2 contains a concise reminder of the needed facts about tessellations.

Another key property of free¹ actions of locally compact groups is the existence of a Haar measure on each individual orbit. As we discuss in Section 4.2, elements of the full group act by non-singular transformations and, in particular, admit the Hopf decomposition (see Appendix B). Section 4.3 explains how these orbitwise decompositions can be understood globally, yielding a natural generalization of the periodic/aperiodic partition for elements of the full group of a measure-preserving action of a *discrete* group. The periodic part in the later case corresponds to the conservative piece of the Hopf decomposition, which generally exhibits a much more complicated dynamical behavior. We will get back to this in Chapters 7 and 8.

In the final Section 4.4, we connect L^1 full groups to the notion of L^1 orbit equivalence for actions of locally compact *compactly generated* Polish groups.

4.1. Dense subgroups in L^1 full groups

Our goal in this section is to prove that any element of the full group $[G \curvearrowright X]$ can be approximated arbitrarily well by an automorphism that piecewise acts by elements of a given dense subset of G .

DEFINITION 4.1. A measure-preserving transformation $T : A \rightarrow B$ between two measurable sets $A, B \subseteq X$ is said to be **H -decomposable**, where $H \subseteq \text{Aut}(X, \mu)$, if there exist a measurable partition $A = \bigsqcup_{k \in \mathbb{N}} A_k$ and elements $h_k \in H$ such that $T \upharpoonright_{A_k} = h_k$ for all $k \in \mathbb{N}$.

The property of being H -decomposable is similar to being an element of the full group generated by H except that we do not require the transformation to be defined on all of X .

THEOREM 4.2. *Let $G \curvearrowright X$ be a measure-preserving action of a locally compact Polish group, let $\|\cdot\|$ be a compatible norm on G with the associated metric on the*

¹Motivated by our focus on \mathbb{R} -flows, this monograph primarily concentrates on *free* actions. We note, however, that each orbit of a Borel action of a locally compact Polish group is a homogeneous space, since point stabilizers are necessarily closed. In particular, orbits can be endowed with the Haar measure even without the freeness assumption.

orbits $D : \mathcal{R}_G \rightarrow \mathbb{R}^{\geq 0}$, and let $H \subseteq G$ be a dense set. For any $T \in [G \curvearrowright X]$ and any $\epsilon > 0$ there exists an H -decomposable transformation $S \in [G \curvearrowright X]$ such that $\text{ess sup}_{x \in X} D(Tx, Sx) < \epsilon$.

Theorem 4.2 establishes density of H -decomposable transformations in the very strong uniform topology given by ess sup . In particular, it pertains to the L^1 topology.

COROLLARY 4.3. *Let $G \curvearrowright X$ be a measure-preserving action of a locally compact Polish group, let $\|\cdot\|$ be a compatible norm on G , and let $H \subseteq G$ be a dense subgroup. The L^1 full group $[H \curvearrowright X]_1$ is dense in $[G \curvearrowright X]_1$.*

REMARK 4.4. Theorem 4.2 is an improvement upon the conclusion of [CLM18, Thm. 2.1], which shows that $[H \curvearrowright X]$ is dense in $[G \curvearrowright X]$ whenever H is a dense subgroup of G . While the proof, which we present below, establishes density in a much stronger topology through more elementary means, we note that, as already mentioned in [CLM18, Thm. 2.3], their methods apply to all *suitable* (in the sense of [Bec13]; see also Definition 4.7) actions of Polish groups, whereas our approach here crucially uses local compactness of the acting group to guarantee existence of various cross-sections.

Let \mathcal{C} be a cross-section for a measure-preserving action $G \curvearrowright X$ and let \mathcal{W} be a tessellation over \mathcal{C} (in the sense of Appendix C.2). Let also $\nu_{\mathcal{W}}$ be the push-forward measure $(\pi_{\mathcal{W}})_*\mu$ on the cross-section and $(\mu_c)_{c \in \mathcal{C}}$ be the disintegration of μ over $(\pi_{\mathcal{W}}, \nu_{\mathcal{W}})$ (see Appendix C.1 and Theorem C.1, specifically). Without loss of generality, we assume, whenever convenient, that the set H in the statement of Theorem 4.2 is countable.

DEFINITION 4.5. Two Borel sets $A, B \subseteq X$ are said to be

- **\mathcal{W} -proportionate** if the equivalence $\mu_c(A) = 0 \iff \mu_c(B) = 0$ holds for $\nu_{\mathcal{W}}$ -almost all $c \in \mathcal{C}$;
- **\mathcal{W} -equimeasurable** if $\mu_c(A) = \mu_c(B)$ for $\nu_{\mathcal{W}}$ -almost all $c \in \mathcal{C}$.

For the context of Lemmas 4.6 through 4.10, we let N denote an open *symmetric* neighborhood of the identity of G , and \mathcal{W} stands for an N -lacunary tessellation.

LEMMA 4.6. *If $A, B \subseteq N \cdot \mathcal{C}$ are \mathcal{W} -proportionate Borel sets then*

$$\mu(B \setminus N^2 \cdot A) = 0.$$

PROOF. By the defining property of the disintegration,

$$\mu(B \setminus N^2 \cdot A) = \int_{\mathcal{C}} \mu_c(B \setminus N^2 \cdot A) d\nu_{\mathcal{W}}(c),$$

and so we need to check that $\mu_c(B \setminus N^2 \cdot A) = 0$ for $\nu_{\mathcal{W}}$ -almost all c . Since A and B are \mathcal{W} -proportionate, it suffices to show that $\mu_c(B \setminus N^2 \cdot A) = 0$ whenever $\mu_c(A) \neq 0$. For any $c \in \mathcal{C}$ satisfying the latter, one necessarily has $c \in N \cdot A$ (because $A \subseteq N \cdot \mathcal{C}$ and \mathcal{W} is N -lacunary, by assumption), and thus $N \cdot c \subseteq N^2 \cdot A$. In particular, $(B \setminus N^2 \cdot A) \cap N \cdot c = \emptyset$. It remains to use the inclusion $B \subseteq N \cdot \mathcal{C}$, which together with N -lacunarity of \mathcal{W} , guarantees that

$$\mu_c(B \setminus N^2 \cdot A) = \mu_c((B \setminus N^2 \cdot A) \cap N \cdot c) = 0. \quad \square$$

For the proof of the next lemma, we need the notion of a suitable action, introduced by H. Becker [Bec13, Def. 1.2.7].

DEFINITION 4.7. A measure-preserving Borel action $G \curvearrowright X$ of a Polish group G is **suitable** if for all Borel sets $A, B \subseteq X$ one of the two options holds:

- (1) for any open neighborhood of the identity $M \subseteq G$ there exists $g \in M$ such that $\mu(gA \cap B) > 0$;
- (2) there exist Borel sets $A' \subseteq A, B' \subseteq B$ such that $\mu(A \setminus A') = 0 = \mu(B \setminus B')$ and an open neighborhood of the identity $M \subseteq G$ such that $M \cdot A' \cap B' = \emptyset$.

All measure-preserving actions of locally compact Polish groups are known to be suitable (see [Bec13, Thm. 1.2.9]).

LEMMA 4.8. *For all non-negligible \mathcal{W} -proportionate Borel sets $A, B \subseteq N \cdot \mathcal{C}$, there exists an open set $U \subseteq N^3$ such that $\mu(gA \cap B) > 0$ for all $g \in U$.*

PROOF. Let $H_1 = H \cap N^2$, which is dense in $N^2 = NN^{-1}$, and put $A_1 = H_1 \cdot A$. We apply the dichotomy in the definition of a suitable action to the sets A_1, B and show that item (2) cannot hold.

Indeed, suppose there exist $A'_1 \subseteq A_1, B' \subseteq B$ satisfying

$$\mu(A_1 \setminus A'_1) = 0 = \mu(B \setminus B'),$$

and an open neighborhood of the identity $M \subseteq G$ such that $(M \cdot A'_1) \cap B' = \emptyset$. Set $A' = \bigcap_n (h_n^{-1} A'_1 \cap A)$, where $(h_n)_{n \in \mathbb{N}}$ is an enumeration of H_1 , and note that $\mu(A \setminus A') = 0$ and $(MH_1 \cdot A') \cap B' = \emptyset$, simply because $H_1 \cdot A' \subseteq A'_1$. Since H_1 is dense in N^2 , we have $N^2 \subseteq MH_1$ and thus $(N^2 \cdot A') \cap B' = \emptyset$. Lemma 4.6, applied to A' and B' , guarantees that $\mu(B' \setminus N^2 \cdot A') = 0$, which is possible only when $\mu(B') = 0$, contradicting the assumption that B is non-negligible.

We are left with the alternative of the item (1), and so there has to exist some $g \in N$ such that $\mu(gA_1 \cap B) > 0$. Since $A_1 = H_1 \cdot A$, there exists $h \in H_1$ such that $\mu(ghA \cap B) > 0$. It remains to note that $gh \in N^3$ and that $\mu(g'A \cap B) > 0$ is an open condition on g' , since the homomorphism $G \rightarrow \text{Aut}(X, \mu)$ associated to the measure-preserving action of G on (X, μ) is continuous (see for instance [CLM18, Lem. 1.2]). \square

LEMMA 4.9. *For any non-empty open $V \subseteq N$ and for any non-negligible Borel set $A \subseteq X$, there exists $h \in H$ such that*

$$\mu(\{x \in A : hx \in V \cdot \mathcal{C} \text{ and } \pi_{\mathcal{W}}(x) = \pi_{\mathcal{W}}(hx)\}) > 0.$$

PROOF. Let $\zeta : X \rightarrow \mathcal{W}$ be the Borel bijection $\zeta(x) = (\pi_{\mathcal{W}}(x), x)$ and consider the push-forward measure $\zeta_* \mu$, which for $Z \subseteq \mathcal{W}$ can be expressed as $\zeta_* \mu(Z) = \int_{\mathcal{C}} \mu_c(Z_c) d\nu_{\mathcal{W}}(c)$. Let $(h_n)_{n \in \mathbb{N}}$ be an enumeration of H and set

$$W_n = \{(c, x) \in \mathcal{W} : \pi_{\mathcal{W}}(x) = \pi_{\mathcal{W}}(h_n x) \text{ and } h_n x \in V \cdot \mathcal{C}\}.$$

We claim that $\bigcup_n W_n = \mathcal{W}$. Indeed, for each $(c, x) \in \mathcal{W}$ the set of $g \in G$ such that $gx \in V \cdot c$ is non-empty and open, hence there is $h_n \in H$ such that $h_n x \in V \cdot c$.

Finally, A is non-negligible by assumption, i.e., $0 < \mu(A) = \zeta_* \mu(\zeta(A))$, so there exists W_n such that $\zeta_* \mu(\zeta(A) \cap W_n) > 0$, which translates into the required

$$\mu(\{x \in A : h_n x \in V \cdot \mathcal{C} \text{ and } \pi_{\mathcal{W}}(x) = \pi_{\mathcal{W}}(h_n x)\}) > 0. \quad \square$$

LEMMA 4.10. *For all non-negligible \mathcal{W} -proportionate Borel sets $A, B \subseteq X$, there exists $h \in H$ such that*

$$\mu(\{x \in A : hx \in B \text{ and } \pi_{\mathcal{W}}(x) = \pi_{\mathcal{W}}(hx)\}) > 0.$$

PROOF. The plan is to reduce the setup of this lemma to that of Lemma 4.8. Let $V \subseteq N$ be a symmetric neighborhood of the identity that is furthermore small enough to guarantee that \mathcal{W} is V^4 -lacunary. Apply Lemma 4.9 to find $h_1 \in H$ such that for

$$A' = \{x \in A : h_1x \in V \cdot \mathcal{C} \text{ and } \pi_{\mathcal{W}}(x) = \pi_{\mathcal{W}}(h_1x)\}$$

one has $\mu(A') > 0$. Set $A_1 = h_1A'$, $B_1 = \pi_{\mathcal{W}}^{-1}(\{c \in \mathcal{C} : \mu_c(A_1) > 0\}) \cap B$ and note that A_1 and B_1 are non-negligible \mathcal{W} -proportionate sets. Moreover, $A_1 \subseteq V \cdot \mathcal{C}$ by construction.

Repeat the same steps for B_1 and find $h_2 \in H$ such that for

$$B'_1 = \{x \in B_1 : h_2x \in V \cdot \mathcal{C} \text{ and } \pi_{\mathcal{W}}(x) = \pi_{\mathcal{W}}(h_2x)\}$$

we have $\mu(B'_1) > 0$. Set $B_2 = h_2B'_1$ and $A_2 = A_1 \cap \pi_{\mathcal{W}}^{-1}(\{c \in \mathcal{C} : \mu_c(B_2) > 0\})$. Once again, sets A_2 and B_2 are non-negligible, \mathcal{W} -proportionate and are both contained in $V \cdot \mathcal{C}$.

We now apply Lemma 4.8 to sets A_2, B_2 and \mathcal{W} , viewed as a V -lacunary tessellation, yielding an open $U \subseteq V^3$ such that $\mu(gA_2 \cap B_2) > 0$ for all $g \in U$. Note that since $U \subseteq V^3$ and \mathcal{W} is, in fact, V^4 -lacunary, the equality $\pi_{\mathcal{W}}(x) = \pi_{\mathcal{W}}(gx)$ holds for all $x \in V \cdot \mathcal{C}$ and $g \in U$. We conclude that $\mu(h_2^{-1}gh_1A \cap B) > 0$ for all $g \in U$ and hence any $h \in h_2^{-1}Uh_1 \cap H$ satisfies the conclusion of the lemma. \square

A measure-preserving map $T : A \rightarrow B$ is \mathcal{W} -coherent if μ -almost surely one has $\pi_{\mathcal{W}}(x) = \pi_{\mathcal{W}}(Tx)$.

LEMMA 4.11. *For all \mathcal{W} -equimeasurable Borel sets $A, B \subseteq X$, there exists a \mathcal{W} -coherent H -decomposable measure-preserving bijection $T : A \rightarrow B$.*

PROOF. Let $(h_n)_{n \in \mathbb{N}}$ be an enumeration of H . Consider the set

$$A_0 = \{x \in A : h_0x \in B \text{ and } \pi_{\mathcal{W}}(x) = \pi_{\mathcal{W}}(h_0x)\},$$

and let $B_0 = h_0A_0$. Note that the sets $A \setminus A_0$ and $B \setminus B_0$ are \mathcal{W} -equimeasurable, so we may continue in the same fashion and construct sets A_k such that

$$A_k = \left\{ x \in A \setminus \bigsqcup_{i < k} A_i : h_kx \in B \setminus \bigsqcup_{i < k} B_i \text{ and } \pi_{\mathcal{W}}(x) = \pi_{\mathcal{W}}(h_kx) \right\}.$$

We define $T : \bigsqcup_{k \in \mathbb{N}} A_k \rightarrow \bigsqcup_{k \in \mathbb{N}} B_k$ by the condition $Tx = h_kx$ for $x \in A_k$.

Sets $A \setminus \bigsqcup_{k \in \mathbb{N}} A_k$ and $B \setminus \bigsqcup_{k \in \mathbb{N}} B_k$ are \mathcal{W} -equimeasurable. If either one of them (and thus necessarily both of them) were non-negligible, Lemma 4.10 would yield an element $h \in H$ that moves a portion of $A \setminus \bigsqcup_{k \in \mathbb{N}} A_k$ into $B \setminus \bigsqcup_{k \in \mathbb{N}} B_k$, contradicting the construction. We conclude that

$$\mu\left(A \setminus \bigsqcup_{k \in \mathbb{N}} A_k\right) = 0 = \mu\left(B \setminus \bigsqcup_{k \in \mathbb{N}} B_k\right)$$

and T is therefore as required. \square

LEMMA 4.12. *Suppose \mathcal{W} is a cocompact tessellation and let $A, B \subseteq X$ be \mathcal{W} -equimeasurable Borel sets. For any $\epsilon > 0$ and any \mathcal{W} -coherent measure-preserving $T : A \rightarrow B$ there exists a \mathcal{W} -coherent H -decomposable $\tilde{T} : A \rightarrow B$ such that $\text{ess sup}_{x \in A} D(Tx, \tilde{T}x) < \epsilon$.*

PROOF. Let \mathcal{V} be a K' -cocompact tessellation over some cross-section \mathcal{C}' such that the diameter of each region in \mathcal{V} is less than ϵ . Suppose \mathcal{W} is K -cocompact. By Lemma C.9, we can find a finite partition of $\mathcal{C}' = \bigsqcup_{i \leq n} \mathcal{C}'_i$ such that each \mathcal{C}'_i is $K'K^2K'$ -lacunary, which guarantees that, for each i , every \mathcal{W}_c intersects at most one class $\mathcal{V}_{c'}$, $c' \in \mathcal{C}'_i$. For each $i, j < n$ set $A_{(i,j)} = \{x \in A : \pi_{\mathcal{V}}(x) \in \mathcal{C}'_i, \pi_{\mathcal{V}}(Tx) \in \mathcal{C}'_j\}$ and $B_{(i,j)} = TA_{(i,j)}$. We re-enumerate sets $A_{(i,j)}$ and $B_{(i,j)}$ as a sequence A_k, B_k , $k \leq n^2$ and note that for all $x, y \in A_k$ one has

$$\pi_{\mathcal{W}}(x) = \pi_{\mathcal{W}}(y) \implies (\pi_{\mathcal{V}}(x) = \pi_{\mathcal{V}}(y) \text{ and } \pi_{\mathcal{V}}(Tx) = \pi_{\mathcal{V}}(Ty)).$$

Moreover, sets A_k and $T(A_k)$ are \mathcal{W} -equimeasurable, so Lemma 4.11 yields \mathcal{W} -coherent H -decomposable measure-preserving maps $T_k : A_k \rightarrow T(A_k)$. The transformation $\tilde{T} : A \rightarrow B$ can now be defined by the condition $\tilde{T}x = T_kx$ whenever $x \in A_k$. It is easy to check that \tilde{T} is as claimed. \square

PROOF OF THEOREM 4.2. Fix a cocompact cross-section \mathcal{C} , and let $(U_n)_n$ be a nested and exhaustive sequence of compact neighborhoods of the identity in G . For all $n \in \mathbb{N}$, select based on Lemma C.9 a finite sequence of cocompact cross-sections $\mathcal{C}_1^n, \dots, \mathcal{C}_{k_n}^n$ such that each \mathcal{C}_i^n is U_n -lacunary and $\mathcal{C} = \bigsqcup_{i=1}^{k_n} \mathcal{C}_i^n$. Re-enumerate cross-sections \mathcal{C}_i^n , $n \in \mathbb{N}$, $1 \leq i \leq k_n$, into a sequence $(\mathcal{C}_k)_{k=0}^\infty$ and let \mathcal{V}_k be the Voronoi tessellation over \mathcal{C}_k .

Let $A_0 = \{x \in X : \pi_{\mathcal{V}_0}(x) = \pi_{\mathcal{V}_0}(Tx)\}$, and use Lemma 4.12 to find an H -decomposable measure-preserving map $T_0 : A_0 \rightarrow T(A_0)$ that satisfies the inequality $\text{ess sup}_{x \in A_0} D(T_0x, Tx) < \epsilon$. Set

$$A_k = \left\{ x \in X : \pi_{\mathcal{V}_k}(x) = \pi_{\mathcal{V}_k}(Tx) \text{ and } x \notin \bigsqcup_{l < k} A_l \right\}$$

and observe that A_k , $k \in \mathbb{N}$, form a partition of X . Find transformations $T_k : A_k \rightarrow T(A_k)$ by repeated applications of Lemma 4.12 applied to the tessellations \mathcal{V}_k . The element $S \in [G \curvearrowright X]$ defined by $Sx = T_kx$ satisfies the conclusion of the theorem. \square

4.2. Orbital transformations

Let $G \curvearrowright X$ be a *free* measure-preserving action of a locally compact Polish group on a standard probability space. Fix a *right*-invariant Haar measure λ on G . Any orbit $[x]_{\mathcal{R}_G}$ can be identified with the group itself via the map $G \ni g \mapsto gx \in [x]_{\mathcal{R}_G}$, and λ can be pushed via this identification onto orbits resulting in a collection $(\lambda_x)_{x \in X}$ of measures on X defined by $\lambda_x(A) = \lambda(\{g \in G : gx \in A\})$. Right invariance of the measure ensures that λ_x depends only on the orbit $[x]_{\mathcal{R}_G}$ and is independent of the choice of the base point, i.e., $\lambda_x = \lambda_y$ whenever $x\mathcal{R}_Gy$.

This section focuses on two main facts: the so-called mass-transport principle, given in Eq. (4.1) below, and non-singularity of the transformations induced by elements of $[G \curvearrowright X]$ onto orbits of the action, formulated in Proposition 4.13. Both of these topics have been discussed in the literature in many related contexts including, for instance, [CLM18, Appen. A] and the treatise [ADR00]. We are, however, not aware of any specific reference from which Eq. (4.1) and Proposition 4.13 can be readily deduced. The following derivations are therefore included for reader's convenience, with the disclaimer that these results are likely to be known to experts.

Freeness of the action allows us to identify the equivalence relation \mathcal{R}_G with $X \times G$ via $\Phi : X \times G \rightarrow \mathcal{R}_G$, $\Phi(x, g) = (x, gx)$. The push-forward $\Phi_*(\mu \times \lambda)$ of the

product measure is denoted by M and can equivalently be defined by

$$M(A) = \int_X \lambda_x(A_x) d\mu(x),$$

where $A \subseteq \mathcal{R}_G$ and $A_x = \{y \in X : (x, y) \in A\}$.

In general, the flip transformation $\sigma : \mathcal{R}_G \rightarrow \mathcal{R}_G$, $\sigma(x, y) = (y, x)$, is not M -invariant. Set $\Psi : X \times G \rightarrow X \times G$ to be $\Psi = \Phi^{-1} \circ \sigma \circ \Phi$, which amounts to $\Psi(x, g) = (gx, g^{-1})$. Following the computation as in [CLM18, Prop. A.11], one can easily check that $\Psi_*(\mu \times \lambda) = \mu \times \hat{\lambda}$, where $\hat{\lambda}$ is the associated *left*-invariant measure, $\hat{\lambda}(A) = \lambda(A^{-1})$. If we define the measure \widehat{M} on \mathcal{R}_G to be

$$\widehat{M}(A) = \Phi_*(\mu \times \hat{\lambda}) = \int_X \hat{\lambda}_x(A_x) d\mu(x),$$

then $\sigma_*M = \widehat{M}$. In particular, σ is M -invariant if and only if $\lambda = \hat{\lambda}$, i.e., G is unimodular.

Let $\Delta : G \rightarrow \mathbb{R}^{>0}$ be the *left Haar modulus* function given for $g \in G$ by $\lambda(gA) = \Delta(g)\lambda(A)$. Recall that $\Delta : G \rightarrow \mathbb{R}^{>0}$ is a continuous homomorphism (see, for instance, [Nac65, Prop. 7]), measures λ and $\hat{\lambda}$ belong to the same measure class and $\frac{d\hat{\lambda}}{d\lambda}(g) = \Delta(g^{-1})$ for all $g \in G$ (see [Nac65, p. 79]).

A function $f : \mathcal{R}_G \rightarrow \mathbb{R}$ is M -integrable if and only if $X \times G \ni (x, g) \mapsto f(x, gx)$ is $(\mu \times \lambda)$ -integrable, which together with the expression for the Radon-Nikodym derivative $\frac{d(\mu \times \hat{\lambda})}{d(\mu \times \lambda)} = \frac{d\hat{\lambda}}{d\lambda}$ and Fubini's theorem yields the following identity:

$$(4.1) \quad \int_X \int_G f(x, g \cdot x) d\lambda(g) d\mu(x) = \int_X \int_G \Delta(g) f(g \cdot x, x) d\lambda(g) d\mu(x).$$

When the group G is unimodular, this expression attains a very symmetric form and is known as the **mass-transport principle**:

$$(4.2) \quad \int_X \int_G f(x, g \cdot x) d\lambda(g) d\mu(x) = \int_X \int_G f(g \cdot x, x) d\lambda(g) d\mu(x).$$

Any automorphism $T \in [G \curvearrowright X]$ induces for each $x \in X$ a transformation of the σ -finite measure space (X, λ_x) . In general, T does not preserve λ_x , however, it is always non-singular, and the Radon-Nikodym derivative $\frac{dT_*\lambda_x}{d\lambda_x}$ can be described explicitly. Note that the full group $[G \curvearrowright X]$ admits two natural actions on the equivalence relation \mathcal{R}_G : the *left* action l is given by $l_T(x, y) = (Tx, y)$, and the *right* action r is defined as $r_T(x, y) = (x, Ty)$. A straightforward verification (see [CLM18, Lem. A.9]) shows that l is always M -invariant. Since $r_T \circ \sigma = \sigma \circ l_T$, for all $T \in [G \curvearrowright X]$ we have

$$(r_T)_*\widehat{M} = (r_T \circ \sigma)_*M = (\sigma \circ l_T)_*M = \sigma_*M = \widehat{M}.$$

Let $\Theta = \Phi^{-1} \circ r_T \circ \Phi$, i.e., $\Theta(x, g) = (x, \rho_{Tg}(x))$. The equality $(r_T)_*\widehat{M} = \widehat{M}$ is equivalent to $\Theta_*(\mu \times \hat{\lambda}) = \mu \times \hat{\lambda}$. The latter implies that each Borel $B \subseteq G$ and all

measurable $A \subseteq X$ we have

$$\begin{aligned} \int_A \widehat{\lambda}(B) d\mu &= (\mu \times \widehat{\lambda})(A \times B) = \Theta_*(\mu \times \widehat{\lambda})(A \times B) \\ &= (\mu \times \widehat{\lambda})(\{(x, g) \in X \times G : (x, \rho_{Tg}(x)) \in A \times B\}) \\ \text{Fubini's theorem} &= \int_A \widehat{\lambda}(\{g \in G : \rho_{Tg}(x) \in B\}) d\mu(x) \\ &= \int_A \widehat{\lambda}(\{g \in G : gx \in T^{-1}Bx\}) d\mu(x), \end{aligned}$$

which is possible only if $\widehat{\lambda}(\{g \in G : gx \in T^{-1}Bx\}) = \widehat{\lambda}(B)$ for μ -almost all x . Passing to the measures on the orbits, this translates for each B into $\widehat{\lambda}_x(T^{-1}Bx) = \widehat{\lambda}_x(Bx)$. If $(B_n)_{n \in \mathbb{N}}$ is a countable algebra of Borel sets in G that generates the whole Borel σ -algebra, then for each $x \in X$, $(B_n x)_{n \in \mathbb{N}}$ is an algebra of Borel subsets of the orbit $[x]_{\mathcal{R}_G}$, which generates the Borel σ -algebra on it. We have established that for μ -almost all $x \in X$ the two measures, $\widehat{\lambda}_x$ and $T_*\widehat{\lambda}_x$, coincide on each $B_n x$, $n \in \mathbb{N}$, thus μ -almost surely $\widehat{\lambda}_x = T_*\widehat{\lambda}_x$.

Equality $\frac{d\widehat{\lambda}}{d\lambda}(g) = \Delta(g^{-1})$ translates into $\frac{d\widehat{\lambda}_x}{d\lambda_x}(y) = \Delta(\rho(x, y)^{-1}) = \Delta(\rho(y, x))$ and the Radon-Nikodym derivative $\frac{dT_*\widehat{\lambda}_x}{d\lambda_x}$ can now be computed as follows.

$$\begin{aligned} \frac{dT_*\widehat{\lambda}_x}{d\lambda_x}(y) &= \frac{dT_*\widehat{\lambda}_x}{dT_*\widehat{\lambda}_x}(y) \cdot \frac{dT_*\widehat{\lambda}_x}{d\widehat{\lambda}_x}(y) \cdot \frac{d\widehat{\lambda}_x}{d\lambda_x}(y) \\ T \text{ preservers } \widehat{\lambda}_x &= \frac{dT_*\widehat{\lambda}_x}{dT_*\widehat{\lambda}_x}(y) \cdot \frac{d\widehat{\lambda}_x}{d\lambda_x}(y) = \frac{d\lambda_x}{d\widehat{\lambda}_x}(T^{-1}y) \cdot \frac{d\widehat{\lambda}_x}{d\lambda_x}(y) \\ &= \left(\frac{d\widehat{\lambda}_x}{d\lambda_x}(T^{-1}y) \right)^{-1} \cdot \frac{d\widehat{\lambda}_x}{d\lambda_x}(y) \\ &= \Delta(\rho(x, T^{-1}y)^{-1})^{-1} \Delta(\rho(x, y)^{-1}) \\ &= \Delta(\rho(x, T^{-1}y) \cdot \rho(y, x)) = \Delta(\rho_{T^{-1}}(y)). \end{aligned}$$

We summarize the content of this section into a proposition.

PROPOSITION 4.13. *Let G be a locally compact Polish group acting freely $G \curvearrowright X$ on a standard probability space (X, μ) . Let λ be a right Haar measure on G , $\Delta : G \rightarrow \mathbb{R}^{>0}$ be the corresponding Haar modulus, and let $(\lambda_x)_{x \in X}$ be the family of measures obtained by pushing λ onto orbits via the action map. Each $T \in [G \curvearrowright X]$ induces a non-singular transformation of (X, λ_x) for almost every $x \in X$, and moreover one has $\lambda_x(T^{-1}A) = \int_A \Delta(\rho_{T^{-1}}(y)) d\lambda_x(y)$ for all Borel sets $A \subseteq X$. If G is unimodular, then $T_*\lambda_x = \lambda_x$ for μ -almost all $x \in X$.*

For future reference, we isolate a simple lemma, which is an immediate consequence of Fubini's theorem.

LEMMA 4.14. *Let G be a locally compact Polish group acting freely on a standard probability space (X, μ) . Let $\lambda, \widehat{\lambda}, (\lambda_x)_{x \in X}$, and $(\widehat{\lambda})_{x \in X}$ be as above. For any Borel set $A \subseteq X$ the following are equivalent:*

- (1) $\mu(A) = 0$;
- (2) $\lambda_x(A) = 0$ for μ -almost all $x \in X$;
- (3) $\widehat{\lambda}_x(A) = 0$ for μ -almost all $x \in X$.

PROOF. (1) \iff (2) Using Fubini's Theorem on $(X \times G, \mu \times \lambda)$ to rearrange the order of quantifiers, one has:

$$\begin{aligned} \mu(A) = 0 &\iff \forall g \in G \forall^\mu x \in X \quad gx \notin A \\ &\iff \forall^\mu x \in X \forall^\lambda g \in G \quad gx \notin A \iff \forall^\mu x \in X \quad \lambda_x(A) = 0. \end{aligned}$$

(2) \iff (3) is evident, since λ and $\widehat{\lambda}$ are equivalent measures, hence so are λ_x and $\widehat{\lambda}_x$ for all $x \in X$. \square

4.3. The Hopf decomposition of elements of the full group

Fix an element $T \in [G \curvearrowright X]$ of the full group of a free measure-preserving action of a locally compact Polish group G . As explained in Section 4.2, T acts naturally in a non-singular manner on each G -orbit. This action thus has a Hopf decomposition (see Appendix B). We will now explain how to understand globally this decomposition, obtaining a generalization of the fact that when G is discrete, any element of the full group decomposes the space into a periodic and an aperiodic part.

Let us pick a cocompact cross-section \mathcal{C} and let $\mathcal{V}_{\mathcal{C}}$ be the associated Voronoi tessellation (see Appendix C.2). Set $\pi_{\mathcal{C}} : X \rightarrow \mathcal{C}$ to be the projection map given by the condition $(\pi_{\mathcal{C}}(x), x) \in \mathcal{V}_{\mathcal{C}}$ for all $x \in X$. Define the dissipative and conservative sets as follows:

$$\begin{aligned} D &= \{x \in X : \exists n \in \mathbb{N} \forall k \in \mathbb{Z} \text{ such that } |k| \geq n \text{ one has } \pi_{\mathcal{C}}(x) \neq \pi_{\mathcal{C}}(T^k x)\}, \\ C &= \{x \in X : \forall n \in \mathbb{N} \exists k_1, k_2 \in \mathbb{Z} \text{ such that} \\ &\quad k_1 \leq -n, n \leq k_2 \text{ and } \pi_{\mathcal{C}}(T^{k_1} x) = \pi_{\mathcal{C}}(x) = \pi_{\mathcal{C}}(T^{k_2} x)\}. \end{aligned}$$

In plain words, the dissipative set D consists of those points x whose orbit has a finite intersection with the Voronoi region of x . The conservative set C , on the other hand, collects all the points whose orbit is bi-recurrent in the region. We argue in Proposition 4.16 that sets D and C induce the Hopf decomposition for $T \upharpoonright_{[x]_{\mathcal{R}_T}}$ for almost every $x \in X$; in particular, $D \sqcup C$ is a partition of X , which is independent of the choice of the cross-section \mathcal{C} .

LEMMA 4.15. *Sets D and C partition the phase space: $X = D \sqcup C$.*

PROOF. Define sets N_+ and N_- according to

$$\begin{aligned} N_+ &= \{x \in X \setminus (D \sqcup C) : \forall k \geq 1 \quad \pi_{\mathcal{C}}(T^k x) \neq \pi_{\mathcal{C}}(x)\}, \\ N_- &= \{x \in X \setminus (D \sqcup C) : \forall k \geq 1 \quad \pi_{\mathcal{C}}(T^{-k} x) \neq \pi_{\mathcal{C}}(x)\}, \end{aligned}$$

and note that $X \setminus (D \sqcup C) \subseteq \bigcup_{k \in \mathbb{Z}} T^k(N_+ \cup N_-)$. To show that $X = D \sqcup C$ it is enough to verify that $\mu(N_+) = 0 = \mu(N_-)$.

This is done by noting that these sets admit pairwise disjoint copies using piecewise translations by powers of T . In view of the fact that T is measure-preserving, this implies that N_+ and N_- are null. To be more precise, set $N_-^0 = N_-$ and define inductively $N_-^n = \{T^{k(x)} x : x \in N_-^{n-1}\}$, where $k(x) \geq 1$ is the smallest natural number such that $\pi_{\mathcal{C}}(T^{k(x)} x) = \pi_{\mathcal{C}}(x)$. Note that $k(x)$ is well-defined, for otherwise x would belong to D . Sets N_-^n , $n \in \mathbb{N}$, are pairwise disjoint, and have the same measure since T is measure-preserving. We conclude that $\mu(N_-) = 0$. The argument for $\mu(N_+) = 0$ is similar. \square

PROPOSITION 4.16 (Hopf decomposition). *Let $G \curvearrowright X$ be a free measure-preserving action of a locally compact Polish group on a standard probability space (X, μ) . Let λ be a right Haar measure on G and $(\lambda_x)_{x \in X}$ be the push-forward of λ onto the orbits as described in Section 4.2. For any element $T \in [G \curvearrowright X]$, the measurable T -invariant partition $X = D \sqcup C$ defined above satisfies that for μ -almost all $x \in X$ the partition $[x]_{\mathcal{R}_G} = ([x]_{\mathcal{R}_G} \cap D) \sqcup ([x]_{\mathcal{R}_G} \cap C)$ is the Hopf decomposition for $T \upharpoonright_{[x]_{\mathcal{R}_G}}$ on $([x]_{\mathcal{R}_G}, \lambda_x)$. Moreover, there is only one partition $X = D \sqcup C$ satisfying this property up to null sets.*

PROOF. According to Proposition 4.13, we may assume that for all $x \in X$ the map $T \upharpoonright_{[x]_{\mathcal{R}_G}}: [x]_{\mathcal{R}_G} \rightarrow [x]_{\mathcal{R}_G}$ is a non-singular transformation with respect to λ_x and satisfies $\lambda_x(TA) = \int_A \Delta(\rho_T(y)) d\lambda_x(y)$ for all Borel $A \subseteq X$.

Let $[x]_{\mathcal{R}_G} = D_x \sqcup C_x$, $x \in X$, denote the Hopf's decomposition for $T \upharpoonright_{[x]_{\mathcal{R}_G}}$. For any $c \in \mathcal{C}$, the set

$$\widetilde{W}_c = \{x \in (\mathcal{V}_c)_c : T^k x \notin (\mathcal{V}_c)_c \text{ for all } k \geq 1\}$$

is a wandering set and therefore $\widetilde{W}_c \subseteq D_x$ up to a null set. If $x \in D$ satisfies $x \in (\mathcal{V}_c)_c$, $c \in \mathcal{C}$, then $[x]_{\mathcal{R}_G} \cap (\mathcal{V}_c)_c$ is finite, and therefore $[x]_{\mathcal{R}_G} \cap (\mathcal{V}_c)_c \subseteq \bigcup_{k \in \mathbb{Z}} T^k \widetilde{W}_c$, whence also

$$[x]_{\mathcal{R}_G} \cap D \subseteq \bigcup_{c \in \mathcal{C} \cap [x]_{\mathcal{R}_G}} \bigcup_{k \in \mathbb{Z}} T^k \widetilde{W}_c \subseteq D_x.$$

CLAIM. We have $\lambda_x([x]_{\mathcal{R}_G} \cap C \cap D_x) = 0$ for each $x \in X$.

PROOF OF THE CLAIM. Otherwise we can find $c \in \mathcal{C} \cap [x]_{\mathcal{R}_G}$ and a wandering set $W \subseteq [x]_{\mathcal{R}_G} \cap (\mathcal{V}_c)_c \cap C$ of positive measure, $\lambda_x(W) > 0$. Construct a sequence of sets W_n by setting $W_0 = W$ and

$$W_n = \{T^{k_n(y)} y : y \in W_0 \text{ and } k_n(y) \text{ is minimal such that } \pi_{\mathcal{C}}(T^{k_n(y)}) = \pi_{\mathcal{C}}(y) \text{ and } T^{k_n(y)} y \notin \bigcup_{k < n} W_k\},$$

where the value of $k_n(y)$ is well-defined for each $y \in W_0$ and $n \in \mathbb{N}$, since all points in C return to their Voronoi domain infinitely often. Define a transformation $S_n : W_0 \rightarrow W_n$ as $S_n(y) = T^{k_n(y)} y$, and note that for all $n \in \mathbb{N}$ one has $\rho_{S_n}(y) \in \rho((\mathcal{V}_c)_c, (\mathcal{V}_c)_c)$. The region $\rho((\mathcal{V}_c)_c, (\mathcal{V}_c)_c)$ is precompact, since \mathcal{C} is cocompact, and therefore using continuity of the Haar modulus $\Delta : G \rightarrow \mathbb{R}^{>0}$ one can pick $\epsilon > 0$ such that $\Delta(\rho_{S_n}(y)) > \epsilon$ for all $y \in W_0$ and all $n \in \mathbb{N}$.

Since S_n is composed of powers of T , Proposition 4.13 ensures that

$$\lambda_x(S_n W_0) = \int_{W_0} \Delta(\rho_{S_n}(y)) d\lambda_x(y),$$

whence $\lambda_x(S_n W_0) \geq \epsilon \lambda_x(W_0)$ for each $n \in \mathbb{N}$. We now arrive at a contradiction, as W_n , $n \in \mathbb{N}$, form a pairwise disjoint infinite family of subsets of $(\mathcal{V}_c)_c$ whose measure is uniformly bounded away from zero by $\epsilon \lambda_x(W_0)$, which is impossible, since $\lambda_x((\mathcal{V}_c)_c) < \infty$ by cocompactness of \mathcal{C} . This finishes the proof of the claim.

□_{claim}

We have established by now that $D \cap [x]_{\mathcal{R}_G} \subseteq D_x$ and, up to a null set, $C \cap [x]_{\mathcal{R}_G} \subseteq C_x$ by the claim above. Finally, $\mu(X \setminus (D \sqcup C)) = 0$ implies via Lemma 4.14 $\lambda_x((D \cap [x]_{\mathcal{R}_G}) \sqcup (C \cap [x]_{\mathcal{R}_G})) = 0$ for μ -almost all $x \in X$, and therefore $\lambda_x((D \cap$

$[x]_{\mathcal{R}_G} \triangle D_x) = 0 = \lambda_x((C \cap [x]_{\mathcal{R}_G}) \triangle C_x)$ μ -almost surely. Sets D and C thus satisfy the conclusion of the proposition.

For the uniqueness part of the proposition, suppose D, C and D', C' are two partitions of X such that

$$\lambda_x(D \triangle D_x) = 0 = \lambda_x(D' \triangle D_x) \text{ and } \lambda_x(C \triangle C_x) = 0 = \lambda_x(C' \triangle C_x)$$

for μ -almost all $x \in X$. One therefore also has $\forall^\mu x \in X$ $\lambda_x(D \triangle D') = 0 = \lambda_x(C \triangle C')$, and hence $\mu(D \triangle D') = 0$ by Lemma 4.14. \square

We end this section with a natural definition which will be useful for analyzing elements of the full group.

DEFINITION 4.17. Let $G \curvearrowright X$ be a free measure-preserving action of a locally compact Polish group on a standard probability space (X, μ) , and let $T \in [G \curvearrowright X]$. Consider the T -invariant partition $X = D \sqcup C$ provided by the Hopf decomposition of T as per the previous proposition. We say that T is **dissipative** when $D = X$ and that T is **conservative** when $C = X$.

When G is discrete, observe that T is dissipative if and only if it is aperiodic (all its orbits are infinite), and that T is conservative if and only if it is periodic (all its orbits are finite).

EXAMPLE 4.18. Let us give a general example of dissipative elements of the full group. Let $G \overset{\alpha}{\curvearrowright} X$ be a free measure-preserving action of a locally compact Polish group on a standard probability space (X, μ) . If $g \in G$ generates a discrete infinite subgroup, then the element of the full group $\alpha(g)$ is dissipative. Indeed, the action of $\alpha(g)$ on each orbit is isomorphic to the g -action by left translation on G endowed with its right Haar measure, which is dissipative since it admits a Borel fundamental domain and has only infinite orbits. For instance, if $G = \mathbb{R}$, such a domain is given by the interval $[0, g)$ (or $(g, 0]$, if g is negative).

In Chapter 7, we build an interesting example of a conservative element in the full group of any free measure-preserving flow: its action on each orbit is actually ergodic, and its cocycle is bounded.

4.4. L^1 full groups and L^1 orbit equivalence

We now restrict ourselves to the setup where the acting group G is locally compact Polish and *compactly generated*, endowed with a maximal compatible norm $\|\cdot\|$ (the existence of such a norm for locally compact Polish group is equivalent to being compactly generated, see [Ros21, Cor. 2.8 and Thm. 2.53]). For such a group, as explained in Section 2.3, it makes sense to talk about the associated L^1 full group by endowing the group with a maximal norm.

The following definition is the natural extension of the notion of L^1 orbit equivalence to the locally compact case, stated in terms of full groups.

DEFINITION 4.19. Let α and β be the respective measure-preserving actions of two locally compact Polish compactly generated groups G and H on a standard probability space (X, μ) . We say that α and β are L^1 **orbit equivalent** when there is a measure-preserving transformation $S \in \text{Aut}(X, \mu)$ such that for all $g \in G$ and all $h \in H$,

$$S\alpha(g)S^{-1} \in [H \overset{\beta}{\curvearrowright} X]_1 \text{ and } S^{-1}\beta(h)S \in [G \overset{\alpha}{\curvearrowright} X]_1.$$

In other words, up to conjugating α by S , we have that the image of α is contained in the L^1 full group of β , and the image of β is contained in the L^1 full group of α .

We now show that L^1 full groups do remember actions up to L^1 orbit equivalence as abstract groups. This is done by finding a spacial realization of the isomorphism between the full groups. Such techniques originated in the work of H. Dye [Dye59] and have been greatly generalized by D. H. Fremlin [Fre04, 384D]. We recall that a subgroup G of $\text{Aut}(X, \mu)$ is said to have **many involutions** if for any non-trivial measurable $A \subseteq X$ there exists a non-trivial involution $U \in G$ such that $\text{supp } U \subseteq A$. The group of quasi-measure-preserving transformations of (X, μ) is denoted by $\text{Aut}^*(X, \mu)$.

THEOREM 4.20 (Fremlin). *Let G, H be subgroups of $\text{Aut}(X, \mu)$ with many involutions. For any isomorphism $\psi : G \rightarrow H$ there exists $S \in \text{Aut}^*(X, \mu)$ such that $\psi(T) = STS^{-1}$ for all $T \in G$.*

PROPOSITION 4.21. *If two ergodic measure-preserving actions of locally compact compactly generated Polish groups have isomorphic L^1 full groups, then they are also L^1 orbit equivalent.*

PROOF. Denote by $G \overset{\alpha}{\curvearrowright}$ and $H \overset{\beta}{\curvearrowright}$ the two actions on the same standard probability space (X, μ) . Since the L^1 full groups of ergodic actions have many involutions (see, for example, Lemma 3.6), any isomorphism $\psi : [G \overset{\alpha}{\curvearrowright} X]_1 \rightarrow [H \overset{\beta}{\curvearrowright} X]_1$ admits a spatial realization by some $S \in \text{Aut}^*(X, \mu)$. The Radon–Nikodym derivative of $S_*\mu$ with respect to μ is easily seen to be preserved by every element of $[H \overset{\beta}{\curvearrowright} X]_1$, and hence must be constant by ergodicity. We conclude that $S \in \text{Aut}(X, \mu)$, and therefore by the definition the actions α and β are L^1 orbit equivalent. \square

REMARK 4.22. Similarly to the finitely generated case [LM21, Sec. 8.1], one could define L^1 full orbit equivalence between actions as equality of L^1 full groups up to conjugacy, which is a strengthening of L^1 orbit equivalence (indeed the latter only requires inclusion of each acting group in the L^1 full group of the other acting group). It would be interesting to have examples of actions which are L^1 orbit equivalent, but not L^1 fully orbit equivalent.

We end this section by showing that L^1 orbit equivalence is equivalent to a stronger definition where we ask that, up to conjugating α by S , we moreover have that, on a full measure set $X_0 \subseteq X$, the α and β orbits coincide. This will be a direct consequence of the following proposition. The proof of this proposition is the same as that of [CLM16, Prop. 3.8] which was not stated in the level of generality we need. Since it is short, we reproduce it here.

PROPOSITION 4.23. *Let G and H be two locally compact Polish groups acting in a Borel measure-preserving manner on a standard probability space (X, μ) , denote by α the G -action and suppose that $\alpha(G) \leq [H \curvearrowright X]$. Then there is a full measure Borel subset $X_0 \subseteq X$ such that*

$$\mathcal{R}_G \cap (X_0 \times X_0) \subseteq \mathcal{R}_H.$$

PROOF. Let λ be the Haar measure on G . Since $\alpha(G) \leq [H \curvearrowright X]$, for all $g \in G$ and almost all $x \in X$, we have $gx \in Hx$. By Fubini's theorem, this implies

that the Borel set

$$X_0 = \{x \in X : \text{for } \lambda\text{-almost all } g \in G, \text{ we have } gx \in Hx\}$$

has full measure. Now let $x \in X_0$, and let $g_1 \in G$ be such that $g_1x \in X_0$. We want to show that $g_1x \in Hx$.

Since x and g_1x are in X_0 , the sets

$$A = \{g \in G : gx \in Hx\} \quad \text{and} \quad B = \{g \in G : gx \in Hg_1x\}$$

have full measure and so $A \cap B$ has full measure. Take $g \in A \cap B$, and note that $gx \in Hx \cap Hg_1x$, so the two orbits Hx and Hg_1x intersect, hence $g_1x \in Hx$. \square

COROLLARY 4.24. *Two measure-preserving actions of locally compact compactly generated Polish groups G and H on a standard probability space (X, μ) are L^1 orbit equivalent if and only if they can be conjugated so as to share the same orbits on a full measure Borel subset $X_0 \subseteq X$, and for all $g \in G$ and $h \in H$ there are Borel maps*

$$\rho_G(g, \cdot) : X_0 \rightarrow H \quad \text{and} \quad \rho_H(h, \cdot) : X_0 \rightarrow G$$

such that for all $x \in X_0$,

$$g \cdot x = \rho_G(g, x) \cdot x \quad \text{and} \quad h \cdot x = \rho_H(h, x) \cdot x,$$

and finally, if we denote by $\|\cdot\|_G$ and $\|\cdot\|_H$ maximal norms on G and H respectively, then

$$\int_X \|\rho_G(g, x)\|_H d\mu(x) < +\infty \quad \text{and} \quad \int_X \|\rho_H(h, x)\|_G d\mu(x) < +\infty.$$

REMARK 4.25. Note that both ρ_G and ρ_H are actually Borel globally (as maps $\rho_G : G \times X_0 \rightarrow H$ and $\rho_H : H \times X_0 \rightarrow G$) as a consequence of the Arsenin selection theorem for Borel sets with K_σ sections and the fact that point stabilizers are closed, a result of D. Miller.

PROOF OF COROLLARY 4.24. It is clear from the definition of L^1 full groups that the conditions in the corollary are sufficient for L^1 orbit equivalence. Observe that up to conjugating the two actions, they do share the same full group. Since L^1 full groups contain the acting groups, we can apply Proposition 4.23 twice and get the desired full measure Borel subset X_0 restricted to which orbits coincide. The remaining statements are then direct consequences of the definition of L^1 full groups. \square

We will see in the final chapter that there are free ergodic \mathbb{R} -flows which are not L^1 orbit equivalent. This will be done by relating L^1 orbit equivalence to flip-Kakutani equivalence. In the discrete amenable case, an important result of Austin shows that entropy is preserved by L^1 orbit equivalence [Aus16]. We wonder what happens in the general locally compact setup.

QUESTION 4.26. *Let G be an amenable non-discrete non-compact compactly generated locally compact Polish group. Are there two measure-preserving ergodic actions of G which are not L^1 orbit equivalent?*

Derived L^1 full groups for locally compact amenable groups

Given a measure-preserving action of a normed Polish group $(G, \|\cdot\|)$ on (X, μ) , the **derived L^1 full group** $D([G \curvearrowright X]_1)$ of the action is by definition the closure in $[G \curvearrowright X]_1$ of the group generated by commutators, i.e., elements of the form $TUT^{-1}U^{-1}$, where $T, U \in [G \curvearrowright X]_1$. Provided the G -action is aperiodic, the latter can be described in three different ways using the fact that $[G \curvearrowright X]_1$ is *induction friendly*, as explained in the Section 3.2 (see Corollary 3.15):

- $D([G \curvearrowright X]_1)$ is the closure of the group generated by involutions;
- $D([G \curvearrowright X]_1)$ is the closure of the group generated by 3-cycles;
- $D([G \curvearrowright X]_1)$ is the closure of the group generated by periodic elements.

In particular, all periodic elements of $[G \curvearrowright X]_1$ actually belong to $D([G \curvearrowright X]_1)$.

Compared to the previous chapter, we impose one further restriction on the acting group, and consider actions of a locally compact *amenable* Polish normed group $(G, \|\cdot\|)$. Appendix G of [BdlHV08] contains an excellent review of amenability for locally compact Polish groups. As before, we fix a measure-preserving action $G \curvearrowright X$ on a standard probability space (X, μ) , and let $D : \mathcal{R}_G \rightarrow \mathbb{R}^{\geq 0}$ denote the family of metrics induced onto the orbits by the norm.

In Section 5.1, we will first exhibit a dense increasing chain of subgroups in $D([G \curvearrowright X]_1)$. This dense chain is used in the two remaining sections. In Section 5.2, we show that amenability of the group is reflected in *whirly amenability* of $D([G \curvearrowright X]_1)$, while in Section 5.3 we prove by a Baire category argument that $D([G \curvearrowright X]_1)$ has a dense 2-generated subgroup.

5.1. Dense chain of subgroups

An equivalence relation $\mathcal{R} \subseteq \mathcal{R}_G$ is said to be **uniformly bounded** if there is $M > 0$ and $X' \subseteq X$ such that $\mu(X \setminus X') = 0$ and $\sup_{(x_1, x_2) \in \mathcal{R}'} D(x_1, x_2) \leq M$, where $\mathcal{R}' = \mathcal{R} \cap X' \times X'$.

LEMMA 5.1. *Let $(G, \|\cdot\|)$ be a locally compact amenable Polish normed group acting on a standard probability space (X, μ) . There exists a sequence of cross-sections \mathcal{C}_n , $n \in \mathbb{N}$, and tessellations \mathcal{W}_n over \mathcal{C}_n such that for all $n \in \mathbb{N}$*

- (1) $\mathcal{R}_{\mathcal{W}_n} \subseteq \mathcal{R}_{\mathcal{W}_{n+1}}$ and $\bigcup_{k \in \mathbb{N}} \mathcal{R}_{\mathcal{W}_k} = \mathcal{R}_G$ (up to a null set);
- (2) $\mathcal{R}_{\mathcal{W}_n}$ is uniformly bounded.

PROOF. Let \mathcal{C} be a cocompact cross-section, $\mathcal{V}_{\mathcal{C}}$ be the Voronoi tessellation over \mathcal{C} , $\pi_{\mathcal{V}_{\mathcal{C}}} : X \rightarrow \mathcal{C}$ be the associated reduction, and $\nu = (\pi_{\mathcal{V}_{\mathcal{C}}})_* \mu$ be the push-forward measure on \mathcal{C} . Recall that $\mathcal{R}_{\mathcal{V}_{\mathcal{C}}}$ is uniformly bounded, since \mathcal{C} is cocompact. Let E be the equivalence relation obtained by restricting \mathcal{R}_G onto \mathcal{C} . By a theorem of A. Connes, J. Feldman, and B. Weiss [CFW81], E is hyperfinite on an invariant

set of ν -full measure. Throwing away a G -invariant null set, we may write $E = \bigcup_n E_n$, where $(E_n)_{n \in \mathbb{N}}$ is an increasing sequence of Borel equivalence relations with finite classes. For $m, n \in \mathbb{N}$, define $A_{n,m}$ to be the set of points in the cross-section whose E_n -class is bounded in diameter by m :

$$A_{n,m} = \{c \in \mathcal{C} : D(c_1, c_2) \leq m \text{ for all } c_1, c_2 \in \mathcal{C} \text{ such that } c_1 E_n c \text{ and } c_2 E_n c\}.$$

Note that the sets $A_{n,m}$ are E_n -invariant, nested, and $\bigcup_m A_{n,m} = \mathcal{C}$ for every $n \in \mathbb{N}$. Pick m_n so large as to ensure $\nu(\mathcal{C} \setminus A_{n,m_n}) < 2^{-n}$ and let $B_n = \bigcap_{k \geq n} A_{k,m_k}$. The sets B_n are E_n -invariant, increasing, and $\lim_n \nu(B_n) = \nu(\mathcal{C})$. Define equivalence relations F_n on \mathcal{C} by setting $c_1 F_n c_2$ whenever $c_1 = c_2$ or $c_1, c_2 \in B_n$ and $c_1 E_n c_2$. Note that $D(c_1, c_2) \leq m_n$ whenever $c_1 F_n c_2$. Let $\mathcal{C}_n \subseteq \mathcal{C}$ be a Borel transversal for F_n and define $\mathcal{W}_n = \{(c, x) \in \mathcal{C}_n \times X : c F_n \pi_{\mathcal{C}}(x)\}$. It is straightforward to check that each \mathcal{W}_n is a tessellation over \mathcal{C}_n , and equivalence relations $\mathcal{R}_{\mathcal{W}_n}$ satisfy the conclusions of the lemma. \square

The equivalence relations $\mathcal{R}_{\mathcal{W}_n}$ produced by Lemma 5.1 give rise to a nested chain of groups $[\mathcal{R}_{\mathcal{W}_0}] \leq [\mathcal{R}_{\mathcal{W}_1}] \leq \dots$. Some basic facts about such groups can be found in Appendix C.2. The following lemma establishes that such a chain is dense in the *derived* L^1 full group.

LEMMA 5.2. *Let $(G, \|\cdot\|)$ be a locally compact amenable Polish normed group acting on a standard probability space (X, μ) and let $(\mathcal{R}_n)_{n \in \mathbb{N}}$ be a sequence of equivalence relations as in Lemma 5.1. If the action is aperiodic, then the union $\bigcup_n [\mathcal{R}_n]$ is contained in the derived L^1 full group $D([G \curvearrowright X]_1)$ and is dense therein.*

PROOF. By definition, $[\mathcal{R}_n]$ is a subgroup of $[\mathcal{R}_G]$. Since equivalence relations \mathcal{R}_n are uniformly bounded, we actually have $[\mathcal{R}_n] \leq [G \curvearrowright X]_1$, and the topology induced by the L^1 metric on $[\mathcal{R}_n]$ coincides with the topology induced from $[\mathcal{R}_G]$. Moreover, in view of Proposition C.7, $[\mathcal{R}_n]$ is topologically generated by periodic transformations, so we actually have $[\mathcal{R}_n] \leq D([G \curvearrowright X]_1)$ as a consequence of Lemma 3.10 and Corollary 3.15.

It remains to verify that the union $\bigcup_n [\mathcal{R}_n]$ is dense in $D([G \curvearrowright X]_1)$. To this end, recall that by Corollary 3.15 the derived L^1 full group $D([G \curvearrowright X]_1)$ is topologically generated by involutions. So let $U \in D([G \curvearrowright X]_1)$ be an involution and set $X_n = \{x \in X : (x, U(x)) \in \mathcal{R}_n\}$, $n \in \mathbb{N}$. Note that X_n is U -invariant since U is an involution. Moreover, $\mu(X_n) \rightarrow 1$ as $\bigcup_n \mathcal{R}_n = \mathcal{R}_G$, and thus the induced transformations $U_{X_n} \in [\mathcal{R}_n]$ converge to U in the topology of $[G \curvearrowright X]_1$. We conclude that $\bigcup_n [\mathcal{R}_n]$ is dense in the derived L^1 full group. \square

COROLLARY 5.3. *Let $(G, \|\cdot\|)$ be a locally compact amenable Polish normed group acting on a standard probability space (X, μ) . Suppose that almost every orbit of the action is uncountable. There exists a chain $H_0 \leq H_1 \leq \dots \leq D([G \curvearrowright X]_1)$ of closed subgroups such that $\bigcup_n H_n$ is dense in $D([G \curvearrowright X]_1)$, and each H_n is isomorphic to $L^0(Y_n, \nu_n, \text{Aut}([0, 1], \lambda))$ for some standard Lebesgue space (Y_n, ν_n) . If moreover each orbit of the action has measure zero, then one can assume that all (Y_n, ν_n) are atomless and each H_n is isomorphic to $L^0([0, 1], \lambda, \text{Aut}([0, 1], \lambda))$.*

PROOF. Apply Lemmas 5.1 and 5.2 to get a dense chain of subgroups $[\mathcal{R}_0] \leq [\mathcal{R}_1] \leq \dots \leq D([G \curvearrowright X]_1)$ and use Corollary C.14 to deduce that each $[\mathcal{R}_n]$ has the desired form. \square

COROLLARY 5.4. *Let $(G, \|\cdot\|)$ be a locally compact amenable Polish normed group acting on a standard probability space (X, μ) . If the action is aperiodic, then the set of periodic elements is dense in the derived L^1 full group $D([G \curvearrowright X]_1)$.*

PROOF. Consider a chain of subgroups $[\mathcal{R}_n]$ given by Lemma 5.2. Periodic elements are dense in these groups for their natural topology (see Proposition C.7 and the discussion preceding it). These topologies are compatible with the standard Borel structure of $\text{Aut}(X, \mu)$ induced by the weak topology and therefore must refine the L^1 topology by the standard automatic continuity arguments [BK96, Sec. 1.6]. Hence periodic elements are dense in all of $D([G \curvearrowright X]_1)$, as claimed. \square

Corollary 5.4 together with Proposition 3.24 show that the L^1 norm is maximal on derived L^1 full groups of aperiodic measure-preserving actions of locally compact amenable Polish normed groups (see Section 2.3 for a short reminder on maximality of norms). In particular, such groups are boundedly generated by [Ros22, Thm. 2.53].

THEOREM 5.5. *Let $(G, \|\cdot\|)$ be a locally compact amenable Polish normed group acting on a standard probability space (X, μ) . If the action is aperiodic, then the L^1 norm is maximal on the derived L^1 full group $D([G \curvearrowright X]_1)$.*

We do not know if the amenability hypothesis can be removed, even when G is discrete and the action is free.

5.2. Whirly amenability

Lemma 5.2 is a powerful tool to deduce various dynamical properties of derived L^1 full groups. Recall that a Polish group G is said to be **whirly amenable** if it is amenable and for any continuous action of G on a compact space any invariant measure is supported on the set of fixed points of the action. In particular, each such action has to have some fixed points, so whirly amenable groups are extremely amenable.

PROPOSITION 5.6. *Let \mathcal{R} be a smooth measurable equivalence relation on a standard Lebesgue space (X, μ) . If μ is atomless, then the full group $[\mathcal{R}]$ is whirly amenable.*

PROOF. In view of Proposition C.6, the full group $[\mathcal{R}]$ is isomorphic to

$$L^0([0, 1], \lambda, \text{Aut}([0, 1], \lambda))^{\epsilon_0} \times \text{Aut}([0, 1], \lambda)^{\kappa_0} \times \prod_{n \geq 1} L^0([0, 1], \lambda, \mathfrak{S}_n)^{\epsilon_n},$$

where \mathfrak{S}_n is the group of permutations of an n -element set, and $\epsilon_n \in \{0, 1\}$, $\kappa_0 \leq \aleph_0$. Since a product of whirly amenable groups is whirly amenable, it suffices to show that the groups appearing in the decomposition above, namely $L^0([0, 1], \lambda, \text{Aut}([0, 1], \lambda))$, $\text{Aut}([0, 1], \lambda)$, and $L^0([0, 1], \lambda, \mathfrak{S}_n)$, $n \geq 1$, are whirly amenable.

The group $\text{Aut}([0, 1], \lambda)$ is whirly amenable by [GP02] (it is, in fact, a so-called Levy group). Finally, we apply a theorem of V. Pestov and F. M. Schneider [PS17], which asserts that a group $L^0([0, 1], \lambda, G)$ is whirly amenable if and only if G is amenable. This readily implies whirly amenability of $L^0([0, 1], \lambda, \mathfrak{S}_n)$ and $L^0([0, 1], \lambda, \text{Aut}([0, 1], \lambda))$. \square

REMARK 5.7. The assumption of μ being atomless cannot be omitted in the proposition above. Indeed, $[\mathcal{R}]$ will factor onto \mathfrak{S}_n for some $n \geq 2$, as long as an \mathcal{R} -class contains at least 2 atoms of μ of the same measure. However, if all μ -atoms within each \mathcal{R} -class have distinct measures, then the restriction of $[\mathcal{R}]$ onto the atomic part of X is trivial, which suffices to conclude the whirly amenability of the group $[\mathcal{R}]$.

THEOREM 5.8. *Let $G \curvearrowright X$ be a measure-preserving action of an amenable locally compact Polish normed group on a standard probability space (X, μ) . If the action is aperiodic, then the derived L^1 full group $D([G \curvearrowright X]_1)$ is whirly amenable. In particular, $[G \curvearrowright X]_1$ is amenable.*

PROOF. Lemma 5.2 shows that $D([G \curvearrowright X]_1)$ has an increasing dense chain of subgroups H_n of the form $[\mathcal{R}_n]$, where \mathcal{R}_n are smooth measurable equivalence relations on X . Proposition 5.6 applies and shows that groups H_n are whirly amenable. The latter is sufficient to conclude whirly amenability of $D([G \curvearrowright X]_1)$, as any invariant measure for the action of the derived group is also invariant for the induced H_n actions, hence it has to be supported on the intersection of fixed points of all H_n , which coincides with the set of fixed points for the action of $D([G \curvearrowright X]_1)$.

The fact that $[G \curvearrowright X]_1$ is amenable now follows from the fact that every abelian group is amenable, and every amenable extension of an amenable group must itself be amenable (for instance, see [BdlHV08, Prop. G.2.2]). \square

REMARK 5.9. Note that in general $[G \curvearrowright X]_1$ is not extremely amenable. For flows, it factors onto \mathbb{R} via the index map (see Chapter 6) and \mathbb{R} admits continuous actions on compact spaces without fixed points, so $[\mathbb{R} \curvearrowright X]_1$ is not extremely amenable (and in particular, it is not whirly amenable) for any free measure-preserving flow.

COROLLARY 5.10. *Let $G \curvearrowright X$ be a free measure-preserving action of a unimodular locally compact Polish group on a standard probability space (X, μ) . The following are equivalent:*

- (1) G is amenable.
- (2) $[G \curvearrowright X]_1$ is amenable.
- (3) The derived L^1 full group $D([G \curvearrowright X]_1)$ is amenable.
- (4) The derived L^1 full group $D([G \curvearrowright X]_1)$ is extremely amenable.
- (5) The derived L^1 full group $D([G \curvearrowright X]_1)$ is whirly amenable.

PROOF. We established the implication (1) \implies (5) in Theorem 5.8. The chain of implications (5) \implies (4) \implies (3) is straightforward, and (3) \implies (2) follows from the stability of amenability under group extensions, which was already discussed in Theorem 5.8.

For the last implication (2) \implies (1), first recall that the orbit full group of the action is generated by involutions. It follows that the orbit full group is topologically generated by involutions whose cocycles are integrable (actually, one can even ask that the cocycles are bounded). In particular, the L^1 full group $[G \curvearrowright X]_1$ is dense in the orbit full group, and so assuming (2) we conclude that the orbit full group $[G \curvearrowright X]$ is amenable. The amenability of G then follows from [CLM18, Thm. 5.1]. \square

REMARK 5.11. We have to require unimodularity in order to be able to apply [CLM18, Thm. 5.1]. It seems likely that the unimodularity hypothesis can be dropped in this result, but we do not pursue this question further.

5.3. Topological generators

We now concern ourselves with the question of determining the topological rank of derived L^1 full groups. Our approach will be based on the dense chain of subgroups established in Corollary 5.3, and the first step is to study the topological rank of the group $L^0([0, 1], \text{Aut}([0, 1]))$.

Let (Y, ν) and (Z, λ) be standard Lebesgue spaces. Consider the product space $Y \times Z$ equipped with the product measure $\nu \times \lambda$ and let \mathcal{R} be the product of the discrete equivalence relation on Y and the anti-discrete on Z ; in other words, $(y_1, z_1)\mathcal{R}(y_2, z_2)$ if and only if $y_1 = y_2$. As discussed in Appendix C.1, the following two groups are one and the same:

- (1) the full group $[\mathcal{R}]$;
- (2) the topological group $L^0(Y, \nu, \text{Aut}(Z, \lambda))$.

Suppose that (Z, λ) is atomless. Pick a hyperfinite ergodic equivalence relation E on Z so that $\text{APER}(Z) \cap [E]$ is dense in $\text{Aut}(Z, \lambda)$, where $\text{APER}(Z)$ stands for the collection of aperiodic automorphisms of Z . Set $\mathcal{R}_0 = \text{id}_Y \times E$ to be the equivalence relation on $Y \times Z$ given by $(y_1, z_1)\mathcal{R}_0(y_2, z_2)$ whenever $y_1 = y_2$ and $z_1 E z_2$. A standard application of the Jankov-von Neumann uniformization theorem yields the following lemma.

LEMMA 5.12. *$\text{APER}(Y \times Z) \cap [\mathcal{R}_0]$ is dense in $[\mathcal{R}] \simeq L^0(Y, \nu, \text{Aut}([0, 1], \lambda))$.*

Our first goal is to establish that the topological rank of $[\mathcal{R}]$ is 2. We do so by first verifying this under the assumption that (Y, ν) is atomless, and then deducing the general case.

We say that a topological group G is **generically k -generated**, $k \in \mathbb{N}$, if the set of k -tuples $(g_1, \dots, g_k) \in G^k$ that generate a dense subgroup of G is dense in G^k . Note that the set of such tuples is always a G_δ set, so if G is generically k -generated, then a comeager set of k -tuples generates a dense subgroup of G .

PROPOSITION 5.13. *Suppose that (Y, ν) is atomless. The group $[\mathcal{R}]$ is generically 2-generated.*

PROOF. By [LM16, Thm 5.1], the set of pairs

$$(S, T) \in (\text{APER}(Y \times Z) \cap [\mathcal{R}_0]) \times [\mathcal{R}_0]$$

such that $\overline{\langle S, T \rangle} = [\mathcal{R}_0]$ is dense G_δ for the uniform topology. In view of Lemma 5.12, this implies that $[\mathcal{R}]$ is generically 2-generated. \square

LEMMA 5.14. *For all topological groups G and H one has*

$$\text{rk}(G \times H) \geq \max\{\text{rk}(G), \text{rk}(H)\}.$$

If $G \times H$ is generically k -generated, then so are G and H as well.

PROOF. The inequality on ranks is immediate from the trivial observation that if $\langle (g_1, h_1), \dots, (g_k, h_k) \rangle$ is dense in $G \times H$, then $\langle g_1, \dots, g_k \rangle$ is dense in G and $\langle h_1, \dots, h_k \rangle$ is dense in H .

Suppose $G \times H$ is generically k -generated, pick an open set $U \subseteq G^k$ and note that $U \times H^k$ naturally corresponds to an open subset of $(G \times H)^k$ via the isomorphism $(G \times H)^k \simeq G^k \times H^k$. Since $G \times H$ is generically k -generated, there is a tuple $(g_i, h_i)_{i=1}^k \in (G \times H)^k$ that generates a dense subgroup and $(g_i, h_i)_{i=1}^k \in U \times H^k$. We conclude that $(g_i)_{i=1}^k \in U$ generates a dense subgroup of G and the lemma follows. \square

LEMMA 5.15. *For any separable topological group G*

$$\text{rk}(L^0([0, 1], \lambda, G)) = \text{rk}(L^0([0, 1], \lambda, G) \times G^{\mathbb{N}}).$$

If $L^0([0, 1], \lambda, G)$ is generically k -generated for some $k \in \mathbb{N}$, then so is the group $L^0([0, 1], \lambda, G) \times G^{\mathbb{N}}$.

PROOF. In view of Lemma 5.14, $\text{rk}(L^0([0, 1], \lambda, G)) \leq \text{rk}(L^0([0, 1], \lambda, G) \times G^{\mathbb{N}})$, and, since the group G is separable, we only need to consider the case when the rank $\text{rk}(L^0([0, 1], \lambda, G))$ is finite.

It is notationally convenient to shrink the interval and work with the group $L^0([0, 1/2], \lambda, G) \times G^{\mathbb{N}}$ instead as it can naturally be viewed as a closed subgroup of $L^0([0, 1], \lambda, G)$ via the identification $f \times (g_i)_{i \in \mathbb{N}} \mapsto \zeta$, where

$$\zeta(t) = \begin{cases} f(t) & \text{if } 0 \leq t < 1/2, \\ g_i & \text{if } 1 - 2^{-i-1} \leq t < 1 - 2^{-i-2} \text{ for } i \in \mathbb{N}. \end{cases}$$

Pick families $(\xi_l)_{l \in \mathbb{N}}$ dense in $L^0([0, 1/2], \lambda, G)$, and $(h_m)_{m \in \mathbb{N}}$ dense in G .

Let us call a function $\alpha : \mathbb{N} \rightarrow \mathbb{N}$ a multi-index if $\alpha(i) = 0$ for all but finitely many $i \in \mathbb{N}$. We use $\mathbb{N}^{<\mathbb{N}}$ to denote the set of all multi-indices. Given $\alpha \in \mathbb{N}^{<\mathbb{N}}$, let $h_\alpha = (h_{\alpha(i)})_{i \in \mathbb{N}}$ be an element of $G^{\mathbb{N}}$. Note that $\{h_\alpha : \alpha \in \mathbb{N}^{<\mathbb{N}}\}$ is dense in $G^{\mathbb{N}}$ and thus $\{\xi_l \times h_\alpha : l \in \mathbb{N}, \alpha \in \mathbb{N}^{<\mathbb{N}}\}$ is a dense family in $L^0([0, 1/2], \lambda, G) \times G^{\mathbb{N}}$.

Pick a tuple $f_1, \dots, f_k \in L^0([0, 1], \lambda, G)$ that generates a dense subgroup. For each pair $(l, \alpha) \in \mathbb{N} \times \mathbb{N}^{<\mathbb{N}}$, there exists a sequence of reduced words $(w_n^{l, \alpha})_{n \in \mathbb{N}}$ in the free group on k generators such that $w_n^{l, \alpha}(f_1, \dots, f_k)$ converges to $\xi_l \times h_\alpha$ in measure. By passing to a subsequence, we may assume that $w_n^{l, \alpha}(f_1, \dots, f_k) \rightarrow \xi_l \times h_\alpha$ pointwise almost surely. In other words, the set

$$P_{l, \alpha} = \{t \in [0, 1] : w_n^{l, \alpha}(f_1, \dots, f_k)(t) \rightarrow (\xi_l \times h_\alpha)(t)\}$$

has Lebesgue measure 1 for each $(l, \alpha) \in \mathbb{N} \times \mathbb{N}^{<\mathbb{N}}$, and hence so does the set

$$P = \bigcap_{l \in \mathbb{N}} \bigcap_{\alpha \in \mathbb{N}^{<\mathbb{N}}} P_{l, \alpha}.$$

Pick some $t_j \in P \cap [1 - 2^{-j-1}, 1 - 2^{-j-2})$, $j \in \mathbb{N}$, and set

$$\tilde{f}_i(t) = \begin{cases} f_i(t) & \text{for } 0 \leq t < 1/2, \\ f_i(t_j) & \text{for } 1 - 2^{-j-1} \leq t < 1 - 2^{-j-2} \text{ for } j \in \mathbb{N}. \end{cases}$$

Elements \tilde{f}_i naturally belong to $L^0([0, 1/2], \lambda, G) \times G^{\mathbb{N}}$, and we claim that they generate a dense subgroup therein, witnessing $\text{rk}(L^0([0, 1/2], \lambda, G) \times G^{\mathbb{N}}) \leq k$. To this end recall that $w_n^{l, \alpha}(f_1, \dots, f_k) \rightarrow \xi_l \times h_\alpha$ pointwise almost surely. In particular,

$$w_n^{l, \alpha}(f_1, \dots, f_k) \upharpoonright_{[0, 1/2]} \rightarrow \xi_l \times h_\alpha \upharpoonright_{[0, 1/2]}$$

in measure and, for each $j \in \mathbb{N}$,

$$w_n^{l, \alpha}(f_1, \dots, f_k)(t_j) \rightarrow (\xi_l \times h_\alpha)(t_j) = h_{\alpha(j)}$$

is guaranteed by choosing $t_j \in P$. We conclude that

$$w_n^{l,\alpha}(\tilde{f}_1, \dots, \tilde{f}_k) \rightarrow \xi_l \times h_\alpha$$

in $L^0([0, 1/2], \lambda, G) \times G^{\mathbb{N}}$, and therefore

$$\text{rk}(L^0([0, 1/2], \lambda, G) \times G^{\mathbb{N}}) \leq k.$$

Finally, suppose that $L^0([0, 1], \lambda, G)$ is generically k -generated. Choose open sets $U_i \subseteq L^0([0, 1/2], \lambda, G) \times G^{\mathbb{N}}$, $1 \leq i \leq k$. Shrinking them if necessary, we may assume that all U_i have the form $U_i = A_0^i \times A_1^i \times \dots \times A_n^i \times G^{\mathbb{N}}$, where A_0^i is open in $L^0([0, 1/2], \lambda, G)$, and A_j^i , $j \geq 1$, are open in G .

Pick $V_i \subseteq L^0([0, 1], \lambda, G)$, $1 \leq i \leq k$, to consist of those functions f satisfying $f|_{[0, 1/2]} \in A_0^i$ and $f(t) \in A_j^i$ for all $t \in [1 - 2^{-j-1}, 1 - 2^{-j-2}]$, $1 \leq j \leq n$. Note that $V_i \cap L^0([0, 1/2], \lambda, G) \times G^{\mathbb{N}} = U_i$.

Since $L^0([0, 1], \lambda, G)$ is assumed to be generically k -generated, there is a tuple (f_1, \dots, f_k) generating a dense subgroup in $L^0([0, 1], \lambda, G)$ such that $f_i \in V_i$ for each i . Running the above construction, we get a tuple $(\tilde{f}_1, \dots, \tilde{f}_k) \in L^0([0, 1/2], \lambda, G) \times G^{\mathbb{N}}$ such that $\tilde{f}_i \in U_i$, $1 \leq i \leq k$, whence $L^0([0, 1/2], \lambda, G) \times G^{\mathbb{N}}$ is generically k -generated. \square

Lemma 5.15 remains valid if we take the product with a finite power of G , which follows from Lemma 5.14.

COROLLARY 5.16. *For any separable topological group G and any $m \in \mathbb{N}$ one has*

$$\text{rk}(L^0([0, 1], \lambda, G)) = \text{rk}(L^0([0, 1], \lambda, G)) \times G^m.$$

If $\text{rk}(L^0([0, 1], \lambda, G))$ is generically k -generated for some $k \in \mathbb{N}$, then so is the group $L^0([0, 1], \lambda, G) \times G^m$.

We may now strengthen Proposition 5.13 by dropping the assumption on (Y, ν) being atomless.

PROPOSITION 5.17. *Let (Y, ν) be a standard Lebesgue space and (Z, λ) be a standard probability space. The topological group $L^0(Y, \nu, \text{Aut}(Z, \lambda))$ is generically 2-generated.*

PROOF. Let Y_a be the set of atoms of Y , put $Y_0 = Y \setminus Y_a$ and $\nu_0 = \nu \upharpoonright_{Y_0}$. The group $L^0(Y, \nu, \text{Aut}(Z, \lambda))$ is naturally isomorphic to

$$L^0(Y_0, \nu_0, \text{Aut}(Z, \lambda)) \times \text{Aut}(Z, \lambda)^{|Y_a|}.$$

An application of Proposition 5.13 together with Lemma 5.15 or Corollary 5.16 (depending on whether Y_a is infinite or not) finishes the proof. \square

PROPOSITION 5.18. *Let G be a Polish group and let $H_0 \leq H_1 \leq \dots \leq G$ be a dense chain of Polish subgroups, $\bigcup_n H_n = G$. If each H_n is generically k -generated, then G is generically k -generated.*

PROOF. We need to show that for any open $U \subseteq G^k$ and any open $V \subseteq G$ there is a tuple $(g_1, \dots, g_k) \in U$ such that $\langle g_1, \dots, g_k \rangle \cap V \neq \emptyset$. Since groups H_n are nested and $\bigcup_n H_n$ is dense in G , there is n so large that $U \cap H_n^k \neq \emptyset$ and $V \cap H_n \neq \emptyset$. It remains to use the fact that H_n is generically k -generated to find the required tuple. \square

THEOREM 5.19. *Let $G \curvearrowright X$ be a measure-preserving action of a locally compact amenable Polish normed group on a standard probability space (X, μ) . If almost every orbit of the action is uncountable, then the derived L^1 full group $D([G \curvearrowright X]_1)$ is generically 2-generated.*

PROOF. In view of Corollary 5.3, there is a chain of subgroups

$$H_0 \leq H_1 \leq \cdots \leq D([G \curvearrowright X]_1), \quad \overline{\bigcup_n H_n} = D([G \curvearrowright X]_1),$$

where each H_n is isomorphic to $L^0(Y_n, \nu_n, \text{Aut}([0, 1], \lambda))$ for some standard Lebesgue space (Y_n, ν_n) . By Proposition 5.17, every H_n is generically 2-generated and we may apply Proposition 5.18. \square

COROLLARY 5.20. *Let $G \curvearrowright X$ be a measure-preserving action of a locally compact amenable Polish normed group on a standard probability space (X, μ) . If almost every orbit of the action is uncountable, then the derived L^1 full group $D([G \curvearrowright X]_1)$ has topological rank 2.*

PROOF. Theorem 5.19 implies that the topological rank is at most two. To see that it is actually equal to 2, simply note that $D([G \curvearrowright X]_1)$ is not abelian (e.g. by the proof of Proposition 3.8). \square

The assumption for orbits to be uncountable is essential, and Corollary 5.20 is in a striking difference with the dynamical interpretation of the topological rank of derived L^1 full groups for actions of discrete groups. As shown in [LM21, Thm. 4.3], given an aperiodic measure-preserving action of a finitely generated group $\Gamma \curvearrowright X$, the topological rank of $D([\Gamma \curvearrowright X]_1)$ is finite if and only if the action has finite Rokhlin entropy.

The index map for L^1 full groups of flows

We now turn our attention to **flows**, i.e., measure-preserving actions of \mathbb{R} . Since the group of reals is locally compact, amenable, unimodular, and, of course, Polish, all of the results in the previous chapters apply to \mathbb{R} -flows. A much more in-depth understanding of L^1 full groups of flows is possible and is based on the existence of the so-called *index map*, which we define and investigate in this chapter. This map is a continuous homomorphism from the L^1 full group of the flow to the additive group of reals, which can be thought of measuring the average shift distance. When the flow is ergodic, such averages are the same across orbits. By taking the ergodic decomposition of the flow \mathcal{F} , we can adopt a slightly more general vantage point and view the index map \mathcal{I} as a homomorphism into the L^1 space of functions on the space of invariant measures (\mathcal{E}, p) , $\mathcal{I} : [\mathcal{F}]_1 \rightarrow L^1(\mathcal{E}, p)$.

Understanding the kernel of the index map is the task of fundamental importance. We will subsequently identify $\ker \mathcal{I}$ with the derived topological subgroup of $[\mathcal{F}]_1$ (Theorem 10.1). This will allow us to describe abelianizations of L^1 full groups of flows and estimate the number of their topological generators.

It has already been mentioned that any element T of a full group of a flow induces Lebesgue measure-preserving transformations on orbits (Section 4.2). When T furthermore belongs to the L^1 full group, these transformations are special—they leave “half-lines” invariant up to a set of finite measure. Such transformations form the so-called **commensurating group**. Let us therefore begin with a more formal treatment of this group, which has already appeared in the literature before, for instance in [RS98].

6.1. Self commensurating automorphisms of a subset

Consider an infinite measure space (Z, λ) . We say that two measurable sets $A, B \subseteq Z$ are **commensurate** if the measure of their symmetric difference is finite, $\lambda(A \Delta B) < \infty$. The relation of being commensurate is an equivalence relation, and all sets of finite measure fall into a single class. Note also that if A and B are both commensurate to some C , then so is the intersection $A \cap B$; in other words, all equivalence classes of commensurability are closed under finite intersections.

Let $\mathfrak{C}(B)$ denote the collection of all measurable $A \subseteq Z$ that are commensurate to B . Fix some $Y \subseteq Z$ and consider the semigroup of measure-preserving transformations between elements of $\mathfrak{C}(Y)$. More precisely, let $\text{Iso}^*(Y, \lambda)$ be the collection of measure-preserving maps $T : A \rightarrow B$ between sets $A, B \in \mathfrak{C}(Y)$, which we call the **self commensurating semigroup** of (Y, λ) .

We use the notation $\text{dom} T = A$ and $\text{rng} T = B$ to refer to the domain and the range of T , respectively. As usual, we identify two maps that differ on a null set. Since classes of commensurability are closed under finite intersections, the set $\text{Iso}^*(Y, \lambda)$ forms a semigroup under the composition.

This semigroup carries a natural equivalence relation: $T \sim S$ whenever the transformations disagree on a set of finite measure, $\lambda(\{x : Tx \neq Sx\}) < \infty$. This equivalence is, moreover, a congruence, i.e., if $T_1 \sim S_1$ and $T_2 \sim S_2$, then $T_1 \circ T_2 \sim S_1 \circ S_2$. One may therefore push the semigroup structure from $\text{Iso}^*(Y, \lambda)$ onto the set of equivalence classes, which we denote by $\text{Aut}^*(Y, \lambda)$. An important observation is that $\text{Aut}^*(Y, \lambda)$ is a group. Indeed, the identity corresponds to the map $x \mapsto x$ on Y , and for a representative $T \in \text{Iso}^*(Y, \lambda)$, its inverse inside $\text{Aut}^*(Y, \lambda)$ is, naturally, given by $T^{-1} : \text{rng } T \rightarrow \text{dom } T$. We call $\text{Aut}^*(Y, \lambda)$ the **self commensurating automorphism group** of Y .

The self commensurating semigroup admits an important homomorphism into the reals, $\mathcal{I} : \text{Iso}^*(Y, \lambda) \rightarrow \mathbb{R}$, called the **index map** and defined by

$$\mathcal{I}(T) = \lambda(\text{dom } T \setminus \text{rng } T) - \lambda(\text{rng } T \setminus \text{dom } T).$$

LEMMA 6.1. *For all $T \in \text{Iso}^*(Y, \lambda)$, the index map satisfies the following:*

(1) *if $A \in \mathfrak{C}(Y)$ is such that $\text{dom } T \subseteq A$ and $\text{rng } T \subseteq A$, then*

$$\mathcal{I}(T) = \lambda(A \setminus \text{rng } T) - \lambda(A \setminus \text{dom } T);$$

(2) *if $T' \in \text{Iso}^*(Y, \lambda)$ is a restriction of T , that is $T' = T \upharpoonright_{\text{dom } T'}$, then $\mathcal{I}(T') = \mathcal{I}(T)$.*

PROOF. (1) If $A \subseteq Z$ is commensurate to Y and $\text{dom } T \subseteq A$, $\text{rng } T \subseteq A$, then

$$\begin{aligned} \mathcal{I}(T) &= \lambda(\text{dom } T \setminus \text{rng } T) - \lambda(\text{rng } T \setminus \text{dom } T) \\ &= \lambda(A \setminus \text{rng } T) - \lambda(A \setminus (\text{dom } T \cup \text{rng } T)) \\ &\quad - (\lambda(A \setminus \text{dom } T) - \lambda(A \setminus (\text{dom } T \cup \text{rng } T))) \\ &= \lambda(A \setminus \text{rng } T) - \lambda(A \setminus \text{dom } T). \end{aligned}$$

(2) If $T' \in \text{Iso}^*(Y, \lambda)$ is a restriction of T , then

$$T(\text{dom } T \setminus \text{dom } T') = \text{rng } T \setminus \text{rng } T'.$$

Thus for any $A \in \mathfrak{C}(Y)$ containing both $\text{dom } T$ and $\text{rng } T$, item (1) implies

$$\begin{aligned} \mathcal{I}(T) &= \lambda(A \setminus \text{dom } T) - \lambda(A \setminus \text{rng } T) \\ &= \lambda(A \setminus \text{dom } T') - \lambda(\text{dom } T \setminus \text{dom } T') - (\lambda(B \setminus \text{rng } T') - \lambda(\text{rng } T \setminus \text{rng } T')) \\ &= \lambda(A \setminus \text{dom } T') - \lambda(A \setminus \text{rng } T') = \mathcal{I}(T'), \end{aligned}$$

where the equality $\lambda(\text{dom } T \setminus \text{dom } T') = \lambda(\text{rng } T \setminus \text{rng } T')$ is based on T being measure-preserving. \square

PROPOSITION 6.2. *The index map $\mathcal{I} : \text{Iso}^*(Y, \lambda) \rightarrow \mathbb{R}$ is a homomorphism. Moreover, if $T, S \in \text{Iso}^*(Y, \lambda)$ are equivalent, $T \sim S$, then $\mathcal{I}(T) = \mathcal{I}(S)$.*

PROOF. In view of Lemma 6.1(2), to check that $\mathcal{I}(T_1 \circ T_2) = \mathcal{I}(T_1) + \mathcal{I}(T_2)$ we may pass to restrictions of these transformations and assume that $\text{rng } T_2 = \text{dom } T_1$. Pick a set $A \in \mathfrak{C}(Y)$ large enough to contain the domains and ranges of T_1 and T_2 ; by Lemma 6.1(1)

$$\begin{aligned} \mathcal{I}(T_1 \circ T_2) &= \lambda(A \setminus \text{rng } T_1) - \lambda(A \setminus \text{dom } T_2) \\ &= \lambda(A \setminus \text{rng } T_1) - \lambda(A \setminus \text{dom } T_1) + \lambda(A \setminus \text{rng } T_2) - \lambda(A \setminus \text{dom } T_2) \\ &= \mathcal{I}(T_1) + \mathcal{I}(T_2). \end{aligned}$$

For the moreover part, suppose that $T, S \in \text{Iso}_Y^*(Y, \lambda)$ are equivalent. Let U be the restriction of T and S onto the set $\{x : Tx = Sx\}$. Using Lemma 6.1(2) once again, we get $\mathcal{I}(T) = \mathcal{I}(U) = \mathcal{I}(S)$, hence the index map is invariant under the equivalence relation \sim . \square

The proposition above implies that the index map respects the relation \sim , and hence gives rise to a map from $\text{Aut}^*(Y, \lambda)$ to the reals.

COROLLARY 6.3. *The index map factors to a group homomorphism*

$$\mathcal{I} : \text{Aut}^*(Y, \lambda) \rightarrow \mathbb{R}.$$

6.2. The commensurating automorphism group

Let us again consider an infinite measure space (Z, λ) and $Y \subseteq Z$ a measurable subset. We now define the **commensurating automorphism group of Y in Z** as the group of all measure-preserving transformations $T \in \text{Aut}(Z, \lambda)$ such that $\lambda(Y \Delta T(Y)) < \infty$. We denote this group by $\text{Aut}_Y(Z, \lambda)$.

Every $T \in \text{Aut}_Y(Z, \lambda)$ naturally gives rise to an element of $\text{Aut}^*(Y, \lambda)$ by considering its restriction $T \upharpoonright_Y$. The following lemma shows that in this case we may use any other set A commensurate to Y instead without changing the corresponding element of the commensurating group.

LEMMA 6.4. *Let $T \in \text{Aut}(Z, \lambda)$ be a measure-preserving automorphism. If $T \upharpoonright_A \in \text{Iso}^*(Y, \lambda)$ for some $A \in \mathfrak{C}(Y)$, then $T \upharpoonright_B \in \text{Iso}^*(Y, \lambda)$ and $T \upharpoonright_B \sim T \upharpoonright_A$ for all $B \in \mathfrak{C}(Y)$.*

PROOF. Since commensuration is an equivalence relation and A is commensurate to Y , the assumption $T \upharpoonright_A \in \text{Iso}^*(Y, \lambda)$ is equivalent to $\lambda(A \Delta T(A)) < \infty$. Moreover, given $B \in \mathfrak{C}(Y)$, we only need to show that $\lambda(B \Delta T(B))$ is finite in order to conclude that $T \upharpoonright_B \in \text{Iso}^*(Y, \lambda)$. So we compute

$$\begin{aligned} \lambda(B \Delta T(B)) &= \lambda(B \setminus T(B)) + \lambda(T(B) \setminus B) \\ &\leq \lambda(A \setminus T(A)) + \lambda(B \setminus A) + \lambda(T(A \setminus B)) \\ &\quad + \lambda(T(A) \setminus A) + \lambda(A \setminus B) + \lambda(T(B \setminus A)) \\ &= \lambda(A \Delta T(A)) + 2\lambda(A \Delta B) < \infty. \end{aligned}$$

Thus the measure $\lambda(B \Delta T(B))$ is finite, hence $T \upharpoonright_B \in \text{Iso}^*(Y, \lambda)$ for all $B \in \mathfrak{C}(Y)$. Finally, $T \upharpoonright_A \sim T \upharpoonright_B$, since these transformations agree on $A \cap B$. \square

To summarize, if $T \upharpoonright_A \in \text{Iso}^*(Y, \lambda)$ for some $A \in \mathfrak{C}(Y)$, then all restrictions $T \upharpoonright_B$, $B \in \mathfrak{C}(Y)$, are pairwise equivalent, hence correspond to the same element $T \upharpoonright_Y \in \text{Aut}^*(Y, \lambda)$. According to Proposition 6.2, the index $\mathcal{I}(T \upharpoonright_Y)$ of this element can be computed as $\mathcal{I}(T \upharpoonright_Y) = \lambda(B \setminus T(B)) - \lambda(B \setminus T^{-1}(B))$ for any $B \in \mathfrak{C}(Y)$.

6.3. Index map on L^1 full groups of \mathbb{R} -flows

Let $\mathcal{F} = \mathbb{R} \curvearrowright X$ be a free measure-preserving Borel flow, let $[\mathcal{F}]_1$ be the associated L^1 full group, where we endow \mathbb{R} with the standard Euclidean norm, and let $T \in [\mathcal{F}]_1$. The action of $r \in \mathbb{R}$ upon $x \in X$ is denoted additively by $x + r$. Recall that the cocycle of T is denoted by $\rho_T : X \rightarrow \mathbb{R}$ and is defined by the equality $T(x) = x + \rho_T(x)$ for all $x \in X$. We are going to argue that, on every orbit, T induces a measure-preserving transformation that belongs to the commensurate group of $\mathbb{R}^{\geq 0}$, when the orbit is identified with the real line.

Consider the function $f : \mathcal{R}_{\mathcal{F}} \rightarrow \{-1, 0, 1\}$ defined by

$$f(x, y) = \begin{cases} 1 & \text{if } x < y < T(x), \\ -1 & \text{if } T(x) < y < x, \\ 0 & \text{otherwise.} \end{cases}$$

One can think of f as a ‘‘charge function’’ that spreads charge $+1$ over each interval $(x, T(x))$ and -1 over $(T(x), x)$. Note that $\int_{\mathbb{R}} f(x, x+r) d\lambda(r) = \rho_T(x)$. Since T belongs to the L^1 full group, its cocycle is integrable, which means that f is M -integrable (see Section 4.2). We apply the mass-transport principle, which shows that

$$\int_X \int_{\mathbb{R}} f(x, x+r) d\lambda(r) d\mu(x) = \int_X \int_{\mathbb{R}} f(x+r, x) d\lambda(r) d\mu(x).$$

Let $T_x \in \text{Aut}(\mathbb{R}, \lambda)$ denote the transformation induced by T onto the orbit of x obtained by identifying the origin of the real line with x . The following two quantities are therefore finite:

$$\begin{aligned} \int_{\mathbb{R}} |f(x+r, x)| d\lambda(r) &= \lambda(\mathbb{R}^{\geq 0} \setminus T_x(\mathbb{R}^{\geq 0})) + \lambda(T_x(\mathbb{R}^{\geq 0}) \setminus \mathbb{R}^{\geq 0}), \\ \int_{\mathbb{R}} f(x+r, x) d\lambda(r) &= \lambda(\mathbb{R}^{\geq 0} \setminus T_x(\mathbb{R}^{\geq 0})) - \lambda(T_x(\mathbb{R}^{\geq 0}) \setminus \mathbb{R}^{\geq 0}). \end{aligned}$$

In particular, $T_x \upharpoonright_{\mathbb{R}^{\geq 0}}$ belongs to the commensurating group of $\mathbb{R}^{\geq 0}$. The second quantity, on the other hand, is equal to the index of $T_x \upharpoonright_{\mathbb{R}^{\geq 0}}$. By Section 6.2, $\mathcal{I}(T_x \upharpoonright_{\mathbb{R}^{\geq 0}}) = \mathcal{I}(T_y \upharpoonright_{\mathbb{R}^{\geq 0}})$ whenever $x\mathcal{R}_{\mathcal{F}}y$. For any $T \in [\mathcal{F}]_1$, we therefore have an orbit invariant measurable map $h_T : X \rightarrow \mathbb{R}$ given by $h_T(x) = \int_{\mathbb{R}} f(x+r, x) d\lambda(r)$. Note that for any \mathcal{F} -invariant set $Y \subseteq X$, we have

$$(6.1) \quad \int_Y \rho_T(x) d\mu(x) = \int_Y h_T(x) d\mu(x).$$

Let (\mathcal{E}, p) , $X \ni x \mapsto \nu_x \in \mathcal{E}$, be the ergodic decomposition of (X, μ, \mathcal{F}) (see Appendix C.3). Since the map h_T is $\mathcal{R}_{\mathcal{F}}$ -invariant, it produces a map $\tilde{h}_T : \mathcal{E} \rightarrow \mathbb{R}$ via $\tilde{h}(\nu) = h(x)$ for any x such that $\nu = \nu_x$ or, equivalently, via

$$\tilde{h}_T(\nu) = \int_X \int_{\mathbb{R}} f(x+r, x) d\lambda(r) d\nu(x).$$

Note also that

$$\int_X h_T(x) d\mu(x) = \int_X \int_{\mathbb{R}} f(x+r, x) d\lambda(r) d\mu(x) = \int_{\mathcal{E}} \tilde{h}_T(\nu) dp(\nu),$$

thus $\tilde{h}_T \in L^1(\mathcal{E}, \mathbb{R})$. We can now define the index map of a (possibly non-ergodic) flow as a function $\mathcal{I} : [\mathcal{F}]_1 \rightarrow L^1(\mathcal{E}, \mathbb{R})$.

DEFINITION 6.5. Let $\mathcal{F} = \mathbb{R} \curvearrowright X$ be a free measure-preserving flow on a standard probability space (X, μ) ; let also (\mathcal{E}, p) be the space of \mathcal{F} -invariant ergodic probability measures, where p is the probability measure yielding the disintegration of μ . The **index map** is the function $\mathcal{I} : [\mathcal{F}]_1 \rightarrow L^1(\mathcal{E}, \mathbb{R})$ given by $\mathcal{I}(T)(\nu) = \tilde{h}_T(\nu) = \int_X \int_{\mathbb{R}} f(x+r, x) d\lambda(r) d\nu(x)$.

PROPOSITION 6.6. For any free measure-preserving flow $\mathcal{F} = \mathbb{R} \curvearrowright X$, the index map $\mathcal{I} : [\mathcal{F}]_1 \rightarrow L^1(\mathcal{E}, \mathbb{R})$ is a continuous and surjective homomorphism.

PROOF. The index map is a homomorphism, since, as we have discussed earlier, $h_T(x)$ is equal to the index of $T_x \upharpoonright_{\mathbb{R}_{\geq 0}}$. Continuity follows from the fact that \mathcal{I} is a Borel homomorphism between Polish groups. To see surjectivity, pick any $\tilde{h} \in L^1(\mathcal{E}, \mathbb{R})$, view it as a map $h : X \rightarrow \mathbb{R}$ via the identification $h(x) = \tilde{h}(\nu_x)$. Define the automorphism $T \in \text{Aut}(X, \mu)$ by $T(x) = x + h(x)$. It is straightforward to check that $T \in [\mathcal{F}]_1$ and $\mathcal{I}(T) = h$. \square

The quotient group $[\mathcal{F}]_1 / \ker \mathcal{I}$ naturally inherits the quotient norm given by

$$\|T \ker \mathcal{I}\|_1 = \inf_{S \in \ker \mathcal{I}} \|TS\|_1.$$

By Proposition 6.6, the index map induces an isomorphism between $[\mathcal{F}]_1 / \ker \mathcal{I}$ and $L^1(\mathcal{E}, \mathbb{R})$. We argue that this isomorphism is, in fact, an isometry.

PROPOSITION 6.7. *The index map \mathcal{I} induces an isometric isomorphism between $[\mathcal{F}]_1 / \ker \mathcal{I}$ and $L^1(\mathcal{E}, \mathbb{R})$, where the former is endowed with the quotient norm and the latter bears the usual L^1 norm.*

PROOF. Since $\int_X |h_T(x)| d\mu(x) = \int_{\mathcal{E}} |\tilde{h}_T(\nu)| dp(\nu)$, it suffices to show that for all $T \in [\mathcal{F}]_1$

$$\inf_{S \in \ker \mathcal{I}} \|TS\|_1 = \int_X |h_T| d\mu.$$

Let $T \in [\mathcal{F}]_1$. We first show the inequality $\inf_{S \in \ker \mathcal{I}} \|TS\|_1 \geq \int_X |h_T| d\mu$.

Pick any $S \in \ker \mathcal{I}$. For any \mathcal{F} -invariant measurable $Y \subseteq X$, $\int_Y \rho_S d\mu = 0$ and

$$\int_Y \rho_{TS} d\mu = \int_Y \rho_T(S(x)) d\mu(x) + \int_Y \rho_S(x) d\mu(x) = \int_Y \rho_T d\mu = \int_Y h_T d\mu,$$

where we rely on Eq. (6.1) and S being measure-preserving. Consider the \mathcal{F} -invariant sets

$$Y^{<0} = \{x \in X : h_T(x) < 0\} \quad \text{and} \quad Y^{\geq 0} = \{x \in X : h_T(x) \geq 0\}.$$

The norm $\|TS\|_1$ can be estimated from below as follows.

$$\begin{aligned} \|TS\|_1 &= \int_X |\rho_{TS}| d\mu = \int_{Y^{<0}} |\rho_{TS}| d\mu + \int_{Y^{\geq 0}} |\rho_{TS}| d\mu \\ &\geq \left| \int_{Y^{<0}} \rho_{TS} d\mu \right| + \left| \int_{Y^{\geq 0}} \rho_{TS} d\mu \right| \\ &= \left| \int_{Y^{<0}} h_T d\mu \right| + \left| \int_{Y^{\geq 0}} h_T d\mu \right| \\ &= - \int_{Y^{<0}} h_T d\mu + \int_{Y^{\geq 0}} h_T d\mu = \int_X |h_T| d\mu. \end{aligned}$$

We conclude that

$$\inf_{S \in \ker \mathcal{I}} \|TS\|_1 \geq \int_X |h_T| d\mu.$$

For the other direction, consider a transformation T' defined by $T'(x) = x + h_T(x)$; note that $T' \in [\mathcal{F}]_1$, $\rho_{T'}(x) = h_{T'}(x) = h_T(x)$ for all $x \in X$, and $T^{-1}T' \in \ker \mathcal{I}$. Therefore

$$\inf_{S \in \ker \mathcal{I}} \|TS\|_1 \leq \|TT^{-1}T'\|_1 = \|T'\|_1 = \int_X |h_{T'}| d\mu = \int_X |h_T| d\mu,$$

and the desired equality of norms follows. \square

Using a similar reasoning, we get the following characterization of the L^1 full group and the index map, where for all $T \in [\mathcal{R}_{\mathcal{F}}]$ we let r_T be the measure-preserving transformation of $(\mathcal{R}_{\mathcal{F}}, M)$ given by $r_T(x, y) = (x, T(y))$ (see Section 4.2).

PROPOSITION 6.8. *Let $\mathcal{F} = \mathbb{R} \curvearrowright X$ be a free measure-preserving \mathbb{R} -flow. Consider the set $\mathcal{R}^{\geq 0} = \{(x, y) \in \mathcal{R}_{\mathcal{F}} : x \geq y\}$. Then for every $T \in [\mathbb{R} \curvearrowright X]$, we have*

$$\|T\|_1 = M(\mathcal{R}^{\geq 0} \triangle r_T(\mathcal{R}^{\geq 0})).$$

In particular, the L^1 full group of \mathcal{F} can be seen as the commensurating group of $\mathcal{R}^{\geq 0}$ inside the full group of \mathcal{R} . Moreover, in the ergodic case, the index of T as defined above is equal to its index as a commensurating transformation of the set $\mathcal{R}^{\geq 0}$ in the sense of Section 6.1.

PROOF. Through the identification $(x, t) \mapsto (x, x + t)$, the measure-preserving transformation r_T is acting on $X \times \mathbb{R}$ as $\text{id}_X \times T_x$, and the set $\mathcal{R}^{\geq 0}$ becomes $X \times \mathbb{R}^{\geq 0}$. We then have

$$\begin{aligned} M(\mathcal{R}^{\geq 0} \triangle r_T(\mathcal{R}^{\geq 0})) &= \int_X \lambda(\mathbb{R}^{\geq 0} \triangle (T_x(\mathbb{R}^{\geq 0}))) d\mu(x) \\ &= \int_X |\rho_T| d\mu \end{aligned}$$

by the mass-transport principle, which yields the conclusion, since by the definition of the norm $\|T\|_1 = \int_X |\rho_T| d\mu$.

The moreover part follows from a similar computation. \square

REMARK 6.9. The full group of \mathcal{R} embeds via $T \mapsto r_T$ into the group of measure-preserving transformations of (\mathcal{R}, M) . One could use this and the fact that the commensurating automorphism group of $\mathcal{R}^{\geq 0}$ is a Polish group in order to give another proof that L^1 full groups of measure-preserving \mathbb{R} -flows are themselves Polish.

Orbitwise ergodic bounded elements of full groups

The purpose of this chapter is to contrast some of the differences in the dynamics of the elements of full groups of \mathbb{Z} -actions and those arising from \mathbb{R} -flows. Let $S \in [\mathbb{Z} \curvearrowright X]$ be an element of the full group of a measure-preserving aperiodic transformation and let $\rho_{S^k} : X \rightarrow \mathbb{Z}$ be the cocycle associated with S^k for $k \in \mathbb{Z}$. Since \mathbb{Z} is a discrete group, the conservative part in the Hopf's decomposition for S (see Appendix B) reduces to the set of periodic orbits. In particular, an aperiodic $S \in [\mathbb{Z} \curvearrowright X]$ has to be dissipative, hence $|\rho_{S^k}(x)| \rightarrow \infty$ as $k \rightarrow \infty$. When S belongs to the L^1 full group of the action, a theorem of R. M. Belinskaja [Bel68, Thm. 3.2] strengthens this conclusion and asserts that for almost all x in the dissipative component of S either $\rho_{S^k}(x) \rightarrow +\infty$ or $\rho_{S^k}(x) \rightarrow -\infty$.

Given an arbitrary free measure-preserving flow $\mathbb{R} \curvearrowright X$, we build an example of an aperiodic $S \in [\mathbb{R} \curvearrowright X]_1$ for which the signs in $\{\rho_{S^k}(x) : k \in \mathbb{N}\}$ keep alternating indefinitely for almost all $x \in X$. In fact, we present a transformation that acts ergodically on each orbit of the flow (in particular, it is conservative and globally ergodic as soon as the flow is ergodic). Moreover, we ensure it has a uniformly bounded cocycle. Our argument uses a variant of the well-known cutting and stacking construction adapted for infinite measure spaces. Additional technical difficulties arise from the necessity to work across all orbits of the flow simultaneously. The transformation will arise as a limit of special partial maps we call *castles*, which we now define.

The **pseudo full group** of the flow is the set of injective Borel maps $\varphi : \text{dom } \varphi \rightarrow \text{rng } \varphi$ between Borel sets $\text{dom } \varphi \subseteq X$, $\text{rng } \varphi \subseteq X$, for which there exists a countable Borel partition $(A_n)_{n \in \mathbb{N}}$ of the domain $\text{dom } \varphi$ and a countable family of reals $(t_n)_{n \in \mathbb{N}}$ such that $\varphi(x) = x + t_n$ for every $x \in A_n$. Such maps are measure-preserving isomorphisms between $(\text{dom } \varphi, \mu \upharpoonright_{\text{dom } \varphi})$ and $(\text{rng } \varphi, \mu \upharpoonright_{\text{rng } \varphi})$. The **support** of φ is the set

$$\text{supp } \varphi = \{x \in \text{dom } \varphi : \varphi(x) \neq x\} \cup \{x \in \text{rng } \varphi : \varphi^{-1}(x) \neq x\}.$$

Given φ in the pseudo full group and a Borel set $A \subseteq X$, we let

$$\varphi(A) = \{\varphi(x) : x \in A \cap \text{dom } \varphi\}.$$

In particular, $\varphi(A) = \emptyset$ if A is disjoint from $\text{dom } \varphi$. A **castle** is an element φ of the pseudo full group of the flow such that for $B = \text{dom } \varphi \setminus \text{rng } \varphi$ the sequence $(\varphi^k(B))_{k \in \mathbb{N}}$ consists of pairwise disjoint subsets which cover its support. Since φ is measure-preserving, for almost every $x \in B$ there is $k \in \mathbb{N}$ such that $\varphi^k(x) \notin \text{dom } \varphi$. It follows that φ^{-1} is also a castle. The set B is called the **basis** of the castle, and the basis of its inverse C is called its **ceiling**, which is equal to $\text{rng } \varphi \setminus \text{dom } \varphi$. Observe that if two castles have disjoint supports, then their union is also a castle.

We denote by $\vec{\varphi} : B \rightarrow C$ the element of the pseudo full group which takes every element of the basis of φ to the corresponding element of the ceiling.

REMARK 7.1. Equivalently, one could define a castle as an element φ of the pseudo full group which induces a *graphing* consisting of finite segments only (see [KM04, Sec. 17] for the definition of a graphing). It induces a partial order \leq_φ defined by $x \leq_\varphi y$ if and only if there is $k \in \mathbb{N}$ such that $y = \varphi^k(x)$. The basis of the castle is the set of minimal elements, while the ceiling is the set of maximal ones. Finally, $\vec{\varphi}$ is the map which takes a minimal element to the unique maximal element above it.

THEOREM 7.2. *Let $\mathbb{R} \curvearrowright X$ be a free measure-preserving flow. There exists $S \in [\mathbb{R} \curvearrowright X]$ that acts ergodically on every orbit of the flow and whose cocycle is bounded by 4. Moreover, the signs in $\{\rho_{S^k}(x) : k \in \mathbb{N}\}$ keep changing indefinitely for almost all $x \in X$.*

PROOF. Fix a free measure-preserving flow $\mathbb{R} \curvearrowright X$, and let $\mathcal{C} \subset X$ be a cross-section. Since \mathcal{C} is lacunary, for any $c \in \mathcal{C}$ there exists $\min\{r > 0 : c + r \in \mathcal{C}\}$; we denote this value by $\text{gap}_{\mathcal{C}}(c)$. This gives the first return map $\sigma_{\mathcal{C}} : \mathcal{C} \rightarrow \mathcal{C}$ via $\sigma_{\mathcal{C}}(c) = c + \text{gap}_{\mathcal{C}}(c)$, which is Borel. There is also a natural bijective correspondence between X and the set $\{(c, r) \in \mathcal{C} \times \mathbb{R}^{\geq 0} : c \in \mathcal{C}, 0 \leq r < \text{gap}_{\mathcal{C}}(c)\}$. Let $\lambda_c^{\mathcal{C}}$ be the ‘‘Lebesgue measure’’ on $c + [0, \text{gap}_{\mathcal{C}}(c))$ given by

$$\lambda_c^{\mathcal{C}}(A) = \lambda(\{r \in \mathbb{R} : 0 \leq r < \text{gap}_{\mathcal{C}}(c), c + r \in A\}).$$

The measure μ on X can be disintegrated as $\mu(A) = \int_{\mathcal{C}} \lambda_c^{\mathcal{C}}(A) d\nu(c)$ for some finite (but not necessarily probability) measure ν on \mathcal{C} (see, for instance, [Slu17, Sec. 4] and Appendix C.1).

Let $(\mathcal{C}_n)_{n \in \mathbb{N}}$ be a vanishing sequence of markers—a sequence of nested cross-sections $\mathcal{C}_1 \supset \mathcal{C}_2 \supset \mathcal{C}_3 \cdots$ with the empty intersection: $\bigcap_{n \in \mathbb{N}} \mathcal{C}_n = \emptyset$. We may arrange \mathcal{C}_1 to be such that $\text{gap}_{\mathcal{C}_1}(c) \in (2, 3)$ for all $c \in \mathcal{C}_1$. Put

$$\mathcal{C}_0 = \{c + k : c \in \mathcal{C}_1, k \in \{0, 1, 2\}\}$$

and $Y = \mathcal{C}_1 + [0, 2)$. Note that $\mu(X \setminus Y) \leq \frac{1}{3}$. Our first goal is to define an element φ of the pseudo full group with domain and range equal to Y such that for almost every $x \in Y$, the action of φ on the intersection of the orbit of x with Y is ergodic, and which has cocycle bounded by 3. It will then be easy to modify φ to an element of the full group whose action on each orbit of the flow is ergodic at the cost of increasing the cocycle bound to 4.

Our first transformation φ will arise as the limit of a sequence of castles $(\varphi_n)_{n \in \mathbb{N}}$, with each φ_n belonging to the pseudo full group of $\mathcal{R}_{\mathcal{C}_n}$. We also use another family of castles $(\psi_n)_{n \in \mathbb{N}}$ which allows us to extend φ_n by ‘‘going back’’ from its ceiling to its basis while keeping the cocycle bound (this is our main adjustment compared to the usual cutting and stacking procedure). Both sequences of castles will have their cocycles bounded by 3. Here are the basic constraints that these sequences have to satisfy:

- (1) for all $n \geq 1$, $Y = \text{supp } \varphi_n \sqcup \text{supp } \psi_n$;
- (2) for all $n \geq 1$, φ_{n+1} extends φ_n ;
- (3) $\mu(\text{supp } \psi_n)$ tends to 0 as n tends to $+\infty$.

Bases and ceilings of $(\varphi_n)_{n \in \mathbb{N}}$ and $(\psi_n)_{n \in \mathbb{N}}$ will satisfy additional constraints which will enable us to make the induction work and ensure ergodicity on each

orbit of the flow. In order to specify these constraints properly, we introduce the following notation.

Each orbit of the flow comes with the linear order $<$ inherited from \mathbb{R} via $x < y$ if and only if $y = x + t$ for some $t > 0$. Set $\kappa_{\mathcal{C}_n}(x)$ to be the minimum of the intersection of \mathcal{C}_n with the cone $\{y \in X : y \geq x\}$.

Let $\mathcal{D}_1 = \mathcal{C}_1 + 2 \subseteq \mathcal{C}_0$ and \mathcal{D}_n be the set of those $x \in \mathcal{D}_1$ which are maximal in $\kappa_{\mathcal{C}_n}^{-1}(c)$ among points of \mathcal{D}_1 for some $c \in \mathcal{C}_n$; in other words,

$$\mathcal{D}_n = \{x \in \mathcal{D}_1 : (x, \kappa_{\mathcal{C}_n}(x)) \cap \mathcal{C}_0 = \emptyset\}.$$

Note that by construction the distance between x and $\kappa_{\mathcal{C}_n}(x)$ is less than 1 for each $x \in \mathcal{D}_n$. Let ι_n be the map $\mathcal{C}_n \rightarrow \mathcal{D}_n$ which assigns to $c \in \mathcal{C}_n$ the $<$ -least element of \mathcal{D}_n which is greater than c .

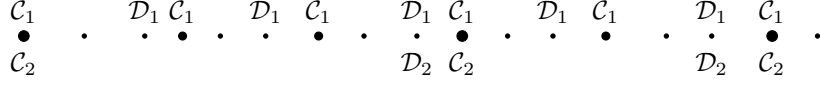

FIGURE 7.1. An example of cross-sections \mathcal{C}_0 (all points), \mathcal{C}_1 (dots of size \bullet and above), \mathcal{C}_2 (marked as \bullet) and $\mathcal{D}_1, \mathcal{D}_2$.

The bases and ceilings of φ_n and ψ_n are as follows.

- the basis of φ_n is $A_n = \mathcal{C}_n + [0, \frac{1}{2^n})$;
- the ceiling of φ_n is $B_n = \mathcal{D}_n + [-\frac{1}{2} - \frac{1}{2^n}, -\frac{1}{2})$;
- the basis of ψ_n is $C_n = \mathcal{D}_n + [-\frac{1}{2}, -\frac{1}{2} + \frac{1}{2^n})$;
- the ceiling of ψ_n is $D_n = \mathcal{C}_n + [\frac{1}{2}, \frac{1}{2} + \frac{1}{2^n})$.

Furthermore, we impose two **translation conditions**, which help us to preserve the above concrete definitions of the bases and ceilings at the inductive step when we construct φ_{n+1} and ψ_{n+1} :

- $\tilde{\varphi}_n(c+t) = \iota_n(c) + t - \frac{1}{2} - \frac{1}{2^n}$ for all $c \in \mathcal{C}_n$ and all $t \in [0, \frac{1}{2^n})$.
- $\tilde{\psi}_n(d+t) = \iota_n^{-1}(d) + t + 1$ for all $d \in \mathcal{D}_n$ and all $t \in [-\frac{1}{2}, -\frac{1}{2} + \frac{1}{2^n})$.

The first step of the construction consists of the castle $\varphi_1 : x \mapsto x + 1$, which has the basis $A_1 = \mathcal{C}_1 + [0, \frac{1}{2})$ and ceiling $B_1 = \mathcal{D}_1 + [-1, -\frac{1}{2})$, and the castle $\psi_1 : x \mapsto x - 1$ defined for $x \in \mathcal{C}_1$ with ceiling $D_1 = \mathcal{C}_1 + [\frac{1}{2}, 1)$.

We now concentrate on the induction step: suppose φ_n and ψ_n have been built for some $n \geq 1$, let us construct φ_{n+1} and ψ_{n+1} .

The strategy is to split the basis of φ_n and ψ_n into two equal intervals and “interleave” the “two halves” of φ_n with “one half” of ψ_n followed by “gluing” adjacent ceilings and basis within the same \mathcal{C}_{n+1} segment (see Figure 7.2). To this end, we introduce two intermediate castles $\tilde{\varphi}_n$ and $\tilde{\psi}_n$ which will ensure that φ_{n+1} “wiggles” more than φ_n , yielding ergodicity of the final transformation.

Define two new half measure subsets of the bases A_n and C_n respectively:

- $A_n^1 = \mathcal{C}_n + [0, \frac{1}{2^{n+1}})$;
- $C_n^0 = \mathcal{D}_n + [-\frac{1}{2} + \frac{1}{2^{n+1}}, -\frac{1}{2} + \frac{1}{2^n})$;

and let

$$B_n^0 = \tilde{\varphi}_n(A_n^1) = \mathcal{D}_n + \left[-\frac{1}{2} - \frac{1}{2^n}, -\frac{1}{2} - \frac{1}{2^{n+1}}\right),$$

and

$$D_n^0 = \vec{\psi}_n(C_n^0) = C_n + \left[\frac{1}{2} + \frac{1}{2^{n+1}}, \frac{1}{2} + \frac{1}{2^n} \right),$$

where the two equalities are consequences of the translation conditions. Let E_n be the ψ_n -saturation of C_n^0 , and note that the restriction of ψ_n to E_n is a castle with support E_n , whose basis is C_n^0 and whose ceiling is D_n^0 . Finally, let

$$A_n^0 = A_n \setminus A_n^1 = C_n + \left[\frac{1}{2^{n+1}}, \frac{1}{2^n} \right).$$

We define the partial measure-preserving transformation $\xi_n : B_n^0 \sqcup D_n^0 \rightarrow C_n^0 \sqcup A_n^0$ to be used for “gluing together” φ_n and the restriction of ψ_n to E_n :

- $\xi_n(b) = b + \frac{3}{2^{n+1}} \in C_n^0$ for all $b \in B_n^0$ and
- $\xi_n(d) = d - \frac{1}{2} \in A_n^0$ for all $d \in D_n^0$.

Set $\tilde{\varphi}_n = \varphi_n \sqcup \xi_n \sqcup \psi_n|_{E_n}$, whereas $\tilde{\psi}_n$ is simply the restriction of ψ_n onto the complement of E_n . Observe that $\tilde{\varphi}_n$ has basis A_n^1 and ceiling

$$B_n^1 = B_n \setminus B_n^0 = D_n + \left[-\frac{1}{2} - \frac{1}{2^{n+1}}, -\frac{1}{2} \right),$$

while $\tilde{\psi}_n$ has basis

$$C_n^1 = C_n \setminus C_n^0 = D_n + \left[-\frac{1}{2}, -\frac{1}{2} + \frac{1}{2^{n+1}} \right)$$

and ceiling

$$D_n^1 = D_n \setminus D_n^0 = C_n + \left[\frac{1}{2}, \frac{1}{2} + \frac{1}{2^{n+1}} \right).$$

We continue to have $Y = \text{supp } \tilde{\varphi}_n \sqcup \text{supp } \tilde{\psi}_n$, but the support of $\tilde{\psi}_n$ is half the support of ψ_n , and $\mu(\text{supp } \tilde{\psi}_n) = \frac{1}{2}\mu(\text{supp } \psi_n)$.

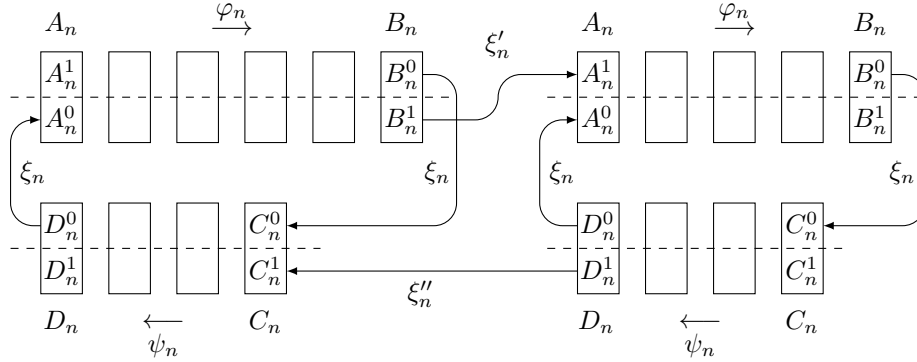

FIGURE 7.2. Inductive step.

The ceiling of $\tilde{\varphi}_n$ is equal to $B_n^1 = D_n + \left[-\frac{1}{2} - \frac{1}{2^{n+1}}, -\frac{1}{2} \right)$, whereas we need the ceiling of φ_{n+1} to be equal to $B_{n+1} = D_{n+1} + \left[-\frac{1}{2} - \frac{1}{2^{n+1}}, -\frac{1}{2} \right)$. We obtain the required φ_{n+1} and ψ_{n+1} out of $\tilde{\varphi}_n$ and $\tilde{\psi}_n$ respectively by “passing through each element of $C_n \setminus C_{n+1}$ ”.

Note that \mathcal{D}_{n+1} is equal to the set of $d \in \mathcal{D}_n$ such that $\kappa_{\mathcal{C}_n}(d) \in \mathcal{C}_{n+1}$. Each $x \in B_n^1 \setminus B_{n+1}$ can be written uniquely as $x = d + t$ where $d \in \mathcal{D}_n \setminus \mathcal{D}_{n+1}$ and $t \in [-\frac{1}{2} - \frac{1}{2^{n+1}}, -\frac{1}{2}]$. Set

$$\xi'_n(x) = \kappa_{\mathcal{C}_n}(d) + t + \frac{1}{2} + \frac{1}{2^{n+1}},$$

and note that $\xi'_n(x)$ belongs to $(\mathcal{C}_n \setminus \mathcal{C}_{n+1}) + [0, \frac{1}{2^{n+1}}) = A_n^1 \setminus A_{n+1}$, hence ξ'_n is a measure-preserving bijection from $B_n^1 \setminus B_{n+1}$ onto $A_n^1 \setminus A_{n+1}$.

The transformation φ_{n+1} is set to be $\tilde{\varphi}_n \sqcup \xi'_n$, and we claim that it is a castle with basis A_{n+1} and ceiling B_{n+1} . This amounts to showing that for all $x \in A_{n+1}$, there is $k \in \mathbb{N}$ such that $\varphi_{n+1}^k(x)$ is not defined. Pick $x \in A_{n+1}$ and write it as $c_0 + t$ for some $c_0 \in \mathcal{C}_{n+1}$ and $t \in [0, \frac{1}{2^{n+1}})$. Let c_1 be the successor of c_0 in \mathcal{C}_n , which we suppose not to be an element of \mathcal{C}_{n+1} . By the construction of $\tilde{\varphi}_n$ and ξ'_n , there is $k \in \mathbb{N}$ such that $\xi'_n(\tilde{\varphi}_n^k(x)) \in c' + [0, \frac{1}{2^{n+1}})$, which means that $\varphi_{n+1}^{k+1}(x) \in c' + [0, \frac{1}{2^{n+1}})$. Iterating this argument, we eventually find $k_0, p \in \mathbb{N}$ such that $\varphi_{n+1}^{k_0+p}(x) \in c_p + [0, \frac{1}{2^{n+1}})$ for some $c_p \in \mathcal{C}_n$ such that the successor c_{p+1} of c_p in \mathcal{C}_n belongs to \mathcal{C}_{n+1} . By the definition of $\tilde{\varphi}_n$ we must have some $l \in \mathbb{N}$ such that $\varphi_{n+1}^{k_0+l}(x) = \tilde{\varphi}_n^l(\varphi_{n+1}^{k_0}(x)) \in B_{n+1}$, whereas $\varphi_{n+1}^{k_0+l+1}(x)$ is not defined, thus φ_{n+1} is indeed a castle.

Extension ψ_{n+1} of $\tilde{\psi}_n$ is defined similarly by connecting adjacent segments of D_n^1 and C_n^1 by a translation. More specifically, each $x \in D_n^1 \setminus D_{n+1}$ can be written uniquely as $x = c + t$ for some $c \in \mathcal{C}_n \setminus \mathcal{C}_{n+1}$ and $t \in [\frac{1}{2}, \frac{1}{2} + \frac{1}{2^{n+1}})$. The restriction of $\kappa_{\mathcal{C}_n}$ to \mathcal{D}_n is a bijection $\mathcal{D}_n \rightarrow \mathcal{C}_n$, we denote its inverse by p_n and let $\xi''_n(x) = p_n(c) + t - 1$. The map $\psi_{n+1} = \tilde{\psi}_n \sqcup \xi''_n$ can be checked to be a castle with basis C_{n+1} and ceiling D_{n+1} as desired. It also follows that the translation conditions continue to be satisfied by both of φ_{n+1} and ψ_{n+1} .

Transformations φ_n extend each other, so $\varphi = \bigcup_n \varphi_n$ is an element of the pseudo full group supported on $Y = \text{supp } \varphi_n \sqcup \text{supp } \psi_n$. Note also that

$$\mu(\text{supp } \psi_{n+1}) = \mu(\text{supp } \psi_n)/2,$$

and therefore $\text{dom } \varphi = Y = \text{rng } \varphi$. We claim that φ , seen as a measure-preserving transformation of Y , induces an ergodic measure-preserving transformation on $(y + \mathbb{R}) \cap Y$ for almost all $y \in Y$, where $y + \mathbb{R}$ is endowed with the Lebesgue measure. This follows from the fact that φ induces a **rank-one** transformation of the infinite measure space $(y + \mathbb{R}) \cap Y$: for all Borel $A \subseteq (y + \mathbb{R}) \cap Y$ of finite Lebesgue measure and all $\epsilon > 0$, there are $B \subseteq (y + \mathbb{R}) \cap Y$, $k \in \mathbb{N}$, and a subset $F \subseteq \{0, \dots, k\}$ such that $B, \varphi(B), \dots, \varphi^k(B)$ are pairwise disjoint and

$$\lambda(A \triangle (\bigsqcup_{f \in F} \varphi^f(B))) < \epsilon.$$

Indeed, at each step n for every $c \in \mathcal{C}_n$, the iterates of $c + [0, \frac{1}{2^n})$ by the restriction of φ_n to the interval $[c, \iota_n(c))$ are disjoint “intervals of size 2^{-n} ”, i.e., sets of the form $t + [0, \frac{1}{2^n})$, and these iterates cover a proportion $1 - \frac{1}{2^n}$ of $[c, \iota_n(c))$ (the rest of this interval being $[c, \iota_n(c)) \cap \text{supp } \psi_n$).

It remains to extend φ supported on Y to a measure-preserving transformation S with $\text{supp } S = X$. Let $Z = X \setminus Y$ be the leftover set,

$$Z = \{c + t : c \in \mathcal{C}_1 : 2 \leq t < \text{gap}_{\mathcal{C}_1}(c)\},$$

and put

$$Z' = \{c + t : c \in \mathcal{C}_1, 2 - \text{gap}_{\mathcal{C}_1}(c) \leq t < 2\}.$$

Figure 7.3 illustrates an interval between $c \in \mathcal{C}_1$ and $c' = \sigma_{\mathcal{C}_1}(c)$. Within this gap, Z corresponds to $[c + 2, c + 2 + \text{gap}_{\mathcal{C}_1}(c))$, and Z' is an interval of the exact same length adjacent to it on the left. Note that $Z' \subseteq Y$ by construction. Let $\eta : Z' \rightarrow Z$ be the natural translation map, $\eta(x) = x + \text{gap}_{\mathcal{C}_1}(c)$ for all $x \in Z'$ satisfying $x \in c + [0, \text{gap}_{\mathcal{C}_1}(c))$. Observe that η is a measure-preserving bijection and its cocycle is bounded by 1.

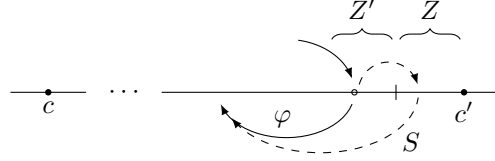

FIGURE 7.3. Construction of the transformation S .

We now rewire the orbits of φ and define $S : X \rightarrow X$ as follows (see Figure 7.3):

$$S(x) = \begin{cases} \varphi(x) & \text{if } x \notin Z \cup Z'; \\ \eta(x) & \text{if } x \in Z'; \\ \varphi(\eta^{-1}(x)) & \text{if } x \in Z. \end{cases}$$

It is straightforward to verify that S is a free measure-preserving transformation, and the distance $D(x, Sx) \leq 4$ for all $x \in X$, because $|\rho_\varphi(x)| \leq 3$ and $|\rho_\eta(x)| \leq 1$ for all x in their domains. Note that the transformation induced by S on Y is equal to φ , so since the latter is ergodic on every orbit of the flow intersected with Y and since $X = Y \sqcup Z$, it follows that S is ergodic on every orbit of the flow and satisfies the conclusion of the theorem. \square

REMARK 7.3. The bound 4 in the formulation of Theorem 7.2 is of no significance as by rescaling the flow it can be replaced with any $\epsilon > 0$.

Conservative and intermitted transformations

Interesting dynamics of conservative transformations is present only in the non-discrete case, as it reduces to periodicity for countable group actions. Chapter 7 provides an illustrative construction of a conservative automorphism, and shows that they exist in L^1 full groups of all free flows. The present chapter is devoted to the study of such elements. The central role is played by the concept of an intermitted transformation, which is related to the notion of induced transformation. Using this tool we show that all conservative elements of $[\mathbb{R} \curvearrowright X]_1$ can be approximated by periodic automorphisms, and hence belong to the derived L^1 full group of $\mathbb{R} \curvearrowright X$; see Corollary 8.8.

Throughout the chapter, we fix a free measure-preserving flow $\mathbb{R} \curvearrowright X$ on a standard Lebesgue space (X, μ) . Given a cross-section $\mathcal{C} \subset X$, recall that we defined an equivalence relation $\mathcal{R}_{\mathcal{C}}$ by declaring $x\mathcal{R}_{\mathcal{C}}y$ whenever there is $c \in \mathcal{C}$ such that both x and y belong to the gap between c and $\sigma_{\mathcal{C}}(c)$. More formally, $x\mathcal{R}_{\mathcal{C}}y$ if there is $c \in \mathcal{C}$ such that $\rho(c, x) \geq 0$, $\rho(c, y) \geq 0$ and $\rho(x, \sigma_{\mathcal{C}}(c)) > 0$, $\rho(y, \sigma_{\mathcal{C}}(c)) > 0$. Such an equivalence relation is smooth.

Now let $T \in [\mathbb{R} \curvearrowright X]$ be a conservative transformation. Under the action of T , almost every point returns to its $\mathcal{R}_{\mathcal{C}}$ -class infinitely often, which suggests the idea of the first return map.

DEFINITION 8.1. The **intermitted transformation** $T_{\mathcal{R}_{\mathcal{C}}} : X \rightarrow X$ is defined by

$$T_{\mathcal{R}_{\mathcal{C}}}x = T^{n(x)}x, \quad \text{where } n(x) = \min\{n \geq 1 : x\mathcal{R}_{\mathcal{C}}T^{n(x)}x\}.$$

The map $T_{\mathcal{R}_{\mathcal{C}}}$ is well-defined, since T is conservative, and it preserves the measure μ , since $T_{\mathcal{R}_{\mathcal{C}}}$ belongs to the full group of T .

REMARK 8.2. The concept of an intermitted transformation T_E makes sense for any equivalence relation E for which intersection of any orbit of T with any E -class is either empty or infinite. In particular, intermitted transformations can be considered for any conservative $T \in [G \curvearrowright X]$ in a full group of a locally compact group action. For instance, with a cocompact cross-section \mathcal{C} we can associate an equivalence relation of lying in same cell of the Voronoi tessellation (see Appendix C.2). Such an equivalence relation does have the aforementioned transversal property, and hence intermitted transformation is well-defined.

Note also the following connection with the more familiar construction of the induced transformation. Let $T \in \text{Aut}(X, \mu)$, let $A \subseteq X$ be a set of positive measure, and define \mathcal{A} to be the equivalence relation with two classes: A and $X \setminus A$. Induced transformations T_A and $T_{X \setminus A}$ commute and satisfy $T_A \circ T_{X \setminus A} = T_A$.

The next lemma forms the core of this chapter. It shows that the operation of taking an intermitted transformation does not increase the norm. As we discuss

later in Remark 8.5, the analog of this statement is false even for \mathbb{R}^2 -flows, which perhaps justifies the technical nature of the argument.

LEMMA 8.3. *Let $T \in [\mathbb{R} \curvearrowright X]_1$ be a conservative automorphism and let \mathcal{C} be a cross-section. Let also Y be the set of points where T and $T_{\mathcal{R}_c}$ differ: $Y = \{x \in X : Tx \neq T_{\mathcal{R}_c}x\}$. One has $\int_Y |\rho_{T_{\mathcal{R}_c}}| d\mu \leq \int_Y |\rho_T| d\mu$.*

PROOF. By the definition of Y , for any $x \in Y$ the arc from x to Tx jumps over at least one point of \mathcal{C} . We may therefore represent $|\rho_T(x)|$ as the sum of the distance from x to the first point of \mathcal{C} along the arc plus the rest of the arc. More formally, for $x \in X$ let $\pi_{\mathcal{C}}(x)$ be the unique $c \in \mathcal{C}$ such that $x \in c + [0, \text{gap}_{\mathcal{C}}(c))$. Define $\alpha : Y \rightarrow \mathbb{R}^{\geq 0}$ by

$$\alpha(x) = \begin{cases} |\rho(x, \sigma_{\mathcal{C}}(\pi_{\mathcal{C}}(x)))|, & \text{if } \rho(x, Tx) > 0, \\ |\rho(x, \pi_{\mathcal{C}}(x))| & \text{if } \rho(x, Tx) < 0. \end{cases}$$

Note that $\alpha(x) \leq |\rho_T(x)|$, and set $\beta(x) = |\rho_T(x)| - \alpha(x)$, so that

$$\int_Y |\rho_T| d\mu = \int_Y \alpha d\mu + \int_Y \beta d\mu.$$

For instance, in the context of Figure 8.1, $\alpha(x_4) = \rho(x_4, c_2)$ and $\beta(x_4) = \rho(c_2, x_5)$. Let us partition $Y = Y' \sqcup Y''$, where

$$Y' = \{x \in Y : \rho(x, Tx) \text{ and } \rho(x, T_{\mathcal{R}_c}x) \text{ have the same sign or } T_{\mathcal{R}_c}x = x\},$$

and $Y'' = Y \setminus Y'$ consists of those $x \in Y$ for which the signs of $\rho(x, Tx)$ and $\rho(x, T_{\mathcal{R}_c}x)$ are different. For example, referring to the same figure, $x_0 \in Y''$, while $x_2 \in Y'$.

To prove the lemma it is enough to show two inequalities:

$$(8.1) \quad \int_{Y'} |\rho_{T_{\mathcal{R}_c}}(x)| d\mu(x) \leq \int_Y \alpha(x) d\mu(x),$$

$$(8.2) \quad \int_{Y''} |\rho_{T_{\mathcal{R}_c}}(x)| d\mu(x) \leq \int_Y \beta(x) d\mu(x).$$

Eq. (8.1) is straightforward, since equality of signs of $\rho(x, Tx)$ and $\rho(x, T_{\mathcal{R}_c}x)$ implies that $T_{\mathcal{R}_c}x$ is closer than x to the point $c \in \mathcal{C}$ over which goes the arc from x to Tx . For example, the point x_2 in Figure 8.1 satisfies

$$|\rho_{T_{\mathcal{R}_c}}(x_2)| = \rho(x_2, x_4) \leq \rho(x_2, c_2) = \alpha(x_2).$$

Thus $|\rho_{T_{\mathcal{R}_c}}(x)| \leq \alpha(x)$ for all $x \in Y'$ and so

$$\int_{Y'} |\rho_{T_{\mathcal{R}_c}}| d\mu \leq \int_{Y'} \alpha d\mu \leq \int_Y \alpha d\mu,$$

which gives (8.1). The other inequality will take us a bit more work.

For $x \in Y''$, let $N(x) \geq 1$ be the smallest integer such that the sign of $\rho(x, T^{N(x)+1}x)$ is opposite to that of $\rho_T(x)$. In less formal words, $N(x)$ is the smallest integer such that the arc from $T^{N(x)}x$ to $T^{N(x)+1}x$ jumps over x . In particular, points T^kx , $1 \leq k \leq N(x)$, are all on the same side relative to x , while $T^{N(x)+1}x$ is on the other side of it. We consider the map $\eta : Y'' \rightarrow X$ given by $\eta(x) = T^{N(x)}x$. Properties of this map will be crucial for establishing the inequality (8.2), so let us provide some explanations first.

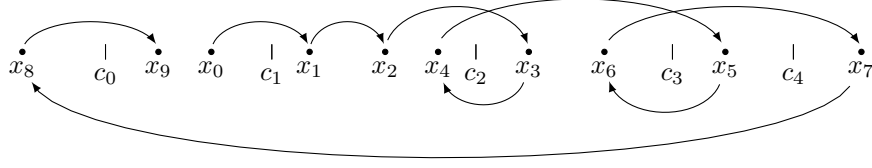

FIGURE 8.1. Dynamics of a conservative orbit.

Consider once again Figure 8.1, which shows a partial orbit of a point x_0 for $x_i = T^i x_0$ up to $i \leq 9$ and several points $c_i \in \mathcal{C}$. First, as we have already noted before, $x_0 \in Y$, since $\neg x_0 \mathcal{R}_{\mathcal{C}} x_1$; moreover, $x_0 \in Y''$, since $x_9 = T_{\mathcal{R}_{\mathcal{C}}} x_0$ is to the left of x_0 , while x_1 is to the right of it, so $\rho(x_0, x_1)$ and $\rho(x_0, x_9)$ have the opposite signs. Also, $N(x_0) = 7$, because x_8 is the first point in the orbit to left of x_0 , thus $\eta(x_0) = x_7$. In particular, generally $T^{N(x)+1} x \neq T_{\mathcal{R}_{\mathcal{C}}} x$, but $T^{N(x)+1} x = T_{\mathcal{R}_{\mathcal{C}}} x$ is the case for $x \in Y''$ whenever $T^{N(x)+1} x$ and x are $\mathcal{R}_{\mathcal{C}}$ -equivalent.

The next point in the orbit $x_1 \notin Y$, whereas $x_2 \in Y$ but $x_2 \notin Y''$, because $T_{\mathcal{R}_{\mathcal{C}}} x_2 = x_4$ and both $\rho(x_2, x_3)$ and $\rho(x_2, x_4)$ are positive. The point x_3 belongs to Y'' and has $N(x_3) = 1$ with $\eta(x_3) = x_4$. Points $x_4, x_5, x_6 \in Y$, but whether any of them are elements of Y'' is not clear from Figure 8.1, as the orbit segment is too short to clarify the values of $T_{\mathcal{R}_{\mathcal{C}}} x_i$, $i = 4, 5, 6$. However, if x_4, x_5, x_6 happen to lie in Y'' , then $N(x_5) = 1$ with $\eta(x_5) = x_6$, and $N(x_4) = 3$, $N(x_6) = 1$, $\eta(x_4) = \eta(x_6) = x_7 = \eta(x_0)$. In particular, the function $x \mapsto \eta(x)$ is not necessarily one-to-one, but we are going to argue that it is always finite-to-one.

CLAIM 1. *If $x, y \in Y''$ are distinct points such that $\eta(x) = \eta(y)$, then $\neg x \mathcal{R}_{\mathcal{C}} y$.*

PROOF OF THE CLAIM. Suppose $x, y \in Y''$ satisfy $\eta(x) = \eta(y)$. The definition of η implies that x and y must belong to the same orbit of T , and we may assume without loss of generality that $y = T^{k_0} x$ for some $k_0 \geq 1$. If the orbit of x and y is aperiodic, it implies that that $N(x) > k_0$ and $N(y) + k_0 = N(x)$, $N(y) \geq 1$. However, even if the orbit is periodic, either $N(y) + k_0 = N(x)$ for the smallest positive integer k_0 such that $y = T^{k_0} x$ or $N(x) + k'_0 = N(y)$ for the smallest positive integer k'_0 such that $x = T^{k'_0} y$. Interchanging the roles of x and y if necessary, we may therefore assume that $N(y) + k_0 = N(x)$ holds for some $k_0 \geq 1$, $T^{k_0} x = y$, regardless of the type of orbit we consider.

Suppose x and y are $\mathcal{R}_{\mathcal{C}}$ -equivalent. Let $k \geq 1$ be the smallest natural number for which x and $T^k x$ are $\mathcal{R}_{\mathcal{C}}$ -equivalent. By the assumption $x \mathcal{R}_{\mathcal{C}} y$ and the choice of k_0 we have $k \leq k_0 < N(x)$. By the definition of $N(x)$, all points $T^i x$, $1 \leq i \leq N(x)$, are on the same side of x . In particular, this applies to Tx and $T^k x$, which shows that $\rho(x, Tx)$ and $\rho(x, T_{\mathcal{R}_{\mathcal{C}}} x)$ have the same sign, thus $x \notin Y''$. \square_{claim}

The above claim implies that the function $x \mapsto \eta(x)$ is finite-to-one for the arc from $\eta(x)$ to $T\eta(x)$ intersects only finitely many $\mathcal{R}_{\mathcal{C}}$ -equivalence classes, and the preimage of $\eta(x)$ picks at most one point from each such class. Note also that $\eta(x) \in Y$ for all $x \in Y''$, but $\eta(x)$ may not be an element of Y'' . Among the $\mathcal{R}_{\mathcal{C}}$ -equivalence classes that the arc from $\eta(x)$ to $T\eta(x)$ goes over, two are special—the intervals that contain $T\eta(x)$ and $\eta(x)$, respectively. Our goal will be to bound the sum of $|\rho_{T_{\mathcal{R}_{\mathcal{C}}}}(x)|$ over the points x with the same $\eta(x)$ value by $\beta(\eta(x))$ (see Claim 3 below). For a typical point x we can bound $|\rho_{T_{\mathcal{R}_{\mathcal{C}}}}(x)|$ simply by the length of the interval of its $\mathcal{R}_{\mathcal{C}}$ -class. For example, Figure 8.1 does not specify $T_{\mathcal{R}_{\mathcal{C}}} x_4$, but

we can be sure that $|\rho_{T_{\mathcal{R}_c}}(x_4)| \leq \rho(c_1, c_2)$. In view of Claim 1, such an estimate comes close to showing that the sum of $|\rho_{T_{\mathcal{R}_c}}(x)|$ over x with the same image $\eta(x)$ is bounded by $|\rho(\eta(x), T\eta(x))|$. It merely comes close, due to the two special \mathcal{R}_c -classes mentioned above, where our estimate needs to be improved. The next claim shows that one of these special cases is of no concern as x is never \mathcal{R}_c -equivalent to $\eta(x)$.

CLAIM 2. *For all $x \in Y''$ we have $\neg x\mathcal{R}_c\eta(x)$.*

PROOF OF THE CLAIM. Suppose towards the contradiction that $x\mathcal{R}_c\eta(x)$, and let $k \geq 1$ be the smallest integer for which $x\mathcal{R}_cT^k(x)$; in particular, $T_{\mathcal{R}_c}x = T^kx$. Note that $k \leq N(x)$ by the assumption, and by the definition of $N(x)$, $\rho(T^kx, x)$ has the same sign as $\rho_T(x)$, whence $x \notin Y''$. \square_{claim}

Pick some $y \in Y$ with non-empty preimage $\eta^{-1}(y)$, and let $z_1, \dots, z_n \in Y''$ be all the elements in $\eta^{-1}(y)$. For instance, in the situation depicted in Figure 8.1, we may have $n = 3$ and $z_1 = x_0, z_2 = x_4, z_3 = x_6$, and $y = x_7$. The following claim unlocks the path towards the inequality (8.2).

CLAIM 3. *In the above notation, $\sum_{i=1}^n |\rho_{T_{\mathcal{R}_c}}(z_i)| \leq \beta(y)$.*

PROOF OF THE CLAIM. Recall that the arc from y to Ty crosses at least one point in \mathcal{C} . If $c \in \mathcal{C}$ is the first such point, then $\beta(y)$ is defined to be $|\rho(c, Ty)|$. For instance, in the notation of Figure 8.1, $\beta(x_7) = |\rho(c_4, x_8)|$. Each point z_i is located under the arc from y to Ty , and by Claim 2, no point z_i belongs to the interval from c to y . In the language of our concrete example, no point z_i can be between c_4 and x_7 . As discussed before, $|\rho_{T_{\mathcal{R}_c}}(x)|$ is always bounded by the length of the gap to which x belongs. This is sufficient to prove the claim if no z_i is equivalent to Ty , as in this case the whole \mathcal{R}_c -equivalence class of every z_i is fully contained under the interval between c and Ty , and distinct z_i represent distinct \mathcal{R}_c -classes by Claim 1. This is the situation depicted in Figure 8.1, and our argument boils down to the inequalities

$$\begin{aligned} |\rho_{T_{\mathcal{R}_c}}(x_0)| + |\rho_{T_{\mathcal{R}_c}}(x_4)| + |\rho_{T_{\mathcal{R}_c}}(x_5)| &\leq |\rho(c_0, c_1)| + |\rho(c_1, c_2)| + |\rho(c_2, c_3)| \\ &\leq |\rho(c_0, c_4)| \leq \beta(x_7). \end{aligned}$$

Suppose there is some z_i such that $z_i\mathcal{R}_cTy$. By Claim 1 such z_i must be unique, and we assume without loss of generality that $z_1\mathcal{R}_cTy$. For example, this situation would occur if in Figure 8.1 Tx_7 were equal to x_9 . Let c' be the first element of \mathcal{C} over which goes the arc from z_1 to Tz_1 (it would be the point c_1 in Figure 8.1). It is enough to show that $|\rho_{T_{\mathcal{R}_c}}(z_1)| \leq |\rho(T_{\mathcal{R}_c}z_1, c')|$, as we can use the previous estimate for all other $|\rho_{T_{\mathcal{R}_c}}(z_i)|$, $i \geq 2$. Note that $T_{\mathcal{R}_c}z_1 = Ty$, and $z_1 \in Y''$ by assumption, which implies that the signs of $\rho(z_1, T_{\mathcal{R}_c}z_1)$ and $\rho(z_1, c')$ are different. The latter is equivalent to saying that z_1 is between $T_{\mathcal{R}_c}z_1$ and c' , i.e., $|\rho(T_{\mathcal{R}_c}z_1, c')| = |\rho_{T_{\mathcal{R}_c}}(z_1)| + |\rho(z_1, c')|$, and the claim follows. \square_{claim}

We are now ready to finish the proof of this lemma. We have already shown that η is finite-to-one, so let $Y''_n \subseteq Y''$, $n \geq 1$, be such that $x \mapsto \eta(x)$ is n -to-one on Y''_n . Let $R_n = \eta(Y''_n)$, and recall that $R_n \subseteq Y$. Sets R_n are pairwise disjoint. Let $\phi_{k,n} : R_n \rightarrow Y''_n$, $1 \leq k \leq n$, be Borel bijections that pick the k th point in the preimage: $Y''_n = \bigsqcup_{i=1}^n \phi_{k,n}(R_n)$. Note that maps $\phi_{k,n} : R_n \rightarrow Y''_n$ are measure-preserving, since they belong to the pseudo full group of T , and $\sum_{k=1}^n |\rho_{T_{\mathcal{R}_c}}(\phi_{k,n}(x))| \leq \beta(x)$ for all $x \in R_n$ by Claim 3. One now has

$$\begin{aligned}
\int_{Y''_n} |\rho_{T_{\mathcal{R}_c}}(x)| d\mu(x) &= \sum_{k=1}^n \int_{\phi_{k,n}(R_n)} |\rho_{T_{\mathcal{R}_c}}(x)| d\mu(x) \\
\because \phi_{n,k} \text{ are measure-preserving} &= \int_{R_n} \sum_{k=1}^n |\rho_{T_{\mathcal{R}_c}}(\phi_{k,n}^{-1}(x))| d\mu(x) \\
\because \text{Claim 3} &\leq \int_{R_n} \beta(x) d\mu(x).
\end{aligned}$$

Summing these inequalities over n we get

$$\begin{aligned}
\int_{Y''} |\rho_{T_{\mathcal{R}_c}}(x)| d\mu(x) &= \sum_{n=1}^{\infty} \int_{Y''_n} |\rho_{T_{\mathcal{R}_c}}(x)| d\mu(x) \\
&\leq \sum_{n=1}^{\infty} \int_{R_n} \beta(x) d\mu(x) \leq \int_Y \beta(x) d\mu(x),
\end{aligned}$$

where the last inequality is based on the fact that sets R_n are pairwise disjoint. This finishes the proof of the inequality (8.2) as well as the lemma. \square

Several important facts follow easily from Lemma 8.3. For one, it implies that for any cross-section \mathcal{C} the intermitted transformation $T_{\mathcal{R}_c}$ belongs to $[\mathbb{R} \curvearrowright X]_1$. In fact, we have the following inequality on the norms.

COROLLARY 8.4. *For any intermitted transformation $T_{\mathcal{R}_c}$ one has $\|T_{\mathcal{R}_c}\|_1 \leq \|T\|_1$.*

PROOF. By the definition of the set Y in Lemma 8.3, $\rho_{T_{\mathcal{R}_c}}(x) = \rho_T(x)$ for all $x \notin Y$, hence

$$\begin{aligned}
\int_X |\rho_{T_{\mathcal{R}_c}}| d\mu &= \int_{X \setminus Y} |\rho_{T_{\mathcal{R}_c}}| d\mu + \int_Y |\rho_{T_{\mathcal{R}_c}}| d\mu \\
\because \text{Lemma 8.3} &\leq \int_{X \setminus Y} |\rho_T| d\mu + \int_Y |\rho_T| d\mu = \int_X |\rho_T| d\mu,
\end{aligned}$$

which shows $\|T_{\mathcal{R}_c}\|_1 \leq \|T\|_1$. \square

REMARK 8.5. As we discussed in Remark 8.2, the concept of an intermitted transformation applies wider than the case of one-dimensional flows. We mention, however, that the analog of Lemma 8.3 and Corollary 8.4 does not hold even for free measure-preserving \mathbb{R}^2 -flows. Consider an annulus depicted in Figure 8.2a and let T be the rotation by an angle α around the center of this annulus. Let the equivalence relation E consist of two classes, each composing half of the ring. For a point x such that $\neg xETx$, $T_E x$ will be close to the other side of the class. It is easy to arrange the parameters (the angle α and the radii of the annulus) so that $\|\rho_{T_E}(x)\| > \|\rho_T(x)\|$ for all x such that $Tx \neq T_E x$.

Every free measure-preserving flow $\mathbb{R}^2 \curvearrowright X$ admits a tiling of its orbits by rectangles. The transformation $T \in [\mathbb{R}^2 \curvearrowright X]_1$ can be defined similarly to Figure 8.2a on each rectangle of the tiling by splitting each tile into two equivalence classes as in 8.2b. The resulting transformation T will have bounded orbits and satisfy $\|T_E\|_1 > \|T\|_1$ relative to the equivalence relation E whose classes are the half tiles.

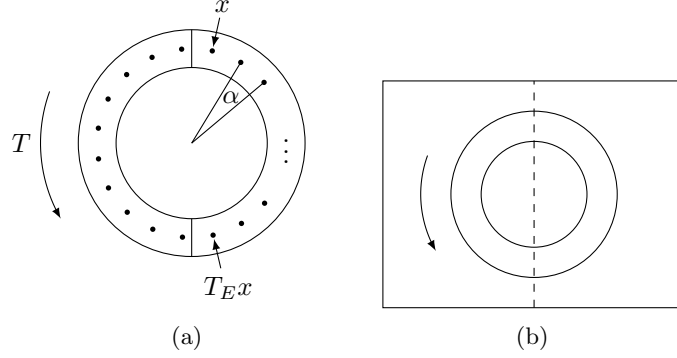

FIGURE 8.2. Construction of a conservative transformation T with $\|T_E\|_1 > \|T\|_1$.

When the gaps in a cross-section \mathcal{C} are large, x and Tx will often be $\mathcal{R}_\mathcal{C}$ -equivalent, and it therefore natural to expect that $T_{\mathcal{R}_\mathcal{C}}$ will be close to T . This intuition is indeed valid, and the following approximation result is the most important consequence of Lemma 8.3.

LEMMA 8.6. *Let $T \in [\mathbb{R} \curvearrowright X]_1$ be a conservative transformation. For any $\epsilon > 0$ there exists M such for any cross-section \mathcal{C} with $\text{gap}_\mathcal{C}(c) \geq M$ for all $c \in \mathcal{C}$ one has $\|T \circ T_{\mathcal{R}_\mathcal{C}}^{-1}\|_1 < \epsilon$.*

PROOF. Let $A_K = \{x \in X : |\rho_T(x)| \geq K\}$, $K \in \mathbb{R}^{\geq 0}$, be the set of points whose cocycle is at least K in the absolute value. Since $T \in [\mathbb{R} \curvearrowright X]_1$, we may pick $K \geq 1$ is so large that $\int_{A_K} |\rho_T| d\mu < \epsilon/4$. Pick any real M such that $2K^2/M < \epsilon/4$. We claim that it satisfies the conclusion of the lemma. To verify this we pick a cross-section \mathcal{C} with all gaps having size at least M . Set as before $Y = \{x \in X : Tx \neq T_{\mathcal{R}_\mathcal{C}}x\}$. Since

$$\|T \circ T_{\mathcal{R}_\mathcal{C}}^{-1}\|_1 = \int_Y D(Tx, T_{\mathcal{R}_\mathcal{C}}x) d\mu(x),$$

our task is to estimate this integral. This can be done in a rather crude way. We can simply use the triangle inequality $D(Tx, T_{\mathcal{R}_\mathcal{C}}x) \leq |\rho_T(x)| + |\rho_{T_{\mathcal{R}_\mathcal{C}}}(x)|$, and deduce

$$\int_Y D(Tx, T_{\mathcal{R}_\mathcal{C}}x) d\mu(x) \leq \int_Y |\rho_T| d\mu + \int_Y |\rho_{T_{\mathcal{R}_\mathcal{C}}}| d\mu \leq 2 \int_Y |\rho_T| d\mu,$$

where the last inequality is based on Lemma 8.3.

It remains to show that $\int_Y |\rho_T| d\mu < \epsilon/2$. Let $\tilde{X} = \{c + [K, \text{gap}_\mathcal{C}(c) - K] : c \in \mathcal{C}\}$ be the region that leaves out intervals of length K on both sides of each point in \mathcal{C} . Note that for any $x \in \tilde{X} \setminus A_K$ one has $x_{\mathcal{R}_\mathcal{C}}Tx$ and thus $T_{\mathcal{R}_\mathcal{C}}x = Tx$ for such points. Therefore, $Y \subseteq A_K \sqcup B_K$, where $B_K = X \setminus (\tilde{X} \cup A_K)$, and thus

$$\int_Y |\rho_T| d\mu \leq \int_{A_K} |\rho_T| d\mu + \int_{B_K} |\rho_T| d\mu < \epsilon/4 + K \cdot 2K/M < \epsilon/2. \quad \square$$

LEMMA 8.7. *Let $T \in [\mathbb{R} \curvearrowright X]_1$ be a conservative transformation. For any $\epsilon > 0$ there exists a periodic transformation $P \in [T]$ such that $\|T \circ P^{-1}\|_1 < \epsilon$.*

PROOF. By Lemma 8.6, we can find a cocompact cross-section \mathcal{C} such that $\|T \circ T_{\mathcal{R}_c}^{-1}\| < \epsilon/2$. Let \tilde{M} be an upper bound for gaps in \mathcal{C} . Recall that the cocycle $|\rho_{T_{\mathcal{R}_c}}(x)|$ is uniformly bounded by \tilde{M} , and, in fact, the same is true for any element in the full group of $T_{\mathcal{R}_c}$. In particular, we may use Rokhlin's lemma to find a periodic $P \in [T_{\mathcal{R}_c}]$ such that $\|T_{\mathcal{R}_c} \circ P^{-1}\| < \epsilon/2\tilde{M}$, and conclude that $\|T_{\mathcal{R}_c} \circ P^{-1}\|_1 < \epsilon/2$. We therefore have

$$\|T \circ P^{-1}\|_1 \leq \|T \circ T_{\mathcal{R}_c}^{-1}\|_1 + \|T_{\mathcal{R}_c} \circ P^{-1}\|_1 < \epsilon. \quad \square$$

COROLLARY 8.8. *If $T \in [\mathbb{R} \curvearrowright X]_1$ is conservative then T belongs to the derived full group $D([\mathbb{R} \curvearrowright X]_1)$, in particular its index satisfies $\mathcal{I}(T) = 0$.*

PROOF. Follows directly from Lemma 8.7 and Corollary 3.15. \square

Dissipative and monotone transformations

The previous chapter studied conservative transformations, whereas this one concentrates on dissipative ones. Our goal will be to show that any dissipative $T \in [\mathbb{R} \curvearrowright X]_1$ of index $\mathcal{I}(T) = 0$ belongs to the derived subgroup $D([\mathbb{R} \curvearrowright X]_1)$. We begin however by describing some general aspects of dynamics of dissipative automorphisms.

Recall that according to Proposition 4.16, any transformation $T \in [\mathbb{R} \curvearrowright X]$ induces a T -invariant partition of the phase space $X = D \sqcup C$ such that $T|_C$ is conservative and $T|_D$ is dissipative. Formally speaking, a transformation is said to be dissipative if the partition trivializes to $D = X$. For the purpose of this chapter it is however convenient to widen this notion just a bit by allowing T to have fixed points.

DEFINITION 9.1. A transformation $T \in [\mathbb{R} \curvearrowright X]$ is said to be **dissipative** if $D = \text{supp } T$, where D is the dissipative element of the Hopf's decomposition for T .

9.1. Orbit limits and monotone transformations

We begin by showing that dynamics of dissipative transformations in L^1 full groups of \mathbb{R} -flows is similar to those in L^1 full groups of \mathbb{Z} actions. We do so by establishing an analog of R. M. Belinskaja's result [Bel68, Thm. 3.2]. Recall that a sequence of reals is said to have an almost constant sign if all but finitely many elements of the sequence have the same sign.

PROPOSITION 9.2. *Let S be a measure-preserving transformation of the real line which commensurates the set \mathbb{R}^- , suppose that S is dissipative. Then for almost all $x \in \mathbb{R}$, the sequence of reals $(S^k(x) - x)_{k \in \mathbb{N}}$ has an almost constant sign.*

PROOF. Let Q be the set of reals x such that $(S^k(x) - x)_{k \in \mathbb{N}}$ does not have an almost constant sign, and suppose by contradiction that Q has positive measure. Since S is dissipative, we can find a Borel wandering set $A \subseteq \mathbb{R}$ for S which non-trivially intersects Q . All the translates of $Q' = Q \cap A$ are disjoint, and, for all $x \in Q'$, $(S^k(x) - x)_{k \in \mathbb{N}}$ does not have an almost constant sign.

Since S is dissipative, for almost all $x \in Q'$, the sequence of absolute values $(|S^k(x)|)_{k \in \mathbb{N}}$ tends to $+\infty$ (see Proposition B.4). In particular, there are infinitely many points y in the S -orbit of x such that $y < 0$ but $S(y) > 0$. Since the map $Q' \times \mathbb{Z} \rightarrow \mathbb{R}$ which maps (x, k) to $S^k(x)$ is measure-preserving, this yields that the set of $y < 0$ such that $S(y) > 0$ has infinite measure, contradicting the fact that S commensurates the set \mathbb{R}^- . \square

COROLLARY 9.3. *Let $T \in [\mathbb{R} \curvearrowright X]_1$ be a dissipative transformation. For almost all $x \in \text{supp } T$, the sequence $(\rho(x, T^k(x)))_{k \in \mathbb{N}}$, has an almost constant sign.*

PROOF. Let $T \in [\mathbb{R} \curvearrowright X]_1$. For all $x \in X$, denote by T_x the measure-preserving transformation of \mathbb{R} induced by T on the \mathbb{R} -orbit of x . By the proof of Proposition 6.8, the integral

$$\int_X \lambda(\mathbb{R}^{\geq 0} \Delta (T_x(\mathbb{R}^{\geq 0}))) d\mu(x)$$

is finite. In particular, for almost every $x \in X$, the transformation T_x commensurates the set $\mathbb{R}^{\geq 0}$. The conclusion now follows directly from the previous proposition. \square

For any dissipative transformation in an L^1 full group of a free locally compact Polish group action and for almost every $x \in X$, $\rho(x, T^n x) \rightarrow \infty$ as $n \rightarrow \infty$, in the sense that $\rho(x, T^n x)$ eventually escapes any compact subset of the acting group. In the context of flows, Corollary 9.3 strengthens this statement and implies that $\rho(x, T^n x)$ must converge to either $+\infty$ or $-\infty$.

COROLLARY 9.4. *If $T \in [\mathbb{R} \curvearrowright X]_1$ is dissipative, then for almost every point $x \in \text{supp} T$ either $\lim_{n \rightarrow \infty} \rho(x, T^n x) = +\infty$ or $\lim_{n \rightarrow \infty} \rho(x, T^n x) = -\infty$.* \square

In view of this corollary, there is a canonical T -invariant decomposition of $\text{supp} T$ into “positive” and “negative” orbits.

DEFINITION 9.5. Let $T \in [\mathbb{R} \curvearrowright X]_1$ be a dissipative automorphism. Its support is partitioned into $\vec{X} \sqcup \bar{X}$, where

$$\begin{aligned} \vec{X} &= \{x \in \text{supp} T : \lim_{n \rightarrow \infty} \rho(x, T^n x) = +\infty\}, \\ \bar{X} &= \{x \in \text{supp} T : \lim_{n \rightarrow \infty} \rho(x, T^n x) = -\infty\}. \end{aligned}$$

The set \vec{X} is said to be **positive evasive** and \bar{X} is **negative evasive**.

According to Corollary 9.3, for almost every $x \in \text{supp} T$, *eventually* either all $T^n x$ are to the right of x or all are to the left of it. There are points x for which the adverb “eventually” can, in fact, be dropped.

COROLLARY 9.6. *Let $T \in [\mathbb{R} \curvearrowright X]_1$ be a dissipative transformation and let*

$$\begin{aligned} \vec{A} &= \{x \in \vec{X} : \rho(x, T^n x) > 0 \text{ for all } n \geq 1\}, \\ \bar{A} &= \{x \in \bar{X} : \rho(x, T^n x) < 0 \text{ for all } n \geq 1\}. \end{aligned}$$

The set $A = \vec{A} \sqcup \bar{A}$ is a complete section for $T|_{\text{supp} T}$.

PROOF. We need to show that almost every orbit of T intersects A . Let $x \in \text{supp} T$ and suppose for definiteness that $x \in \vec{X}$. Since $\lim_{n \rightarrow \infty} \rho(x, T^n x) = +\infty$, there is $n_0 = \max\{n \in \mathbb{N} : \rho(x, T^n x) \leq 0\}$, and therefore $T^{n_0} x \in \vec{A}$. \square

DEFINITION 9.7. A dissipative transformation $T \in [\mathbb{R} \curvearrowright X]_1$ is **monotone** if $\rho(x, Tx) > 0$ for almost all $x \in \vec{X}$, and $\rho(x, Tx) < 0$ for almost all $x \in \bar{X}$.

COROLLARY 9.8. *Let $T \in [\mathbb{R} \curvearrowright X]_1$ be a dissipative transformation. There is a complete section $A \subseteq \text{supp} T$ and a periodic transformation $P \in [\mathbb{R} \curvearrowright X]_1 \cap [T]$ such that $T = P \circ T_A$ and T_A is monotone.*

PROOF. Take A to be as in Corollary 9.6 and note that $P = T \circ T_A^{-1}$ is periodic and satisfies the conclusions of the corollary. \square

As we discussed at the beginning of the chapter, our goal is to show that the index of the kernel map coincides with the derived subgroup of $[\mathbb{R} \curvearrowright X]_1$. Note that if $T = P \circ T_A$ is as above, then $\mathcal{I}(T) = \mathcal{I}(T_A)$, and, coupled with the results of Chapter 8, it will suffice to show that all monotone transformations of index zero belong to $D([\mathbb{R} \curvearrowright X]_1)$. This will be the focus of the rest of this chapter and will take some effort to achieve, but the main strategy is to show that such automorphisms can be approximated by periodic maps, which is the content of Theorem 9.15 below.

9.2. Arrival and departure sets

Throughout the rest of this chapter, we fix a cross-section $\mathcal{C} \subset X$ and a monotone transformation $T \in [\mathbb{R} \curvearrowright X]_1$. The **arrival set** $A_{\mathcal{C}}$ is the set of the first visitors to $E_{\mathcal{C}}$ classes: $A_{\mathcal{C}} = \{x \in \text{supp } T : \neg x E_{\mathcal{C}} T^{-1}x\}$. Analogously, the **departure set** $D_{\mathcal{C}}$ is defined to be $D_{\mathcal{C}} = \{x \in \text{supp } T : \neg x E_{\mathcal{C}} Tx\}$. We also let $\vec{A}_{\mathcal{C}}$ denote $A_{\mathcal{C}} \cap \vec{X}$ and $\vec{A}_{\mathcal{C}} = A_{\mathcal{C}} \cap \vec{X}$; likewise for $\vec{D}_{\mathcal{C}}$ and $\vec{D}_{\mathcal{C}}$. Note that $T(D_{\mathcal{C}}) = A_{\mathcal{C}}$, and thus $T^{-1}(A_{\mathcal{C}}) = D_{\mathcal{C}}$. There is, however, another useful map from $A_{\mathcal{C}}$ onto $D_{\mathcal{C}}$.

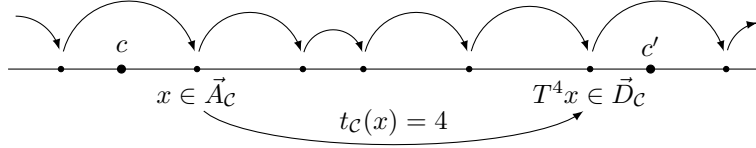

FIGURE 9.1. Arrival and Departure sets.

We define the **transfer value** $t_{\mathcal{C}} : A_{\mathcal{C}} \rightarrow \mathbb{N}$ by the condition

$$t_{\mathcal{C}}(x) = \min\{n \geq 0 : T^n x \in D_{\mathcal{C}}\}$$

and the **transfer function** $\tau_{\mathcal{C}} : A_{\mathcal{C}} \rightarrow D_{\mathcal{C}}$ is defined to be $\tau_{\mathcal{C}}(x) = T^{t_{\mathcal{C}}(x)}x$. Note that $\tau_{\mathcal{C}}$ is measure-preserving. The transfer value introduces a partition of the arrival set $A_{\mathcal{C}} = \bigsqcup_{n \in \mathbb{N}} A_{\mathcal{C}}^n$, where $A_{\mathcal{C}}^n = t_{\mathcal{C}}^{-1}(n)$; by applying the transfer function, it also produces a partition for the departure set: $D_{\mathcal{C}} = \bigsqcup_{n \in \mathbb{N}} D_{\mathcal{C}}^n$, where $D_{\mathcal{C}}^n = \tau_{\mathcal{C}}(A_{\mathcal{C}}^n)$.

In plain words, $t_{\mathcal{C}}(x) + 1$ is the number of points in $[x]_{E_T} \cap [x]_{E_{\mathcal{C}}}$. Therefore if $\lambda_{\mathcal{C}}^c(A_{\mathcal{C}}^n) \geq \lambda_{\mathcal{C}}^c(A_{\mathcal{C}}^m)$ for some $n \geq m$ then also $\lambda_{\mathcal{C}}^c([A_{\mathcal{C}}^n]_{E_T}) \geq \lambda_{\mathcal{C}}^c([A_{\mathcal{C}}^m]_{E_T})$. In Sections 9.3 and 9.4 we modify the transformation T on the arrival and departure sets and we want to do this in a way that affects as many orbits as possible as measured by $\lambda_{\mathcal{C}}^c$. This amounts to using sets $A_{\mathcal{C}}^n$ (and $D_{\mathcal{C}}^n$) with as high values of n as possible. The next lemma will be helpful in conducting such a selection in a measurable way across all of $c \in \mathcal{C}$.

LEMMA 9.9. *Let $A \subseteq X$ be a measurable set with a measurable partition $A = \bigsqcup_n A_n$ and let $\xi : \mathcal{C} \rightarrow \mathbb{R}^{\geq 0}$ be a measurable function such that $\xi(c) \leq \lambda_{\mathcal{C}}^c(A)$ for all $c \in \mathcal{C}$. There are measurable $\nu : \mathcal{C} \rightarrow \mathbb{N}$ and $r : \mathcal{C} \rightarrow \mathbb{R}^{\geq 0}$ such that for any $c \in \mathcal{C}$ for which $\xi(c) > 0$ one has*

$$\lambda_{\mathcal{C}}^c\left(\left(\bigsqcup_{n > \nu(c)} A_n\right) \cup \left(A_{\nu(c)} \cap (c + [0, r(c)])\right)\right) = \xi(c).$$

PROOF. For $c \in \mathcal{C}$ such that $\xi(c) > 0$ set

$$\nu(c) = \min\{n \in \mathbb{N} : \lambda_c^{\mathcal{C}}(\bigsqcup_{k>n} A_k) < \xi(c)\}.$$

Note that one necessarily has $\lambda_c^{\mathcal{C}}(A_{\nu(c)}) \geq \xi(c) - \lambda_c^{\mathcal{C}}(\bigsqcup_{n>\nu(c)} A_n)$. Set

$$r(c) = \min\{a \geq 0 : \lambda_c^{\mathcal{C}}(A_{\nu(c)} \cap (c + [0, a])) = \xi(c) - \lambda_c^{\mathcal{C}}(\bigsqcup_{n>\nu(c)} A_n)\}.$$

These functions ν and r satisfy the conclusions of the lemma. \square

DEFINITION 9.10. Consider the partition of the positive arrival set $\vec{A}_{\mathcal{C}} = \bigsqcup_n \vec{A}_{\mathcal{C}}^n$ and let $\xi : \mathcal{C} \rightarrow \mathbb{R}^{\geq 0}$, $r : \mathcal{C} \rightarrow \mathbb{R}^{\geq 0}$, and $\nu : \mathcal{C} \rightarrow \mathbb{N}$ be as in Lemma 9.9. The set $\vec{A}_{\mathcal{C}}^{\bullet}$ defined by the condition

$$\vec{A}_{\mathcal{C}}^{\bullet}(c) = \bigsqcup_{n>\bar{\nu}(c)} \vec{A}_{\mathcal{C}}^n(c) \cup (A_{\mathcal{C}}^{\bar{\nu}(c)} \cap (c + [0, \bar{r}(c)])) \quad \text{for all } c \in \mathcal{C}$$

is said to be the **positive ξ -copious arrival set**. The **positive ξ -copious departure set** is given by $\vec{D}_{\mathcal{C}}^{\bullet} = \tau_{\mathcal{C}}(\vec{A}_{\mathcal{C}}^{\bullet})$. The definitions of the **negative ξ -copious arrival** and **departure sets** use the partition $\vec{A}_{\mathcal{C}} = \bigsqcup_n \vec{A}_{\mathcal{C}}^n$ of the negative arrival set and are analogous.

Copious sets maximize measure $\lambda_c^{\mathcal{C}}$ of their saturation under the action of T . In other words, among all subsets $A' \subseteq \vec{A}_{\mathcal{C}}$ for which $\lambda_c^{\mathcal{C}}(A') = \xi(c)$, the measure $\lambda_c^{\mathcal{C}}([A']_{E_T})$ is maximal when $A'(c) = \vec{A}_{\mathcal{C}}^{\bullet}(c)$. In particular, if $\lambda_c^{\mathcal{C}}(\vec{A}_{\mathcal{C}}^{\bullet})$ is close to $\lambda_c^{\mathcal{C}}(\vec{A}_{\mathcal{C}})$, then we expect $\lambda_c^{\mathcal{C}}([\vec{A}_{\mathcal{C}}^{\bullet}]_{E_T})$ to be close to $\lambda_c^{\mathcal{C}}([\vec{A}_{\mathcal{C}}]_{E_T})$. The following lemma quantifies this intuition.

LEMMA 9.11. *Let $\xi : \mathcal{C} \rightarrow \mathbb{R}^{\geq 0}$ be such that $\xi(c) \leq \lambda_c^{\mathcal{C}}(\vec{A}_{\mathcal{C}})$ for all $c \in \mathcal{C}$, and let $\vec{A}_{\mathcal{C}}^{\bullet}$ be the ξ -copious arrival set constructed in Lemma 9.9. If there exists $1/2 > \delta > 0$ such that $\xi(c) \geq (1 - \delta)\lambda_c^{\mathcal{C}}(\vec{A}_{\mathcal{C}})$ for all $c \in \mathcal{C}$, then*

$$\lambda_c^{\mathcal{C}}([\vec{A}_{\mathcal{C}}(c) \setminus \vec{A}_{\mathcal{C}}^{\bullet}(c)]_{E_T}) \leq \frac{\delta}{1 - \delta} \lambda_c^{\mathcal{C}}(\vec{X}) \quad \text{for all } c \in \mathcal{C},$$

and therefore also $\mu([\vec{A}_{\mathcal{C}} \setminus \vec{A}_{\mathcal{C}}^{\bullet}]_{E_T}) \leq \frac{\delta}{1 - \delta} \mu(\vec{X})$.

An analogous statement is valid for the negative arrival set $\vec{A}_{\mathcal{C}}$.

PROOF. Let ν be as in Lemma 9.9 and note that

$$\bigsqcup_{k>\nu(c)} \vec{A}_{\mathcal{C}}^k(c) \subseteq \vec{A}_{\mathcal{C}}^{\bullet}(c) \subseteq \bigsqcup_{k \geq \nu(c)} \vec{A}_{\mathcal{C}}^k(c)$$

whenever $c \in \mathcal{C}$ satisfies $\xi(c) > 0$. Recall that for $x \in \vec{A}_{\mathcal{C}}^n$ we have $x E_{\mathcal{C}} T^k$ for all $0 \leq k \leq n$ and sets $T^k(\vec{A}_{\mathcal{C}}^n)$ are pairwise disjoint. In particular,

$$\begin{aligned} \lambda_c^{\mathcal{C}}(\vec{X}) &\geq \lambda_c^{\mathcal{C}}([\bigsqcup_{k \geq \nu(c)} \vec{A}_{\mathcal{C}}^k(c)]_{E_T}) \geq (\nu(c) + 1) \lambda_c^{\mathcal{C}}(\bigsqcup_{k \geq \nu(c)} \vec{A}_{\mathcal{C}}^k(c)) \\ (9.1) \quad &\geq (\nu(c) + 1) \lambda_c^{\mathcal{C}}(\vec{A}_{\mathcal{C}}^{\bullet}) = (\nu(c) + 1) \xi(c). \end{aligned}$$

Note also that $\xi(c) \geq (1 - \delta)\lambda_c^{\mathcal{C}}(\vec{A}_{\mathcal{C}})$ implies

$$(9.2) \quad \lambda_c^{\mathcal{C}}(\vec{A}_{\mathcal{C}} \setminus \vec{A}_{\mathcal{C}}^{\bullet}) \leq \xi(c) \delta / (1 - \delta).$$

For any $c \in \mathcal{C}$ we have

$$\begin{aligned}
\lambda_c^{\mathcal{C}}([\vec{A}_{\mathcal{C}}(c) \setminus \vec{A}_{\mathcal{C}}^{\bullet}(c)]_{E_T}) &\leq \lambda_c^{\mathcal{C}}(\{T^k x : x \in \vec{A}_{\mathcal{C}}(c) \setminus \vec{A}_{\mathcal{C}}^{\bullet}(c), 0 \leq k \leq \bar{\nu}(c)\}) \\
&\leq (\bar{\nu}(c) + 1) \lambda_c^{\mathcal{C}}(\vec{A}_{\mathcal{C}} \setminus \vec{A}_{\mathcal{C}}^{\bullet}) \\
&\because (9.2) \leq (\bar{\nu}(c) + 1) \bar{\xi}(c) \delta / (1 - \delta) \\
&\because (9.1) \leq \lambda_c^{\mathcal{C}}(\vec{X}) \delta / (1 - \delta).
\end{aligned}$$

The inequality for the measure μ follows by disintegrating μ into $\int_{\mathcal{C}} \lambda_c^{\mathcal{C}}(\cdot)$.

The argument for the negative arrival set is completely analogous. \square

9.3. Coherent modifications

We remind the reader that our goal is to show that any dissipative transformation $T \in [\mathbb{R} \curvearrowright X]_1$ of index $\mathcal{I}(T) = 0$ can be approximated by periodic transformations. One approach to “loop” the orbits of T is by mapping $\vec{D}_{\mathcal{C}}(c)$ to $\vec{A}_{\mathcal{C}}(c)$ and $\vec{D}_{\mathcal{C}}(c)$ to $\vec{A}_{\mathcal{C}}(c)$ (cf. Figure 9.6). For such a modification to work, measures $\lambda_c^{\mathcal{C}}(\vec{D}_{\mathcal{C}}(c))$ and $\lambda_c^{\mathcal{C}}(\vec{A}_{\mathcal{C}}(c))$ have to be equal. Recall that $\mathcal{I}(T) = 0$ implies that for almost every $c \in \mathcal{C}$, the measure of points x such that $x \leq c < Tx$ equals the measure of those y for which $Ty < c \leq y$. If one could guarantee that $T(\vec{D}_{\mathcal{C}}(c)) = \vec{A}_{\mathcal{C}}(\sigma_{\mathcal{C}}(c))$, then the aforementioned modification would indeed work. In the case of \mathbb{Z} actions, discreteness of the acting group allows one to find a cross-section \mathcal{C} for which this condition does hold. Whereas for the flows, we have to deal with the possibility that $T(\vec{D}_{\mathcal{C}}(c))$ can be “scattered” (see Figure 9.4) along the orbit and be unbounded, which is the key reason for the increased complexity compared to the argument for \mathbb{Z} actions.

Since we can’t hope to “loop” all the orbits of T , we will do the next best thing, and apply the modification of Figure 9.6 on “most” orbits as measured by $\lambda_c^{\mathcal{C}}$. Copious sets discussed in Section 9.2 have large saturations under T , but, generally speaking, fail to satisfy $T(\vec{D}_{\mathcal{C}}^{\bullet}(c)) = \vec{A}_{\mathcal{C}}^{\bullet}(\sigma_{\mathcal{C}}(c))$ for the same reason as do the sets $\vec{D}_{\mathcal{C}}(c)$. Our plan is to use the “ ϵ of room” provided by the difference $\vec{D}_{\mathcal{C}}(c) \setminus \vec{D}_{\mathcal{C}}^{\bullet}(c)$ in order to modify T into some T' with the same arrival and departure sets as T , but for which also $T'(\vec{D}_{\mathcal{C}}^{\bullet}(c)) = \vec{A}_{\mathcal{C}}^{\bullet}(\sigma_{\mathcal{C}}(c))$ holds. In this section, we describe two abstract modifications of dissipative transformations, and the approximation strategy outlined above will later be implemented in Section 9.4.

Since we are about to consider arrival and departure sets of different transformations, we use the notation $\vec{A}_{\mathcal{C}}[U]$ to denote the positive arrival set constructed for a transformation U ; likewise for negative arrival and departure sets, etc.

LEMMA 9.12. *Let ϕ and ϕ' be measure-preserving transformations on X subject to the following conditions:*

- (1) $\text{supp}(\phi) \subseteq D_{\mathcal{C}}$, $\text{supp}(\phi') \subseteq A_{\mathcal{C}}$;
- (2) $\phi(\vec{D}_{\mathcal{C}}) = \vec{D}_{\mathcal{C}}$, $\phi(\vec{D}_{\mathcal{C}}) = \vec{D}_{\mathcal{C}}$, and $\phi'(\vec{A}_{\mathcal{C}}) = \vec{A}_{\mathcal{C}}$, $\phi'(\vec{A}_{\mathcal{C}}) = \vec{A}_{\mathcal{C}}$;
- (3) $x E_{\mathcal{C}} \phi(x)$ and $x E_{\mathcal{C}} \phi'(x)$ for all $x \in \text{supp } T$.

The transformation $Ux = \phi' T \phi(x)$ is monotone, $Ux = Tx$ for all $x \notin D_{\mathcal{C}}$, and the sets $D_{\mathcal{C}}$, $A_{\mathcal{C}}$ remain the same:

$$\begin{aligned}
\vec{X}[U] &= \vec{X} & \vec{X}[U] &= \vec{X}, \\
\vec{D}_{\mathcal{C}}[U] &= \vec{D}_{\mathcal{C}} & \vec{D}_{\mathcal{C}}[U] &= \vec{D}_{\mathcal{C}},
\end{aligned}$$

$$\vec{A}_C[U] = \vec{A}_C \qquad \vec{A}_C[U] = \vec{A}_C.$$

Moreover, the integral of lengths of “departing arcs” remains unchanged:

$$\int_{D_c} |\rho_U| d\mu = \int_{D_c} |\rho_T| d\mu,$$

and the following estimate on $\int_X D(Tx, Ux) d\mu(x)$ is available:

$$\int_X D(Tx, Ux) d\mu(x) \leq 2 \int_{D_c} |\rho_T(x)| d\mu(x).$$

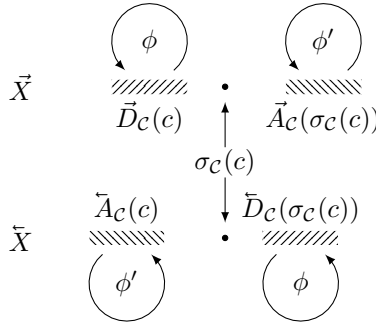

FIGURE 9.2. The transformation $U = \phi' T \phi$ defined in Lemma 9.12.

PROOF. Figure 9.2 illustrates the definition of the transformation U . Equality of the arrival and departure sets is straightforward to verify. Note that $\phi(\vec{D}_C(c)) = \vec{D}_C(c)$ for all $c \in \mathcal{C}$, and therefore $\int_{\vec{D}_C} \rho_\phi d\mu = 0$. In fact, the following four integrals vanish:

$$(9.3) \quad \int_{\vec{D}_C} \rho_\phi d\mu = \int_{\vec{D}_C} \rho_\phi d\mu = \int_{\vec{A}_C} \rho_{\phi'} d\mu = \int_{\vec{A}_C} \rho_{\phi'} d\mu = 0.$$

Observe that ρ_U is positive on \vec{D}_C and negative on \vec{D}_C , thus

$$\begin{aligned} \int_{D_c} |\rho_U| d\mu &= \int_{\vec{D}_C} \rho_{\phi' T \phi} d\mu - \int_{\vec{D}_C} \rho_{\phi' T \phi} d\mu \\ \because \text{cocycle identity} &= \int_{\vec{D}_C} \rho_\phi d\mu(x) + \int_{\vec{D}_C} \rho_T(\phi(x)) d\mu(x) + \int_{\vec{D}_C} \rho_{\phi'}(T\phi(x)) d\mu(x) \\ &\quad - \int_{\vec{D}_C} \rho_\phi d\mu - \int_{\vec{D}_C} \rho_T(\phi(x)) d\mu(x) - \int_{\vec{D}_C} \rho_{\phi'}(T\phi(x)) d\mu(x) \\ &= \int_{\vec{D}_C} \rho_\phi d\mu + \int_{\vec{D}_C} \rho_T d\mu + \int_{\vec{A}_C} \rho_{\phi'} d\mu \\ &\quad - \int_{\vec{D}_C} \rho_\phi d\mu - \int_{\vec{D}_C} \rho_T d\mu - \int_{\vec{A}_C} \rho_{\phi'} d\mu \\ \therefore \text{Eq. (9.3)} &= \int_{\vec{D}_C} \rho_T d\mu - \int_{\vec{D}_C} \rho_T d\mu = \int_{D_c} |\rho_T| d\mu. \end{aligned}$$

Finally, note that for any $x \in D_C$, the arc from x to Tx intersects the arc from $T^{-1}\phi'T\phi(x)$ to $\phi'T\phi(x)$ (both arcs go over the same point of \mathcal{C}), and therefore

$$D(Tx, Ux) \leq |\rho_T(x)| + |\rho_T(T^{-1}\phi'T\phi(x))|.$$

Integration over D_C yields

$$\int_X D(Tx, Ux) d\mu(x) = \int_{D_C} D(Tx, Ux) d\mu(x) \leq 2 \int_{D_C} |\rho_T(x)| d\mu(x). \quad \square$$

LEMMA 9.13. *Let $T \in [\mathbb{R} \curvearrowright X]_1$ be a monotone transformation, let $F \subseteq D_C$ be such that $\lambda_c^{\mathcal{C}}(\vec{F}) = \lambda_c^{\mathcal{C}}(\tilde{F})$ for all $c \in \mathcal{C}$ and the function $\mathcal{C} \ni c \mapsto \lambda_c^{\mathcal{C}}(F)$ is E -invariant (i.e., $\lambda_c^{\mathcal{C}}(F) = \lambda_{c'}(F)$ whenever c and c' belong to the same orbit of the flow). Let $Z \subseteq A_C$ be the arrival subset that corresponds to F , i.e., $Z = T(F)$. Let $\psi : \vec{F} \rightarrow \vec{Z}$ and $\psi' : \tilde{F} \rightarrow \tilde{Z}$ be any measure-preserving transformations such that $\psi(x)E_Cx$ and $\psi'(x)E_Cx$ for all x in the corresponding domains. Define $V : X \rightarrow X$ by the following formula:*

$$Vx = \begin{cases} \psi(x) & \text{if } x \in \vec{F}, \\ \psi'(x) & \text{if } x \in \tilde{F}, \\ Tx & \text{otherwise.} \end{cases}$$

The transformation V is a measure-preserving automorphism from the full group $[\mathbb{R} \curvearrowright X]$ and $Vx = Tx$ for all $x \notin F$. The integral of distances $D(Tx, Vx)$ can be estimated as follows:

$$\int_X D(Tx, Vx) d\mu(x) \leq 2 \int_{D_C} |\rho_T(x)| d\mu(x).$$

The following figure illustrates the notions of Lemma 9.13.

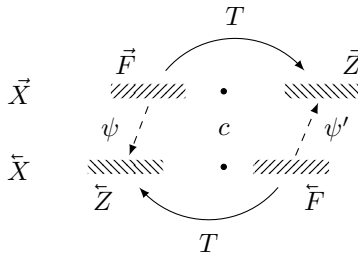

FIGURE 9.3. The transformation V defined in Lemma 9.13.

PROOF. It is straightforward to verify that V is a measure-preserving transformation. For the integral inequality note that for any $x \in \vec{F}$ one has

$$D(Tx, Vx) \leq |\rho_T(x)| + |\rho_T(T^{-1}x)|,$$

and therefore

$$\int_{\vec{F}} D(Tx, Vx) d\mu(x) \leq \int_{\vec{F}} |\rho_T| d\mu + \int_{\tilde{F}} |\rho_T| d\mu = \int_F |\rho_T| d\mu \leq \int_{D_C} |\rho_T| d\mu.$$

A similar inequality holds for $\int_{\tilde{F}} d(Tx, Vx) d\mu$, and the lemma follows. \square

9.4. Periodic approximations

We now have all the ingredients necessary to prove that monotone transformations can be approximated by periodic automorphisms. Our arguments follow the approach outlined at the beginning of Section 9.3.

In the following lemma, we assume that the Lebesgue measure of those $x \in \vec{X}$ that jump over any given $c \in \mathcal{C}$ is bounded from above by some β , and that most of such jumps — of measure at least γ — are between adjacent $E_{\mathcal{C}}$ -classes. We are going to construct a periodic approximation P of the transformation T with an explicit bound on $\int_X D(Tx, Px) d\mu(x)$, which can be made small for a sufficiently sparse cross-section \mathcal{C} . When the flow is ergodic, this lemma alone suffices to conclude that $T \in D([\mathbb{R} \curvearrowright X]_1)$. Theorem 9.15 builds upon Lemma 9.14 and treats the general case.

LEMMA 9.14. *Let $T \in [\mathbb{R} \curvearrowright X]_1$ be a monotone transformation, let $K > 0$ be a positive real, and let $J = \{x \in \text{supp } T : |\rho_T(x)| \geq K\}$. Let \mathcal{C} be a cross-section such that $\text{gap}_{\mathcal{C}}(c) > K$ for all $c \in \mathcal{C}$. Let $0 < \gamma < \beta$ be reals such that for all $c \in \mathcal{C}$:*

$$\begin{aligned} \lambda_{\mathcal{C}}^{\mathcal{C}}(\{x \in \vec{X} : x < \sigma_{\mathcal{C}}(c) \leq Tx, Tx E_{\mathcal{C}} \sigma_{\mathcal{C}}(c)\}) &> \gamma, \\ \lambda_{\mathcal{C}}^{\mathcal{C}}(\{x \in \vec{X} : Tx < c \leq x, Tx E_{\mathcal{C}} \sigma_{\mathcal{C}}^{-1}(c)\}) &> \gamma, \\ \lambda(\{x \in \vec{X} : x < \sigma_{\mathcal{C}}(c) \leq Tx\}) &< \beta, \\ \lambda(\{x \in \vec{X} : Tx < c \leq x\}) &< \beta. \end{aligned}$$

There exists a periodic transformation $P \in [\mathbb{R} \curvearrowright X]_1$ such that $\text{supp } P \subseteq \text{supp } T$ and

$$\int_X D(Tx, Px) d\mu(x) \leq 5 \int_{D_{\mathcal{C}}} |\rho_T| d\mu + \int_J |\rho_T| d\mu + \frac{K(\beta - \gamma)}{\gamma} \mu(\text{supp } T).$$

PROOF. Let $D_{\mathcal{C}}$ and $A_{\mathcal{C}}$ be the departure and the arrival sets of T . Figure 9.4 depicts the arrival $\vec{A}_{\mathcal{C}}(c)$ and the departure $\vec{D}_{\mathcal{C}}(c)$ sets for an element c of the cross-section \mathcal{C} . Note that preimages $T^{-1}(\vec{A}_{\mathcal{C}}(c))$ may come from different (possibly, infinitely many) $E_{\mathcal{C}}$ -equivalence classes; likewise, images $T(\vec{D}_{\mathcal{C}}(c))$ of the departure set may visit several $E_{\mathcal{C}}$ -equivalence classes.

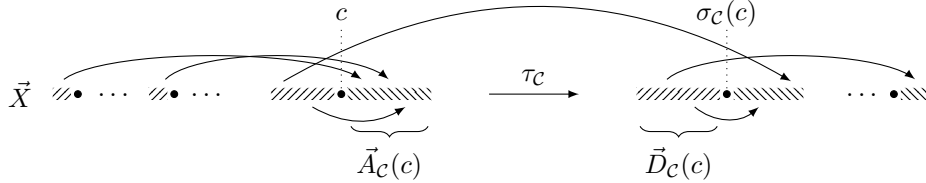

FIGURE 9.4. The arrival $\vec{A}_{\mathcal{C}}(c)$ and the departure $\vec{D}_{\mathcal{C}}(c)$ sets for some $c \in \mathcal{C}$.

Set $\xi(c) = \gamma$ to be the constant function; in view of the assumptions on γ , we may apply Lemma 9.9 to get positive and negative ξ -copious arrival sets $\vec{A}_{\mathcal{C}}^{\bullet} \subseteq A_{\mathcal{C}}$, $\vec{A}_{\mathcal{C}}^{\ominus} \subseteq A_{\mathcal{C}}$, as well as the corresponding departure sets $\vec{D}_{\mathcal{C}}^{\bullet} = \tau_{\mathcal{C}}(\vec{A}_{\mathcal{C}}^{\bullet})$ and $\vec{D}_{\mathcal{C}}^{\ominus} =$

$\tau_{\mathcal{C}}(\vec{A}_{\mathcal{C}}^{\bullet})$. Set $A_{\mathcal{C}}^{\bullet} = \vec{A}_{\mathcal{C}}^{\bullet} \sqcup \bar{A}_{\mathcal{C}}^{\bullet}$ and $D_{\mathcal{C}}^{\bullet} = \vec{D}_{\mathcal{C}}^{\bullet} \sqcup \bar{D}_{\mathcal{C}}^{\bullet}$. We have $\lambda(A_{\mathcal{C}}^{\bullet}(c)) = 2\gamma = \lambda(D_{\mathcal{C}}^{\bullet}(c))$ for all $c \in \mathcal{C}$. Let

$$\begin{aligned} A_{\mathcal{C}}^{\circ} &= \{x \in \vec{A}_{\mathcal{C}} : T^{-1}xE_{\mathcal{C}}\sigma_{\mathcal{C}}^{-1}(\pi_{\mathcal{C}}(x))\} \cup \{x \in \bar{A}_{\mathcal{C}} : T^{-1}xE_{\mathcal{C}}\sigma_{\mathcal{C}}(\pi_{\mathcal{C}}(x))\}, \\ D_{\mathcal{C}}^{\circ} &= \{x \in \vec{D}_{\mathcal{C}} : Tx E_{\mathcal{C}}\sigma_{\mathcal{C}}(\pi_{\mathcal{C}}(x))\} \cup \{x \in \bar{D}_{\mathcal{C}} : Tx E_{\mathcal{C}}\sigma_{\mathcal{C}}^{-1}(\pi_{\mathcal{C}}(x))\}, \end{aligned}$$

be the set of arcs that jump from/to the next $E_{\mathcal{C}}$ -equivalence class. By the assumptions of the lemma, we have $\lambda(\vec{D}_{\mathcal{C}}^{\circ}(c)) \geq \gamma$ and $\lambda(\bar{A}_{\mathcal{C}}^{\circ}(c)) \geq \gamma$ for all $c \in \mathcal{C}$. Let ϕ be any measure-preserving transformation such that:

- ϕ is supported on $D_{\mathcal{C}}$;
- $\phi(\vec{D}_{\mathcal{C}}) = \vec{D}_{\mathcal{C}}$ and $\phi(\bar{D}_{\mathcal{C}}) = \bar{D}_{\mathcal{C}}$;
- $\phi(x)E_{\mathcal{C}}x$ for all $x \in X$;

and moreover

$$(9.4) \quad \phi(D_{\mathcal{C}}^{\bullet}) \subseteq D_{\mathcal{C}}^{\circ}.$$

Select a transformation ϕ' such that

- ϕ' is supported on $A_{\mathcal{C}}$;
- $\phi'(\vec{A}_{\mathcal{C}}) = \vec{A}_{\mathcal{C}}$ and $\phi'(\bar{A}_{\mathcal{C}}) = \bar{A}_{\mathcal{C}}$;
- $\phi'(x)E_{\mathcal{C}}x$ for all $x \in X$;

and moreover

$$(9.5) \quad \phi'(T \circ \phi(D_{\mathcal{C}}^{\bullet})) = A_{\mathcal{C}}^{\bullet}.$$

Figure 9.5 illustrates these maps. Note that while in general $\tau_{\mathcal{C}}(\vec{A}^{\circ}(c)) \neq \vec{D}^{\circ}(c)$, one has $\tau_{\mathcal{C}}(\vec{A}^{\bullet}(c)) = \vec{D}^{\bullet}(c)$ for all $c \in \mathcal{C}$ by the definition of the ξ -copious departure set.

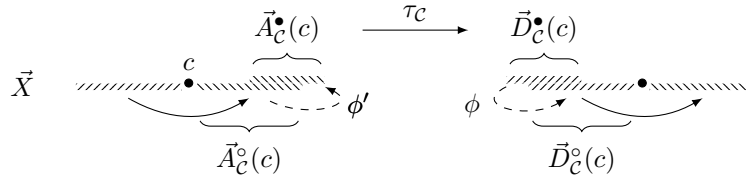

FIGURE 9.5. Automorphism ϕ maps $D_{\mathcal{C}}^{\bullet}(c)$ into $D_{\mathcal{C}}^{\circ}(c)$ and $(\phi')^{-1}$ sends $A_{\mathcal{C}}^{\bullet}(c)$ into $A_{\mathcal{C}}^{\circ}(c)$.

Let U be the transformation obtained by applying Lemma 9.12 to T , ϕ and ϕ' . The automorphism U satisfies $U(\vec{D}_{\mathcal{C}}^{\bullet}(c)) = \vec{A}_{\mathcal{C}}^{\bullet}(\sigma_{\mathcal{C}}(c))$ and $U(\bar{D}_{\mathcal{C}}^{\bullet}(c)) = \bar{A}_{\mathcal{C}}^{\bullet}(\sigma_{\mathcal{C}}^{-1}(c))$ for all $c \in \mathcal{C}$. Choose a measure-preserving transformation $\psi : \vec{D}_{\mathcal{C}}^{\bullet} \rightarrow \vec{A}_{\mathcal{C}}^{\bullet}$ such that $x E_{\mathcal{C}} \psi(x)$ for all x in the domain of ψ . Set $\psi' = \tau_{\mathcal{C}}^{-1} \circ \psi^{-1} \circ \tau_{\mathcal{C}}^{-1} : \bar{D}_{\mathcal{C}}^{\bullet} \rightarrow \bar{A}_{\mathcal{C}}^{\bullet}$. Let V be the transformation that is produced by Lemma 9.13 applied to U , ψ , and ψ' (see Figure 9.6). Finally, set $P : X \rightarrow X$ to be

$$Px = \begin{cases} Vx & \text{if } x \in [D_{\mathcal{C}}^{\bullet}]_{E_V}, \\ x & \text{otherwise.} \end{cases}$$

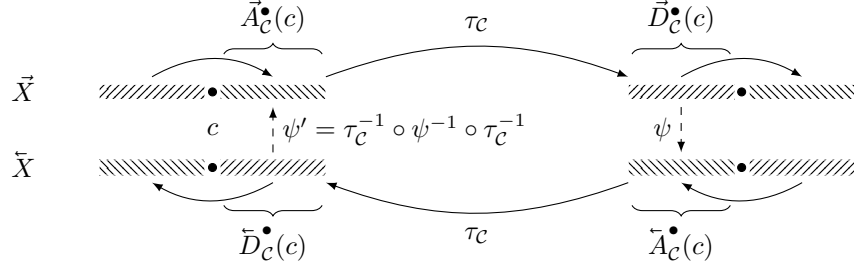

FIGURE 9.6. Construction of the automorphism V from U , ψ , and ψ' .

We claim that P satisfies the conclusions of the lemma. It is periodic, since the transformation $\psi' \circ \tau_C \circ \psi \circ \tau_C$ is the identity map and $\text{supp } P \subseteq \text{supp } T$ by construction. It remains to estimate $\int_X D(Tx, Px) d\mu(x)$.

$$\begin{aligned} \int_X D(Tx, Px) d\mu(x) &\leq \int_X D(Tx, Ux) d\mu(x) + \int_X D(Ux, Vx) d\mu(x) \\ &\quad + \int_X D(Vx, Px) d\mu(x) \\ &\leq [\text{Estimates of Lemma 9.12 and Lemma 9.13}] \\ &\leq 4 \int_{D_C} |\rho_T| d\mu + \int_X D(Vx, Px) d\mu(x). \end{aligned}$$

We concentrate on estimating $\int_X D(Vx, Px) d\mu(x)$. Recall that $Tx = Ux = Vx$ for all $x \notin D_C$, hence $\rho_T(x) = \rho_V(x)$ for $x \notin D_C$. Set $\Psi = (\vec{X} \cup \tilde{X}) \setminus [D_C^\bullet]_{E_V}$ and note that $Vx = Ux$ for $x \in \Psi$, and therefore using the conclusion of Lemma 9.12 we have

$$(9.6) \quad \int_{D_C \cap \Psi} |\rho_V| d\mu = \int_{D_C \cap \Psi} |\rho_U| d\mu \leq \int_{D_C} |\rho_U| d\mu = \int_{D_C} |\rho_T| d\mu.$$

The integral $\int_X D(Vx, Px) d\mu(x)$ can now be estimated as follows.

$$\begin{aligned} \int_X D(Vx, Px) d\mu(x) &= \int_{\Psi} |\rho_V| d\mu \\ &\leq \int_{\Psi \setminus D_C} |\rho_V| d\mu + \int_{D_C \cap \Psi} |\rho_V| d\mu \\ &\because Tx = Vx \text{ for } x \notin D_C \text{ and Eq. (9.6)} \leq \int_{\Psi \setminus D_C} |\rho_T| d\mu + \int_{D_C} |\rho_T| d\mu. \end{aligned}$$

Finally, we consider the integral $\int_{\Psi \setminus D_C} |\rho_T| d\mu$ and partition its domain $\Psi \setminus D_C$ as $(J \cap (\Psi \setminus D_C)) \sqcup ((\Psi \setminus D_C) \setminus J)$, which yields

$$\begin{aligned} \int_{\Psi \setminus D_C} |\rho_T| d\mu &\leq \int_J |\rho_T| d\mu + K\mu(\Psi) \\ &\leq \int_J |\rho_T| d\mu + \frac{K(\beta - \gamma)}{\gamma} \mu(\text{supp } T), \end{aligned}$$

where the last inequality follows from Lemma 9.11 with $\delta = 1 - \gamma/\beta$. Combining all the inequalities together, we get

$$\int_X D(Tx, Px) d\mu(x) \leq 5 \int_{D_c} |\rho_T| d\mu + \int_J |\rho_T| d\mu + \frac{K(\beta - \gamma)}{\gamma} \mu(\text{supp } T). \quad \square$$

Lemma 9.14 allows us to approximate with a periodic transformation a monotone T for which the Lebesgue measure of points jumping over any given $c \in X$ is roughly constant across orbits. To deal with the general case, we simply need to split the phase space X into countably many segments invariant under the flow, and apply Lemma 9.14 on each of them separately. Small care needs to be taken to ensure that values $(\beta - \gamma)/\gamma$, which appear in the formulation of Lemma 9.14, remain uniformly small across the partition of X . Details are presented in the following theorem.

THEOREM 9.15. *Let $T \in [\mathbb{R} \curvearrowright X]_1$ be a monotone transformation that belongs to the kernel of the index map, hence*

$$\lambda(\{x \in \text{supp } T : x < c \leq Tx\}) = \lambda(\{y \in \text{supp } T : Ty < c \leq y\})$$

for almost all $c \in X$. For any $\epsilon > 0$ there exists a periodic transformation $P \in [\mathbb{R} \curvearrowright X]_1$ such that $\text{supp } P \subseteq \text{supp } T$ and $\int_X D(Tx, Px) d\mu(x) < \epsilon$.

PROOF. Let $K_\epsilon \geq 1$ be such that for the set

$$J_\epsilon = \{x \in \text{supp } T : |\rho_T(x)| \geq K_\epsilon\}$$

one has $\int_{J_\epsilon} |\rho_T| d\mu < \epsilon/18$. Pick a cross-section \mathcal{C} with gaps so large that

$$2K_\epsilon^2/\text{gap}(c) < \epsilon/15$$

for all $c \in \mathcal{C}$, which ensures

$$(9.7) \quad K_\epsilon \cdot \mu(D_{\mathcal{C}} \setminus J_\epsilon) \leq \epsilon/15.$$

Note also that Eq. (9.7) holds for any cross-section $\mathcal{C}' \subseteq \mathcal{C}$, since $D_{\mathcal{C}'} \subseteq D_{\mathcal{C}}$ and $\text{gap}_{\mathcal{C}'}(c) \geq \text{gap}_{\mathcal{C}}(c)$ for all $c \in \mathcal{C}'$.

For any positive real $\alpha > 0$ there exists a positive $\delta(\alpha) = \delta > 0$ so small that $\delta < \alpha$ and $2\delta/(\alpha - \delta) < \epsilon/3K_\epsilon$. We may therefore pick countably many positive reals $\alpha_n > 0$, $n \geq 1$, such that $\mathbb{R}^{>0} = \bigcup_n (\alpha_n - \delta_n/2, \alpha_n + \delta_n/2)$ and

$$(9.8) \quad \left(\frac{2\delta_n}{\alpha_n - \delta_n} \right) < \frac{\epsilon}{3K_\epsilon} \quad \forall n \geq 1.$$

Define intervals $I_n = (\alpha_n - \delta_n/2, \alpha_n + \delta_n/2)$, $n \geq 1$.

Let $\zeta : \mathcal{C} \rightarrow \mathbb{R}^{\geq 0}$ be the map that measures the set of forward arcs over its argument:

$$\zeta(c) = \lambda(\{x \in \vec{X} : x < c \leq Tx\}).$$

Set $\mathcal{C}_1 = \zeta^{-1}(I_1)$ and construct inductively $\mathcal{C}_n = \zeta^{-1}(I_n) \setminus [\bigcup_{k < n} \mathcal{C}_k]_E$. Sets \mathcal{C}_n are pairwise disjoint, and moreover, $-c_1 E c_2$ for all $c_1 \in \mathcal{C}_{n_1}$, $c_2 \in \mathcal{C}_{n_2}$, $n_1 \neq n_2$. Let $\chi_n : \mathcal{C}_n \rightarrow \mathbb{N}$, $n \geq 1$, be the function defined by

$$\chi_n(c) = \min \left\{ m \in \mathbb{N} : \lambda(\{x \in \vec{X} : x < c \leq Tx, D(x, c) \leq m, D(Tx, c) \leq m\}) > \zeta(c) - \delta_n/2 \right\}.$$

Set $\mathcal{C}'_{n,1} = \chi_n^{-1}(1)$ and define inductively $\mathcal{C}'_{n,m} = \chi^{-1}(m) \setminus [\bigcup_{k < m} \mathcal{C}'_{n,k}]_E$. Let $X_{n,m}$ denote the saturated set $[\mathcal{C}'_{n,m}]_E$. Finally, for all $m, n \geq 1$, let $\mathcal{C}_{n,m} \subseteq \mathcal{C}'_{n,m}$ be such that $\text{gap}_{\mathcal{C}_{n,m}}(c) > m$ for all $c \in \mathcal{C}_{n,m}$. Sets $\mathcal{C}_{n,m}$ and $X_{n,m}$ satisfy the following conditions:

- (1) $\mathcal{C}_{n,m}$ is a cross-section for the restriction of the flow onto $X_{n,m}$;
- (2) sets $X_{n,m}$, $m, n \geq 1$, are pairwise disjoint.
- (3) $\zeta(c) \in I_n$ and $\lambda_c^{\mathcal{C}}(\{x \in \vec{X} : x < \sigma_{\mathcal{C}_{n,m}}(c) \leq Tx\}) > \alpha_n - \delta_n$ for all $c \in \mathcal{C}_{n,m}$.

Let $T_{n,m}$ denote the restriction of T onto $X_{n,m}$. Apply Lemma 9.14 to the transformation $T_{n,m}$, cross-section $\mathcal{C}_{n,m}$, which has gaps at least K_ϵ , and $\beta = \alpha_n + \delta_n$, $\gamma = \alpha_n - \delta_n$. Let $P_{n,m}$ be the resulting periodic transformation on $X_{n,m}$. Set $P = \bigsqcup_{n,m} P_{n,m}$. We claim that P satisfies conclusions of the theorem. Set $\mathcal{C}' = \bigsqcup_{n,m} \mathcal{C}_{n,m}$ and note that $\mathcal{C}' \subseteq \mathcal{C}$, whence $D_{\mathcal{C}'} \subseteq D_{\mathcal{C}}$.

$$\begin{aligned} \int_X D(Tx, Px) d\mu(x) &= \sum_{n,m} \int_{X_{n,m}} D(T_{n,m}x, P_{n,m}x) d\mu(x) \\ &\because \text{Lemma 9.14} \leq 5 \sum_{n,m} \int_{D_{\mathcal{C}_{n,m}}} |\rho_T| d\mu + \sum_{n,m} \int_{J_\epsilon \cap X_{n,m}} |\rho_T| d\mu \\ &\quad + \sum_{n,m} K_\epsilon \left(\frac{2\delta_n}{\alpha_n - \delta_n} \right) \mu(X_{n,m}) \\ &\because \text{Eq. (9.8)} \leq 5 \int_{D_{\mathcal{C}}} |\rho_T| d\mu + \int_{J_\epsilon} |\rho_T| d\mu + (\epsilon/3)\mu(X) \\ &\leq 5 \int_{D_{\mathcal{C}} \setminus J_\epsilon} |\rho_T| d\mu + 6 \int_{J_\epsilon} |\rho_T| d\mu + \epsilon/3 \\ &\because \text{choice of } K_\epsilon < 5K_\epsilon\mu(D_{\mathcal{C}} \setminus J_\epsilon) + \epsilon/3 + \epsilon/3 \\ &\because \text{Eq. (9.7)} \leq \epsilon, \end{aligned}$$

and the theorem follows. \square

COROLLARY 9.16. *Let $\mathbb{R} \curvearrowright X$ be a measure-preserving flow and $T \in [\mathbb{R} \curvearrowright X]_1$ be a dissipative transformation. If $\mathcal{I}(T) = 0$, then $T \in D([\mathbb{R} \curvearrowright X]_1)$.*

PROOF. By Corollary 9.8, there is a monotone transformation U and a periodic transformation P such that $T = U \circ P$. Since $P \in D([\mathbb{R} \curvearrowright X]_1)$ by Corollary 3.15, it remains to show that U belongs to the derived subgroup. The latter follows from Theorem 9.15, since $\mathcal{I}(U) = \mathcal{I}(T) - \mathcal{I}(P) = 0$. \square

CHAPTER 10

Conclusions

Our objective in this last chapter is to draw several conclusions regarding the structure of the L^1 full groups of measure-preserving flows. The analysis conducted in Chapters 8 and 9 leads to the most technically challenging result of our work, which is the following theorem.

THEOREM 10.1. *Let $\mathcal{F} : \mathbb{R} \curvearrowright X$ be a free measure-preserving flow on a standard probability space. The kernel of the index map coincides with the closed derived subgroup $D([\mathcal{F}]_1)$.*

PROOF. Inclusion $D([\mathcal{F}]_1) \subseteq \ker \mathcal{I}$ is automatic since the image of \mathcal{I} is abelian. For the other direction, pick a transformation $T \in \ker \mathcal{I}$ and consider its Hopf's decomposition $X = C \sqcup D$ provided by Proposition 4.16. We have $T = T_C \circ T_D$, where $T_C \in [\mathcal{F}]_1$ is conservative and $T_D \in [\mathcal{F}]_1$ is dissipative. According to Corollary 8.8, $\mathcal{I}(T_C) = 0$ and $T_C \in D([\mathcal{F}]_1)$, whence $\mathcal{I}(T_D) = \mathcal{I}(T) - \mathcal{I}(T_C) = 0$. Therefore, the dissipative part T_D satisfies the assumptions of Corollary 9.16, which yields $T_D \in D([\mathcal{F}]_1)$, and hence $T \in D([\mathcal{F}]_1)$ as desired. \square

10.1. Topological ranks of L^1 full groups

Empowered with the result above and Corollary 5.20, we can estimate the topological ranks of L^1 full groups of flows. We recall the following well-known inequalities.

PROPOSITION 10.2. *Let $\phi : G \rightarrow H$ be a surjective continuous homomorphism of Polish groups. The topological rank $\text{rk}(G)$ satisfies*

$$\text{rk}(H) \leq \text{rk}(G) \leq \text{rk}(H) + \text{rk}(\ker \phi).$$

PROPOSITION 10.3. *Let $\mathcal{F} : \mathbb{R} \curvearrowright X$ be a free measure-preserving flow on a standard probability space (X, μ) . The topological rank $\text{rk}([\mathcal{F}]_1)$ is finite if and only if the flow has finitely many ergodic components. Moreover, if \mathcal{F} has exactly n ergodic components then*

$$n + 1 \leq \text{rk}([\mathcal{F}]_1) \leq n + 3.$$

PROOF. Let \mathcal{E} be the space of probability invariant ergodic measures of the flow, and let p be the probability measure on \mathcal{E} such that $\mu = \int_{\mathcal{E}} \nu dp(\nu)$ (see Appendix C.3). Proposition 6.6 shows that the index map $\mathcal{I} : [\mathcal{F}]_1 \rightarrow L^1(\mathcal{E}, p)$ is continuous and surjective. An application of Proposition 10.2 yields

$$(10.1) \quad \text{rk}(L^1(\mathcal{E}, p)) \leq \text{rk}([\mathcal{F}]_1) \leq \text{rk}(L^1(\mathcal{E}, p)) + \text{rk}(\ker \mathcal{I}) = \text{rk}(L^1(\mathcal{E}, p)) + 2.$$

where the last equality is based on Theorem 10.1 and Corollary 5.20. Since $L^1(\mathcal{E}, \nu)$ is a Banach space, its topological rank is finite if and only if its dimension is finite, which is equivalent to (\mathcal{E}, p) being purely atomic with finitely many atoms. We have

shown that $\text{rk}([\mathcal{F}]_1)$ is finite if and only if the flow has only finitely many ergodic components. The moreover part of the proposition follows from the inequality (10.1) and the observation that $\text{rk}(L^1(\mathcal{E}, p)) = \dim(L^1(\mathcal{E}, p)) + 1$. \square

As already mentioned in the introduction, we conjecture that the topological rank completely remembers the number of ergodic components.

CONJECTURE 10.4. *Let \mathcal{F} be a measure-preserving flow. If it has exactly n ergodic components, then $\text{rk}([\mathcal{F}]_1) = n + 1$.*

Provided the conjecture holds, we have a priori no way of distinguishing L^1 full groups of ergodic flows as topological groups. For \mathbb{Z} -actions, it is a consequence of Belinskaya's theorem that there are many L^1 full groups. The next two sections are devoted to analogues of her result for flows, yielding that there are many L^1 full groups of free ergodic flows, although we don't have a concrete way of distinguishing them (we will discuss in the last section their geometry, which might help there).

10.2. Katznelson's conjugation theorem

R. M. Belinskaja [Bel68] showed that if measure-preserving transformations $T, U \in \text{Aut}(X, \mu)$ generate the same orbit equivalence relation, i.e., $\mathcal{R}_T = \mathcal{R}_U$, and $U \in [T]_1$, then T and U are conjugated. Y. Katznelson found a different argument and isolated a sufficient condition for conjugacy of measure-preserving transformations (see [CJMT22, Theorem A.1]). In the following, for $T \in \text{Aut}(X, \mu)$, $x \in X$, and $A \subseteq \mathbb{Z}$ we let $T^A x$ denote the set $\{T^k x : k \in A\}$.

THEOREM 10.5 (Katznelson). *Suppose $T, U \in \text{Aut}(X, \mu)$ are measure-preserving transformations that generate the same orbit equivalence relation, $\mathcal{R}_T = \mathcal{R}_U$. If the symmetric difference $T^{\mathbb{N}}x \Delta U^{\mathbb{N}}x$ is finite for almost all x , then T and U are conjugated by an element from the full group $[T] = [U]$.*

The analog of this result for free measure-preserving flows will be proved shortly in Theorem 10.9. But first we discuss an important application of Theorem 10.5. Consider a free measure-preserving flow $\mathcal{F} : \mathbb{R} \curvearrowright X$. Given a dissipative transformation $T \in [\mathcal{F}]$ (in the sense of Definition 9.1), Proposition B.4 implies that almost every non-trivial T -orbit $[x]_{\mathcal{R}_T}$ is a discrete subset of $[x]_{\mathcal{R}}$ unbounded both from below and from above. The order induced on $[x]_{\mathcal{R}_T}$ by the flow may disagree with the T -order of points. One may therefore define the \mathcal{F} -reordering of T to be the first return transformation \tilde{T} induced by the ordering of the flow on the orbits of T :

$$\tilde{T}x = x + \min\{r > 0 : x + r \in [x]_{\mathcal{R}_T}\} \quad \text{for } x \in \text{supp } T.$$

Note that T and \tilde{T} generate the same orbit equivalence relation, $\mathcal{R}_T = \mathcal{R}_{\tilde{T}}$.

If T belongs to the L^1 full group of the flow, either $T^{\mathbb{N}}x \Delta \tilde{T}^{\mathbb{N}}x$ or $T^{\mathbb{N}}x \Delta \tilde{T}^{-\mathbb{N}}x$ is finite, depending on whether $\lim_n \rho(x, T^n x) = +\infty$ or $\lim_n \rho(x, T^n x) = -\infty$ (cf. Corollary 9.4). Which symmetric difference is finite may depend on the point $x \in X$, and Theorem 10.5 can be used to show that T and its reordering \tilde{T} are flip conjugated.

DEFINITION 10.6. Let (X_1, μ_1) and (X_2, μ_2) be standard probability spaces, and let $T_i \in \text{Aut}(X_i, \mu_i)$, $i = 1, 2$. Measure-preserving transformations T_1 and T_2 are **flip conjugate** if there exist an isomorphism of measure spaces $S : X_1 \rightarrow X_2$ and measurable partitions $X_1 = X_1^- \sqcup X_1^+$, $X_2 = X_2^- \sqcup X_2^+$ such that

- (1) $S(X_1^-) = X_2^-$ and $S(X_1^+) = X_2^+$;
- (2) X_1^-, X_1^+ are T_1 -invariant and X_2^-, X_2^+ are T_2 -invariant;
- (3) $ST_1 \upharpoonright_{X_1^+} S^{-1} = T_2 \upharpoonright_{X_2^+}$ and $ST_1 \upharpoonright_{X_1^-} S^{-1} = T_2^{-1} \upharpoonright_{X_2^-}$.

Note that when one of the T_i 's is ergodic, our definition of flip-conjugacy coincides with the standard one, which requires X_i^- or X_i^+ to have full measure.

PROPOSITION 10.7. *Any dissipative $T \in [\mathcal{F}]_1$ and its \mathcal{F} -reordering \tilde{T} are flip conjugated by an element from the full group $[T] = [\tilde{T}]$.*

PROOF. Consider the decomposition $\text{supp } T = \tilde{X} \sqcup \vec{X}$ into the positive and negative orbits as in Definition 9.5. In particular, $T^{\mathbb{N}}x \triangle \tilde{T}^{\mathbb{N}}x$ and $T^{\mathbb{N}}x \triangle \tilde{T}^{-\mathbb{N}}x$ are finite for $x \in \tilde{X}$ and $x \in \vec{X}$, respectively. Theorem 10.5 implies that there exist automorphisms $S_1 \in [T \upharpoonright_{\tilde{X}}]$ and $S_2 \in [T \upharpoonright_{\vec{X}}]$ such that $S_1 T \upharpoonright_{\tilde{X}} S_1^{-1} = \tilde{T} \upharpoonright_{\tilde{X}}$ and $S_2 T \upharpoonright_{\vec{X}} S_2^{-1} = \tilde{T}^{-1} \upharpoonright_{\vec{X}}$. The transformation S given by

$$Sx = \begin{cases} S_1 x & \text{if } x \in \tilde{X}, \\ S_2 x & \text{if } x \in \vec{X}, \\ x & \text{otherwise} \end{cases}$$

belongs to the full group $[T]$ and witnesses flip conjugacy of T and \tilde{T} . \square

The transformation conjugating T and U in Theorem 10.5 can be written fairly explicitly. This is done in terms of the function δ defined as follows. Suppose (Ω, λ) is a (possibly infinite) measure space, and let $A, B \subseteq \Omega$ be measurable sets such that $\lambda(A \triangle B) < +\infty$. We set $\delta(A, B) = \lambda(A \setminus B) - \lambda(B \setminus A)$. This function satisfies a few properties which the reader can easily verify.

PROPOSITION 10.8. *Suppose (Ω, λ) is a measure space. For all $A, B, C, a, \subseteq \Omega$ such that $\lambda(A \triangle B), \lambda(B \triangle C), \lambda(A \triangle C), \lambda(a) < +\infty$, the following holds:*

- (1) $\delta(A, C) = \delta(A, B) + \delta(B, C)$;
- (2) $\delta(A, A) = 0$ and $\delta(A, B) = -\delta(B, A)$;
- (3) $\delta(A \triangle a, B) = \delta(A, B) + (\lambda(a) - 2\lambda(a \cap A))$.

Any orbit of a measure-preserving transformation can be endowed with a counting measure. Given T and U as in the statement of Theorem 10.5, set $\tau(x) = \delta(U^{\mathbb{N}}x, T^{\mathbb{N}}x)$ and define $Sx = U^{\tau(x)}x$. One can verify that $S \in [U] = [T]$ and $STS^{-1} = U$ (further details can be found in [CJMT22, Theorem A.1]).

Let now \mathcal{F}_1 and \mathcal{F}_2 be measure-preserving flows on a standard probability space (X, μ) ; we denote the actions of $r \in \mathbb{R}$ upon $x \in X$ by $x +_1 r$ and $x +_2 r$, respectively. Suppose that their full groups coincide, $[\mathcal{F}_1] = [\mathcal{F}_2]$, and so the flows share the same orbits, $\mathcal{R}_{\mathcal{F}_1} = \mathcal{R}_{\mathcal{F}_2}$. For $x \in X$, let $s_i(x) = x +_i [0, \infty)$, $i = 1, 2$, denote the ‘‘right half-orbit’’ of x . A natural analog of the condition $|T^{\mathbb{N}}x \triangle U^{\mathbb{N}}x| < \infty$ from Theorem 10.5 would be to require finiteness of the Lebesgue measure of $s_1(x) \triangle s_2(x)$ for all $x \in X$. This condition alone, however, is not sufficient for conjugacy of \mathcal{F}_1 and \mathcal{F}_2 .

Each flow induces a copy of the Lebesgue measure onto orbits via

$$\lambda_{i,x}(A) = \lambda(\{r \in \mathbb{R} : x +_i r \in A\}).$$

Since we assume $[\mathcal{F}_1] = [\mathcal{F}_2]$, and so $\mathcal{F}_2 \subseteq [\mathcal{F}_1]$, $\lambda_{1,x}$ is a translation invariant measure relative to the action of \mathcal{F}_2 , and therefore must differ from $\lambda_{2,x}$ by a

constant: there is an orbit invariant measurable function $c : X \rightarrow \mathbb{R}^{>0}$ such that $\lambda_{2,x} = c(x)\lambda_{1,x}$. Any element in $[\mathcal{F}_1] = [\mathcal{F}_2]$ preserves $\lambda_{i,x}$, $i = 1, 2$, and therefore cannot conjugate \mathcal{F}_1 into \mathcal{F}_2 unless $c(x)$ is constantly equal to 1.

When the flows are ergodic, $c(x) = c$ is a constant, and one may renormalize the flows without changing the full groups. Let \mathcal{F}'_2 be the rescaling of \mathcal{F}_2 given by $x + \frac{1}{2}r = x +_2 cr$. It is straightforward to check that $\lambda'_{2,x}(A) = c^{-1}\lambda_{2,x}(A) = \lambda_{1,x}(A)$ and flows \mathcal{F}_1 and \mathcal{F}'_2 induce the same measure onto orbits.

For flows that do induce the same measures on the orbits, finiteness of the measure $s_1(x) \triangle s_2(x)$ for all $x \in X$ is indeed sufficient to conclude conjugacy of the flows.

THEOREM 10.9. *Let \mathcal{F}_i , $i = 1, 2$, be free measure-preserving flows that share the same orbits, $\mathcal{R}_{\mathcal{F}_1} = \mathcal{R}_{\mathcal{F}_2}$, and induce the same measures $(\lambda_x)_{x \in X}$ onto orbit. If $\lambda_x(s_1(x) \triangle s_2(x)) < +\infty$ for $x \in X$, then the flows are conjugate by a measure-preserving transformation $S \in [\mathcal{F}_1]$.*

PROOF. Let $n : X \times \mathbb{R} \rightarrow \mathbb{R}$ be the $\mathcal{F}_1, \mathcal{F}_2$ -cocycle defined by $x +_2 r = x +_1 n(x, r)$. Since \mathcal{F}_1 and \mathcal{F}_2 induce the same measure on the orbits, $n(x, \cdot) : \mathbb{R} \rightarrow \mathbb{R}$ is a Lebesgue measure-preserving automorphism:

$$\begin{aligned} \lambda(n(x, A)) &= \lambda_{1,x}(\{x +_1 n(x, r) : r \in A\}) \\ &= \lambda_{2,x}(\{x +_2 r : r \in A\}) = \lambda(A). \end{aligned}$$

For $x \in X$ and $r \in \mathbb{R} \cup \{+\infty\}$ let

$$s_{i,r}(x) = \begin{cases} x +_i [0, r) & \text{if } r \geq 0, \\ x +_i [r, 0) & \text{if } r < 0. \end{cases}$$

In particular, $s_i(x) = s_{i,+\infty}(x)$. Note that

$$(10.2) \quad \begin{aligned} s_1(x +_2 r) &= s_1(x) \triangle s_{1,n(x,r)}(x), \\ s_2(x +_2 r) &= s_2(x) \triangle s_{2,r}(x). \end{aligned}$$

Also, considering the cases $r < 0$ and $r \geq 0$ separately, one can easily verify that for all $r \in \mathbb{R}$ and $i = 1, 2$

$$\lambda_{i,x}(s_{i,r}(x)) - 2\lambda_{i,x}(s_2(x) \cap s_{2,r}(x)) = -r.$$

and, in particular,

$$(10.3) \quad \begin{aligned} \lambda_{1,x}(s_{1,n(x,r)}(x)) - 2\lambda_{1,x}(s_1(x) \cap s_{1,n(x,r)}(x)) &= -n(x, r), \\ \lambda_{2,x}(s_{2,r}(x)) - 2\lambda_{2,x}(s_2(x) \cap s_{2,r}(x)) &= -r. \end{aligned}$$

Put $\tau(x) = \delta(s_1(x), s_2(x))$, then

$$(10.4) \quad \begin{aligned} &\tau(x +_2 r) = \delta(s_1(x +_2 r), s_2(x +_2 r)) \\ &\cdot \text{ Eq. (10.2)} = \delta(s_1(x) \triangle s_{1,n(x,r)}(x), s_2(x +_2 r)) \\ &\cdot \text{ Prop. 10.8} = \delta(s_1(x), s_2(x +_2 r)) + \\ &\quad \lambda_{1,x}(s_{1,n(x,r)}(x)) - 2\lambda_{1,x}(s_1(x) \cap s_{1,n(x,r)}(x)) \\ &\cdot \text{ Eq. (10.3)} = \delta(s_1(x), s_2(x +_2 r)) - n(x, r) \\ &\cdot \text{ Prop. 10.8} = -\delta(s_2(x +_2 r), s_1(x)) - n(x, r) = \delta(s_1(x), s_2(x +_2 r)) - \\ &\quad (\lambda_{2,x}(s_{2,r}(x)) - 2\lambda_{2,x}(s_2(x) \cap s_{2,r}(x))) - n(x, r) \\ &\cdot \text{ Eq. (10.3)} = \delta(s_1(x), s_2(x)) - n(x, r) + r. \end{aligned}$$

The required transformation $S : X \rightarrow X$ is given by $Sx = x +_1 \tau(x)$.

$$S(x +_2 r) = (x +_2 r) +_1 \tau(x +_2 r) = (x +_1 n(x, r)) +_1 \tau(x +_2 r)$$

$$\stackrel{\cdot}{=} \text{Eq. (10.4)} = x +_1 (n(x, r) + \tau(x) - n(x, r) + r) = Sx +_1 r.$$

Thus S conjugates \mathcal{F}_1 and \mathcal{F}_2 . It therefore remains to check that S is a measure-preserving bijection. First, note that Sx satisfies $\delta(s_1(Sx), s_2(x)) = 0$. Indeed, $s_1(Sx) = s_1(x) \triangle s_{1, \tau(x)}(x)$ (by the analog of Eq. (10.2)), and therefore

$$(10.5) \quad \delta(s_1(Sx), s_2(x)) = \tau(x) - \tau(x) = 0$$

by Proposition 10.8.

To show injectivity, suppose that $Sx = Sy$. In view of Eq. (10.5) and Proposition 10.8,

$$\delta(s_2(x), s_2(y)) = \delta(s_2(x), s_1(Sx)) + \delta(s_1(Sy), s_2(y)) = 0.$$

However, if $y = x +_2 r$, then $s_2(y) = s_2(x) \triangle s_{2, r}(x)$ and so $\delta(s_2(x), s_2(y)) = r$. One concludes that $r = 0$ and $x = y$. We have already established that $S(x +_2 r) = Sx +_1 r$, which shows that the range of S is orbit invariant, yielding surjectivity.

Finally, to show that S is measure-preserving, it suffices to check that S preserves the Lebesgue measure $\lambda_{1, x} = \lambda_{2, x}$ on all the orbits. To this end, let $n' : X \times \mathbb{R} \rightarrow \mathbb{R}$ be the \mathcal{F}_1 -cocycle (i.e., $x +_1 r = x +_2 n'(x, r)$). For all $r' \in \mathbb{R}$, one has

$$\begin{aligned} \lambda_{1, x}(Ss_{1, r'}(x)) &= \lambda_{1, x}(\{y +_1 \tau(y) : y \in s_{1, r'}(x)\}) \\ &= \lambda_{1, x}(\{(x +_1 r) +_1 \tau(x +_1 r) : 0 \leq r < r'\}) \\ &= \lambda(\{r + (\tau(x) - r + n'(x, r)) : 0 \leq r < r'\}) \\ &= \lambda(\{n'(x, r) : 0 \leq r < r'\}) = \lambda(n'(x, [0, r'])) = r', \end{aligned}$$

hence $S \in \text{Aut}(X, \mu)$ is the required conjugation between \mathcal{F}_1 and \mathcal{F}_2 . \square

In the \mathbb{Z} case, the above result is the key to Belinskaja's flip conjugacy result for L¹ orbit equivalence. Unfortunately, here we don't know if it can be useful towards proving an analogous result. In the next section, we nevertheless obtain a weaker result which yields that there are many L¹ full groups. We leave the following question open.

QUESTION 10.10. *Given two ergodic flows with equal L¹ full groups, do they have to satisfy the hypothesis of the above theorem after appropriate rescaling?*

10.3. L¹ orbit equivalence implies flip Kakutani equivalence

A measure-preserving action of a compactly generated locally compact Polish group can always be twisted by a continuous automorphism of the group without affecting the L¹ full group.

In the case of \mathbb{Z} -actions, this takes a particularly simple form, since the only non-trivial automorphism of \mathbb{Z} is given by $n \mapsto -n$. It follows from the results of R. M. Belinskaja [Bel68] that this is up to conjugacy the only way to get an L¹ orbit equivalence for ergodic \mathbb{Z} -actions [LM18, Theorem 4.2]: if T_1, T_2 are two ergodic measure-preserving transformations which are L¹ orbit equivalent, then they are flip-conjugate: T_1 is conjugate to either T_2 or T_2^{-1} .

As mentioned before, we do not know whether a variant of such rigidity holds when we replace \mathbb{Z} by \mathbb{R} (see Question 10.17 below), but, as shown in Theorem 10.15, L¹ orbit equivalent free measure-preserving flows must at least be flip Kakutani

equivalent. In particular, there are uncountably many L^1 full groups of free ergodic flows up to abstract group isomorphism.

Let us first define the notion of (flip) Kakutani equivalence of flows. For the main results about this concept, the reader may consults [Kat75, Kat77], where it is called **monotone equivalence** of flows. Given a measure-preserving automorphism $T \in \text{Aut}(Z, \nu)$ and a positive integrable function $f \in L^1(Z, \nu)$, one can define the so-called **suspension flow** or **flow under a function** of T on the space

$$X = \{(z, t) : z \in Z, 0 \leq t < f(z)\}$$

under the graph of f . For $r \geq 0$, the action $(z, t) + r$ is given by

$$(z, t) + r = (T^k z, t + r - \sum_{i=0}^{k-1} f(T^i z))$$

where $k \geq 0$ is defined uniquely by the condition $\sum_{i=0}^{k-1} f(T^i z) \leq t + r < \sum_{i=0}^k f(T^i z)$; similarly for $r \leq 0$ the action is

$$(z, t) + r = (T^{-k} z, t + r + \sum_{i=1}^k f(T^{-i} z)),$$

where $k \geq 0$ satisfies $0 \leq t + r + \sum_{i=1}^k f(T^{-i} z) < f(T^{-k} z)$. Such a flow preserves the restriction onto X of the product measure $\nu \times \lambda$. The space

$$(X, \mu), \text{ where } \mu = \frac{\nu \times \lambda}{\int_Z f d\nu} \upharpoonright_X$$

is a standard probability space. The automorphism T in the suspension flow construction is called the **base automorphism**.

DEFINITION 10.11. Two flows are **(flip) Kakutani equivalent** if they are isomorphic to suspension flows over flip conjugate base automorphisms.

It is important to note that the construction of suspension flows can be reversed through the use of cross-sections¹. If we have a fixed free flow on (X, μ) and $\mathcal{C} \subseteq X$ is a co-compact cross-section which is U -lacunary where U is precompact, then there is a unique probability measure ν on \mathcal{C} such that the map $U \times \mathcal{C} \rightarrow \mathcal{C} + U \subseteq X$ taking (t, c) to $c + t$ is measure-preserving (see e.g. [KPV15, Prop. 4.3] for the general construction). It is then clear that the first-return map $\sigma_{\mathcal{C}} : \mathcal{C} \rightarrow \mathcal{C}$ is measure-preserving, and our initial flow can be seen as the flow built under the gap function $\text{gap}_{\mathcal{C}}$ with base transformation $\sigma_{\mathcal{C}}$.

We need the following important result, which is due to D. Rudolph [Rud76]. Keeping in mind the previous paragraph, it can be reformulated as the fact that every measure-preserving flow is conjugate to a suspension flow over a two-valued function.

THEOREM 10.12 (Rudolph). *Let \mathcal{F} be a free measure-preserving flow on a standard probability space (X, μ) , let $t_0 \in \mathbb{R} \setminus \mathbb{Q}$, then \mathcal{F} admits a cross-section whose gap function only takes the values 1 and t_0 almost surely.*

¹In full generality, the definition of a cross-section should actually be relaxed, replacing lacunarity by discreteness in each orbit, and only requiring the gap function of the cross-section to be integrable.

REMARK 10.13. The second named author has obtained a generalization of this to the purely Borel context, see [Slu19].

THEOREM 10.14. *Let $\mathcal{F}, \mathcal{F}'$ be free measure-preserving flows on (X, μ) that share the same orbits, $\mathcal{R}_{\mathcal{F}} = \mathcal{R}_{\mathcal{F}'}$. If $\mathcal{F}' \leq [\mathcal{F}]_1$, then \mathcal{F} and \mathcal{F}' are flip Kakutani equivalent.*

PROOF. We denote the flow \mathcal{F} using our usual notation, $(x, t) \mapsto x + t$. As explained right after Definition 10.11, it suffices to find cross-sections for \mathcal{F} and \mathcal{F}' such that the corresponding first return automorphisms are flip conjugated.

Pick Borel realizations of the flows and let $\mathcal{C} \subseteq X$ be a Borel cross-section for \mathcal{F} such that $\text{gap}_{\mathcal{C}}(c) \in \{1, t_0\}$ for all $c \in \mathcal{C}$, as provided by Theorem 10.12. Define the automorphism $T : X \rightarrow X$ by

$$Tx = \begin{cases} \sigma_{\mathcal{C}}(c) + \alpha & \text{if } x = c + \alpha \text{ for some } c \in \mathcal{C}, \alpha \in [0, 1], \\ x & \text{otherwise.} \end{cases}$$

The transformation T is obtained by gluing together the identity map, $x \mapsto x + 1$ and $x \mapsto x + t_0$, and since all these belong to $[\mathcal{F}]_1$, which is finitely full, we have that $T \in [\mathcal{F}]_1$ as well. Note that T is dissipative and is therefore flip conjugated to its \mathcal{F}' -reordering \tilde{T} by Proposition 10.7. In other words, there is a T -invariant Borel set $Z \subseteq X$ of full measure, $\mu(Z) = 1$, and a T -invariant Borel partition $Z = Z^+ \sqcup Z^-$ such that $T \upharpoonright_{Z^+}$ is conjugated to $\tilde{T} \upharpoonright_{Z^+}$ and $T \upharpoonright_{Z^-}$ is conjugated to $\tilde{T}^{-1} \upharpoonright_{Z^-}$.

Let ν be the measure on \mathcal{C} given for a Borel $A \subseteq \mathcal{C}$ by $\nu(A) = \mu(A + [0, 1])$. The measure $\mu \upharpoonright_{\mathcal{C} + [0, 1]}$ is naturally isomorphic to $(\nu \times \lambda) \upharpoonright_{\mathcal{C} + [0, 1]}$, where λ is the Lebesgue measure on $[0, 1]$, and therefore we have

$$\forall \nu \times \lambda(c, \lambda) \in \mathcal{C} \times [0, 1) \quad c + \alpha \in Z.$$

By Fubini's theorem, this is equivalent to

$$\forall \lambda \alpha \in [0, 1) \quad \forall \nu c \in \mathcal{C} \quad (c + \alpha \in Z).$$

Therefore there exists some $\alpha_0 \in [0, 1)$ such that $\nu(\{c \in \mathcal{C} : c + \alpha_0 \in Z\}) = 1$. Note that $T \upharpoonright_{\mathcal{C} + \alpha_0}$ is the first return map on $\mathcal{C} + \alpha_0$ in the order of the flow \mathcal{F} , whereas $\tilde{T} \upharpoonright_{\mathcal{C} + \alpha_0}$ is the first return map in the order induced on the orbits by \mathcal{F}' . Since $T \upharpoonright_{\mathcal{C} + \alpha_0}$ and $\tilde{T} \upharpoonright_{\mathcal{C} + \alpha_0}$ are flip conjugated, the flows are flip Kakutani equivalent. \square

Theorem 10.14 has the following straightforward consequences.

COROLLARY 10.15. *If two free ergodic measure-preserving flows are L^1 orbit equivalent, then they are also flip Kakutani equivalent.*

PROOF. This now follows from the definition of L^1 orbit equivalence, see Definition 4.19 and the paragraph thereafter. \square

COROLLARY 10.16. *If two free ergodic measure-preserving flows have abstractly isomorphic L^1 full groups, then they are also flip Kakutani equivalent.*

PROOF. We have seen in Proposition 4.21 that isomorphism of L^1 full groups of ergodic flows implies L^1 orbit equivalence, so the result follows from the previous corollary. \square

Kakutani equivalence is a highly non-trivial equivalence relation (see, for instance, [ORW82] or [GK21, Kun23]). It seems likely, however, that L^1 full groups of flows contain even more information about the action. The only continuous automorphisms of \mathbb{R} are multiplications by nonzero scalars, and we ask whether isomorphism of L^1 full groups necessarily recovers the action up to such an automorphism.

QUESTION 10.17. *Let \mathcal{F}_1 and \mathcal{F}_2 be free ergodic measure-preserving flows with isomorphic L^1 full groups. Is it true that there is $\alpha \in \mathbb{R}^*$ such that \mathcal{F}_1 and $\mathcal{F}_2 \circ m_\alpha$ are isomorphic, where m_α denotes the multiplication by α ?*

Note that a positive answer to Question 10.10 would imply a positive answer to the above question.

10.4. Maximality of the L^1 norm and geometry

In this last section, we show that the L^1 norm is maximal on L^1 full groups of flows. In particular, it defines their quasi-isometry type. Exploring this quasi-isometry type further thus might lead to topological group invariants which distinguish some ergodic flows.

THEOREM 10.18. *Let \mathcal{F} be a free measure-preserving flow. The L^1 norm on $[\mathcal{F}]_1$ is maximal.*

PROOF. We have already shown that the L^1 norm on the derived L^1 full group is maximal (see Theorem 5.5). Denote by (\mathcal{E}, p) the space of \mathcal{F} -invariant ergodic probability measures, where p is the probability measure arising from the disintegration of μ which we write as $x \mapsto \nu_x$ (see Section C.3). The derived L^1 full group is equal to the kernel of the surjective index map $\mathcal{I} : [\mathcal{F}]_1 \rightarrow L^1(\mathcal{E}, \mathbb{R})$ and the quotient norm on $[\mathcal{F}]_1 / \ker \mathcal{I}$ is equal to the L^1 norm on $L^1(\mathcal{E}, p)$ by Proposition 6.7. The latter norm is maximal, as is any Banach space norm.

Given a function $f \in L^1(\mathcal{E}, p)$, let $U_f \in [\mathcal{F}]_1$ be given by $U_f(x) = x + f(\nu_x)$. The cocycle $\rho_{U_f}(x) = f(\nu_x)$ is constant on each ergodic component and $\|U_f\|_1 = \|f\|_1$. Furthermore, $\mathcal{I}(U_f) = f$. We show that $\|\cdot\|$ is both large-scale geodesic and coarsely proper (see Appendix A.2 and Proposition A.10, in particular).

Any $T \in [\mathcal{F}]_1$ can be written as $T = (TU_{\mathcal{I}(T)}^{-1})U_{\mathcal{I}(T)}$, where the transformation $TU_{\mathcal{I}(T)}^{-1} \in \ker \mathcal{I} = D([\mathcal{F}]_1)$, and $\|U_{\mathcal{I}(T)}\|_1 \leq \|T\|_1$. In particular, we have $\|TU_{\mathcal{I}(T)}^{-1}\|_1 \leq 2\|T\|_1$.

Since the L^1 norm is maximal on $D([\mathcal{F}]_1)$, it is large-scale geodesic. In fact, Proposition 3.24 establishes that it is large-scale geodesic with constant $K = 2$. We may therefore express $TU_{\mathcal{I}(T)}^{-1}$ as a product $V_1 \cdots V_n$ of elements $V_i \in D([\mathcal{F}]_1)$, where each V_i has norm at most K and

$$\sum_{i=1}^n \|V_i\|_1 \leq K \|TU_{\mathcal{I}(T)}^{-1}\|_1 \leq 2K \|T\|_1.$$

The transformation $U_{\mathcal{I}(T)}$ can, for any $m \geq 1$, also be expressed as a product

$$U_{\mathcal{I}(T)} = U_{\mathcal{I}(T)/m} \cdots U_{\mathcal{I}(T)/m} = U_{\mathcal{I}(T)/m}^m.$$

Taking m sufficiently large, we can ensure that $\|U_{\mathcal{I}(T)/m}\|_1 = \|\mathcal{I}(T)/m\|_1 \leq K$. Therefore, $T = (V_1 \cdots V_n)(U_{\mathcal{I}(T)/m} \cdots U_{\mathcal{I}(T)/m})$, and

$$\sum_{i=1}^n \|V_i\|_1 + \sum_{j=1}^m \|U_{\mathcal{I}(T)/m}\|_1 \leq 2K\|T\|_1 + \|U_{\mathcal{I}(T)}\|_1 \leq 3K\|T\|_1.$$

We conclude that the norm $\|\cdot\|$ on $[\mathcal{F}]_1$ is large-scale geodesic with $K' = 3K = 6$.

It remains to prove coarse properness. Let $\epsilon > 0$ and $R > 0$ be positive reals. By Theorem 5.5, there is $n \in \mathbb{N}$ so large that every element in the derived L^1 full group of norm at most $2R$ is a product of n elements of norm at most ϵ . Let N be any integer greater than R/ϵ . We argue that every element of $[\mathcal{F}]_1$ of norm at most R is a product of $2n + N$ elements of norm at most ϵ .

Indeed, if $T = (TU_{\mathcal{I}(T)}^{-1})U_{\mathcal{I}(T)}$ has norm at most R , then

$$\|TU_{\mathcal{I}(T)}^{-1}\|_1 \leq 2\|T\|_1 \leq 2R,$$

and $TU_{\mathcal{I}(T)}^{-1}$ can therefore be written as a product of n elements of $D([F]_1)$ each of norm $\leq \epsilon$. Also, $U_{\mathcal{I}(T)} = U_{\mathcal{I}(T)/N}^N$ and $\|U_{\mathcal{I}(T)/N}\|_1 \leq \epsilon$ by the choice of N . The conclusion follows. \square

REMARK 10.19. While the proposition above states that L^1 full groups of flows are quite big, one can use Proposition 6.8 to show that they satisfy the *Haagerup property*. In other words, such groups admit a coarsely proper affine action on a Hilbert space (namely, the affine Hilbert space $\chi_{\mathcal{R} \geq 0} + L^2(\mathcal{R}, M)$).

Corollary 10.16 along with [ORW82, Sec. 12] implies that there are uncountably many L^1 full groups of ergodic free flows up to topological group isomorphism. It would be great if their geometry allowed us to distinguish these groups. However, we don't even know the answer to the following question.

QUESTION 10.20. *Are there two free ergodic measure-preserving flows with non quasi-isometric L^1 full groups?*

APPENDIX A

Normed groups

We chose to present our work in the framework of groups equipped with compatible norms rather than metrics. These two frameworks are equivalent, but the former has some stylistic advantages, in our opinion. In Appendix A, we remind the reader the concept of a norm on a group (Section A.1) and state C. Rosendal's results on maximal norms (Section A.2).

A.1. Norms on groups

DEFINITION A.1. A **norm** on a group G is a map $\|\cdot\| : G \rightarrow \mathbb{R}^{\geq 0}$ such that for all $g, h \in G$

- (1) $\|g\| = 0$ if and only if $g = e$;
- (2) $\|g\| = \|g^{-1}\|$;
- (3) $\|gh\| \leq \|g\| + \|h\|$.

If G is moreover a topological group, a norm $\|\cdot\|$ on G is called **compatible** if the balls $\{g \in G : \|g\| < r\}$, $r > 0$, form a basis of neighborhoods of the identity.

There is a correspondence between (compatible) left-invariant metrics on a group and (compatible) norms on it. Indeed, given a left-invariant metric d on G , the function $\|g\| = d(e, g)$ is a norm. Conversely, from a norm $\|\cdot\|$ one can recover the left-invariant metric d via $d(g, h) = \|g^{-1}h\|$. Analogously, there is a correspondence between norms and right invariant metrics given by $d(g, h) = \|hg^{-1}\|$.

The language of group norms thus contains the same information as the formalism of left-invariant (or right-invariant) metrics, but it has the stylistic advantage of removing the need of making a choice between the invariant side, when such a choice is immaterial.

REMARK A.2. Note, however, that there are metrics that are neither left- nor right-invariant, which nonetheless induce a group norm via the same formula $\|g\| = d(g, e)$. Consider for example a Polish group G with a compatible left-invariant metric d' on it. If G is not a CLI group, the metric d' is not complete, but the metric

$$d(f, g) = \frac{d'(f, g) + d'(f^{-1}, g^{-1})}{2}$$

is complete. Since $d(g, e) = d'(g, e)$, we see that d induces the same norm $\|\cdot\|$ as does the left-invariant metric d' .

There is a canonical way to push a norm onto a factor group.

PROPOSITION A.3 (see [Fre04, Thm. 2.2.10]). *Let $(G, \|\cdot\|)$ be a Polish normed group, and let $H \trianglelefteq G$ be a closed normal subgroup of G . The function*

$$\|gH\|^{G/H} = \inf\{\|gh\| : h \in H\}$$

is a norm on G/H which is compatible with the quotient topology. In particular, $(G/H, \|\cdot\|^{G/H})$ is a Polish normed group.

DEFINITION A.4. A compatible norm $\|\cdot\|$ on a locally compact Polish group G is **proper** if all balls $\{g \in G : \|g\| \leq r\}$ are compact.

R. A. Struble [Str74] showed that all locally compact Polish groups admit a compatible proper norm.

A.2. Maximal norms

As was noted in Lemma 2.13, quasi-isometric norms yield the same L^1 full groups. C. Rosendal identified the class of Polish groups that admit maximal norms, which are unique up to quasi-isometry. In this section, we state some of results from C. Rosendal's treatise [Ros22], which are relevant to our work. For reader's convenience, we formulate the following definitions and propositions in the language of group norms as opposed to left-invariant metrics or *écartes*, as in the original reference.

DEFINITION A.5 ([Ros22, Def. 2.68]). A compatible norm $\|\cdot\|$ on a Polish group G is said to be **maximal** if for any compatible norm $\|\cdot\|'$ there is a constant $C > 0$ such that $\|g\|' \leq C\|g\| + C$ for all $g \in G$.

DEFINITION A.6 ([Ros22, Prop. 2.15]). Let G be a Polish group. A subset $A \subseteq G$ is **coarsely bounded** if for every continuous isometric action of G on a metric space (M, d_M) , the set $A \cdot m$ is bounded for all $m \in M$, i.e., there is $K > 0$ such that $d_M(a_1 \cdot m, a_2 \cdot m) \leq K$ for all $a_1, a_2 \in A$. A Polish group G is **boundedly generated** if it is generated by a coarsely bounded set.

THEOREM A.7 ([Ros22, Thm. 2.73]). *A Polish group admits a maximal compatible norm if and only if it is boundedly generated.*

The following characterization is available to establish maximality of a given norm.

DEFINITION A.8 ([Ros22, Def. 2.62]). A norm $\|\cdot\|$ on a group G is called **large-scale geodesic** if there is $K > 0$ such that for any $g \in G$, there are $g_1, \dots, g_n \in G$ of norm $\|g_i\| \leq K$, $1 \leq i \leq n$, such that $g = g_1 \cdots g_n$ and

$$\sum_{i=1}^n \|g_i\| \leq K \|g\|.$$

DEFINITION A.9 ([Ros22, Lem. 2.39(2) and Prop. 2.7(5)]). A compatible norm $\|\cdot\|$ on a topological group G is called **coarsely proper** if for every $\epsilon > 0$ and every $R > 0$, there are a finite subset $F \subseteq G$ and $n \in \mathbb{N}$ such that every element $g \in G$ of norm at most R can be written as a product

$$g = f_1 g_1 \cdots f_n g_n,$$

where $f_1, \dots, f_n \in F$ and each g_i has norm at most ϵ .

PROPOSITION A.10 ([Ros22, Prop. 2.72]). *A compatible norm $\|\cdot\|$ on a Polish group G is maximal if and only if it is both large-scale geodesic and coarsely proper.*

APPENDIX B

Hopf decomposition

An important tool in the theory of non-singular transformations on σ -finite measure spaces is the Hopf decomposition, which partitions the phase space into the so-called *dissipative* and *recurrent* parts reflecting different dynamics of the transformation. In this appendix, we recall the relevant definitions and indicate what happens for measure-preserving transformations of a σ -finite space. The reader may consult [Kre85, Sec. 1.3] for further details on the following definitions.

DEFINITION B.1. Let S be a non-singular transformation of a σ -finite measure space (Ω, λ) . A measurable set $A \subseteq \Omega$ is said to be:

- **wandering** if $A \cap S^k(A) = \emptyset$ for all $k \geq 1$;
- **recurrent** if $A \subseteq \bigcup_{k \geq 1} S^k(A)$;
- **infinitely recurrent** if $A \subseteq \bigcap_{n \geq 1} \bigcup_{k \geq n} S^k(A)$.

The inclusions above are understood to hold up to a null set. The transformation S is:

- **dissipative** if the phase space Ω is a countable union of wandering sets;
- **conservative** if there are no wandering sets of positive measure;
- **recurrent** if every set of positive measure is recurrent;
- **infinitely recurrent** if every set of positive measure is infinitely recurrent.

It turns out that the properties of being conservative, recurrent, and infinitely recurrent are all mutually equivalent.

PROPOSITION B.2. *Let S be a non-singular transformation of a σ -finite measure space (Ω, λ) . The following are equivalent:*

- (1) S is conservative;
- (2) S is recurrent;
- (3) S is infinitely recurrent.

Among the properties introduced in Definition B.1, only recurrence and dissipativity are therefore different. In fact, any non-singular transformation admits a canonical decomposition, known as the Hopf decomposition, into these two types of action.

PROPOSITION B.3 (Hopf decomposition). *Let S be a non-singular transformation of a σ -finite measure space (Ω, λ) . There exists an S -invariant partition $\Omega = D \sqcup C$ such that $S \upharpoonright_D$ is dissipative and $S \upharpoonright_C$ is recurrent (equivalently, conservative). Moreover, if $\Omega = D' \sqcup C'$ is another partition with this property then $\lambda(D \Delta D') = 0$ and $\lambda(C \Delta C') = 0$.*

We also note the following consequence of dissipativity in case the measure is preserved.

PROPOSITION B.4. *Let S be a measure-preserving transformation of a σ -finite measure space (Ω, λ) and let $\Omega = D \sqcup C$ be its Hopf decomposition. For every set $A \subseteq \Omega$ of finite measure, almost every point in D eventually escapes A :*

$$\forall^\lambda x \in D \exists N \forall n \geq N T^n x \notin A.$$

PROOF. We may as well assume $D = \Omega$. Let $A \subseteq \Omega$ have finite measure. Let Q be a wandering set whose translates cover Ω . Consider the map $\Phi : Q \times \mathbb{Z} \rightarrow \Omega$ which maps (x, n) to $T^n(x)$, and observe that Φ is measure-preserving if we endow $Q \times \mathbb{Z}$ with the product of the measure induced by λ on Q and the counting measure on \mathbb{Z} .

So if there is a positive measure set of $x \in Q$ such that $S^n(x) \in A$ for infinitely many $n \in \mathbb{N}$, by Fubini's theorem we would have that A has infinite measure, a contradiction. The same conclusion is true if we replace Q by any of its S -translates, and since these translates cover Ω the proof is finished. \square

Actions of locally compact Polish groups

In this chapter of the appendix, we collect some well-known facts related to actions of locally compact Polish groups. This exposition is provided for reader's convenience and completeness. We recall that by a result of G. W. Mackey [Mac62], any Boolean measure-preserving action of a locally compact Polish group can be realized as a spatial Borel action, so we may switch to pointwise formulations, whenever convenient for the exposition.

C.1. Disintegration of measure

Let \mathcal{R} be a smooth measurable equivalence relation on a standard Lebesgue space (X, μ) , and let $\pi : X \rightarrow Y$ be a measurable reduction to the identity relation on some standard Lebesgue space (Y, ν) , $\pi(x) = \pi(y)$ if and only if $x\mathcal{R}y$. Suppose that ν is a σ -finite measure on Y that is equivalent to the push-forward $\pi_*\mu$. A **disintegration** of μ relative to (π, ν) is a collection of measures $(\mu_y)_{y \in Y}$ on X such that for all Borel sets $A \subseteq X$

- (1) $\mu_y(X \setminus \pi^{-1}(y)) = 0$ for ν -almost all $y \in Y$;
- (2) the map $Y \ni y \mapsto \mu_y(A) \in \mathbb{R}$ is measurable;
- (3) $\mu(A) = \int_Y \mu_y(A) d\nu(y)$.

A theorem of D. Maharam [Mah50] asserts that μ can be disintegrated over any (π, ν) as above. In fact, existence of a disintegration can be proved in a setup considerably more general (see, for example, D. H. Fremlin [Fre06, Thm. 452I]), but in the framework of standard Lebesgue spaces, disintegration is essentially unique. While the context of our work is purely ergodic theoretical, we note that the disintegration result holds in the descriptive set theoretical setting as well, as discussed in [Mah84] and [GM89]. Without striving for generality, we formulate here a specific version, which suits our needs.

THEOREM C.1 (Disintegration of Measure). *Let (X, μ) be a standard Lebesgue space, (Y, ν) be a σ -finite standard Lebesgue space, and let $\pi : X \rightarrow Y$ be a measurable function. If $\pi_*\mu$ is equivalent to ν , then there exists a disintegration $(\mu_y)_{y \in Y}$ of μ over (π, ν) . Moreover, such a disintegration is essentially unique in the sense that if $(\mu'_y)_{y \in Y}$ is another disintegration, then $\mu_y = \mu'_y$ for ν -almost all $y \in Y$.*

REMARK C.2. It is more common to formulate the disintegration theorem with the assumption that $\pi_*\mu = \nu$, when one can additionally ensure that $\mu_y(X) = \mu(X)$ for ν -almost all y . Weakening the equality $\pi_*\mu = \nu$ to mere equivalence is a simple consequence, for if $(\mu_y)_{y \in Y}$ is a disintegration of μ over $(\pi, \pi_*\mu)$, then $(\frac{d\pi_*\mu}{d\nu}(y) \cdot \mu_y)_{y \in Y}$ is a disintegration of μ over (π, ν) .

Let $X_a \subseteq X$ be the set of atoms of the disintegration, i.e., $X_a = \{x \in X : \mu_y(x) > 0 \text{ for some } y \in Y\}$, and let F be the equivalence relation on X_a , where two

atoms within the same fiber are equivalent whenever they have the same measure: $x_1 F x_2$ if and only if $\mu_{\pi(x_1)}(x_1) = \mu_{\pi(x_2)}(x_2)$ and $\pi(x_1) = \pi(x_2)$. The equivalence relation F is measurable and has finite classes μ -almost surely. Let X_n , $n \geq 1$, be the union of F -equivalence classes of size exactly n , thus $X_a = \bigsqcup_{n \geq 1} X_n$. Set also $X_0 = X \setminus X_a$ to be the atomless part of the disintegration and let \mathcal{R}_n denote the restriction of \mathcal{R} onto X_n .

Consider the group $[\mathcal{R}] \leq \text{Aut}(X, \mu)$ of measure-preserving automorphisms for which $x\mathcal{R}Tx$ holds μ -almost surely. Every $T \in [\mathcal{R}]$ preserves ν -almost all measures μ_y , since $(T_*\mu_y)_{y \in Y}$ is a disintegration of $T_*\mu = \mu$, which has to coincide with $(\mu_y)_{y \in Y}$ by uniqueness of the disintegration. In particular, the partition $X = \bigsqcup_{n \in \mathbb{N}} X_n$ is invariant under the full group $[\mathcal{R}]$, and for any $T \in [\mathcal{R}]$ the restriction $T \upharpoonright_{X_n} \in [\mathcal{R}_n]$ for every $n \in \mathbb{N}$. Conversely, for a sequence $T_n \in [\mathcal{R}_n]$, $n \in \mathbb{N}$, one has $T = \bigsqcup_n T_n \in [\mathcal{R}]$. We therefore have an isomorphism of (abstract) groups $[\mathcal{R}] \cong \prod_{n \in \mathbb{N}} [\mathcal{R}_n]$.

The groups $[\mathcal{R}_n]$ can be described quite explicitly. First, let us consider the case $n \geq 1$, thus $X_n \subseteq X_a$. All equivalence classes of the restriction of F onto X_n have size n . Let $Y_n \subseteq X_n$ be a measurable transversal, i.e., a measurable set intersecting every F -class in a single point, and let $\nu_n = \mu \upharpoonright_{Y_n}$. Every $T \in [\mathcal{R}_n]$ produces a permutation of μ -almost every F -class, so we can view it as an element of $L^0(Y_n, \nu_n, \mathfrak{S}_n)$, where \mathfrak{S}_n is the group of permutations of an n -element set. This identification works in both directions and produces an isomorphism $[\mathcal{R}_n] \cong L^0(Y_n, \nu_n, \mathfrak{S}_n)$. Note also that all ν_n are atomless if so is μ . We allow for $\mu(X_n) = 0$, in which case $L^0(Y_n, \nu_n, \mathfrak{S}_n)$ is the trivial group.

Let us now go back to the equivalence relation $\mathcal{R}_0 = \mathcal{R} \cap X_0 \times X_0$, and recall that measures $\mu_y \upharpoonright_{X_0}$ are atomless. Let $Y_0 = \{y : \mu_y(X_0) > 0\}$ be the encoding of fibers with non-trivial atomless components and put $\nu_0 = \nu \upharpoonright_{Y_0}$. In particular, for every $y \in Y_0$ the space (X_0, μ_y) is isomorphic to the interval $[0, \mu_y(X_0)]$ endowed with the Lebesgue measure. In fact, one can select such isomorphisms in a measurable way across all $y \in Y_0$. More precisely, there is a measurable isomorphism $\psi : X_0 \rightarrow \{(y, r) \in Y_0 \times \mathbb{R} : 0 \leq r \leq \mu_y(X_0)\}$ such that for all $y \in Y_0$

- $\psi(\pi^{-1}(y) \cap X_0) = \{y\} \times [0, \mu_y(X_0)]$;
- $\psi_*\mu_y \upharpoonright_{X_0}$ coincides with the Lebesgue measure on $\{y\} \times [0, \mu_y(X_0)]$.

The reader may find further details in [GM89, Thm. 2.3], where the same construction is discussed in a more refined setting of Borel disintegrations.

Using the isomorphism ψ , we can identify each $\pi^{-1}(y) \cap X_0$, $y \in Y_0$, with $[0, \mu_y(X_0)]$. Since every $T \in [\mathcal{R}_0]$ preserves ν -almost every μ_y , we may rescale these intervals and view any $T \in [\mathcal{R}_0]$ as an element of $L^0(Y_0, \nu_0, \text{Aut}([0, 1], \lambda))$. Conversely, every $f \in L^0(Y_0, \nu_0, \text{Aut}([0, 1], \lambda))$ gives rise to $T_f \in [\mathcal{R}_0]$ via the notationally convoluted but natural

$$T_f(x) = \psi^{-1}(\pi(x), (f(\pi(x)) \cdot \text{proj}_2(\psi(x)) / \mu_{\pi(x)}(X_0)) \mu_{\pi(x)}(X_0)),$$

which, in plain words, simply applies $f(\pi(x))$ upon the corresponding fiber identified with $[0, 1]$ using ψ . This map is an isomorphism between the groups $[\mathcal{R}_0]$ and $L^0(Y_0, \nu_0, \text{Aut}([0, 1], \lambda))$.

Let us say that \mathcal{R} has **atomless classes** if μ_y is atomless ν -almost surely or, equivalently, $\mu(X_a) = 0$ in the notation above. We may summarize the discussion so far into the following proposition.

PROPOSITION C.3. *Let \mathcal{R} be a smooth measurable equivalence relation on a standard Lebesgue space (X, μ) . There are (possibly empty) standard Lebesgue spaces (Y_k, ν_k) , $k \in \mathbb{N}$, such that the full group $[\mathcal{R}] \leq \text{Aut}(X, \mu)$ is (abstractly) isomorphic to*

$$L^0(Y_0, \nu_0, \text{Aut}([0, 1], \lambda)) \times \prod_{n \geq 1} L^0(Y_n, \nu_n, \mathfrak{S}_n),$$

where \mathfrak{S}_n is the group of permutations of a n -element set. If μ is atomless, then so are the spaces (Y_n, ν_n) , $n \geq 1$. If \mathcal{R} has atomless classes, then all (Y_n, ν_n) , $n \geq 1$, are negligible and $[\mathcal{R}]$ is isomorphic to $L^0(Y_0, \nu_0, \text{Aut}([0, 1], \lambda))$.

We can further refine the product in Proposition C.3 by decomposing the spaces (Y_n, ν_n) into individual atoms and the atomless remainders. More specifically, let (Z, ν_Z) be a standard Lebesgue space and G be a Polish group. Given a measurable partition $Z = Z_0 \sqcup Z_1$, every function $f \in L^0(Z, \nu_Z, G)$ can be associated with a pair $(f_0, f_1) \in L^0(Z_0, \nu_{Z,0}, G) \times L^0(Z_1, \nu_{Z,1}, G)$, $\nu_{Z,i} = \nu_Z \upharpoonright_{Z_i}$ and $f_i = f \upharpoonright_{Z_i}$, which is an isomorphism of the topological groups. The same consideration applies to finite or countably infinite partitions.

PROPOSITION C.4. *Let (Z, ν_Z) be a standard Lebesgue space and G be a Polish group. For any finite or countably infinite measurable partition $Z = \bigsqcup_{n \in I} Z_n$, there is an isomorphism of topological groups $L^0(Z, \nu_Z, G)$ and $\prod_{n \in I} L^0(Z_n, \nu_{Z,n}, G)$, where $\nu_{Z,n}$ is the restriction of ν_Z onto Z_n .*

Applying Proposition C.4 to the partition of (Z, ν_Z) into the atomless part Z_0 and individual atoms $Z_k = \{z_k\}$ (if any), and noting that for a singleton Z_k the group $L^0(Z_k, \nu_{Z,k}, G)$ is naturally isomorphic to G , we get the following corollary.

COROLLARY C.5. *Let (Z, ν_Z) be a standard Lebesgue space and G be a Polish group. Let $Z_a \subseteq Z$ be the set of atoms of Z and $Z_0 = Z \setminus Z_a$ be the atomless part. The group $L^0(Z, \nu_Z, G)$ is isomorphic to $L^0(Z_0, \nu_Z \upharpoonright_{Z_0}, G) \times G^{|Z_a|}$.*

Combining the discussion above with Proposition C.3, we obtain a very concrete representation for $[\mathcal{R}]$. In the formulation below, G^0 is understood to be the trivial group.

PROPOSITION C.6. *Let \mathcal{R} be a smooth measurable equivalence relation on a standard Lebesgue space (X, μ) . There are cardinals $\kappa_n \leq \aleph_0$ and $\epsilon_n \in \{0, 1\}$ such that*

$$[\mathcal{R}] \cong L^0([0, 1], \lambda, \text{Aut}([0, 1], \lambda))^{\epsilon_0} \times \text{Aut}([0, 1], \lambda)^{\kappa_0} \times \left(\prod_{n \geq 1} L^0([0, 1], \lambda, \mathfrak{S}_n)^{\epsilon_n} \times \mathfrak{S}_n^{\kappa_n} \right).$$

If μ is atomless, then $\kappa_n = 0$ for all $n \geq 1$; if \mathcal{R} has atomless classes, then $\epsilon_n = 0$ for all $n \geq 1$.

So far we viewed $[\mathcal{R}]$ as an abstract group. This is because neither of the two natural topologies on $\text{Aut}(X, \mu)$ play well with the full group construction— $[\mathcal{R}]$ is generally not closed in the weak topology, and not separable in the uniform topology whenever $\mu(X_0) > 0$. Nonetheless, the isomorphism given in Proposition C.3 shows that there is a natural Polish topology on $[\mathcal{R}]$, which arises when we view groups $L^0(Y_0, \nu_0, \text{Aut}([0, 1], \lambda))$ and $L^0(Y_n, \nu_n, \mathfrak{S}_n)$ as Polish groups in the topology of convergence in measure. It is with respect to this topology we formulate Proposition C.7.

PROPOSITION C.7. *Let \mathcal{R} be a smooth measurable equivalence relation on a standard Lebesgue space (X, μ) . The set of periodic elements is dense in $[\mathcal{R}]$.*

PROOF. Rokhlin's Lemma implies that any $T \in [\mathcal{R}]$ can be approximated in the uniform topology by periodic elements from $[T] \subseteq [\mathcal{R}]$. Since the uniform topology is stronger than the Polish topology on $[\mathcal{R}]$, the proposition follows. \square

C.2. Tessellations

An important feature of locally compact group actions is the fact that they all admit measurable cross-sections. This was proved by J. Feldman, P. Hahn, and C. Moore in [FHM78], whereas a Borel version of the result was obtained by A. S. KeCHRIS in [Kec92].

DEFINITION C.8. Let $G \curvearrowright X$ be a Borel action of a locally compact Polish group. A **cross-section** is a Borel set $\mathcal{C} \subseteq X$ which is both

- a **complete section** for \mathcal{R}_G : it intersects every orbit of the action and
- **lacunary**: for some neighborhood of the identity $1_G \in U \subseteq G$ one has $U \cdot c \cap U \cdot c' = \emptyset$ for all distinct $c, c' \in \mathcal{C}$.

A cross-section \mathcal{C} is **K -cocompact**, where $K \subseteq G$ is a compact set, if $K \cdot \mathcal{C} = X$; a cross-section is **cocompact** if it is K -cocompact for some compact $K \subseteq G$.

Any action $G \curvearrowright X$ admits a K -cocompact cross-section, whenever $K \subseteq G$ is a compact neighborhood of the identity (see [Slu17, Thm. 2.4]). We also remind the following well-known lemma on the possibility to partition a cross-section into pieces with a prescribed lacunarity parameter.

LEMMA C.9. *Let $G \curvearrowright X$ be a Borel action of a locally compact Polish group and \mathcal{C} be a cross-section for the action. For any compact neighborhood of the identity $V \subseteq G$, there exists a finite Borel partition $\mathcal{C} = \bigsqcup_i \mathcal{C}_i$ such that each \mathcal{C}_i is V -lacunary.*

PROOF. Set $K = (V \cup V^{-1})^2$ and let $U \subseteq G$ be a compact neighborhood of the identity small enough for \mathcal{C} to be U -lacunary. Define a binary relation \mathcal{G} on \mathcal{C} by declaring $(c, c') \in \mathcal{G}$ whenever $c \in K \cdot c'$ and $c \neq c'$. Note that \mathcal{G} is symmetric since so is K . We view \mathcal{G} as a Borel graph on \mathcal{C} and claim that it is locally finite. More specifically, if λ is a right Haar measure, then the degree of each $c \in \mathcal{C}$ is at most $\lfloor \frac{\lambda(U \cdot K)}{\lambda(U)} \rfloor - 1$.

Indeed, let $c_0, \dots, c_N \in \mathcal{C}$ be distinct elements such that $c_i \in K \cdot c_0$ for all $i \leq N$; in particular $(c_i, c_0) \in \mathcal{G}$ for $i \geq 1$. Let $k_i \in K$ be such that $k_i \cdot c_0 = c_i$. Lacunarity of \mathcal{C} asserts that sets $U \cdot c_i = U k_i \cdot c_0$ are supposed to be pairwise disjoint, which necessitates $U k_i$ to be pairwise disjoint for $0 \leq i \leq N$. Clearly $U k_i \subseteq U K$ as $k_i \in K$. Using the right-invariance of λ , we have $\lambda(U K) \geq \lambda(\bigsqcup_{i \leq N} U k_i) = (N + 1)\lambda(U)$, and thus $N + 1 \leq \frac{\lambda(U K)}{\lambda(U)}$, as claimed.

We may now use [KST99, Prop. 4.6] to deduce existence of a finite partition $\mathcal{C} = \bigsqcup_i \mathcal{C}_i$ such that no two points in \mathcal{C}_i are adjacent. In other words, if $c, c' \in \mathcal{C}_i$ are distinct, then $c \notin K \cdot c'$, and therefore $V \cdot c \cap V \cdot c' = \emptyset$, which shows that \mathcal{C}_i are V -lacunary. \square

Every cross-section \mathcal{C} gives rise to a smooth subrelation of \mathcal{R}_G by associating to $x \in X$ “the closest point” of \mathcal{C} in the same orbit. Such a subrelation is known

as the Voronoi tessellation. For the purposes of Chapter 5, we need a slightly more abstract concept of a tessellation which may not correspond to Voronoi domains. While far from being the most general, the following treatment is sufficient for our needs.

DEFINITION C.10. Let $G \curvearrowright X$ be a Borel action of a locally compact Polish group on a standard Borel space and let $\mathcal{C} \subseteq X$ be a cross-section. A **tessellation** over \mathcal{C} is a Borel set $\mathcal{W} \subseteq \mathcal{C} \times X$ such that

- (1) all fibers $\mathcal{W}_c = \{x \in X : (c, x) \in \mathcal{W}\}$ are pairwise disjoint for $c \in \mathcal{C}$;
- (2) for all $c \in \mathcal{C}$ elements of \mathcal{W}_c are \mathcal{R}_G -equivalent to c , i.e., $\{c\} \times \mathcal{W}_c \subseteq \mathcal{R}_G$;
- (3) fibers cover the phase space, $X = \bigsqcup_{c \in \mathcal{C}} \mathcal{W}_c$.

A tessellation \mathcal{W} over \mathcal{C} is **N -lacunary** for an open $N \subseteq G$ if

$$\{(c, N \cdot c) : c \in \mathcal{C}\} \subseteq \mathcal{W}.$$

It is **K -cocompact**, $K \subseteq G$, if $\mathcal{W} \subseteq \{(c, K \cdot c) : c \in \mathcal{C}\}$.

Any tessellation \mathcal{W} can be viewed as a (flipped) graph of a function, since for any $x \in X$ there is a unique $c \in \mathcal{C}$ such that $(c, x) \in \mathcal{W}$. We denote such c by $\pi_{\mathcal{W}}(x)$, which produces a Borel map $\pi_{\mathcal{W}} : X \rightarrow \mathcal{C}$. There is a natural equivalence relation $\mathcal{R}_{\mathcal{W}}$ associated with the tessellation. Namely, x_1 and x_2 are $\mathcal{R}_{\mathcal{W}}$ -equivalent whenever they belong to the same fiber, i.e., $\pi_{\mathcal{W}}(x_1) = \pi_{\mathcal{W}}(x_2)$. In view of the item (2), $\mathcal{R}_{\mathcal{W}} \subseteq \mathcal{R}_G$ and moreover, every \mathcal{R}_G -class consists of countably many $\mathcal{R}_{\mathcal{W}}$ -classes.

Voronoi tessellations provide a specific way of constructing tessellations over a given cross-section. Suppose that the group G is endowed with a compatible *proper* norm $\|\cdot\|$. Let $D : \mathcal{R}_G \rightarrow \mathbb{R}^{\geq 0}$ be the associated metric on the orbits of the action (as in Section 2.2) and let $\preceq_{\mathcal{C}}$ be a Borel linear order on \mathcal{C} . The **Voronoi tessellation** over the cross-section \mathcal{C} relative to a proper norm $\|\cdot\|$ is the set $\mathcal{V}_{\mathcal{C}} \subseteq \mathcal{C} \times X$ defined by

$$\begin{aligned} \mathcal{V}_{\mathcal{C}} = \{ & (c, x) \in \mathcal{C} \times X : c \mathcal{R}_G x \text{ and for all } c' \in \mathcal{C} \text{ such that } c' \mathcal{R}_G x \text{ either} \\ & D(c, x) < D(c', x) \text{ or} \\ & (D(c, x) = D(c', x) \text{ and } c \preceq_{\mathcal{C}} c') \}. \end{aligned}$$

Properness of the norm ensures that for each $x \in X$ there are only finitely many candidates c which minimize $D(c, x)$, and hence each $x \in X$ is associated with a unique $c \in \mathcal{C}$.

For the sake of Chapter 5, we need a definition of the Voronoi tessellation for norms that may not be proper. The set $\mathcal{V}_{\mathcal{C}}$ specified as above may in this case fail to satisfy item (3) of the definition of a tessellation, as for some $x \in X$ there may be infinitely many $c \in \mathcal{C}$ that minimize $D(c, x)$, none of which are $\preceq_{\mathcal{C}}$ -minimal. We therefore need a different way to resolve the points on the “boundary” between the regions, which can be done, for example, by delegating this task to a proper norm.

DEFINITION C.11. Let $\|\cdot\|$ be a compatible norm on G and let \mathcal{C} be a cross-section. Pick a compatible proper norm $\|\cdot\|'$ on G and a Borel linear order $\preceq_{\mathcal{C}}$ on \mathcal{C} . Let D and D' be the metrics on orbits of the action associated with the norms $\|\cdot\|$ and $\|\cdot\|'$ respectively. The **Voronoi tessellation** over the cross-section \mathcal{C} relative

to the norm $\|\cdot\|$ is the set $\mathcal{V}_\mathcal{C} \subseteq \mathcal{C} \times X$ defined by

$$\mathcal{V}_\mathcal{C} = \{(c, x) \in \mathcal{C} \times X : c\mathcal{R}_G x \text{ and for all } c' \in \mathcal{C} \text{ such that } c'\mathcal{R}_G x \text{ either} \\ D(c, x) < D(c', x) \text{ or} \\ (D(c, x) = D(c', x) \text{ and } D'(c, x) < D'(c', x)) \text{ or} \\ (D(c, x) = D(c', x) \text{ and } D'(c, x) = D'(c', x) \text{ and } c \preceq_\mathcal{C} c')\}.$$

The definition of the Voronoi tessellation does depend on the choice of the norm $\|\cdot\|'$ and the linear order $\preceq_\mathcal{C}$ on the cross-section, but its key properties are the same regardless of these choices. We therefore often do not specify explicitly which $\|\cdot\|'$ and $\preceq_\mathcal{C}$ are picked. Note also that if the cross-section is cocompact, then every region of the Voronoi tessellation is bounded, i.e., $\sup_{x \in X} D(x, \pi_{\mathcal{V}_\mathcal{C}}(x)) < +\infty$.

Our goal is to show that equivalence relations $\mathcal{R}_\mathcal{W}$ are atomless in the sense of Section C.1 as long as each orbit of the action is uncountable. To this end we first need the following lemma.

LEMMA C.12. *Let G be a locally compact Polish group acting on a standard Lebesgue space (X, μ) by measure-preserving automorphisms. Suppose that almost every orbit of the action is uncountable. If $\mathcal{A} \subseteq X$ is a measurable set such that the intersection of \mathcal{A} with almost every orbit is countable, then $\mu(\mathcal{A}) = 0$.*

PROOF. Pick a proper norm $\|\cdot\|$ on G , let \mathcal{C} be a cross-section for the action, let $B_{2r} \subseteq G$ be an open ball around the identity of sufficiently small radius $2r > 0$ such that $B_{2r} \cdot c \cap B_{2r} \cdot c' = \emptyset$ whenever $c, c' \in \mathcal{C}$ are distinct, and let $\mathcal{V}_\mathcal{C}$ be the Voronoi tessellation over \mathcal{C} relative to $\|\cdot\|$. Note that $B_{2r} \cdot c$ is fully contained in the $\mathcal{R}_{\mathcal{V}_\mathcal{C}}$ -class of c and set $X = B_r \cdot \mathcal{C}$. Let also $(g_n)_{n \in \mathbb{N}}$ be a countable dense subset of G .

We claim that it is enough to consider the case when \mathcal{A} intersects each $\mathcal{R}_{\mathcal{V}_\mathcal{C}}$ -class in at most one point. Indeed, the restriction of $\mathcal{R}_{\mathcal{V}_\mathcal{C}}$ onto \mathcal{A} is a smooth countable equivalence relation, so one can write $\mathcal{A} = \bigsqcup_{n \in \mathbb{N}} \mathcal{A}'_n$, where each \mathcal{A}'_n intersects each $\mathcal{R}_{\mathcal{V}_\mathcal{C}}$ -class in at most one point. To simplify notations, we assume that \mathcal{A} already possesses this property.

Let $\gamma : X \rightarrow \mathbb{N}$ be defined by $\gamma(x) = \min\{n \in \mathbb{N} : x\mathcal{R}_{\mathcal{V}_\mathcal{C}} g_n x \text{ and } g_n x \in X\}$. Let $\mathcal{A}_n = \mathcal{A} \cap \gamma^{-1}(n)$ and note that sets \mathcal{A}_n partition \mathcal{A} . It is therefore enough to show that $\mu(\mathcal{A}_n) = 0$ for any $n \in \mathbb{N}$. Pick $n_0 \in \mathbb{N}$. The action is measure-preserving and therefore $\mu(\mathcal{A}_{n_0}) = \mu(g_{n_0} \mathcal{A}_{n_0})$. Set $\mathcal{B}_0 = g_{n_0} \mathcal{A}_{n_0}$ and note that for any $x \in \mathcal{B}_0$ and $g \in B_r \subseteq G$ one has $gx\mathcal{R}_{\mathcal{V}_\mathcal{C}} x$. If the action were free, we could easily conclude that $\mu(\mathcal{B}_0) = 0$, since sets $g\mathcal{B}_0$, $g \in B_r$, would be pairwise disjoint. In general, we need to exhibit a little more care and construct a countable family of pairwise disjoint sets \mathcal{B}_n as follows.

For $x \in \mathcal{B}_0$ let $\tau_n(x) = \min\{m \in \mathbb{N} : x\mathcal{R}_{\mathcal{V}_\mathcal{C}} g_m x \text{ and } g_m x \notin \bigcup_{k \leq n} \mathcal{B}_k\}$. The value $\tau_n(x)$ is well-defined because the stabilizer of x is closed and must be nowhere dense in B_r due to the orbit $G \cdot x$ being uncountable. Put $\mathcal{B}_{n+1} = \{g_{\tau_n(x)} x : x \in \mathcal{B}_0\}$ and note that $\mu(\mathcal{B}_n) = \mu(\mathcal{B}_0)$. We get a pairwise disjoint infinite family of sets \mathcal{B}_n all having the same measure. Since μ is finite, we conclude that $\mu(\mathcal{B}_0) = 0$ and the lemma follows. \square

COROLLARY C.13. *Let G be a locally compact Polish group acting on a standard Lebesgue space (X, μ) by measure-preserving automorphisms, let \mathcal{C} be a cross-section for the action and let $\mathcal{W} \subseteq \mathcal{C} \times X$ be a tessellation. If μ -almost every orbit of G is uncountable, then $\mathcal{R}_{\mathcal{W}}$ is atomless.*

PROOF. Consider the disintegration $(\mu_c)_{c \in \mathcal{C}}$ of $\mathcal{R}_{\mathcal{W}}$ relative to $(\pi_{\mathcal{W}}, \nu)$, where $\pi_{\mathcal{W}} : X \rightarrow \mathcal{C}$ and $\nu = (\pi_{\mathcal{W}})_* \mu$. Let $X_a \subseteq X$ be the set of atoms of the disintegration. Since ν -almost every μ_c is finite, fibers $\pi_{\mathcal{W}}^{-1}(c)$ have countably many atoms. Since every tessellation has only countably many tiles within each orbit, we conclude that X_a has countable intersection with almost every orbit of the action. Lemma C.12 applies and shows that $\mu(X_a) = 0$, hence $\mathcal{R}_{\mathcal{W}}$ is atomless as required. \square

Consider the full group $[\mathcal{R}_{\mathcal{W}}]$ which by Proposition C.3 and Corollary C.13 is isomorphic to $L^0(Y, \nu, \text{Aut}([0, 1], \lambda))$ for some standard Lebesgue space (Y, ν) . This full group can naturally be viewed as a subgroup of $[\mathcal{R}_G]$ and the topology induced on $[\mathcal{R}_{\mathcal{W}}]$ from the full group $[\mathcal{R}_G]$ coincides with the topology of converges in measure on $L^0(Y, \nu, \text{Aut}([0, 1], \lambda))$ (see Section 3 of [CLM16]). We therefore have the following corollary.

COROLLARY C.14. *Let G be a locally compact Polish group acting on a standard Lebesgue space (X, μ) by measure-preserving automorphisms, let \mathcal{C} be a cross-section for the action and let $\mathcal{W} \subseteq \mathcal{C} \times X$ be a tessellation and $\pi_{\mathcal{W}} : X \rightarrow \mathcal{C}$ be the corresponding reduction. If μ -almost every orbit of G is uncountable, then the subgroup $[\mathcal{R}_{\mathcal{W}}] \leq [\mathcal{R}_G]$ is isomorphic as a topological group to $L^0(\mathcal{C}, (\pi_{\mathcal{W}})_* \mu, \text{Aut}([0, 1], \lambda))$. If moreover all orbits of the action have measure zero, then $(\pi_{\mathcal{W}})_* \mu$ is non-atomic and $[\mathcal{R}_{\mathcal{W}}]$ is isomorphic to $L^0([0, 1], \lambda, \text{Aut}([0, 1], \lambda))$.*

C.3. Ergodic decomposition

Let $G \curvearrowright X$ be a free measure-preserving action of a locally compact group on a standard probability space (X, μ) . The space $\mathcal{E} = \text{EINV}(G \curvearrowright X)$ of invariant ergodic probability measures of this action possesses a structure of a standard Borel space. The Ergodic Decomposition theorem of V. S. Varadarajan [Var63, Thm. 4.2] asserts that there is an essentially unique Borel \mathcal{R}_G -invariant surjection $X \ni x \mapsto \nu_x \in \mathcal{E}$ and a probability measure p on \mathcal{E} such that $\mu = \int_{\mathcal{E}} \nu dp(\nu)$ in the sense that for all Borel $A \subseteq X$ one has $\mu(A) = \int_{\mathcal{E}} \nu(A) dp(\nu)$.

There is a one-to-one correspondence between measurable \mathcal{R}_G -invariant functions $h : X \rightarrow \mathbb{R}$ and measurable functions $\tilde{h} : \mathcal{E} \rightarrow \mathbb{R}$ given by $\tilde{h}(\nu_x) = h(x)$. For measures μ and p as above, this correspondence gives an isometric isomorphism between $L^1(\mathcal{E}, \mathbb{R})$ and the subspace of $L^1(X, \mathbb{R})$ that consists of \mathcal{R}_G -invariant functions.

APPENDIX D

Conditional measures

The ergodic decomposition theorem, as formulated in Section C.3, is not available for general probability measure-preserving actions of Polish groups. Conditional measures provide a useful framework to remedy this. As before, $\text{Aut}(X, \mu)$ stands for the group of measure-preserving automorphisms of a standard probability space. It is more useful, however, to view $\text{Aut}(X, \mu)$ as the group of measure-preserving automorphisms of the **measure algebra** $\text{MAlg}(X, \mu)$ of (X, μ) , i.e., is the Boolean algebra of equivalence classes of Borel subsets of X , identified up to measure zero. The measure algebra is endowed with a natural metric d_μ given by $d_\mu(A, B) = \mu(A \triangle B)$. Completeness of $(\text{MAlg}(X, \mu))$ in this metric is a standard and well-known fact (see, for instance, [Kec95, Exer. 17.43]), which we include for reader's convenience.

PROPOSITION D.1. *The metric space $(\text{MAlg}(X, \mu), d_\mu)$ is complete.*

PROOF. It suffices to show that a Cauchy sequence $(A_n)_n$ admits a converging subsequence. Passing to a subsequence if necessary, we may assume that $d_\mu(A_n, A_{n+1}) < 2^{-n}$ holds for all n , and therefore $\sum_{n \in \mathbb{N}} \mu(A_n \triangle A_{n+1}) < +\infty$. The set

$$A = \{x \in X : x \in A_n \text{ for all but finitely many } n \in \mathbb{N}\}$$

is the limit we seek. Indeed, given an $\epsilon > 0$ and an index N chosen so large that $\sum_{n \geq N} \mu(A_n \triangle A_{n+1}) < \epsilon$, for all $n \geq N$ and all x outside of the set $\bigcup_{n \geq N} A_n \triangle A_{n+1}$ of measure at most ϵ , we have $x \in A_n$ if and only if $x \in A$. \square

Note that closed (or equivalently, metrically complete) subalgebras of $\text{MAlg}(X, \mu)$ are in a natural one-to-one correspondence with complete (in the measure-theoretical sense) σ -subalgebras of the σ -algebra of Lebesgue measurable sets.

D.1. Conditional expectations

We review here how conditional expectations can easily be defined without appealing to disintegration.

Let M be a closed subalgebra of $\text{MAlg}(X, \mu)$ and let $L^2(M, \mu)$ denote the L^2 space of real-valued M -measurable functions. Note that $L^2(M, \mu)$ is a closed subspace of $L^2(X, \mu) = L^2(\text{MAlg}(X, \mu), \mu)$. The M -**conditional expectation** is the orthogonal projection $\mathbb{E}_M : L^2(X, \mu) \rightarrow L^2(M, \mu)$. It is also uniquely defined by the condition

$$(D.1) \quad \int_X fg \, d\mu = \int_X \mathbb{E}_M(f)g \, d\mu \quad \text{for all } f \in L^2(X, \mu) \text{ and all } g \in L^2(M, \mu).$$

By the density of step functions in $L^2(M, \mu)$, the conditional expectation can equivalently be defined as the linear contraction $L^2(X, \mu) \rightarrow L^2(M, \mu)$ satisfying

$$(D.2) \quad \int_A f d\mu = \int_A \mathbb{E}_M(f) d\mu \quad \text{for all } A \in M \text{ and all } f \in L^2(X, \mu).$$

Positive functions are exactly those whose dot product with any characteristic function is positive. Letting g in Eq. (D.1) range through the collection of all characteristic functions of sets in M shows that the conditional expectation \mathbb{E}_M is positivity-preserving.

PROPOSITION D.2. *If $f \in L^2(X, \mu)$ is non-negative, $f \geq 0$, then $\mathbb{E}_M(f) \geq 0$.*

While we defined conditional expectations as operators on $L^2(X, \mu)$, their domain can be extended to all of $L^1(X, \mu)$, making \mathbb{E}_M a contraction from $L^1(X, \mu)$ to $L^1(M, \mu)$. This is justified by the following proposition.

PROPOSITION D.3. *The conditional expectation $\mathbb{E}_M : L^2(X, \mu) \rightarrow L^2(M, \mu)$ is a contraction when the domain and the range are endowed with the L^1 norms.*

PROOF. If $f \in L^2(X, \mu)$ is non-negative, $f \geq 0$, then Eq. D.1 yields

$$\|f\|_1 = \int_X f d\mu = \int_X f \cdot 1 d\mu = \int_X \mathbb{E}_M(f) \cdot 1 d\mu = \int_X \mathbb{E}_M(f) d\mu.$$

Since $\mathbb{E}_M(f) \geq 0$ by Proposition D.2, we conclude that $\|\mathbb{E}_M(f)\|_1 = \|f\|_1$ for all non-negative $f \in L^2(X, \mu)$.

For an arbitrary $f \in L^2(X, \mu)$, set $f^+ = \max\{f, 0\}$ and $f^- = \max\{-f, 0\}$. Note that functions f^+, f^- are non-negative and belong to $L^2(X, \mu)$. Furthermore, $f^+ - f^- = f$ and $\|f^+\|_1 + \|f^-\|_1 = \|f\|_1$. We therefore have

$$\|\mathbb{E}_M(f)\|_1 = \|\mathbb{E}_M(f^+ - f^-)\|_1 \leq \|\mathbb{E}_M(f^+)\|_1 + \|\mathbb{E}_M(f^-)\|_1,$$

but the latter term is equal to $\|f^+\|_1 + \|f^-\|_1 = \|f\|_1$, which finishes the proof. \square

REMARK D.4. By the previous proposition, \mathbb{E}_M admits a (necessarily unique) extension to a contraction

$$\mathbb{E}_M : L^1(X, \mu) \rightarrow L^1(M, \mu).$$

Moreover, since every non-negative integrable function can be written as an increasing limit of bounded non-negative functions, the analog of Proposition D.2 continues to hold for $f \in L^1(X, \mu)$.

D.2. Conditional measures

Throughout this section, we let $\chi_A : X \rightarrow \{0, 1\}$ denote the characteristic function of $A \subseteq X$.

DEFINITION D.5. Let M be a closed subalgebra of $\text{MAlg}(X, \mu)$. The **M -conditional measure** of $A \in \text{MAlg}(X, \mu)$, denoted by $\mu_M(A)$, is the conditional expectation of the characteristic function of A , i.e., $\mu_M(A) = \mathbb{E}_M(\chi_A)$.

In particular, the conditional measure $\mu_M(A)$ is an M -measurable function. It enjoys the following natural properties.

PROPOSITION D.6. *Let $M \subseteq \text{MAlg}(X, \mu)$ be a closed subalgebra. The following properties hold for all $A \in \text{MAlg}(X, \mu)$:*

- (1) $\mu_M(\emptyset) = 0$ and $\mu_M(X) = 1$, where 0 and 1 denote the constant maps;

- (2) $\mu_M(A)$ takes values in $[0, 1]$ and $\int_X \mu_M(A) = \mu(A)$;
(3) μ_M is σ -additive: if $A = \bigsqcup_n A_n$, $A_n \in \text{MAlg}(X, \mu)$, is a partition then

$$\mu_M(A) = \sum_{n \in \mathbb{N}} \mu_M(A_n),$$

where the convergence holds in $L^1(M, \mu)$;

- (4) if $T \in \text{Aut}(X, \mu)$ fixes every element of M , then $\mu_M(A) = \mu_M(T(A))$.

PROOF. The first item is clear from the fact that both \emptyset and X belong to M , so their characteristic functions are fixed by \mathbb{E}_M . The second item follows from the first and positivity of the conditional expectation; the equality is a direct consequence of Eq. D.2. The third one is a consequence of the L^1 continuity of \mathbb{E}_M and its linearity, noting that $\chi_A = \sum_n \chi_{A_n}$ in $L^1(M, \mu)$.

Finally, the last item follows from the uniqueness of conditional expectation given by Eq. D.2. Indeed, if an automorphism T fixes every element of M , then

$$\int_B f \circ T^{-1} d\mu = \int_{T(B)} f d\mu = \int_B f d\mu \quad \text{for all } B \in \text{MAlg}(X, \mu),$$

so $\mathbb{E}_M(f \circ T^{-1}) = \mathbb{E}_M(f)$. Taking $f = \chi_A$ for $A \in \text{MAlg}(X, \mu)$, we conclude that $\mu_M(T(A)) = \mu_M(A)$. \square

D.3. Conditional measures and full groups

Conditional measures, as defined in Section D.2, are associated with closed subalgebras of $\text{MAlg}(X, \mu)$. Each subgroup $\mathbb{G} \leq \text{Aut}(X, \mu)$ gives rise to the subalgebra of \mathbb{G} -invariant sets, and we may therefore associate a conditional measure with the group \mathbb{G} itself.

DEFINITION D.7. Let \mathbb{G} be a subgroup of $\text{Aut}(X, \mu)$. The closed **subalgebra of \mathbb{G} -invariant sets** is denoted by $M_{\mathbb{G}}$ and consists of all $A \in \text{MAlg}(X, \mu)$ such that $gA = A$ for all $g \in \mathbb{G}$.

By definition, $\mathbb{G} \leq \text{Aut}(X, \mu)$ is **ergodic** if $M_{\mathbb{G}} = \{\emptyset, X\}$. In this case, the $M_{\mathbb{G}}$ -conditional measure is the measure μ itself. The following lemma is an easy consequence of the definitions of the full group generated by a subgroup (Section 3.1) and the weak topology on $\text{Aut}(X, \mu)$.

LEMMA D.8. Let $\mathbb{G} \leq \text{Aut}(X, \mu)$ be a group.

- (1) If $[\mathbb{G}]$ is the full group generated by \mathbb{G} , then $M_{\mathbb{G}} = M_{[\mathbb{G}]}$.
(2) If $\Gamma \leq \mathbb{G}$ is dense in the weak topology, then $M_{\Gamma} = M_{\mathbb{G}}$.

Given a subgroup $\mathbb{G} \leq \text{Aut}(X, \mu)$, we denote the $M_{\mathbb{G}}$ -conditional measure simply by $\mu_{\mathbb{G}}$. Note that \mathbb{G} is ergodic if and only if $\mu_{\mathbb{G}} = \mu$.

Recall that a **partial measure-preserving automorphism** of (X, μ) is a measure-preserving bijection $\varphi : \text{dom } \varphi \rightarrow \text{rng } \varphi$ between measurable subsets of X , called the domain and the range of φ , respectively. The **pseudo full group** generated by a group $\Gamma \leq \text{Aut}(X, \mu)$ is denoted by $[[\Gamma]]$ and consists of all partial automorphisms $\varphi : \text{dom } \varphi \rightarrow \text{rng } \varphi$ for which there exists a partition $\text{dom } \varphi = \bigsqcup_n A_n$ and elements $\gamma_n \in \Gamma$ such that $\varphi \upharpoonright_{A_n} = \gamma_n \upharpoonright_{A_n}$ for all n . Elements of $[[\Gamma]]$ automatically preserve the conditional measure μ_{Γ} in view of item (4) of Proposition D.6.

LEMMA D.9. *Let $\mathbb{G} \leq \text{Aut}(X, \mu)$ be a group and let $A, B \in \text{MAlg}(X, \mu)$ satisfy $\mu_{\mathbb{G}}(A) = \mu_{\mathbb{G}}(B)$. There exists an element $\varphi \in [[\mathbb{G}]]$ such that $\text{dom } \varphi = A$ and $\text{rng } \varphi = B$.*

PROOF. Let $\Gamma = \{\gamma_n : n \in \mathbb{N}\}$ be a countable weakly dense subgroup of \mathbb{G} . Note that $\mu_{\Gamma}(A) = \mu_{\mathbb{G}}(A) = \mu_{\mathbb{G}}(B) = \mu_{\Gamma}(B)$ by Lemma D.8, and also clearly $[[\Gamma]] \leq [[\mathbb{G}]]$.

We define inductively sequences $(A_n)_n$ and $(B_n)_n$ of subsets of A and B respectively by setting $A_0 = A \cap \gamma_0^{-1}B$ and $B_0 = \gamma_0 A_0$, and then putting for $n \geq 1$

$$A_n = \left(A \setminus \bigcup_{m < n} A_m \right) \cap \gamma_n^{-1} \left(B \setminus \bigcup_{m < n} B_m \right) \quad \text{and} \quad B_n = \gamma_n A_n.$$

By construction, the sets A_n are pairwise disjoint subsets of A , $\gamma_n A_n = B_n$, and the sets B_n are pairwise disjoint subsets of B . We claim that $\varphi = \bigsqcup_n \gamma_n \upharpoonright_{A_n}$ is the desired element of $[[\mathbb{G}]]$.

Suppose towards a contradiction that either $\text{dom } \varphi \neq A$ or $\text{rng } \varphi \neq B$. Since Γ preserves μ_{Γ} and $\mu_{\Gamma}(A) = \mu_{\Gamma}(B)$, the sets $A \setminus \text{dom } \varphi$ and $B \setminus \text{rng } \varphi$ have the same M_{Γ} -conditional measure, which is not constantly equal to zero. The set $\tilde{A} = \bigcup_{\gamma \in \Gamma} \gamma(A \setminus \text{dom } \varphi)$ is Γ -invariant and non zero. Its conditional measure is therefore the characteristic function $\chi_{\tilde{A}}$, which must be greater than or equal to $\mu_{\Gamma}(A \setminus \text{dom } \varphi) = \mu_{\Gamma}(B \setminus \text{rng } \varphi)$. We conclude that $B \setminus \text{rng } \varphi \subseteq \bigcup_{\gamma \in \Gamma} \gamma(A \setminus \text{dom } \varphi)$. In particular, there is the first $n \in \mathbb{N}$ such that $(A \setminus \text{dom } \varphi) \cap \gamma_n^{-1}(B \setminus \text{rng } \varphi)$ is non zero. By construction, this set should be a subset of A_n , yielding the desired contradiction. \square

PROPOSITION D.10. *Let \mathbb{G} be a full subgroup of $\text{Aut}(X, \mu)$. The following conditions are equivalent for all $A, B \in \text{MAlg}(X, \mu)$:*

- (1) $\mu_{\mathbb{G}}(A) = \mu_{\mathbb{G}}(B)$;
- (2) there is $T \in \mathbb{G}$ such that $T(A) = B$.
- (3) there is an involution $T \in \mathbb{G}$ such that $T(A) = B$ and $\text{supp } T = A \triangle B$.

PROOF. The implication (2) \Rightarrow (1) is a direct consequence of the definition of $M_{\mathbb{G}}$ along with the item (4) of Proposition D.6. Also (3) \Rightarrow (2) is evident.

We now prove the implication (1) \Rightarrow (3). The assumption $\mu_{\mathbb{G}}(A) = \mu_{\mathbb{G}}(B)$ guarantees that $\mu_{\mathbb{G}}(A \setminus B) = \mu_{\mathbb{G}}(B \setminus A)$. Lemma D.9 applies and produces an element $\varphi \in [[\mathbb{G}]]$ such that $\varphi(A \setminus B) = B \setminus A$. The required involution T is then given by $\varphi \sqcup \varphi^{-1} \sqcup \text{id}_{X \setminus (A \triangle B)}$. \square

D.4. Aperiodicity

A countable subgroup $\Gamma \leq \text{Aut}(X, \mu)$ is called **aperiodic** if almost all the orbits of some (equivalently, any) realization of its action on (X, μ) are infinite. The so-called Maharam's lemma provides a characterization of aperiodicity in a purely measure-algebraic way. We begin by formulating a variant of the standard Marker Lemma for countable Borel equivalence relations (see, for instance, [KM04, Lemma 6.7]).

LEMMA D.11. *Let $\Gamma \curvearrowright X$ be a Borel action of a countable group on a standard Borel space X . For every Borel $C \subseteq X$, there is a decreasing sequence $(C_n)_n$ of Borel subsets of C such that $C \subseteq \Gamma \cdot C_n$ for each n , and the set $\bigcap_n C_n$ intersects the Γ -orbit of every $x \in X$ in at most one point. Furthermore, if all orbits of Γ are infinite, sets C_n can be chosen to have the empty intersection, $\bigcap_n C_n = \emptyset$.*

The following result is essentially due to H. Dye [Dye59], where it is called Maharam's lemma.

THEOREM D.12 (Maharam's lemma). *Let $\Gamma \leq \text{Aut}(X, \mu)$ be a countable subgroup. The following are equivalent:*

- (1) Γ is aperiodic;
- (2) for any $A \in \text{MAlg}(X, \mu)$ and any M_Γ -measurable function $f : X \rightarrow [0, 1]$ satisfying $f \leq \mu_\Gamma(A)$, there is $B \subseteq A$, $B \in \text{MAlg}(X, \mu)$, such that $\mu_\Gamma(B) = f$.

PROOF. Let us begin with the easier (2) \Rightarrow (1), which is proved by the contrapositive. Assume that (1) does not hold and Γ is not aperiodic. Let $n \in \mathbb{N}$ be such that the Γ -invariant set $X_n = \{x \in X : |\Gamma \cdot x| = n\}$ has non-zero measure. We may assume that X bears a Borel total order (for instance, by identifying X with $[0, 1]$). Let $A = \{x \in X_n : x = \max\{\Gamma \cdot x\}\}$ be the set of maximal points of the n -element Γ -orbits and set φ , $\text{dom } \varphi = X_n \setminus A$, to be the element of the pseudo full group $[[\Gamma]]$ that takes every $x \in X_n \setminus A$ to its \leftarrow -successor in the orbit $\Gamma \cdot x$. Given any $B \subseteq A$, the set $\bigsqcup_{k=0}^{n-1} \varphi^{-k}(B)$ is Γ -invariant, hence $\mu_\Gamma(\bigsqcup_{k=0}^{n-1} \varphi^{-k}(B))$ takes values in $\{0, 1\}$. Also

$$\mu_\Gamma\left(\bigsqcup_{k=0}^{n-1} \varphi^{-k}(B)\right) = \sum_{k=0}^{n-1} \mu_\Gamma(\varphi^{-k}(B)) = n\mu_\Gamma(B),$$

where the last equality is a consequence of Proposition D.6. We conclude that $\mu_\Gamma(B)$ necessarily takes values in $\{0, \frac{1}{n}\}$, which contradicts (2).

We now assume that Γ is aperiodic and prove the direct implication (1) \Rightarrow (2). The argument is based on the following crucial claim.

CLAIM. For every $C \in \text{MAlg}(X, \mu)$, for every M_Γ -measurable not almost surely zero $f : X \rightarrow [0, 1]$ such that $f \leq \mu_\Gamma(C)$, there is a non zero $B \subseteq C$ satisfying $\mu_\Gamma(B) \leq f$.

PROOF OF THE CLAIM. Let $(C_n)_n$ be a vanishing sequence of subsets of C given by Lemma D.11. Note that $\mu_\Gamma(C_n) \rightarrow 0$ in L^1 , since $\bigcap_n C_n = \emptyset$ and the C_n 's are decreasing. Passing to a subsequence, we may assume that convergence $\mu_\Gamma(C_n) \rightarrow 0$ holds pointwise. Set $B_n = \{x \in C_n : \mu_\Gamma(C_n)(x) \leq f(x)\}$ and note that $\mu_\Gamma(B_n) \leq \mu_\Gamma(C_n)$ and therefore $\mu_\Gamma(B_n) \leq f$.

Pointwise convergence $\mu_\Gamma(C_n) \rightarrow 0$ guarantees existence of an index n such that $\mu(B_n) > 0$, and so the set $B = B_n$ is as required. \square_{claim}

The conclusion of the theorem now follows from a standard application of Zorn's lemma¹. Indeed, the latter provides a maximal family $(B_i)_{i \in I}$ of pairwise disjoint positive measure elements of $\text{MAlg}(X, \mu)$ contained in A and satisfying $\sum_{i \in I} \mu_\Gamma(B_i) \leq f$. The index set I has to be countable, and if $B = \bigsqcup_{i \in I} B_i$ then $\mu_\Gamma(B) = \sum_{i \in I} \mu_\Gamma(B_i) \leq f$. Assume towards a contradiction that $\mu_\Gamma(B)$ is not equal to f almost everywhere, and use the previous claim to get a non null $B' \subseteq A \setminus B$ with $\mu_\Gamma(B') \leq f - \mu_\Gamma(B)$, contradicting the maximality of $(B_i)_{i \in I}$. Therefore $\mu_\Gamma(B) = f$ as claimed. \square

We conclude this appendix with a useful consequence of aperiodicity.

¹A more constructive version of the whole argument can be found in [LM14, Prop. D.1].

LEMMA D.13. *Let $\mathbb{G} \leq \text{Aut}(X, \mu)$ be an aperiodic full group. For each set $B \in \text{MAlg}(X, \mu)$, there is an involution $U \in \mathbb{G}$ whose support is equal to B .*

PROOF. Theorem D.12 gives $A \subseteq B$ such that $\mu_{\mathbb{G}}(A) = \mu_{\mathbb{G}}(B)/2$. We then have $\mu_{\mathbb{G}}(B \setminus A) = \mu_{\mathbb{G}}(B) - \mu_{\mathbb{G}}(A) = \mu_{\mathbb{G}}(A)$, and item (3) of Proposition D.10 provides an involution $T \in \mathbb{G}$ satisfying $T(B \setminus A) = A$ and $\text{supp } T = (B \setminus A) \triangle A = B$. \square

REMARK D.14. Lemma D.13, in fact, characterizes aperiodicity of full groups: if \mathbb{G} is not aperiodic, then there is some $B \in \text{MAlg}(X, \mu)$ which is not the support of any involution since its $M_{\mathbb{G}}$ -conditional measure cannot be split in half (see the proof of the direct implication in Theorem D.12).

Bibliography

- [ADR00] C. Anantharaman-Delaroche and J. Renault, *Amenable groupoids*, Monographies de L'Enseignement Mathématique [Monographs of L'Enseignement Mathématique], vol. 36, L'Enseignement Mathématique, Geneva, 2000, With a foreword by Georges Skandalis and Appendix B by E. Germain. MR 1799683
- [Aus16] Tim Austin, *Behaviour of Entropy Under Bounded and Integrable Orbit Equivalence*, Geometric and Functional Analysis **26** (2016), no. 6, 1483–1525.
- [Ban32] Stefan Banach, *Théorie des opérations linéaires*, Warsaw, 1932.
- [BdlHV08] Bachir Bekka, Pierre de la Harpe, and Alain Valette, *Kazhdan's property (T)*, vol. 11, Cambridge University Press, Cambridge, 2008 (English).
- [Bec13] Howard Becker, *Cocycles and continuity*, Trans. Amer. Math. Soc. **365** (2013), no. 2, 671–719. MR 2995370
- [Bel68] R. M. Belinskaja, *Partitionings of a Lebesgue space into trajectories which may be defined by ergodic automorphisms*, Funkcional. Anal. i Priložen. **2** (1968), no. 3, 4–16. MR 0245756
- [BK96] Howard Becker and Alexander S. Kechris, *The descriptive set theory of Polish group actions*, London Mathematical Society Lecture Note Series, vol. 232, Cambridge University Press, Cambridge, 1996. MR 1425877
- [BO10] Nicholas H. Bingham and Adam J. Ostaszewski, *Normed versus topological groups: dichotomy and duality*, Dissertationes Math. **472** (2010), 138. MR 2743093
- [CFW81] Alain Connes, Jacob Feldman, and Benjamin Weiss, *An amenable equivalence relation is generated by a single transformation*, Ergodic Theory Dynam. Systems **1** (1981), no. 4, 431–450 (1982). MR 662736
- [CJMT22] Alessandro Carderi, Matthieu Joseph, François Le Maître, and Romain Tessera, *Belinskaya's theorem is optimal*, 2022.
- [CLM16] Alessandro Carderi and François Le Maître, *More Polish full groups*, Topology Appl. **202** (2016), 80–105. MR 3464151
- [CLM18] ———, *Orbit full groups for locally compact groups*, Trans. Amer. Math. Soc. **370** (2018), no. 4, 2321–2349. MR 3748570
- [DHU08] Manfred Droste, W. Charles Holland, and Georg Ulbrich, *On full groups of measure-preserving and ergodic transformations with uncountable cofinalities*, Bulletin of the London Mathematical Society **40** (2008), no. 3, 463–472.
- [Dye59] Henry A. Dye, *On Groups of Measure Preserving Transformations. I*, American Journal of Mathematics **81** (1959), no. 1, 119–159.
- [FHM78] Jacob Feldman, Peter Hahn, and Calvin C. Moore, *Orbit structure and countable sections for actions of continuous groups*, Adv. in Math. **28** (1978), no. 3, 186–230. MR 492061
- [Fre04] David H. Fremlin, *Measure theory. Vol. 3*, Torres Fremlin, Colchester, 2004, Measure algebras, Corrected second printing of the 2002 original. MR 2459668 (2011a:28003)
- [Fre06] ———, *Measure theory. Vol. 4*, Torres Fremlin, Colchester, 2006, Topological measure spaces. Part I, II, Corrected second printing of the 2003 original. MR 2462372
- [GK21] Marlies Gerber and Philipp Kunde, *Anti-classification results for the Kakutani equivalence relation*, September 2021.
- [GM89] Siegfried Graf and R. Daniel Mauldin, *A classification of disintegrations of measures*, Measure and measurable dynamics (Rochester, NY, 1987), Contemp. Math., vol. 94, Amer. Math. Soc., Providence, RI, 1989, pp. 147–158. MR 1012985
- [GP02] Thierry Giordano and Vladimir Pestov, *Some extremely amenable groups*, C. R. Math. Acad. Sci. Paris **334** (2002), no. 4, 273–278. MR 1891002

- [GPS99] Thierry Giordano, Ian F. Putnam, and Christian F. Skau, *Full groups of Cantor minimal systems*, Israel J. Math. **111** (1999), 285–320. MR 1710743
- [GTW05] Eli Glasner, Boris Tsirelson, and Benjamin Weiss, *The automorphism group of the Gaussian measure cannot act pointwise*, Israel Journal of Mathematics **148** (2005), no. 1, 305–329.
- [Hal17] Paul R. Halmos, *Lectures on ergodic theory*, Dover Publications, Mineola, NY, 2017.
- [Kat75] Anatole B. Katok, *Time change, monotone equivalence, and standard dynamical systems*, Doklady Akademii Nauk SSSR **223** (1975), no. 4, 789–792. MR 0412383
- [Kat77] ———, *Monotone equivalence in ergodic theory*, Izvestiya Akademii Nauk SSSR. Seriya Matematicheskaya **41** (1977), no. 1, 104–157, 231. MR 0442195
- [Kec92] Alexander S. Kechris, *Countable sections for locally compact group actions*, Ergodic Theory Dynam. Systems **12** (1992), no. 2, 283–295. MR 1176624
- [Kec95] ———, *Classical descriptive set theory*, Graduate Texts in Mathematics, vol. 156, Springer-Verlag, New York, 1995.
- [Kec10] ———, *Global aspects of ergodic group actions*, Mathematical Surveys and Monographs, vol. 160, American Mathematical Society, Providence, RI, 2010. MR 2583950
- [KM04] Alexander S. Kechris and Benjamin D. Miller, *Topics in orbit equivalence*, Lecture Notes in Mathematics, no. 1852, Springer, Berlin ; New York, 2004.
- [KPV15] David Kyed, Henrik Petersen, and Stefaan Vaes, *L^2 -Betti numbers of locally compact groups and their cross section equivalence relations*, Trans. Amer. Math. Soc. **367** (2015), no. 7, 4917–4956.
- [Kre85] Ulrich Krengel, *Ergodic theorems*, De Gruyter Studies in Mathematics, vol. 6, Walter de Gruyter & Co., Berlin, 1985, With a supplement by Antoine Brunel. MR 797411
- [KST99] Alexander S. Kechris, Slawomir Solecki, and Stevo Todorcevic, *Borel chromatic numbers*, Adv. Math. **141** (1999), no. 1, 1–44. MR 1667145
- [Kun23] Philipp Kunde, *Anti-classification results for weakly mixing diffeomorphisms*, March 2023.
- [LM14] François Le Maître, *Sur les groupes pleins préservant une mesure de probabilité*, Ph.D. thesis, ENS Lyon, 2014.
- [LM16] François Le Maître, *On full groups of non-ergodic probability-measure-preserving equivalence relations*, Ergodic Theory Dynam. Systems **36** (2016), no. 7, 2218–2245. MR 3568978
- [LM18] ———, *On a measurable analogue of small topological full groups*, Adv. Math. **332** (2018), 235–286. MR 3810253
- [LM21] ———, *On a measurable analogue of small topological full groups II*, Ann. Inst. Fourier (Grenoble) **71** (2021), no. 5, 1885–1927. MR 4398251
- [Mac62] George W. Mackey, *Point realizations of transformation groups*, Illinois J. Math. **6** (1962), 327–335. MR 143874
- [Mah50] Dorothy Maharam, *Decompositions of measure algebras and spaces*, Trans. Amer. Math. Soc. **69** (1950), 142–160. MR 36817
- [Mah84] ———, *On the planar representation of a measurable subfield*, Measure theory, Oberwolfach 1983 (Oberwolfach, 1983), Lecture Notes in Math., vol. 1089, Springer, Berlin, 1984, pp. 47–57. MR 786682
- [Mil77] Douglas E. Miller, *On the measurability of orbits in Borel actions*, Proc. Amer. Math. Soc. **63** (1977), no. 1, 165–170. MR 440519
- [Mil04] Benjamin D. Miller, *Full groups, classification, and equivalence relations*, Ph.D. thesis, University of California, Berkeley, 2004.
- [Nac65] Leopoldo Nachbin, *The Haar integral*, D. Van Nostrand Co., Inc., Princeton, N.J.-Toronto-London, 1965. MR 0175995
- [Nek19] Volodymyr Nekrashevych, *Simple groups of dynamical origin*, Ergodic Theory Dynam. Systems **39** (2019), no. 3, 707–732. MR 3904185
- [ORW82] Donald S. Ornstein, Daniel J. Rudolph, and Benjamin Weiss, *Equivalence of measure preserving transformations*, Memoirs of the American Mathematical Society **37** (1982), no. 262, xii+116. MR 653094
- [PS17] Vladimir G. Pestov and Friedrich Martin Schneider, *On amenability and groups of measurable maps*, J. Funct. Anal. **273** (2017), no. 12, 3859–3874. MR 3711882
- [Ros21] Christian Rosenthal, *Coarse Geometry of Topological Groups*, Cambridge Tracts in Mathematics, Cambridge University Press, Cambridge, 2021.

- [Ros22] ———, *Coarse geometry of topological groups*, Cambridge Tracts in Mathematics, vol. 223, Cambridge University Press, Cambridge, 2022. MR 4327092
- [RS98] Guyan Robertson and Tim Steger, *Negative definite kernels and a dynamical characterization of property (T) for countable groups*, Ergodic Theory and Dynamical Systems **18** (1998), no. 1, 247–253 (en).
- [Rud76] Daniel Rudolph, *A two-valued step coding for ergodic flows*, Mathematische Zeitschrift **150** (1976), no. 3, 201–220.
- [Ryz85] V. V. Ryzhikov, *Representation of transformations preserving the lebesgue measure in the form of periodic transformations*, Mathematical notes of the Academy of Sciences of the USSR **38** (1985), no. 6, 978–981.
- [Slu17] Konstantin Slutsky, *Lebesgue orbit equivalence of multidimensional Borel flows: a picturebook of tilings*, Ergodic Theory Dynam. Systems **37** (2017), no. 6, 1966–1996. MR 3681992
- [Slu19] ———, *Regular cross sections of Borel flows*, Journal of the European Mathematical Society **21** (2019), no. 7, 1985–2050.
- [Str74] Raimond A. Struble, *Metrics in locally compact groups*, Compositio Math. **28** (1974), 217–222. MR 348037
- [Var63] Veeravalli S. Varadarajan, *Groups of automorphisms of Borel spaces*, Trans. Amer. Math. Soc. **109** (1963), 191–220. MR 159923