

# MetaSketch: Wireless Semantic Segmentation by Metamaterial Surfaces

Jingzhi Hu, *Student Member, IEEE*, Hongliang Zhang, *Member, IEEE*,

Kaigui Bian, *Senior Member, IEEE*, Zhu Han, *Fellow, IEEE*,

H. Vincent Poor, *Life Fellow, IEEE*, and Lingyang Song, *Fellow, IEEE*

## Abstract

Semantic segmentation is a process of partitioning an image into multiple segments for recognizing humans and objects, which can be widely applied in scenarios such as healthcare and safety monitoring. To avoid privacy violation, using RF signals instead of an image for human and object recognition has gained increasing attention. However, human and object recognition by using RF signals is usually a passive signal collection and analysis process without changing the radio environment, and the recognition accuracy is restricted significantly by unwanted multi-path fading, and/or the limited number of independent channels between RF transceivers in uncontrollable radio environments. This paper introduces MetaSketch, a novel RF-sensing system that performs semantic recognition and segmentation for humans and objects by making the radio environment reconfigurable. A metamaterial surface is incorporated into MetaSketch and diversifies the information carried by RF signals. Using compressive sensing techniques, MetaSketch reconstructs a point cloud consisting of the reflection coefficients of humans and objects at different spatial points, and recognizes the semantic meaning of the points by using symmetric multilayer perceptron groups. Our evaluation results show that MetaSketch is capable of generating favorable radio environments and extracting exact point clouds, and labeling the semantic meaning of the points with an average error rate of less than 1% in an indoor space.

## Index Terms

RF sensing, reconfigurable intelligent surface, semantic segmentation, compressive sensing.

This work has been submitted to the IEEE for possible publication. Copyright may be transferred without notice, after which this version may no longer be accessible.

J. Hu and L. Song are with Department of Electronics, Peking University, China (e-mails: {jingzhi.hu, lingyang.song}@pku.edu.cn).

H. Zhang and H. Vincent Poor are with Department of Electrical Engineering, Princeton University, USA (e-mails: hongliang.zhang92@gmail.com, poor@princeton.edu).

K. Bian is with Department of Computer Science, Peking University, China (e-mail: bkg@pku.edu.cn).

Z. Han is with the Department of Electrical and Computer Engineering, University of Houston, USA, and also with the Department of Computer Science and Engineering, Kyung Hee University, South Korea (e-mail: zhan2@uh.edu).

## I. INTRODUCTION

In computer vision, semantic segmentation seeks to partition the pixel set of an image into multiple subsets, with each subset having the same semantic meaning. Owing to its wide applications in public safety and healthcare monitoring scenarios, semantic segmentation has garnered significant interest recently as a powerful tool for simultaneous recognition and localization of humans and objects. Generally, semantic segmentation is conducted over images captured by video cameras and used to obtain meaningful representations for the images to simplify and facilitate further potential analyses [1].

However, using video cameras to collect images for semantic segmentation inevitably introduces privacy concerns. As a potential solution, recently using RF signals for profiling humans and objects has gained broad interest in research in this field. Many RF-sensing systems based on WiFi signals or millimeter waves have been proposed for recognizing humans and objects [2–6], or generating images that can be further used as materials for semantic segmentation [7–9]. However, human and object recognition by using RF signals usually employs a passive signal collection and analysis process without changing the radio environment. Hence, due to the complicated and unpredictable radio environments, the accuracy and flexibility of recognition can be affected significantly by undesirable multi-path fading [10–11], and/or the limited number of independent channels from the transmitters to the receivers in the conventional RF-sensing systems.

Recently, metamaterial surfaces, i.e., metasurfaces, have been developed as a promising solution to actively customize the undesirable propagation channels into favorable radio environments [12]. A metasurface is composed of a massive number of electrically controllable elements, which applies different phase-shifts to the signals reflected by it. By optimally programming its elements, a metasurface mounted in a radio environment can generate a massive number of independent propagation channels, which allows RF signals to carry diverse information about humans and objects. Therefore, sensing based on the use of a metasurface potentially lead to more accurate semantic recognition and segmentation results than those of traditional RF-sensing systems. This also introduces a new way of RF sensing that, instead of using more complicated and sophisticated RF transmitters and receivers, using a metasurface with the capability of active channel customization to obtain high-fidelity results.

In this paper, we present MetaSketch, a metasurface-based RF-sensing system that can extract

a point cloud from the RF signals reflected by humans and objects, which consists of the reflection coefficients in the spatial points, and perform semantic segmentation on the point cloud to recognize the humans and objects. Specifically, via programming metasurface configurations, MetaSketch creates multiple independent propagation channels which facilitate the point cloud extraction. Since metasurfaces rather than video cameras are employed for generating images for segmentation, MetaSketch is designed to be privacy-protecting, and thus it has a wide variety of applications in healthcare and security monitoring scenarios.

The grand challenge of building a system that extracts point clouds without cameras is the absence of a method to directly capture an image of humans and objects by RF signals or to match an image to a certain set of received signals. Therefore, existing systems cannot reconstruct images from RF signals directly. Instead, MetaSketch seeks to extract the point clouds directly from processing the RF signals by compressive sensing, without relying on the reconstructed images. The design of MetaSketch is structured around three components that together provide an architecture for using compressive sensing and semantic segmentation for metasurface-based RF-sensing systems: (1) A *radio environment reconfiguration module* to create multiple independent propagation channels and facilitate compressive sensing based on metasurface, (2) a *point cloud extraction module* that extracts reflection characteristics of different positions in space, and (3) a *semantic segmentation module* to recognize humans and objects and label the point clouds with their semantic meaning.

We evaluate the semantic segmentation capability of MetaSketch over daily scenarios that involve a human and a set of practical objects. Experiment results show that MetaSketch can extract point clouds in space from RF signals and perform semantic segmentation accurately with an average error rate of less than 1%, given the setup of a human and three objects in a  $1.6 \text{ m}^3$  indoor space represented by 400 evenly distributed points.

The rest of the paper is organized as follows. Section II reviews related work on RF-sensing systems and video-image-based semantic segmentation. Section III provides preliminaries required to understand the design of MetaSketch. In Section IV, we describe the system model MetaSketch, including the system components and the coordination protocol among components. Then, we describe the three component modules of MetaSketch, i.e., the radio environment reconfiguration module in Section V-A, the point cloud extraction module in Section V-B, and the semantic segmentation module in Section V-C. Section VI describes the implementation of MetaSketch, and Section VII shows the results of a performance evaluation of MetaSketch.

Finally, we summarize the paper and discuss the technical issues for enhancing MetaSketch in Section VIII.

## II. RELATED WORK

In this section, we first explain the advantages of the proposed metasurface-based segmentation in this paper, then we summarize the related work for this paper, including the existing literature on RF-sensing systems and the image-based semantic segmentation technique.

One of the advantages of using the RF-sensing system for segmentation instead of image-based systems is for privacy protection. Specifically, as RF-sensing can be independent of video cameras in data collection, which prevents any invasion of privacy. In addition, regarding the customization of radio environments, the metasurface is capable of reconfiguring the propagation channels between RF transceivers into various favorable shapes, and can be used to enhance the RF-sensing systems [11], e.g., the metasurface can generate propagation channels which are mutually independent by programming its configurations. Since RF signals traveling over independent channels generally carry more diverse information than those on coherent ones, adopting metasurface in the RF-sensing system can potentially increase the accuracy of locating and recognizing humans and objects [13–14]. In other words, owing to the capability of reconfiguring radio environments, the metasurface-based RF-sensing system can provide more reliable materials to perform semantic segmentation, compared with existing RF-sensing systems.

### A. *RF-sensing Systems*

Recent years have witnessed much interest in RF-sensing systems for human and object recognition. Existing systems work by analyzing the influence of human body and objects on the RF signals. Different systems are designed for people localization [15–16] and particular posture- and gesture-identification [13, 17–20]. Besides, RF-sensing also proves to be feasible for imaging humans and objects with the help of MIMO techniques [7, 21].

### B. *Image-based Semantic Segmentation*

In semantic segmentation, usually, each segment is a set of pixels of the image which collectively represent one semantically meaningful object, e.g., a human or a suitcase in the image. Most semantic segmentation approaches are based on processing images captured from 2D video cameras. The 2D semantic segmentation techniques are becoming mature due to

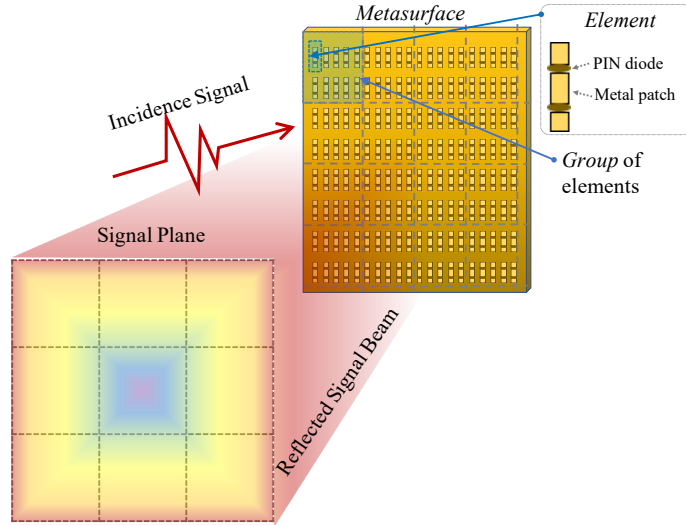

Fig. 1. Metasurface elements and signal reflection on metasurface.

the increasing availability of the deep convolutional network model, e.g., fully convolutional networks [22], R-CNNs [23], and deep convolutional encoder-decoders [24].

Different from the increasingly matured segmentation in 2D, the semantic segmentation in 3D has gained more attention. Authors in [25] proposed to construct human skeletons in 3D from 2D images by using convolutional neural networks combined with kinematic skeleton fitting. Besides, authors in [26] explored deep learning architectures capable of reasoning about geometric data other than 2D images such as 3D point clouds and meshes. This lays the foundation for semantic recognition and segmentation in metasurface-based RF-sensing systems where the reflection coefficients in space points are captured and form a point cloud.

### III. PRELIMINARIES

In this section, we show preliminary results that lead to successfully building the three components of MetaSketch.

#### A. Pilot Experiment for Reconfiguring Radio Environment by Metasurface

We first explain the metasurface and its elements, and then elaborate on a pilot experiment which illustrate their capability of reconfiguring radio environments.

1) *Metasurface elements and states*: Metasurface is an artificial thin film of reconfigurable electromagnetic materials, which is composed of a massive number of uniformly distributed *metasurface elements*. As shown in Fig. 1, metasurface elements are arranged in a two-dimensional

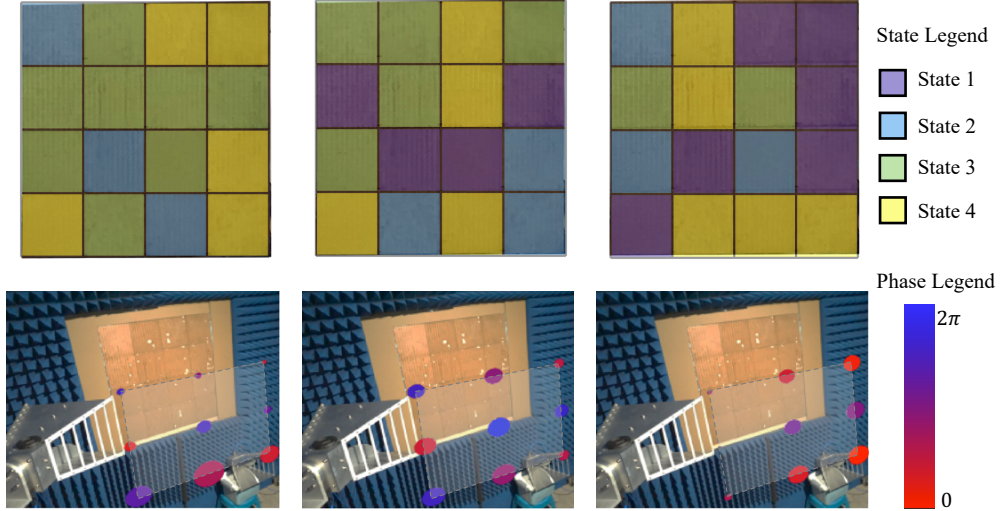

Fig. 2. Configurations of the metasurface and the corresponding reflected signals at different positions.

array. For each metasurface element, it can adjust its response to the incident RF signals by leveraging positive-intrinsic-negative (PIN) diodes [27]. We refer to the different responses of a metasurface as the *states* of the metasurface element. The metasurface elements can be set to different states, and each state of the metasurface element shows its own electrical property, leading to a unique reflection coefficient for the incident RF signals. To be specific, the reflection coefficients of a metasurface element at different states can be represented as a complex number. The amplitude and phase of the reflection coefficient denote the amplitude ratio and the phase shift between the reflected and incident signals, respectively.

Due to the number of metasurface elements within a metasurface is usually large, it is costly and inefficient to control each metasurface element independently. To reduce the controlling complexity, we divide the metasurface elements into multiple *groups*, as shown in Fig. 1. Therefore, the states of all metasurface elements can be represented by the states of the groups, which we referred to as the *configuration* of the metasurface.

2) *Visualization of reconfiguring radio environment*: Through changing its configuration, the metasurface is able to modify the waveforms of the reflected signals and form directional beams [28]. Based on [29], the beamforming capability of a metasurface can be characterized as follows. Given a spatial position in front of the metasurface, the radio signal at that position is

$$y = \sum_{n=1}^N \frac{\lambda \exp(-j2\pi d_n/\lambda)}{4\pi d_n} \cdot r_n(s_n) \cdot x_n \quad (1)$$

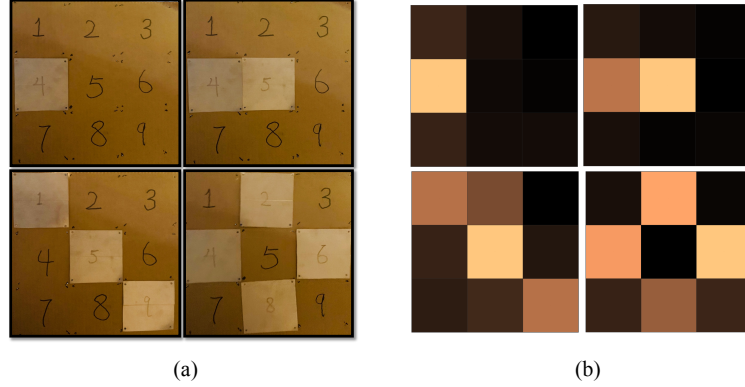

Fig. 3. (a) The signal plane with 10 cm  $\times$  10 cm metal patches at part of the 9 positions; and (b) illustrations of the reconstructed absolute values of the reflection coefficients at different positions by solving (3).

where  $N$  denotes the number of metasurface elements,  $\lambda$  is the wavelength of the transmitted sine wave,  $n$  denotes the index of a metasurface element,  $d_n$  denotes the distance from the it to the position,  $s_n$  denotes the state of it and  $x_n$  is the incident signal of it. Besides,  $r_n(s_n)$  is the reflection coefficient of the metasurface element  $n$ , which is dependent on state  $s_n$  and the physical structure of the metasurface element.

With the beamforming capability, the metasurface can reconfigure the radio environment for the incident signals and reflect diverse beam patterns in front of it. To show the metasurface's capability of reconfiguring the radio environment we conduct a pilot environment by changing the configuration of the metasurface randomly, and measuring the reflected signals at 9 different positions on a plane around 1.2 m in front of the metasurface. In Fig. 2, the configurations of the metasurface are depicted in the upper part, where the four colors indicate four different states of groups. Besides, the corresponding reflected signals are visualized as colored solid circles (red, blue, or purple) in the lower part. In the lower part, the size of each circle is proportional to the signal amplitude, and the color represents the signal phase. It can be observed that by changing the configuration of metasurface, the strength and phase of the reflected signals at different positions can be modified.

### B. Feasibility of Extracting Point Cloud via Compressive Sensing

In the following, we demonstrate the method of extracting point cloud based on the received RF signals in a metasurface-assisted system. Specifically, we first introduce the compressive

sensing technique, and then illustrate the feasibility of recovering the reflection coefficients using the compressive sensing technique.

1) *Compressive sensing technique*: The compressive sensing technique is developed to recover signals from highly incomplete information [30]. We need to restore the reflection coefficients at many positions in space from a limited amount of measurement signals and extract the point clouds. Hence, when we use the compressive sensing technique, the main focus is to solve some target variable  $\mathbf{x}$  in underdetermined equation under some noise  $\mathbf{e}$  given measurement  $\mathbf{y}$  and measurement matrix  $\mathbf{H}$ , i.e.,

$$\mathbf{y} = \mathbf{H}\mathbf{x} + \mathbf{e}, \quad (2)$$

where the dimension of  $\mathbf{y}$ , i.e.,  $\dim(\mathbf{y})$ , is much less than  $\dim(\mathbf{x})$ , and the number of non-zero elements of  $\mathbf{x}$  is much less than its dimension, indicating that  $\mathbf{x}$  is *sparse*. Mathematically, the sparsity can be evaluated by  $l_0$ -norm defined by  $\|\mathbf{x}\|_0 = |\{i \in [1, \dim(\mathbf{x})] | x_i \neq 0\}|$ , where  $|\cdot|$  denotes the number of elements in the contained set.

Given  $\mathbf{x}$  to be sparse, solving  $\mathbf{x}$  in (2) can be done by minimizing  $\|\mathbf{x}\|_0$  subject to  $\|\mathbf{y} - \mathbf{H}\mathbf{x}\|_2 \leq \epsilon$ , where  $\epsilon$  denotes the variance of noise  $\mathbf{e}$ . However, due to the non-convexity of  $l_0$  norm minimization, it is infeasible for most practical applications. An alternative approach suggested in [31] is the  $l_1$ -norm minimization approach, which solve sparse vector  $\mathbf{x}$  in (2) by solving

$$\hat{\mathbf{x}} = \arg \min_{\mathbf{x}} \|\mathbf{x}\|_1 \quad \text{s.t.} \quad \|\mathbf{H}\mathbf{x} - \mathbf{y}\|_2 \leq \epsilon. \quad (3)$$

As shown in [31], if a sparse variable  $\mathbf{x}$  exists such that  $\mathbf{y} = \mathbf{H}\mathbf{x} + \mathbf{e}$ , for some small error term  $\|\mathbf{e}\|_2 \leq \epsilon$ , then the solution for (3)  $\hat{\mathbf{x}}$  will be close to the real  $\mathbf{x}$ .

2) *Feasibility of recovering the reflection coefficients*: As an example to verify the feasibility of extracting point cloud via compressive sensing, we try using metasurface MetaSketch to reconstruct the average reflection coefficients of a 9-rectangle grids in space. We place one 10 cm  $\times$  10 cm metal patch at the 9 positions on the signal plane shown in Fig. 2 in turn and measure the corresponding received signals when the metasurface takes 5 random configurations. Based on the received signal sequences at the 9 points, the measurement matrix  $\mathbf{H}$  is obtained, i.e.,

$$\mathbf{H} = \begin{bmatrix} \hat{\mathbf{y}}_1 & \dots & \hat{\mathbf{y}}_9 \end{bmatrix}. \quad (4)$$

Here,  $\hat{\mathbf{y}}_i = \mathbf{y}_i^M - \mathbf{y}^B$  ( $i \in [1, 9]$ ) is the  $i$ -th column of  $\mathbf{H}$  and indicates the influence of a metal patch at  $i$ -th grid on the received signals, where  $\mathbf{y}_i^M$  denotes the received signal vector given the



metal patch located at the  $i$ -th grid and  $\mathbf{y}^B$  indicates the received signal vector given no metal patch presented.

Then, we place multiple metal patches on the 9 grids, obtain received signal  $\mathbf{y}$ , and solve (3) to obtain  $\mathbf{x}$ , which is a 9-dim complex vector indicating the average reflection coefficients of the 9 grids with respect to the metal patch. Fig. 3 (a) shows the photo of the pattern that the metal patches form, where the light (yellow) regions are the metal patches, and the dark (brown) regions are the cardboards, which have a negligible impact on wireless signals. Fig. 3 (b) illustrates the reconstructed amplitude of the average reflection coefficients at the 9 grids, where the lighter color indicates a higher reflection coefficient value indicating the position of metal patches. Comparing Figs. 3 (a) and (b), we can observe that solving (3) successfully reconstructs the reflection characteristics of the 9 grids, which shows the feasibility of extracting point cloud via compressive sensing based on metasurface.

Based on the extracted point clouds, MetaSketch can then perform semantic recognition and segmentation on the points. Compared with the existing RF-sensing system with a metasurface [32] which relies on cameras to capture profiles of human and links them with RF signals, MetaSketch uses point clouds extracted by using compressive sensing as input data, which prevents raising privacy concerns.

### C. Point Clouds Recognition using Symmetric Multilayer Perceptron Groups

In order to recognize humans and objects in an extracted point cloud, semantic segmentation is necessary for feature learning [22, 33]. To be specific, given a set of points, we aim to label each point with its semantic meaning. However, as the point clouds are essentially point sets, they are invariant to changing order, which make them different from conventional data structures for semantic segmentation such as pixel images [26]. Therefore, traditional semantic segmentation methods based on convolutional neural networks [22, 33] cannot be used here, as they rely on the convolution operation on input data arranged in spatial order for regional feature extraction. In order to handle the unordered properties of point cloud data structure, the input data need to be treated by symmetric functions. As proven in [26], this can be achieved effectively by using multi-layer perceptrons (MLPs) with shared parameters to treat the feature vectors of points in the point cloud.

An MLP can be considered as a mathematical function mapping that is constituted by many tunable functions in simpler forms [34]. In MetaSketch, the MLP is used to extract a more

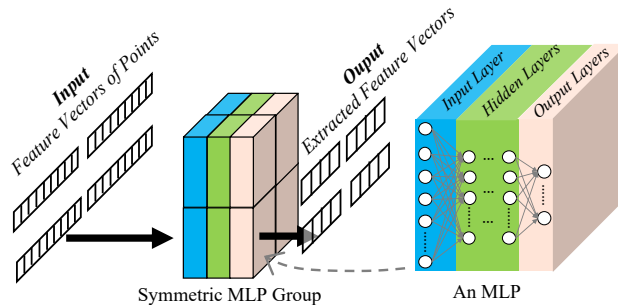

Fig. 4. Illustration on a symmetric MLP group to process the feature vectors in a point cloud.

representative feature vector of each point from its ordinary one, in order to facilitate point recognition.

More specifically, as shown in Fig. 4, an MLP contains multiple layers of *neurons* that extract information from the input feature vector. Each neuron takes input from the connected neurons in the lower layer, handles them by weighted summation with bias and an activation function (e.g., sigmoid), and outputs the result value to the upper layer.

In MetaSketch, since the point cloud is an unordered set, the MLP to treat each point needs to be symmetric. Therefore, we ensure that the MLPs to have the same parameters by parameter sharing, and refer to them as a symmetric MLP group. In a symmetric MLP group in MetaSketch, the input to each MLP can be the position and reflection coefficient of its point as well as an extracted feature vector from a previous MLP, and the output can be a feature vector with higher/lower dimensions or the semantic recognition result for that point.

#### IV. SYSTEM MODEL

In this section, we describe the system model of MetaSketch by describing three system components and a protocol that coordinates the messages transmission among the components.

##### A. System Components

MetaSketch is an RF-sensing system that can extract point clouds of humans and objects in space and perform semantic segmentation on the point clouds. As illustrated in Fig. 5, the system contains the following three component modules:

- **Radio environment reconfiguration module:** This module contains a pair of RF transceivers and a metasurface. The pair of transceiver consists of a transmitter (Tx) and a receiver (Rx), which are equipped with single antennas to transmit and receive RF signals, respectively.

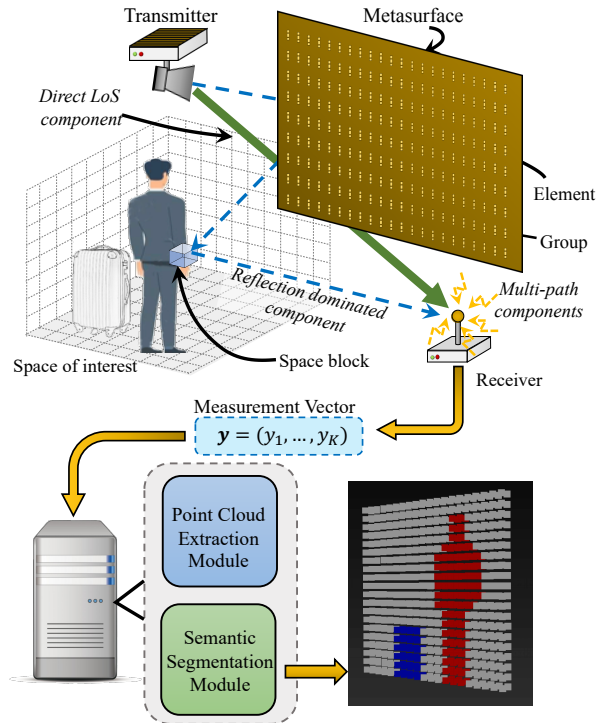

Fig. 5. Components of MetaSketch: metasurface-based radio environment reconfiguration (as shown in the top half of the figure), point cloud extraction, and semantic segmentation modules (as shown in the bottom half of the figure).

The metasurface reflects and reshapes incident signals according to its configuration. The transmitted signals from the Tx are modified by the metasurface and then reach the humans and objects, carrying out the information of them to the Rx.

- **Point cloud extraction module:** This module is implemented in the sever connected to the Rx and adopts a compressive sensing technique to extract the point cloud from the baseband RF signals from the Rx, which is the reflection coefficients at different space points.
- **Semantic segmentation module:** The obtained point cloud in the previous module is then inputted into the semantic segmentation module implemented in the server. The semantic segmentation module recognizes humans and objects in the point cloud and labels each point with its semantic meaning. In this module, the MLPs are adopted and trained by supervised learning method.

### B. Coordination Protocol

In the following, we propose a protocol to coordinate the component modules of MetaSketch to perform RF-sensing, point cloud extraction, and semantic segmentation. In the protocol, the

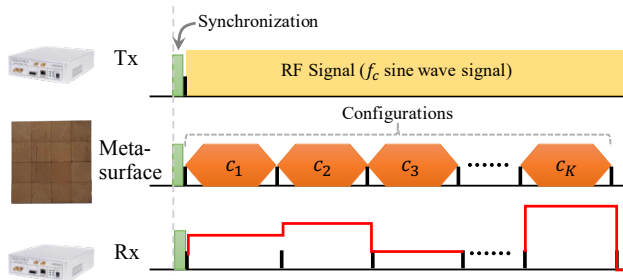

Fig. 6. Illustration on the data collection phase.

timeline is slotted and divided into *cycles*, and MetaSketch operates in a synchronized and periodic manner. Each cycle is constituted of two phases: *data collection* and *signal processing* phases. As illustrated in Fig. 6, in the data collection phase, the metasurface changes configuration sequentially. The receiver measures the received signals during every configuration and stores them as a vector, referred to as the *measurement vector*.

The signal processing phase follows the data collection phase, where the point cloud extraction and semantic segmentation modules are invoked to process the obtained data sequentially. In the following part, we describe the data collection and signal processing phases in detail.

1) *Data collection phase:* At the beginning of the data collection phase, the Tx first transmits a starting signal to the metasurface and the receiver for synchronization. Then, the Tx starts to transmit sine wave signal with frequency  $f_c$ , and the metasurface changes sequentially from the first to the  $K$ -th configuration, which are denoted by  $c_1$  to  $c_K$  with  $K$  being the total number of configurations, as shown in Fig. 6. Specifically,  $c_k$  ( $k \in [1, K]$ ) is a  $L$ -dim vector where  $L$  is the number of groups of the metasurface. Moreover, the  $K$  configurations of the metasurface constitutes *measurement matrix*  $\mathbf{C}$ , i.e.,  $\mathbf{C} = (c_1, \dots, c_K)$ . While random  $\mathbf{C}$  can be adopted, we propose the method to obtain an optimized configuration matrix in Section V-A.

At the end of the data collection phase, the Rx generates the  $K$ -dim measurement vector  $\mathbf{y}$  by taking the averages of the received signals within  $K$  configuration duration. Then, the Rx sends  $\mathbf{y}$  to the sever for point cloud extraction and semantic segmentation.

2) *Signal processing phase:* After receiving the measurement vector generated by the Rx, the sever first invokes the point cloud extraction module to extract the point cloud of the humans and objects from the measurement vector. Then, the generated point cloud image is processed by the semantic segmentation module, which provides each point with the label representing its semantic meaning. The point cloud extraction module will be introduced in Section V-B, and

the semantic segmentation module will be elaborated in Section V-C.

## V. PROBLEM FORMULATION AND ALGORITHM DESIGN OF METASKETCH

In this section, we describe the problem formulation and algorithm design of MetaSketch's three core components, which enables the MetaSketch to perform RF segmentation accurately.

### A. Radio Environment Reconfiguration

In this section, we describe how the radio environment reconfiguration module of MetaSketch derives its configuration matrix. While random configuration matrices are available, to facilitate the point cloud extraction and semantic segmentation requires the configuration matrix to be optimized. As the point clouds are supposed to be extracted from measurement vector  $\mathbf{y}$  in each cycle, we consider selecting the configuration matrix with which  $\mathbf{y}$  can carry the largest amount of information about the humans and objects.

The information about humans and objects is contained in the reflection coefficients at different positions in space. Specifically, the reflection coefficients can be expressed as a  $M$ -dim vector  $\boldsymbol{\eta}$ , where  $M$  is the cardinality of a set of pre-assigned spatial positions whose reflection coefficients we want to restore. The  $j$ -th element of  $\boldsymbol{\eta}$  indicates the average reflection coefficient around the  $j$ -th pre-assigned spatial position. Consequently, we need to optimize  $\mathbf{C}$  so that  $\boldsymbol{\eta}$  can be restored from  $\mathbf{y}$  with the highest accuracy.

In MetaSketch, though the number of spatial positions,  $M$ , can be large, most spatial positions are empty, and thus tend to have zero reflection coefficients. Besides, for the spatial positions where the humans and objects reside, only those which are around the object surfaces with specific angles can reflect the incident signals towards the receiver and have non-zero reflection coefficients. Therefore,  $\boldsymbol{\eta}$  is a sparse vector and can be solved by using the compressive sensing technique, which we introduced in Section III-B.

Based on [35], to minimize the loss between the reconstructed  $\boldsymbol{\eta}$  and the actual one, we can minimize the average mutual coherence (AMC) of  $\mathbf{H}$ , which is defined as

$$\mu(\mathbf{H}) = \frac{1}{M(M-1)} \sum_{m,m' \in [1,M], m \neq m'} \frac{|\mathbf{h}_m^T \mathbf{h}_{m'}|}{\|\mathbf{h}_m\|_2 \cdot \|\mathbf{h}_{m'}\|_2}. \quad (5)$$

Here,  $\mathbf{h}_m \in \mathbb{C}^K$  and  $\mathbf{h}_m$  is the  $m$ -th column of  $\mathbf{H}$ . The  $i$ -th element of  $\mathbf{h}_m$  ( $i \in [1, K]$ ) indicates the influence of a surface with reflection coefficient 1 at the  $m$ -th position on the received signals,

---

**Algorithm 1: Configuration Optimization Algorithm**

---

**Input** : Initial random configuration matrix  $\mathbf{C}^{(0)}$ ; Initial population size for genetic algorithm (GA)  $N_P$ .

**Output**: Optimal AMC  $\mu^*$  and configuration matrix  $\mathbf{C}^*$ .

- 1 Set  $\mathbf{C}^* = \mathbf{C}^{(0)}$ , and compute initial  $\mu^*$  based on (5) and Appendix A given  $\mathbf{C}$ ;
  - 2 Set the number of consecutive iterations with no improvements as  $N_{\text{non}} = 0$  and current frame index  $k = 1$ ;
  - 3 **while** *True* **do**
  - 4     Based on Appendix A, generate continuous configuration matrix  $\tilde{\mathbf{D}}$  based on  $\mathbf{C}^*$ , and denote the  $k$ -th row of  $\tilde{\mathbf{D}}$  as  $\tilde{\mathbf{d}}_k$  and the other rows as  $\tilde{\mathbf{D}}_{-k}$ ;
  - 5     Invoke pattern search algorithm [36] to solve  $\tilde{\mathbf{d}}_k^* = \arg \min \mu([\tilde{\mathbf{d}}_k, \tilde{\mathbf{D}}_{-k}] \mathbf{A})$ , where  $\mathbf{A}$  is defined in Appendix A;
  - 6     Round up  $\tilde{\mathbf{d}}_k^*$  to discrete configuration vector  $\mathbf{c}'_k$  by  $(\mathbf{c}'_k)_l = \arg \max_{j \in [1, N_s]} ((\tilde{\mathbf{d}}_k^*)_{(L-1)N_s+j})$ ;
  - 7     Invoke genetic algorithm [37] to solve  $\mathbf{c}_k^* = \arg \max_{\mathbf{c}_{k,l} \in [1, N_s]} \mu(\mathbf{g}(\mathbf{c}_k, \mathbf{C}_{-k}^*))$ , with the initial population consisting of  $\mathbf{c}'_k$  and  $(N_P - 1)$  random configurations, and denote the result AMC as  $\mu^{*'}$ ;
  - 8     If  $\mu^{*' < \mu^*$ , update  $\mu^* = \mu^{*'}$ , the  $k$ -th row of  $\mathbf{C}^*$  to be  $\mathbf{c}_k^*$ ; otherwise, set  $N_{\text{non}} = N_{\text{non}} + 1$ ;
  - 9     If  $N_{\text{non}} < K$ , set  $k = \text{mod}(k + 1, K) + 1$ ; otherwise, return  $\mu^*$  and  $\mathbf{C}^*$ ;
  - 10 **end**
- 

given the metasurface is at the  $k$ -th configuration. Measurement matrix  $\mathbf{H}$  is determined by  $\mathbf{C}$ , and we can obtain the value of  $\mathbf{H} = \mathbf{g}(\mathbf{C})$  according to Appendix A.

Based on (5), we can formulate the optimization for radio environment reconfiguration the following mutual coherence minimization problem:

$$\begin{aligned}
 \text{(P1)} \quad & \min_{\mathbf{C}} \mu(\mathbf{H}), \\
 & s.t. \quad \mathbf{H} = \mathbf{g}(\mathbf{C}), \\
 & \quad c_{k,l} \in [1, N_s] \quad \forall k \in [1, K], l \in [1, L],
 \end{aligned} \tag{6}$$

where  $N_s$  denotes the number of states of a metasurface element and  $c_{k,l}$  denotes the state of the  $l$ -th group in the  $k$ -th configuration. To solve (P1), we propose the configuration optimization algorithm, which is summarized in Algorithm 1.

### B. Point Clouds Extraction

1) *Measurement Matrix Construction*: To perform point cloud extraction, we need first to construct the accurate values of the measurement matrix given the optimized configuration matrix

$\mathbf{C}^*$  obtained by solving (P1), as mapping  $\mathbf{g}$  in Appendix A does not take the influence of the environment into account. To be specific, we first assign a set of  $M$  spatial positions, which is denoted by  $\mathcal{M} = \{(x_m, y_m, z_m) | m \in [1, M]\}$ . Then, we position a metal patch at the center of each spatial position, and collect the measurement vectors using the protocol described in Section IV-B with the metasurface using optimized configuration matrix  $\mathbf{C}^*$ . When the metal patch is at the  $m$ -th ( $m \in [1, M]$ ) spatial position, the collected measurement vector is denoted as  $\hat{\mathbf{y}}_{\mathbf{C}^*, m}$ . Then, we remove the metal patch and obtain the measurement vector accounting for the background scattering, which is denoted as  $\mathbf{y}_{\mathbf{C}^*}^B$ . Based on the superposition property of the wireless signals, the channel gain for the propagation channel reflected at the  $m$ -th space block can be obtained by

$$\mathbf{h}_m^* = (\hat{\mathbf{y}}_{\mathbf{C}^*, m} - \mathbf{y}_{\mathbf{C}^*}^B) / \eta_m^M, \quad (7)$$

where  $\eta_m^M$  is the reflection coefficient of the metal patch at the  $m$ -th space block towards the Rx antenna. Moreover, for normalization, we assume  $\eta_m^M = 1$ , and thus each element in obtained  $\boldsymbol{\eta}$  indicates the reflection coefficient with respect to the metal patch at that spatial position.

Then, the measurement matrix  $\mathbf{H}^* \in \mathbb{C}^{K \times M}$  corresponding to  $\mathbf{C}^*$  can be formed by  $\mathbf{H}^* = [\mathbf{h}_1^*, \dots, \mathbf{h}_M^*]$ . We use  $\mathbf{H}$  to extract point cloud of target objects. Denote the collected measurement vector as  $\mathbf{y}$ , and then the following equation holds

$$\mathbf{y} - \mathbf{y}^B = \mathbf{H}\tilde{\boldsymbol{\eta}} + \mathbf{e}, \quad (8)$$

where  $\boldsymbol{\eta} \in \mathbb{C}^M$  is the reflection coefficient vector of the pre-assigned spatial positions with respect to metal patches. Then, with known  $\mathbf{y}$ ,  $\mathbf{y}^B$ , and  $\mathbf{H}$ , we can extract the point cloud by solving (8) to obtain  $\boldsymbol{\eta}$ , i.e., the normalized reflection coefficients of the spatial positions.

2) *Reconstruction of Reflection Coefficients*: Based on the compressive sensing technique described in Section III-B, we can obtain  $\hat{\boldsymbol{\eta}}$  by solving the following  $l_1$ -norm minimization problem:

$$\begin{aligned} \text{(P2)} \quad & \min_{\boldsymbol{\eta} \in \mathbb{C}^M} \|\boldsymbol{\eta}\|_1, \\ & \|\mathbf{H}^* \boldsymbol{\eta} - \mathbf{y}_{\mathbf{C}^*} + \mathbf{y}_{\mathbf{C}^*}^B\|_2 \leq \epsilon. \end{aligned} \quad (9)$$

Here,  $\epsilon$  is the variance of noise  $\mathbf{e}$  in (8). As (P2) can be recast as a *second-order cone program* problem, it can be solved using standard convex optimization tools in [38].

From  $\boldsymbol{\eta}$ , the generation of the point cloud, which is a set of feature vectors and denoted by  $\mathcal{P}$ , is described as follows. Set  $\mathcal{P}$  contains  $M$  elements, and each element is a 5-dimensional

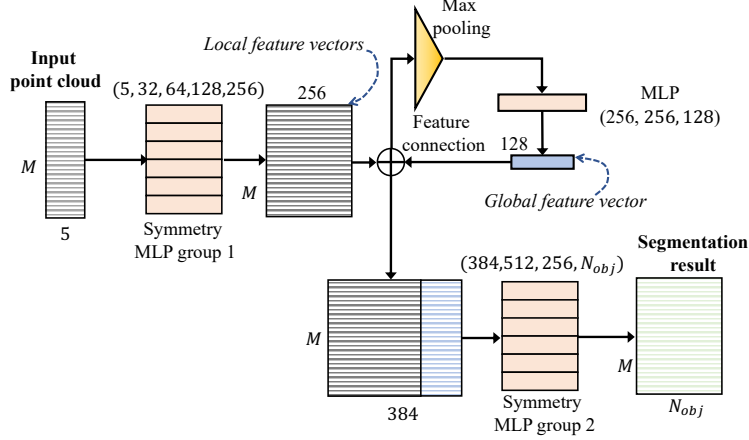

Fig. 7. Workflow of semantic segmentation module.

feature vector, which is composed of its position and the reconstructed normalized reflection coefficient of it, i.e.,

$$\mathbf{p}_m = (x_m, y_m, z_m, \text{Re}(\boldsymbol{\eta}_m), \text{Im}(\boldsymbol{\eta}_m)), \forall m \in [1, M]. \quad (10)$$

Here, the first three dimensions of  $\mathbf{p}_m$  indicate the coordinates of the  $m$ -th space block center, and Re and Im denote the real and imaginary parts of complex values, respectively.

### C. Semantic Segmentation

The semantic segmentation module takes the extracted point cloud  $\mathcal{P}$  as input and outputs set  $\tilde{\mathcal{P}}$ , which contains the positions and semantic labels (e.g., bottle, table, human, etc.) of the points in  $\mathcal{P}$ , i.e.,

$$\tilde{\mathcal{P}} = \{(x_m, y_m, z_m, b_m) | m \in [1, M]\} \quad (11)$$

where  $b_m \in [1, N_{obj}]$  denotes the semantic meaning of the  $m$ -th point, and  $N_{obj}$  denotes the total number of considered semantic meanings. Without loss of generality, we denote the mapping performed by the semantic segmentation module by  $\mathbf{f}_S : \mathcal{P} \rightarrow \hat{\mathcal{P}}$ .

As described in Section III-C,  $\mathbf{f}_S$  needs to be symmetric. Besides, the process of labeling the semantic meaning of each point needs to consider both local and global information; because knowing the semantic meaning of the point cloud as a whole helps figure out the semantic meaning of each point. Therefore, based on [26], we design the semantic segmentation module to contain *symmetric MLP groups* and *feature-gathering connections*, which are depicted in Fig. 7.



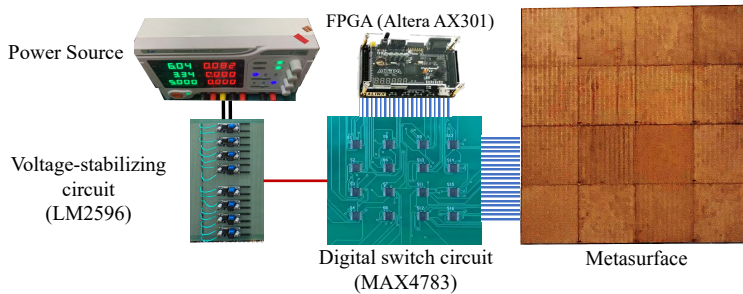

Fig. 8. Diagram of metasurface control circuit.

1) *Symmetric MLP groups*: We process  $M$  points in  $\mathcal{P}$  with  $M$  symmetric MLPs with symmetric MLP groups. As the MLP that treats each point has the same structure and adopts the same parameters, the results of the symmetric MLP group are invariant to the permutation of the input points. Specifically, we adopt 2 symmetric MLP groups in the semantic segmentation module. The structures of the symmetric MLP groups are labeled in Fig. 7.

2) *Feature-gathering connections*: Feature-gathering connections refer to the *max pooling layer* and the concatenation of the local feature vectors and the global feature vector. In the max-pooling layer, each dimension of the feature vectors of points are divided into small groups, and only the max values in the groups are picked as the output. By this means, the max pooling layer reduces the amount of parameters and aggregate the information, which also alleviates overfitting. The output of the max-pooling layer is equal to the number of semantic classes in total and can be considered as the global feature vector. Then, the global feature vector is concatenated to the local feature vector of each point. By this means, the feature vector of each point now contains both local and global information.

## VI. IMPLEMENTATION

In this section, we present the implementation of MetaSketch, including the implementation of the metasurface and the RF transceiver module.

### A. Building the Metasurface

As shown in Fig. 8, the metasurface is with the size of  $69 \times 69 \times 0.52 \text{ cm}^3$  and is composed of 16 independently controllable groups which are tightly paved in squares. Each group contains  $12 * 12 = 144$  metasurface elements arranged in a two-dimensional array, and thus the total number of metasurface elements is 2304.

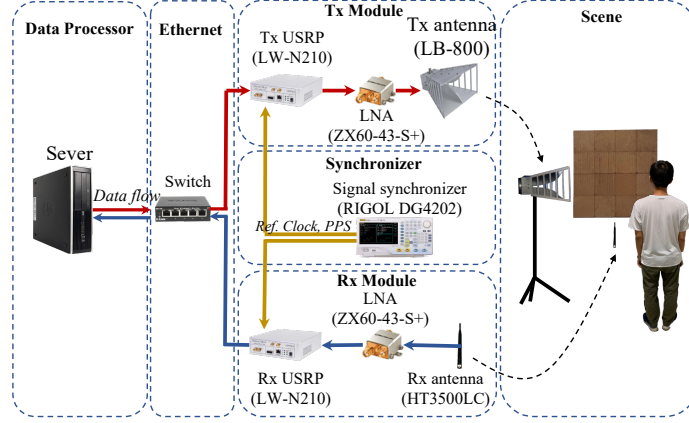

Fig. 9. Components of the transceiver module.

Each metasurface element has the size of  $1.5 \times 1.5 \times 0.52 \text{ cm}^3$  and is composed of 4 rectangle copper patches printed on a dielectric substrate (Rogers 3010) with a dielectric constant of 10.2 and 3 PIN diodes (BAR 65-02L). Any two adjacent copper patches are connected by a PIN diode, and each PIN diode has two operation states, i.e., ON and OFF, which are controlled by applied bias voltages on the via holes. When the applied bias voltage is 1.2 V (or 0 V), the PIN diode is at the ON (or OFF) state.

As there are 3 PIN diodes in a metasurface element, the total number of possible states of a metasurface element is 8. We simulate the  $S_{21}$  parameters, i.e., the *forward transmission gain*, of the metasurface element in different states for normal-direction incident RF signals in CST software, Microwave Studio, Transient Simulation Package [39]. We pick these four states with a phase shift interval equaling to  $\pi/2$  as the *available state set*  $\mathcal{S}_a$ , i.e.,  $\mathcal{S}_a = \{\hat{s}_1, \hat{s}_2, \hat{s}_3, \hat{s}_4\}$ . The four selected states have the phase values equaling to  $\pi/4$ ,  $3\pi/4$ ,  $5\pi/4$  and  $7\pi/4$ , respectively.

As described in Section III-A, the metasurface elements within the same group are in the same state. The states of the 16 groups are controlled by the metasurface control circuit, which contains a direct current power supply, multiple voltage-stabilizing modules (LM2596), 16 digital switch circuit (MAX4783), and a field-programmable gate array (FPGA) (ALTERA AX301). The DC power supply is connected to the voltage-stabilizing modules, and the input voltage to the voltage-stabilizing modules is about 6 V. The voltage-stabilizing modules stabilize the input voltage and reduce it to a 1.2 V output level. The digital switch circuits are single-pole double-throw and control whether the PIN diodes of metasurface elements are connecting to the ground, i.e., 0 V level, or to the 1.2 V output of the voltage-stabilizing modules.

### B. Building the Transceiver Module

As shown in Fig. 9, we build the RF transceiver module in MetaSketch by using the following components.

**(1) USRP devices:** We implement the Tx and Rx based on two USRPs (LW-N210), which are capable of converting baseband signals to RF signals, and vice versa. The USRP is composed of the hardwares, including the RF modulation/demodulation circuits and baseband processing units, and can be controlled by using the GNU packet in Python [40].

**(2) Low-noise amplifiers (LNAs):** Since the RF signals need to be reflected twice (on metasurface and on objects) before reaching the Rx antenna, they suffer from large attenuation in signal strength, which results in low SNR and degrades the measurement accuracy. To handle this issue, two LNA (ZX60-43-S+) connect the Tx/Rx USRP and the Tx/Rx antenna and amplify the transmitted/received RF signals by about 15 dB.

**(3) Tx and Rx antennas:** The Tx antenna is a directional double-ridged horn antenna (LB-800), and the Rx antenna an omni-directional vertical antenna (HT3500LC). The polarization of both the Tx and Rx antennas is linear and vertical to the ground.

**(4) Signal synchronizer:** For the Rx USRP to obtain the relative phases and amplitudes of the received signals with respect to the transmitted signals of the Tx USRP, we employ a signal source (DG4202) to synchronize the frequency and phase of the Tx and Rx USRPs. The signal source provides the reference clock signal and the pulses-per-second (PPS) signal to the USRPs, which ensures the modulation and demodulation of the USRPs to be coherent.

**(5) Ethernet switch:** The Ethernet switch connects the USRPs and a sever forming a local Ethernet, where the controlling signals and received signals are exchanged.

**(6) Sever:** The sever controls the two USRPs by using the GNU packet in Python, extracts the measurement vectors from the received signals of the Rx USRP, and performs point cloud extraction and semantic segmentation.

## VII. SIMULATION AND EXPERIMENTAL EVALUATION

In this section, we demonstrate the experimental setup for MetaSketch and evaluate the performance of the three component modules.

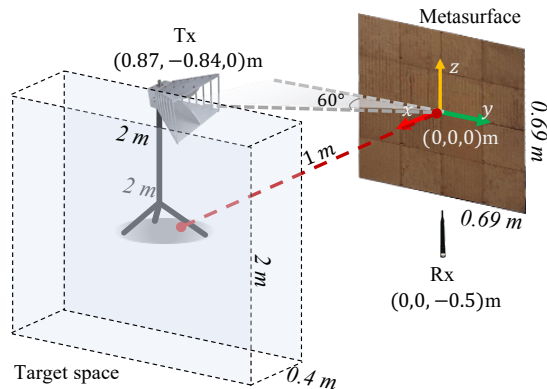

Fig. 10. Environment layout in experiments.

### A. Experimental Setup

We describe the experimental setup in three aspects: the environment layout to test MetaSketch, the data structure of each module, and the adopted evaluation metrics.

1) *Environment layout*: The environment layout of MetaSketch is shown in Fig. 10. To be specific, the origin of coordinate is at the center of the metasurface, and the metasurface is in the  $y - z$  plane. Besides, the  $z$ -axis is vertical to the ground and pointing upwards, and the  $x$ - and  $y$ -axes are parallel to the ground. The Tx and Rx antennas are located at  $(0.87, -0.84, 0)$  m and  $(0, 0, -0.5)$  m, respectively.

The humans and objects are in the space of interest, which is a cuboid region located at 1 m from the metasurface. Since the space of interest is behind the Tx antenna and the Tx antenna is directional horn antenna, no LoS signal path from the Tx antenna to the space of interest exists.

The humans and objects for recognition are located within a *target space*, which is a  $0.4 \times 2 \times 2$  m<sup>3</sup> cuboid space. The target space is regularly divided into  $M = 400$  space blocks each with size  $0.4 \times 0.2 \times 0.2$  m<sup>3</sup>.

2) *Collected Data*: The optimized configuration matrix of metasurface, i.e.,  $C^*$ , is obtained by solving (P1) in the sever and is uploaded to the FPGA. In the data collection phase, the metasurface changes its configuration by 0.1 second. To obtain the corresponding measurement matrix, i.e.,  $H^*$ , we set a metal patch with size  $0.2 \times 0.2$  m<sup>2</sup> at the center of each space block sequentially given metasurface using  $C^*$ , as described in Section V-B1.

We first generate a set of 64 point clouds with semantic labels as the ground truth set. Then, we arrange humans and objects in the target space according to each of the point clouds. The objects include a bottle, a laptop, and a suitcase. We measure the received signals following

the protocol in Section IV-B. Using measurement matrix  $\mathbf{H}^*$  corresponding to  $\mathbf{C}^*$ , point cloud extraction module processes the received signals by solving (P2). The ground truth set and the corresponding extracted point clouds constitute the training data for the semantic segmentation module.

In the collected training data, each point is represented by a 5-dim vector and a label. The first three dimensions indicate the coordinate of the point; the next 2 dimensions indicate the real and imaginary values of the regenerated reflection coefficients of the point. The label takes value in set  $[1, N_{\text{obj}}]$  where  $N_{\text{obj}} = 5$ , which represent human, bottle, laptop, suitcase, and empty space, respectively.

3) *Evaluation metrics*: We adopt the following three evaluation metrics. (a) *AMC*: As defined in (5), the AMC evaluates the average coherence between every two columns in the designed measurement matrix. A lower AMC indicates the propagation channels via different space blocks are more independent of each other. The AMC is inversely proportional to the reconstruction performance of the compressive sensing method [35]. (b) *Loss*: We adopt *cross-entropy loss* [34] as the metric to train the semantic segmentation module. The cross entropy loss is defined as  $\mathcal{L}_{\mathbf{b}'}(\mathbf{b}) = \sum_i^{N_{\text{obj}}} b'_i \log(b_i)$ , where  $\mathbf{b}'$  is a 0 – 1 vector indicating the true label of a point, and  $\mathbf{b}$  is the probability vector obtained by the semantic segmentation module. (c) *Average error rate*: For each label, the error rate is defined as the ratio between the number of inaccurately labeled points and the total number of points with that label in truth. We adopt the average of the error rates of the  $N_{\text{obj}}$  labels as the metric to evaluate the performance of MetaSketch.

### B. AMC by Radio Environment Reconfiguration

Fig. 11 shows the AMC of  $\mathbf{H}$  vs. the number of iterations in Algorithm 1, under different values of the number of configurations,  $K$ . It can be observed that AMC decreases with the number of iterations, which verifies the effectiveness of the proposed radio environment reconfiguration algorithm. Besides, it can also be seen that the converged optimal AMC of  $\mathbf{H}$  decreases with  $K$ . This can be explained as follows. To reduce the mutual coherence of  $\mathbf{H}$ , it requires different columns of  $\mathbf{H}$  have large elements at different dimensions. As  $K$  is the dimension of  $\mathbf{h}_m$ , large  $K$  increases the probability to have the large elements at different dimensions and reduce the mutual coherence. Therefore, as  $K$  increases, the AMC value of the optimized measurement

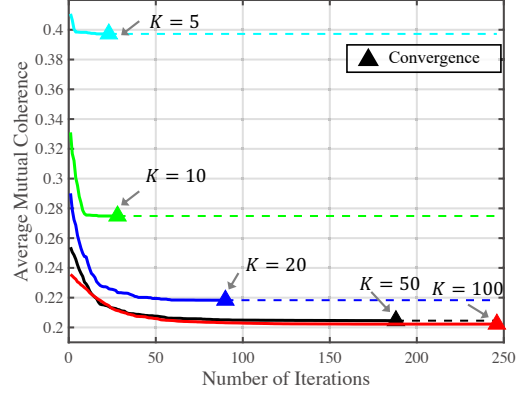

Fig. 11. AMC of measurement matrix vs. the number of training iterations.

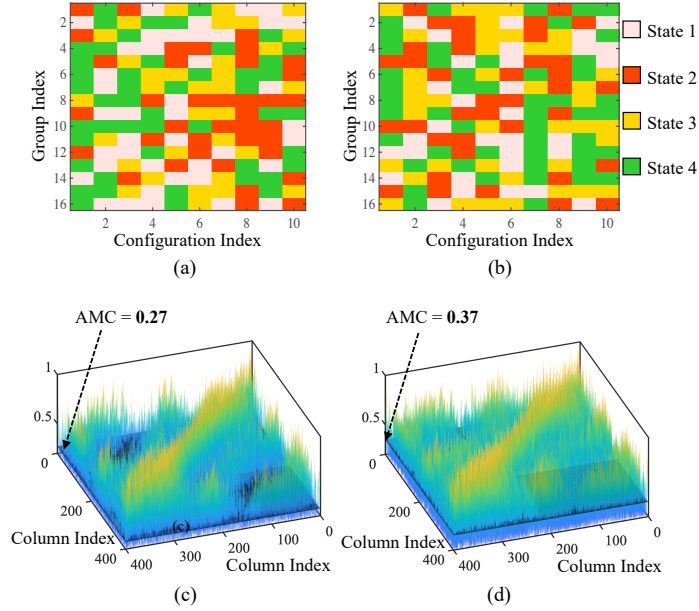

Fig. 12. Illustrations on the (a) optimized and (b) random metasurface configuration matrices, and (c) the mutual coherence values of the optimized configuration matrix and (d) those of the random configuration matrix. The planes in (c) and (d) indicate the AMC values.

matrix decreases, which can lead to a higher accuracy for the compressive sensing technique to extract exact point clouds.

We compare the mutual coherence of the measurement matrices corresponding to the random and optimized configuration matrices. The configuration matrix in Fig. 12 (a) is  $C^*$  obtained by using Algorithm 1, and Fig. 12 (c) shows the mutual coherence of corresponding  $H^*$ . Besides, the configuration matrix in Fig. 12 (b) is a random configuration matrix where the elements in  $C$

True Images	Point Clouds (Optimized $\mathcal{C}^*$ )	Point Clouds (Random $\mathcal{C}$ )	True Images	Point Clouds (Optimized $\mathcal{C}^*$ )	Point Clouds (Random $\mathcal{C}$ )

Fig. 13. Extracted point clouds by using random and optimized configuration matrices. A large square indicates a large absolute value of the obtained reflection coefficient at a certain position, and the colors of squares indicate the phases.

are generated following uniform distribution in  $[1, 4]$ . Fig. 12 (d) shows the coherence of column vectors of  $\mathbf{H}$  corresponding to random  $\mathbf{C}$  in Fig. 12 (a). Comparing Figs. 12 (c) and (d), we can observe that Algorithm 1 optimizes the configuration matrix, which effectively reduces the mutual coherence of the measurement matrix, resulting in a lower AMC than that of a random configuration matrix. Based on discussion in Section V-A, the configuration matrix in Fig. 12 (a) can result in higher accuracy of point cloud extraction than that in Fig. 12 (b).

### C. Extracted Point Clouds

Fig. 13 shows the photos and the corresponding extracted point clouds under random and optimized configuration matrices. In the photos, the light (yellow) regions are the metal patches, and the dark (brown) regions are the cardboards which have a negligible impact on wireless signals. It can be observed that when the number of metal patches is small (the number of metal patches is less than 3), the point cloud extraction module can successfully reconstruct the point clouds which reflect the true images well. However, when the number of metal patches is larger than 4, the point clouds are not in accordance with true images. This is due to that the compressive sensing method requires the target vector to be sparse. Besides, the point clouds obtained by using the optimal metasurface configuration  $\mathcal{C}^*$  reflects the photos more accurately than those obtained by using a random metasurface configuration  $\mathcal{C}$ , which verifies the effectiveness of optimizing radio environment reconfiguration.

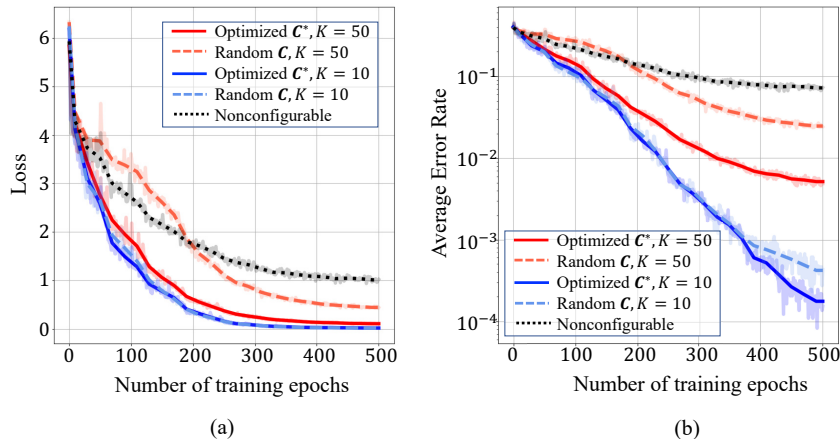

Fig. 14. (a) Loss and (b) accuracy vs. the number of training epochs with optimized and random configurations under different  $K$ . The shaded areas denote the values for each epoch, and the thick lines denote the average values for the adjacent 20 epochs.

#### D. Semantic Segmentation of Human and Objects

Figs. 14 (a) and (b) shows the loss and average error rate vs. the number of training epochs of the semantic segmentation module. The solid and dash lines in red and in blue are the loss and average error rate curves obtained when  $K = 10$  and  $K = 50$ , respectively, where solid lines are the results under  $C^*$  and dash lines are the results under  $C$ . The dot lines in black indicate those curves obtained in a nonconfigurable radio environment, where the configuration of the metasurface is fixed to all state  $\hat{s}_1$ , i.e.,  $K = 1$  and  $C = 1$ . As the number of training epochs increases, both the loss and the average error rate decreases. Compared to those in a nonconfigurable radio environment where the configuration of the metasurface is fixed, the loss and average error rates in configurable radio environments are significantly lower, which verifies the effectiveness of using a metasurface to configure radio environment. Besides, when  $K$  is small ( $K = 10$ ), it can be observed that using  $C^*$  can help the semantic segmentation module to train the MLP with a much lower loss and error rate. When  $K = 10$ , after about 350 epochs of training, MetaSketch can perform semantic segmentation with an average error rate of less than 1%. If the number of configurations is sufficiently large, i.e.,  $K = 50$ , the average error rate can be further reduced to less than 0.1% after 400 epochs of training. However, when  $K = 50$ , the data collection phase lasts for 5 seconds, which makes the assumption of humans and objects being static during the data collection phase impractical.

Fig. 15 shows the semantic segmentation results after training for 500 epochs overlaid on the ground truth images, given that metasurface adopts optimized and random configuration



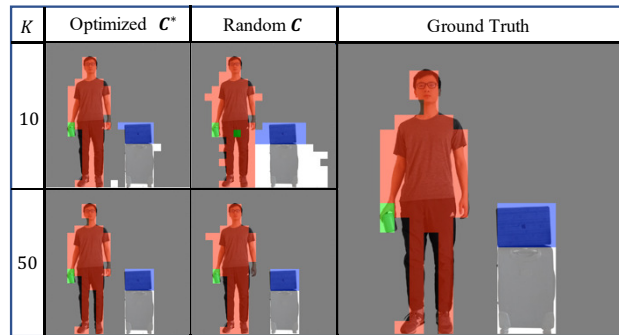

Fig. 15. Semantic segmentation results for human and objects given that the metasurface adopts optimized and random configuration matrices with different  $K$ . The number of training epochs is 500. The human, suitcase, laptop, and bottle are labeled by red, white, blue, and green colors, respectively.

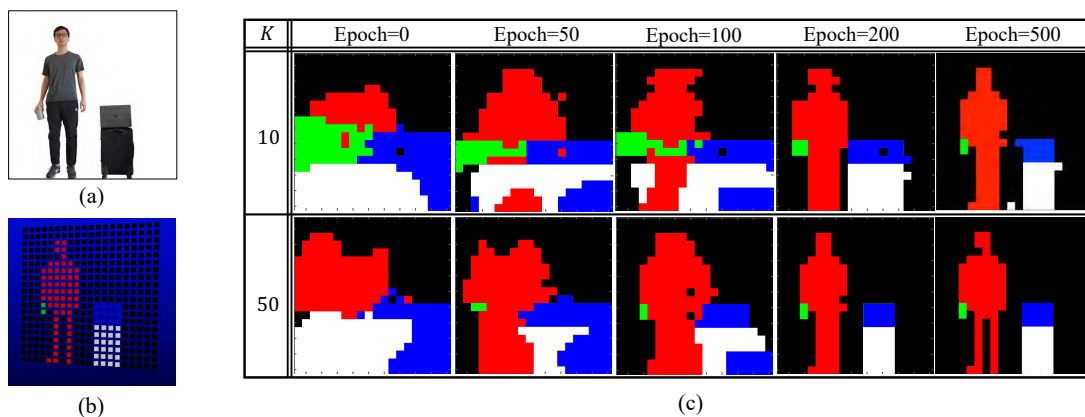

Fig. 16. (a) and (b) are the image of the human and objects and the ground truth of the corresponding labeled point cloud, respectively, and (c) is the semantic segmentation results in different training epochs given metasurface adopting the optimized  $C^*$  with  $K = 10$  and  $K = 50$ .

matrices with different  $K$ . Moreover, Fig. 16 provides the details of the training process by showing the semantic segmentation results in different training epochs. Figs. 16 (a) and (b) are the images of the human and objects, and the ground truth of the corresponding labeled point cloud, respectively, and (c) shows the semantic segmentation results in different training epochs, where the metasurface adopts  $C^*$  with  $K = 10$  and  $K = 50$ . In the semantic segmentation results, the human, suitcase, laptop, and bottle in the results are labeled by red, white, blue, and green colors, respectively.

In Fig. 15, comparing the cases where  $K = 50$  and  $K = 10$ , we can observe that increasing the number of configurations in a cycle enables the MetaSketch to obtain labeled point cloud

closer to the ground truth. In Fig. 16 (c), it can be seen that when  $K$  is larger, the training process is faster, as the semantic segmentation result gets close to the ground truth in an earlier epoch. Besides, in Fig. 15, it can also be seen that using the optimized configuration matrix improves segmentation accuracy. When  $K = 50$ , the improvement due to using optimized configuration matrix is smaller than when  $K = 10$ . Nevertheless, since large  $K$  results in a long duration of the data collection phase and thus low recognition speed of MetaSketch, a small  $K$  is preferable, where adopting an optimized configuration matrix is necessary and important.

## VIII. CONCLUSION

In this paper, we have presented MetaSketch, a metasurface-based RF-sensing system, to perform semantic segmentation for humans and objects in 3D space. We have designed the MetaSketch with three modules, i.e., a radio environment reconfiguration module, a point cloud extraction module, and a semantic segmentation module. MetaSketch can actively modify the radio environment according to the configurations of a metasurface and generate abundant favorable propagation channels for sensing, which have been optimized by using the proposed configuration optimization algorithm. By the point cloud extraction module, MetaSketch extracts the point cloud in space, which can be further processed by its semantic segmentation module for semantic meaning labeling.

Our results have shown that, firstly, the metasurface-based radio environment reconfiguration module with the proposed algorithm can produce measurement matrices with low AMC, which promotes the accuracy of point cloud extraction. Secondly, after training, MetaSketch can label semantic meanings of the points with an average error rate of less than 1%, given the setup of a human, a suitcase, a laptop, and a bottle in a  $1.6 \text{ m}^3$  indoor space represented by 400 points. Thirdly, optimizing the measurement matrix has reduced the required number of training epochs and measurements to obtain an accurate segmentation.

For further making MetaSketch system complete, it requires the following additional technical challenges to be addressed.

- **Higher resolution of MetaSketch:** In this paper, the target space is divided into  $0.4 \times 0.2 \times 0.2 \text{ m}^3$  cubic regions, i.e., space blocks, which limits the resolution. Increasing the resolution of MetaSketch requires the target space to be finely divided. As described in Section V-B1, to obtain the measurement matrix, a metal patch needs to be placed in each space block.

Therefore, to increase the resolution of MetaSketch implies the size of the metal patch needs to be shrunk and the number of measurements needs to be increased.

- **Faster data collection of MetaSketch:** In the data collection phase, the metasurface changes its configuration by 0.1 second, and thus the data collection phase lasts for at least  $K/10$  seconds. As the humans and objects need to be static during the data collection phase, a long data collection phase due to large  $K$  requires more efforts of ensuring them stay still when deploying MetaSketch. To speed up the data collection procedure, we can adopt more advanced switching circuits and FPGA to shorten the time for changing the configurations of metasurface.

## APPENDIX A

### CALCULATION OF MEASUREMENT MATRIX

Given configuration matrix  $\mathbf{C}$ , we now calculate the corresponding measurement matrix  $\mathbf{H}$ . Based on ray-tracing technique [41] and (1), we first calculate channel gain matrix  $\mathbf{A}$ , where the elements indicate the channel gains of the radio paths from the Tx to Rx via the  $L$  metasurface groups in  $N_s$  states and the  $M$ space blocks. Specifically,  $\mathbf{A}$  is  $(N_s \cdot L) \times M$  matrix, where  $l \in [1, L]$ , and  $i \in [1, N_s]$ ,

$$(\mathbf{A})_{N_s(l-1)+i,m} = \sum_{n \in \mathcal{N}_l} \frac{\lambda \cdot r_{n,m}(\hat{s}_i) \cdot \sqrt{g_{T,n} g_{R,m}} \cdot e^{-j2\pi(d_n + d_{n,m})/\lambda}}{4\pi d_n d_{n,m}},$$

where  $r_{n,m}(\hat{s}_i)$  denotes the reflection coefficient of the  $n$ -th metasurface element for the incident signal towards the  $m$ -th space block in the  $i$ -th state,  $g_{T,n}$  is the gain of the transmitter towards the  $n$ -th metasurface element,  $g_{R,m}$  is the gain of the receiver towards the  $m$ -th space block,  $d_n$  is the distance from the Tx to the  $n$ -th metasurface element, and  $d_{n,m}$  denotes the distance from the  $n$ -th metasurface element to the Rx antenna via the  $m$ -th space block. Here,  $r_{n,m}(\hat{s}_i)$  is calculated by using the CST microwave studio [39]. Besides,  $g_{T,n}$  and  $g_{R,m}$  are obtained from the datasheets of Tx and Rx antennas, respectively.

We then transform  $\mathbf{C}$  to a  $K \times (L \cdot N_s)$  zero-one matrix  $\mathbf{D}$ , which satisfies  $\forall k \in [1, K]$ ,  $l \in [1, L]$ , and  $i \in [1, N_s]$ ,

$$(\mathbf{D})_{k,N_s \cdot (l-1)+i} = \begin{cases} 1, & \text{if } (\mathbf{C})_{k,l} = n, \\ 0, & \text{otherwise.} \end{cases}$$

Therefore,  $\mathbf{H}$  can be calculated by  $\mathbf{H} = \mathbf{D}\mathbf{A}$ . We denote process of calculating  $\mathbf{H}$  from  $\mathbf{C}$  by the mapping  $g : \mathbf{C} \rightarrow \mathbf{H}$ .

## REFERENCES

- [1] L. Shapiro, *Computer Vision and Image Processing*. San Diego, CA: Academic Press, 1992.
- [2] D. Zhang, J. Wang, J. Jang, J. Zhang, and S. Kumar, “On the feasibility of Wi-Fi based material sensing,” in *Proceedings of the 25th Annual International Conference on Mobile Computing and Networking (MobiCom’18)*, Los Cabos, Mexico, Oct. 2019.
- [3] W. Jiang, C. Miao, F. Ma, S. Yao, Y. Wang, Y. Yuan, H. Xue, C. Song, X. Ma, D. Koutsonikolas, and et al., “Towards environment independent device free human activity recognition,” in *Proceedings of the 24th Annual International Conference on Mobile Computing and Networking (MobiCom’18)*, New Delhi, India, Oct. 2018.
- [4] J. Zhang, Z. Tang, M. Li, D. Fang, P. Nurmi, and Z. Wang, “Crosssense: Towards cross-site and large-scale WiFi sensing,” in *Proceedings of the 24th Annual International Conference on Mobile Computing and Networking (MobiCom’18)*, New Delhi, India, Oct. 2018.
- [5] C.-Y. Hsu, R. Hristov, G.-H. Lee, M. Zhao, and D. Katabi, “Enabling identification and behavioral sensing in homes using radio reflections,” in *Proceedings of the 2019 CHI Conference on Human Factors in Computing Systems (CHI’19)*, Glasgow, Scotland UK, May 2019.
- [6] M. Zhao, T. Li, M. Abu Alsheikh, Y. Tian, H. Zhao, A. Torralba, and D. Katabi, “Through-wall human pose estimation using radio signals,” in *Proceedings of the IEEE Conference on Computer Vision and Pattern Recognition (CVPR’18)*, Salt Lake City, Utah, Jun. 2018.
- [7] F. Adib, C.-Y. Hsu, H. Mao, D. Katabi, and F. Durand, “Capturing the human figure through a wall,” *ACM Transactions on Graphics*, vol. 34, no. 6, p. 219, Oct. 2015.
- [8] M. Zhao, Y. Tian, H. Zhao, M. A. Alsheikh, T. Li, R. Hristov, Z. Kabelac, D. Katabi, and A. Torralba, “RF-based 3D skeletons,” in *Proceedings of the 2018 Conference of the ACM Special Interest Group (SIGCOMM’18)*, New York, New York, USA, Aug. 2018.
- [9] A. Pedross-Engel, D. Arnitz, J. N. Gollub, O. Yurduseven, K. P. Trofater, M. F. Imani, T. Sleasman, M. Boyarsky, X. Fu, D. L. Marks, D. R. Smith, and M. S. Reynolds, “Orthogonal coded active illumination for millimeter wave, massive-MIMO computational imaging with metasurface antennas,” *IEEE Transactions on Computational Imaging*, vol. 4, no. 2, pp. 184–193, Jun. 2018.
- [10] N. Honma, D. Sasakawa, N. Shiraki, T. Nakayama, and S. Iizuka, “Human monitoring using MIMO radar,” in *Proceedings of the 2018 IEEE International Workshop on Electromagnetics: Applications and Student Innovation Competition (iWEM’18)*, Nagoya, Japan, Aug. 2018.
- [11] Z. Li, Y. Xie, L. Shangguan, R. I. Zelaya, J. Gummeson, W. Hu, and K. Jamieson, “Programmable radio environments with large arrays of inexpensive antennas,” *GetMobile: Mobile Computing and Communications*, vol. 23, no. 3, pp. 23–27, Sep. 2019.
- [12] M. Di Renzo, M. Debbah, D.-T. Phan-Huy, A. Zappone, M.-S. Alouini, C. Yuen, V. Sciancalepore, G. C. Alexandropoulos, J. Hoydis, H. Gacanin, J. D. Rosny, A. Bounceu, G. Lerosey, and M. Fink, “Smart radio environments empowered by AI reconfigurable meta-surfaces: An idea whose time has come,” *arXiv:1903.08925*.

- [13] H. Wang, D. Zhang, Y. Wang, J. Ma, Y. Wang, and S. Li, "RT-Fall: A real-time and contactless fall detection system with commodity WiFi devices," *IEEE Transaction Mobile Computing*, vol. 16, no. 2, pp. 511–526, Dec. 2016.
- [14] T. Zhou, H. Li, D. Ye, J. Huangfu, S. Qiao, Y. Sun, W. Zhu, C. Li, and L. Ran, "Short-range wireless localization based on meta-aperture assisted compressed sensing," *IEEE Transactions on Microwave Theory and Technology*, vol. 65, no. 7, pp. 2516–2524, Jan. 2017.
- [15] F. Adib, Z. Kabelac, and D. Katabi, "Multi-person localization via RF body reflections," in *Proceedings of the 12th USENIX Symposium on Networked Systems Design and Implementation (NSDI'15)*, Oakland, CA, May 2015.
- [16] N. Patwari and J. Wilson, "RF sensor networks for device-free localization: Measurements, models, and algorithms," *Proceedings of the IEEE*, vol. 98, no. 11, pp. 1961–1973, Nov. 2010.
- [17] B. Kellogg, V. Talla, and S. Gollakota, "Bringing gesture recognition to all devices," in *Proceedings of the 11th USENIX Symposium on Networked Systems Design and Implementation (NSDI'14)*, Seattle, WA, Apr. 2014.
- [18] S. Sigg, M. Scholz, S. Shi, Y. Ji, and M. Beigl, "RF-sensing of activities from non-cooperative subjects in device-free recognition systems using ambient and local signals," *IEEE Transactions on Mobile Computing*, vol. 13, no. 4, pp. 907–920, Feb. 2013.
- [19] J. Lien, N. Gillian, M. E. Karagozler, P. Amihood, C. Schwesig, E. Olson, H. Raja, and I. Poupyrev, "Soli: Ubiquitous gesture sensing with millimeter wave radar," *ACM Transactions on Graphics*, vol. 35, no. 4, p. 142, Jul. 2016.
- [20] Y. Tian, G.-H. Lee, H. He, C.-Y. Hsu, and D. Katabi, "RF-based fall monitoring using convolutional neural networks," in *Proceedings of the ACM on Interactive, Mobile, Wearable and Ubiquitous Technologies*, vol. 2, no. 3, pp. 1–24, Sep. 2018.
- [21] J. N. Gollub, O. Yurduseven, K. P. Trofatter, D. Arnitz, M. F. Imani, T. Sleasman, M. Boyarsky, A. Rose, A. Pedross-Engel, H. Odabasi, T. Zvolensky, G. Lipworth, D. Brady, D. L. Marks, M. S. Reynolds, and D. R. Smith, "Large metasurface aperture for millimeter wave computational imaging at the human-scale," *Scientific Reports*, vol. 7, no. 1, p. 42650, Feb.
- [22] J. Long, E. Shelhamer, and T. Darrell, "Fully convolutional networks for semantic segmentation," in *Proceedings of the IEEE Conference on Computer Vision and Pattern Recognition (CVPR'15)*, Boston, MA, Jun. 2015.
- [23] S. Ren, K. He, R. Girshick, and J. Sun, "Faster R-CNN: Towards real-time object detection with region proposal networks," in *Advances in Neural Information Processing Systems (NIPS'15)*, Montreal, Canada, Dec. 2015.
- [24] V. Badrinarayanan, A. Kendall, and R. Cipolla, "SegNet: A deep convolutional encoder-decoder architecture for image segmentation," *IEEE Transactions on Pattern Analysis and Machine Intelligence*, vol. 39, no. 12, pp. 2481–2495, Dec. 2017.

- [25] D. Mehta, S. Sridhar, O. Sotnychenko, H. Rhodin, M. Shafiei, H.-P. Seidel, W. Xu, D. Casas, and C. Theobalt, “Vnect: Real-time 3D human pose estimation with a single RGB camera,” *ACM Transactions on Graphics*, vol. 36, no. 4, p. 44, Jul. 2017.
- [26] C. R. Qi, H. Su, K. Mo, and L. J. Guibas, “Pointnet: Deep learning on point sets for 3d classification and segmentation,” in *Proceedings of the IEEE Conference on Computer Vision and Pattern Recognition (CVPR’17)*, Honolulu, Hawaii, Jul. 2017.
- [27] T. J. Cui, D. R. Smith, and R. Liu, *Metamaterials*. Boston, MA: Springer, 2010.
- [28] B. Di, H. Zhang, L. Song, Y. Li, Z. Han, and H. V. Poor, “Hybrid beamforming for reconfigurable intelligent surface based multi-user communications: Achievable rates with limited discrete phase shifts,” *arXiv:1910.14328*.
- [29] W. Tang, M. Z. Chen, X. Chen, J. Y. Dai, Y. Han, M. Di Renzo, Y. Zeng, S. Jin, Q. Cheng, and T. J. Cui, “Wireless communications with reconfigurable intelligent surface: Path loss modeling and experimental measurement,” *arXiv:1911.05326*.
- [30] Z. Han, H. Li, and W. Yin, *Compressive Sensing for Wireless Networks*. New York, NY: Cambridge University Press, 2013.
- [31] E. J. Candes, J. K. Romberg, and T. Tao, “Stable signal recovery from incomplete and inaccurate measurements,” *Communications on Pure and Applied Mathematics*, vol. 59, no. 8, pp. 1207–1223, Mar. 2006.
- [32] L. Li, H. Ruan, C. Liu, Y. Li, Y. Shuang, A. Alù, C.-W. Qiu, and T. J. Cui, “Machine-learning reprogrammable metasurface imager,” *Nature Communications*, vol. 10, no. 1082, pp. 1–8, Jun. 2019.
- [33] J. Dai, K. He, and J. Sun, “Boxsup: Exploiting bounding boxes to supervise convolutional networks for semantic segmentation,” in *Proceedings of the IEEE Conference on Computer Vision and Pattern Recognition (CVPR’15)*, Boston, MA, Jun. 2015.
- [34] I. Goodfellow, Y. Bengio, and A. Courville, *Deep Learning*. MIT Press: Cambridge, MA, 2016.
- [35] M. Elad, “Optimized projections for compressed sensing,” *IEEE Transactions on Signal Processing*, vol. 55, no. 12, pp. 5695–5702, Nov. 2007.
- [36] R. M. Lewis, A. Shepherd, and V. Torczon, “Implementing generating set search methods for linearly constrained minimization,” *SIAM Journal on Scientific Computing*, vol. 29, no. 6, pp. 2507–2530, Oct. 2007.
- [37] D. E. Goldberg, *Genetic Algorithms*. Pearson Education India, 2006.
- [38] S. Boyd and L. Vandenberghe, *Convex Optimization*. Cambridge University Press: Cambridge, U.K., 2004.
- [39] F. Hirtenfelder, “Effective antenna simulations using CST MICROWAVE STUDIO®,” in *Proceedings of the 2nd International ITG Conference on Antennas (INICA’07)*, Munich, Germany, Mar. 2007.
- [40] E. Blossom, “Gnu radio: Tools for exploring the radio frequency spectrum,” *Linux Journal*, vol. 2004, no. 122, p. 4, Jun. 2004.
- [41] A. Goldsmith, *Wireless communications*. Cambridge University Press, 2005.