

# Import options for chemical energy carriers from renewable sources to Germany

Johannes Hampp<sup>1\*</sup>, Michael Düren<sup>1</sup>, Tom Brown<sup>2,3</sup>

**1** Center for International Development and Environmental Research, Justus Liebig University Gießen, Hesse, Germany

**2** Department of Digital Transformation in Energy Systems, Technische Universität Berlin, Berlin, Germany

**3** Institute for Automation and Applied Informatics, Karlsruhe Institute of Technology, Baden-Württemberg, Germany

\* johannes.hampp@zeu.uni-giessen.de (JH)

## Abstract

Import and export of fossil energy carriers are cornerstones of energy systems world-wide. If energy systems are to become climate neutral and sustainable, fossil carriers need to be substituted with carbon neutral alternatives or electrified if possible. We investigate synthetic chemical energy carriers, hydrogen, methane, methanol, ammonia and Fischer-Tropsch fuels, produced using electricity from Renewable Energy Source (RES) as fossil substitutes. RES potentials are obtained from GIS-analysis and hourly resolved time-series are derived using reanalysis weather data. We model the sourcing of feedstock chemicals, synthesis and transport along nine different Energy Supply Chains to Germany and compare import options for seven locations around the world against each other and with domestically sourced alternatives on the basis of their respective cost per unit of hydrogen and energy delivered. We find that for each type of chemical energy carrier, there is an import option with lower costs compared to domestic production in Germany. No single exporting country or energy carrier has a unique cost advantage, since for each energy carrier and country there are cost-competitive alternatives. This allows exporter and infrastructure decisions to be made based on other criteria than energy and cost. The lowest cost means for importing of energy and hydrogen are by hydrogen pipeline from Denmark, Spain and Western Asia and Northern Africa starting at 36 EUR/MWh<sub>LHV</sub> to 42 EUR/MWh<sub>LHV</sub> or 1.0 EUR/kg<sub>H2</sub> to 1.3 EUR/kg<sub>H2</sub> (in 2050, assuming 5% p.a. capital cost). For complex energy carriers derived from hydrogen like methane, ammonia, methanol or Fischer-Tropsch fuels, imports from Argentina by ship to Germany are lower cost than closer exporters in the European Union or Western Asia and Northern Africa. For meeting hydrogen demand, direct hydrogen imports are more attractive than indirect routes using methane, methanol or ammonia imports and subsequent decomposition to hydrogen because of high capital investment costs and energetic losses of the indirect routes. We make our model and data available under open licenses for adaptation and reuse.

## Introduction

Climate change mitigation efforts are driving energy transitions across the world. In these efforts alternatives for established fossil energy carriers are being sought. These

aspirations gained additional traction with the plans of major international players like China, the European Union (EU) and United States of America (USA) to become climate neutral by the middle of this century. With technologies for the electricity sector already existing, these plans require a shift of focus to the industrial, heating and mobility sectors. Today's and tomorrow's energy demand of these sectors will have to be met with climate neutral and sustainable alternatives. The same requirements also hold for industrial feedstock which have to be de-fossilised. For some countries producing chemical energy carriers and feedstock from domestic RES or other near-zero-carbon energy sources may be an option. For other countries this will prove challenging due to geographical, sociological or technological restrictions. Germany can be considered such a country where limited potentials for domestic energy generation will presumably be insufficient to meet energy demand for chemical energy carriers. Nowadays Germany strongly relies on energy imports, which made up more than 76 % (approximately 13.5 EJ) of Germany's domestically handled energy in 2018 [1]. Despite a high population density and mediocre RES potentials in a world-wide comparison, Germany has committed itself to RES as a future source of energy. With these limitations the continued import of energy should be investigated, where fossil carriers are substituted by synthetic chemical energy carriers produced from RES.

Compared to electrical or heat energy, chemical energy carriers are easy to transport and store, making them a preferred option for energy exports. Aided by pre-existing infrastructure and experience from handling of fossil energy carriers, extensive use and significant trade volumes of synthetic chemical energy carriers from RES can be expected by 2050. One option, hydrogen, is currently receiving renewed world-wide attention with an increasing number of nations adopting hydrogen strategies. A convergence to a system with one single predominant chemical energy carrier might not be ideal: Depending on the end use the adaptation of processes to a different chemical, e.g. hydrogen, will have to be weighed against substituting fossil chemicals with synthetic drop-in alternatives. Adding to the complexity of this decision are the different chemical and energy carrier specific properties which influence the conditions and behaviour of a chemical during transport and storage. It therefore becomes important to gain insight into the costs, composition and interaction of steps inside potential future chemical Energy Supply Chains (ESCs).

Previous works have already analysed possible schemes for sourcing chemical energy carriers. Fasihi et al. [2] conducted a world-wide analysis on how renewable energy sources may be combined with other technologies to locally provide electricity and hydrogen at baseload quality and determined possible cost developments for 2020 to 2050. With a focus on synthetic fuels another study by Fasihi et al. [3] analysed an ESC for Fischer-Tropsch-Diesel (FTD) and synthetic natural gas (SNG) (methane) from the Maghreb region to Europe. Watanabe et al. [4] and later Heuser et al. [5] modelled green liquefied hydrogen production and transport from Patagonia to Japan. Ishimoto et al. [6] analysed the cost for transporting hydrogen and ammonia from Norway to Japan and compared it with transport to the Port of Rotterdam in Europe. Lanphen [7] also looked into ship-based supply chain options for importing liquid hydrogen, ammonia and methylcyclohexane from various exporting ports to the Port of Rotterdam. Niermann et al. [8] explored the transport of hydrogen using a variety of Liquid Organic Hydrogen Carriers (LOHCs) and compared their results against a hydrogen gas pipeline system to supply the energy carrier over a distance of 5000 km to Germany (DE). Schorn et al. [9] compared shipping of methanol with shipping of H<sub>2</sub> (l) from Saudi Arabia (SA) to DE and the economic viability depending on H<sub>2</sub> and CO<sub>2</sub> feedstock costs. More recently a number of global studies and analysis for importing hydrogen and other energy carriers from various regions around the world to DE have been released [10–13]. With a stronger focus on downstream infrastructure and energy

distribution to end users, Runge et al. [14] compared the costs for transport fuels in a well-to-wheel analysis for mobility services in Germany. A global view on international hydrogen trade was taken by Heuser et al. [15] who modelled transport by pipeline and ship to determine optimal global supply costs. Later, International Renewable Energy Agency (IRENA) [16] gave an outlook on global energy trade scenarios for RES-based hydrogen and additionally ammonia.

While each case study provides important insights, it is difficult to compare these studies due to their different system boundaries, limited subsets of overlapping technologies, different energy carriers and regions investigated.

With this study we add several novel features to the existing literature. First we provide a comprehensive comparison of multiple ESCs from several different countries based on uniform assumptions and system boundaries. Secondly we deduct local electricity demand from the renewable resource availability in exporting countries, so that the best resources may be used locally. Thirdly we design our ESCs to work as islanded systems and be energy self-sufficient. Fourthly we make our data and model available under open licenses to allow for reproduction, adaptation and reuse.

## Materials and methods

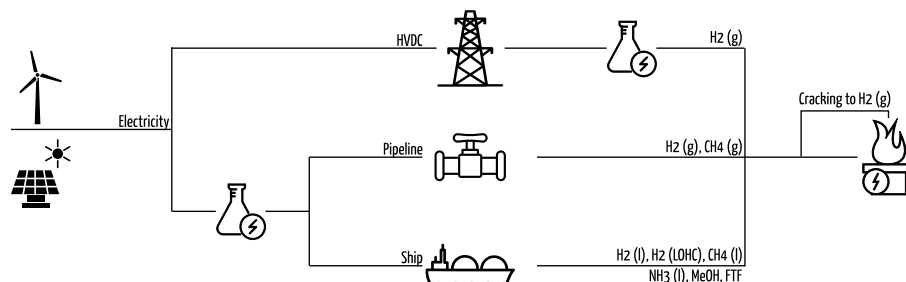
In this section we first describe how our ESCs are structured. The investment optimisation problem is outlined followed by a description of the assumed technologies and a motivation for the countries selected. We then illustrate how RES potentials and feed-in are derived domestic demand is considered. We end this section by motivating our choice of Weighted Average Cost of Capital (WACC) and an overview of the technical model structure. The most important equations on which this model builds are given in S 3 Appendix.

### Design of Energy Supply Chains

We model and investigate ESCs for chemical energy carriers starting at the energy source in an exporting country until the energy carriers are available in the importing country, in this analysis chosen to be DE. The ESCs considered in this study are export of a.) electricity by High-Voltage Direct Current (HVDC) with conversion to hydrogen in DE, b.) hydrogen gas by pipeline, c.) methane gas by pipeline, d.) liquid hydrogen by ship, e.) liquid methane by ship, f.) liquid ammonia by ship, g.) liquid methanol by ship, h.) hydrogen bound to LOHC dibenzyltoluene (DBT) [8] by ship, i.) liquid Fischer-Tropsch fuels (FT fuels) (kerosene-like) by ship. Fig 1 shows a schematic representation of all ESCs. For ESCs transporting ammonia, methane and methanol, an optional cracking step to hydrogen is further included for the case that the consumer needs pure hydrogen. Key properties of the chemical energy carriers are listed in Table 1.

The basic idea of the ESCs is shown in Fig 1. Detailed representations for all components, energy and chemical flows considered in each ESC are included in S 4 Figs. In each ESC we consider

- a.) sourcing of energy as electricity from RES,
- b.) sourcing of the major chemical feedstock for synthesis i.e. water from seawater desalination, carbon-dioxide ( $\text{CO}_2$ ) using Direct Air Capture (DAC) and nitrogen ( $\text{N}_2$ ) using an air separation unit (ASU) from ambient air,
- c.) electrolysis of hydrogen and optional synthesis (hydrogenation) of the chemical energy carrier,



**Fig 1. Schematic representation of ESCs considered in this study.** ESCs cover electricity generation from RES, intermediary buffer storage for electricity and chemicals, conversion to chemical energy carriers, conditioning and transport from exporter to importer. Each ESCs delivers one out of five chemical energy carriers. Detailed representations of each ESC and all involved technologies are included in S 4 Figs. License for icons: CC-BY-3.0 [17–21] and CC-0.

**Table 1. Energy content of chemical energy carriers considered.**

Energy carrier	State of matter (normal conditions)	Specific energy <sup>a</sup> [MWh/t]	Hydrogen content [wt. %]
Hydrogen H <sub>2</sub> (g) / (l)	Gas / Liquid (cryogenic)	33.33	100
LOHC (DBT) <sup>b</sup>	Liquid	1.87 <sup>c</sup>	5.6 <sup>d</sup>
Methane CH <sub>4</sub> (g) / (l)	Gas / Liquid (cryogenic)	13.89	25
Ammonia NH <sub>3</sub>	Gas / Liquid (cryogenic)	5.17	17
Methanol MeOH (CH <sub>3</sub> OH)	Liquid	5.54	12.5
FT fuel	Liquid	11.95	- (var.)

Values based on [22].

<sup>a</sup> All values represent the LHV.

<sup>b</sup> LOHC chemical is not consumed and reused, hydrogen is the chemical energy carrier delivered to the importer.

<sup>c</sup> H<sub>2</sub> share.

<sup>d</sup> DBT can hold up to 6.2% H<sub>2</sub>, a depth-of-discharge for cycling at 90% is favourable for (de-)hydrogenation [14].

- d.) necessary conversion of the energy carriers for transport, e.g. compression or liquefaction,
- e.) back-conversion into the energy carriers' usable form at ambient conditions, e.g. relaxation or evaporation.

If downstream processes require energy as input in addition to chemical feedstock, then this energy is provided from within the ESC. Either electricity is used for processes on the exporter side or the currently available chemical energy carrier is used, e.g. the propulsion energy for shipping is provided using the energy carrier transported by the ship and LOHC dehydrogenation uses part of the transported hydrogen. We exclude the transport within the exporting and importing country and storage in the importing country, i.e. excluded is

1. transport of electricity, feedstocks and chemical energy carriers between facilities and to the export terminal
2. short-term or long-term storage at the importer in DE
3. distribution and end use of chemical energy carriers within DE

We exclude these steps because the range of possible options, such as the time patterns of the demand, would create too many scenarios and detract from the generality of our analysis. Such scenarios are better suited for investigation in specific case studies.

The ESCs are generally designed to not interact with any systems outside the ESCs. This design decision excludes the possibility for use of secondary products such as process heat and cooling services from cryogenic carriers, the sale of chemical by-products such as O<sub>2</sub>. Also excluded are possible synergies by sector-coupling to heat and electricity systems on the exporter's and importer's sides, e.g. of industrial waste heat into the ESCs. Integration with other processes and commercial use of secondary products may provide grounds for business cases and lower market prices for chemical energy carriers.

## Investment optimisation problem

We model and optimise for least-cost investment of the essential components of ESCs to supply an annual energy demand. The ESCs components include electricity generators and generation based on historic weather data, conversion processes, buffer storage and transport between countries. The ESCs with their components, energy and mass flows are modelled using the open source modelling framework PyPSA [23]. We use a greenfield approach for our model and disregard existing infrastructure. We justify this modelling decision as a comparable scale of infrastructure described by the ESCs does not yet exist anywhere. Minimum annual investment costs are determined for each ESC based on the annualised cost  $c_i$  of every single component  $i$ . The annualised cost represent cost for investment Capital Expenditures (CAPEX)  $C_i$  and Fixed Operation & Maintenance (FOM) and are annualised using the Equivalent Annual Cost (EAC) method:

$$c_i = C_i \cdot (A_i + \text{FOM}_i) \quad (1)$$

where the component-specific annuity factor  $A_i$  is

$$A_i = \frac{(1+r)^{\text{lifetime}(i)} \cdot r}{(1+r)^{\text{lifetime}(i)} - 1} \quad (2)$$

The annual interest rate  $r$  is assumed equal to the selected WACC discussed below. The objective function to be optimised for minimal investment is

$$\min \left\{ \sum_{i \in \text{Generators}} c_i \cdot G_i + \sum_{i \in \text{Converters}} c_i \cdot F_i + \sum_{i \in \text{Storage}} c_i \cdot H_i \right\} \quad (3)$$

where generators (e.g. photovoltaics (PV)) are considered with their nominal capacities  $G_i$  (e.g. MW), converters (e.g. compressors, electrolysers) with their throughput capacity  $F_i$  (e.g. tonne per hour t/h, MW) and storage components (e.g. batteries, tanks) with their storage capacity  $H_i$  (e.g. MWh, m<sup>3</sup>). The optimisation is subject to constraints which ensure conservation of energy and mass flow and runs at hourly resolution. Most components may be freely dispatched without restrictions on ramping rates and minimum must-run capacities, as most technologies are usually flexible within a below hourly time-scale. Must-run capacities are only enforced for the synthesis of methane, ammonia, methanol and FT fuel, see the discussion in the technologies section. RES electricity feed-in is limited to the individual modelled time-series and excess electricity may be freely curtailed.

RES capacities may only be extended to the maximum potentials of their respective technology and resource quality class determined through geographic information system (GIS)-analysis, see the section on electricity supply below for details. The nominal capacities of all other components may be freely extended without limit. Capital costs for all components scale linearly with their capacity representing a

situation where capacity expansion requires new facilities rather than extending existing ones. The used capital costs and FOM already assume large scale facilities with respective economies of scale applied as well as exogenous learning rates for cost reductions between 2030 to 2050. Process efficiencies are assumed constant for all years (see S 10 Table) due to the difficulty of making well-founded estimates for future technological developments and improvements. One exception is made for hydrogen electrolysis where efficiency is expected to increase across all available technology options [24,25], an improvement which would affect all ESCs presented here. Thus the electricity-to-hydrogen (Lower Heating Value (LHV)) efficiency for electrolysis is assumed to improve from 68 % in 2030 to 71.5 % in 2040 and 75 % in 2050.

## Choice of technologies and energy carriers

The following section discusses the chemical energy carriers listed in Table 1 and their simplified production pathways. For most production pathways, alternative methods and integrated technologies with potential for efficiency improvement exist. Integrated technologies and alternative technology options are beyond the scope of our investigation and not discussed further.

### Renewable Energy Sources

We select utility PV, on-shore and off-shore wind as the only sources of energy for our model. We consider these technologies the only available ones with sufficient modularity and possibility for quick build up to high capacities while delivering near-zero carbon electricity necessary for a sustainable deployment. We consider the following other sources of energy unsuitable (with selected reasons):

- a.) hydro power (prioritised for domestic demand, limited geographical locations, significant environmental impact, poor modularity and scalability),
- b.) concentrated solar power (limited to specific geographical locations, low modularity and scalability),
- c.) conventional nuclear fission (intransparent cost, unmodular and difficult deployment, sustainability issues with fuel and waste streams),
- d.) nuclear fusion and unconventional nuclear fission (insufficient technology readiness level with unclear techno-economic prospects).

### Hydrogen

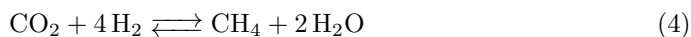
In all ESCs electricity is converted to the simplest chemical energy carrier, hydrogen, via alkaline electrolysis (AE). Compared to alternatives like proton exchange membrane (PEM) electrolyzers, AEs electrolyzers were historically considered to be less suitable to provide grid services due to their slow start-up times in the range of minutes [25]. For large scale operations in chemical energy carrier production the slow start-up time may be neglected because the electrolysis here does not need to provide grid services and the variability of RES feed-in can be managed using for example battery storage. The main advantages of AEs are that it is a well established technology which has in comparison to PEMs lower costs and does not require rare-earth-metals or platinum which may become bottlenecks for massive deployments in the future. In the case of large-scale hydrogen production and hydrogen-derived chemical energy carriers investigated here, we expect installations to run at high utilisation factors with a large number of modular units that can combine into a large unit to create virtual flexibility, thus negating the main weakness of AE. The necessary water for electrolysis is produced through

desalination of seawater via reverse osmosis to achieve the required purity and conserve existing, potentially scarce fresh water resources.

Hydrogen as a chemical energy carrier is versatile and may also be used as a feedstock for chemical synthesis. The physical properties of hydrogen make it difficult to transport as a gas due to its low energy density and as a cryogenic liquid due to the very low temperature required and high energy demand for liquefaction (0.203 MWh/MWh<sub>LHV</sub>).

### Methane

Methane is an alternative gaseous energy carrier to hydrogen and is synthesised in established production processes through catalytic reaction of CO<sub>2</sub> with H<sub>2</sub> via the reverse water gas shift reaction:



The synthesis is accompanied by adverse side reactions but can be run at high selectivity [26]. Transport of methane is well established and infrastructure for pipeline transport or transport as liquefied natural gas (LNG) already exists on large scales were synthetic methane may be used as drop-in replacement. Downsides are the emissions of CO<sub>2</sub> from combustion and methane during handling (leakage, slippage) and the high global warming potential (GWP) of methane. Liquefaction of methane requires less energy (0.036 MWh/MWh<sub>LHV</sub>) than liquefaction of hydrogen and handling of cryogenic LNG is less complex and better established compared to liquefied hydrogen.

### Ammonia

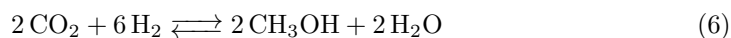
Ammonia is another option for an gaseous energy carrier and was already used as energy carrier in past applications. Ammonia is synthesised by hydrogenation of nitrogen in the Haber-Bosch reaction:



Feedstock nitrogen gas N<sub>2</sub> is available through extraction from the atmosphere via e.g. cryogenic ASUs. The ammonia synthesis process is well-established and an increasing focus in research for direct energetic applications of ammonia can be seen. In comparison to H<sub>2</sub> or CH<sub>4</sub>, NH<sub>3</sub> has a lower specific energy but a high boiling point at -33 °C, making it easier to handle as a liquid with a high volumetric energy density. In addition industry has long-standing experience of transporting and handling ammonia in its various forms, with around 10 % of the global 183 Mt annual ammonia production being traded [27]. Direct energetic use of ammonia is possible but poses a range of challenges including suppression of NO<sub>x</sub> emissions [28]. Alternatively ammonia may be used as hydrogen carrier where the dehydrogenation of NH<sub>3</sub> happens through thermal decomposition. The dehydrogenation process has high energy requirements (> 25 % of LHV [29]) and the technology is not yet fully commercially mature. Large specialised ammonia crackers are already in operation for the production of heavy water [27].

### Methanol (MeOH)

Methanol (MeOH) is a liquid organic compound with favourable properties for transport, storage and energetic use. It is obtained by hydrogenation of CO<sub>2</sub>:



either in a direct catalytic methanolisation reaction or by an indirect route using a reverse water gas shift reactor to obtain syngas [30]. With an annual production volume

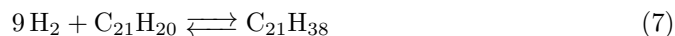
of ca. 100 Mt [31] methanol synthesis is a well-established process with industry experience in handling, storage and transport. Methanol is used either as a industrial feedstock, for power and heat generation, as a mobility fuel [32,33] and also be considered a member the LOHC family with the dehydrogenated form being CO<sub>2</sub> [8]. Methanol-to-hydrogen cracking (steam methanol reforming) is mature on small industrial scales [34] and practical where methanol logistics are easier than logistics for alternative hydrogen feedstocks like e.g. natural gas.

### Fischer-Tropsch fuels (FT fuels)

Liquid fuels like Fischer-Tropsch-Diesel or kerosene can be produced from CO<sub>2</sub> and H<sub>2</sub> via Fischer-Tropsch synthesis. These fuels can be used as drop-in replacements for today's fossil based fuels and are simple to transport and store due to their liquid nature. The catalytic Fischer-Tropsch synthesis is not very selective and yields a mixture of hydrocarbon products, requiring post-processing to yield FT fuels [35]. We neglect gaseous outputs like fuel gases which constitute approximately 20 % of the output [25] in our analysis and assume the products to have an average LHV of 11.95 MWh<sub>th</sub>/t which is similar to regular diesel and aviation kerosene. Fischer-Tropsch synthesis is well established process using fossil syngas and infrastructure as well as experience from fossil hydrocarbon handling can be directly applied to FT fuels.

### Liquid Organic Hydrogen Carrier (LOHC)

LOHC is the last chemical energy carrier we consider which allows for piggyback transport of hydrogen. We choose DBT as a representative of the variety of LOHCs available [8]. Between its dehydrogenated ('unloaded', H0DBT) and hydrogenated ('loaded', H18DBT) form it may be loaded with up to 9 H<sub>2</sub>:



For repetitive cycling and favourable (de-) hydrogenation a depth of discharge of 90 % is more favourable [14] corresponding to 5.6 wt. % H<sub>2</sub>. One significant advantage of DBT is that its properties do not change significantly between its hydrogenated and dehydrogenated form, allowing for the same infrastructure to be reused to achieve a closed LOHC cycle. The cost for the LOHC chemical DBT is assumed to be 2264 EUR<sub>2015</sub>/t. The LOHC can be easily handled and stored with infrastructure similar to that of commonly traded liquid carbohydrates. To access the hydrogen stored it has to be dehydrogenated which requires about 28 % of the hydrogen content as energy [8] as we assume the necessary heat has to be provided by the ESC itself and is not provided from an external source.

### CO<sub>2</sub> feedstock

Methane, methanol and FT fuels require carbon dioxide (CO<sub>2</sub>) as feedstock for synthesis. In our model all CO<sub>2</sub> feedstock is sourced from atmospheric CO<sub>2</sub> using DAC, thus creating a closed carbon cycle via the atmosphere between energy carrier synthesis and use. We do not consider the alternative approach of carbon capture (CC) at the location of use and back-transport of pure CO<sub>2</sub> to the location of energy carrier synthesis via a dedicated CO<sub>2</sub> infrastructure. This approach would require guaranteed capture of CO<sub>2</sub> from all use cases, which will prove complicated for applications where concentrated point sources are not available, like in aviation and individual mobility. Another obstacle to a perfect carbon cycle via CC is carbon leakage from imperfect CC which would need to be compensated through DAC infrastructure to ensure atmospheric carbon neutrality. Finally the infrastructure for recirculation of CO<sub>2</sub> would for most



ESCs require additional dedicated infrastructure for CO<sub>2</sub> transport, incurring additional costs and complexity. While the costs of carbon capture at the location of use and back-transport may not be prohibitive, but such closed carbon cycles would require detailed analysis that is out of the scope of this paper. For the LOHC ESC recirculation is considered here as the infrastructure for recirculation of DBT in the LOHC ESC is the same as required for delivery of the hydrogen-loaded energy-carrying LOHC.

### **Battery and chemical storage**

Storage technologies are essential for balancing the variable nature of RES electricity, buffering chemical feedstock and storing chemical energy carriers before export. Storage technologies smoothen the utilisation of downstream processes by buffering variable upstream processes like RES or hydrogen production in RES-follow mode. Storage capacity expansion is an alternative way to increase process capacities by additionally increasing downstream utilisation rates and thus leading to lower Levelised Cost of Energy (LCoE) if the investment into storage capacity is lower than into process capacity expansion. In our model electricity from RES may be stored in a battery buffer storage. CO<sub>2</sub> as a feedstock gas may be stored in liquefied form. Hydrogen and methane may be stored for short term buffer storage in a compressed form as their liquefaction process is energy and capital intensive. Larger amounts of any chemical are only stored in liquid form to reduce the necessary storage volume. For hydrogen and methane this requires energy intensive and well insulated tanks to store both liquids at cryogenic temperatures. Underground storage like salt caverns for gases are not considered to keep our ESCs independent of location and geological conditions. In comparison ammonia liquefaction and storage is significantly easier as its boiling point is only  $-33^{\circ}\text{C}$  and thus ammonia may be stored in liquefied form. Storage tanks for methanol, LOHC and FT fuel are straightforward as they correspond to today's technologies used for light and heavy hydrocarbons. The storage technology options available for each ESC are as shown in S 4 Figs. Storage capacities are endogenously determined by the model and represent optimal capacities under the given constraints minimising the objective function.

### **Flexibility of synthesis processes**

In addition to the economic perspective of operating synthesis processes at a high utilisation rate, some synthesis processes may be designed for continuous operation from a chemical process point of view [25, 26] and not be suited for flexible operation or standby. We consider this by assuming a must-run capacity for the methanation and ammonia synthesis processes of 30 % each, based on what could potentially be feasible for the methanation [26] and Haber-Bosch [25] processes. Methanol and FT fuel synthesis are assumed to run at a minimum of 94.25 % capacity corresponding to a maximum of 3 weeks downtime for e.g. maintenance per year. The must-run capacity is assumed for the aggregated availability factor of the whole respective process plant, e.g. a must-run capacity of 94.25 % translates to a maximum of 5.75 % of the facilities capacities being unavailable for maintenance or other reasons at the same time (see S 3 Appendix).

### **Transport: Transmission lines, pipelines and ships**

Transfer of the energy between exporting and importing country plays a significant role due to the different characteristics between transport modes. HVDC transmission lines for transfer of electricity and pipelines for hydrogen and methane gas are already deployed technologies. These technologies allow for a continuous export-import supply

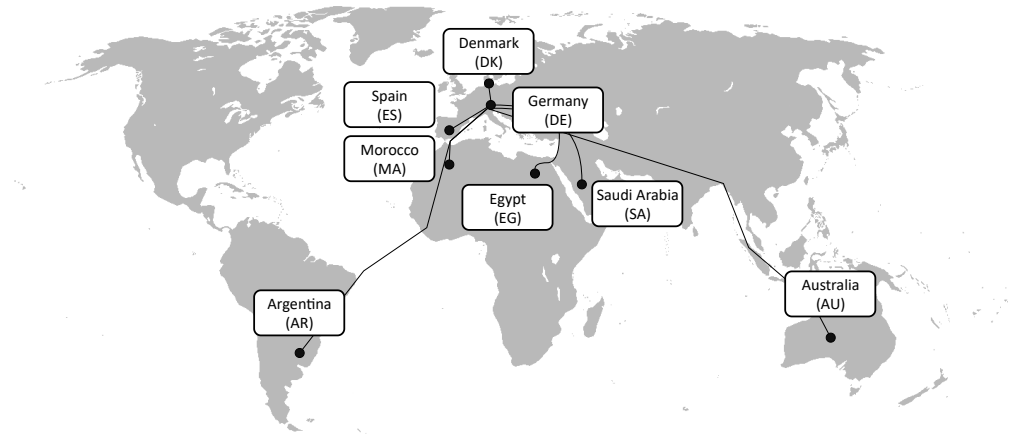
stream. We consider here average costs, energy demand and distance-related losses for HVDC transformers, transmission lines, pipelines and pipeline compressors for above-ground if geographically possible. For imports from Argentina (AR) and Australia (AU) subsea connectors are unavoidable and we consider average subsea HVDC transmission line and subsea pipeline costs. The pipeline compressor costs in these few cases are the same as for above-ground pipelines due to a lack of reference numbers for long-distance deep-sea pipeline connectors. The numbers may thus prospectively underestimate real compressor costs. Shipping is the third class of transport modes considered and characterised by a non-continuous and delayed transfer of the energy carrier. We take this shipping characteristics into account by not allowing for concurrent use of loading and unloading infrastructure by different (groups of) ships at the same time. Rather than having ships travel at their (maximum) average cruise speeds and wait for the (un-) loading terminals to become available we create ex ante shipping schedules with lowered cruise speeds such that the arrival and departure of (groups of) ships does not overlap. The shipping distance along sea routes affect the shipping duration in the shipping schedules and the energy demands for propulsion, optional onboard refrigeration of boil-off gases and finally the necessary number of ships.

### Countries investigated

In our study we investigate large scale energy imports to Germany (DE) from the various countries shown in Fig 2. Germany as a country is interesting, as it heavily relies on energy imports today, is phasing out nuclear power and has less abundant renewable energy resources compared to other countries. We assume an energy import volume of 120 TWh based on the estimated hydrogen energy demand (LHV) for 2030 in the German Hydrogen Strategy [36]. On the one hand this number may seem ambitious given the high German fossil energy imports today and that its hydrogen production currently is mostly captive or merchant hydrogen from fossil sources without carbon capture. On the other hand we also presume an increase of this volume by 2040 and 2050 as not only fossil energy carriers but also industrial feedstock will have to be substituted by hydrogen or other chemicals. The import volume in our model is considered as annual demand since hydrogen uses and their demand patterns are yet to be known. This way it is decoupled from a specific demand pattern such with constant baseload or seasonally changing hydrogen demand and their case-specific buffer storage needs. As a reference we model and include chemical energy carriers produced from domestic resources in DE. The other countries included in our study are:

- a.) Spain (ES), an EU country with high solar potentials,
- b.) Denmark (DK), an EU country in close proximity to DE with high wind potentials,
- c.) Morocco (MA), Egypt (EG) and Saudi Arabia (SA), representative countries in relative proximity to the EU with low population densities and high renewable potentials,
- d.) Argentina (AR), a country repeatedly investigated by similar studies for exports of hydrogen to Japan,
- e.) Australia (AU), a country discussed for energy exports to DE and as a possible future powerhouse for Asian countries.

The distance of an export-import route ESC influences the associated costs. With increasing distance investment costs, transportation energy demand, losses and duration (for shipping) increase. The lengths of pipelines and transmission lines are based on the



**Fig 2. Countries considered for export.** Exports of chemical energy carriers from countries shown to Germany (DE) are modelled and investigated for nine different Energy Supply Chains (ESCs).

as-the-crow-flies distances between the country centres scaled by different detour factors for transmission lines (1.2) and pipelines (1.4). For AR and AU a land-only connection is not possible. We therefore estimate the share of distance to be traversed with submarine technologies based on the shortest cross-continental distances and scale them with the same detour factors as for land connections. A comparable approach with detour factors does not work for shipping routes as it does not account for land and water bodies. Instead we opt to use a freely available data source [37] to measure the shortest shipping routes. All resulting distances used are shown in Table 2.

**Table 2. Distances between exporting countries and DE assumed for each ESC.**

From	Code <sup>a</sup>	Distance <sup>b</sup> [km]	HVDC line <sup>c</sup> [km]	Pipeline <sup>d</sup> [km]	Ship <sup>e</sup> [km]
Argentina	AR	12 280 (3000)	14 736 (3600)	17 192 (4200)	13 056
Australia	AU	14 450 (3000)	17 340 (3600)	20 230 (4200)	20 284
Denmark	DK	580 (0)	696 (0)	812 (0)	812
Egypt	EG	3220 (0)	3864 (0)	4508 (0)	6605
Germany	DE	0 (0)	0 (0)	0 (0)	0
Morocco	MA	3330 (0)	3996 (0)	4662 (0)	2938
Saudi Arabia	SA	4240 (0)	5088 (0)	5936 (0)	12 174
Spain	ES	1600 (0)	1920 (0)	2240 (0)	3587

Bracketed values indicate the share of submarine distances considered.

<sup>a</sup> Based on ISO 3166-1 alpha-2.

<sup>b</sup> As-the-crow-flies distance between region centres [38], measured in Google Maps.

<sup>c</sup> Distance times a detour factor 1.2, own estimate.

<sup>d</sup> Distance times a detour factor 1.4, based on [39].

<sup>e</sup> Shortest sea route, determined with [37].

## Electricity supply, demand and supply curves

For each country we model RES potentials and time-series based on results from a GIS-analysis and historical weather data using the GlobalEnergyGIS (GEGIS) model [40]. Eligible areas for PV and wind installations are determined on a 1 km<sup>2</sup> grid resolution by exclusion of protected areas, unsuitable land types and areas of high

population density. Areas not within a 400 km radius of a gross domestic product (GDP) density of 100 000 USD/km<sup>2</sup> are further excluded where the threshold serves as a proxy to grid access and location accessibility. For a detailed description we refer to [40], for maps of the resulting eligible area see S 12 Figs. Annual capacity factors are determined for all eligible grid cells and types of RES using ERA5 reanalysis weather data and data from the Global Wind Atlas (GWA) for 2013 as representative weather year. Grid cells are then categorised into one of 100 quality classes (0 % to 100 % Capacity Factor (CF)) for each RES technology based on their annual capacity factor. From the categorisation the potential of each quality class for each of the three RES technologies is calculated assuming a deployable potential of 1.45 MW/km<sup>2</sup> (PV) and 3 MW/km<sup>2</sup> (on-shore and off-shore wind). This potential is a compromise between technical potential, accessible potentials and social acceptance used in another study for the European electricity grid [41]. For PV these potentials may be conservative for less population dense regions and closer to the equator where others consider 75 MW/km<sup>2</sup> (PV) and 8.4 MW/km<sup>2</sup> (wind) feasible [2]. For large continuous wind farms power densities may need to artificially be reduced to lessen wake effect penalties [42]. These influences become more relevant for exporters with already high potentials and flat supply curves and therefore should therefore not contribute a major influence on this studies' supply side.

In addition to the potentials we derive hourly generation time-series for each technology and quality class, resulting in a total of up to 300 independent RES time-series for each exporter.

**Table 3. Main technology assumptions for RES and electrolysis.**

Technology	Lifetime	CAPEX	FOM	Density	Efficiency
2030/2040/2050	[years]	[EUR <sub>2015</sub> /kW]	[% p.a.]	[MW/km <sup>2</sup> ]	[%]
PV (utility)	40/40/40	376/329/302	1.9/2/2.1	1.45	—
wind onshore	30/30/30	1035/978/963	1.2/1.2/1.2	3	—
wind offshore	30/30/30	1573/1447/1416	2.3/2.3/2.3	3	—
electrolysis	30/32/35	450/330/250	2/2/2	—	68/71.5/75

Assumptions based on [43] and [25] used for 2030, 2040 and 2050. CAPEX reflects the engineering, procurement and construction price. A full list of all technology assumptions is included in S 9 Table.

From the annual generation for each quality class we can calculate each classes respective LCoE following

$$\text{LCoE (RES)} = \frac{\text{Annualised cost}}{\text{Annual generation}} = \frac{\text{CAPEX}}{G(2013)} \cdot \left[ \text{FOM} + \frac{r}{1 - (1 + r)^{-t}} \right] \quad (8)$$

assuming technology specific parameters (Table 3), as well as  $r = \text{WACC}$  and the modelled annual electricity generation  $G$  in 2013. By ordering the class potentials based on their LCoE we obtain country specific electricity supply curves. Fig 3 shows examples using 10 % p.a. WACC and technology (cost) assumptions for 2030.

Using the supply curve we account for projected domestic electricity demand: We generate electricity demand projections with a machine learning approach implemented by GEGIS [40]. The demand projections are based on global datasets for GDP, calendar days, temperature from ERA5 and the SSP2-34 'Middle of the Road' scenario [44] for 2050. This approach extrapolates past demand into the future and cannot account for structural changes like increasing demand through electrification. The projections are thus to be considered conservative estimates for electricity demand. The projected demands are shown in Table 4.

We consider the domestic electricity demand by removing the equivalent volume and RES with the lowest cost RES supply from our model. This corresponds to reserving the capacities with lowest expected LCoE for domestic use. The respective volumes are

**Table 4. Used future (2050, projected) electricity demand and actual (2018) for reference.**

Country	demand 2018 (actual) <sup>a</sup> [GWh]	demand used 2050 (projected) [GWh]
Argentina (AR)	125 030	346 904
Australia (AU)	234 278	314 389
Denmark (DK)	32 865	44 854
Egypt (EG)	150 579	615 351
Germany (DE)	533 177	759 065
Morocco (MA)	29 678	122 419
Saudi Arabia (SA)	322 373	1 145 638
Spain (ES)	245 426	355 416

<sup>a</sup> Source: [45].

marked in the supply curves by the black dashed lines for the shown example 2030 and 10 % p.a. WACC. Changes to the RES technology costs (year assumption) and WACC assumption affect the order of RES and therefore change RES with associated time-series available for export. Considering the shape of the supply curves in Fig 3, this approach noticeably affects the Marginal Costs of Energy (MCoEs) for DE and Denmark (DK).

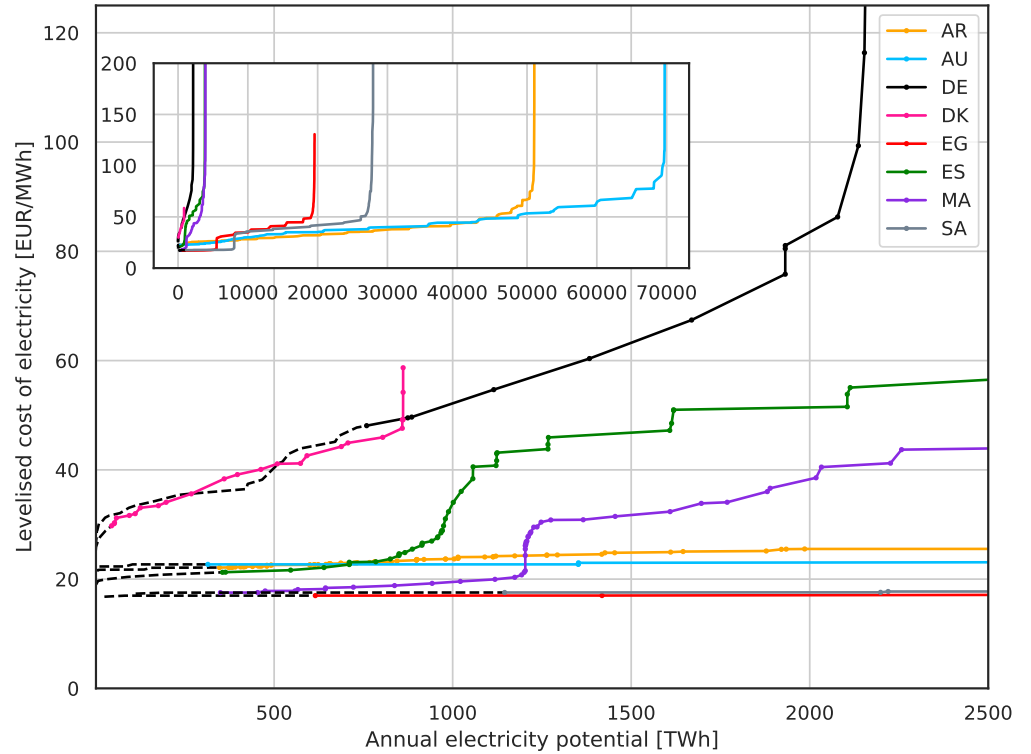
### Choice of WACC

The choice of the costs of capital influences all cost calculations and is therefore crucial for meaningful results. [46] showed how configurations of a cost-optimised European electricity system change significantly from changes to WACC assumptions, especially non-homogeneous, country-specific assumptions. At the same time we are aware of the possible bias this might introduce, cf. [47].

To retain comparability we assume time and technology independent WACC. We further choose to assume 10 % p.a. WACC for all investments within all ESCs independent of the exporting country. This choice is founded on the assumptions used by IRENA, where the authors used inhomogeneous WACC assumptions of 10 % p.a. for non-OECD countries and 7.5 % p.a. for OECD countries and China in [48]. WACC for local RES projects usually depend on the technologies used and on individual project as well as country-specific risks [49]. It will therefore be interesting to see how WACC will develop for highly vertically integrated, multi-national and mixed-technology ESCs as presented here.

### Technical model structure

We use a multi-step workflow hard-linked using `snakemake` [50]. In the first part of the workflow we utilise GEGIS [40] to determine potentials for RES, RES generation time-series and predict electricity demand. In the second part of the workflow we implement the ESCs in PyPSA [23] and combine them with the RES potentials, RES time-series and demand predictions into one dedicated PyPSA model for each combination of ESC and exporting country. The structure is also visualised in S 2 Appendix.



**Fig 3. Modelled electricity supply curves for 2030 at 10 % p.a. WACC.** Dashed black parts are reserved for meeting domestic electricity demand and unavailable for export. The inset contains the same plot on a larger scale. The visible step-wise increase in LCoE for ES and MA is where the cheapest electricity potentials from low cost PV are exhausted and the onshore and offshore wind enter the supply curve.

## Results

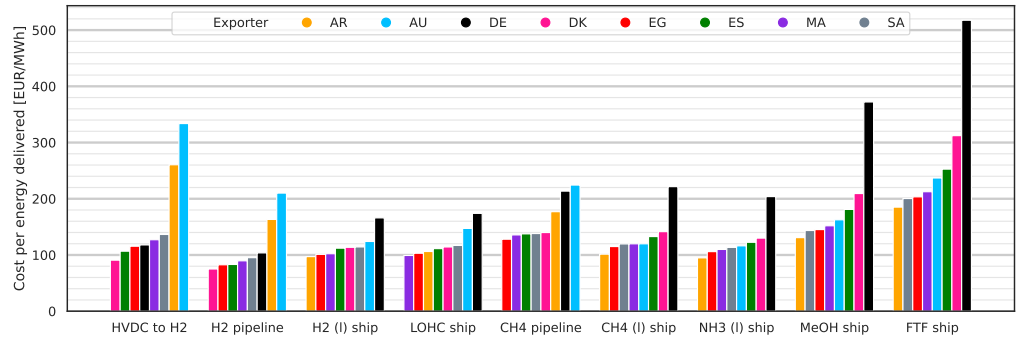
Results are compared with a focus on their Levelised Cost of Energy and Levelised Cost of Hydrogen. The LCoE represent the costs for delivering 1 MWh of energy in the form of the energy carrier of the respective ESC, i.e.  $\text{H}_2$  (g),  $\text{CH}_4$  (g),  $\text{NH}_3$  (g), methanol or FT fuel. For the Levelised Cost of Hydrogen (LCoH), costs are compared for delivering 1 MWh of  $\text{H}_2$  (g) to the importer.

We first present LCoE for all ESCs and exporting countries for 2030. Then we show the development of LCoE based on technology cost projections up to 2050. Cost compositions for the ESCs are examined and main cost drivers discussed. We then continue by looking at the LCoH and by discussing sensitivities of the ESCs based on an sensitivity analysis for two selected scenarios. The sensitivity analysis shows an expected strong dependence to the choice of WACC on two selected ESCs from Spain (ES) to DE. We therefore also present LCoE and LCoH for 2030 to 2050 under a more optimistic choice for WACC of 5% p.a.. Additional results focusing on supply chain efficiency, curtailment rates and installed RES capacities are discussed in the S 1 Appendix and S 5 Figs. Presented results for LCoE and LCoH are included as tabular form in S 7 Table and S 8 Table.

### Energy import costs for 2030 to 2050

LCoE, i.e. total system cost per  $\text{MWh}_{\text{th}}$  delivered to DE, are shown in Fig 4 for 2030, 10% p.a. WACC and all exporting countries. The lowest cost options for import are by  $\text{H}_2$  pipeline from DK at 75 EUR/ $\text{MWh}_{\text{LHV}}$  and at 83 EUR/ $\text{MWh}_{\text{LHV}}$  from Egypt (EG) and ES. All three ESCs take advantage of the low losses and investments associated with  $\text{H}_2$  pipelines as static transport option and the short to medium transport distances to DE. With costs of 104 EUR/ $\text{MWh}_{\text{LHV}}$  domestic  $\text{H}_2$  production in DE is less attractive than these imports.  $\text{CH}_4$  imports by pipeline are the least cost attractive option of the three (HVDC to  $\text{H}_2$ ,  $\text{H}_2$  &  $\text{CH}_4$  pipeline) static transport connection ESCs. Methane in particular may be imported at lower costs as  $\text{CH}_4$  (l) by ship rather than by  $\text{CH}_4$  (g) pipeline. Cost performances of the shipping ESCs for  $\text{H}_2$  (l), LOHC and  $\text{NH}_3$  (l) are similar to those for  $\text{CH}_4$  (l). They are followed by ship-based imports of methanol and finally imports of FT fuel by ship. There are some outliers for AR and AU for the static HVDC and pipeline connection ESCs. Reasons are the long transport distances for both exporters and the related high investment required for the HVDC and pipeline infrastructure.

An order of preference for the exporting countries can be identified: For statically connected ESCs short and mid-distanced exporters like DK, ES and EG are preferable. For ship-based ESCs, AR offers the lowest cost imports of energy to DE, making use of its good-quality RES, followed by imports from EG again. The least favourable position is taken by domestic production in DE: Generally for each ESC exists an alternative where the same energy carrier can be sourced for 75% of the cost of domestic production in DE. This development is driven by the low quality RES with high electricity costs and the approach we used to reserve RES capacities for domestic electricity demand. The approach reserved all PV potentials and only left wind resources for chemical production (cf. S 5 Figs). Wind energy in Germany suffers from low output between June and September which the model compensates by over expanding wind capacities to keep supplying the synthesis processes. This is cheaper than using storage by batteries, which are not economical for storing more than a few hours worth of electricity demand, and there is no longer term electricity storage in the model. The remaining time of the year excess electricity is curtailed, causing high curtailment rates (cf. S 1 Appendix) for DE. This leads to domestic production in DE to be competitive with imports only if  $\text{H}_2$  is produced without further processing.



**Fig 4. LCoE in 2030 assuming 10 % p.a. WACC by ESC and exporter.** LCoE are per  $\text{MWh}_{\text{th}}$  delivered to DE. Lowest cost options are imports via HVDC with subsequent electrolysis in DE and  $\text{H}_2$  pipelines. For more complex and energy intensive ESCs on the right the order of preference is different compared to the static import options with imports from AR in all but one case being the cheapest.

Under this condition the absence of need to transport chemicals internationally can compensate for the higher production cost in DE.

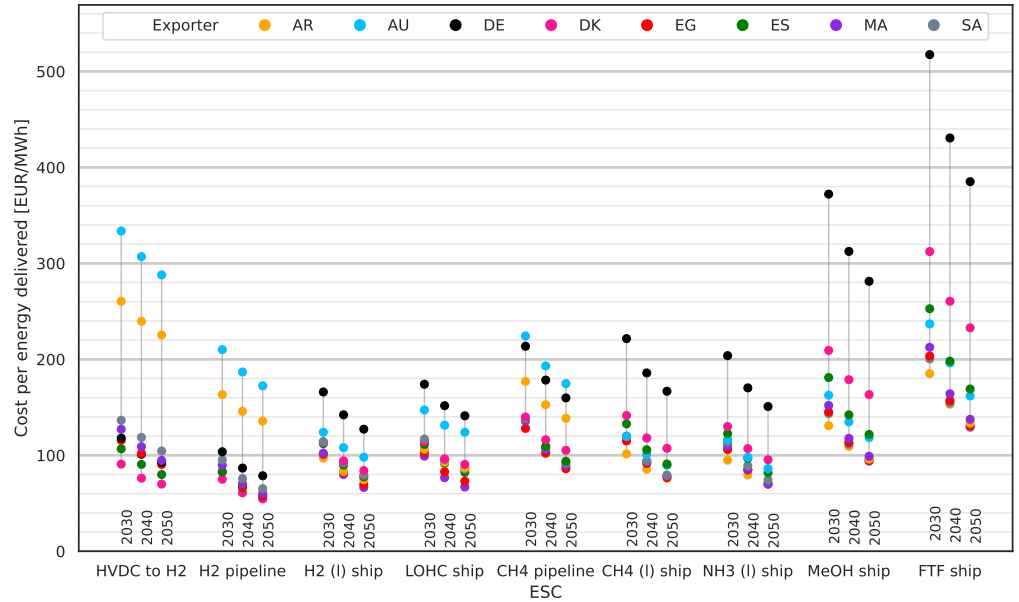
In Fig 5 the LCoE are shown declining in accordance with decreasing technology cost by 2050. Some of the projected LCoE decrease more strongly than others, most notable for methanol and FT fuel. While  $\text{CH}_4$  (l) transport is cost competitive with  $\text{CH}_4$  pipeline transport due to technological developments in the LNG industry over the past decades, for hydrogen the more complex of the transport chain and higher energy demands for liquefaction continue to make  $\text{H}_2$  pipelines the preferred option for  $\text{H}_2$  imports in the future. Noteworthy are the spreads between different ESCs and years. Neglecting domestic production in DE, the spread of LCoE for  $\text{H}_2$  (l) or LOHC ship imports is low compared to the spread of methanol and FT fuel imports. It is also worth noting that the exporting country preference order does not change much between the years. Highest and lowest cost exporters stay the same and only some reordering in the cost mid-field can be seen where some countries benefit from anticipated cost developments more than others, see the mid-field options for methanol or  $\text{NH}_3$  shipping. This observation translates to no significant changes in the cost compositions of the ESCs, but rather just a general more or less homogeneous decrease of the total costs due to the cost technology reductions and electrolysis efficiency gains by 2050.

### Cost composition and drivers

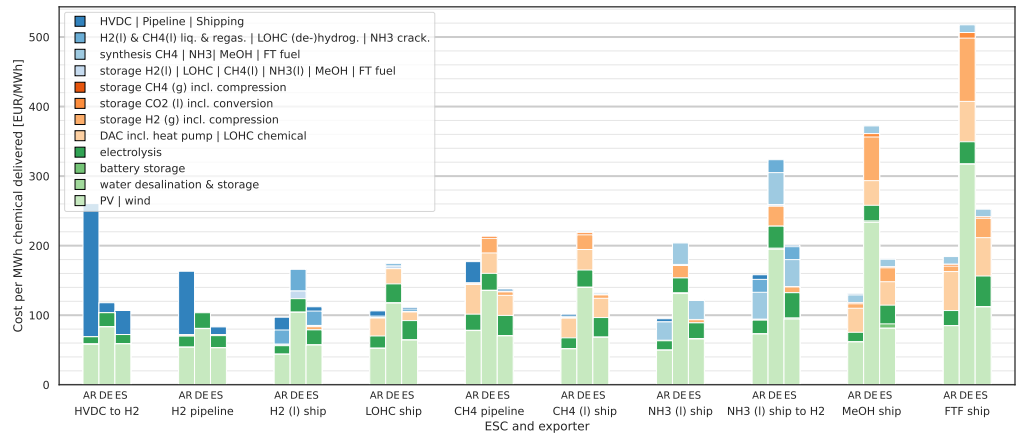
Cost drivers can be individually identified for all ESCs by investigating their cost compositions. Fig 6 shows the cost compositions for three selected countries, comparing exports from AR and ES with domestic production in DE. Additionally a tenth ESC is included where ammonia is decomposed back into hydrogen for investigating hydrogen import costs discussed in the next section. The costs shown are the annualised cost per component. Energy costs are not attributed to the components and instead cause higher upstream investments for conversion steps or RES capacities to keep the ESCs self-sufficient.

RES generally make the single largest cost contribution between 39% to 55% (interquartile distance). The specific cost contribution depends on the ESC, exporter, the local energy demand and conversion processes involved. Electrolysis plays only a minor role with on average 5% of the costs in the shown cases. The costs for synthesis or liquefaction processes and DAC (for  $\text{CO}_2$ -based ESCs) have a higher contribution





**Fig 5. LCoE in 2030 to 2050 assuming 10% p.a. WACC by ESC and exporter.** LCoE are per  $MWh_{th}$  delivered to DE. The lowest cost import options are  $H_2$  (g) imported by pipeline and electricity imports by HVDC with subsequent electrolysis. Methanol and FT fuel imports experience the strongest cost decrease linked to the anticipated cost reduction for synthesis and DAC.



**Fig 6. Cost composition of selected ESCs for 2030 at 10% p.a. WACC.** Simpler, less energy intensive ESCs are favourable for short distances, e.g. domestic sourcing from DE and imports from ES, where low costs associated with transport can compensate high RES costs. More complex, energy intensive ESCs allow long distances exports, e.g. from AR, to become cost competitive due to lower RES costs and trading more complex molecules with higher energy intensity for lower transport cost.

than electrolysis. Related to the synthesis processes is the necessity for chemical feedstock storage required to operate the synthesis processes at and above their must-run capacities. The contribution from H<sub>2</sub> and CO<sub>2</sub> feedstock above-ground steel tank storage is higher for most ESCs than the contribution from electrolysis. Some feedstock storage is also deployed for domestic provisioning of H<sub>2</sub> (l) in DE but it cannot be seen for all H<sub>2</sub> (l) ESCs. The costs associated with shipping are negligible in comparison to HVDC and pipeline costs.

From Fig 6 we can also identify cost drivers for the bad performance of AR as an exporter with the static pipeline and HVDC to H<sub>2</sub> ESCs: The HVDC and H<sub>2</sub> pipeline connections have high investment costs due to the long distance between AR and DE. For the CH<sub>4</sub> pipeline connection the investment costs are only a third of the H<sub>2</sub> pipeline, but the LCoE is driven by energy demand of the CH<sub>4</sub> pipeline which is assumed to use the transported CH<sub>4</sub> (g) as energy source. This energy demand for transport requires additional capacities for CH<sub>4</sub> synthesis, H<sub>2</sub> electrolysis and CO<sub>2</sub> capture as well as RES capacities, thus making pipeline transport less attractive across medium and long distances compared to H<sub>2</sub> and CH<sub>4</sub> shipping. For the LOHC ESC the long shipping distance increases shipping time and thus makes larger volumes of the LOHC chemical necessary which is reflected in the share of cost of the LOHC chemical. In comparison to ES as an exporter the necessary LOHC chemical investment volume is 2 times higher for AR as exporter. Despite this the LCoE for imports from AR by LOHC are lower than from ES due to the country-specific differences in available RES: While the LOHC investment volume for ES is lower compared to AR, the LCoE in the electricity supply curve are higher for ES than for AR. For domestic production in DE the LCoE for electricity from RES are driving the ESCs LCoE even higher. Furthermore the lower CF of RES in DE lead to higher capacities for electrolysis needed during peak production but with lower overall utilisation rate. The case of LOHC is the only ship-based ESC where imports from AR do not offer the lowest LCoE. Comparing the LOHC ESC and the other carbon-based shipping ESCs with the NH<sub>3</sub> (l) ESC shows the advantages of an energy carrier with low investment costs on the synthesis molecule (N<sub>2</sub>) compared to the high cost for the LOHC chemical and CO<sub>2</sub> sourcing and handling. Inflexibilities in the synthesis processes do not directly become apparent from the cost composition figure but show up indirectly by the need for increased buffer storage capacities and overcapacities of components upstream in the ESCs, e.g. RES. A good example for this are the FT fuel and CH<sub>4</sub> (l) ESCs where the more inflexible FT fuel synthesis leads to higher RES investments per MWh with higher curtailment and a different mix of RES capacities (see 12).

Battery storage is usually only deployed with limited capacities, able to sustain the ESC only for a few hours. In a few cases larger capacities of battery storage are deployed with a notable influence on the LCoE. Battery deployment can mainly be seen for HVDC, methanol and FT fuel-based ESCs, e.g. the HVDC to H<sub>2</sub> ESC for ES in 2040 (see S 6 Figs). Investment into battery storage in the model coincides with higher shares of PV in the generation mix to increase the utilisation factor of downstream infrastructure, e.g. HVDC links, and to provide continuous electricity supply for must-run methanol and FT fuel synthesis processes. While sea water desalination is an important aspect for ensuring a sustainable production environment its costs and electricity needs do not contribute in a significant way to the final energy carrier cost.

Leverages for decreasing overall costs lie in reduction of storage costs by either direct reduction of the investment costs or usage of different technologies, e.g. cavern storage instead of steel-tank storage for H<sub>2</sub>. An indirect leverage is the flexibility of synthesis processes as the must-run processes drive the storage volumes in our results, something which was shown for methanol by [51]. Increasing flexibility of processes and enabling lower must-run capacities as well as hot-standby would decrease the required storage

volumes. Simultaneously it would increase the cost share of the synthesis process, such that cost improvements of the said processes could have a higher impact in lowering total product costs.

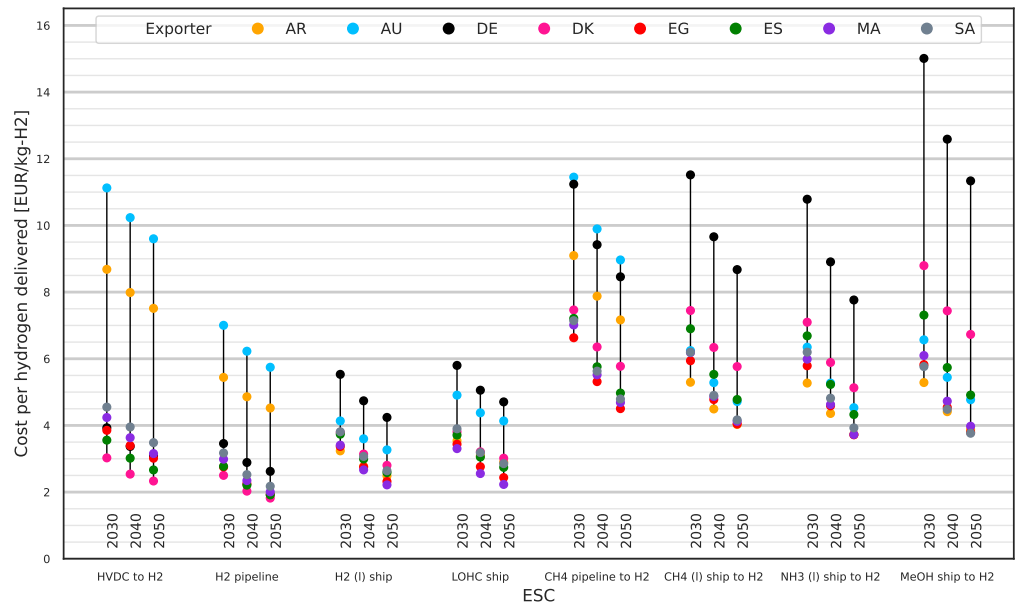
## Hydrogen import costs for 2030 to 2050

In addition to comparing the costs of energy delivered, we can also compare the ESCs based on their import costs for delivering hydrogen. For this we calculate the levelised cost of delivering 1 MWh  $\text{H}_2$  (g) using adapted versions of the previously discussed ESCs. Comparing the cost of hydrogen rather than the cost of energy is useful for applications which either require pure hydrogen like hydrogen fuel cells or processes requiring hydrogen as an industrial feedstock.

The ESCs used are identical where the ESCs already delivered  $\text{H}_2$  (g). The  $\text{CH}_4$ ,  $\text{NH}_3$  and MeOH ESCs are extended by cracking processes for converting the energy carrier to  $\text{H}_2$  (g) with their respective energy demand and investment costs. The additional cracking processes are steam methane reforming (SMR), methanol steam reforming (MSR) and ammonia cracking. Additional water demand of the cracking processes is neglected. The extra process steps and their location in the ESCs are shown in S 4 Figs. We exclude cracking of FT fuel as methanol can be considered an equivalent choice for the purpose of being a liquid, carbon-based hydrogen carrier under ambient conditions but with easier synthesis. FT fuels are better suited as drop-in fuel replacements.

Resulting LCoH for 2030 to 2050 are shown in Fig 7. There is a clear cost advantage for the four ESCs which import hydrogen directly (left side) compared to the four ESCs requiring an additional cracking step (right side). Lowest cost imports are from DK by  $\text{H}_2$  (g) pipeline at 2.5 EUR/kg $\text{H}_2$  in 2030 and 1.8 EUR/kg $\text{H}_2$  in 2050. Other exporters located in close proximity, i.e. ES and the Western Asia and Northern Africa (WANA) countries, offer hydrogen at only slightly higher LCoH and can thus be considered comparable alternatives. For non-static imports via ship  $\text{H}_2$  (l) and LOHC ESCs exports from AR and to some extent from AU are also attractive. By 2050 as most exporting countries show similar LCoH the question of exporter makes no big difference from a techno-economic point of view as there does not seem to be an inherent advantage to a specific exporter. For the remaining non- $\text{H}_2$ -based ESCs the additional conversion steps required for  $\text{CO}_2$ -based and the  $\text{NH}_3$  ESCs drive their energy demand and investment costs, leading to less attractive LCoH starting at 5.3 EUR/kg $\text{H}_2$  in 2030 decreasing to 3.7 EUR/kg $\text{H}_2$  in 2050 from various exporters via  $\text{NH}_3$  and methanol.

If long-term storage were additionally taken into account, the ammonia and methanol ESCs would have an advantage over the  $\text{CH}_4$ -based ESCs due to easier long-term bulk storage. This advantage would translate into lower LCoH in comparison to the other ESCs with the advantage increasing with the storage duration. Examining the results for alternative exporter options, it shows that in general for each lowest cost option of an ESC an alternative exporter with similar or slightly higher LCoH exists. Neglecting the extreme outliers for AR, AU and DE, the spreads for pipeline based and direct hydrogen imports are lower than for ship based  $\text{NH}_3$ ,  $\text{CH}_4$  (l) and methanol imports. The higher spreads translate to a higher uncertainty of hydrogen import costs when trade relations change and a switch in exporting country become necessary. Choosing a chemical energy carrier and ESC for scale up based on lower spreads in LCoH and existing low cost exporter alternatives ensures the opportunity for increased competition and potential exporter substitution in the future.



**Fig 7. Levelised Cost of Hydrogen (LCoH) for 2030 to 2050 using extended ESCs.** Direct hydrogen imports have lower LCoH than the alternative ESCs using methane, methanol or ammonia as energy carrier. The extended ESCs include extra process steps for cracking of the energy carrier to deliver hydrogen. All costs assuming 10 % p.a. WACC.

### Sensitivity analysis

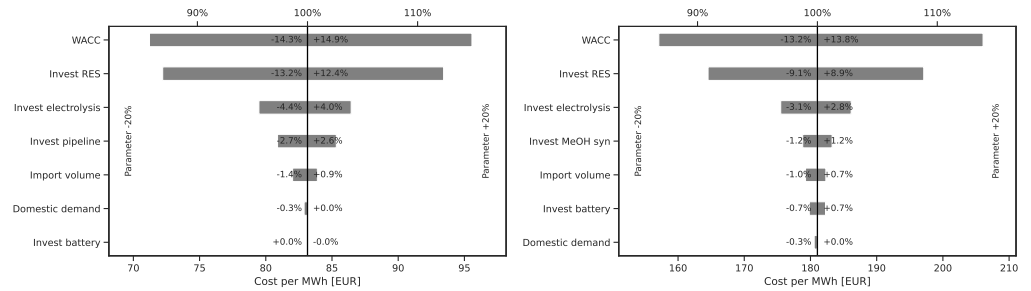
The sensitivities to exogenous parameter changes are visualised in Fig 8. Sensitivities are dependent on the scenario (year, ESC, exporter) by model design. We present quantified results for two selected scenarios of imports from ES to DE in 2030, by H<sub>2</sub> (g) pipeline and shipping of methanol. The exogenous parameters to be considered in the sensitivity analysis were pre-selected based on which parameters were expected to have the highest influence on the LCoE. For both ESCs one additional major cost contributor based on the cost composition analysis was added, i.e. CAPEX for H<sub>2</sub> pipeline including compressors and methanol synthesis.

The results show the highest influence on LCoE to be from the choice of WACC, followed by variations to CAPEX of RES and then the CAPEX of electrolysis or the ESC specific contributor (investment in pipeline or MeOH synthesis).

Reduction of CAPEX for batteries has no effect for the pipeline-based ESC and only a small symmetric effect on the methanol ESC. Variations of domestic demand and import volume are negligible. This is to be expected because the relevant supply curve range does not show considerable changes to the LCoE in the relevant area around 500 TWh of electricity demand.

### Lower WACC scenario

As indicated by the sensitivity analysis, the choice of WACC has the highest influence on the two ESCs analysed. Following this result we revisit the earlier analysis of LCoE and LCoH and rerun our model assuming 5 % p.a. WACC (= -50 %). Resulting LCoE are shown in Fig 9 and LCoH in Fig 10. The lower assumption is optimistic in comparison to other investigations like [48], but plausible and in line with recent reports



**Fig 8. Sensitivities for two ESCs (left) H<sub>2</sub> (g) pipeline and (right) methanol by ship from ES to DE for 2030.** Parameters listed on the left y-axis were varied by  $\pm 20\%$ . The x-axis shows the resulting LCoE after variation and the relative change. The highest impact on the LCoE can be attributed to the choice of WACC followed by the cost of renewables and hydrogen electrolysis.

like [52,53] and in the face of similar or lower WACC reported for e.g. PV projects [49]. For large scale projects the assumption is also more reasonable as the projects include arguably high national interests and therefore support. The lower WACC leads to reductions of LCoE and LCoH each by around 35%. This exceeds most of the original scenario reductions seen between 2030 to 2050 due to technological learning. Under these more optimistic WACC assumptions one can find within each ESC one exporter and for each exporter one ESC with LCoE below 100 EUR/MWh<sub>LHV</sub>. Similarly options for LCoH below 4 EUR/kg<sub>H<sub>2</sub></sub> are available for all ESCs and exporters. What is left unchanged is the order of preference for exporting countries within each ESC; given that the change to WACC affects all exporters the same way this result is not surprising.

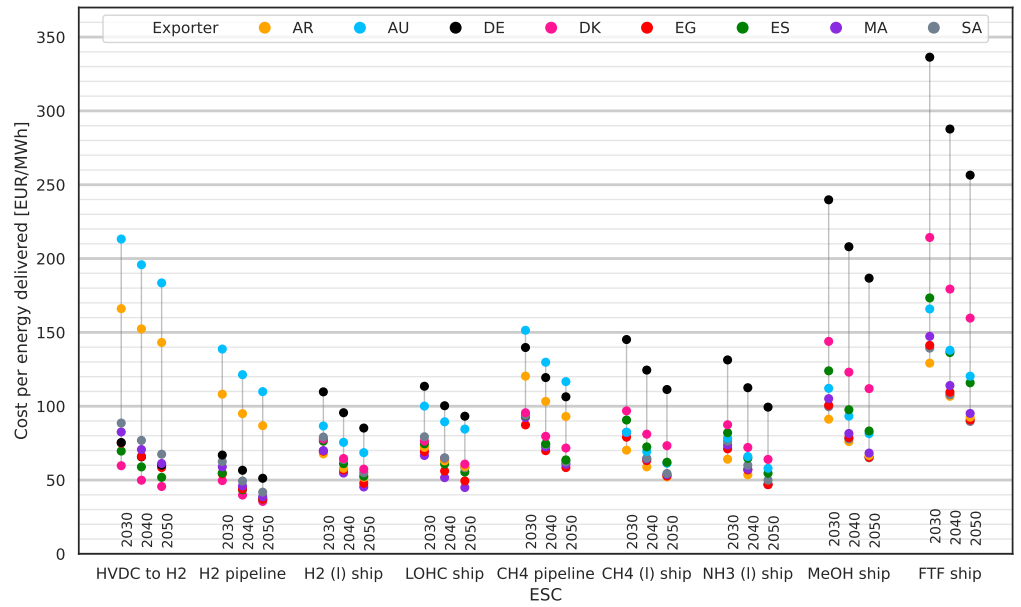
Lowest LCoE are 50 EUR/MWh<sub>LHV</sub> in 2030 to 36 EUR/MWh<sub>LHV</sub> in 2050 by H<sub>2</sub> pipeline from DK which are also the lowest LCoH at 1.7 EUR/kg<sub>H<sub>2</sub></sub> in 2030 to 1.2 EUR/kg<sub>H<sub>2</sub></sub> in 2050. By 2050 more than 20 ESCs offer options for imports of hydrogen at 2 EUR/kg<sub>H<sub>2</sub></sub> (60 EUR/MWh<sub>LHV</sub>) or lower, most of them being by a static transport connection via H<sub>2</sub> pipeline or HVDC but also including some shipping options.

### Comparison with today's commodity prices

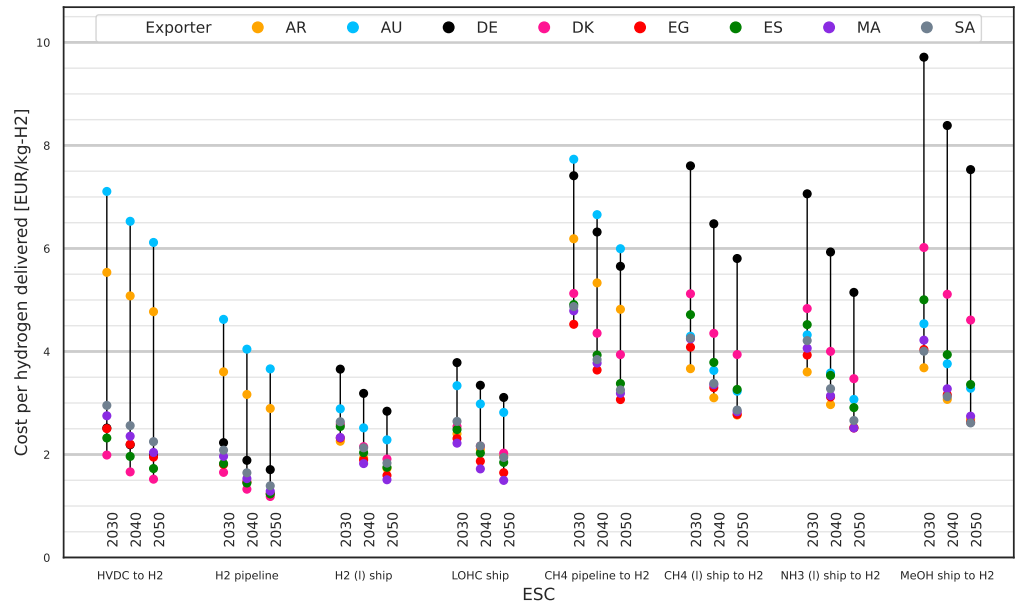
We evaluate the competitiveness of our ESCs by comparing the future cost scenarios against today's market prices for the fossil-based counterpart commodities. The comparison between market prices and costs is not strictly valid because it ignores price formation in markets, but it can give a useful indication for the economic attractiveness of the ESCs. Fig 11 shows commodity prices relative to the average and median LCoE under 2050 technology assumptions with 5% p.a. and 10% p.a. WACC.

In our results methanol becomes available starting at 360 EUR/t from SA which is around 50% above 2020 market prices but within the range of market prices from 2021 and later. The current market prices are also within the range of the median methanol cost, indicating at least four exporter options for methanol within that cost range. Under less favourable financing conditions, cost differences exceed 100% and even the highest historical market prices are well below the 600 EUR/t median for methanol at 10% p.a. WACC. The constellation is similar for imports of FT fuel which hit break-even with the European average Diesel 2022 market price under favourable WACC assumptions but are not attractive compared to 2021 and earlier market prices or under higher WACC.

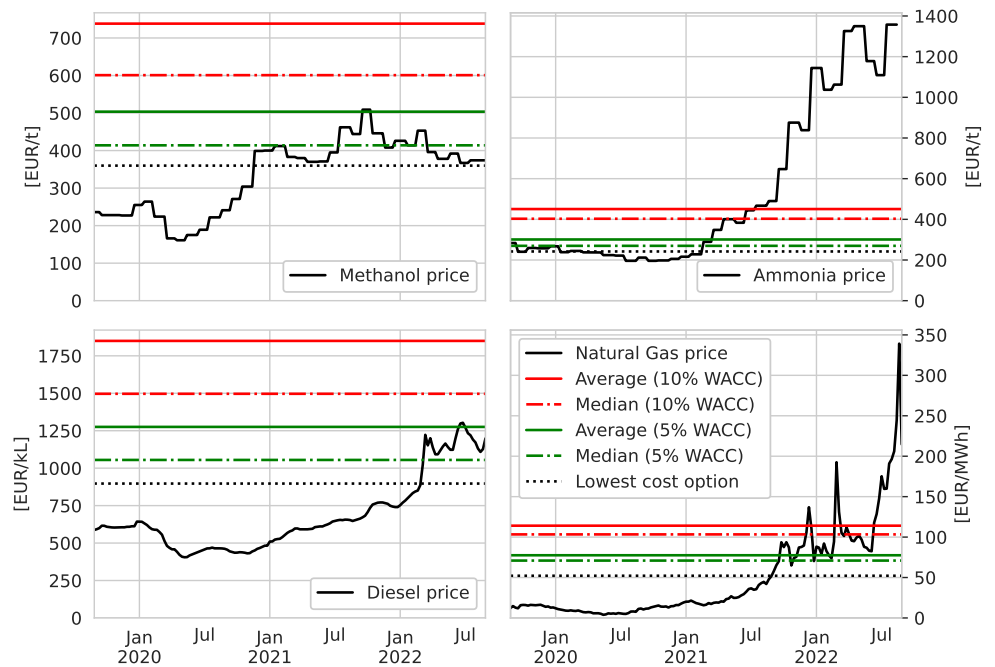
Market prices of ammonia and natural gas are strongly correlated with natural gas, it being the major cost-driving feedstock for today's ammonia production. Until the middle of 2021 prices for natural gas and ammonia were moderate and about 50%



**Fig 9. LCoE for 2030 to 2050 at a reduced WACC of 5 % p.a..** Lowering the WACC reduces LCoE by around 35 %.



**Fig 10. LCoH for 2030 to 2050 at a reduced WACC of 5 % p.a..** Lowering the WACC reduces LCoH by around 35 %.



**Fig 11. Comparison of market prices of current fossil-based commodities with modelled costs for synthetic ESC-based alternatives.** Market prices are for Methanol based on MMSA Europe Spot FOB [31], Ammonia based on German export prices for ammonia [54], Natural gas based on Dutch TTF C1 future [55], FT fuel based on EU Diesel prices without taxes [56]. Statistics for natural gas are based on the costs for the CH<sub>4</sub> pipeline and shipping CH<sub>4</sub> (l) ESCs. The median value thus represents four exporter options for FT fuel, ammonia and methanol. For methane the median value represents eight exporter options.

below the costs of the lowest cost option available from our ESCs. In the second half of 2021 market prices started to increase and reached up to ten-fold of previous levels during the energy crisis in Europe. In the long-term market prices in Europe for natural gas and therefore also for ammonia can be expected to stay well above pre-2021 levels as pipeline-based gas imports are substituted with LNG. At higher market prices our modelled import costs are within the cost range of being attractive. Even median import costs for the less favourable 10 % p.a. WACC scenario are below currently seen market prices.

The differences between costs and market prices can also be bridged through CO<sub>2</sub> prices on the direct emissions of fossil-based energy carriers, which may also make higher LCoE with unfavourable financing conditions (10 % p.a. WACC) more attractive. Bridging e.g. a cost difference of 500 EUR/kl for diesel/FT fuel would be equivalent to a CO<sub>2</sub> price of 187 EUR/tCO<sub>2</sub>. A difference of 100 EUR/t on methanol could be compensated by a CO<sub>2</sub> price of 73 EUR/tCO<sub>2</sub>. For natural gas a CO<sub>2</sub> price of 126 EUR/tCO<sub>2</sub> could cover a difference of 25 EUR/MWh<sub>LHV</sub> which is the difference seen between mid July 2021 spot market prices and median LCoE from our scenarios. Such CO<sub>2</sub> prices are realistic when compared to the estimated CO<sub>2</sub> emission prices for 2030 of 129 EUR/tCO<sub>2</sub> under stricter EU regulation [57] and are well within the range of the estimated social cost of carbon from CO<sub>2</sub> emissions in DE of 195 EUR/tCO<sub>2</sub> to 250 EUR/tCO<sub>2</sub> (2020 to 2050) [58].

This shows that under fast-track technology deployment that makes the 2050 cost projections appear earlier and under favourable financing conditions leading to low WACC, the differences in LCoE to the fossil chemical energy carrier alternatives could in some cases be overcome in the near future. It also shows the important role of enabling an environment of lower financing cost (WACC) to reduce the costs. Until the cost gap between synthetic RES-based and fossil energy carriers is closed, a purely cost-driven switch from fossil to synthetic fuels is improbable. Supporting policies, e.g. CO<sub>2</sub> prices and fuel quotas, or softer factors which incentivise change, e.g. adjusted customer preferences, exporter independence and diversification or business self-regulation following e.g. corporate social responsibility (CSR) or environmental social and corporate governance (ESG) criteria, will be required to drive the change.

## Discussion

### Limitations

The results we presented in this study are subject to a range of limitations. Some general limitations are due to the nature of the methods used while others arise from our model assumptions.

GIS-based analysis at low resolutions for determining RES potentials can over- or underestimate real potentials as it ignores local siting limitations below the resolution limit or not contained in the data input, e.g. terrain. The RES potentials and generation are likewise affected by using 2013 as representative weather year which disregards multi-year weather and climate change induced variations on RES generation and costs. By including exogenous technology development and learning for costs which use fixed projections for technology capacities being deployed in the future, we ignore the influence our ESCs capacities could have on world-wide learning and development. This limitation similarly extends to process efficiencies which are exogenously fixed and learning independent. For cost assumptions the validity and uncertainties cannot be assessed ex ante, a pitfall famously encountered by cost projections for RES technologies like PV which in hindsight were often too high [59]. Also some technologies might realise technological maturity faster or slower than others leading to earlier or later cost



decreases in some ESC thus influencing the time-horizon of the results presented. There could also be path dependencies where existing infrastructure influences the choice of ESCs, such as existing LNG terminals leading to an advantage for SNG imports. Lastly assuming identical WACC for all countries and ESCs increases comparability but is not realistic; WACCs are generally country- and project-specific. More specific to our model we conducted investment optimisation for greenfield conditions in an islanded system. This assumption may not be appropriate where significant infrastructure for reuse or co-use already exists. Such cases are to be expected e.g. for electrical transmission lines and pipeline systems in the EU. Integrating energy exports with existing systems rather than deploying islanded systems can open opportunities e.g. for reuse of existing heat sources at lower costs than sourcing of the energy from inside an ESC. Reuse of existing infrastructure and integration both would lower the costs along an ESC. A similar effect should be expected from integration of technologies along the ESCs, e.g. heat generated by electrolysis used for DAC, which was not considered either. Further we use simplified transport assumptions: Energy transport properties only scale by distance using representative average values which ignore e.g. topography, and we neglect shipping terminal costs. For forwarding electricity and chemicals between production locations and centralised facilities we assume copperplate-like transport without connection costs or losses on the exporter side and likewise for distribution systems on the importer side. On the demand side we presume an annual energy demand for domestic electricity as well as chemical energy carrier demand without specific demand pattern. This may cause unrealistically high amounts of low-cost, highly correlated electricity from PV to be used for domestic demand rather than some of its peak supply for the production of chemical energy carriers. The lack of demand pattern for the chemical energy carriers waives the need for short-term or long-term storage prior to end use where non-H<sub>2</sub> energy carriers may be better suited than any pure H<sub>2</sub> option. For the demand we further exclude differences in conversion efficiencies from energy carriers to energy services for better comparison. Potential competing demand by imports of other countries which may compete for the same ESCs is omitted as well as a to be expected increasing demand in DE exceeding 120 TWh. Aggregated demand may exceed available supply potential from some countries, e.g. DK, or regions, e.g. EU, cf. Fig 3. The decisions for transport, distribution and energy demand are expected to lead to an underestimation of LCoE. Another boost to LCoE can be expected as other nations start to import equally significant volumes of energy carriers, thus driving MCoEs in the supply curve and competition for best RES sites, unequally affecting LCoE from some exporters more, e.g. DK, than others, e.g. AU, AR. Attempting a generalisation for diverse distribution and end-use cases appears inadequate to us as it may lead to potentially misleading or easily misunderstood results. Instead we offer basic results on which further studies using sector or project specific parameters may be undertaken for which our results and model can act as a starting point.

In the broader picture we have considered imports to a single country, Germany, in our study. In reality there is to be expected a complex web of trade and competition between importing and exporting countries and individual actors. Our study is a first step into this direction.

### Comparison with other studies

Opportunities to compare our modelling results with other studies are limited to the various different system boundaries common in literature. [3] investigated import of FTD and SNG from the Maghreb region. For 2030 they arrived at 85.3 EUR/MWh<sub>LHV</sub> for FTD and for regasified SNG 98.8 EUR/MWh<sub>LHV</sub> assuming 5 % p.a. WACC without O<sub>2</sub> sale benefits. Compared to our results with 5 % p.a. (and 10 % p.a.) WACC for imports from Morocco (MA) in 2030, their costs are lower than ours reaching

147 EUR/MWh<sub>LHV</sub> (213 EUR/MWh<sub>LHV</sub>) for FT fuel and within a similar range for CH<sub>4</sub> (l) by ship at 82 EUR/MWh<sub>LHV</sub> (120 EUR/MWh<sub>LHV</sub>). Differences can be found in [3] assuming DAC CAPEX to be a third of what we assumed and use a lifetime of 30 years compared to 20 years. They also assumed 37% lower CAPEX for AE, low cost cavern hydrogen storage rather than steel tanks, higher AE efficiencies and made use of heat integration into their process. Fasihi et al. [60] estimated 2050 costs for local ammonia production to be 260 EUR/t<sub>NH<sub>3</sub></sub> to 300 EUR/t<sub>NH<sub>3</sub></sub> for the best sites including AR, AU and the WANA region. For ‘most habitable regions of the world’ they estimate costs of around 450 EUR/t<sub>NH<sub>3</sub></sub>. The costs we arrived at in our study covers a similar range with costs (excluding DE) between 242 EUR/t<sub>NH<sub>3</sub></sub> to 330 EUR/t<sub>NH<sub>3</sub></sub> for the optimistic WACC case of 5% p.a. and 360 EUR/t<sub>NH<sub>3</sub></sub> to 492 EUR/t<sub>NH<sub>3</sub></sub> for the conservative WACC of 10% p.a.. The main differences between the studies are the different assumptions on WACC with [60] assuming 7% p.a. and their significantly lower CAPEX assumptions for hydrogen and battery storage. In terms of RES system compositions the authors saw a PV dominated system with complementary onshore wind deployed, while we see in our study quite different combinations of PV, offshore and onshore wind being deployed depending on the exporter and ESC.

Results from Niermann et al. [61] for hydrogen imports from Algeria by HVDC, ship with H<sub>2</sub> (l) and the LOHC DBT show significantly higher import costs at 6% p.a. WACC when compared with our results for MA in 2030 with 5% p.a. WACC: They report 11.5 EUR/kg<sub>H<sub>2</sub></sub> for LOHC shipping (we: 2.2 EUR/kg<sub>H<sub>2</sub></sub>), 13.2 EUR/kg<sub>H<sub>2</sub></sub> for H<sub>2</sub> (l) shipping (we: 2.3 EUR/kg<sub>H<sub>2</sub></sub>) and 15.6 EUR/kg<sub>H<sub>2</sub></sub> for HVDC imports (we: 2.8 EUR/kg<sub>H<sub>2</sub></sub>) The stark cost difference is driven by their assumptions of a different electrolysis technology (PEM) with different technological parameters, fixed electricity costs of 50 EUR/MWh<sub>e1</sub> and inclusion of seasonal storage as well as distribution costs, i.e. assumptions which are expected to drive costs for pure hydrogen storage (gaseous or liquid) and investment costs for the LOHC chemical substantially.

Lastly compared to [15] we see comparably flat supply curves for regions with large RES potentials. The lowest costs for H<sub>2</sub> (l) exports from Patagonia (AR) seen by Heuser et al. [15] are at 3.06 EUR/kg<sub>H<sub>2</sub></sub> excluding shipping cost. The authors further estimate the shipping costs to add another 0.53 EUR/kg<sub>H<sub>2</sub></sub>. These results are significantly higher than our results for 2050 with 2.5 EUR/kg<sub>H<sub>2</sub></sub> and 1.7 EUR/kg<sub>H<sub>2</sub></sub> at 10% p.a. and 5% p.a. WACC respectively. The difference in cost can be partially attributed to the inclusion of the collection infrastructure on the exporter side necessary for transporting the energy carrier from the distributed points of production to the coast for exports.

Concluding the comparison with existing literature yields consistent results where comparison is possible within a broader range. Differences to literature can be tracked and explained based on significantly different technology, cost and model assumptions.

## Conclusion

In this paper we modelled large scale, islanded production and export of chemical energy carriers to Germany (DE) from Australia (AU), Argentina (AR), Denmark (DK), Egypt (EG), Spain (ES), Morocco (MA) and Saudi Arabia (SA). We compared these Energy Supply Chains (ESCs) with their equivalents for domestic production of chemical energy carriers in Germany. For the nine different ESCs we minimised greenfield investment costs to determine the Levelised Cost of Energy (LCoE) per MWh<sub>th</sub> of the specific chemical energy carriers as well as Levelised Cost of Hydrogen (LCoH) per kg<sub>H<sub>2</sub></sub> after dehydrogenation of the energy carriers. We determined and used local Renewable Energy Source (RES) potentials via GIS-analysis, considered the influence of local electricity demand on exporters’ supply curves and included the intermittency of RES sources via modelled hourly time-series.

In all investigated scenarios domestic sourcing of the individual chemical energy carriers in DE is among the most expensive options. Sourcing through ESCs from other countries is in almost all cases cheaper. Under conservative assumptions of 10 % p.a. WACC we find the lowest LCoE (LCoH) for 2030 to be 75 EUR/MWh<sub>LHV</sub> (2.5 EUR/kg<sub>H2</sub>) from DK by H<sub>2</sub> (g) pipeline. Under optimistic assumptions of 5 % p.a. WACC the costs reduce to 50 EUR/MWh<sub>LHV</sub> (1.7 EUR/kg<sub>H2</sub>). With technological development, costs further decrease by 2050 to 55 EUR/MWh<sub>LHV</sub> (10 % p.a. WACC) and 36 EUR/MWh<sub>LHV</sub> (5 % p.a. WACC). Other than Denmark, imports from Spain and Western Asia and Northern Africa by hydrogen pipeline are also attractive, e.g. at between 37 EUR/MWh<sub>LHV</sub> to 42 EUR/MWh<sub>LHV</sub> (2050, 5 % p.a. WACC). With optimistic 5 % p.a. WACC assumptions, import options for any to all of the investigated chemical energy carriers and from all exporters become available at cost of 100 EUR/MWh<sub>LHV</sub> or lower. Importing FT fuels by ship is the most expensive ESC with the largest cost range we investigated, with the costs ranging 90 EUR/MWh<sub>LHV</sub> to 256 EUR/MWh<sub>LHV</sub> under best assumptions (2050, 5 % p.a. WACC). The lowest cost options and exporters for importing energy are also the lowest cost options for imports of hydrogen. While better financing conditions and fast-track technology development lead to lower costs for imported energy and hydrogen, they do not lead to changes in the order of preference regarding technology and exporter if they affect all exporters and ESC similarly.

As a rule of thumb LCoE increase with the complexity and energy intensity of an ESC. Costs for RES are the major cost driver usually contributing 39 % to 55 % to the total cost of an ESC. Electrolysis costs play only a minor role with on average 5 % of the costs of an ESC. Costs for ESCs using ammonia, methane, methanol and FT fuels are additionally driven by the costs for synthesis and costs for hydrogen storage using above-ground steel tank, which is used to ensure feedstock availability for the inflexible synthesis processes.

Our findings support the notion that no best one-size-fits-all solution exists for chemical energy carrier imports. In fact no single exporter or ESC shows a unique techno-economic advantage over the others, leading to the conclusion that preference for one energy carrier, ESC and exporter should not be given solely based on small differences in LCoE and LCoH. This allows supply of energy carriers and feedstocks to be sourced from a diverse selection of countries, without affecting costs too strongly. For large volume imports of energy and pure hydrogen, imports by H<sub>2</sub> (g) pipeline or electricity by HVDC with domestic electrolysis are favourable. Alternatives incur only slightly higher costs. Our results support the notion that the choice of chemical energy carrier should be based on the requirements for end-use including short-term and long-term storage necessity, energy service conversion efficiency and distribution logistics rather than the cost alone. Accordingly future analysis of full ESCs could provide more insights by using specific demand assumptions and distinguishing between specific energy service or chemical needs. Such analysis could further include local production (captive) scenarios compared to our nation-level analysis. Finally, qualities of ESCs like reliability of supply, long-term cost predictability, local value chains and employment generation, which are generally not represented by the investment costs, need to be investigated and considered.

To overcome the limitations of this study and increase insight into energy imports, future research should focus on differentiating WACC based on exporter and technologies, include spatially resolved RES and collection infrastructure, include additional relevant energy carriers and ESC designs like CO<sub>2</sub>-cycling and import of secondary, energy-intense products like refined-iron or other valuable hydrocarbons and investigate sensitivities of results also to technical aspects like process flexibilities and synthesis must-run conditions.

## Acknowledgements

We thank Niclas Mattsson of Chalmers University of Technology, Sweden, for the valuable exchange and help with GlobalEnergyGIS (GEGIS). We also like to express our gratitude to Herib Blanco and the anonymous reviewer, for their time and effort in reviewing our manuscript and providing us with very valuable and helpful comments and suggestions.

## Acronyms

**AE** alkaline electrolysis.

**AR** Argentina.

**ASU** air separation unit.

**AU** Australia.

**CAPEX** Capital Expenditures.

**CC** carbon capture.

**CF** Capacity Factor.

**DAC** Direct Air Capture.

**DBT** dibenzyltoluene.

**DE** Germany.

**DK** Denmark.

**EAC** Equivalent Annual Cost.

**EG** Egypt.

**ES** Spain.

**ESC** Energy Supply Chain.

**ESF** energy surplus factor.

**EU** European Union.

**FOM** Fixed Operation & Maintenance.

**FT fuel** Fischer-Tropsch fuel.

**FTD** Fischer-Tropsch-Diesel.

**GDP** gross domestic product.

**GEGIS** GlobalEnergyGIS.

**GIS** geographic information system.

**GWA** Global Wind Atlas.

**GWP** global warming potential.

**HVDC** High-Voltage Direct Current.

**IRENA** International Renewable Energy Agency.

**LCoE** Levelised Cost of Energy.

**LCoH** Levelised Cost of Hydrogen.

**LHV** Lower Heating Value.

**LNG** liquefied natural gas.

**LOHC** Liquid Organic Hydrogen Carrier.

**MA** Morocco.

**MCoE** Marginal Cost of Energy.

**MSR** methanol steam reforming.

**OECD** Organisation for Economic Co-operation and Development.

**PEM** proton exchange membrane.

**PV** photovoltaics.

**RES** Renewable Energy Source.

**SA** Saudi Arabia.

**SMR** steam methane reforming.

**SNG** synthetic natural gas.

**USA** United States of America.

**WACC** Weighted Average Cost of Capital.

**WANA** Western Asia and Northern Africa.

## References

1. AG Energiebilanzen e V . Energieflussbild 2018 Für Die Bundesrepublik Deutschland; 2020. Available from:  
[https://ag-energiebilanzen.de/index.php?article\\_id=29&fileName=ageb\\_energieflussbild-kurz\\_de-2018-pj\\_20190909.pdf](https://ag-energiebilanzen.de/index.php?article_id=29&fileName=ageb_energieflussbild-kurz_de-2018-pj_20190909.pdf).
2. Fasihi M, Breyer C. Baseload Electricity and Hydrogen Supply Based on Hybrid PV-wind Power Plants. *Journal of Cleaner Production*. 2020;243:118466. doi:10.1016/j.jclepro.2019.118466.

3. Fasihi M, Bogdanov D, Breyer C. Long-Term Hydrocarbon Trade Options for the Maghreb Region and Europe—Renewable Energy Based Synthetic Fuels for a Net Zero Emissions World. *Sustainability*. 2017;9(2):306. doi:10.3390/su9020306.
4. Watanabe T, Murata K, Kamiya S, Ota KI. Cost Estimation of Transported Hydrogen, Produced by Overseas Wind Power Generations. In: Detlef Stolten, Thomas Grube, editors. *Proceedings of the WHEC*. vol. 78–3 of *Schriften Des Forschungszentrums Jülich Reihe Energie & Umwelt*. Jülich: Forschungszentrum Jülich (IEF-3); 2010. p. 547–557.
5. Heuser PM, Ryberg DS, Grube T, Robinius M, Stolten D. Techno-Economic Analysis of a Potential Energy Trading Link between Patagonia and Japan Based on CO<sub>2</sub> Free Hydrogen. *International Journal of Hydrogen Energy*. 2019;44(25):12733–12747. doi:10.1016/j.ijhydene.2018.12.156.
6. Ishimoto Y, Voldsund M, Neksa P, Roussanaly S, Berstad D, Gardarsdottir SO. Large-Scale Production and Transport of Hydrogen from Norway to Europe and Japan: Value Chain Analysis and Comparison of Liquid Hydrogen and Ammonia as Energy Carriers. *International Journal of Hydrogen Energy*. 2020;45(58):32865–32883. doi:10.1016/j.ijhydene.2020.09.017.
7. Lanphen S. Hydrogen Import Terminal; 2019. Available from: <https://repository.tudelft.nl/islandora/object/uuid%3Ad2429b05-1881-4e42-9bb3-ed604bc15255>.
8. Niermann M, Drünert S, Kaltschmitt M, Bonhoff K. Liquid Organic Hydrogen Carriers (LOHCs) – Techno-Economic Analysis of LOHCs in a Defined Process Chain. *Energy & Environmental Science*. 2019;12(1):290–307. doi:10.1039/C8EE02700E.
9. Schorn F, Breuer JL, Samsun RC, Schnorbus T, Heuser B, Peters R, et al. Methanol as a Renewable Energy Carrier: An Assessment of Production and Transportation Costs for Selected Global Locations. *Advances in Applied Energy*. 2021;3:100050. doi:10.1016/j.adapen.2021.100050.
10. Brändle G, Schönfisch M, Schulte S. Estimating Long-Term Global Supply Costs for Low-Carbon Hydrogen. *Applied Energy*. 2021;302:117481. doi:10.1016/j.apenergy.2021.117481.
11. Johnston C, Ali Khan MH, Amal R, Daiyan R, MacGill I. Shipping the Sunshine: An Open-Source Model for Costing Renewable Hydrogen Transport from Australia. *International Journal of Hydrogen Energy*. 2022;47(47):20362–20377. doi:10.1016/j.ijhydene.2022.04.156.
12. Pfennig M, Böttger D, Häckner B, Geiger D, Zink C, Bisevic A, et al.. Global GIS-based Potential Analysis and Cost Assessment of Power-to-X Fuels in 2050; 2022. Available from: <http://arxiv.org/abs/2208.14887>.
13. Staiß F, Adolf J, Ausfelder F, Erdmann C, Hebling C, Jordan T, et al. Optionen für den Import grünen Wasserstoffs nach Deutschland bis zum Jahr 2030. *acatech - Deutsche Akademie der Technikwissenschaften*; 2022. Available from: <https://energiesysteme-zukunft.de/publikationen/analyse/transportoptionen-wasserstoff-2030>.
14. Runge P, Sölch C, Albert J, Wasserscheid P, Zöttl G, Grimm V. Economic Comparison of Electric Fuels Produced at Excellent Locations for Renewable Energies: A Scenario for 2035; 2020. Available from: <https://papers.ssrn.com/abstract=3623514>.

15. Heuser PM, Grube T, Heinrichs H, Robinius M, Stolten D. Worldwide Hydrogen Provision Scheme Based on Renewable Energy; 2020. Available from: <https://www.preprints.org/manuscript/202002.0100/v1>.
16. IRENA. Global Hydrogen Trade to Meet the 1.5°C Climate Goal: Trade Outlook for 2050 and Way Forward; 2022. Available from: <https://www.irena.org/publications/2022/Jul/Global-Hydrogen-Trade-Outlook>.
17. Dmitry Podluzny. Tankers; 2016. Available from: <https://thenounproject.com/search/?q=tanker&i=429161>.
18. Yushchenko A. Chemicals; 2019. Available from: <https://thenounproject.com/search/?q=chemical&i=2757758>.
19. Oliver Guin, FR. Transmission Tower; 2012. Available from: <https://thenounproject.com/search/?q=Transmission+line&i=4747>.
20. Viral faisalovers. Heat; 2018. Available from: <https://thenounproject.com/icon/heat-2090492/>.
21. Iconika. Pipeline; 2018. Available from: <https://thenounproject.com/search/?q=pipeline&i=1612436>.
22. Wikipedia contributors. Heat of Combustion; 2020. Available from: [https://en.wikipedia.org/w/index.php?title=Heat\\_of\\_combustion&oldid=984838958](https://en.wikipedia.org/w/index.php?title=Heat_of_combustion&oldid=984838958).
23. Brown T, Hörsch J, Schlachtberger D. PyPSA: Python for Power System Analysis. *Journal of Open Research Software*. 2018;6(1). doi:10.5334/jors.188.
24. IRENA. Green Hydrogen Cost Reduction; 2020. Available from: <https://www.irena.org/publications/2020/Dec/Green-hydrogen-cost-reduction>.
25. Danish Energy Agency, Energinet. Technology Data for Renewable Fuels (04/2021); 2021. Available from: [https://ens.dk/sites/ens.dk/files/Analyser/technology\\_data\\_for\\_renewable\\_fuels.pdf](https://ens.dk/sites/ens.dk/files/Analyser/technology_data_for_renewable_fuels.pdf).
26. Götz M, Lefebvre J, Mörs F, McDaniel Koch A, Graf F, Bajohr S, et al. Renewable Power-to-Gas: A Technological and Economic Review. *Renewable Energy*. 2016;85:1371–1390. doi:10.1016/j.renene.2015.07.066.
27. IRENA. Global Hydrogen Trade to Meet the 1.5°C Climate Goal: Technology Review of Hydrogen Carriers; 2022. Available from: <https://www.irena.org/publications/2022/Apr/Global-hydrogen-trade-Part-II>.
28. MacFarlane DR, Cherepanov PV, Choi J, Suryanto BHR, Hodgetts RY, Bakker JM, et al. A Roadmap to the Ammonia Economy. *Joule*. 2020;4(6):1186–1205. doi:10.1016/j.joule.2020.04.004.
29. ENGIE, Siemens, Ecuity Consulting, UK's Science & Technology Facilities Council. Ammonia to Green Hydrogen Project: Feasibility Study; 2020. Available from: [https://assets.publishing.service.gov.uk/government/uploads/system/uploads/attachment\\_data/file/880826/HS420\\_-\\_Ecuity\\_-\\_Ammonia\\_to\\_Green\\_Hydrogen.pdf](https://assets.publishing.service.gov.uk/government/uploads/system/uploads/attachment_data/file/880826/HS420_-_Ecuity_-_Ammonia_to_Green_Hydrogen.pdf).
30. Bazzanella AM, Ausfelder F, DECHEMA Gesellschaft für Chemische Technik und Biotechnologie e V . Low carbon energy and feedstock for the European chemical industry: Technology study; 2017. Available from: <http://www.dechema.de/>.

31. Methanol Institute. Methanol Price and Supply/Demand; 2022. Available from: <https://www.methanol.org/methanol-price-supply-demand/>.
32. Dolan G. Overview of Global Methanol Fuel Blending; 2019. Available from: <https://www.methanol.org/wp-content/uploads/2019/01/Dolan-TT-Methanol-Fuel-Blending-Workshop-24-Jan-2018.pdf>.
33. IRENA, Methanol Institute. Innovation Outlook: Renewable Methanol; 2021. Available from: [https://www.methanol.org/wp-content/uploads/2020/04/IRENA\\_Innovation\\_Renewable\\_Methanol\\_2021.pdf](https://www.methanol.org/wp-content/uploads/2020/04/IRENA_Innovation_Renewable_Methanol_2021.pdf).
34. Caloric Anlagenbau GmbH. Hydrogen by Methanol Reforming; 2020. Available from: <https://www.caloric.com/en/product/hydrogen-generation/hydrogen-by-methanol-reforming/>.
35. König DH, Baucks N, Dietrich RU, Wörner A. Simulation and Evaluation of a Process Concept for the Generation of Synthetic Fuel from CO<sub>2</sub> and H<sub>2</sub>. *Energy*. 2015;91:833–841. doi:10.1016/j.energy.2015.08.099.
36. Bundesministerium für Wirtschaft und Energie. Die Nationale Wasserstoffstrategie; 2020. Available from: <https://www.bmwi.de/Redaktion/DE/Publikationen/Energie/die-nationale-wasserstoffstrategie.html>.
37. SeaRates. Distances & Time; 2020. Available from: <https://www.searates.com/en/services/distances-time/>.
38. Google. Countries.Csv | Dataset Publishing Language; 2012. Available from: [https://developers.google.com/public-data/docs/canonical/countries\\_csv](https://developers.google.com/public-data/docs/canonical/countries_csv).
39. Timmerberg S, Kaltschmitt M. Hydrogen from Renewables: Supply from North Africa to Central Europe as Blend in Existing Pipelines – Potentials and Costs. *Applied Energy*. 2019;237:795–809. doi:10.1016/j.apenergy.2019.01.030.
40. Mattsson N, Verendel V, Hedenus F, Reichenberg L. An Autopilot for Energy Models – Automatic Generation of Renewable Supply Curves, Hourly Capacity Factors and Hourly Synthetic Electricity Demand for Arbitrary World Regions. *Energy Strategy Reviews*. 2021;33:100606. doi:10.1016/j.esr.2020.100606.
41. Hörsch J, Hofmann F, Schlachtberger D, Brown T. PyPSA-Eur: An Open Optimisation Model of the European Transmission System. *Energy Strategy Reviews*. 2018;22:207–215. doi:10.1016/j.esr.2018.08.012.
42. Deutsche WindGuard GmbH. Capacity Densities of European Offshore Wind Farms; 2018. Available from: [https://vasab.org/wp-content/uploads/2018/06/BalticLINES\\_CapacityDensityStudy\\_June2018-1.pdf](https://vasab.org/wp-content/uploads/2018/06/BalticLINES_CapacityDensityStudy_June2018-1.pdf).
43. Danish Energy Agency, Energinet. Technology Data: Generation of Electricity and District Heating (04/2020); 2020. Available from: [https://ens.dk/sites/ens.dk/files/Statistik/technology\\_data\\_catalogue\\_for\\_el\\_and\\_dh\\_-\\_0009.pdf](https://ens.dk/sites/ens.dk/files/Statistik/technology_data_catalogue_for_el_and_dh_-_0009.pdf).
44. Riahi K, van Vuuren DP, Kriegler E, Edmonds J, O’Neill BC, Fujimori S, et al. The Shared Socioeconomic Pathways and Their Energy, Land Use, and Greenhouse Gas Emissions Implications: An Overview. *Global Environmental Change*. 2017;42:153–168. doi:10.1016/j.gloenvcha.2016.05.009.



45. U S Energy Information Administration (EIA). International Data: Electricity Consumption by Country; 2018. Available from: <https://www.eia.gov/international/data/world/electricity/electricity-consumption>.
46. Schyska BU, Kies A. How Regional Differences in Cost of Capital Influence the Optimal Design of Power Systems. *Applied Energy*. 2020;262:114523. doi:10.1016/j.apenergy.2020.114523.
47. Egli F, Steffen B, Schmidt TS. Bias in Energy System Models with Uniform Cost of Capital Assumption. *Nature Communications*. 2019;10(1):4588. doi:10.1038/s41467-019-12468-z.
48. IRENA. Renewable Power Generation Costs in 2019. Abu Dhabi: International Renewable Energy Agency; 2020. Available from: <https://www.irena.org/publications/2020/Jun/Renewable-Power-Costs-in-2019>.
49. Steffen B. Estimating the Cost of Capital for Renewable Energy Projects. *Energy Economics*. 2020;88:104783. doi:10.1016/j.eneco.2020.104783.
50. Mölder F, Jablonski KP, Letcher B, Hall MB, Tomkins-Tinch CH, Sochat V, et al. Sustainable Data Analysis with Snakemake. *F1000Research*. 2021;10:33. doi:10.12688/f1000research.29032.1.
51. Chen C, Yang A. Power-to-Methanol: The Role of Process Flexibility in the Integration of Variable Renewable Energy into Chemical Production. *Energy Conversion and Management*. 2021;228:113673. doi:10.1016/j.enconman.2020.113673.
52. IRENA. Renewable Power Generation Costs in 2020; 2021. Available from: <https://www.irena.org/publications/2021/Jun/Renewable-Power-Costs-in-2020>.
53. IEA. The Cost of Capital in Clean Energy Transitions – Analysis; 2021. Available from: <https://www.iea.org/articles/the-cost-of-capital-in-clean-energy-transitions>.
54. Statistisches Bundesamt. 51000-0006: Aus- und Einfuhr (Außenhandel): Deutschland, Monate, Warensystematik; 2022. Available from: <https://www-genesis.destatis.de/genesis/online?operation=table&code=51000-0006&bypass=true&levelindex=0&levelid=1667074103053#abreadcrumb>.
55. Investing.com. ICE Dutch TTF Natural Gas Futures Historical Prices; 2022. Available from: <https://www.investing.com/commodities/ice-dutch-ttf-gas-c1-futures-historical-data>.
56. European Commission. Weekly Oil Bulletin: Price Developments 2005 Onwards; 2022. Available from: [https://energy.ec.europa.eu/data-and-analysis/weekly-oil-bulletin\\_en](https://energy.ec.europa.eu/data-and-analysis/weekly-oil-bulletin_en).
57. Pietzcker RC, Osorio S, Rodrigues R. Tightening EU ETS Targets in Line with the European Green Deal: Impacts on the Decarbonization of the EU Power Sector. *Applied Energy*. 2021;293:116914. doi:10.1016/j.apenergy.2021.116914.
58. Astrid Matthey, Björn Büniger. Kostensätze: Methodenkonvention 3.1 Zur Ermittlung von Umweltkosten. Dessau: Umweltbundesamt; 2020. Available from: [https://www.umweltbundesamt.de/sites/default/files/medien/1410/publikationen/2020-12-21\\_methodenkonvention\\_3\\_1\\_kostensaetze.pdf](https://www.umweltbundesamt.de/sites/default/files/medien/1410/publikationen/2020-12-21_methodenkonvention_3_1_kostensaetze.pdf).

59. Victoria M, Haegel N, Peters IM, Sinton R, Jäger-Waldau A, del Cañizo C, et al. Solar Photovoltaics Is Ready to Power a Sustainable Future. *Joule*. 2021;doi:10.1016/j.joule.2021.03.005.
60. Fasihi M, Weiss R, Savolainen J, Breyer C. Global Potential of Green Ammonia Based on Hybrid PV-wind Power Plants. *Applied Energy*. 2021; p. 116170. doi:10.1016/j.apenergy.2020.116170.
61. Niermann M, Timmerberg S, Drünert S, Kaltschmitt M. Liquid Organic Hydrogen Carriers and Alternatives for International Transport of Renewable Hydrogen. *Renewable and Sustainable Energy Reviews*. 2021;135:110171. doi:10.1016/j.rser.2020.110171.

## Supporting information

- S 1 Appendix. ESF, LCoE and curtailment**
- S 2 Appendix. Technical model structure**
- S 3 Appendix. Model equations**
- S 4 Figs. Energy Supply Chains visualisations**
- S 5 Figs. Electricity generation mix and supply curves**
- S 6 Figs. Cost composition for other years, lower WACC**
- S 7 Table. Tabular results: Levelised Cost of Energy**
- S 8 Table. Tabular results: Levelised Cost of Hydrogen**
- S 9 Table. Technology assumptions**
- S 10 Table. Conversion efficiencies**
- S 11 Table. Shipping parameters**
- S 12 Figs. RES eligible area masks**
- S 13 Appendix. Data and code availability**

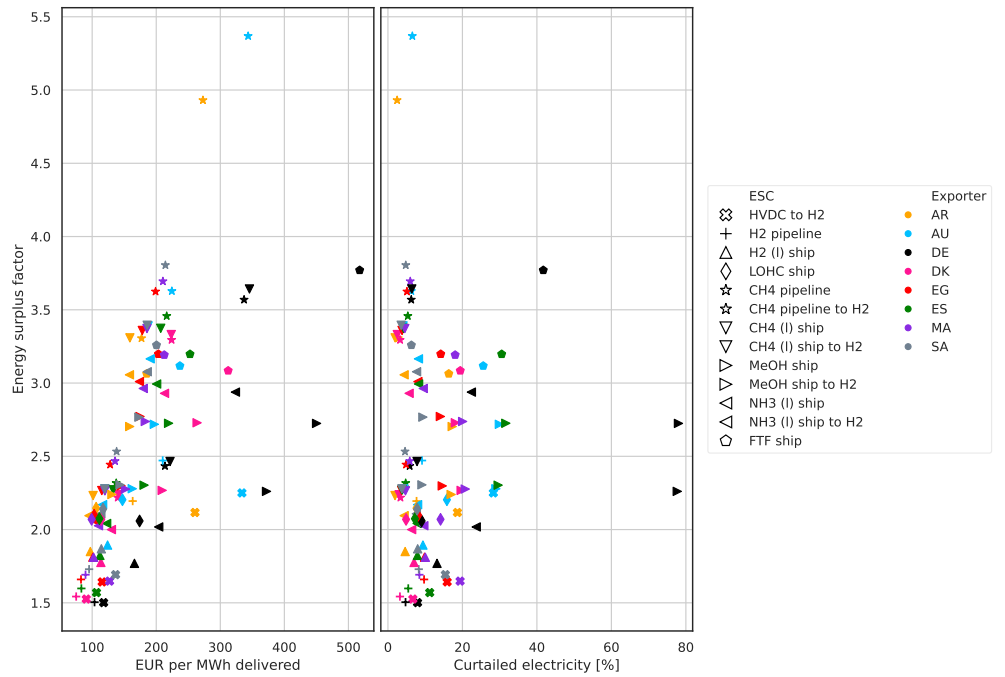
## S 1 Appendix ESF, LCoE and curtailment

Additional characteristics of the ESCs can become apparent by looking into the energy required for each ESC for synthesis, conversion and transport. We use the energy surplus factor (ESF) (Input electricity required per unit of energy delivered) instead of the energy efficiency (Share of energy delivered per unit of electricity generated) for this purpose. In Fig 12 the ESFs are shown on the left versus the LCoE for each ESC and exporter.

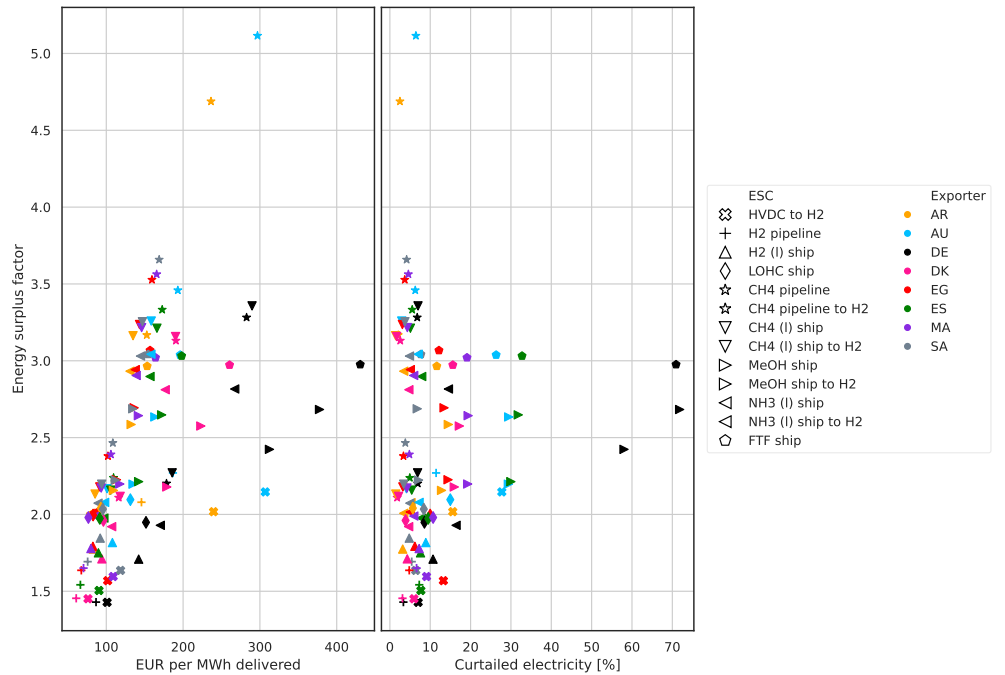
The ESFs for imports range from 1.4 ( $\text{H}_2$  (g) pipeline and HVDC with subsequent electrolysis) to 5.4 ( $\text{CH}_4$  (g) pipeline to  $\text{H}_2$  from AU). The simpler and lower cost ESCs using HVDC and hydrogen pipelines have as a rule of thumb lower ESFs. The majority of shipping options are between 100 EUR/ $\text{MWh}_{\text{th}}$  to 200 EUR/ $\text{MWh}_{\text{th}}$  at ESFs ranging from 1.8 to 3.8. FT fuel ship-based imports are clustered around an ESF of 3.2. Notable outliers are the domestic production of methanol and FT fuel in DE which we will discuss further below. Comparing the ESFs can provide insight into the necessary of RES capacities and thus e.g. land requirements involved between different ESCs.

The right side of Fig 12 shows the ESFs versus the share of electricity curtailed. Curtailment in islanded system as in our scenarios may only be avoided with investments into storage capacities or increasing the flexibility of involved synthesis processes ( $\text{CH}_4$ ,  $\text{NH}_3$ , methanol and FT fuel). We find a wide range of curtailment levels with the majority being below 20% and no apparent correlation with ESCs and exporter.

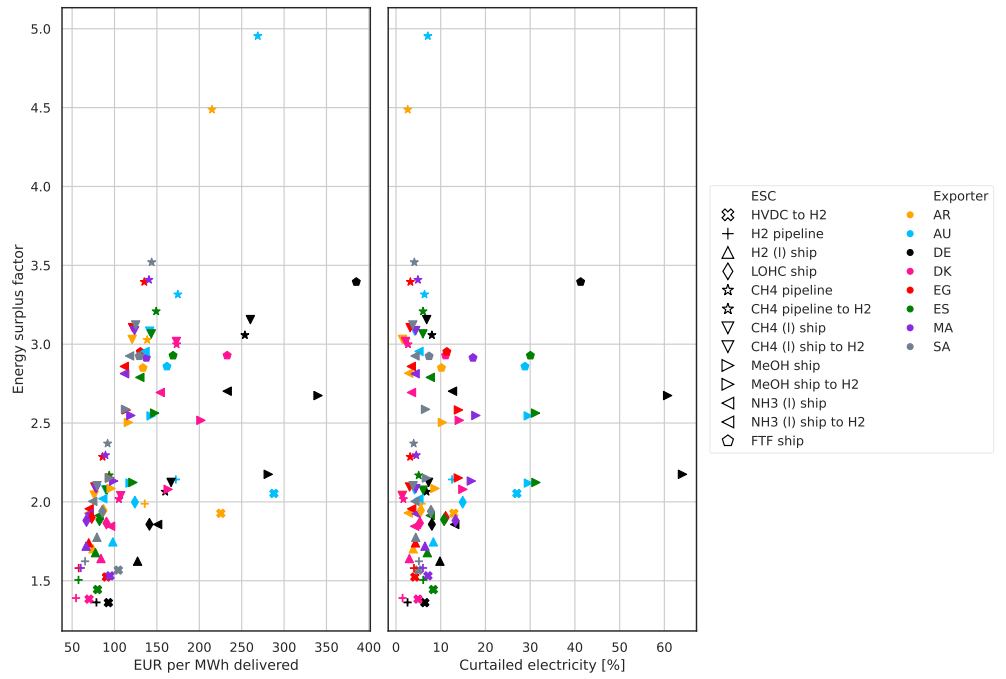
Looking at the curtailment we again find the ESCs for methanol, methanol to  $\text{H}_2$  and FT fuel with domestic production in DE as outliers. Closer inspection of these ESCs links the high curtailment rate to the available RES potentials for DE where, after domestic electricity demand was given priority in the supply curve, only onshore and offshore wind remain as RES and no PV is available to the ESCs. The high temporal correlation of the wind quality classes cause in combination with the inflexible synthesis processes for these chemical energy carriers the need to deploy high volumes of feedstock storage ( $\text{H}_2$  and  $\text{CO}_2$ ) as well as electrolysis capacities with low CF to be build. This in turn causes the investment costs and therefore LCoE to increase dramatically and significant curtailment on days of high wind speeds. This issue does not appear with any other exporter, as all other exporters have some PV potentials available, see S 5 Figs.



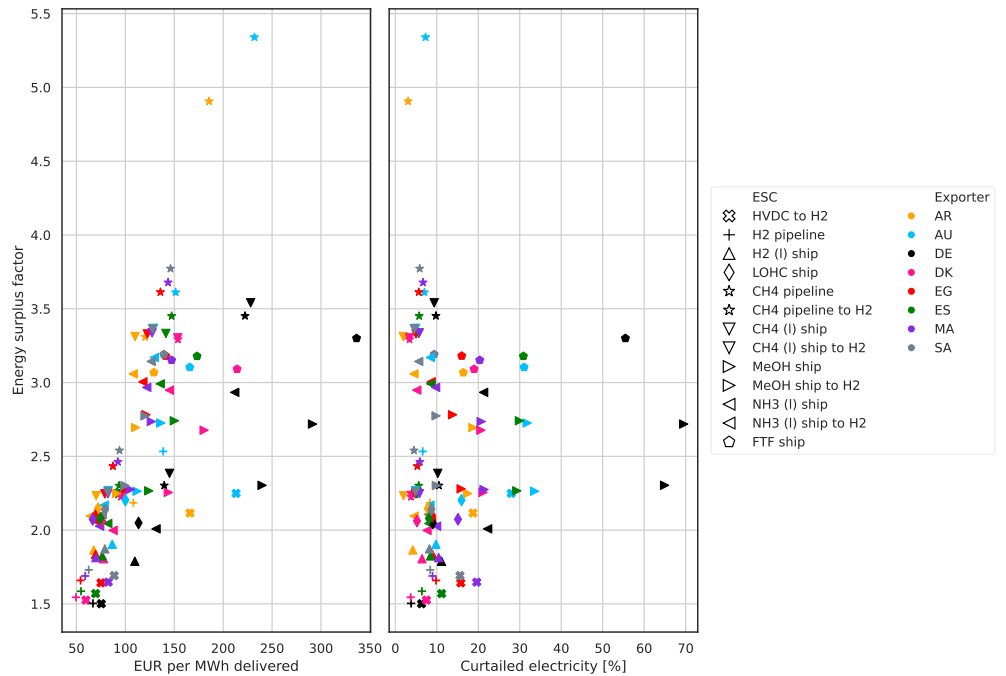
**Fig 12. ESFs for ESCs and exporters displayed against LCoE (left) and electricity curtailment (right). Values shown are for 2030 and 10 % p.a. WACC scenarios. Simplicity (lower ESF) and costs of ESCs increase to some extent together while curtailment varies greatly between exporter and ESC driven by the available RES, inflexibility of synthesis processes and storage deployment.**



**Fig 13. ESFs vs. LCoE and electricity curtailment for 2040 and 10 % p.a. WACC scenarios.**



**Fig 14. ESFs vs. LCoE and electricity curtailment for 2050 and 10 % p.a. WACC scenarios.**



**Fig 15. ESFs vs. LCoE and electricity curtailment for 2030 and 5 % p.a. WACC scenarios.**

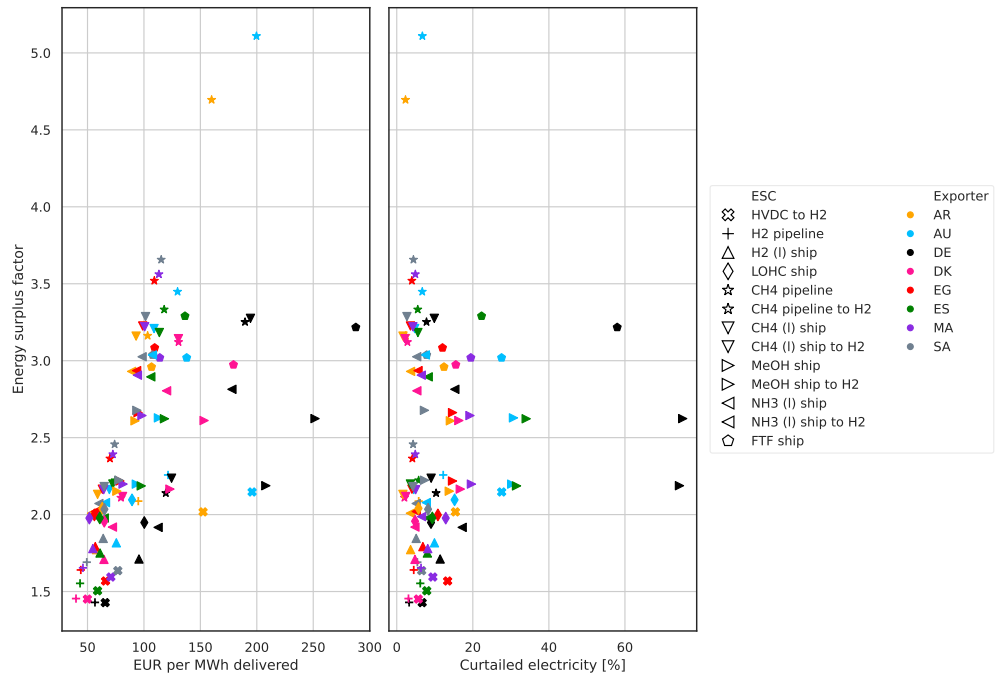


Fig 16. ESFs vs. LCoE and electricity curtailment for 2040 and 5 % p.a. WACC scenarios.

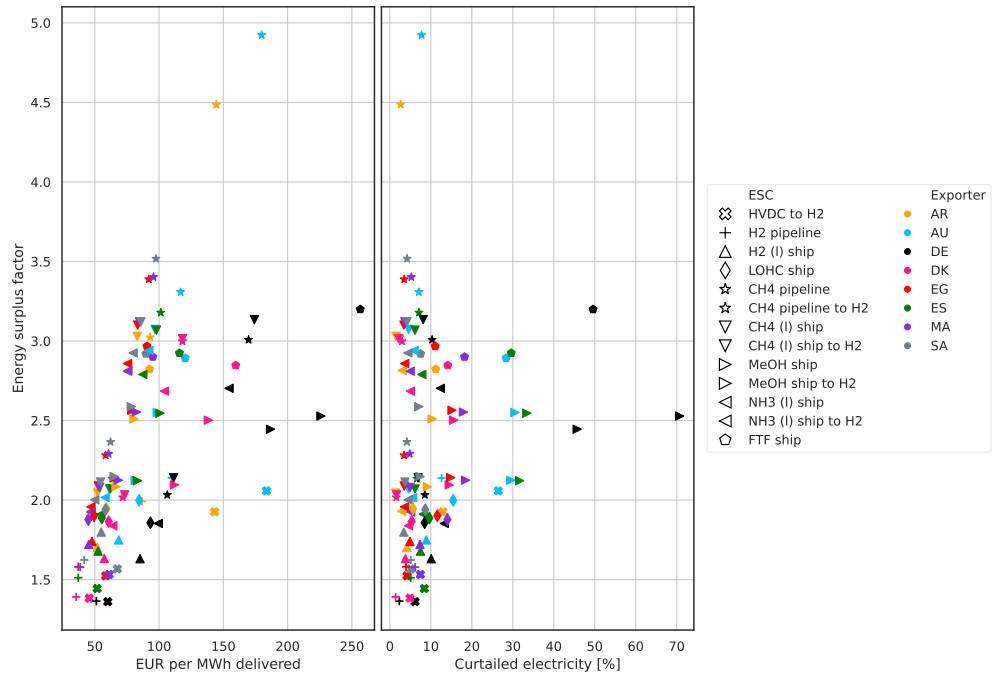
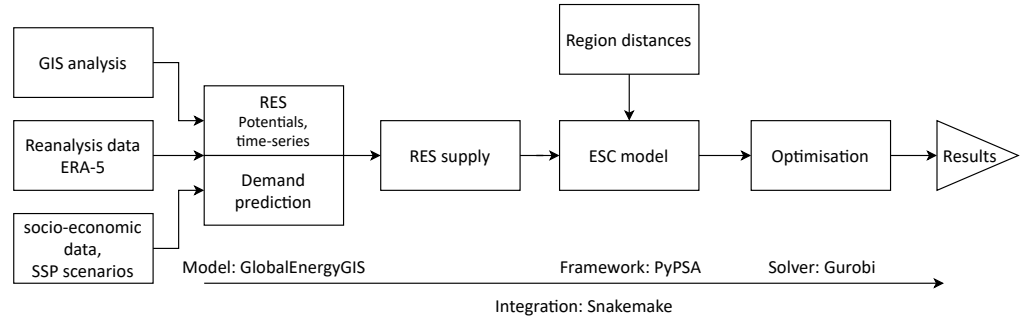


Fig 17. ESFs vs. LCoE and electricity curtailment for 2050 and 5 % p.a. WACC scenarios.

## S 2 Appendix Technical model structure



**Fig 18.** Model structure, underlying workflow and software used for this study.

### S 3 Appendix Model equations

The underlying model equations for each scenario are constructed through the open source framework PyPSA. PyPSA is a framework for building power and energy system models for running capacity expansion optimisation among other features. A detailed description of the mathematical background can be found in [1] and in the online documentation at [pypsa.readthedocs.io](http://pypsa.readthedocs.io).

PyPSA models are built using elemental components, such as generators, links, loads, stores and buses. Buses are the fundamental nodes to which all other components attach. In this study buses represent intermediary steps in the conversion between materials and energy carriers and different locations during the transport of materials or energy. Each bus is associated with one specific type of energy or material. Energy and materials enter a model through generators or links with efficiencies  $\eta > 1$ . Links connect different buses and represent in this study conversion steps or the transport of materials or energy. Each link's inflows and outflows are linked to individual efficiencies. Loads represents sinks for energy and materials where they are consumed, i.e. they leave a model.

From the interconnected components PyPSA generates a network (graph) model for which then energy and material flows are conserved [1], i.e. for at each bus  $n$  for each timestep  $t$

$$\sum_r g_{n,r,t} + \sum_s h_{n,s,t} + \sum_l \alpha_{l,n,t} f_{l,t} = d_{n,t} \quad \forall i, t \quad (9)$$

where  $g_{n,r,t}$  is the inflow from generator  $r$  at bus  $n$  at timestep  $t$ ,  $h_{n,s,t}$  is the flow from or into store  $s$  attached to bus  $n$  at timestep  $t$ ,  $f_{l,t}$  incoming or outgoing flows through link  $l$ ,  $\alpha_{l,n,t}$  the incidence matrix and  $d_{i,t}$  the outflow through loads attached to the bus. The incidence matrix takes on the values

$$\alpha_{l,n,t} = \begin{cases} -1 & \text{if } l \text{ starts at } n \\ \eta_{l,n,t} & \text{if } l \text{ ends at } n \end{cases} \quad (10)$$

with  $\eta_{l,n,t}$  being the specific efficiency for the link  $t$  ending in  $n$ .

The pipeline efficiency  $\eta^{\text{pipe}}$  is determined from the pipeline efficiency per 1000 km  $\eta_0^{\text{pipe}}$  (losses and energy consumption for pressure boosting compressors) and the pipeline length  $d$  in [km]

$$\eta^{\text{pipe}} = 1 - \eta_0^{\text{pipe}} \frac{d^{\text{pipe}}}{1000} \quad (11)$$

The efficiencies for HVDC connections are calculated analogously.

The shipping efficiency  $\eta^{\text{ship}}$  is determined by the boil-off and the propulsion energy demand as ships are assumed to use their cargoed energy carrier also as propulsion fuel. The lower efficiency, i.e. higher losses due to propulsion or boil off, are used as total efficiency. The total propulsion energy demand for outbound and return journey is determined by the shipping distance  $d^{\text{ship}}$  in [km], the ship's specific energy demand  $e$  in [MW h/km] and the ship's total cargo capacity  $c$  in [MW h].

Boil-off is only considered for the outbound journey as we assume the absolute boil-off during the return journey with near empty cargo hold to be minimal. The boil-off for the outbound journey is determined by the specific boil-off rate  $b^{\text{ship}}$  in [%/h] and the adjusted outbound journey travel time  $t_{\text{outbound, adjusted}}^{\text{ship}}$  in [h].

The total shipping efficiency is thus calculated as

$$\eta^{\text{ship}} = \min \left\{ 1 - 2d^{\text{ship}} \cdot \frac{e}{c}, (1 - b^{\text{ship}})^{t_{\text{outbound, adjusted}}^{\text{ship}}} \right\} \quad (12)$$



The outbound journey travel time  $t_{\text{outbound}}^{\text{ship}}$  is determined by the ship's average speed  $v^{\text{ship}}$  and shipping distance  $d^{\text{ship}}$

$$t_{\text{outbound}}^{\text{ship}} = \frac{d^{\text{ship}}}{v^{\text{ship}}} \quad (13)$$

The round-trip time for shipping is further affected by the time required for loading and unloading the ship  $t_{(\text{un-})\text{loading}}^{\text{ship}}$

$$t_{\text{round-trip}}^{\text{ship}} = 2t_{\text{outbound}}^{\text{ship}} + 2t_{(\text{un-})\text{loading}}^{\text{ship}} \quad (14)$$

The adjusted outbound journey time  $t_{\text{outbound, adjusted}}^{\text{ship}}$  is then determined by stretching the round-trip journey time. Stretching the journey time keeps the number of trips per year the same while reducing the number of hours a ship is not engaged in transporting cargo to a minimum.

$$t_{\text{outbound, adjusted}}^{\text{ship}} = t_{\text{outbound}}^{\text{ship}} + \text{round} \left( \frac{1}{2} \left[ \frac{t_{\text{gap}}^{\text{ship}}}{n_{\text{journeys}}^{\text{ship}}} \right] \right) \quad (15)$$

Here  $\text{round}(\dots)$  is rounding to the next integer,

$$t_{\text{gap}}^{\text{ship}} = 8760 \text{ h} \cdot \text{mod } t_{\text{round-trip}}^{\text{ship}} \quad (16)$$

the time a ship would be idle per year (8760 h) if the travel time was not adjusted and

$$n_{\text{journeys}}^{\text{ship}} = \left\lceil \frac{8760 \text{ h}}{t_{\text{round-trip}}^{\text{ship}}} \right\rceil \quad (17)$$

the number of journeys a ship can undertake per year. The shipping process also suffers from cargo losses during the loading and unloading process of the ship  $l$  in %. These losses are accounted for separately and are not part of the shipping efficiency. Technical shipping parameters are listed in S 11 Table.

For specific synthesis processes (methanation, Haber-Bosch synthesis, methanol synthesis, Fischer-Tropsch synthesis) a must-run constraint is implemented in the model which forces a minimum capacity of synthesis capacity of each ESC to be online at all times. The constraint is

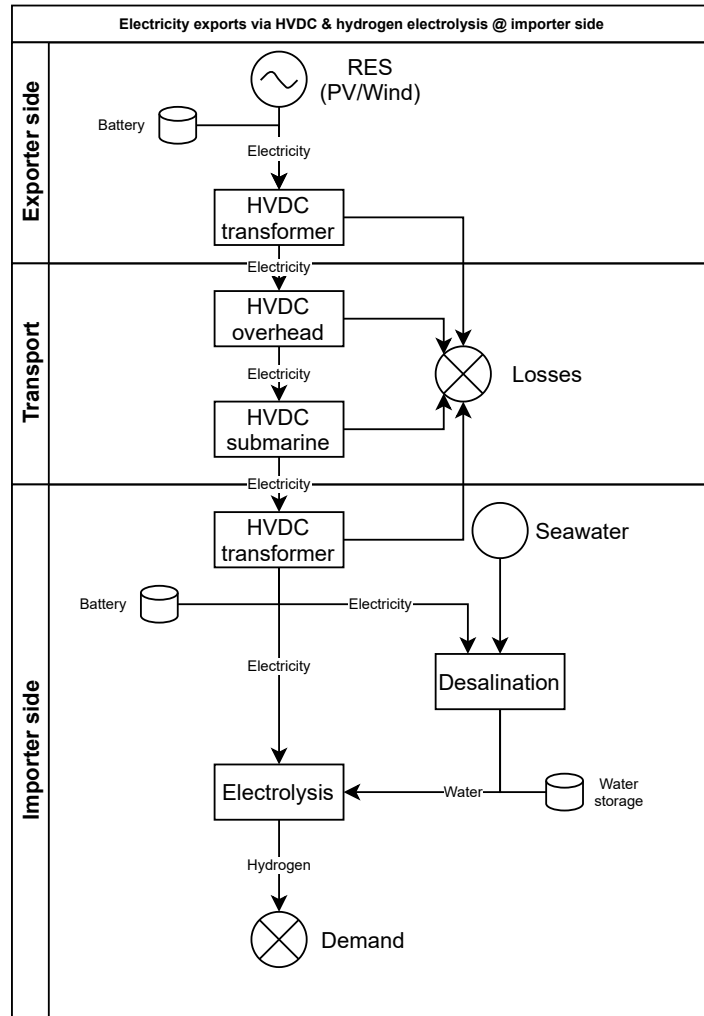
$$p_{\text{nom}}(t, \text{plant}) \geq p_{\text{nom, min}}(t, \text{plant}) \quad \forall t \quad (18)$$

with  $p_{\text{nom}}$  being the normalised output of a synthesis in timestep  $t$  of a specific synthesis plant and  $p_{\text{nom, min}}$  the normalised lower limit must-run availability, e.g. 0.9425.

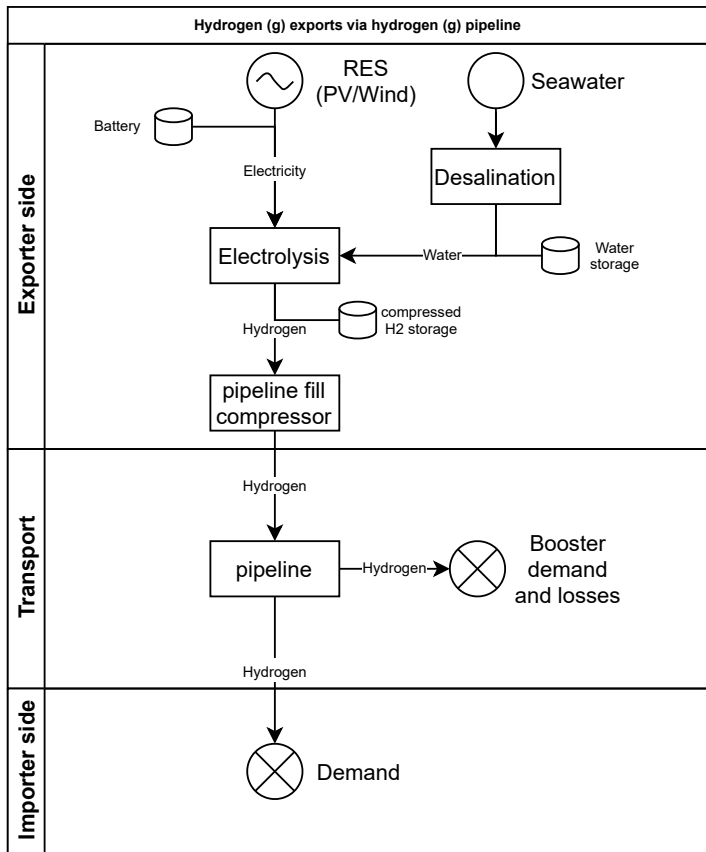
## References

1. Brown T, Hörsch J, Schlachtberger D. PyPSA: Python for Power System Analysis. Journal of Open Research Software. 2018;6(1). doi:10.5334/jors.188.

## S 4 Figs Energy Supply Chains visualisations



**Fig 19.** ESC schematic for HVDC electricity imports and domestic hydrogen electrolysis.



**Fig 20.** ESC schematic for imports of hydrogen gas by pipeline.

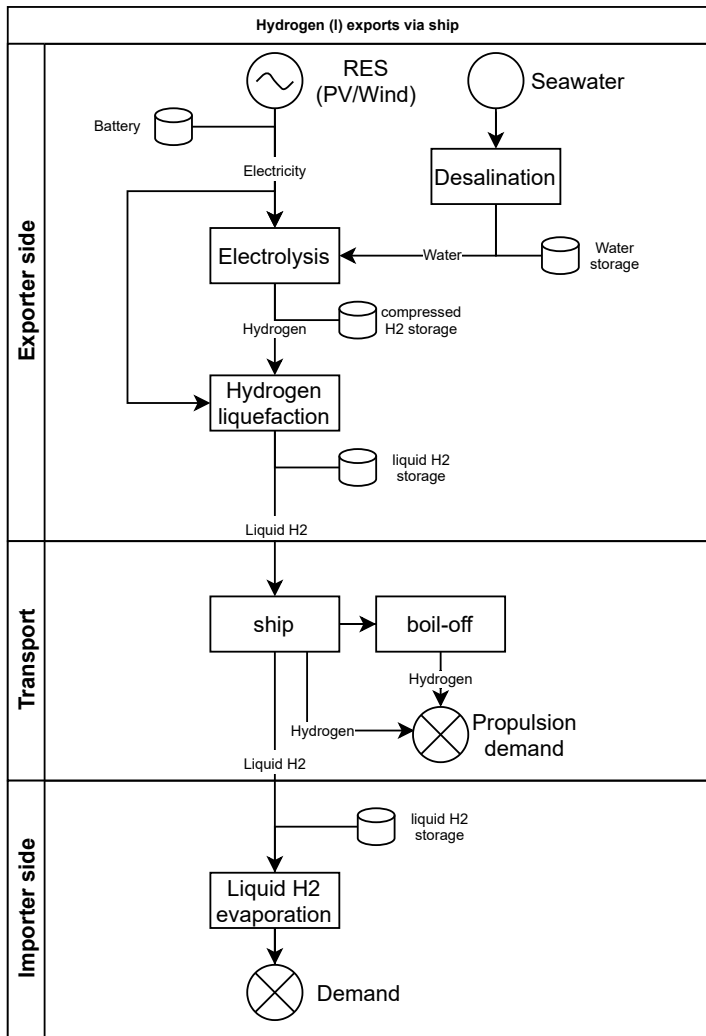


Fig 21. ESC schematic for liquid hydrogen imports by ship.

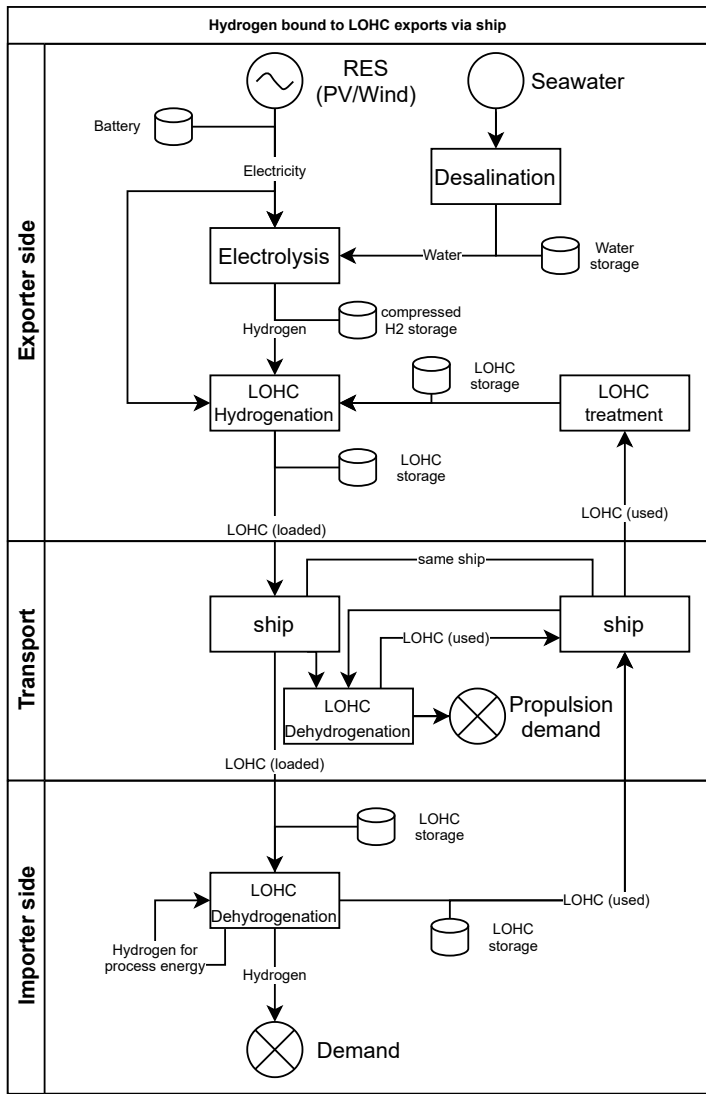
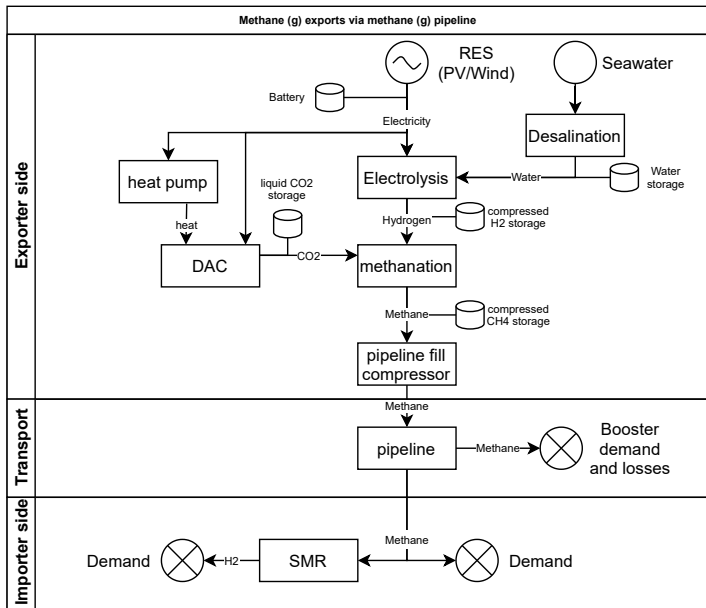
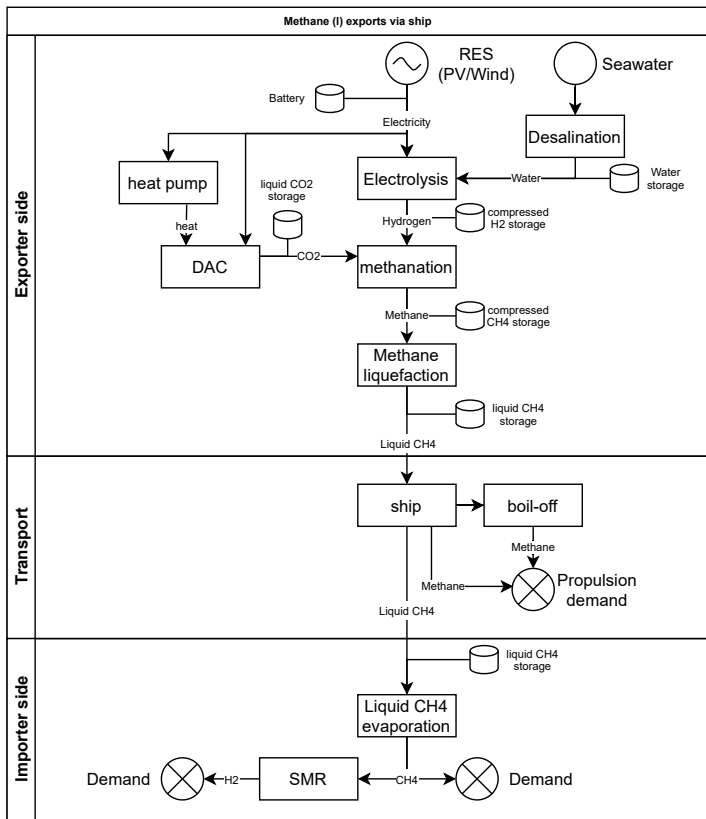


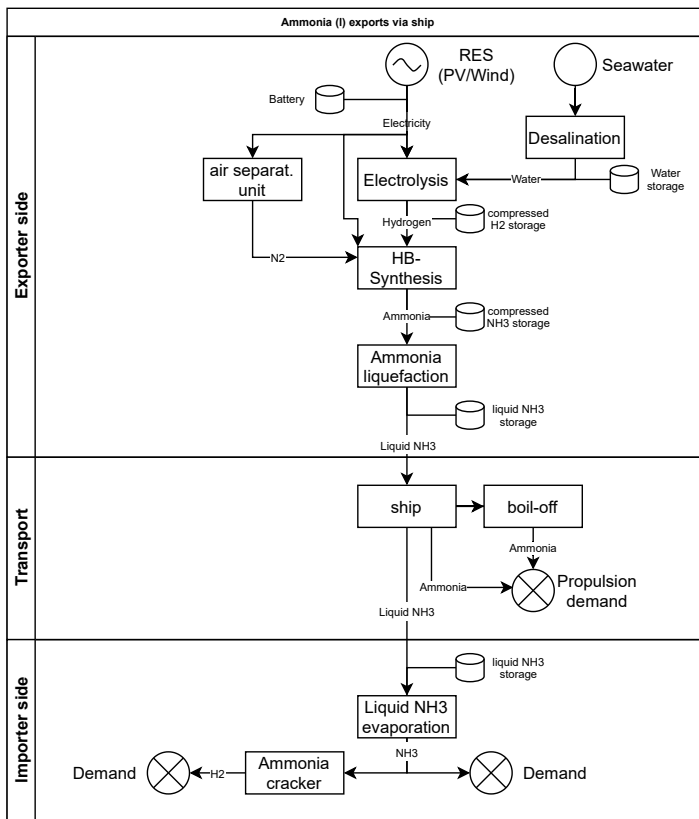
Fig 22. ESC schematic for hydrogen imports using LOHC by ship.



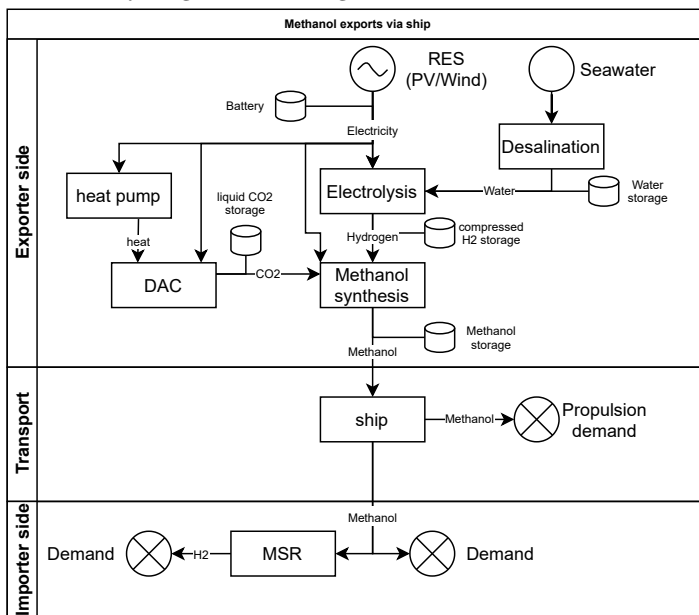
**Fig 23.** ESC schematic for imports of methane gas by pipeline. To serve an optional demand of hydrogen, methane may be split via steam methane reforming.



**Fig 24.** ESC schematic for liquid methane imports by ship. To serve an optional demand of hydrogen, methane may be split via steam methane reforming.



**Fig 25.** ESC schematic for liquid ammonia imports by ship. The ASU is assumed to provide nitrogen on demand without a dedicated nitrogen gas feedstock storage following [1]. To serve an optional demand of hydrogen, ammonia may be cracked in an ammonia cracker into hydrogen and nitrogen.



**Fig 26.** ESC schematic for methanol imports by ship. To serve an optional demand of hydrogen, methanol may be split via methanol steam reforming.

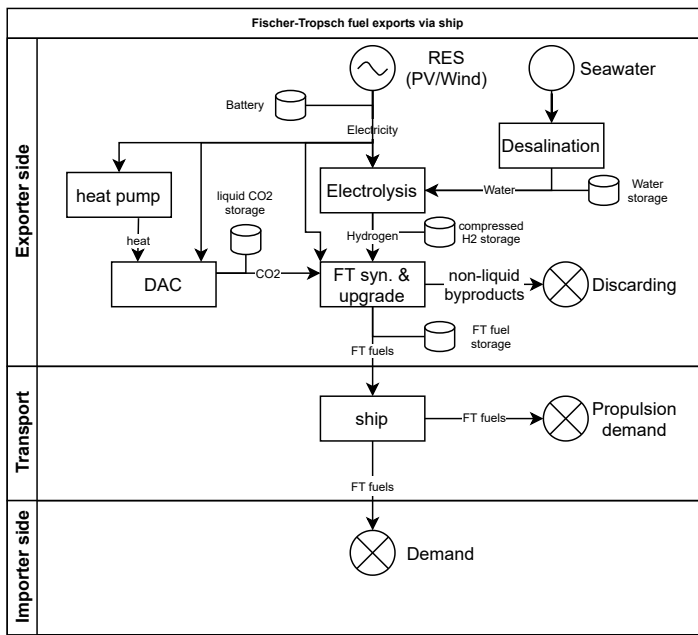


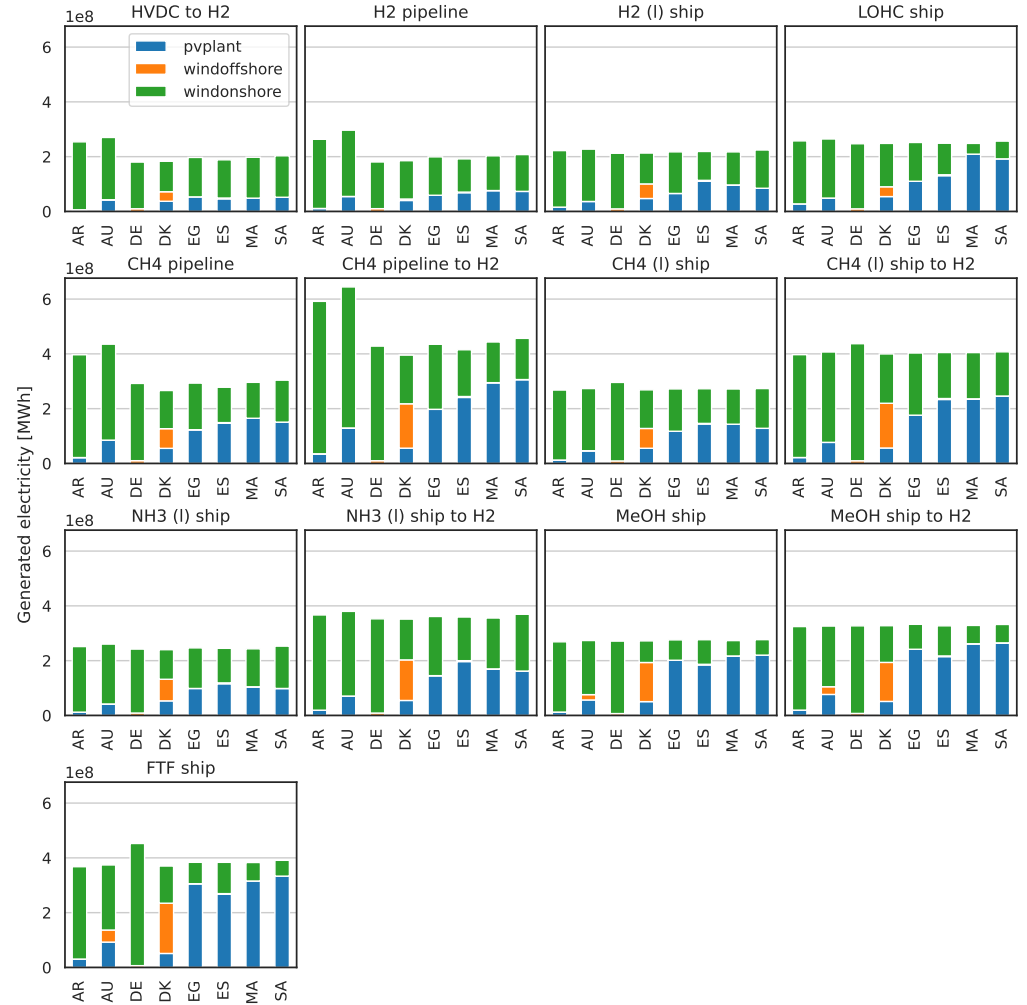
Fig 27. ESC schematic for FT fuel imports by ship.

## References

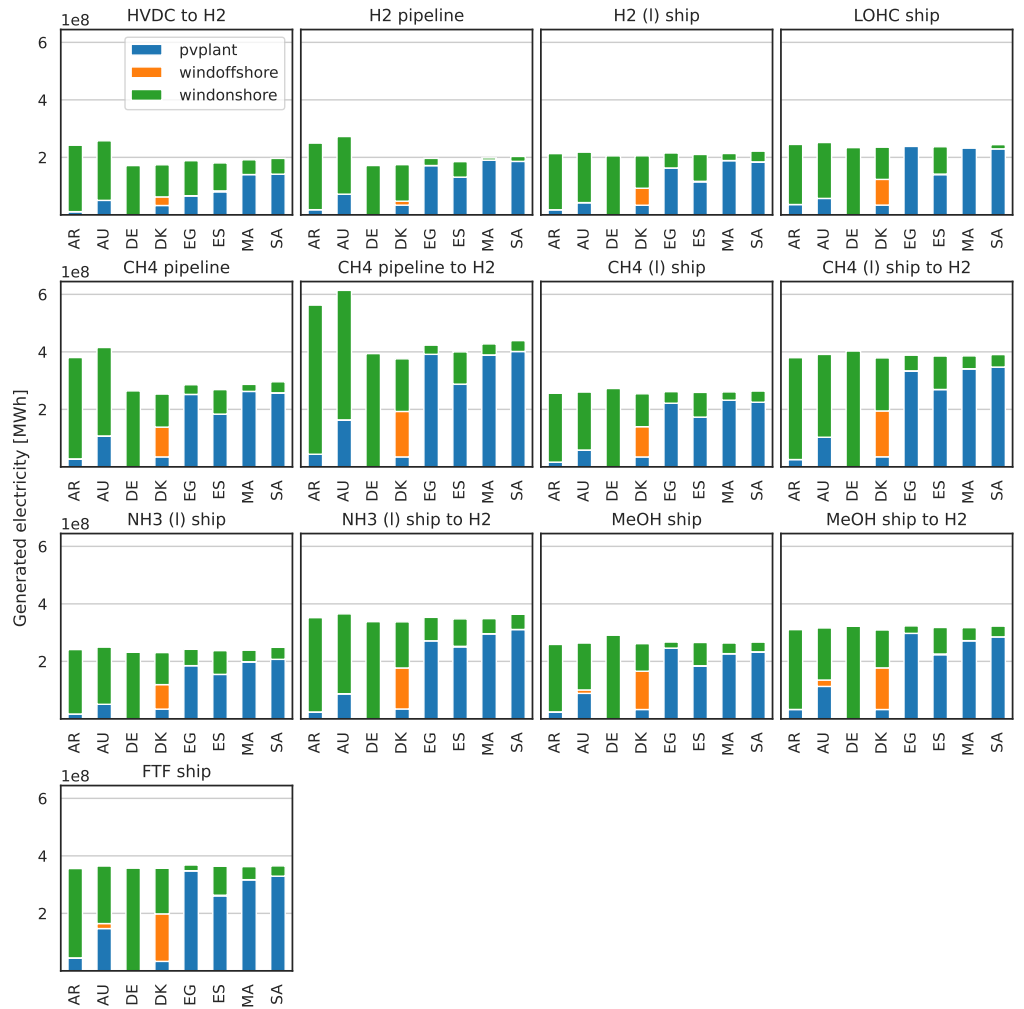
1. Bañares-Alcántara R, Iii GD, Fiaschetti M, Grünewald P, Lopez JM, Tsang E, et al. Analysis of Islanded Ammonia-based Energy Storage Systems; 2015. Available from: [http://www2.eng.ox.ac.uk/systemseng/publications/Ammonia-based\\_ESS.pdf](http://www2.eng.ox.ac.uk/systemseng/publications/Ammonia-based_ESS.pdf).



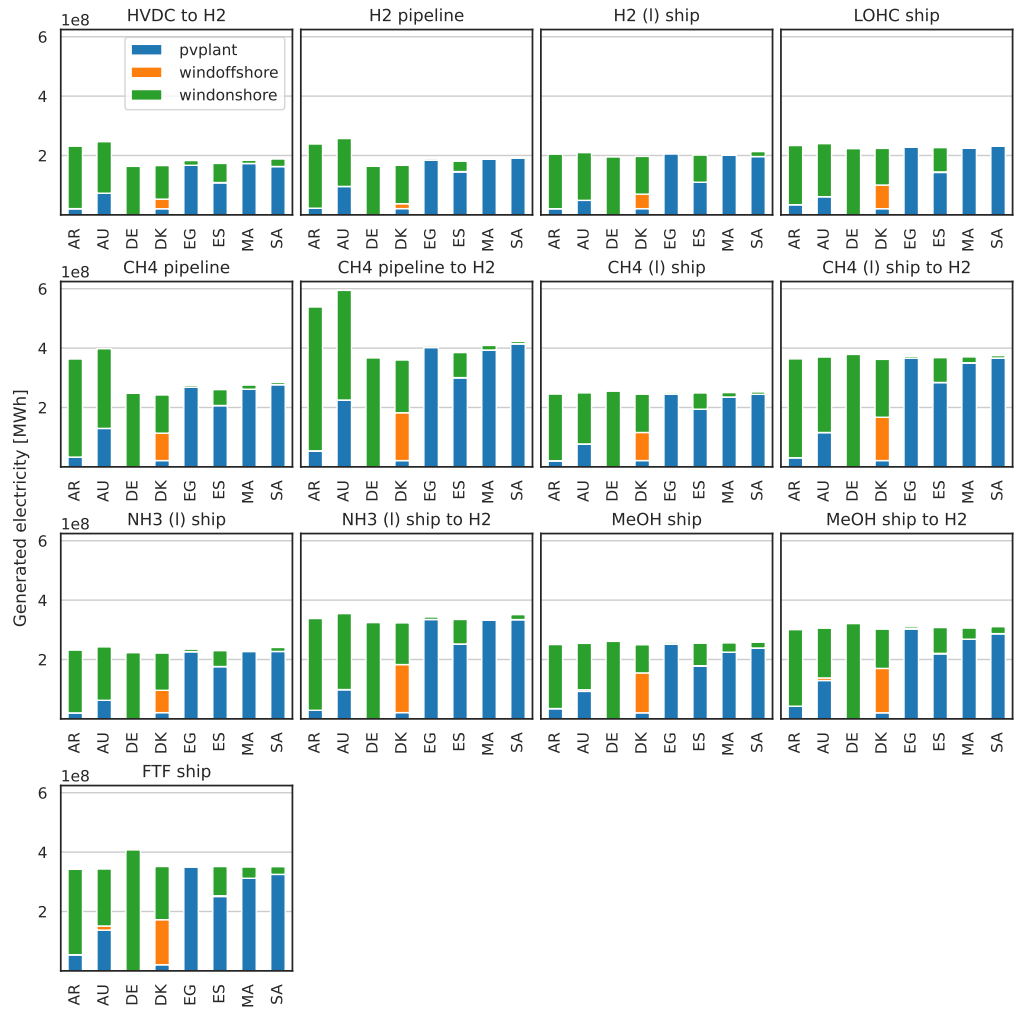
## S 5 Figs Electricity generation mix and supply curves



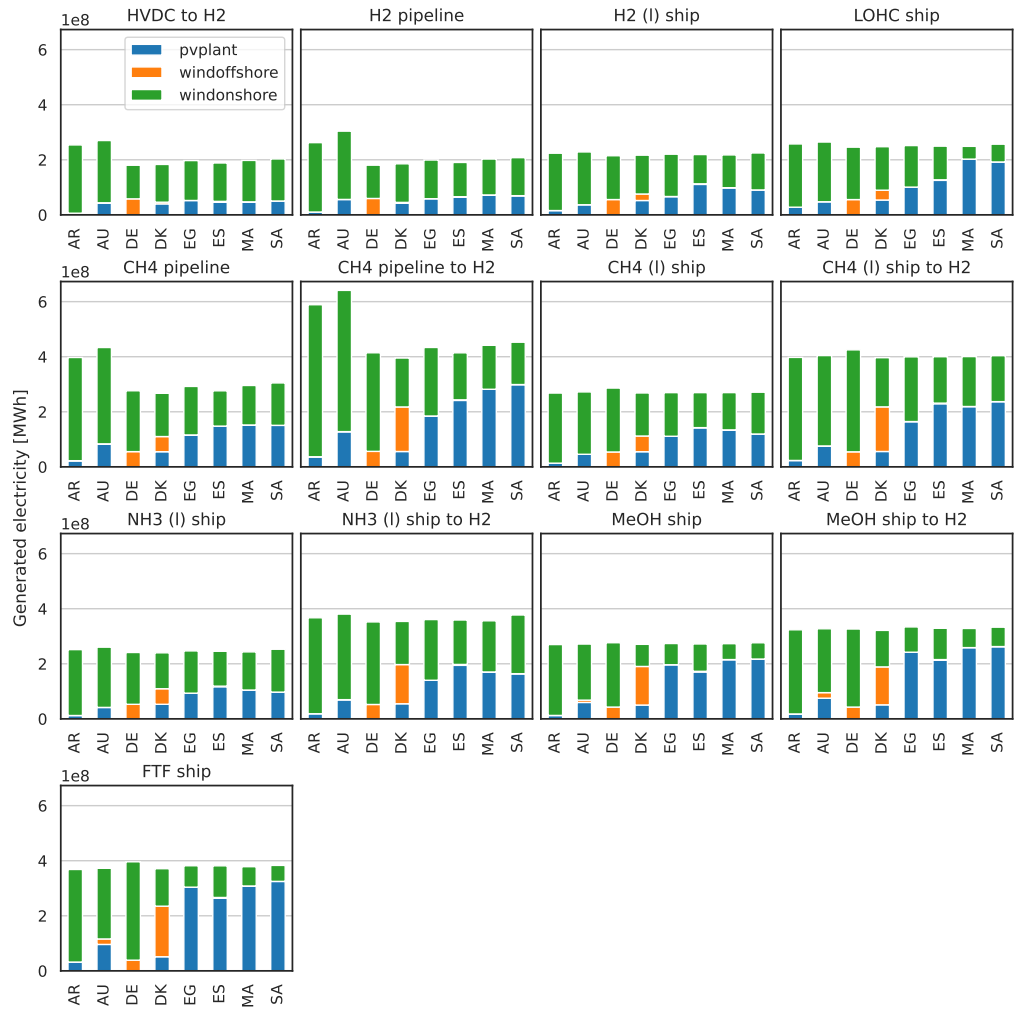
**Fig 28.** Electricity generation from RES ESC and exporting country under 10% p.a. WACC scenario for 2030.



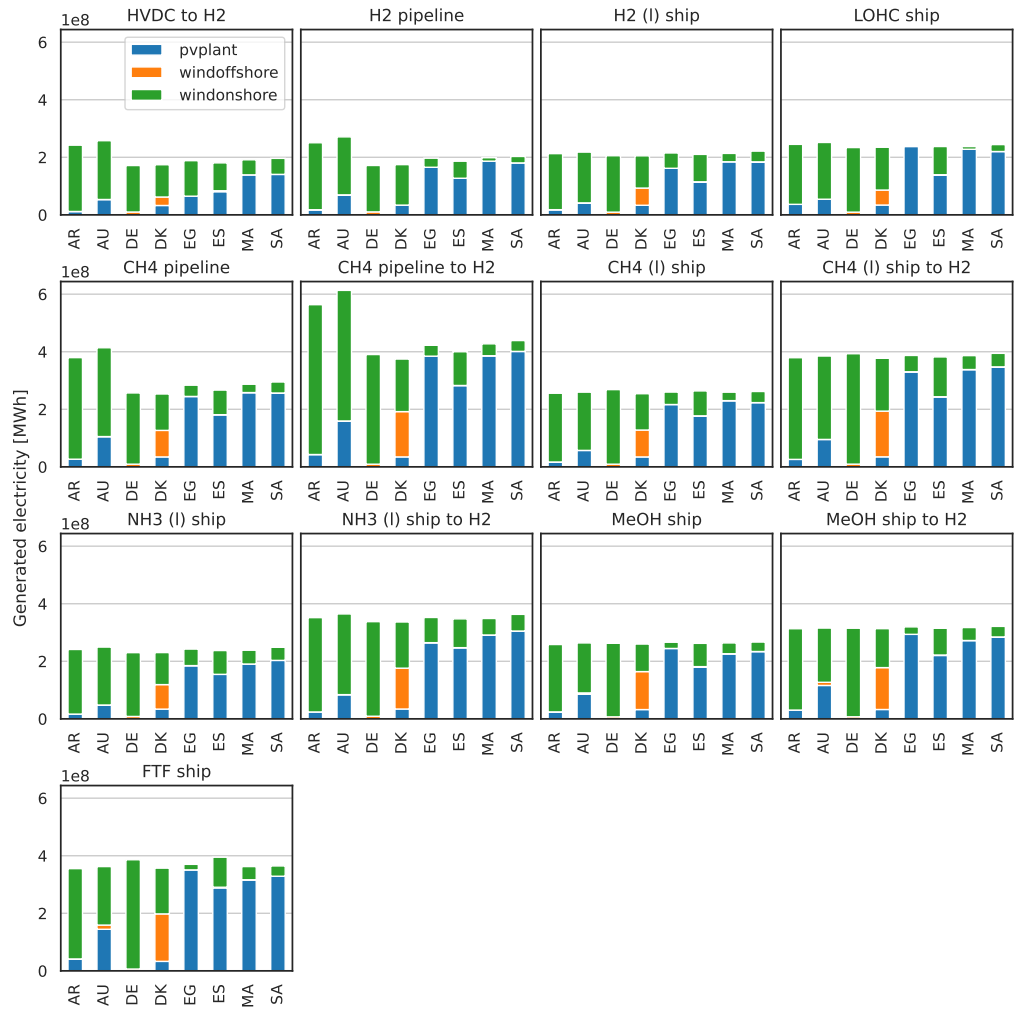
**Fig 29.** Electricity generation from RES ESC and exporting country under 10% p.a. WACC scenario for 2040.



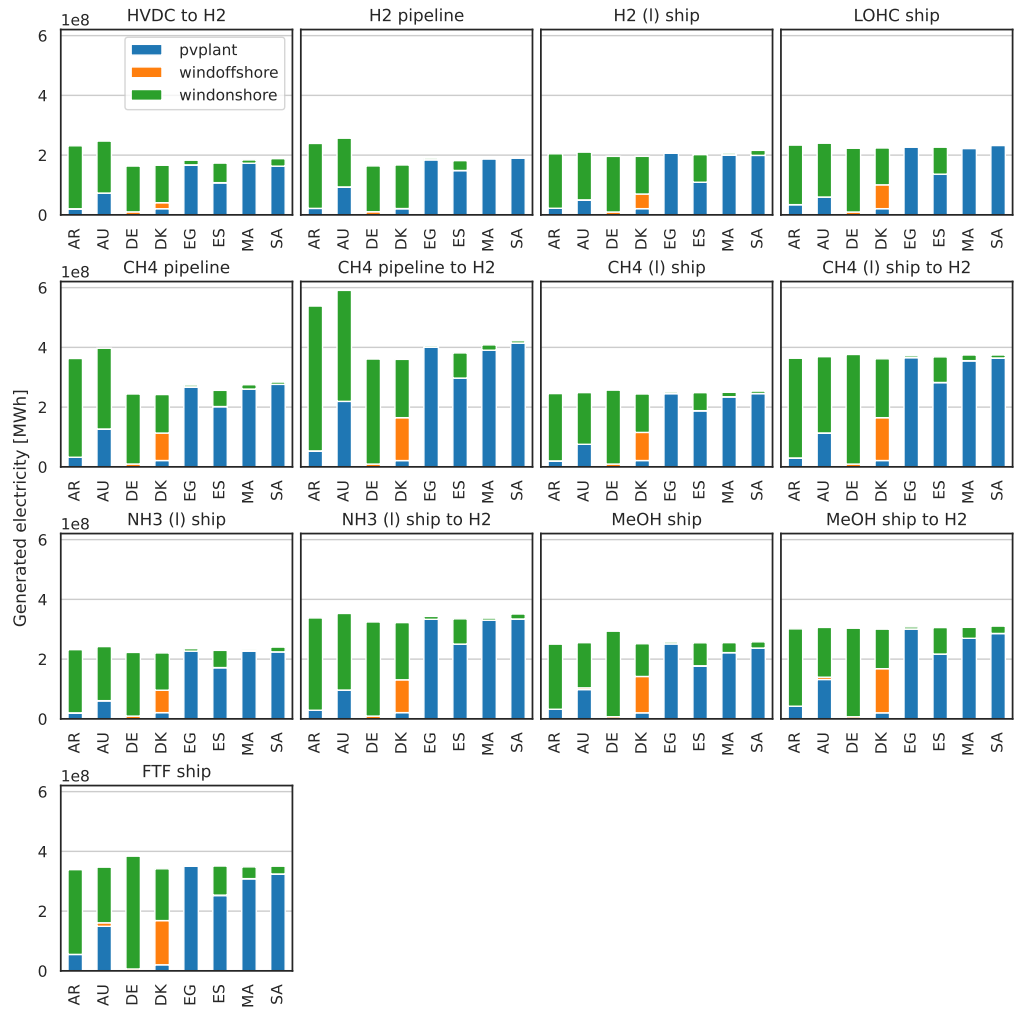
**Fig 30.** Electricity generation from RES ESC and exporting country under 10% p.a. WACC scenario for 2050.



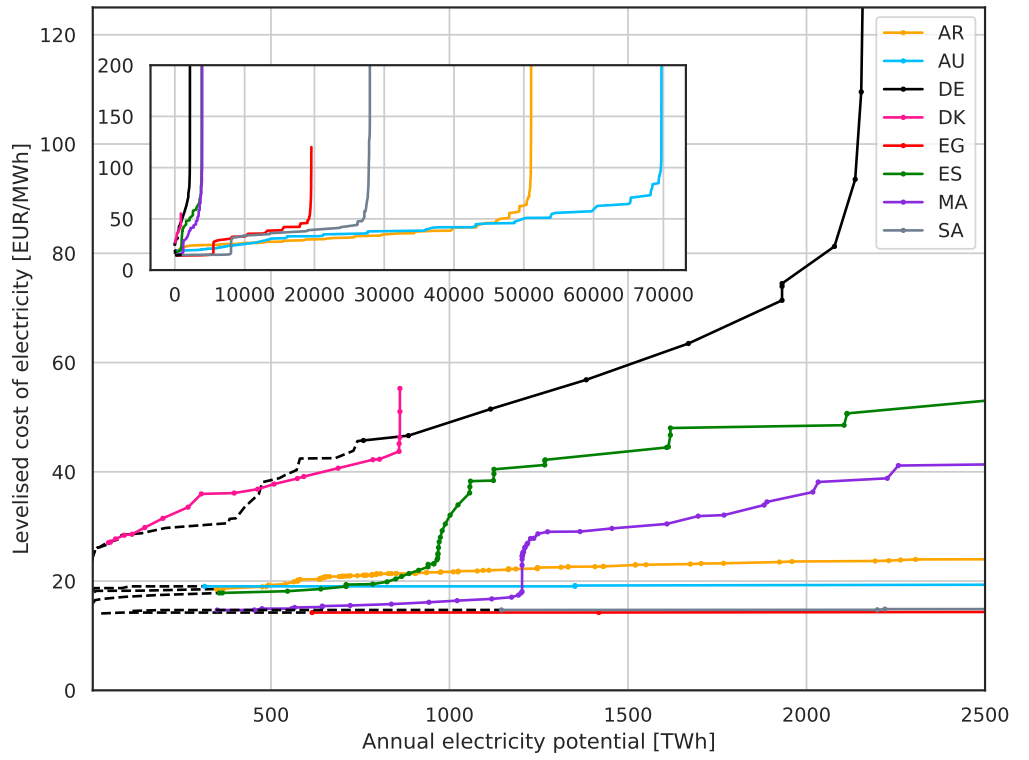
**Fig 31.** Electricity generation from RES ESC and exporting country under 5% p.a. WACC scenario for 2030.



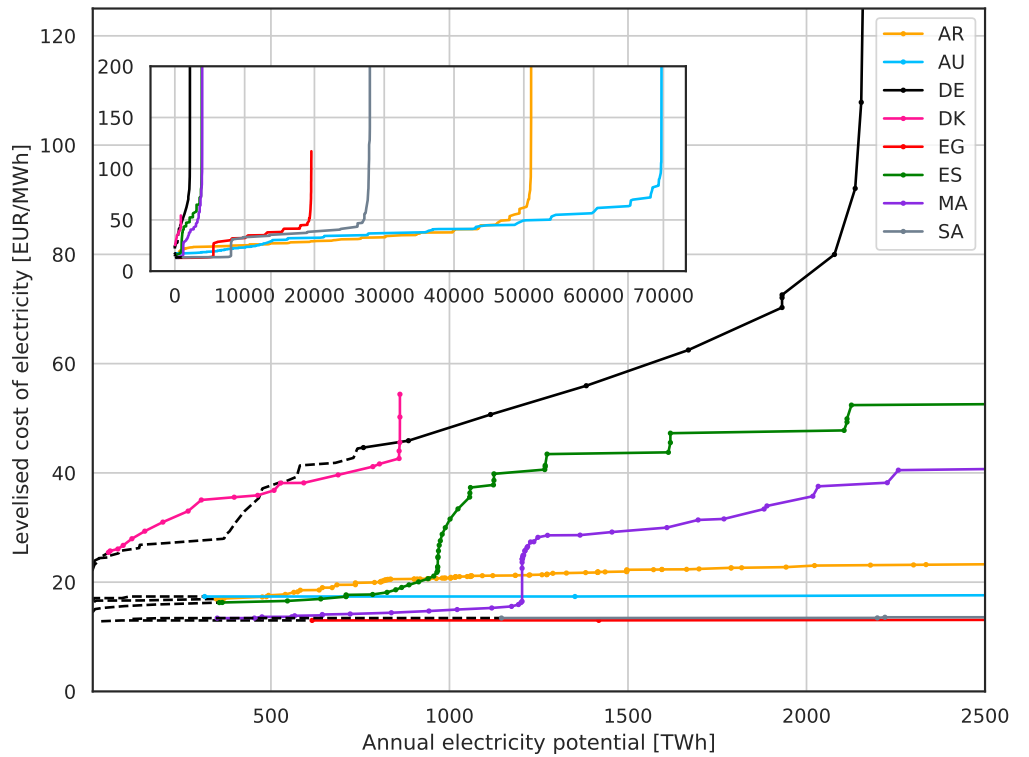
**Fig 32.** Electricity generation from RES ESC and exporting country under 5% p.a. WACC scenario for 2040.



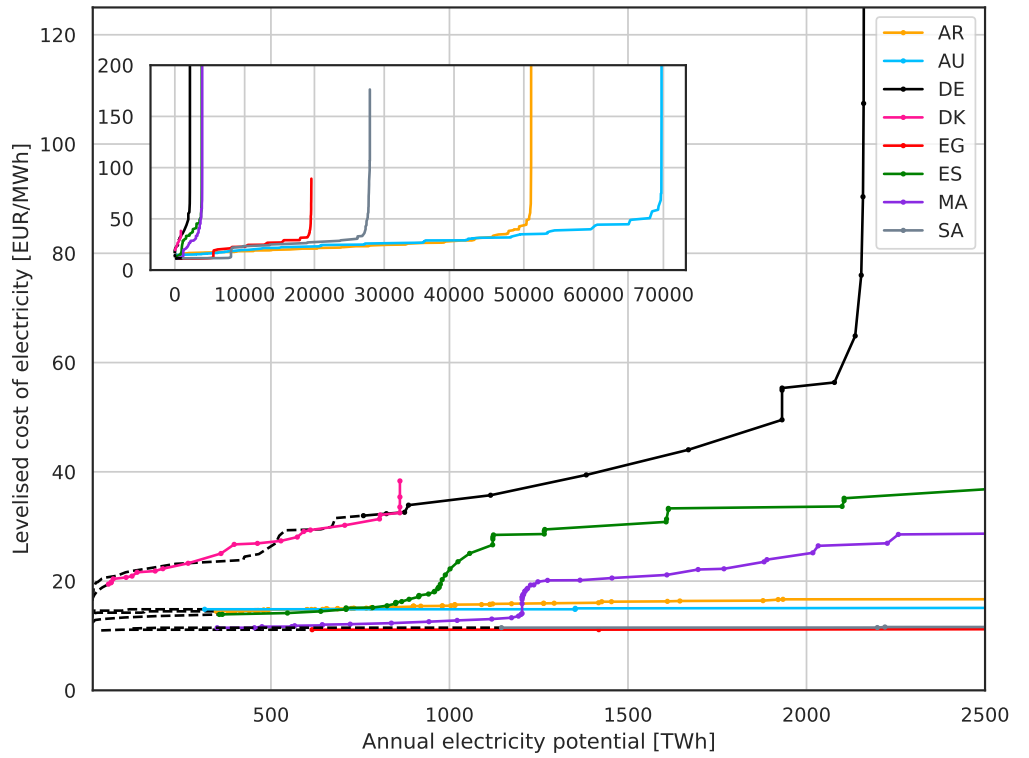
**Fig 33.** Electricity generation from RES ESC and exporting country under 5% p.a. WACC scenario for 2050.



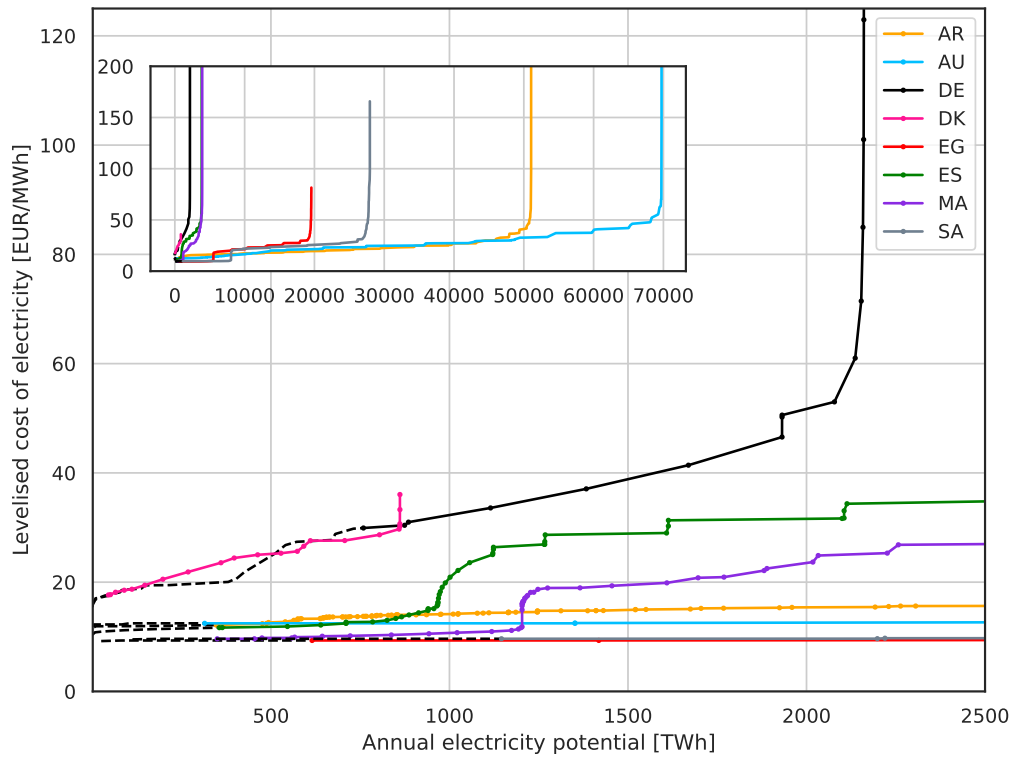
**Fig 34.** Similar figure as Fig 3 of electricity supply curves at 10% p.a. WACC for year 2040.



**Fig 35.** Similar figure as Fig 3 of electricity supply curves at 10% p.a. WACC for year 2050.

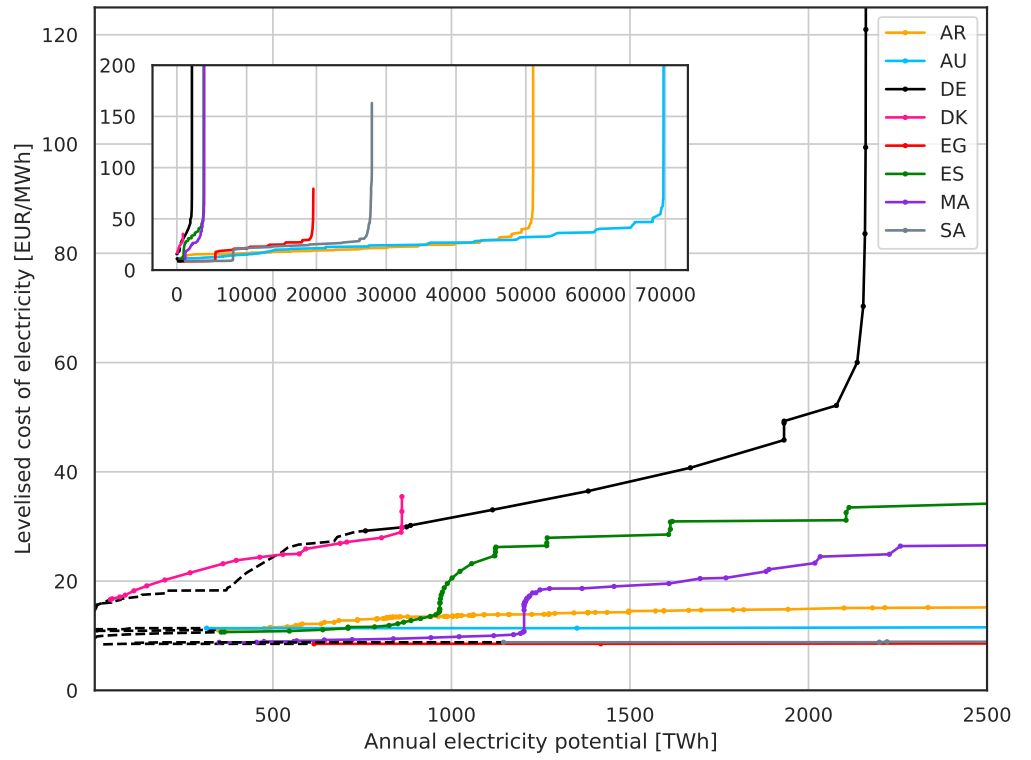


**Fig 36.** Similar figure as Fig 3 of electricity supply curves at 5% p.a. WACC for year 2030.



**Fig 37.** Similar figure as Fig 3 of electricity supply curves at 5% p.a. WACC for year 2040.





**Fig 38.** Similar figure as Fig 3 of electricity supply curves at 5% p.a. WACC for year 2050.

S 6 Figs Cost composition for other years, lower WACC

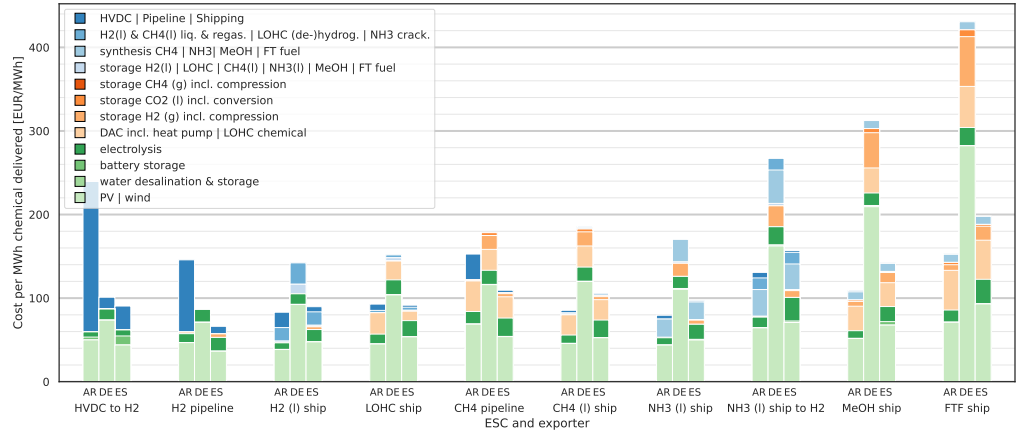


Fig 39. Similar figure as Fig 6 of cost compositions for selected ESCs at 10 % p.a. WACC for year 2040.

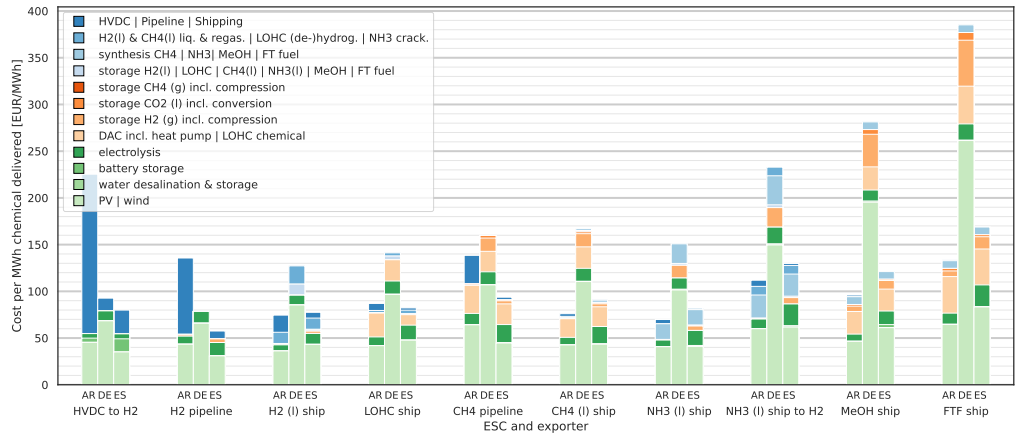


Fig 40. Similar figure as Fig 6 of cost compositions for selected ESCs at 10 % p.a. WACC for year 2050.

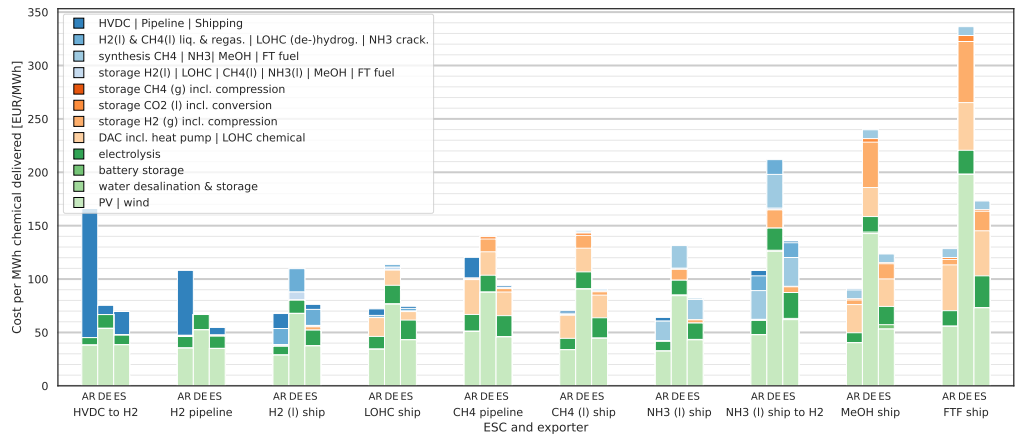


Fig 41. Cost compositions for selected ESCs at 5 % p.a. WACC for year 2030.

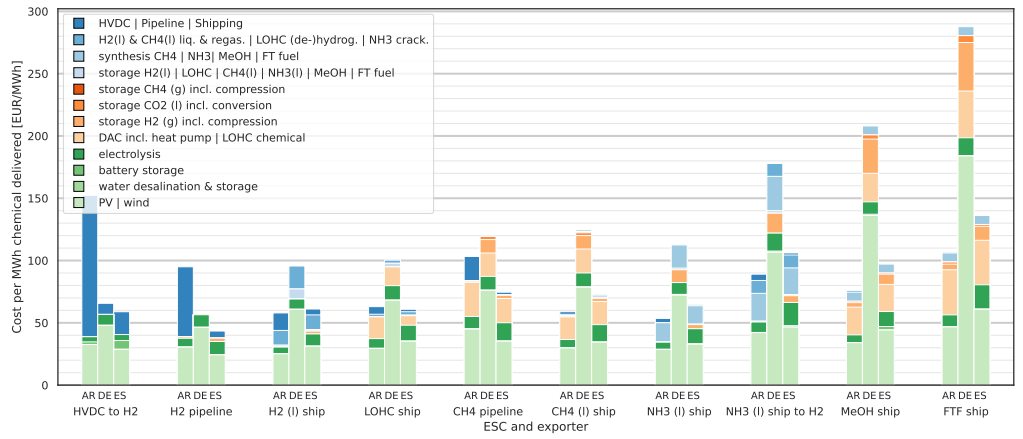


Fig 42. Cost compositions for selected ESCs at 5% p.a. WACC for year 2040.

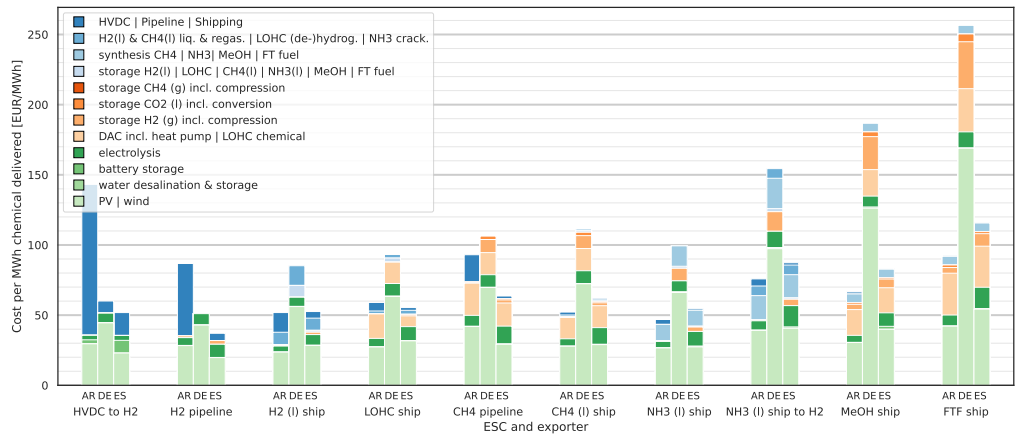


Fig 43. Cost compositions for selected ESCs at 5% p.a. WACC for year 2050.

### S 7 Table Tabular results: Levelised Cost of Energy

**Table 5.** Obtained Levelised Cost of Energy (LCoE) for all Energy Supply Chains (ESCs), exporting countries and 5 % p.a. as well as 10 % p.a. WACC.

ESC	year	WACC [% p.a.]	EUR/MWh <sub>LHV</sub>							
			AR	AU	DE	DK	EG	ES	MA	SA
pipeline-ch4	2030	5	120.36	151.42	139.76	95.56	87.33	93.60	92.42	94.01
	2030	10	177.03	224.37	213.60	139.92	128.07	137.57	135.71	138.14
	2040	5	103.28	129.78	119.39	79.60	69.88	74.59	72.45	74.01
	2040	10	152.72	193.13	178.38	116.17	102.15	109.46	106.02	108.53
	2050	5	93.04	116.67	106.37	71.67	58.44	63.63	60.69	62.24
pipeline-h2	2050	10	138.51	174.70	159.81	105.19	85.96	93.74	89.34	91.85
	2030	5	108.14	138.71	66.90	49.61	54.24	54.70	58.93	62.53
	2030	10	163.24	210.11	103.70	75.06	82.57	83.15	89.62	95.20
	2040	5	94.98	121.35	56.60	39.81	44.05	43.41	45.96	49.35
	2040	10	145.80	186.80	86.66	60.86	67.49	66.28	70.37	75.74
shipping-ffuel	2050	5	86.81	109.88	51.19	35.54	37.15	37.09	38.66	41.78
	2050	10	135.68	172.35	78.67	54.61	57.79	57.53	60.17	65.27
	2030	5	129.18	165.87	336.38	214.27	141.25	173.33	147.31	139.32
	2030	10	185.13	236.93	517.53	312.28	203.41	252.72	212.54	200.43
	2040	5	106.71	137.86	287.71	179.32	109.51	136.36	114.01	107.79
shipping-1ch4	2040	10	153.22	196.21	430.63	260.49	157.00	198.08	164.06	154.48
	2050	5	92.58	120.35	256.49	159.66	90.61	115.87	95.12	89.72
	2050	10	133.59	161.81	385.18	232.87	130.49	169.08	137.49	129.17
	2030	5	70.22	82.44	145.16	96.83	79.01	90.66	82.21	82.16
	2030	10	101.46	119.88	221.56	141.51	115.01	132.76	119.85	119.66
shipping-1ch4	2040	5	58.92	69.32	124.47	81.06	63.14	72.44	64.33	64.79
	2040	10	85.43	100.95	185.81	118.04	91.52	105.82	93.39	94.01
	2050	5	52.19	61.35	111.31	73.27	52.75	62.04	53.73	54.45
	2050	10	76.06	89.70	166.74	107.26	76.84	90.87	78.36	79.33

Table 5 (continued).

ESC	year	WACC [% p.a.]	EUR/MW <sub>hLHV</sub>									
			AR	AU	DE	DK	EG	ES	MA	SA		
shipping-lh2	2030	5	67.72	86.61	109.72	77.73	69.59	76.31	69.92	79.09		
	2030	10	97.12	124.05	165.98	113.63	101.07	112.11	102.24	114.30		
	2040	5	57.95	75.53	95.60	64.58	56.87	61.09	54.72	63.90		
	2040	10	83.14	107.97	142.17	94.25	82.58	89.75	79.99	92.08		
	2050	5	51.84	68.54	85.21	57.38	47.81	52.57	45.30	54.99		
shipping-lmh3	2050	10	74.56	98.00	127.22	84.06	69.56	77.55	66.49	79.23		
	2030	5	64.09	78.39	131.35	87.44	71.13	82.02	73.69	76.32		
	2030	10	94.89	116.27	203.86	130.01	105.98	122.58	109.86	113.50		
	2040	5	53.55	65.92	112.52	72.06	56.87	64.79	57.35	60.05		
	2040	10	79.51	97.85	170.29	106.99	84.61	96.85	85.46	89.16		
shipping-lohc	2050	5	46.90	57.94	99.37	63.98	46.95	54.62	46.93	49.92		
	2050	10	69.84	86.16	150.84	95.35	70.06	81.85	70.19	74.32		
	2030	5	72.06	100.08	113.52	76.33	69.32	74.52	66.62	79.29		
	2030	10	106.21	147.26	174.02	114.25	103.08	111.30	99.14	116.97		
	2040	5	62.98	89.44	100.32	64.84	56.10	60.87	51.63	65.01		
shipping-meoh	2040	10	92.85	131.36	151.70	96.25	82.85	91.54	76.70	95.55		
	2050	5	59.05	84.51	93.23	60.80	49.39	55.40	44.94	58.30		
	2050	10	87.05	124.03	141.18	90.52	73.07	82.25	66.90	85.64		
	2030	5	91.21	112.10	239.80	143.90	100.64	123.95	105.13	99.68		
	2030	10	130.87	162.58	372.17	209.31	145.20	181.05	151.94	143.53		
shipping-meoh	2040	5	76.03	93.26	208.01	123.06	78.73	97.61	81.53	77.81		
	2040	10	109.26	134.86	312.47	178.82	113.22	142.16	117.67	111.67		
	2050	5	66.53	81.44	186.72	111.91	65.43	83.22	68.27	65.07		
	2050	10	96.01	118.37	281.32	163.25	94.49	121.71	98.96	93.80		

### S 8 Table Tabular results: Levelised Cost of Hydrogen

**Table 6.** Obtained Levelised Cost of Hydrogen (LCoH) for all Energy Supply Chains (ESCs), exporting countries and 5% p.a. as well as 10% p.a. WACC.

ESC	year	WACC [% p.a.]	EUR/kg <sub>H2</sub>									
			AR	AU	DE	DK	EG	ES	MA	SA		
hvdc	2030	5	5.54	7.11	2.51	1.99	2.50	2.32	2.75	2.95		
	2030	10	8.68	11.13	3.93	3.03	3.85	3.56	4.24	4.55		
	2040	5	5.08	6.53	2.19	1.66	2.20	1.96	2.36	2.56		
	2040	10	7.99	10.23	3.37	2.54	3.39	3.02	3.63	3.95		
	2050	5	4.77	6.12	2.00	1.52	1.95	1.73	2.04	2.25		
pipeline-ch4	2050	10	7.51	9.60	3.09	2.33	3.02	2.66	3.16	3.48		
	2030	5	6.19	7.73	7.41	5.13	4.53	4.91	4.79	4.87		
	2030	10	9.10	11.45	11.24	7.46	6.63	7.21	7.01	7.14		
	2040	5	5.33	6.66	6.32	4.35	3.64	3.93	3.77	3.84		
	2040	10	7.88	9.89	9.42	6.35	5.31	5.76	5.52	5.63		
pipeline-h2	2050	5	4.82	6.00	5.65	3.94	3.07	3.38	3.19	3.25		
	2050	10	7.17	8.96	8.46	5.77	4.50	4.97	4.69	4.79		
	2030	5	3.60	4.62	2.23	1.65	1.81	1.82	1.96	2.08		
	2030	10	5.44	7.00	3.46	2.50	2.75	2.77	2.99	3.17		
	2040	5	3.17	4.04	1.89	1.33	1.47	1.45	1.53	1.64		
shipping-ffuel	2040	10	4.86	6.23	2.89	2.03	2.25	2.21	2.35	2.52		
	2050	5	2.89	3.66	1.71	1.18	1.24	1.24	1.29	1.39		
	2050	10	4.52	5.75	2.62	1.82	1.93	1.92	2.01	2.18		
	2030	5	4.31	5.53	11.21	7.14	4.71	5.78	4.91	4.64		
	2030	10	6.17	7.90	17.25	10.41	6.78	8.42	7.08	6.68		
shipping-ffuel	2040	5	3.56	4.60	9.59	5.98	3.65	4.55	3.80	3.59		
	2040	10	5.11	6.54	14.35	8.68	5.23	6.60	5.47	5.15		
	2050	5	3.09	4.01	8.55	5.32	3.02	3.86	3.17	2.99		
	2050	10	4.45	5.39	12.84	7.76	4.35	5.64	4.58	4.31		

Table 6 (continued).

ESC	year	WACC [% p.a.]	EUR/kg <sub>H2</sub>									
			AR	AU	DE	DK	EG	ES	MA	SA		
shipping-lch4	2030	5	3.67	4.30	7.60	5.12	4.08	4.71	4.25	4.26		
	2030	10	5.30	6.24	11.52	7.45	5.94	6.90	6.18	6.20		
	2040	5	3.10	3.63	6.48	4.35	3.30	3.79	3.36	3.38		
	2040	10	4.49	5.28	9.66	6.34	4.78	5.53	4.87	4.90		
	2050	5	2.77	3.23	5.81	3.94	2.78	3.26	2.83	2.86		
shipping-lh2	2050	10	4.03	4.72	8.67	5.77	4.04	4.78	4.12	4.17		
	2030	5	2.26	2.89	3.66	2.59	2.32	2.54	2.33	2.64		
	2030	10	3.24	4.13	5.53	3.79	3.37	3.74	3.41	3.81		
	2040	5	1.93	2.52	3.19	2.15	1.90	2.04	1.82	2.13		
	2040	10	2.77	3.60	4.74	3.14	2.75	2.99	2.67	3.07		
shipping-lmh3	2050	5	1.73	2.28	2.84	1.91	1.59	1.75	1.51	1.83		
	2050	10	2.49	3.27	4.24	2.80	2.32	2.59	2.22	2.64		
	2030	5	3.60	4.32	7.06	4.83	3.93	4.52	4.06	4.21		
	2030	10	5.27	6.35	10.79	7.10	5.79	6.69	5.99	6.20		
	2040	5	2.97	3.58	5.93	4.00	3.12	3.54	3.14	3.28		
shipping-lohc	2040	10	4.36	5.27	8.91	5.89	4.59	5.23	4.63	4.82		
	2050	5	2.53	3.07	5.15	3.47	2.51	2.91	2.52	2.66		
	2050	10	3.73	4.53	7.76	5.13	3.72	4.33	3.73	3.93		
	2030	5	2.40	3.34	3.78	2.54	2.31	2.48	2.22	2.64		
	2030	10	3.54	4.91	5.80	3.81	3.44	3.71	3.30	3.90		
shipping-meoh	2040	5	2.10	2.98	3.34	2.16	1.87	2.03	1.72	2.17		
	2040	10	3.09	4.38	5.06	3.21	2.76	3.05	2.56	3.18		
	2050	5	1.97	2.82	3.11	2.03	1.65	1.85	1.50	1.94		
	2050	10	2.90	4.13	4.71	3.02	2.44	2.74	2.23	2.85		
	2030	5	3.68	4.54	9.71	6.02	4.04	5.00	4.22	4.01		
shipping-meoh	2030	10	5.29	6.57	15.01	8.79	5.83	7.31	6.10	5.77		
	2040	5	3.07	3.76	8.39	5.11	3.16	3.94	3.28	3.12		

Table 6 (continued).

ESC	year	WACC [% p.a.]	EUR/kg <sub>H2</sub>							
			AR	AU	DE	DK	EG	ES	MA	SA
	2040	10	4.41	5.44	12.59	7.44	4.54	5.74	4.73	4.48
	2050	5	2.69	3.29	7.53	4.61	2.63	3.36	2.74	2.61
	2050	10	3.88	4.77	11.34	6.73	3.79	4.91	3.98	3.77



## S 9 Table Technology assumptions

All technology costs are given in EUR2015. Inflation adjustment was done where necessary assuming a 2 % p.a. inflation rate.

**Table 7.** Technology cost and lifetime assumptions used for 2030/2040/2050. A machine readable version of the input assumption can be found in the Zenodo and GitHub repositories listed in the data availability section.

technology	parameter	year	value	unit	source	
direct air capture	CAPEX	2030	60000000.0			
		2040	50000000.0	EUR/(tCO <sub>2</sub> /h)	Danish Energy Agency, ../technology_data_for_industrial_process_heat_0002.xlsx	
		2050	40000000.0			
	lifetime	2030	20.0		years	Danish Energy Agency, ../technology_data_for_industrial_process_heat_0002.xlsx
		2040	20.0			
		2050	20.0			
CO <sub>2</sub> liquefaction	FOM	2030	4.95	%/year	Danish Energy Agency, ../technology_data_for_industrial_process_heat_0002.xlsx	
		2040	4.95			
		2050	4.95			
	CAPEX	2030	16.03		EUR/t_CO <sub>2</sub> /h	Mitsubishi Heavy Industries Ltd. and IEA (2004): <a href="https://ieaghg.org/docs/General_Docs/Reports/PH4-30%20Ship%20Transport.pdf">https://ieaghg.org/docs/General_Docs/Reports/PH4-30%20Ship%20Transport.pdf</a>
		2040	16.03			
		2050	16.03			
methanolisation	lifetime	2030	25.0			
		2040	25.0		Guesstimate, based on CH <sub>4</sub> liquefaction.	
		2050	25.0			
	FOM	2030	5.0		%/year	Mitsubishi Heavy Industries Ltd. and IEA (2004): <a href="https://ieaghg.org/docs/General_Docs/Reports/PH4-30%20Ship%20Transport.pdf">https://ieaghg.org/docs/General_Docs/Reports/PH4-30%20Ship%20Transport.pdf</a>
		2040	5.0			
		2050	5.0			
CAPEX	2030	3008.96		EUR/kW_MeOH	Danish Energy Agency, ../data_sheets_for_renewable_fuels.xlsx	
	2040	2256.72				
	2050	1504.48				
		2030	20.0	years	Danish Energy Agency, ../data_sheets_for_renewable_fuels.xlsx	

Table 7 (continued).

technology	parameter	year	value	unit	source
		2040	20.0		
		2050	20.0		
		2030	1.75		
	FOM	2040	2.33	%/year	Danish Energy Agency, ../data_sheets_for_renewable_fuels.xlsx
		2050	3.5		
battery storage	CAPEX	2030	142.0	EUR/kWh	Danish Energy Agency, ../technology_data_catalogue_for_energy_storage.xlsx
		2040	94.0		
		2050	75.0		
		2030	25.0		
	lifetime	2040	30.0	years	Danish Energy Agency, ../technology_data_catalogue_for_energy_storage.xlsx
		2050	30.0		
	FOM	-	-		
seawater desalination	CAPEX	2030	32882.05	EUR/(m <sup>3</sup> -H <sub>2</sub> O/HP)	Caldera et al 2017: Learning Curve for Seawater Reverse Osmosis Desalination (https://doi.org/10.1002/2017WR021402), Table 4.
		2040	26297.44		
		2050	21025.64		
		2030	30.0	years	Caldera et al 2016: Local cost of seawater RO desalination based on solar PV and windenergy: A global estimate. (https://doi.org/10.1016/j.desal.2016.02.004), Table 1.
	lifetime	2040	30.0	years	Caldera et al 2016: Local cost of seawater RO desalination based on solar PV and windenergy: A global estimate. (https://doi.org/10.1016/j.desal.2016.02.004), Table 1.
		2050	30.0		
	FOM	2030	4.0	%/year	Caldera et al 2016: Local cost of seawater RO desalination based on solar PV and windenergy: A global estimate. (https://doi.org/10.1016/j.desal.2016.02.004), Table 1.
		2040	4.0		
		2050	4.0		
methanation	CAPEX	2030	278.0	EUR/kW(CH <sub>4</sub> )	Fasihi et al 2017, table 1, https://www.mdpi.com/2071-1050/9/2/306
		2040	226.0		
		2050	226.0		
		2030	30.0	years	Fasihi et al 2017, table 1, https://www.mdpi.com/2071-1050/9/2/306
	lifetime	2040	30.0	years	Fasihi et al 2017, table 1, https://www.mdpi.com/2071-1050/9/2/306

Table 7 (continued).

technology	parameter	year	value	unit	source
H2 (g) submarine pipeline	FOM	2050	30.0	% / year	Fasihi et al 2017, table 1, <a href="https://www.mdpi.com/2071-1050/9/2/306">https://www.mdpi.com/2071-1050/9/2/306</a>
		2030	4.0		
	2040	4.0	EUR/MW/km		
	2050	4.0			
	2030	329.37			
CAPEX	2040	329.37	years		
	2050	329.37			
lifetime	FOM	2030		30.0	Assume same as for CH4 (g) submarine pipeline.
		2040		30.0	
	2050	30.0			
	2030	3.0			
	2040	3.0			
General liquid hydrocarbon storage (product)	FOM	2050	3.0	% / year	Assume same as for CH4 (g) submarine pipeline.
		2030	169.79		
	CAPEX	2040	169.79	EUR/m3	
		2050	169.79		
		2030	30.0		
lifetime	FOM	2040	30.0	years	Stelter and Nishida 2013: <a href="https://webstore.iea.org/insights-series-2013-focus-on-energy-security">https://webstore.iea.org/insights-series-2013-focus-on-energy-security</a> , pg. 11.
		2050	30.0		
	2030	6.25	Stelter and Nishida 2013: <a href="https://webstore.iea.org/insights-series-2013-focus-on-energy-security">https://webstore.iea.org/insights-series-2013-focus-on-energy-security</a> , figure 7 and pg. 12 .		
	2040	6.25			
	2050	6.25			
CH4 evaporation	CAPEX	2030	0.28	EUR/kW(CH4)	Calculated, based on Fasihi et al 2017, table 1, <a href="https://www.mdpi.com/2071-1050/9/2/306">https://www.mdpi.com/2071-1050/9/2/306</a>

Table 7 (continued).

technology	parameter	year	value	unit	source
		2040	0.28		
		2050	0.28		
	lifetime	2030	30.0	years	Fasihi et al 2017, table 1, <a href="https://www.mdpi.com/2071-1050/9/2/306">https://www.mdpi.com/2071-1050/9/2/306</a>
		2040	30.0		
		2050	30.0		
	FOM	2030	3.5	%/year	Fasihi et al 2017, table 1, <a href="https://www.mdpi.com/2071-1050/9/2/306">https://www.mdpi.com/2071-1050/9/2/306</a>
		2040	3.5		
		2050	3.5		
Fischer-Tropsch	CAPEX	2030	1600.0	EUR/kW <sub>FT</sub> /year	Danish Energy Agency, ../data_sheets_for_renewable_fuels.xlsx
		2040	1100.0		
		2050	900.0		
	lifetime	2030	25.0	years	Danish Energy Agency, ../data_sheets_for_renewable_fuels.xlsx
		2040	25.0		
		2050	25.0		
	FOM	2030	3.0	%/year	doi:10.3390/su9020306
		2040	3.0		
		2050	3.0		
LNG storage tank	CAPEX	2030	611.59	EUR/m <sup>3</sup>	Hurskainen 2019, <a href="https://cris.vtt.fi/en/publications/liquid-organic-hydrogen-carriers-lohc-concept-evaluation-and-tech">https://cris.vtt.fi/en/publications/liquid-organic-hydrogen-carriers-lohc-concept-evaluation-and-tech</a> pg. 46 (59).
		2040	611.59		
		2050	611.59		
	lifetime	2030	20.0	years	Guesstimate, based on H2 (1) storage tank with comparable requirements.
		2040	20.0		
		2050	20.0		
	FOM	2030	2.0	%/year	Guesstimate, based on H2 (1) storage tank with comparable requirements.
		2040	2.0		
		2050	2.0		

Table 7 (continued).

technology	parameter	year	value	unit	source
H2 (l) storage tank	CAPEX	2030	750.08		EUR/MWh(H2) Reuß et al 2017, <a href="https://doi.org/10.1016/j.apenergy.2017.05.050">https://doi.org/10.1016/j.apenergy.2017.05.050</a> , Table 6.
		2040	750.08		
		2050	750.08		
		2030	20.0		
		2040	20.0	years	
	lifetime	2050	20.0		Reuß et al 2017, <a href="https://doi.org/10.1016/j.apenergy.2017.05.050">https://doi.org/10.1016/j.apenergy.2017.05.050</a> , Table 6.
		2030	2.0		
		2040	2.0	%/year	
		2050	2.0		
		2030	132.26		
LOHC un-loaded storage	CAPEX	2040	2.0		Density via Wissenschaftliche Dienste des Deutschen Bundestages 2020, <a href="https://www.bundestag.de/resource/blob/816048/454e182d5956d45a664da9eb85486f76/WD-8-058-20-pdf-data.pdf">https://www.bundestag.de/resource/blob/816048/454e182d5956d45a664da9eb85486f76/WD-8-058-20-pdf-data.pdf</a> , pg. 11.
		2050	2.0		
		2030	132.26		
		2040	132.26		
		2050	132.26		
	lifetime	2030	30.0		nan
		2040	30.0	years	
		2050	30.0		
		2030	6.25		
		2040	6.25	%/year	
battery in-verter	CAPEX	2050	6.25		Danish Energy Agency, ../technology_data_catalogue_for_energy_storage.xlsx
		2030	160.0		
		2040	100.0	EUR/kW	
		2050	60.0		
		2030	10.0		
	lifetime	2040	10.0		Danish Energy Agency, ../technology_data_catalogue_for_energy_storage.xlsx, Note K.
		2050	10.0	years	
		2030	10.0		
		2040	10.0		
		2050	10.0		

Table 7 (continued).

technology	parameter	year	value	unit	source
	FOM	2030	0.34		
		2040	0.54	%/year	Danish Energy Agency, ../technology_data_catalogue_for_energy_storage.xlsx
		2050	0.9		
Methanol steam reforming	CAPEX	2030	16318.43	EUR/MW(H2)	Niermann et al (2021): 10.1016/j.rser.2020.110171 , table 4.
		2040	16318.43		
		2050	16318.43		
	lifetime	2030	20.0	years	Niermann et al (2021): 10.1016/j.rser.2020.110171 , table 4.
		2040	20.0		
		2050	20.0		
	FOM	2030	4.0		
		2040	4.0	%/year	Niermann et al (2021): 10.1016/j.rser.2020.110171 , table 4.
		2050	4.0		
CO2 storage tank	CAPEX	2030	2528.17	EUR/t_CO2	Lauri et al. 2014: doi: 10.1016/j.egypro.2014.11.297, Table 3.
		2040	2528.17		
		2050	2528.17		
	lifetime	2030	25.0	years	Lauri et al. 2014: doi: 10.1016/j.egypro.2014.11.297, pg. 2746 .
		2040	25.0		
		2050	25.0		
	FOM	2030	1.0		
		2040	1.0	%/year	Lauri et al. 2014: doi: 10.1016/j.egypro.2014.11.297, pg. 2746 .
		2050	1.0		
LOHC hydro-generation	CAPEX	2030	46471.24	EUR/MW(H2)	Runge et al 2020, pg.8, https://papers.ssrn.com/abstract=3623514
		2040	46471.24		
		2050	46471.24		

Table 7 (continued).

technology	parameter	year	value	unit	source
H2 (g) pipeline	lifetime	2030	20.0	years	Runge et al 2020, pg.8, <a href="https://papers.ssrn.com/abstract=3623514">https://papers.ssrn.com/abstract=3623514</a>
		2040	20.0		
		2050	20.0		
	FOM	2030	3.0	%/year	Runge et al 2020, pg.8, <a href="https://papers.ssrn.com/abstract=3623514">https://papers.ssrn.com/abstract=3623514</a>
		2040	3.0		
		2050	3.0		
industrial heat pump medium temperature	CAPEX	2030	226.47	EUR/MW/km	European Hydrogen Backbone Report (June 2021): <a href="https://gasforclimate2050.eu/wp-content/uploads/2021/06/EHB_Analysing-the-future-demand-supply-and-transport-of-hydrogen_June-2021.pdf">https://gasforclimate2050.eu/wp-content/uploads/2021/06/EHB_Analysing-the-future-demand-supply-and-transport-of-hydrogen_June-2021.pdf</a> .
		2040	226.47		
		2050	226.47		
	lifetime	2030	50.0	years	Danish Energy Agency, Technology Data for Energy Transport (2021), Excel datasheet: H2 140.
		2040	50.0		
		2050	50.0		
FOM	2030	3.17	%/year	Danish Energy Agency, Technology Data for Energy Transport (2021), Excel datasheet: H2 140.	
	2040	2.33			
	2050	1.5			
CH4 (g) pipeline	CAPEX	2030	778.8	EUR/kW	Danish Energy Agency, <a href="https://technology_data_for_industrial_process_heat_0002.xlsx">technology_data_for_industrial_process_heat_0002.xlsx</a>
		2040	730.0		
		2050	700.0		
	lifetime	2030	20.0	years	Danish Energy Agency, <a href="https://technology_data_for_industrial_process_heat_0002.xlsx">technology_data_for_industrial_process_heat_0002.xlsx</a>
		2040	20.0		
		2050	20.0		
FOM	2030	0.11	%/year	Danish Energy Agency, <a href="https://technology_data_for_industrial_process_heat_0002.xlsx">technology_data_for_industrial_process_heat_0002.xlsx</a>	
	2040	0.11			
	2050	0.1			
		2030	79.0	EUR/MW/km	Guesstimate.

Table 7 (continued).

technology	parameter	year	value	unit	source
		2040	79.0		
		2050	79.0		
		2030	50.0		
	lifetime	2040	50.0	years	Assume same as for H2 (g) pipeline in 2050 (CH4 pipeline as mature technology).
		2050	50.0		
		2030	1.5		
	FOM	2040	1.5	%/year	Assume same as for H2 (g) pipeline in 2050 (CH4 pipeline as mature technology).
		2050	1.5		
CCGT		2030	830.0		
	CAPEX	2040	815.0	EUR/kW	Danish Energy Agency, ../technology_data_for(el)_and_dh.xlsx
		2050	800.0		
		2030	25.0		
	lifetime	2040	25.0	years	Danish Energy Agency, ../technology_data_for(el)_and_dh.xlsx
		2050	25.0		
		2030	3.35		
	FOM	2040	3.3	%/year	Danish Energy Agency, ../technology_data_for(el)_and_dh.xlsx
		2050	3.25		
		2030	0.74		
CH4 liquefaction	CAPEX			EUR/kW(CH4)	Calculated, based on Fasihi et al 2017, table 1, <a href="https://www.mdpi.com/2071-1050/9/2/306">https://www.mdpi.com/2071-1050/9/2/306</a>
		2040	0.74		
		2050	0.74		
		2030	25.0		
	lifetime	2040	25.0	years	Fasihi et al 2017, table 1, <a href="https://www.mdpi.com/2071-1050/9/2/306">https://www.mdpi.com/2071-1050/9/2/306</a>
		2050	25.0		
		2030	3.5		
	FOM	2040	3.5	%/year	Fasihi et al 2017, table 1, <a href="https://www.mdpi.com/2071-1050/9/2/306">https://www.mdpi.com/2071-1050/9/2/306</a>
		2050	3.5		



Table 7 (continued).

technology	parameter	year	value	unit	source
clean water tank storage	CAPEX	2030	67.63	EUR/m <sup>3</sup> -H <sub>2</sub> O	Caldera et al 2016: Local cost of seawater RO desalination based on solar PV and windenergy: A global estimate. ( <a href="https://doi.org/10.1016/j.desal.2016.02.004">https://doi.org/10.1016/j.desal.2016.02.004</a> ), Table 1.
		2040	67.63		
		2050	67.63		
	lifetime	2030	30.0	years	Caldera et al 2016: Local cost of seawater RO desalination based on solar PV and windenergy: A global estimate. ( <a href="https://doi.org/10.1016/j.desal.2016.02.004">https://doi.org/10.1016/j.desal.2016.02.004</a> ), Table 1.
		2040	30.0		
		2050	30.0		
HVDC in-verter pair	FOM	2030	2.0	%/year	Caldera et al 2016: Local cost of seawater RO desalination based on solar PV and windenergy: A global estimate. ( <a href="https://doi.org/10.1016/j.desal.2016.02.004">https://doi.org/10.1016/j.desal.2016.02.004</a> ), Table 1.
		2040	2.0		
		2050	2.0		
	CAPEX	2030	1500000.0	EUR/MW	Hagspiel
		2040	1500000.0		
		2050	1500000.0		
Ammonia cracker	lifetime	2030	40.0	years	Hagspiel
		2040	40.0		
		2050	40.0		
	FOM	2030	2.0	%/year	Hagspiel
		2040	2.0		
		2050	2.0		
Ammonia cracker	CAPEX	2030	1400083.71	EUR/MW(H <sub>2</sub> )	ENGIE et al (2020): Ammonia to Green Hydrogen Feasibility Study ( <a href="https://assets.publishing.service.gov.uk/government/uploads/system/uploads/attachment_data/file/880826/HS420_-_Ecuity_-_Ammonia_to_Green_Hydrogen.pdf">https://assets.publishing.service.gov.uk/government/uploads/system/uploads/attachment_data/file/880826/HS420_-_Ecuity_-_Ammonia_to_Green_Hydrogen.pdf</a> ).
		2040	1400083.71		
		2050	1400083.71		
	lifetime	2030	30.0	years	-
		2040	30.0		
		2050	30.0		
FOM		2030	3.0	%/year	-

Table 7 (continued).

technology	parameter	year	value	unit	source
LOHC loaded	CAPEX	2040	3.0	EUR/t	Density via Wissenschaftliche Dienste des Deutschen Bundestages 2020, <a href="https://www.bundestag.de/resource/blob/816048/454e182d5956d45a664da9eb85486f76/WD-8-058-20-pdf-data.pdf">https://www.bundestag.de/resource/blob/816048/454e182d5956d45a664da9eb85486f76/WD-8-058-20-pdf-data.pdf</a> , pg. 11.
		2050	3.0		
DBT storage	lifetime	2030	149.27	years	nan
		2040	149.27		
	FOM	2030	30.0	% / year	nan
		2040	30.0		
hydrogen storage tank incl. compressor	CAPEX	2030	6.25	EUR/kWh	Danish Energy Agency, ../technology_data_catalogue_for_energy_storage.xlsx
		2040	6.25		
	lifetime	2030	6.25	years	Danish Energy Agency, ../technology_data_catalogue_for_energy_storage.xlsx
		2040	44.91		
	FOM	2030	27.05	% / year	Danish Energy Agency, ../technology_data_catalogue_for_energy_storage.xlsx
		2040	21.0		
electrolysis	CAPEX	2030	30.0	EUR/kW_e	Danish Energy Agency, ../data_sheets_for_renewable_fuels.xlsx
		2040	30.0		
	lifetime	2030	30.0	years	Danish Energy Agency, ../technology_data_catalogue_for_energy_storage.xlsx
		2040	1.11		
	FOM	2030	1.85	% / year	Danish Energy Agency, ../technology_data_catalogue_for_energy_storage.xlsx
		2040	1.9		
	CAPEX	2030	450.0	EUR/kW_e	Danish Energy Agency, ../data_sheets_for_renewable_fuels.xlsx
		2040	300.0		
	lifetime	2030	250.0	years	Danish Energy Agency, ../data_sheets_for_renewable_fuels.xlsx
		2040	32.0		

Table 7 (continued).

technology	parameter	year	value	unit	source
		2050	35.0		
		2030	2.0		
	FOM	2040	2.0	%/year	Danish Energy Agency, ../data_sheets_for_renewable_fuels.xlsx
		2050	2.0		
methane storage tank incl. compressor	CAPEX	2030	8629.2	EUR/m <sup>3</sup>	Storage costs per l: <a href="https://www.compositesworld.com/articles/pressure-vessels-for-alternative-fuels-2014-2023">https://www.compositesworld.com/articles/pressure-vessels-for-alternative-fuels-2014-2023</a> (2021-02-10).
		2040	8629.2		
		2050	8629.2		
		2030	30.0		
	lifetime	2040	30.0	years	Guesstimate, based on hydrogen storage tank by DEA.
		2050	30.0		
		2030	1.9		
	FOM	2040	1.9	%/year	Guesstimate, based on hydrogen storage tank by DEA.
		2050	1.9		
air separation unit	CAPEX	2030	10942205.1	EUR/MW	Calculated based on Morgan E. 2013: doi:10.7275/11KT-3F59 , Fig. 56, Fig. 58, pg. 207, pg. 210.
		2040	10942205.1		
		2050	10942205.1		
		2030	20.0		
	lifetime	2040	20.0	years	Morgan E. 2013: doi:10.7275/11KT-3F59 , pg. 290
		2050	20.0		
		2030	4.0		
	FOM	2040	4.0	%/year	Estimate, based on methanation plant.
		2050	4.0		
H2 evaporation	CAPEX	2030	4320.43	EUR/MW(H <sub>2</sub> )	Reuß et al 2017: <a href="https://doi.org/10.1016/j.apenergy.2017.05.050">https://doi.org/10.1016/j.apenergy.2017.05.050</a> , Table 9 and equation in sec 3.0.
		2040	4320.43		

Table 7 (continued).

technology	parameter	year	value	unit	source
		2050	4320.43		
	lifetime	2030	10.0	years	Reuß et al 2017: <a href="https://doi.org/10.1016/j.apenergy.2017.05.050">https://doi.org/10.1016/j.apenergy.2017.05.050</a> , Table 9 and equation in sec 3.0.
		2040	10.0		
		2050	10.0		
	FOM	2030	3.0	%/year	Reuß et al 2017: <a href="https://doi.org/10.1016/j.apenergy.2017.05.050">https://doi.org/10.1016/j.apenergy.2017.05.050</a> , Table 9 and equation in sec 3.0.
		2040	3.0		
		2050	3.0		
H2 (g) fill compressor station	CAPEX	2030	4478.0	EUR/MW(H2)	Danish Energy Agency, Technology Data for Energy Transport (2021), pg. 164, Figure 14 (Fill compressor).
		2040	4478.0		
		2050	4478.0		
	lifetime	2030	20.0	years	Danish Energy Agency, Technology Data for Energy Transport (2021), pg. 168, Figure 24 (Fill compressor).
		2040	20.0		
		2050	20.0		
	FOM	2030	1.7	%/year	Guidehouse 2020: European Hydrogen Backbone report, <a href="https://guidehouse.com/-/media/www/site/downloads/energy/2020/gh_european-hydrogen-backbone_report.pdf">https://guidehouse.com/-/media/www/site/downloads/energy/2020/gh_european-hydrogen-backbone_report.pdf</a> (table 3, table 5)
		2040	1.7		
		2050	1.7		
NH3 (l) storage tank incl. liquefaction	CAPEX	2030	161.93	EUR/MWh_NH3	calculated based on Morgan E. 2013: <a href="https://doi.org/10.7275/11KT-3F59">doi:10.7275/11KT-3F59</a> , Fig. 55, Fig 58.
		2040	161.93		
		2050	161.93		
	lifetime	2030	20.0	years	Morgan E. 2013: <a href="https://doi.org/10.7275/11KT-3F59">doi:10.7275/11KT-3F59</a> , pg. 290
		2040	20.0		
		2050	20.0		
	FOM	2030	2.0	%/year	Guesstimate, based on H2 (l) storage tank.
		2040	2.0		
		2050	2.0		

Table 7 (continued).

technology	parameter	year	value	unit	source
Steam methane reforming	CAPEX	2030	470085.47	EUR/MW(H2)	International Energy Agency (2015): Technology Roadmap Hydrogen and Fuel Cells , table 15.
		2040	470085.47		
		2050	470085.47		
	lifetime	2030	30.0	years	International Energy Agency (2015): Technology Roadmap Hydrogen and Fuel Cells , table 15.
		2040	30.0		
		2050	30.0		
CH4 (g) fill compressor station	FOM	2030	3.0	% /year	International Energy Agency (2015): Technology Roadmap Hydrogen and Fuel Cells , table 15.
		2040	3.0		
		2050	3.0		
	CAPEX	2030	1498.95	EUR/MW(CH4)	Guesstimate, based on H2 (g) pipeline and fill compressor station cost.
		2040	1498.95		
		2050	1498.95		
HVDC overhead	lifetime	2030	20.0	years	Assume same as for H2 (g) fill compressor station.
		2040	20.0		
		2050	20.0		
	FOM	2030	1.7	% /year	Assume same as for H2 (g) fill compressor station.
		2040	1.7		
		2050	1.7		
HVDC overhead	CAPEX	2030	400.0	EUR/MW/km	Hagspiel
		2040	400.0		
		2050	400.0		
	lifetime	2030	40.0	years	Hagspiel
		2040	40.0		
		2050	40.0		

Table 7 (continued).

technology	parameter	year	value	unit	source	
HVDC sub-marine	FOM	2030	2.0		Hagspiel	
		2040	2.0			
		2050	2.0			
		CAPEX	2030	471.16	EUR/MW/km	Purvins et al. (2018): <a href="https://doi.org/10.1016/j.jclepro.2018.03.095">https://doi.org/10.1016/j.jclepro.2018.03.095</a> .
	2040		471.16			
	2050		471.16			
		lifetime	2030	40.0		Purvins et al. (2018): <a href="https://doi.org/10.1016/j.jclepro.2018.03.095">https://doi.org/10.1016/j.jclepro.2018.03.095</a> .
	2040		40.0	years		
	2050		40.0			
	LOHC dehydrogenation	FOM	2030	0.35		Purvins et al. (2018): <a href="https://doi.org/10.1016/j.jclepro.2018.03.095">https://doi.org/10.1016/j.jclepro.2018.03.095</a> .
2040			0.35			
2050			0.35			
		CAPEX	2030	759908.15	EUR/MW(H2)	Runge et al 2020, pg.8, <a href="https://papers.ssrn.com/abstract=3623514">https://papers.ssrn.com/abstract=3623514</a>
2040			759908.15			
2050			759908.15			
		lifetime	2030	20.0		Runge et al 2020, pg.8, <a href="https://papers.ssrn.com/abstract=3623514">https://papers.ssrn.com/abstract=3623514</a>
2040			20.0	years		
2050			20.0			
CH4 submarine pipeline		FOM	2030	3.0		Runge et al 2020, pg.8, <a href="https://papers.ssrn.com/abstract=3623514">https://papers.ssrn.com/abstract=3623514</a>
	2040		3.0			
	2050		3.0			
		CAPEX	2030	114.89	EUR/MW/km	Kaiser (2017): <a href="https://doi.org/10.1016/j.marpol.2017.05.003">10.1016/j.marpol.2017.05.003</a> .
	2040		114.89			
		2050	114.89			

Table 7 (continued).

technology	parameter	year	value	unit	source
	lifetime	2030	30.0		
		2040	30.0	years	d'Amore-Domenech et al (2021): 10.1016/j.apenergy.2021.116625 , supplementary material.
		2050	30.0		
	FOM	2030	3.0		
		2040	3.0	%/year	d'Amore-Domenech et al (2021): 10.1016/j.apenergy.2021.116625 , supplementary material.
		2050	3.0		
H2 liquefac-	CAPEX	2030	1497967.32		
tion		2040	1497967.32	EUR/MW(H2)	Reuß et al 2017: <a href="https://doi.org/10.1016/j.apenergy.2017.05.050">https://doi.org/10.1016/j.apenergy.2017.05.050</a> , Table 9 and equation in sec 3.0.
		2050	1497967.32		
	lifetime	2030	20.0		
		2040	20.0	years	Reuß et al 2017: <a href="https://doi.org/10.1016/j.apenergy.2017.05.050">https://doi.org/10.1016/j.apenergy.2017.05.050</a> , Table 9 and equation in sec 3.0.
		2050	20.0		
	FOM	2030	8.0		
		2040	8.0	%/year	Reuß et al 2017: <a href="https://doi.org/10.1016/j.apenergy.2017.05.050">https://doi.org/10.1016/j.apenergy.2017.05.050</a> , Table 9 and equation in sec 3.0.
		2050	8.0		

## S 10 Table Conversion efficiencies

**Table 8.** Energy and feedstock efficiency assumptions used. A machine readable version of these assumptions can be found in the Zenodo and GitHub repositories listed in the data availability section.

process	year	from	amount	to	amount	details and source
Ammonia cracker	all	ammonia (g)	3191.00 MWh(LHV)	hydrogen (g)	2186.00 MWh(LHV)	Assuming a integrated 200t/d cracking and purification facility. Electricity demand (316 MWh per 2186 MWh(LHV) H2 output) is assumed to also be ammonia LHV input which seems a fair assumption as the facility has options for a higher degree of integration according to the report).. Source: ENGIE et al (2020): Ammonia to Green Hydrogen Feasibility Study ( <a href="https://assets.publishing.service.gov.uk/government/uploads/system/uploads/attachment_data/file/880826/HS420_-_Ecuity_-_Ammonia_to_Green_Hydrogen.pdf">https://assets.publishing.service.gov.uk/government/uploads/system/uploads/attachment_data/file/880826/HS420_-_Ecuity_-_Ammonia_to_Green_Hydrogen.pdf</a> ), Fig. 10.
CCGT	all	hydrogen (g)	1.00 MWh(LHV)	electricity	0.58 MWh(el)	nan. Source: DEA technology data for electricity generation and district heating.
CH4 (g) fill compressor station	all	methane (g)	1.00 p.u.	methane compressed	0.97 p.u.	Assume same value as for booster stations, need to provide initial pressure increase.. Source: Guesstimate.
CH4 (g) pipeline	all	methane compressed	1.00 p.u.	methane compressed submarine	0.97 p.u.	Per 1000km for losses and boosting. Based on 0.4%/100 miles estimate.. Source: Asia Pacific Energy Research Centre (2000): <a href="https://aperc.or.jp/file/2010/9/26/Natural_Gas_Infrastructure_Development_Northeast_Asia_2000.pdf">https://aperc.or.jp/file/2010/9/26/Natural_Gas_Infrastructure_Development_Northeast_Asia_2000.pdf</a> , Table 49.
CH4 (g) pipeline decompressor	all	methane compressed	1.00 p.u.	methane (g)	1.00 p.u.	Arbitrary componenet for degrading gas pipeline content to regular methane (g) bus.. Source: Guesstimate.



Table 8 (continued).

process	year	from	amount	to	amount	details and source
CH4 (g) submarine pipeline	all	methane compressed submarine	1.00 p.u.	methane compressed	0.97 p.u.	Per 1000km for losses and boosting. Based on 0.4%/100 miles estimate.. Source: Asia Pacific Energy Research Centre (2000): <a href="https://aperc.or.jp/file/2010/9/26/Natural_Gas_Infrastructure_Development_Northeast_Asia_2000.pdf">https://aperc.or.jp/file/2010/9/26/Natural_Gas_Infrastructure_Development_Northeast_Asia_2000.pdf</a> , Table 49.
CH4 (l) storing and unstoring	all	methane (l)	0.42 t	methane storage	1.00 m3	Auxiliary efficiency. Storage units are usually per m3, component for unit conversion. Based on density of 422.36 kg/m3.. Source: <a href="https://encyclopedia.airliquide.com/methane">https://encyclopedia.airliquide.com/methane</a> (2021-02-10).
CH4 evaporation	all	methane (l)	1.00 t	methane (g)	13.61 MWh(LHV)	98% efficiency.. Source: Pospíšil et al. 2019: <a href="https://doi.org/10.1016/j.rser.2018.09.027">https://doi.org/10.1016/j.rser.2018.09.027</a> , Fig. 14.
CH4 liquefaction	all	electricity	0.50 MWh	methane (l)	1.00 t	Assuming 0.5 MWh/t(CH4) for refrigeration cycle based on Table 2 of source; cleaning of gas presumed unnecessary as it should be nearly pure CH4 (=SNG). Assuming energy required is only electricity which is for Table 3 in the source provided with efficiencies of 50% of LHV, making the numbers consistent with the numbers in Table 2.. Source: Pospíšil et al. 2019: <a href="https://doi.org/10.1016/j.rser.2018.09.027">https://doi.org/10.1016/j.rser.2018.09.027</a> , Table 2 and Table 3. Source 2: <a href="https://encyclopedia.airliquide.com/methane">https://encyclopedia.airliquide.com/methane</a> (2021-02-10).

Table 8 (continued).

process	year	from	amount	to	amount	details and source
CH4 liquefaction	all	methane (g)	13.89 MWh(LHV)	methane (l)	1.00 t	For refrigeration cycle, cleaning of gas presumed unnecessary as it should be nearly pure CH4 (=SNG). Assuming energy required is only electricity which is for Table 3 in the source provided with efficiencies of 50% of LHV, making the numbers consistent with the numbers in Table 2.. Source: Pospíšil et al. 2019: <a href="https://doi.org/10.1016/j.rser.2018.09.027">https://doi.org/10.1016/j.rser.2018.09.027</a> , Table 2 and Table 3.
CH4 storage pressor	all	electricity	0.19 MWh	methane storage	(g) 1.00 m3	Assuming ca. 7.5% of HHV (55.50 MJ/kg) based on multi-stage adiabatic compression and density of 167.758 kg/m3 .. Source: e.g. Bossel and Eliasson, "Energy and the Hydrogen Economy", pg. 10f. ( <a href="https://afdc.energy.gov/files/pdfs/hydrogen_economy_bossel(eli)jasson.pdf">https://afdc.energy.gov/files/pdfs/hydrogen_economy_bossel(eli)jasson.pdf</a> , 10.02:2021)
CH4 storage pressor	all	methane (g)	2.33 MWh(LHV)	methane storage	(g) 1.00 m3	Assuming methane density of 167.758 kg/m3 at 200 bar and LHV of 50 MJ/kg .. Source: <a href="https://www.unitrove.com/engineering/tools/gas/natural-gas-density">https://www.unitrove.com/engineering/tools/gas/natural-gas-density</a> (2021-02-10).
CH4 storage unstoring	all	methane storage	(g) 1.00 m3	methane (g)	2.33 MWh(LHV)	Reverse connection (auxiliary object) for CH4 (g) compressed storage.. Source: <a href="https://www.unitrove.com/engineering/tools/gas/natural-gas-density">https://www.unitrove.com/engineering/tools/gas/natural-gas-density</a> (2021-02-10).
CO2 evaporation	all	CO2 (l)	1.00 t	CO2 (g)	1.00 t	nan. Source: nan

Table 8 (continued).

process	year	from	amount	to	amount	details and source
CO2 liquefaction	all	CO2 (g)	1.00 t	CO2 (l)	1.00 t	Assuming a pure, humid, low-pressure input stream. Neglecting possible gross-effects of CO2 which might be cycled for the cooling process.. Source: Mitsubishi Heavy Industries Ltd. and IEA (2004): <a href="https://ieaghg.org/docs/General_Docs/Reports/PH4-30%20Ship%20Transport.pdf">https://ieaghg.org/docs/General_Docs/Reports/PH4-30%20Ship%20Transport.pdf</a> .
CO2 liquefaction	all	electricity	0.12 MWh	CO2 (l)	1.00 t	nan. Source: Mitsubishi Heavy Industries Ltd. and IEA (2004): <a href="https://ieaghg.org/docs/General_Docs/Reports/PH4-30%20Ship%20Transport.pdf">https://ieaghg.org/docs/General_Docs/Reports/PH4-30%20Ship%20Transport.pdf</a> .
CO2 liquefaction	all	heat	0.01 MWh	CO2 (l)	1.00 t	For drying purposes.. Source: Mitsubishi Heavy Industries Ltd. and IEA (2004): <a href="https://ieaghg.org/docs/General_Docs/Reports/PH4-30%20Ship%20Transport.pdf">https://ieaghg.org/docs/General_Docs/Reports/PH4-30%20Ship%20Transport.pdf</a> .
FT fuel storing and unstoring	all	FT fuel	9.80 MWh(LHV)	FT fuel storage	1.00 m3	Storage units are usually per m3, component for unit conversion. Based on FT fuel composition of 75% jet fuel/25% kerosene and a resulting density of 0.820 t/m3 = (0.75*0.820 + 0.25*0.821)t/m3 and LHV of 11.95 MWh/t = (0.75*11.95+0.25*11.95)MWh/t. Source: nan
Fischer-Tropsch	all	CO2 (g)	3.90 t	FT fuel	9.60 MWh(LHV)	Input per 1t FT fuels output. Product composition can be assumed to be 60% jet fuels/20% kerosene/20%LPG & fuel gases after upgrading, but we discard the LPG&fuel gas byproduct in this assumption – we're focusing on the liquid products. Liquid products both have LHVs of 11.95 Mwh/t.. Source: DEA technology data for Renewable fuels (2018): Hydrogen to Power.

Table 8 (continued).

process	year	from	amount	to	amount	details and source
Fischer-Tropsch	all	electricity	0.01 MWh	FT fuel	0.56 MWh(LHV)	Assuming limited CO2 conversion efficiency; can theoretically be improved upon. Output is 0.7 MWh product equivalent, of which we're neglecting 20% end products after upgrade: LPG and other fuel gases – we're only looking at liquid products here.. Source: DEA technology data for Renewable fuels (2018): Hydrogen to Power.
Fischer-Tropsch	all	hydrogen (g)	0.99 MWh(LHV)	FT fuel	0.56 MWh(LHV)	Output is 0.7 MWh product equivalent, we're neglecting 20% end products after upgrade: LPG and other fuel gases – we're only looking at liquid products here.. Source: DEA technology data for Renewable fuels (2018): Hydrogen to Power.
H2 (g) fill compressor station	all	hydrogen (g)	1.00 p.u.	hydrogen compressed	0.98 p.u.	Is 2.1%/1000km. Assuming self-consumption of H2 for filling compressors.. Source: Danish Energy Agency, Technology Data for Energy Transport (2021), Excel datasheet: H2 140.
H2 (g) pipeline	all	hydrogen (g) compressed	1.00 p.u.	hydrogen compressed submarine	0.98 p.u.	Is 2.1%/1000km. Assuming self-consumption of H2 for boosting, 6000 MW_HHV H2 pipeline.. Source: Danish Energy Agency, Technology Data for Energy Transport (2021), Excel datasheet: H2 140.
H2 (g) pipeline decompressor	all	hydrogen (g) compressed	1.00 p.u.	hydrogen (g)	1.00 p.u.	Arbitrary component for degrading gas pipeline content to regular hydrogen (g) bus.. Source: Guess.
H2 (g) submarine pipeline	all	hydrogen (g) compressed submarine	1.00 p.u.	hydrogen compressed	0.98 p.u.	2.1%/1000km. Assumed per 1000km here including H2 consumption for booster stations for 6000 MW_HHV pipeline.. Source: Danish Energy Agency, Technology Data for Energy Transport (2021), Excel datasheet: H2 140.

Table 8 (continued).

process	year	from	amount	to	amount	details and source
H2 evaporation	all	hydrogen (l)	1.00 MWh(LHV)	hydrogen (g)	1.00 MWh(LHV)	nan. Source: Heuser et al. 2019: <a href="https://doi.org/10.1016/j.ijhydene.2018.12.156">https://doi.org/10.1016/j.ijhydene.2018.12.156</a> , table 1.
H2 evaporation	all	electricity	0.60 MWh	hydrogen (g)	33.33 MWh(LHV)	.6 kWh/kg(H2). Source: Heuser et al. 2019: <a href="https://doi.org/10.1016/j.ijhydene.2018.12.156">https://doi.org/10.1016/j.ijhydene.2018.12.156</a> , table 1.
H2 liquefaction	all	hydrogen (g)	33.33 MWh(LHV)	hydrogen (l)	32.78 MWh(LHV)	'= 1.65% losses.. Source: Heuser et al. 2019: <a href="https://doi.org/10.1016/j.ijhydene.2018.12.156">https://doi.org/10.1016/j.ijhydene.2018.12.156</a> , table 1.
H2 liquefaction	all	electricity	6.78 MWh	hydrogen (l)	33.33 MWh(LHV)	6.78 kWh/kg(H2), considering H2 with LHV of 33.3333 MWh/t. Source: Heuser et al. 2019: <a href="https://doi.org/10.1016/j.ijhydene.2018.12.156">https://doi.org/10.1016/j.ijhydene.2018.12.156</a> , table 1.
H2 storage compressor	all	hydrogen (g)	1.00 MWh(LHV)	hydrogen (g) storage	1.00 MWh(LHV)	nan. Source: nan
H2 storage compressor	all	electricity	4.00 MWh	hydrogen (g) storage	33.33 MWh(LHV)	Storing into low pressure (<200 bar) type I tanks.. Source: DEA technology data for energy storage, pg. 82 .
H2 storage unstoring	all	hydrogen (g) storage	1.00 MWh(LHV)	hydrogen (g)	1.00 MWh(LHV)	Reverse connection (auxiliary object) for H2 (g) compressed storage.. Source: nan
HVDC inverter pair	all	hvdc	1.00 p.u.	electricity	0.99 p.u.	Losses for voltage source converters (VSCs). Line commutated converters (LLC) would be lower 0.7%.. Source: d'Amore-Domenech et al (2021): <a href="https://doi.org/10.1016/j.apenergy.2021.116625">10.1016/j.apenergy.2021.116625</a> .
HVDC inverter pair	all	electricity	1.00 p.u.	hvdc	0.99 p.u.	Losses for voltage source converters (VSCs). Line commutated converters (LLC) would be lower 0.7%.. Source: d'Amore-Domenech et al (2021): <a href="https://doi.org/10.1016/j.apenergy.2021.116625">10.1016/j.apenergy.2021.116625</a> .
HVDC overhead	all	hvdc	1.00 p.u.	hvdc submarine line	0.98 p.u.	Per 1000 km HVDC submarine line. Based on 7% losses for 3000 km.. Source: Purvins et al. (2018): <a href="https://doi.org/10.1016/j.jclepro.2018.03.095">https://doi.org/10.1016/j.jclepro.2018.03.095</a> .

Table 8 (continued).

process	year	from	amount	to	amount	details and source
HVDC submarine	all	hvdc submarine	1.00 p.u.	hvdc	0.98 p.u.	Per 1000 km HVDC submarine line. Based on 7% losses for 3000 km.. Source: Purvins et al. (2018): <a href="https://doi.org/10.1016/j.jclepro.2018.03.095">https://doi.org/10.1016/j.jclepro.2018.03.095</a> .
Haber-Bosch	all	hydrogen (g)	5.93 MWh(LHV)	ammonia (g)	5.17 MWh(LHV)	178 kg(H2) per t_NH3, LHV for both assumed.. Source: DECHEMA 2017: DECHEMA: Low carbon energy and feedstock for the European chemical industry , pg. 57.
Haber-Bosch	all	electricity	1.28 MWh	ammonia (g)	5.17 MWh(LHV)	Assume 5 GJ/t_NH3 for compressors and NH3 LHV = 5.16666 MWh/t_NH3.. Source: DECHEMA 2017: DECHEMA: Low carbon energy and feedstock for the European chemical industry , table 11.
Haber-Bosch	all	nitrogen (g)	0.82 t(N2)	ammonia (g)	5.17 MWh(LHV)	.33 MWh electricity are required for ASU per t_NH3, considering 0.4 MWh are required per t(N2) and LHV of NH3 of 5.1666 Mwh.. Source: DECHEMA 2017: DECHEMA: Low carbon energy and feedstock for the European chemical industry , pg. 57.
LOHC (used) loading	all	LOHC (used)	1.00 p.u.	berth LOHC (used)	1.00 p.u.	Auxiliary process: Unloading / loading of LOHC (loaded/unloaded) happen at the same time, assume no losses as handling of LOHC is rather simple.. Source: nan
LOHC (used) unloading	all	berth LOHC (used)	1.00 p.u.	LOHC (used)	1.00 p.u.	Auxiliary process: Unloading / loading of LOHC (loaded/unloaded) happen at the same time, assume no losses as handling of LOHC is rather simple.. Source: nan

Table 8 (continued).

process	year	from	amount	to	amount	details and source
LOHC dehydrogenation	all	LOHC (loaded)	1.00 t	hydrogen (g)	1.34 MWh(LHV)	1t loaded LOHC (H18-DBT) contains 5.6 wt-% H2 (=0.056 t(H2)). Considering LHV and worst case assumption: Dehydrogenation heat has to be provided by burning hydrogen (no other heat source available, loss of H2 due to burning are 28.07%). The small electricity demand (power = 0.2 MW) from the source also already included, which seems reasonable as in the source the energy flow is missing 1 MW_HHV of hydrogen which is enough to provide this electricity). Source: Niermann et al 2019: <a href="https://pubs.rsc.org/en/content/articlelanding/2019/ee/c8ee02700e">https://pubs.rsc.org/en/content/articlelanding/2019/ee/c8ee02700e</a> , fig. 6A and for depth-of-discharge: Runge et al 2020, pg. 7, <a href="https://papers.ssrn.com/abstract=3623514">https://papers.ssrn.com/abstract=3623514</a> .
LOHC dehydrogenation	all	LOHC (loaded)	1.00 t	LOHC (used)	0.94 t	Considering 5.6 wt-% H2 in loaded LOHC and LHV of H2.. Source: Runge et al 2020, pg. 7, <a href="https://papers.ssrn.com/abstract=3623514">https://papers.ssrn.com/abstract=3623514</a>
LOHC hydrogenation	all	LOHC (loaded)	0.94 t	LOHC (loaded)	1.00 t	LOHC (DBT) has loaded only 5.6%-wt H2 as rate of discharge is kept at ca. 90%.. Source: nan
LOHC hydrogenation	all	electricity	0.20 MWh	LOHC (loaded)	51.66 t	Flow in figures shows 0.2 MW for 114 MW_HHV = 96.4326 MW(LHV) = 2.89298 t hydrogen. At 5.6 wt-% effective H2 storage for loaded LOHC (H18-DBT), corresponds to 51.6604 t loaded LOHC .. Source: Niermann et al 2019: <a href="https://pubs.rsc.org/en/content/articlelanding/2019/ee/c8ee02700e">https://pubs.rsc.org/en/content/articlelanding/2019/ee/c8ee02700e</a> , fig. 6A .

Table 8 (continued).

process	year	from	amount	to	amount	details and source
LOHC hydrogenation	all	hydrogen (g)	1.87 MWh(LHV)	LOHC (loaded)	1.00 t	Considering 5.6 wt-% H2 in loaded LOHC and LHV of H2.. Source: Runge et al 2020, pg. 7, <a href="https://papers.ssrn.com/abstract=3623514">https://papers.ssrn.com/abstract=3623514</a>
LOHC treatment	all	LOHC (used)	1.00 p.u.	LOHC (loaded)	1.00 p.u.	A 0.01% penalty, as ca. 0.01% of LOHC have to be exchanged after each loading/unloading cycle.. Source: Runge et al 2020, pg. 7, <a href="https://papers.ssrn.com/abstract=3623514">https://papers.ssrn.com/abstract=3623514</a>
MeOH storing and un- storing	all	methanol	4.38 MWh(LHV)	methanol stor- age	1.00 m3	Storage units are usually per m3, component for unit conversion. Based on LHV and density of 792 kg/m3 .. Source: nan
Methanol steam re- forming	all	methanol	40.03 MWh(LHV)	hydrogen (g)	33.33 MWh(LHV)	Assuming per 1 t(H2) (with LHV 33.3333 MWh/t): 4.5 MWh(th) and 3.2 MWh(el) are required. We assume electricity can be substituted / provided with 1:1 as heat energy.. Source: Niermann et al (2021): 10.1016/j.rser.2020.110171 , table 4.
NH3 evaporation	all	ammonia (l)	1.00 p.u.	ammonia (g)	1.00 p.u.	guess. .. Source: nan
NH3 liquefaction	all	ammonia (g)	1.00 p.u.	ammonia (l)	1.00 p.u.	nan. Source: nan
NH3 liquefaction	all	electricity	0.00 p.u.	ammonia (l)	1.00 p.u.	0.1% of energy content of ammonia required for refrigeration.. Source: Dias et al. 2020: <a href="https://www.frontiersin.org/articles/10.3389/fmech.2020.00021/full">https://www.frontiersin.org/articles/10.3389/fmech.2020.00021/full</a>
Steam methane re- forming	all	methane (g)	123.61 MWh(LHV)	hydrogen (g)	83.33 MWh(LHV)	Large scale SMR plant producing 2.5 kg/s H2 output (assuming 33.3333 MWh/t H2 LHV), with 6.9 kg/s CH4 input (feedstock) and 2 kg/s CH4 input (energy). Neglecting water consumption.. Source: Keipi et al (2018): 10.1016/j.enconman.2017.12.063 , table 2.



Table 8 (continued).

process	year	from	amount	to	amount	details and source
air separation unit	all	electricity	0.25 MWh	nitrogen (g)	1.00 t(N <sub>2</sub> )	For consistency reasons use value from Danish Energy Agency. DEA also reports range of values (0.2-0.4 MWh/t(N <sub>2</sub> )) on pg. 288. Other efficiencies reported are even higher, e.g. 0.11 Mwh/t(N <sub>2</sub> ) from Morgan (2013): Techno-Economic Feasibility Study of Ammonia Plants Powered by Offshore Wind . Source: Danish Energy Agency, Technology Data for Renewable Fuels (04/2022), pg.288 .
battery inverter	all	battery	1.00 MWh	electricity	0.98 MWh	from DEA technology assumptions via technology-data repository. Source: DEA
battery inverter	all	electricity	1.00 MWh	battery	0.98 MWh	from DEA technology assumptions via technology-data repository. Source: DEA
direct air capture	all	heat	1.60 MWh(th)	CO <sub>2</sub> (g)	1.00 t	Thermal energy demand. Provided via air-sourced heat pumps. 1.6 MWh based on Beuttler et al (2019) for Climeworks LT DAC, alternative value: 1.102 MWh based on Breyer et al (2019).. Source: Beuttler et al (2019), alternative: Breyer et al (2019).
direct air capture	all	electricity	0.40 MWh	CO <sub>2</sub> (g)	1.00 t	0.4 MWh based on Beuttler et al (2019) for Climeworks LT DAC, alternative value: 0.182 MWh based on Breyer et al (2019). Should already include electricity for water scrubbing and compression (high quality CO <sub>2</sub> output).. Source: Beuttler et al (2019), alternative: Breyer et al (2019).
electrolysis	all	water	9.00 m <sup>3</sup>	hydrogen (g)	33.33 MWh(LHV)	Based on ideal conversion process of stoichiometric composition.. Source: -
electrolysis	2050	electricity	44.44 MWh	hydrogen (g)	33.33 MWh(LHV)	nan. Source: nan

Table 8 (continued).

process	year	from	amount	to	amount	details and source
electrolysis	2040	electricity	46.62 MWh	hydrogen (g)	33.33 MWh(LHV)	nan. Source: nan
electrolysis	2030	electricity	49.02 MWh	hydrogen (g)	33.33 MWh(LHV)	Alkaline electrolysis AEC. May potentially increase to 70-80% in the future.. Source: DEA (2021): Technology Data for Renewable Fuels, pg. 97.
electrolysis	2020	electricity	50.13 MWh	hydrogen (g)	33.33 MWh(LHV)	nan. Source: nan
industrial heat pump medium temperature	all	electricity	1.00 MW	heat	3.00 MW(th)	based on DEA technology data catalogue for industrial process heat (302, pg. 48, 2020). Conservative for 20°C → 100°C .. Source: DEA
methanation	all	hydrogen (g)	17.81 MWh(LHV)	methane (g)	13.89 MWh(LHV)	Additional H2 required for methanation process (2x H2 amount compared to stoichiometric conversion).. Source: Götz et al. (2016), fig. 11 .
methanation	all	CO2 (g)	2.75 t	methane (g)	13.89 MWh(LHV)	Based on ideal conversion process of stoichiometric composition (1 t CH4 contains 750 kg of carbon).. Source: nan
methanolisation	all	electricity	1.50 MWh	methanol	5.54 MWh(LHV)	nan. Source: DECHEMA 2017: DECHEMA: Low carbon energy and feedstock for the European chemical industry , pg. 65.
methanolisation	all	CO2 (g)	1.37 t	methanol	5.54 MWh(LHV)	nan. Source: DECHEMA 2017: DECHEMA: Low carbon energy and feedstock for the European chemical industry , pg. 66.
methanolisation	all	hydrogen (g)	6.30 MWh(LHV)	methanol	5.54 MWh(LHV)	189 kg(H2) per t_MeOH, LHV for both assumed.. Source: DECHEMA 2017: DECHEMA: Low carbon energy and feedstock for the European chemical industry , pg. 64.

Table 8 (continued).

process	year	from	amount	to	amount	details and source
seawater desalination	all	electricity	0.00 MWh	water	1.00 m3	Desalination using SWRO. Assume medium salinity of 35 Practical Salinity Units (PSUs) = 35 kg/m3. Source: Caldera et al 2016: Local cost of seawater RO desalination based on solar PV and windenergy: A global estimate. ( <a href="https://doi.org/10.1016/j.desal.2016.02.004">https://doi.org/10.1016/j.desal.2016.02.004</a> ), Fig. 4.

## S 11 Table Shipping parameters

**Table 9.** Shipping parameters used. A machine readable version of these assumptions can be found in the Zenodo and GitHub repositories listed in the data availability section.

ship type	parameter	unit	value	details and source
CH4 (1) transport ship	(un-) loading losses	%/transfer	0.70	Approx. 450 t for a 130 000m <sup>3</sup> tanker based on <a href="https://citeseerx.ist.psu.edu/viewdoc/download?doi=10.1.1.470.6116&amp;rep=rep1&amp;type=pdf">https://citeseerx.ist.psu.edu/viewdoc/download?doi=10.1.1.470.6116&amp;rep=rep1&amp;type=pdf</a> , pg. 59 f.
	(un-) loading time	h	48.00	Hurskainen 2019: <a href="https://cris.vtt.fi/en/publications/liquid-organic-hydrogen-carriers-lohc-concept-evaluation-and-tech">https://cris.vtt.fi/en/publications/liquid-organic-hydrogen-carriers-lohc-concept-evaluation-and-tech</a> , table 8.
	average speed	km/h	37.00	Hurskainen 2019: <a href="https://cris.vtt.fi/en/publications/liquid-organic-hydrogen-carriers-lohc-concept-evaluation-and-tech">https://cris.vtt.fi/en/publications/liquid-organic-hydrogen-carriers-lohc-concept-evaluation-and-tech</a> , table 8.
	boil-off capacity	%/h MWh_LHV	0.01 809 717.00	ca. 0.1% per day. Lowell et al. 2013, pg. 14. Based on CH4 LHV of 13.8888 MWh/t_CH4 and 58300 t capacity. Calculated.
	energy demand	MWh/km	0.57	Taken from source (average fuel demand / average cruising speed) without 50% efficiency. Calculated based on Hurskainen 2019: <a href="https://cris.vtt.fi/en/publications/liquid-organic-hydrogen-carriers-lohc-concept-evaluation-and-tech">https://cris.vtt.fi/en/publications/liquid-organic-hydrogen-carriers-lohc-concept-evaluation-and-tech</a> , table 8.
	(un-) loading losses (un-) loading time	%/transfer h	2.00 48.00	Runge et al 2020, pg. 8. Hurskainen 2019: <a href="https://cris.vtt.fi/en/publications/liquid-organic-hydrogen-carriers-lohc-concept-evaluation-and-tech">https://cris.vtt.fi/en/publications/liquid-organic-hydrogen-carriers-lohc-concept-evaluation-and-tech</a> , table 8.
H2 (1) transport ship	(un-) loading losses (un-) loading time	%/transfer h	2.00 48.00	Runge et al 2020, pg. 8. Hurskainen 2019: <a href="https://cris.vtt.fi/en/publications/liquid-organic-hydrogen-carriers-lohc-concept-evaluation-and-tech">https://cris.vtt.fi/en/publications/liquid-organic-hydrogen-carriers-lohc-concept-evaluation-and-tech</a> , table 8.

Table 9 (continued).

ship type	parameter	unit	value	details and source
	average speed	km/h	30.00	Hurskainen 2019: <a href="https://cris.vtt.fi/en/publications/liquid-organic-hydrogen-carriers-lohc-concept-evaluation-and-tech">https://cris.vtt.fi/en/publications/liquid-organic-hydrogen-carriers-lohc-concept-evaluation-and-tech</a> , table 8.
	boil-off	%/h	0.01	IH2 tank losses (boil off) per day: 0.2%Runge et al 2020 pg. 8. and IEA (2019): The Future of Hydrogen, Assumptions Annex, pg. 7.
	capacity	MWh_LHV	378 666.00	Corresponds to 11360 t H2 (l) with LHV of 33.3333 MWh/t_H2Cihlar et al 2020 based on IEA 2019, Table 3-B
	energy demand	MWh/km	0.41	IEA (2019): The Future of Hydrogen, Annex Assumptions (Transmission)
LOHC transport ship	(un-) loading losses	%/transfer	0.00	Guestimate, transfer of simple non-cryogenic fluid.
	(un-) loading time	h	48.00	Hurskainen 2019: <a href="https://cris.vtt.fi/en/publications/liquid-organic-hydrogen-carriers-lohc-concept-evaluation-and-tech">https://cris.vtt.fi/en/publications/liquid-organic-hydrogen-carriers-lohc-concept-evaluation-and-tech</a> , table 8.
	average speed	km/h	27.80	Hurskainen 2019: <a href="https://cris.vtt.fi/en/publications/liquid-organic-hydrogen-carriers-lohc-concept-evaluation-and-tech">https://cris.vtt.fi/en/publications/liquid-organic-hydrogen-carriers-lohc-concept-evaluation-and-tech</a> , table 8.
	boil-off	%/h	0.00	Guestimate, simple non-cryogenic fluid in closed tanks.
	capacity	MWh_LHV	140 000.00	Assuming DBT as LOHC. Only ca. 90% rate of discharge of H18-DBT recommended, e.g. 1.87 MWh/t effective energy density (5.6 wt-% hydrogen, 33.3333 MWh/t_H2 LHV). 75000 t capacity for LOHC (H18-DBT form). Calculated, based on Runge et al 2020, pg. 7, <a href="https://papers.ssrn.com/abstract=3623514">https://papers.ssrn.com/abstract=3623514</a>

Table 9 (continued).

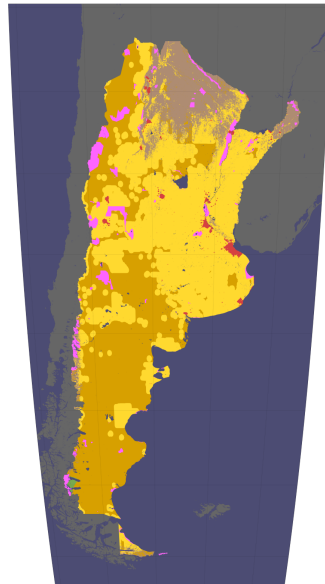
ship type	parameter	unit	value	details and source
	energy demand	MWh/km	0.24	Taken from source (average fuel demand / average cruising speed) without 50% efficiency. Calculated based on Hurskainen 2019: <a href="https://cris.vtt.fi/en/publications/liquid-organic-hydrogen-carriers-lohc-concept-evaluation-and-tech">https://cris.vtt.fi/en/publications/liquid-organic-hydrogen-carriers-lohc-concept-evaluation-and-tech</a> , table 8.
MeOH transport ship	(un-) loading losses	%/transfer	0.00	Guestimate, transfer of simple non-cryogenic fluid.
	(un-) loading time	h	48.00	Assume same as for LOHC.
	average speed	km/h	27.80	Assume same as for LOHC.
	boil-off	%/h	0.00	Guestimate, simple non-cryogenic fluid in closed tanks.
	capacity	MWh_LHV	415 208.00	Based on MeOH LHV of 5.53611 MWh/t_MeOH and 75000t capacity. Calculated.
NH3 (l) transport ship	energy demand	MWh/km	0.24	Assume same as for LOHC.
	(un-) loading losses	%/transfer	0.00	Guestimate, possibly negligible losses due to relatively close to ambient transport temperature.
	(un-) loading time	h	48.00	Assume same as for CH4 (l).
	average speed	km/h	37.00	Assume same as for CH4 (l).
	boil-off	%/h	0.00	Guestimate, possibly negligible losses due to relatively close to ambient transport temperature.
	capacity	MWh_LHV	273 830.00	Based on NH3 LHV of 5.1666 MWh/t_NH3 and 53000 t capacity. Calculated.
FT fuel transport ship	energy demand	MWh/km	0.57	Assume same as for CH4 (l).
	(un-) loading losses	%/transfer	0.00	Guestimate, transfer of simple non-cryogenic fluid.
	(un-) loading time	h	48.00	Assume same as for LOHC.
	average speed	km/h	27.80	Assume same as for LOHC.
	boil-off	%/h	0.00	Guestimate, simple non-cryogenic fluid in closed tanks.

Table 9 (continued).

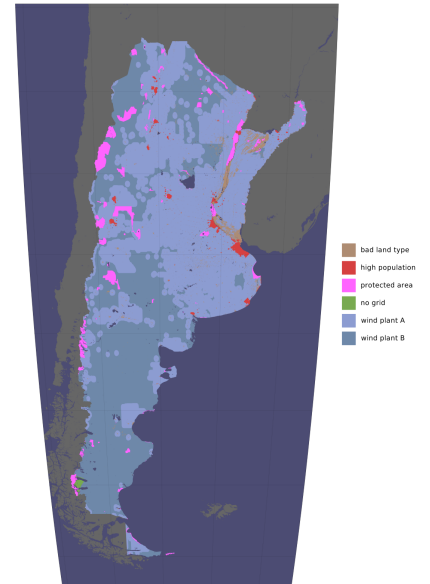
ship type	parameter	unit	value	details and source
	capacity	MWh_LHV	896 250.00	Based on FT fuel LHV of 11.95 MWh/t_FTfuel and 75000t capacity. Calculated.
	energy demand	MWh/km	0.24	Assume same as for LOHC.

## S 12 Figs RES eligible area masks

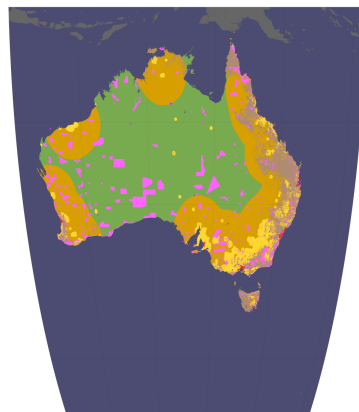
The following figures show the eligible areas considered for onshore wind and PV RES for the countries while determining their RES potentials. For this study no differentiation between 'plant A' and 'plant B' was used. Both eligible types of area were combined to the total eligible area for each technology.



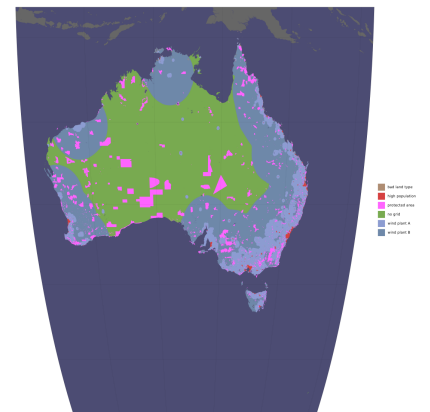
(a) PV mask for Argentina.



(b) Onshore wind mask for Argentina.

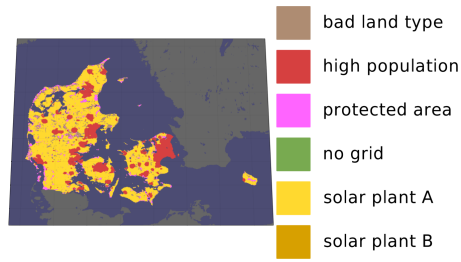


(c) PV mask for Australia.

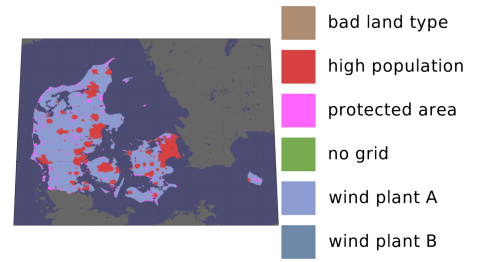


(d) Onshore wind mask for Australia.

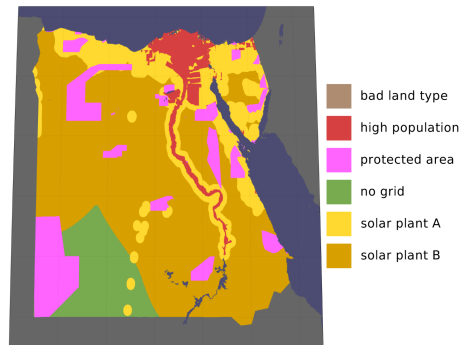




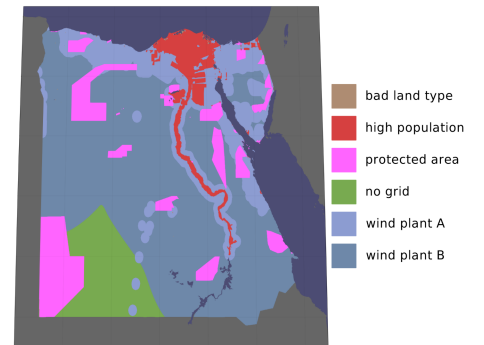
(e) PV mask for Denmark.



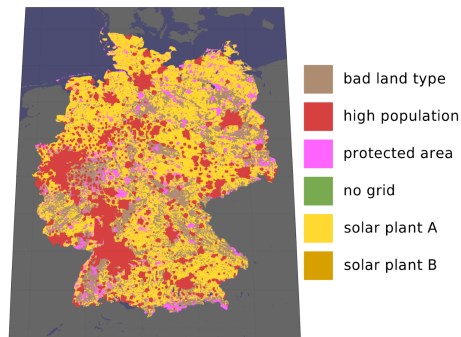
(f) Onshore wind mask for Denmark.



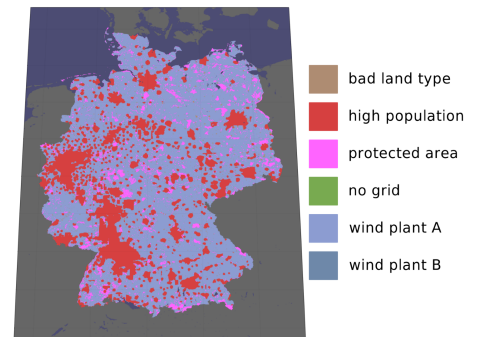
(g) PV mask for Egypt.



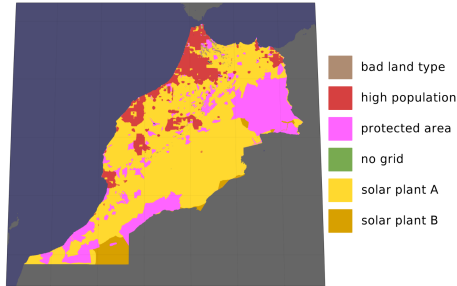
(h) Onshore wind mask for Egypt.



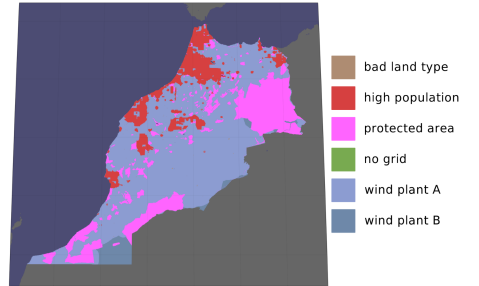
(i) PV mask for Germany.



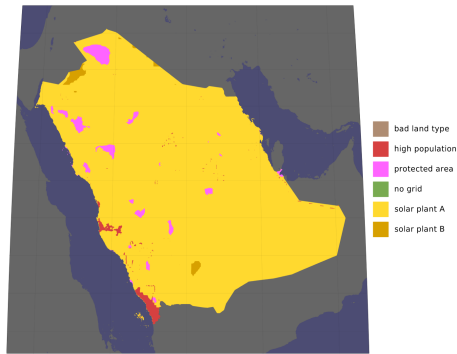
(j) Onshore wind mask for Germany.



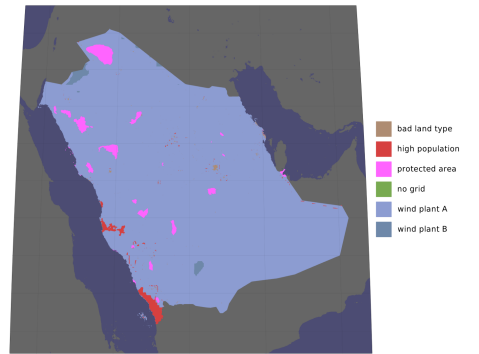
(k) PV mask for Morocco.



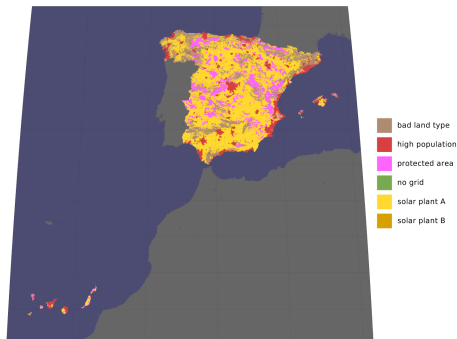
(l) Onshore wind mask for Morocco.



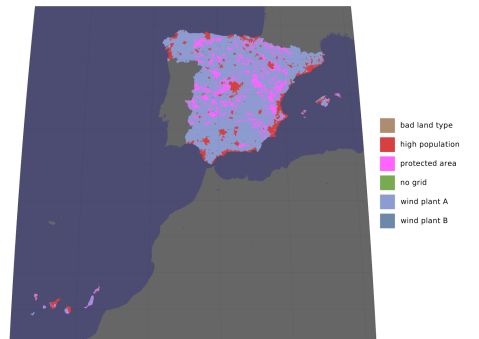
(m) PV mask for Saudi Arabia.



(n) Onshore wind mask for Saudi Arabia.



(o) PV mask for Spain.



(p) Onshore wind mask for Spain.

**Fig 44.** RES area masks for all exporting countries considered and onshore wind as well as PV. No differentiation was made between ‘plant A’ and ‘plant B’ locations in this study.

## **S 13 Appendix Data and code availability**

Model results including technology and cost assumptions are available on Zenodo ([doi:10.5281/zenodo.7293102](https://doi.org/10.5281/zenodo.7293102)). The model is available in this GitHub repository under GPL-3.0-or-later and Creative Commons licenses. Technology cost assumptions are also available in this dedicated GitHub repository under similar license.