



Degrees and Gaps: Tight Complexity Results of General Factor Problems Parameterized by Treewidth and Cutwidth

Dániel Marx ✉

CISPA Helmholtz Center for Information Security, Saarland Informatics Campus, Germany

Govind S. Sankar ✉ 

Indian Institute of Technology Madras, Chennai, India

Philipp Schepper ✉ 

CISPA Helmholtz Center for Information Security, Saarland Informatics Campus, Germany

Saarbrücken Graduate School of Computer Science, Saarland Informatics Campus, Germany

Abstract

In the GENERAL FACTOR problem, we are given an undirected graph G and for each vertex $v \in V(G)$ a finite set B_v of non-negative integers. The task is to decide if there is a subset $S \subseteq E(G)$ such that $\deg_S(v) \in B_v$ for all vertices v of G . Define the max-gap of a finite integer set B to be the largest $d \geq 0$ such that there is an $a \geq 0$ with $[a, a + d + 1] \cap B = \{a, a + d + 1\}$. Cornuéjols showed in 1988 that if the max-gap of all sets B_v is at most 1, then the decision version of GENERAL FACTOR is polynomial-time solvable. This result was extended 2018 by Dudycz and Paluch for the optimization (i.e. minimization and maximization) versions. We present a general algorithm counting the number of solutions of a certain size in time $(M + 1)^{\text{tw}} n^{\mathcal{O}(1)}$, given a tree decomposition of width tw , where M is the maximum integer over all B_v . By using convolution techniques from van Rooij (2020), we improve upon the previous $(M + 1)^{3\text{tw}} n^{\mathcal{O}(1)}$ time algorithm by Arulsevan et al. from 2018.

We prove that this algorithm is essentially optimal for all cases that are not trivial or polynomial time solvable for the decision, minimization or maximization versions. Our lower bounds show that such an improvement is not even possible for B -FACTOR, which is GENERAL FACTOR on graphs where all sets B_v agree with the fixed set B . We show that for every fixed B where the problem is NP-hard, our $(\max B + 1)^{\text{tw}} n^{\mathcal{O}(1)}$ algorithm cannot be significantly improved: assuming the STRONG EXPONENTIAL TIME HYPOTHESIS (SETH), no algorithm can solve B -FACTOR in time $(\max B + 1 - \epsilon)^{\text{tw}} n^{\mathcal{O}(1)}$ for any $\epsilon > 0$. We extend this bound to the counting version of B -FACTOR for arbitrary, non-trivial sets B , assuming #SETH.

We also investigate the parameterization of the problem by cutwidth. Unlike for treewidth, having a larger set B does not appear to make the problem harder: we give a $2^{\text{cutw}} n^{\mathcal{O}(1)}$ algorithm for any B and provide a matching lower bound that this is optimal for the NP-hard cases.

2012 ACM Subject Classification Theory of computation \rightarrow Parameterized complexity and exact algorithms

Keywords and phrases General Factor, General Matching, Treewidth, Cutwidth

Related Version Full version of the paper accepted for ICALP21.

Funding Research supported by the European Research Council (ERC) consolidator grant No. 725978 SYSTEMATICGRAPH.

1 Introduction

Matching problems for graphs are widely studied in computer science [1, 9, 13, 21, 22, 28, 32, 37, 39, 41]. The most prominent ones are PERFECT MATCHING (PERFMATCH) and MAXIMUM-WEIGHT MATCHING. Both problems have long known polynomial-time algorithms [22, 39] and various generalizations were investigated in the graph-theory literature. These range from simple extensions such as the k -factor problem for a positive integer k (every

vertex has to be incident to exactly k edges) [2, 32], to more complex ones, where the vertices are assigned intervals [41]. These problems are generally solved by a reduction to PERFMATCH by replacing the vertices of the original instance with suitable gadgets. Lovász introduced a general version of these problems which we call GENERAL FACTOR [37]:

► **Definition 1.1** (GENERAL FACTOR (GENFAC)). *Let $G = (V, E)$ be an undirected node labeled graph where the label of a vertex v is a set $B_v \subseteq \mathbb{N}$. We say $S \subseteq E$ is a solution if $\deg_S(v) \in B_v$ for all $v \in V$. GENFAC is the problem of deciding whether G has a solution.*

The minimization and maximization versions of GENFAC are the problems of finding the size of the solution with smallest and largest cardinality, respectively.

Polynomial-Time Solvable Cases. For several cases (e.g. k -factor, sets are intervals) reductions to PERFMATCH are known, leading directly to polynomial-time algorithms. Cornuéjols analyzed the complexity of the general problem to identify properties of the sets that make the problem easier to solve [9]. For this he introduced the *gap* of a set: A gap is a finite sequence of consecutive integers not contained in the set but whose boundaries are contained in the set (cf. Definition 2.2). For example, the set $\{1, 5, 6, 8\}$ has gaps of size 3 and 1. For a set S , $\text{max-gap } S$ denotes the size of its largest gap. Cornuéjols showed that if the max-gaps of all sets are at most 1, then the problem is polynomial-time solvable. Later this result was extended to the maximization and minimization (optimization) versions of GENFAC.

► **Theorem 1.2** ([9, 21]). *The decision, maximization, and minimization version of GENFAC can be solved in polynomial time on arbitrary graphs if for all nodes v , $\text{max-gap } B_v \leq 1$.*

On the other side Cornuéjols proved GENFAC to be NP-complete if there are nodes with a gap of size two, namely $\{1\}$ and $\{0, 3\}$, by a reduction from *exact 3-cover*. More generally, it can be deduced from the work of Feder [25] that GENFAC becomes NP-complete whenever every set B_v is restricted to be the same fixed set B having gap size at least two.

Treewidth. This paper is part of a long sequence of works studying problems parameterized by treewidth and related metrics like cutwidth or cliquewidth. Treewidth received significant attention as many NP-hard problems like COLOURING, INDEPENDENT SET, or DOMINATING SET (see [4] for a survey) are polynomial-time solvable on bounded-treewidth graphs. Courcelle’s Theorem [10, 11] shows that a large class of graph problems can be solved in linear time on graphs of bounded treewidth. Recent developments on the algorithmic side include various techniques such as Cut & Count [17, 40], rank-based dynamic programming [3, 16, 26] and fast subset convolution [45, 46]. On the negative side, there have been a large number of results showing lower bounds based on complexity assumptions such as the EXPONENTIAL TIME HYPOTHESIS (ETH) and the STRONG EXPONENTIAL TIME HYPOTHESIS (SETH) [7, 14, 35, 36]. For many such problems, their optimal algorithms utilize some form of dynamic programming, where a “state” is stored for every node in the tree decomposition. The number of such states determines the running time of the algorithms, seemingly suggesting that this number is a natural barrier to the running time of any algorithm. Typically, the conditional lower bounds confirm this intuition by showing that no algorithm can break this barrier.

New Faster Algorithms. One of the first algorithmic results for GENFAC parameterized by treewidth was given by Arulsevan et al. [1]. They present an algorithm for a restricted version of the problem where the sets contain zero and an interval of integers. This algorithm

can be easily extended to handle arbitrary instances while preserving the running time of $(M + 1)^{3\text{tw}}n^{\mathcal{O}(1)}$ where M is the maximum over all sets assigned to the vertices. Their algorithm is based on the standard dynamic programming approach when parameterizing by treewidth, i.e. it considers all possible states for each node of the tree decomposition. The number of states in the dynamic programming is about $(M + 1)^{\text{tw}+1}$: one needs to keep track of the degree of the partial solution at each of the at most $\text{tw} + 1$ vertices of a bag of the tree decomposition, and this degree can be between 0 and M . Therefore, a natural question is whether the algorithm can be improved to obtain an $(M + 1)^{\text{tw}}n^{\mathcal{O}(1)}$ running time, matching the number of states. Such improvements are known for other problems, for example for DOMINATING SET and #PERFMATCH in [46]. We base our algorithm on the same dynamic programming idea, but instead of processing all combination of states at join nodes, we make use of the technique of van Rooij [45] to compute fast convolutions, avoiding this bottle-neck of the computation. The algorithm can be easily generalized to the optimization and counting versions as well; to unify the results, we present the algorithm in a way that counts all solutions of a certain given size.

► **Theorem 1.3.** *Given a GENFAC instance G and a tree decomposition of width tw . Let $M = \max_{v \in V(G)} \max B_v$. Then for all s , we can count the solutions of size exactly s in time $(M + 1)^{\text{tw}}n^{\mathcal{O}(1)}$.*

As we shall see, this algorithm is essentially optimal for every fixed B where B -FACTOR is NP-hard. Note that in order to obtain this optimal running time, we have to use a well-known, but non-trivial technique; beyond that, our algorithm does not provide new insights into the problem.

Tight Lower Bounds for the Decision Version. To investigate how the properties of the sets B_v influence the complexity of the problem, we give conditional lower bounds based on SETH for the restrictive B -FACTOR problem, where all sets have to be the same fixed set B . By a careful design our lower bounds also hold for a parameterization by *pathwidth*. Note that if the set is not fixed, Arulselvan et al. showed that GENFAC is W[1]-hard when parameterizing only by treewidth [1]. Thus, it is reasonable to focus only on the cases with fixed sets to prove tight lower bounds.

► **Theorem 1.4 (Lower Bound for Decision Version).** *Let $B \subseteq \mathbb{N}$ be a fixed, finite set with $0 \notin B$ and $\max\text{-gap } B > 1$. If, given a path decomposition of width pw , B -FACTOR can be solved in time $(\max B + 1 - \epsilon)^{\text{pw}}n^{\mathcal{O}(1)}$ for some $\epsilon > 0$ even on graphs with degree at most $2 \max B$, then SETH is false.*

The same result immediately follows for treewidth as for all graphs the pathwidth forms an upper-bound for the treewidth [15]. Hence, our algorithm is optimal not only for GENFAC but also for B -FACTOR parameterized by treewidth and does not allow major improvements.

Tight Lower Bounds for the Optimization Version. It suffices to consider the maximization version with $\max\text{-gap } B > 1$ and $0 \in B$ for the optimization version. The other cases are either polynomial-time solvable ($\max\text{-gap } B \leq 1$ or $0 \in B$ for MIN- B -FACTOR) [21] or the hardness directly follows from the lower bound for the decision version. Observe that the assumption $0 \in B$ does not make the problem trivially solvable. For these cases, we give essentially the same lower bound as for the decision version. Again the bound rules out that we can improve the given algorithm substantially; the running time is essentially optimal.

► **Theorem 1.5** (Lower Bound for Maximization Version). *Let $B \subseteq \mathbb{N}$ be a fixed, finite set with $\max\text{-gap } B > 1$. If, given a path decomposition of width pw , $\text{MAX-}B\text{-FACTOR}$ can be solved in time $(\max B + 1 - \epsilon)^{\text{pw}n^{\mathcal{O}(1)}}$ for some $\epsilon > 0$ even on graphs with degree at most $2 \max B$, then SETH is false.*

Counting. It is well known that PERFMATCH can be solved in polynomial time [22]. Surprisingly, Valiant showed in [42] that *counting* the number of perfect matchings of a graph is as hard as counting satisfying assignment of a boolean formula. This is curious as (presumably) no polynomial-time algorithm for the decision version of the latter problem exists. The observation then led to the definition of the complexity class $\#\text{P}$ containing the counting problems whose corresponding decision version lies in NP . Indeed, this feature that some structures are easy to find but hard to count appears in our work as well. Apart from $\#\text{PERFMATCH}$, which itself is $\#\{1\}\text{-FACTOR}$, our results imply that $\#B\text{-FACTOR}$ is $\#\text{P}$ -hard for any finite, fixed B . This contrasts with the decision version, where the problem is easy when $\max\text{-gap } B \leq 1$. Over and above showing $\#\text{P}$ -hardness, we show a tight lower bound for $\#B\text{-FACTOR}$, assuming $\#\text{SETH}$, the counting version of SETH . There have been several results [12, 13, 20] based on $\#\text{SETH}$ and $\#\text{ETH}$. Some of our constructions were inspired by one such work by Curticapean and Marx [13], where they show a lower bound of $(2 - \epsilon)^{\text{pw}n^{\mathcal{O}(1)}}$ for $\#\text{PERFMATCH}$ on graphs assuming $\#\text{SETH}$. We prove a wide generalization of this result by providing a tight lower bound for every $\#B\text{-FACTOR}$ problem. As for the optimization and decision version, our algorithm shows the tightness of this lower bound.

► **Theorem 1.6** (Lower Bound for Counting Version). *Let $B \subseteq \mathbb{N}$ be a nonempty, fixed, and finite set such that $B \neq \{0\}$. If, given a path decomposition of width pw , $\#B\text{-FACTOR}$ can be solved in time $(\max B + 1 - \epsilon)^{\text{pw}n^{\mathcal{O}(1)}}$ for some $\epsilon > 0$ even on graphs with degree at most $2 \max B + 6$, then $\#\text{SETH}$ is false.*

We also investigate $\#\text{MAX-}B\text{-FACTOR}$, the problem of counting maximum-sized solutions. The following argument shows that $\#\{\max B\}\text{-FACTOR}$ can be reduced to $\#\text{MAX-}B\text{-FACTOR}$ without increasing pathwidth, hence Theorem 1.6 gives a lower bound of $(\max B + 1 - \epsilon)^{\text{pw}n^{\mathcal{O}(1)}}$. Consider an instance of $\#\{\max B\}\text{-FACTOR}$ on a graph G of pathwidth pw . In polynomial time, check if G has some $\{\max B\}\text{-FACTOR}$ [9]. If it does not, then output 0. If it does, then solve $\#\text{MAX-}B\text{-FACTOR}$ on G . As now every maximum-sized $B\text{-FACTOR}$ is actually a $\{\max B\}\text{-FACTOR}$, this indeed solves the $\#\{\max B\}\text{-FACTOR}$ problem.

► **Corollary 1.7.** *Let $B \subseteq \mathbb{N}$ be a fixed, finite set such that $B \neq \{0\}$. If, given a path decomposition of width pw , $\#\text{MAX-}B\text{-FACTOR}$ can be solved in time $(\max B + 1 - \epsilon)^{\text{pw}n^{\mathcal{O}(1)}}$ for some $\epsilon > 0$ even on graphs with degree at most $2 \max B + 6$, then SETH is false.*

We leave open the question of a tight lower bound for the minimization version.

Parameterizing by Cutwidth. As previously mentioned, pathwidth and treewidth are not the only parameters used in parameterized complexity. Cutwidth, cliquewidth, genus, and crossing number are only a few more examples of a vast class of possible parameters. For cutwidth, we consider linear layouts of graphs with n vertices, which are just enumerations v_1, \dots, v_n of all graph vertices. Then the cut after vertex v_i consists of all edges in G with one end in $\{v_1, \dots, v_i\}$ and the other end in $\{v_{i+1}, \dots, v_n\}$. The *cutwidth* of a linear layout is the maximum over the size of the cut after every v_i . The cutwidth cutw of a graph is the minimum over the cutwidths of all possible linear layouts. As $\text{tw} \leq \text{pw} \leq \text{cutw}$, it is not

completely surprising that we get different upper bounds for cutwidth. But now a simple dynamic program suffices to prove the upper bound for this case. Further, the running time of the algorithm is independent from the maximum of the set B .

► **Theorem 1.8.** *Given a linear layout of a GENFAC instance G with width cutw , for all s we can count the number of solutions of size exactly s in time $2^{\text{cutw}} n^{\mathcal{O}(1)}$.*

This again matches the number of states for each cut of the linear layout. Like before, we omit the algorithm here and refer the reader to the full version. Note that the running times appearing in Theorems 1.3 and 1.8 cannot be directly compared: the base is lower when parameterized by cutwidth, but cutwidth can be larger than treewidth.

By a modified high-level construction, we show matching lower bounds based on SETH for the decision and optimization versions, and, based on #SETH, for the counting version.

► **Theorem 1.9 (Lower Bounds for Cutwidth).** *Let $B \subseteq \mathbb{N}$ be a fixed, nonempty set of finite size. If, given a linear layout of width cutw , the following problems can be solved in time $(2 - \epsilon)^{\text{cutw}} n^{\mathcal{O}(1)}$ for any $\epsilon > 0$ even on graphs with degree at most $2 \max B + 6$, then SETH (resp. #SETH) fails: (1) B -FACTOR and MIN- B -FACTOR if $0 \notin B$ and $\max\text{-gap } B > 1$, (2) MAX- B -FACTOR if $\max\text{-gap } B > 1$, and (3) # B -FACTOR if $B \neq \{0\}$.*

1.1 Techniques

NP-Hardness. Existing results that explicitly show hardness for the GENFAC (or B -FACTOR) problem have been limited. For example, Cornuéjols showed in [9] the hardness only for the case when the lists are either $\{0, 3\}$ or $\{1\}$. However, as we discuss below, the results from Feder in [25] implicitly show that the B -FACTOR problem is NP-hard when the allowed lists have a gap of size more than 1. Feder [25] considered the complexity of Boolean CSP instances where each variable appears in two constraint and each constraint enforces a relation R . As pointed out by Dalmau and Ford in [19], the results in [25] show that when R does not form a Δ -matroid, then the problem is NP-hard.

We say that the relation R is *symmetric* if membership of a tuple in R depends only on the Hamming weight of the tuple, i.e., R contains exactly those tuples that have Hamming weight from a set B . In this case, a CSP instance where each variable appears in two R -constraints can be naturally represented as a B -FACTOR instance: the vertices correspond to the constraints and the edges correspond to the variables.¹ It can be observed that if B has gaps of size more than 1, then the corresponding symmetric relation R cannot form a Δ -matroid. This, combined with the results from [25] show the NP-completeness of B -FACTOR when $\max\text{-gap } B > 1$.

High-level Structure. The known NP-hardness proofs do not fully utilize the capacity for GENFAC to represent relations. For example, [25] argues that just being able to represent the relation $\{(x, y, z) : x = y = z\}$ is enough to ensure NP-hardness. Our lower bounds use the fact that GENFAC (and even B -FACTOR) can represent almost *any* relation. We have two main steps. We first reduce from SAT to the intermediate problem B -FACTOR WITH RELATIONS (B -FACTOR ^{\mathcal{R}}). This is an extension of B -FACTOR where we can additionally assign (almost) arbitrary relations to the vertices of the graph and not only the set B (cf.

¹ There is a minor technicality here: the resulting graph can be a multigraph. This can be resolved by placing vertices with list $\{0, 2\}$ on the parallel edges. For the case where $\max\text{-gap } B > 1$, such vertices can be *realized* (see Lemma 1.10) by vertices with list B .

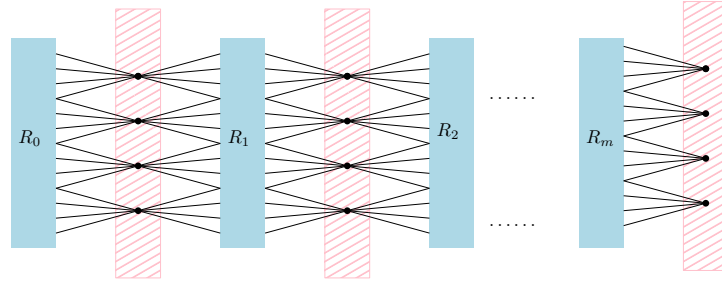

■ **Figure 1** Pink boxes represent the vertical columns of vertices that store the state of the variables. Blue boxes labelled R_i verify that the i th clause is satisfied. Here, m is the number of clauses.

Definition 4.1). This reduction step is similar to previous lower bound constructions [36]. In the second step, we reduce from B -FACTOR $^{\mathcal{R}}$ to B -FACTOR by replacing each relation and its node by a graph expressing the required relation.

For both the pathwidth and cutwidth lower bounds, our broad-strokes idea is the same. See Figure 1 for an illustration. For a given SAT instance, we use vertical columns of high-degree vertices to store the assignment (or “state”) of the variables. This state is stored as the number of edges to its left that are selected in any solution. When parameterizing by cutwidth, this process is easier; we can afford one vertex for each variable of the SAT instance since we are only looking for a lower bound of $(2 - \epsilon)^{\text{cutw}} n^{\mathcal{O}(1)}$. However, in the pathwidth case, we want to show a lowerbound of $(\max B + 1 - \epsilon)^{\text{pw}} n^{\mathcal{O}(1)}$. This means that our constructed graph should have pathwidth $\frac{n}{\log(\max B + 1)} + \mathcal{O}(1)$. We achieve this by grouping q variables together and associate a set of g vertices with each group, where 2^q is roughly $(\max B + 1)^g$. By this the lower bound we get is the number of assignments or states that we can store for a given pathwidth. This directly connects to the dynamic-programming algorithms on path decompositions, where the running time is determined by how many states each node has to store. Thus, our vertical columns represent several of the bags of the path decomposition.

Once we are able to propagate the information about the assignments through these vertical columns, we use some relations placed between them to verify that the assignment satisfies all the clauses. Afterwards, we exploit the (large) gap of the set B and replace the relations by vertices with list B such that we finally get a B -FACTOR instance.

Realizations for the Decision Version. We do this step from B -FACTOR $^{\mathcal{R}}$ to B -FACTOR through what we call *realizations*. We say that we can realize a relation $R \subseteq \{0, 1\}^d$ if we have a gadget G with d *dangling edges*, exactly one corresponding to each coordinate of the relation, such that G behaves in some special way. These dangling edges (say D) have one endpoint in G and another endpoint outside of G . These edges act as inputs to the function f . We say that the function is realized iff the only solutions are those that pick $D' \subseteq D$ such that $D' \in R$. For a more rigorous definition, see Section 5. For example, when showing the hardness for the decision version of the problem, we use the following key result. We say that a Boolean function is *even* if it is zero for all inputs with odd Hamming weight.

► **Lemma 1.10.** *Let $R \subseteq 2^{[d]}$ be an even Boolean relation. Then for every fixed, finite set $B \subseteq \mathbb{N}$ with $\max\text{-gap } B > 1$ and $0 \notin B$, there is a B -FACTOR instance G with a set D of d dangling edges identified with $[d]$ such that for all $D' \subseteq D$ it holds that $D' \in R$ if and only if there is a solution $S \subseteq E$ with $S \cap D = D'$.*

See our later sections for a more formal treatment of this statement. This method of realizing relations was originally introduced in [13] to show tight lower bounds for $\#\text{PERFMATCH}$. We also show similar lemmas for the optimization and counting versions.

Realizations for the Optimization Version. As mentioned earlier, for the maximization version we have to deal with $0 \in B$ which implies that we cannot rule out solutions in all cases. Therefore, we relax the condition “no solution” for the realization and allow the existence of “small” solutions. This gap between largest (as we are considering the maximization version) and small solutions will be the *penalty* of the realizations. To understand how we implement this penalty, first observe that the crucial difference between the decision and the optimization version is that we cannot force edges. Hence, it almost suffices to find a way to force edges to a vertex and obtain a large solution. Otherwise, if the edges we want to force are not selected, the solution should be small. For this we exploit the large gap of the set B and combine it with regular graphs of high girth.² The idea is now the following: If the forced edge is selected, we can select all edges. Otherwise, another (internal) edge is not selected, because we cannot have a degree not contained in B . As the girth of the graph is large, this will lead to many not selected edges and hence the penalty of this realization is large.

Holants. For the counting version, we first describe the Holant problem for (possibly weighted) graphs. Introduced by Valiant in [44], Holants captures a large class of graph problems including coloring problems, vertex cover, and matchings [33]. The input to the problem is a graph and relations over the incident edges of each vertex. The Holant problem on unweighted graphs asks to count the number of subgraphs such that each such relation is satisfied. This can be seen as a general version of $\#B\text{-FACTOR}^{\mathcal{R}}$ where all vertices are assigned a relation. Hence, $\#\text{GENFAC}$ can be seen as the restriction of the Holant problem on unweighted graphs where all relations are *symmetric*. See Section 7 for a formal introduction.

There has been a significant amount of work on the Holant framework in the past two decades [5, 6, 27, 38]. A few of these works directly imply a $\#\text{P}$ -hardness for some cases of $\#B\text{-FACTOR}$. For example, we can use the dichotomy theorem from Cai, Huang, and Lu [5] in the following way when B contains 0, 1 and 2: Let x be the smallest number not in B . To a vertex of list B , attach $x - 3$ vertices with list B and attach three dangling edges. This gadget can be seen as one node with three dangling edges. It can be shown via the dichotomy theorem by Cai et al. that the Holant problem is $\#\text{P}$ -hard when only such nodes are allowed. However, it is not immediate how to realize relations with this approach, nor is it clear how the treewidth of the graphs change through the holographic reductions that are common in showing $\#\text{P}$ -hardness with Holant problems. We circumvent these problems by showing the realizations through polynomial interpolation instead of holographic reductions. To our knowledge, this technique was introduced by Valiant in [43], where the problem of counting *all* matchings was shown to be as hard as counting *perfect* matchings. In our notation, this would correspond to an interpolation argument between $\#\{1\}\text{-FACTOR}$ and $\#\{0, 1\}\text{-FACTOR}$.

Techniques for Cutwidth Lower Bound. As mentioned earlier, we additionally show a matching lower bound parameterized by cutwidth. For this it is crucial to see that the construction for the pathwidth lower bound has large cutwidth. Hence, instead of having

² The girth of a graph is the length of the shortest cycle of a graph.

several variables per vertex, each vertex now corresponds to exactly one variable. Although this construction does not work for the pathwidth bound as it produced large pathwidth, it is sufficient in this setting. The graph will be a grid-like structure where the edges of the rows encode the assignment to the variables and the edges of the columns simulate whether we have already satisfied the clause. We start with every clause being unsatisfied in the first row. Then for each row we check at the crossing points if the variable and the corresponding assignment satisfy the clause. We define relations of constant degree to simulate this behaviour. Then we make use of the previous realization results and replace all relations by their realization. This almost immediately gives us the lower bounds when parameterized by cutwidth.

1.2 Structure of the Paper

Section 2 introduces useful notation and definitions we use in the paper. The two algorithms for parameterization by treewidth and cutwidth are given in Section 3. In Section 4 we show the reduction from SAT to our intermediate problem B -FACTOR ^{\mathcal{R}} . The version-dependent constructions of the realizations and the corresponding lower bounds are shown in Section 5 for the decision version, in Section 6 for the optimization version, and for the counting version in Section 7. Section 8 is dedicated to the lower bound construction when parameterizing by cutwidth.

2 Preliminaries

We introduce homogeneous graphs to formally define B -FACTOR.

► **Definition 2.1** (Homogeneous Graphs and B -FACTOR). *Let $B \subseteq \mathbb{N}$ be some fixed, finite set. We say a node-labeled graph is B -homogeneous if for each node $v \in V$ it holds that $B_v = B$. Then B -FACTOR is the restriction of GENFAC to B -homogeneous graphs.*

This definition directly transfers to the optimization and counting version. We now formally introduce the max-gap of integer sets along with some other properties.

► **Definition 2.2.** *Let $B \subseteq \mathbb{N}$ be finite. We define max-gap B as the largest non-negative integer d such that there is an $a \in B$ with $[a, a + d + 1] \cap B = \{a, a + d + 1\}$.*

In this paper we regularly insert graphs into other graphs. To make this operation formal, we make use of *dangling edges*: these are edges that have only one endpoint. We denote a dangling edge with endpoint v by $(?, v)$. For the sake of completeness we now formally define this procedure of replacing the relations, i.e. the insertion of a graph into another graph.

► **Definition 2.3** (Insertion). *Let $G = (V, E)$ be a graph and $v \in V$ be of degree k , with incident edges $e_1 = (v_1, v), \dots, e_k = (v_k, v)$ that are ordered in some fixed way. Let $H = (W, F)$ be a graph with dangling edges $d_1 = (?, u_1), \dots, d_k = (?, u_k)$ where the u_i are not necessarily pairwise distinct. Inserting H in G at v gives us a new graph $G' = (V', E')$ where:*

$$V' = (V \cup W) \setminus \{v\} \quad \text{and} \quad E' = (E \cup F) \setminus \{e_1, \dots, e_k, d_1, \dots, d_k\} \cup \{(v_1, u_1), \dots, (v_k, u_k)\}$$

All lower bounds we prove in this paper are based on the STRONG EXPONENTIAL TIME HYPOTHESIS. But instead of using the original statement we use a formulation which is more useful to work with.

► **Conjecture 2.4** (STRONG EXPONENTIAL TIME HYPOTHESIS (SETH) [8, 29]). *For all $\delta > 0$, there is a $k \geq 3$ such that satisfiability of k -CNF formulas on n variables requires more than $(2 - \delta)^n$ time.*

Treewidth and Pathwidth. We use the standard definition of a tree decomposition to define treewidth, as for example given in Chapter 7 of [15]. A tree decomposition of a undirected graph G is a pair $\mathcal{T} = (T, \{X_t\}_{t \in V(T)})$, where T is a tree, and every node t of T ³ is assigned a *bag* $X_t \subseteq V(G)$, such that

- Every vertex of G is contained in at least one bag: $\bigcup_{t \in V(T)} X_t = V(G)$.
- For every $(u, v) \in E(G)$, there exists a node t of T such that X_t contains both u and v .
- For every $u \in V(G)$, the nodes whose corresponding bags contain u , i.e. $T_u = \{t \in V(T) \mid u \in X_t\}$, induces a connected subtree of T .

The *width* of the tree decomposition is $\max_{t \in V(T)} |X_t| - 1$, i.e. the maximum size of the bags minus 1. The minimum possible width of a tree decomposition of a graph G defines the *treewidth* $\text{tw}(G)$ of G . The path decomposition leading to pathwidth $\text{pw}(G)$ uses the same definition, except that we require that T is a path.

We use nice tree decompositions as they help in simplifying algorithms; more precisely, we use a variant of nice decompositions with introduce edge nodes. They are defined by a tree decomposition $\mathcal{T} = (T, \{X_t\}_{t \in V(T)})$ and additionally one vertex r of T which serves as the root of T . This rooted tree decomposition \mathcal{T} is *nice* if the bag of the root is empty, i.e. $X_r = \emptyset$, and all nodes t of T have one of the following types:

- **Leaf node:** t has no children and the bag is empty, i.e. $X_t = \emptyset$.
- **Introduce vertex node:** t has a unique child t' with $X_t = X_{t'} \cup \{v\}$ for some vertex $v \notin X_{t'}$.
- **Introduce edge node:** t is labeled with an edge $(u, v) \in E(G)$ where $u, v \in X_t$. Further t has a unique child t' such that $X_t = X_{t'}$. We say, edge (u, v) is introduced at t .
- **Forget node:** t has a unique child t' with $X_t = X_{t'} \setminus \{w\}$ for some vertex $w \in X_{t'}$.
- **Join node:** t has exactly two children t_1 and t_2 such that $X_t = X_{t_1} = X_{t_2}$.

Given a tree decomposition, it can efficiently be transformed into a nice tree decomposition by increasing its size at most polynomially, [31]. Hence, we always assume w.l.o.g. that a given tree decomposition is nice.

About Relations. A relation $R : \{0, 1\}^k \rightarrow \{0, 1\}$ can also be seen as a set $R' \subseteq \{0, 1\}^k$ such that $x \in R'$ iff $R(x) = 1$. We can also identify R with a set $R'' \subseteq 2^{[k]}$, where each element of R'' contains the positions of the 1s of an accepted input. Precisely, $x' = \{i \mid x[i] = 1\} \in R''$ iff $R(x) = 1$. We switch between these definitions depending on the context. Recall, a relation is *symmetric* if its output only depends on the Hamming weight of its input.

To simplify notation, we introduce the following generic classes of symmetric relations.

► **Definition 2.5.** For a vector $x \in \{0, 1\}^k$, we define $\text{hw}(x)$ as the number of 1s in x , i.e. the Hamming weight of x . We define the following for $S \subseteq \mathbb{N}$, and $i, j \in \mathbb{N}$:

$$\text{HW}_{\in S}^{(j)} := \{x \in \{0, 1\}^j \mid \text{hw}(x) \in S\} \quad \text{EQ}_j := \text{HW}_{\in \{0, j\}}^{(j)} \quad \text{HW}_{=i}^{(j)} := \text{HW}_{\in \{i\}}^{(j)}$$

EQ_j is the equality relation on j inputs. We use $\text{HW}_{\in S}$ to denote $\text{HW}_{\in S}^{(j)}$ when the arity j of the relation is implicit. We also use this as the set of the relations $\text{HW}_{\in S}^{(j)}$ for all $j \in \mathbb{N}$. We transfer this abuse of notation to $\text{HW}_{=i}$.

Note that assigning the relations $\text{HW}_{\in B}$ to a vertex corresponds to assigning the set B to the vertex. Which notation is used depends on the context we are in.

³ We refer to the vertices of T as *nodes*, to distinguish them from the vertices of G .

3 Algorithms

In this section we present two algorithms for GENFAC parameterized by treewidth and cutwidth, respectively. By our lower bounds for B -FACTOR we know that these algorithms are (conditionally) optimal for both problems. This is somewhat surprising as the intuitive feeling would be that we can exploit that the graphs are B -homogeneous for B -FACTOR.

Let G be the given graph in the following and let $B_v \subseteq \mathbb{N}$ be the label of vertices $v \in V(G)$. We can assume $B_v \subseteq \{0, \dots, |V(G)|\}$. Then, let $M = \max_{v \in V} \max B_v$ in the following.

3.1 Algorithm when Parameterizing by Treewidth

Assuming a tree decomposition of width tw is given, Arulsevan et al. showed implicitly that GENFAC can be solved in time $(M + 1)^{3\text{tw}} n^{\mathcal{O}(1)}$ [1]. We base our optimal $(M + 1)^{\text{tw}} n^{\mathcal{O}(1)}$ algorithm for counting solutions of a certain size on this approach and combine it with a more precise runtime analysis and fast convolution techniques. As for other algorithms parameterized by treewidth we also assume that a tree decomposition is given as input. This is reasonable as it allows studying the problem independently from finding a decomposition.

3.1.1 Algorithm

Let k be the width of the given tree decomposition where every edge is introduced exactly once. For a node t in the tree decomposition let X_t be the corresponding bag of vertices. We define V_t to be the set of vertices and E_t to be the set of edges introduced in the subtree rooted at t .

For a fixed node t let $f : X_t \rightarrow [0, n]$ and $s \in [0, m]$ where m is the number of edges of G . We define $c[t, f, s]$ to be the number of sets $F \subseteq E_t$ with $|F| = s$ such that $\deg_F(v) = f(v)$ for all $v \in X_t$ and $\deg_F(v) \in B_v$ for all $v \in V_t \setminus X_t$.

As the bag of the root r is empty, only the empty assignment is valid and hence the value of $c[r, \emptyset, s]$ corresponds to the number of solutions of size exactly s for all $s \in [0, m]$. For all other s the number of solutions is 0.

The following dynamic program computes all entries of c and its behavior is completely determined by the type of the node t it currently visits.

Leaf node We have $X_t = \emptyset$ and set $c[t, \emptyset, 0] := 1$ and 0 for all other entries.

Introduce Vertex Node Let t' be the unique child of t such that $X_t = X_{t'} \cup \{v\}$. Let $f|_{X_{t'}}$ be the restriction of f to domain $X_{t'}$. That is $f|_{X_{t'}} : X_{t'} \rightarrow [0, n]$ and $f|_{X_{t'}}(x) = f(x)$ for all $x \in X_{t'}$. We set

$$c[t, f, s] := \begin{cases} c[t', f|_{X_{t'}}, s] & \text{if } f(v) = 0 \\ 0 & \text{else} \end{cases}$$

Introduce Edge Node Let (u, v) be the edge introduced at node t . We have to decide whether to pick the edge or not. As the edge can only be chosen if the degree of the vertices u and v is not zero, we define:

$$c[t, f, s] := c[t', f, s] + \begin{cases} c[t', f_{u \rightarrow f(u)-1, v \rightarrow f(v)-1}, s-1] & \text{if } f(u)f(v) > 0 \\ 0 & \text{else} \end{cases}$$

Forget Node Let t' be the child of t such that $X_t = X_{t'} \setminus \{v\}$. Then we set:

$$c[t, f, s] := \sum_{d \in B_v} c[t', f_{v \rightarrow d}, s]$$

Join Node Let t_1 and t_2 be the left and right child of t such that $X_t = X_{t_1} = X_{t_2}$. For three functions $f, f_1, f_2 : X_t \rightarrow [0, n]$ we write $f_1 + f_2 = f$ if we mean $f_1(v) + f_2(v) = f(v)$ for all $v \in X_t$. Based on this, we can define the values of the table as follows:

$$c[t, f, s] := \sum_{\substack{f_1, f_2 \text{ s.t. } s_1 + s_2 = s \\ f_1 + f_2 = f}} c[t_1, f_1, s_1] \cdot c[t_2, f_2, s_2]$$

Observe that for this to work we crucially need that each edge is introduced exactly once in the whole decomposition. Otherwise the edge could be picked in both subtrees leading to a wrong solution since it could be counted twice. But by assumption each edge is either contained in the tree rooted at t_1 or t_2 or neither of them and thus above t .

Running Time. One can simply observe that each entry of the table can be computed in time $\max\{\mathcal{O}(1), M, (n+1)^{2k+2}m^2\}$. But we can actually restrict the codomain of f to $[0, M]$ and it suffices for the join node to pick f_1 and s_1 as f_2 and s_2 then follow from the equations $f_1 + f_2 = f$ and $s_1 + s_2 = s$, respectively. Hence, each cell can be computed in time $\mathcal{O}((M+1)^{k+1}m)$. Since for each node there are at most $(M+1)^{k+1}$ many valid functions f , the problem can be solved in time $(M+1)^{2k}n^{\mathcal{O}(1)}$. In the next section we show how to improve the running time of the join node by computing all values in parallel.

3.1.2 Improving the Running Time

For the improved computation of the join node we make use of the concepts and ideas from van Rooij [45] including the following lemma:

► **Lemma 3.1** (Lemma 3 in [45] (cyclic and non-cyclic convolution)). *Let $N = \mathbb{N}_{<q_1} \times \mathbb{N}_{<q_2} \times \dots \times \mathbb{N}_{<q_l}$, and let $Q = \prod_{i=1}^l q_i$.⁴ Let $Z = \mathbb{Z}_{r_1} \times \mathbb{Z}_{r_2} \times \dots \times \mathbb{Z}_{r_k}$, and let $R = \prod_{i=1}^k r_i$.*

Let $f, g : Z \times N \rightarrow \mathbb{F}_p$, where p is chosen appropriately. And, let $h : Z \times N \rightarrow \mathbb{F}_p$ be the combined (partially cyclic and partially non-cyclic) convolution of f and g defined as:

$$h(x, i) = \sum_{y_1 + y_2 \equiv x} \sum_{j_1 + j_2 = i} f(y_1, j_1)g(y_2, j_2)$$

where the sum $y_1 + y_2 \equiv x$ is evaluated component-wise modulo r_i at coordinate i (sum in Z), and the sum $j_1 + j_2 = i$ is evaluated component-wise without modulus (sum in N). Then, the combined convolution h can be computed in $\mathcal{O}(RQ2^l(\log(R) + \log(Q) + l))$ arithmetic operations.

The obvious way of using the lemma would be to directly use the non-cyclic part of the convolution. But this would result in $Q = (M+1)^{k+1}(m+1)$ and $l = k+2$, which gives us a bound of $(M+1)^k 2^k n^{\mathcal{O}(1)}$. Instead we mainly use the cyclic part of the convolution and add a degree bound in the non-cyclic part such that we only consider correct combinations of values.

► **Lemma 3.2.** *For each join-node t of the tree decomposition, we can compute $c[t, f, s]$ for all valid f and all $s \in [0, m]$ with $\mathcal{O}((M+1)^k k^2 M m \log(Mm))$ arithmetic operations.*

Proof. We follow the ideas of the proof of Lemma 10 in [45]. Let t_1 and t_2 be the two children of node t . Since $|X_t| \leq k+1$, we can transform each function $f : X_t \rightarrow [0, M]$ into a vector in $[0, M]^{k+1}$ (and vice versa if we add dummy vertices to X_t).

⁴ We set $\mathbb{N}_{<r} = \{0, \dots, r-1\}$.

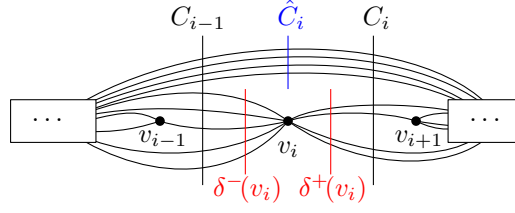

■ **Figure 2** Illustration how the different sets are related to each other.

Based on this we define $a, b : [0, M]^{k+1} \times \mathbb{N} \times [0, m] \rightarrow \mathbb{F}_p$ where $p > 2^{|E|}$ since there can be at most that many edge subsets of the graph G . We define:

$$a(f, F, s) := \begin{cases} c[t_1, f, s] & \text{if } \|f\|_1 = F \\ 0 & \text{else} \end{cases} \quad \text{and} \quad b(f, F, s) := \begin{cases} c[t_2, f, s] & \text{if } \|f\|_1 = F \\ 0 & \text{else} \end{cases}$$

Where we set $\|f\|_1 = \sum_{v \in X_t} f(v)$, where the sum is over the integers (without modulo). Hence, it actually suffices to restrict \mathbb{N} in the definition of a and b to $\mathbb{N}_{\leq (k+1)M}$. We use this to compute the following convolution for all $f \in [0, M]^{k+1}$, $F \in [0, (k+1)M]$, and $s \in [0, m]$.

$$c(f, F, s) = \sum_{f_1 + f_2 \equiv f} \sum_{\substack{F_1 + F_2 = F \\ s_1 + s_2 = s}} a(f_1, F_1, s_1) b(f_2, F_2, s_2)$$

Then we set $c[t, f, s] = c(f, \|f\|_1, s)$ for all f and s to complete the computation for this join-node.

Again the computation of $f_1 + f_2 \equiv f$ is component wise modulo $M + 1$ and for $F_1 + F_2 = F$ and $s_1 + s_2 = s$ over the integers without modulo. By the definition of a and b we only sum values if $\|f_i\|_1 = F_i$. Thus we actually just sum over all values f_1, f_2 such that $f_1 + f_2 = f$ because otherwise we would get that $\|f_1\|_1 + \|f_2\|_1 > \|f\|_1$. We can directly apply Lemma 3.1 with $l = 2$, $q_1 = (k+1)M + 1$, $q_2 = m + 1$, and $r_1 = \dots = r_{k+1} = M + 1$. As $Q = (kM + M + 1)(m + 1)$ and $R = (M + 1)^{k+1}$ the claimed running time follows. ◀

It is easy to see that the computation of the join nodes dominates the running time. Therefore, the proof of this lemma finishes the proof of Theorem 1.3.

3.2 Algorithm when Parameterizing by Cutwidth

Assume we are given a linear layout of the GENFAC instance G . We relabel the vertices such that their index corresponds to this layout. Let C_i be the edges of the graph that cross the cut after vertex v_i , that is $C_i = E \cap (\{v_1, \dots, v_i\} \times \{v_{i+1}, \dots, v_n\})$. We define $\delta_i^+ = C_i \cap I(v_i)$ as the forwards edges of v_i , i.e. the edges to vertices in $\{v_{i+1}, \dots, v_n\}$ and likewise $\delta_i^- = C_{i-1} \cap I(v_i)$ as the backwards edges of v_i . Let $E_i = E|_{v_1, \dots, v_i}$ be the edges induced by the vertices v_1, \dots, v_i . We additionally define \widehat{C}_i as the set of edges in the cuts C_{i-1} and C_i that are not incident to v_i , i.e. $\widehat{C}_i = C_{i-1} \setminus \delta_i^- = C_i \setminus \delta_i^+$. See Figure 2 for an illustration of the setting.

The idea of the algorithm is to fill a three-dimensional table c such that for all $i \in [0, n]$, $s \in [0, m]$, and $C \subseteq 2^{C_i}$ we have that $c[i, C, s]$ is the number of sets $S \subseteq E_i$ with $|S| = s$ such that $\deg_S(v_j) + \deg_C(v_j) \in B_{v_j}$ for all $j \in [i]$. Phrased differently: the number of possibilities to extend the selected edges of the cut to a valid partial solution for the first i vertices.

As the cut after v_n does not contain any edges, we only have to consider the empty set. Hence, the output of the algorithm is the value of $c[n, \emptyset, s]$ for $s \in [0, m]$ and 0 otherwise.

It remains to show how we can compute the values of the table efficiently. We initialize the table with $c[0, \emptyset, 0] = 1$ and 0 at all other positions. Then we design a step function that computes the values of $c[i, \cdot, \cdot]$ given the values of $c[i-1, \cdot, \cdot]$. We first show a naive way for this and then improve the computation to get the algorithm with optimal running time.

3.2.1 Naive Step Function

For all $C \subseteq C_i$ and $s \in [0, m]$ we compute the value sequentially as follows:

$$c[i, C, s] = \sum_{\substack{S^- \subseteq \delta_i^- \text{ s.t.} \\ |S^-| + \deg_C(v_i) \in B_{v_i}}} c[i-1, C \setminus \delta_i^+ \cup S^-, s - |S^-|]$$

For each i we have to compute $\mathcal{O}(2^{\text{cutw}}(m+1))$ table entries. Each of the entries can be computed in time $2^{\text{cutw}}n^{\mathcal{O}(1)}$ as we iterate over all subsets of δ_i^- . This gives us a total running time of $4^{\text{cutw}}n^{\mathcal{O}(1)}$.

3.2.2 Improved Step Function

For the improved algorithm we make use of the fact that for the computation of $c[i, \cdot, \cdot]$ only the selected edges in δ_i^- and the *number* of selected edges from δ_i^+ are of interest. The edges in \widehat{C}_i are not affected as v_i moves to the other side of the cut. Further observe that we can partition $C \subseteq C_i$ into $C = \widehat{C} \dot{\cup} S^+$ for $S^+ \subseteq \delta_i^+$ and $\widehat{C} \subseteq \widehat{C}_i$. We transform the naive formula from above as follows:

$$\begin{aligned} c[i, C, s] &= c[i, \widehat{C} \dot{\cup} S^+, s] \\ &= \sum_{\substack{S^- \subseteq \delta_i^- \text{ s.t.} \\ |S^-| + \deg_{\widehat{C} \dot{\cup} S^+}(v_i) \in B_{v_i}}} c[i-1, (\widehat{C} \dot{\cup} S^+) \setminus \delta_i^+ \cup S^-, s - |S^-|] \\ &= \sum_{\substack{S^- \subseteq \delta_i^- \text{ s.t.} \\ |S^-| + |S^+| \in B_{v_i}}} c[i-1, \widehat{C} \cup S^-, s - |S^-|] \\ &= h[|S^+|, \widehat{C}, s] \end{aligned}$$

where:

$$h[\ell, \widehat{C}, s] = \sum_{\substack{S^- \subseteq \delta_i^- \text{ s.t.} \\ |S^-| + \ell \in B_{v_i}}} c[i-1, \widehat{C} \cup S^-, s - |S^-|]$$

The improved step function now works as follows:

1. Initialize the auxiliary table h with 0s.
2. Use the above formula to fill h for all $\widehat{C} \subseteq \widehat{C}_i$, $s \in [0, m]$, and $\ell \in [0, M]$. This takes time $2^{|\widehat{C}_i|}(M+1)2^{|\delta_i^-|}n^{\mathcal{O}(1)} \leq 2^{|C_{i-1}|}n^{\mathcal{O}(1)}$.
3. For all $\widehat{C} \subseteq \widehat{C}_i$, $s \in [0, m]$, and $S^+ \subseteq \delta_i^+$, we set $c[i, \widehat{C} \dot{\cup} S^+, s] := h[|S^+|, \widehat{C}, s]$. This takes time $2^{|\widehat{C}_i|}2^{|\delta_i^+|}n^{\mathcal{O}(1)} \leq 2^{|C_i|}n^{\mathcal{O}(1)}$.

Hence, we can bound the running time of each round by $2^{\text{cutw}}Mn^{\mathcal{O}(1)}$.

4 Lower Bound when Parameterizing by Pathwidth

We show the lower bounds in two steps. The first step is a reduction from CNF-SAT to the intermediate problem B -FACTOR WITH RELATIONS. In the second step, we reduce to the actual version of B -FACTOR for which we want to show the lower bound. As the lower bounds are for pathwidth they immediately hold for treewidth as it can be upper-bounded by pathwidth for all graphs.

► **Definition 4.1** (B -FACTOR WITH RELATIONS (B -FACTOR ^{\mathcal{R}})). *Let $B \subseteq \mathbb{N}$ be fixed of finite size. $G = (V_S \dot{\cup} V_C, E)$ is an instance of B -FACTOR WITH RELATIONS if all nodes in V_S are labeled with set B and all nodes $v \in V_C$ are labeled with a relation R_v that is given as a truth table such that the following holds:*

1. *Let $I(v)$ be the set of edges incident to v in G . Then $R_v \subseteq 2^{I(v)}$.*
2. *There is an even $c_v > 0$ such that for all $x \in R_v$ we have $\text{hw}(x) = c_v$.*

A set $\hat{E} \subseteq E$ is a solution for G if (1) for $v \in V_S$: $\deg_{\hat{E}}(v) \in B$ and (2) for $v \in V_C$: $I(v) \cap \hat{E} \in R_v$. B -FACTOR ^{\mathcal{R}} is the problem of deciding if such an instance has a solution. We call V_S the set of simple nodes and V_C the set of complex nodes.

Using this intermediate problem, we can formally state the first part of the reduction. The lower bound needs a careful formulation: when we reduce B -FACTOR ^{\mathcal{R}} to B -FACTOR by inserting gadgets realizing the relations at the complex nodes, the size and pathwidth of the graph can increase significantly. Therefore, we state a stronger lower bound that can tolerate additional terms to take care of such increases. The key point is that this increase is mainly influenced by the total degree of the complex nodes in a bag of the path decomposition.

► **Theorem 4.2.** *Let $B \subseteq \mathbb{N}$ be a fixed set of finite size with $B \neq \{0\}$. Given a B -FACTOR ^{\mathcal{R}} instance along with a path decomposition of width pw such that $\Delta^* = \max_{\text{bag } X} \sum_{v \in X \cap V_C} \deg(v)$. Assume B -FACTOR ^{\mathcal{R}} can be solved in $(\max B + 1 - \epsilon)^{\text{pw} + f_B(\Delta^*)} n^{\mathcal{O}(1)}$ time on graphs with n vertices for some $\epsilon > 0$ and some function $f_B : \mathbb{N} \rightarrow \mathbb{R}^+$ that may depend on the set B . Then SETH fails.*

High Level Idea. We follow the ideas of previous lower bound reductions from [36] and combine them with the concept of using relations from [13]. From now on let $M := \max B$. Let ϕ be the given CNF formula with n variables and clauses C_1, \dots, C_m . Instead of encoding each variable separately, we group q variables together and encode (partial) assignments to these groups. For each partial assignment, we define a vector in $[0, M]^g$, where g is chosen such that $2^g \leq (M + 1)^g$. For each group we define a *layer* with g parallel *rows*, where each row corresponds to one dimension of the vector. The layers consist of an alternation of g parallel simple nodes and a complex node that is related to a clause. All simple nodes are connected to their neighboring complex nodes by M parallel edges. The vector from above then corresponds to the number of selected edges from a simple node to the following shared complex node. The complex nodes check whether the assignment represented by the selected edges of a layer satisfies the related clause. For each clause we connect the related complex nodes by a path. This path is used to propagate the information whether the clause is already satisfied by some partial assignment or whether it still needs to be satisfied. We ensure that each clause is initially not satisfied and eventually all clauses must be satisfied.

Constructing the B -Factor ^{\mathcal{R}} Instance. See Figure 3 for an example of the following construction. Split the variables of ϕ into $t := \lceil n/q \rceil$ groups F_1, \dots, F_t of size at most q , where q is chosen later. For each of the t groups we encode the 2^g partial assignments by

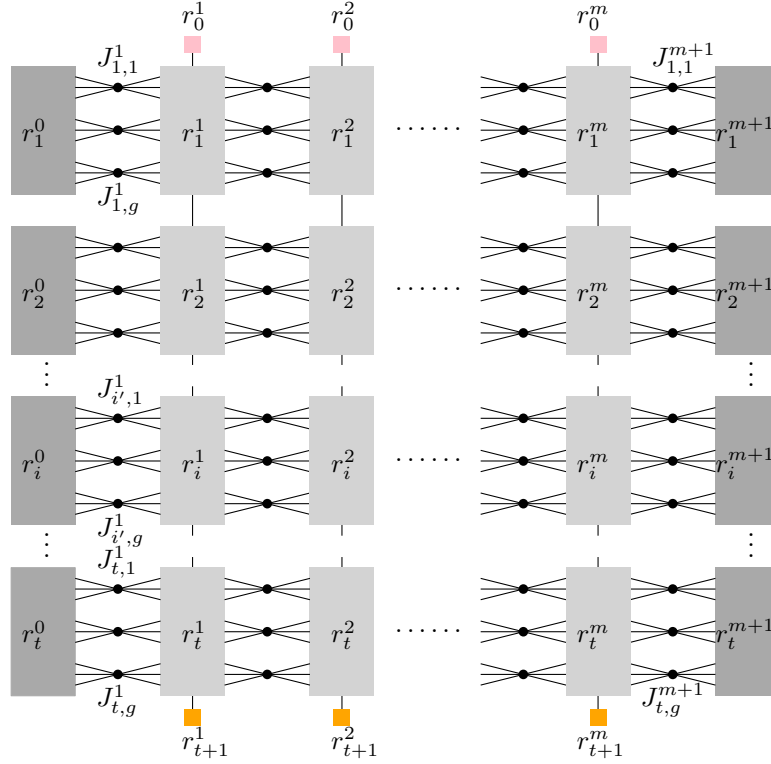

■ **Figure 3** An example illustrating the construction from the proof of Theorem 4.2. The simple nodes are represented by circles while the complex nodes are represented by boxes.

vectors from $[0, M]^g$ for some g chosen later. Instead of using all $(M+1)^g$ possible encodings we only use those vectors where the total weight of the coordinates is equal to $gM/2$ (we will choose g as a multiple of 4, hence $gM/2$ is an even number). It can easily be shown that there are more than $(M+1)^g/(gM+1)$ vectors with exactly this weight. Thus, after setting $q = \lfloor \log((M+1)^g) - \log(gM+1) \rfloor$, we can map each of the 2^q assignments of a group F_i to a distinct vector $[0, M]^g$ with weight exactly $gM/2$. We say that an partial assignment τ to a group F_i satisfies a clause C_j if at least one literal in the clause is satisfied under the assignment τ . Note, that a group F_i does not have to cover all variables of C_j to satisfy the clause.

We define the graph now as follows:

1. For all $i \in [t]$, $\ell \in [g]$, and $j \in [m]$: create a simple node $J_{i,\ell}^j$.
2. For all $i \in [t]$ and $j \in [m]$: create complex nodes r_i^j with relation R_i^j to be defined later.
3. For all $i \in [t]$: create complex nodes r_i^0 and r_i^{m+1} with relation R^0 .
4. For all $j \in [m]$: create complex nodes r_0^j (resp. r_{t+1}^j) with relation $\text{HW}_{=0}$ (resp. $\text{HW}_{=1}$).
5. For all $i \in [t]$, $\ell \in [g]$, and $j \in [m]$: make $J_{i,\ell}^j$ adjacent to r_{i-1}^j and r_i^j by M parallel edges each. We call these edges backwards and forwards edges, respectively.
6. For all $i \in [t]$ and $j \in [m]$, make r_i^j additionally adjacent to r_{i-1}^j and r_{i+1}^j by one edge each. The degree of the nodes is now $2gM+2$.

We call the set of nodes $\{r_i^j, J_{i,\ell}^j\}_{j,\ell}$ the i th layer. The set $\{J_{i,\ell}^j\}_j$ forms the ℓ th row of the i th layer. For a fixed $j \in [m]$, the set of nodes $\{r_i^j\}_i$ is called the j th column.

The idea is now the following: For each partial assignment τ to a group F_i , we define a

vector $v_\tau \in [0, M]^g$ of weight $gM/2$ as its *encoding*.⁵ Then $v_\tau[\ell]$ corresponds to the number of selected forward edges of the simple nodes in the ℓ th row of the i th layer. The vertical edges encode whether a clause was already satisfied. That is, if the edge between r_i^j and r_{i+1}^j is selected, then there is some group F_k with $k \leq i$ where the corresponding assignment satisfies the clause C_j . By the relation of the nodes r_0^j every clause is initially not satisfied. But the relation of the r_{i+1}^j nodes ensures that every clause is eventually satisfied.

Defining the Relations. R^0 accepts exactly those inputs of Hamming weight exactly $gM/2$, an even number by assumption, where the selected edges for each row must precede the unselected edges, i.e. the first k edges are selected, the next $M - k$ are not selected.

The relation $R_i^j \subseteq \{0, 1\}^{2Mg+2}$ of node r_i^j is defined as follows:

- For $\ell \in [g]$, let x_ℓ (resp. y_ℓ) be the number of selected incident edges to $J_{i,\ell}^j$ (resp. $J_{i,\ell}^{j+1}$).
- $\sum_{\ell \in [g]} x_\ell = gM/2 = \sum_{\ell \in [g]} y_\ell$.
- $\langle x_1, \dots, x_g \rangle$ describes a valid encoding, i.e. it corresponds to a partial assignment for F_i .
- $x_\ell + y_\ell = M$. Further, the x_ℓ (resp. y_ℓ) selected edges precede the $M - x_\ell$ (resp. $M - y_\ell$) unselected edges of the M parallel edges going to a simple node.
- If the ingoing top edge is selected, then the outgoing bottom edge is also selected.
- If the ingoing top edge is not selected:
 - If C_j does not contain a variable of F_i , then the outgoing bottom edge is not selected.
 - If C_j contains at least one variable of F_i , then the outgoing bottom edge is selected if and only if the selected edges correspond to a valid partial assignment satisfying C_j .

Final Modifications. Unfortunately the previous construction is not a $B\text{-FACTOR}^{\mathcal{R}}$ instance. One reason is that the Hamming weight of the accepted inputs of the relations R_i^j is not always the same even number. The misbalance is caused by the edges encoding the evaluation of the clause. To avoid this problem, we add another edge between all r_i^j and r_{i+1}^j nodes. We refer to this new edge as the negated edge and to the original edge as the positive edge. We further introduce nodes \hat{r}_0^j and \hat{r}_{i+1}^j with relations $\text{HW}_{=1}$ and $\text{HW}_{=0}$ which are connected to r_0^j and r_{i+1}^j , respectively. Observe that the relations are exactly opposite to the ones for the nodes r_0^j and r_{i+1}^j . We extend all relations R_i^j by two new inputs and require that the negated edge is selected if and only if the corresponding positive edge is not selected. Then, the Hamming weight of the accepted inputs of the relations R_i^j is always the same, namely $gM + 2$, which is an even number as $gM/2$ is even by assumption. In a second step we merge the four nodes r_0^j , r_{i+1}^j , \hat{r}_0^j , and \hat{r}_{i+1}^j into a single node r^j of degree 4, for all $j \in [m]$. The relation of r^j accepts only the unique input of weight 2 which agrees with the relations of all four replaced nodes. We later show that the parallel edges disappear when replacing the complex nodes by their realizations (the portal nodes of the realization will be pairwise different). Nevertheless, if one wants to get a simple graph, one can use five appropriately connected $\text{HW}_{=2}^{(4)}$ nodes to replace one such edge. We leave it to the reader to find the gadget. Almost all of these modification are only necessary due to parity issues. As they are in most cases not relevant for the correctness of the construction, we mostly ignore them in our proofs in the following.

► **Lemma 4.3.** *If ϕ is satisfiable, then there is a solution to the $B\text{-FACTOR}^{\mathcal{R}}$ instance.*

Proof. Let σ be a satisfying assignment to the variables of ϕ . For fixed variable group F_i , let $v_i \in [0, M]^g$ be the encoding that corresponds to σ when restricted to F_i . For the

⁵ Note that for different groups the encoding of the same partial assignment do not need to be the same.

solution we select the edges as follows: In the ℓ th row of the i th layer we select the $v_i[\ell]$ top most forwards edges of the simple nodes and the $M - v_i[\ell]$ top most backwards edges. By this obviously every simple node is incident to M selected edges and the conditions of the relations R^0 are satisfied.

Now consider a fixed clause C_j . Let F_k be the first (with regard to k) group of variables whose partial assignment satisfies the clause. Then we do not select the edges between r_{i-1}^j and r_i^j for all $i \in [k]$. Combined with the valid encoding from above, the relations of these nodes are now satisfied. As the encoding precisely corresponds to the assignment satisfying the clause, we select the edges between the nodes r_i^j and r_{i+1}^j for all $i \geq k$. Then all relations are satisfied and the claim follows. \blacktriangleleft

► **Lemma 4.4.** *If there is a solution to the $B\text{-FACTOR}^{\mathcal{R}}$ instance, then ϕ is satisfiable.*

Proof. Let $S \subseteq E$ be a solution. We construct an assignment σ by assigning values to the variables of each group F_i independently. For this fix some $i \in [t]$.

For $\ell \in [g]$, let $x_\ell^1, \dots, x_\ell^{m+1}$ and $y_\ell^1, \dots, y_\ell^{m+1}$ be the number of selected forwards and backwards edges of the nodes $J_{i,\ell}^j$, respectively. We claim that the number of selected forwards edges does not change for a fixed row $\ell \in [g]$:

▷ **Claim 4.5.** $x_\ell^1 = \dots = x_\ell^{m+1}$ and $y_\ell^1 = \dots = y_\ell^{m+1}$.

Proof. By the construction of the graph and the definition of the relations we get:

$$y_\ell^{j+1} + x_\ell^j = M \quad \forall \ell \in [g], j \in [m] \quad (1)$$

$$y_\ell^j + x_\ell^j \leq M \quad \forall \ell \in [g], j \in [m+1] \quad (2)$$

$$\sum_{\ell=1}^g x_\ell^{m+1} = \frac{gM}{2} = \sum_{\ell=1}^g y_\ell^1 \quad (3)$$

Combining (1) and (2) gives us:

$$x_\ell^j \geq x_\ell^{j+1} \quad \forall j \in [m] \quad (4)$$

$$y_\ell^j \leq y_\ell^{j+1} \quad \forall j \in [m] \quad (5)$$

Now assume for contradictions sake that there is some j' with $x_\ell^{j'} > x_\ell^{j'+1}$:

$$\frac{gM}{2} \stackrel{(3)}{=} \sum_{\ell=1}^g x_\ell^{m+1} \stackrel{(4)}{\leq} \sum_{\ell=1}^g x_\ell^{j'+1} < \sum_{\ell=1}^g x_\ell^{j'} \stackrel{(4)}{\leq} \sum_{\ell=1}^g x_\ell^1 \stackrel{(2)}{\leq} \sum_{\ell=1}^g (M - y_\ell^1) = gM - \sum_{\ell=1}^g y_\ell^1 \stackrel{(3)}{=} \frac{gM}{2}$$

which is obviously a contradiction. This proves the claim as we can use the analogous argument for the backwards edges. Observe that this implies that all simple nodes have degree exactly M in the solution. \triangleleft

Since S is a solution, the relation R_i^j must be satisfied. Thus, $\langle x_1^1, \dots, x_g^1 \rangle$ must correspond to a valid encoding of some assignment for F_i . We use this partial assignment for σ .

To show that σ satisfies all clauses let C_j be an arbitrary clause. As S is a solution, the relations of the nodes r_0^j and r_{t+1}^j must be satisfied by S . By definition of the relations R_i^j , there must be a i_j and a node $r_{i_j}^j$ where the top edge is not selected but the bottom edge is selected. By definition of the relation, this change can only happen if the selected incident forwards edges describe an encoding which corresponds to an assignment satisfying C_j . By Claim 4.5 this number of selected edges is always the same. Hence, the assignment represented by the selected edges that are incident to r_i^j agrees with the assignment we chose for σ . \blacktriangleleft

To obtain a tight lower bound, we need to analyze the pathwidth of our construction and have to bound the degree of the complex nodes.

► **Lemma 4.6.** *The graph has $\mathcal{O}(tgm)$ simple and $\mathcal{O}(tm)$ complex nodes. The degree of the complex nodes is bounded by $2gM + 4$. The degree of the simple nodes is bounded by $2M$. We can efficiently construct a path decomposition of width $tg + \mathcal{O}(1)$ where at most three complex nodes are simultaneously in one bag.*

Proof. The number of nodes and their degree bound follows immediately from the construction. We give a mixed search strategy as shown in [15] to create a path decomposition of the graph.

We start by placing searchers on each node $J_{i,\ell}^1$ for $i \in [t]$ and $\ell \in [g]$. We place a searcher on each r_i^0 and remove it immediately afterwards. Then we clean the rest of the graph in stages, starting with stage 1. Stage j starts if the searchers are placed on the nodes $J_{i,\ell}^j$. First place two searcher on r_1^j and r_1^j . Then we move the searchers placed on the adjacent simple nodes of r_1^j to the next simple node of the row. Then place one searcher on r_2^j and repeat the process after removing the one from r_1^j . Repeat this procedure for all other nodes r_i^j . When removing the searcher from r_t^j , we also remove the searcher from r^j . By this we eventually arrive at a point where all searchers are located at the nodes $J_{i,\ell}^{m+1}$. Then we use one additional searchers to clean the remaining r_i^{m+1} nodes. ◀

Now we have everything ready to prove the lower bound for the intermediate problem B -FACTOR $^{\mathcal{R}}$ based on the previous construction. Recall, we defined Δ^* as the maximum total degree of the complex nodes appearing in one bag, that is $\Delta^* = \max_{\text{bag } X} \sum_{v \in X \cap V_C} \deg(v)$.

Proof of Theorem 4.2. Assume an $(M+1-\epsilon)^{\text{pw}+f(\Delta^*)} N^{\mathcal{O}(1)}$ time algorithm for B -FACTOR $^{\mathcal{R}}$ on graphs with N nodes exists for some function f . Due to rounding issues and the fact that we only use even relations, the parameters must be chosen quite carefully. We set $\lambda := \log_{M+1}(M+1-\epsilon) < 1$. Choose an $\alpha > 1$ such that $\alpha \cdot \lambda = \delta' = \log(2-\delta) < 1$ for some $\delta > 0$. This is always possible since $\lambda < 1$. Choose g large enough such that $g \log(M+1) \leq \alpha \lfloor g \log(M+1) - \log(gM+1) \rfloor$ and g is divisible by 4. By Lemma 4.6 and our choice of parameters ($t = \lceil n/q \rceil$ and $q = \lfloor g \log(M+1) - \log(gM+1) \rfloor$) we get:

$$\begin{aligned} (M+1-\epsilon)^{\text{pw}+f(\Delta^*)} N^{\mathcal{O}(1)} &= (M+1-\epsilon)^{tg+\mathcal{O}(1)+f(\Delta^*)} N^{\mathcal{O}(1)} \\ &= (M+1-\epsilon)^{\lceil \frac{n}{q} \rceil g + f(\Delta^*)} N^{\mathcal{O}(1)} = (M+1-\epsilon)^{\frac{n \cdot g}{\lfloor g \log(M+1) - \log(gM+1) \rfloor} + g + \mathcal{O}(1) + f(\Delta^*)} N^{\mathcal{O}(1)} \end{aligned}$$

Since B is fixed, M is constant. Further, g only depends on M and ϵ and N only depends on the number of variables n and number of clauses m of the SAT instance. As $\Delta^* \in \mathcal{O}(gM)$, the factor of $(M+1-\epsilon)^{\mathcal{O}(1)+g+f(\Delta^*)}$ contributes only a large constant (depending only on M and ϵ) to the overall running time which can be hidden by the $n^{\mathcal{O}(1)}$ term:

$$\begin{aligned} &\leq (M+1-\epsilon)^{\frac{\alpha n}{\log(M+1)}} (n+m)^{\mathcal{O}(1)} \\ &= 2^{\log(M+1-\epsilon) \frac{\alpha n}{\log(M+1)}} (n+m)^{\mathcal{O}(1)} = 2^{\lambda \alpha n} (n+m)^{\mathcal{O}(1)} = 2^{\delta' n} (n+m)^{\mathcal{O}(1)} \\ &= (2-\delta)^n (n+m)^{\mathcal{O}(1)}. \end{aligned}$$

This violates SETH (Conjecture 2.4) since this gives an algorithm to solve k -SAT with n variables and m clauses in time $(2-\delta)^n (n+m)^{\mathcal{O}(1)}$ for some constant $\delta > 0$ for all k . ◀

For the lower bound for the counting version, we need a one-to-one correspondence between valid assignments and solutions to the graph problem. This is why we need that the selected edges are at specific positions, i.e. above the not-selected edges.

► **Corollary 4.7.** *The reduction in Theorem 4.2 is parsimonious, i.e. it preserves the number of solutions. Therefore, the statement also holds for the counting versions of B -FACTOR $^{\mathcal{R}}$ and SETH.*

We also make the following observations about the constructed B -FACTOR $^{\mathcal{R}}$ instances.

► **Corollary 4.8.** *The lower bound proved in Theorem 4.2 holds even for B -FACTOR $^{\mathcal{R}}$ instances where*

1. *the vertices in V_S form an independent set,*
2. *every vertex in V_S is adjacent to exactly two vertices from V_C by $\max B$ edges each,*
3. *and every vertex in V_S will have degree exactly $\max B$ in the solution.*

5 Decision Version

In this section we prove the lower bound for the decision version of B -FACTOR by a reduction from the intermediate B -FACTOR $^{\mathcal{R}}$ problem. For this we formally define the concept of realizations and show that we can realize all relations of a B -FACTOR $^{\mathcal{R}}$ instance. Replacing the nodes and their relations by these realizations yields the final lower bound.

► **Definition 5.1** (Realization). *Let $R \subseteq \{0, 1\}^k$ be a relation. Let G be a node-labeled graph with dangling edges $D = \{d_1, \dots, d_k\} \subseteq E(G)$. We say that graph G realizes R if for all $D' \subseteq D$: $D' \in R$ if and only if there is a solution $S \subseteq E(G)$ with $S \cap D = D'$. We say that G B -realizes R if G is B -homogeneous. The endpoints of the dangling edges are called portals.*

The crucial part of the reduction is the proof of the following theorem. We postpone its proof and first show the lower bound.

► **Theorem 5.2.** *Let $B \subseteq \mathbb{N}$ be a fixed set of finite size with $\max\text{-gap } B > 1$ and $0 \notin B$. There is a $f : \mathbb{N} \rightarrow \mathbb{N}$ such that the following holds. Let $R \subseteq \{0, 1\}^e$ be an even relation (i.e. $\text{hw}(x)$ is even for all $x \in R$). Then we can B -realize R by a simple graph with $f(e)$ vertices of degree at most $\max B + 2$, the portal nodes are pairwise distinct.*

Recall the formal statement of the insertion from Definition 2.3. The following lemma follows directly from this definition and the definition of the realization. We use it to replace the relations by their realization.

► **Lemma 5.3.** *Let G be a node labeled graph, R the relation of node $v \in V(G)$, and let H realize R . Assume inserting H in G at v gives us a new graph G' . Then there is a solution for G if and only if there is a solution for G' .*

Now we can prove the lower bound under SETH. We assume that $B \subseteq \mathbb{N}$ is a fixed, finite set such that $0 \notin B$ and $\max\text{-gap } B > 1$.

Proof of Theorem 1.4. Let H be a B -FACTOR $^{\mathcal{R}}$ instance with n_S simple nodes, n_C complex nodes, pathwidth pw_H , and $\Delta^* = \max_{\text{bag } X} \sum_{v \in V_C \cap X} \deg(v)$.

Replace every complex node v and its relation R_v by a B -homogeneous graph of size at most $f(\deg(v))$ according to Theorem 5.2 to get the graph G with $n_G \in \mathcal{O}(n_S + n_C \cdot f(\Delta^*))$ vertices. Obviously we can bound the pathwidth of the inserted graphs by their size. We transform each bag X of the path decomposition of H into a bag X' of the path decomposition of G by replacing all complex nodes with the nodes of their realization.

$$|X'| \leq |X| + \sum_{v \in X \cap V_C} f(\deg(v)) \leq |X| + \sum_{v \in X \cap V_C} f(\Delta^*) \leq |X| + \Delta^* f(\Delta^*) = |X| + f'(\Delta^*)$$

for some function f' . Hence, the pathwidth of G is bounded by $\text{pw}_G \leq \text{pw}_H + f'(\Delta^*)$.

Now assume we can solve B -FACTOR in the claimed running time:

$$\begin{aligned} (\max B + 1 - \epsilon)^{\text{pw}_G} \cdot n_G^{\mathcal{O}(1)} &\leq (\max B + 1 - \epsilon)^{\text{pw}_H + f'(\Delta^*)} \cdot (n_S + n_C \cdot f'(\Delta^*))^{\mathcal{O}(1)} \\ &\leq (\max B + 1 - \epsilon)^{\text{pw}_H + f'(\Delta^*)} \cdot f''(\Delta^*) \cdot (n_S + n_C)^{\mathcal{O}(1)} \\ &\leq (\max B + 1 - \epsilon)^{\text{pw}_H + f'''(\Delta^*)} \cdot (n_S + n_C)^{\mathcal{O}(1)} \end{aligned}$$

for some f'' and f''' . But this would immediately contradict SETH by Theorem 4.2. \blacktriangleleft

5.1 Realizing Relations

From now on let $B \subseteq \mathbb{N}$ be our fixed, finite set with $\min B \geq 1$ and $\text{max-gap } B = d > 1$ such that $[a, a + d + 1] \cap B = \{a, a + d + 1\}$ for some $a \geq 1$. We first realize three quite basic relations which we use later to realize the more complex relations.

► **Lemma 5.4.** *We can B -realize each of the relations $\text{HW}_{=2}^{(2)}$, EQ_{d+1} , and EQ_2 by a simple graph with $\mathcal{O}(\text{poly}(\max B))$ vertices of degree at most $\max B$.*

Proof. 1. Define a $\min B + 1$ -clique with new vertices. Split an arbitrary edge (u, v) into two dangling edges $(?, u)$ and $(?, v)$. The construction of the clique and the fact that we chose $\min B$ as degree forces the two dangling edges to be selected in any solution.

2. We start with two new vertices u, v and connect each to a many common $\text{HW}_{=2}^{(2)}$ nodes. We add $d + 1$ dangling edges to u and zero to v . Finally the nodes are replaced by their realization. Observe that u has a forced edges and $d + 1$ dangling edges. Thus we must select none or all of the dangling edges since $[a, a + d + 1] \cap B = \{a, a + d + 1\}$.

3. Define a $d + 2$ -clique with EQ_{d+1} nodes. Split an arbitrary edge (u, v) into two dangling edges $(?, u)$ and $(?, v)$. Replace the nodes by their realization. Either both dangling edges are selected in which case all nodes have $d + 1$ incident edges in the solution, or neither is selected in which case every node has zero incident edges in the solution. \blacktriangleleft

The following lemma helps us to keep the later constructions simple. Instead of constructing the relations for arbitrary degree, only the very low degree cases are necessary.

► **Lemma 5.5.** *If we can realize $\text{HW}_{=1}^{(a)}$ for $a \in \{1, 2, 3\}$ by a simple graph with at most N vertices of degree at most D , then we can realize $\text{HW}_{=1}^{(k)}$ for all $k \geq 1$ by a simple graph using $\mathcal{O}(kN)$ nodes of degree at most D .*

Proof. We construct the graph for the realization inductively starting with the basis for $k = 1, 2, 3$. See Figure 4 for an example.

For the inductive step from k to $k + 1$ we start with a node u with relation $\text{HW}_{=1}^{(k)}$. Connect one dangling edge of u to a new node v with $\text{HW}_{=1}^{(2)}$. Connect the other dangling edge of v to a node w with relation $\text{HW}_{=1}^{(3)}$. Observe that the final graph has $k + 1$ dangling edges.

Assume one dangling edge of u is selected, then the edge between u and v is not selected but the edge from v to w is. Hence, no dangling edge of w can be selected. The analogue holds if one of the dangling edges of w is selected. It cannot be the case that more than one or zero dangling edges are selected, as then the relation of one of the three nodes u, v, w would not be satisfied. \blacktriangleleft

Due to parity issues, the construction of the realizations depends on the set B . For each of the possible cases (B contains only even numbers, only odd number, or even and odd numbers) we state the result separately in Lemmas 5.6–5.8.

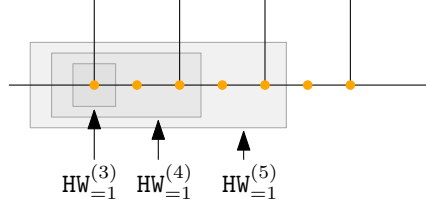

■ **Figure 4** Example of the inductive construction from Lemma 5.5 for $\text{HW}_{=1}^{(6)}$ using $\text{HW}_{=1}^{(3)}$ and $\text{HW}_{=1}^{(2)}$.

► **Lemma 5.6.** *If B contains only even numbers, we can B -realize the following relations by simple graphs:*

1. EQ_k for even $k \geq 2$ using $\mathcal{O}(k \text{ poly}(\max B))$ vertices of degree at most $\max B$.
2. $\text{HW}_{=1}^{(k)}$ together with $\text{HW}_{=1}^{(\ell)}$ for all $k, \ell \geq 1$ using $\mathcal{O}((k + \ell) \text{ poly}(\max B))$ vertices of degree at most $\max B + 2$.

Proof. 1. For $k = 2$ we can use the construction of Lemma 5.4. For the other case we first realize EQ_4 . Then we use a chain of these relations to realize EQ_k for even $k \geq 6$.

Start with a EQ_{d+1} node u and make it adjacent to $\frac{d+1-4}{2}$ many EQ_2 nodes (note that an even B can have only gaps of odd size, hence d is odd). Then we add four dangling edges to u . hence the construction actually works. The graph is simple as the dangling edges in the realization of EQ_2 are different.

2. To use Lemma 5.5 for the general construction, observe that the number of $\text{HW}_{=1}$ nodes used in the construction is odd. Hence, we will always realize two nodes. For this we show how to realize $\text{HW}_{=1}^{(k)}$ together with $\text{HW}_{=1}^{(\ell)}$ for all $k, \ell \in \{1, 2, 3\}$.

Start with two vertices u, v . Make u and v adjacent to $\max B - 1$ common $\text{HW}_{=2}^{(2)}$ nodes. We add k dangling edges to u and ℓ dangling edges to v . As B does not contain $\max B - 1$, the correctness follows. ◀

Despite the fact, that the parity of the elements is still the same when all elements in B are odd, it is possible to show a stronger result, which allows us to realize single $\text{HW}_{=1}$ nodes.

► **Lemma 5.7.** *If B contains only odd numbers, we can B -realize the following relations by simple graphs:*

1. EQ_k for even $k \geq 2$ using $\mathcal{O}(k \text{ poly}(\max B))$ vertices of degree at most $\max B$.
2. $\text{HW}_{=1}^{(k)}$ for $k \geq 1$ using $\mathcal{O}(k \text{ poly}(\max B))$ vertices of degree at most $\max B + 2$.

Proof. 1. The construction from Lemma 5.6 for EQ_k works here too.

2. We again use Lemma 5.5 and only realize $\text{HW}_{=1}^{(k)}$ for $k = 1, 2, 3$. We start with just one node u to which we force $\max B - 1$ edges by making it adjacent to $\frac{\max B - 1}{2}$ nodes of type $\text{HW}_{=2}^{(2)}$. This is possible as $\max B - 1$ is even. We add k dangling edges to u and replace all nodes by their realizations. As before the correctness follows since B does not contain $\max B - 1$. ◀

For the last case, where even and odd numbers are in B , we can additionally drop the remaining restriction that the equality nodes must have even degree. This is rather natural as a gap of size 2 already gives us a EQ_3 node by Lemma 5.4.

► **Lemma 5.8.** *If B contains even and odd numbers, we can B -realize the following relations by simple graphs:*

1. EQ_k for $k \geq 1$ using $\mathcal{O}(k \text{ poly}(\max B))$ vertices of degree at most $\max B$.
2. $\text{HW}_{=1}^{(k)}$ for $k \geq 1$ using $\mathcal{O}(k \text{ poly}(\max B))$ vertices of degree at most $\max B + 2$.

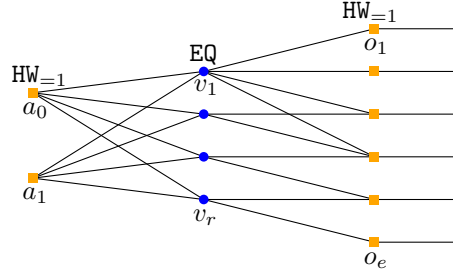

■ **Figure 5** An example illustrating the construction from the proof of Theorem 5.2 for the relation R with $R(000011) = R(110011) = R(111001) = R(111100) = 1$ and zero otherwise.

Proof. 1. The case $k = 2$ follows by Lemma 5.4.

For the remaining cases it suffices to B -realize EQ_1 . Then we make $d - 2 \geq 0$ many of these nodes adjacent to one EQ_{d+1} node. Adding three dangling edges and replacing all nodes recursively by their B -realization realizes EQ_3 . Then we can use a chain of these relations to realize EQ_k for all $k \geq 4$.

Let $b, c \in B$ such that $b < c$ with different parity. Force b edges on two new nodes u, v by making both adjacent to b many common nodes of type $\text{HW}_{=2}^{(2)}$. Then we make $\frac{c-b-1}{2}$ many EQ_2 nodes adjacent to u and add one dangling edge to it. The vertex v does not get any dangling edges but is always in a valid state, as all incident edges are selected. If the dangling edge incident to u is selected, then we also select the edges to the EQ_2 nodes. Otherwise no edge is selected except for the ones forced by the $\text{HW}_{=2}^{(2)}$ nodes.

2. We first realize $\text{HW}_{=1}^{(1)}$ to force single edges. For this let $o \in B$ be an odd number. Start with a new vertex and force $o - 1$ edges to it by making it adjacent to $\frac{o-1}{2}$ nodes of type $\text{HW}_{=2}^{(2)}$. Then we make this vertex adjacent to one more node of that type and add one dangling edge to it.

We only show the construction for $k = 2, 3$ and make use of Lemma 5.5 for larger k . Start by “duplicating” all ingoing edges using EQ_3 nodes from the first step. Force $a + d$ edges on a new vertex u and make it adjacent to one copy of each ingoing edge. Vertex u ensures that at least one of the ingoing edges is selected. The other copy of each ingoing edge is connected to a new vertex v . We force $\max B - 1$ edges to v . By this at most one of the ingoing edges has to be selected. ◀

Now we have everything ready to prove that even relations can be realized.

Proof of Theorem 5.2. See Figure 5 for an example of the following construction. We use essentially the construction from Lemma 3.3 in [13]. Let $R = \{x_1, \dots, x_r\} \subseteq \{0, 1\}^e$ be the even relation for some r . Let further $P = \{(1 + e \bmod 2), 0\}$.

1. Create nodes o_1, \dots, o_e with relation $\text{HW}_{=1}$.
2. Create vertices a_j for all $j \in P$ with relation $\text{HW}_{=1}$.
3. For all $i \in [r]$:
 - a. Let $O_i = \{n_1^{(i)}, \dots, n_{h_i}^{(i)}\} = \{k \in [e] \mid x_i[k] = 0\}$ for $h_i = e - \text{hw}(x_i)$.
 - b. Create the node v_i with relation EQ and connect it to $o_{n_j^{(i)}}$ for all $j \in [h_i]$.
 - c. Connect v_i to all a_j .
4. Replace all nodes by their realization.

There are $|P| + e$ many $\text{HW}_{=1}$ nodes. Since $|P| = 1 + (1 + e \bmod 2)$, we can replace pairs of these nodes by their realization. Every v_i is connected to $|P| + |O_i|$ nodes, where

$|O_i| = e - \text{hw}(x_i)$. Thus, v_i has even degree as the relation R is even, i.e. $\text{hw}(x)$ is even. Hence, we can replace these nodes by their realization according to the previous lemmas.

To show that the construction actually realizes the relation, assume the selected dangling edges corresponds to some element $x \in R$, let it w.l.o.g. be x_1 . Then we can select all edges incident to x_1 , the dangling edges, and the extension of this to all nodes as a solution. As x_1 is incident to all a_j they are in a valid state. Further x_1 is adjacent to those o_k where $x_1[k] = 0$ and hence every o_k is incident to exactly one edge in the solution.

Now assume we are given a solution. As the nodes a_j have exactly one incident edge in the solution, there is exactly one node v_i where all incident edges are in the solution. Let O be the set of nodes o_k to which v_i is incident. By construction v_i corresponds to some $x \in R$ with $x[k] = 0$ iff $k \in O$. As all selected dangling edges must be in the solution, let O' be the set of nodes incident to the selected dangling edges. But as we are given a solution we get $O \cup O' = \{o_1, \dots, o_e\}$. Hence, the dangling edges corresponds to x . ◀

6 Optimization Version

In the previous section we have seen the realization of the relations for the decision version. As we are interested in the largest solution for MAX- B -FACTOR, we also allow $0 \in B$ since this does not make the problem trivially solvable. This makes it necessary to change the definition of a realization, as the pure existence of a solution is not sufficient anymore. We change it such that if the relation is satisfied (i.e. the dangling edges are selected in a good way), then there is a *large* solution. Otherwise, there must be a gap by which any solution is *smaller* compared to the solutions in the good cases. We call this gap the penalty (of the realization).

► **Definition 6.1** (Realization). *Let $R \subseteq \{0, 1\}^k$ be a relation. Let G be a node labeled graph, with dangling edges $D = \{d_1, \dots, d_k\}$. We say that graph G realizes R with penalty β if we can efficiently construct/find a target value $\alpha > 0$ such that for all $D' \subseteq D$:*

- *If $D' \in R$, then there is a solution $S \subseteq E(G)$ with $S \cap D = D'$ and $|S| = \alpha$.*
- *If $D' \notin R$, then for all solutions $S \subseteq E(G)$ with $S \cap D = D'$ we have $|S| \leq \alpha - \beta$.*

We say that G B -realizes R if G is additionally B -homogeneous. We call the endpoints of the dangling edges portal nodes.

In the main part of this section we show how to realize the relations of B -FACTOR $^{\mathcal{R}}$. The following theorem corresponds to Theorem 5.2 for the decision version.

► **Theorem 6.2** (Realization of Relations). *Let $B \subseteq \mathbb{N}$ be a fixed, finite set with $\max\text{-gap } B > 1$ and $0 \in B$. There is a $f : \mathbb{N}^2 \rightarrow \mathbb{N}$ such that the following holds. Let $R \subseteq \{0, 1\}^e$ be a relation with a constant $c_R \in 2\mathbb{N}$ such that for all $x \in R$ we have $\text{hw}(x) = c_R$.*

We can B -realize the relation R with arbitrary penalty $\beta > 0$ by a simple graph with $f(e, \beta)$ vertices of degree at most $\max B + 2$.

► **Note.** Consider a graph G where we replaced nodes and their relations by realizations to get a graph G' . Then we say that a solution S for G' is *valid or good* if $S \cap E(G)$ is a solution for G . Otherwise the solution is *invalid or bad*. Consider a node v in G . Let I be the incident edges and E_v be the edges in G' resulting from replacing v by its realization. When considering a solution S for G , we say that $S \cap (I(v) \cup E_v)$ is the partial solution for the realization of v , i.e. all selected edges from the inserted graph and the incident edges.

It remains to compute the target value by which we decide if the B -FACTOR $^{\mathcal{R}}$ instance has a solution or not.

► **Lemma 6.3.** *Let G be a $B\text{-FACTOR}^{\mathcal{R}}$ instance from Section 4. Let G' be a $B\text{-FACTOR}$ instance resulting from G by replacing every complex nodes with degree δ by its realization with penalty 2δ . Then, there is an efficiently computable constant α such that G has a solution if and only if the largest solution for G' has size α .*

Proof. By Corollary 4.8 the complex nodes form a vertex cover for the graph. Further note, that two complex nodes share at most two edges and by our definition of the relations exactly one edge from each such pair of edges is selected in a valid solution. Let X be the number of these pairs of edges.

Let α_v be the target value for the realization of complex node v . Then we define $\alpha := \sum_{v \in V_c} \alpha_v - X$. The negative term accounts for the edges between the complex nodes, as they are counted twice.

The “only if” direction of the claim follows directly by the definition of α . For the “if” direction assume G' has a solution of size at least α .

It suffices to show that this solution is valid, i.e. the relation of all complex nodes are satisfied. Then the solution for G follows directly by choosing the edges incident to the realizations of the complex node. Assume otherwise and let W be the set of complex nodes whose relation is not satisfied. As the relation of each $v \in W$ is not satisfied, we lose at least a factor of β_v . But as all incident edges of v could be selected, the size of the partial solution for v is at most $\alpha_v - \beta_v + \deg(v)$. But as we chose $\beta_v = 2 \deg(v)$, this solution has size at most $\alpha_v - \deg(v)$.

For $i \in \{0, 1, 2\}$, let Y_i be the number of selected *edges* between complex nodes, where i endpoints are in W . Then $Y_0 + Y_1 + Y_2$ corresponds to the total number of selected edges between complex nodes. As these edges are counted twice, they appear negative in the following bound for the total size:

$$\sum_{v \in W} \alpha_v - \deg(v) + \sum_{v \in V_c \setminus W} \alpha_v - Y_0 - Y_1 - Y_2$$

If we can show that this is strictly smaller than α , we get a contradiction to the assumption that the size of the solution is at least α and the solution is valid.

For $i \in \{0, 1, 2\}$, let X_i be the number of *pairs* of edges between complex nodes where i endpoints are contained in W . Observe that $X_0 + X_1 + X_2 = X$. Now it suffices to show:

$$-\sum_{x \in W} \deg(v) - Y_0 - Y_1 - Y_2 < -X_0 - X_1 - X_2$$

For each pair of edges contributing to X_0 , there is exactly one edge selected, as the relation of both endpoints is satisfied. This implies $X_0 = Y_0$. Further, for all pairs of edges contributing to X_1 , we know that exactly one edge of this pair is selected. Otherwise, the relation of both nodes would not be satisfied and both nodes would be in W , thus $X_1 = Y_1$. Hence, it remains to show

$$X_2 < \sum_{x \in W} \deg(v) + Y_2$$

Each pair of edges contributing to X_2 has two endpoints in W . We could split X_2 according to the contribution of each node in W . As each node in W can definitely contribute only to at most $\deg(v)/2$ pairs (strictly speaking actually only 2), this finishes the proof. ◀

Now we are ready to prove the conditional lower bound for $\text{MAX-}B\text{-FACTOR}$ when $0 \in B$.

Proof of Theorem 1.5. Use Lemma 6.3 to construct the final graph and the target value. Then the proof goes analogous to the proof for the decision version (cf. Theorem 1.4). ◀

6.1 High Girth Graphs

Our definition of realizations includes the dangling edges in the solution size. We also define a slight variation where the dangling edges are not included. While both definitions are equivalent for $\text{HW}_{=k}$ nodes, they differ for $\text{HW}_{\in S}$ nodes. The *internal realization* of a node can be seen as a realization, where we do not adjust the solution size according to the number of selected dangling edges, i.e. only the internal edges are considered for the solution size.

► **Definition 6.4** (Internal Realization). *Let $R \subseteq \{0, 1\}^k$ be a relation. Let G be a node labeled graph, with dangling edges $D = \{d_1, \dots, d_k\} \subseteq E(G)$. G internally realizes R with penalty β if we can efficiently construct/find an $\alpha > 0$ such that for all $D' \subseteq D$:*

- *If $D' \in R$, then there is a solution $S \subseteq E(G)$ with $S \cap D = D'$ and $|S \setminus D| = \alpha$.*
- *If $D' \notin R$, then for all solutions $S \subseteq E(G)$ with $S \cap D = D'$ we have $|S \setminus D| \leq \alpha - \beta$.*

We say that G internally B -realizes R if G is additionally B -homogeneous.

We know that there is a gap of size at least two between a and $a + d + 1$ in B . This allows us to define relatively simple conditions of the form “if one incident edge of a vertex with degree $a + d + 1$ is not selected, then another edge is also not selected”. In other words, this propagates the penalty to a neighboring vertex. We combine this with high girth graphs to introduce an arbitrary large penalty for not selecting an edge.

The construction of r regular graphs with girth g is a long studied problem in graph theory. Erdős and Sachs proved the existence of such graphs for all combinations of r and g .

► **Lemma 6.5** (Theorem 1 in [23]). *For all $r \geq 2$ and $g \geq 3$, there is a r -regular graph $G_{r,g}$ of girth g with at most $4gr^g$ vertices.*

Finding the smallest graph for each r, g is a non-trivial task and known as the (r, g) -cage problem. For several cases (e.g. r is a prime power) constructions are known reducing the number of vertices in the graph. See [18, 24, 30, 34] for more results.

6.2 Realizing Relations

From now on let $d := \max\text{-gap } B > 1$ such that $[a, a + d + 1] \cap B = \{a, a + d + 1\}$ for some $a \geq 0$. As we allow $0 \in B$, we can always find a trivial solution. Thus, we cannot force edges as we did for the decision version. Instead we construct a gadget where we can select many edges when the “forced” edges are selected. Otherwise we ensure that the solution is small. We use the graphs with high girth for this.

► **Lemma 6.6.** *There is a $f : \mathbb{N} \rightarrow \mathbb{N}$ such that the following holds. We can B -realize $\text{HW}_{=2}^{(2)}$ (with distinct portal vertices) and internally B -realize EQ_{d+1} with arbitrary penalty β by simple graphs using at most $f(\beta)$ vertices of degree at most $\max B$.*

Proof. 1. For $\text{HW}_{=2}^{(2)}$ we use Lemma 6.5 to get an $a + d + 1$ -regular graph $G_{a+d+1, \beta}$ of girth at least β . Split an arbitrary edge (u, v) into two dangling edges for u and v each and assign the set B to every vertex.

The graph has the claimed properties: If both dangling edges are selected, then we can use the set of all edges in the graph as a solution since $a + d + 1 \in B$.

It remains to check the case when at least one dangling edge is not selected, let it w.l.o.g. be the one incident to u . Assume S is the optimal solution. We show that this solution does not contain more than $|E_{a+d+1, \beta}| - \beta$ edges.

By assumption $\deg_S(u) \leq a$. Hence, there must be at least one other incident edge to u that is not in the solution, because $a + d - 1 \geq a + 1 \notin B$. Then we can apply this

argument always to the next vertex. Observe that this sequence can only stop if we reach another vertex w we have already visited because for this vertex we already know that two incident edges were not selected in the solution. The length of this path, i.e. the number of not selected edges from w to w , is at least the girth of the graph. Hence the number of edges that are not selected in the solution is at least the girth of the graph which is at least β .

2. For EQ_{d+1} we start with two vertices u and v and make both adjacent to a many common $\text{HW}_{=2}^{(2)}$ nodes with penalty $\beta + 2$. Add $d + 1$ dangling edges to one of the vertices and zero to the other. As the vertices connected to the dangling edges in the realization of the $\text{HW}_{=2}^{(2)}$ nodes are different, the graph is simple.

If $d + 1$ or 0 dangling edges are selected, we can choose all internal edges for the optimal solution S , as $a + d + 1, a \in B$. The size of the solution is in both cases optimal.

Now assume $0 < \ell < d + 1$ dangling edges are selected. From $a + \ell \notin B$ it follows that there must be at least one $\text{HW}_{=2}^{(2)}$ node where at least one incident edge is not selected. By this we lose at least $\beta + 1$ compared to the optimal solution. \blacktriangleleft

As for the decision version, we now realize relations used for the general construction.

► **Lemma 6.7.** *There is a $f : \mathbb{N}^2 \rightarrow \mathbb{N}$ such that the following holds. We can B -realize a pair of $\text{HW}_{=1}^{(k)}$ and $\text{HW}_{=1}^{(\ell)}$ for any $k, \ell \geq 1$ with arbitrary penalty β with simple graphs using at most $f(k + \ell, \beta)$ vertices of degree at most $\max B + 2$.*

For the proof of the lemma we reuse the construction we have already seen for the decision version, by which an explicit construction of these nodes for $k, \ell \in \{1, 2, 3\}$ is sufficient. To realize these relations we distinguish between the cases $\max B - 1 \in B$ or not. By this the proof of Lemma 6.7 follows from Lemmas 6.8–6.10.

► **Lemma 6.8.** *If we can B -realize $\text{HW}_{=1}^{(a)}$ together with $\text{HW}_{=1}^{(b)}$ for $a, b \in \{1, 2, 3\}$, with arbitrary penalty β using simple graphs with at most N vertices of degree at most D , then we can B -realize $\text{HW}_{=1}^{(k)}$ together with $\text{HW}_{=1}^{(\ell)}$ for all $k, \ell \geq 1$ with arbitrary penalty β using simple graphs using $\mathcal{O}((k + \ell)N)$ vertices of degree at most D .*

Proof. We use the same construction as for the decision version as stated in Lemma 5.5. We use $\beta + 3$ as penalty for the realizations. The target value is the sum of the α s of all involved nodes minus the number of $\text{HW}_{=1}^{(2)}$ nodes used to connect the other nodes. This negative term takes care that we do not count edges twice.

For the correctness we observe that there could be solutions that do not satisfy the relations of all nodes. Note that each node has degree at most 3 and is incident to exactly one selected edge for a valid solution. Hence, for every such pair of additionally selected edges, there is at least one node not in a valid state. By its penalty of $\beta + 3$, it can compensate for these additional edges. Hence, these solutions are smaller by at least β . \blacktriangleleft

For the case $\max B - 1 \notin B$, we use the same approach as for the decision version when all elements of B are even.

► **Lemma 6.9.** *There is a $f : \mathbb{N} \rightarrow \mathbb{N}$ such that the following holds. If $\max B - 1 \notin B$, we can B -realize a pair of $\text{HW}_{=1}^{(k)}$ and $\text{HW}_{=1}^{(\ell)}$ for $k, \ell \in \{1, 2, 3\}$ with arbitrary penalty β with simple graphs using at most $f(\beta)$ vertices of degree at most $\max B + 2$.*

Proof. Start with two vertices u, v . Connect both to $\max B - 1$ common nodes of type $\text{HW}_{=2}^{(2)}$. Add k dangling edges to u and ℓ dangling edges to v . Replace all nodes by their realization with penalty $\beta + k + \ell$. The target value α is the sum of target values of the $\text{HW}_{=2}^{(2)}$ plus 2 for two selected dangling edges.

Assume exactly one dangling edge to each u and v is selected. Then we can extend this to a solution for the $\text{HW}_{=2}^{(2)}$ nodes, by selecting all internal edges.

If for u or v no dangling edge is selected, then there must be at least one $\text{HW}_{=2}^{(2)}$ node which is not incident to two edges in the optimal solution as $\max B - 1 \notin B$. Hence, we lose a penalty of $\beta + k + \ell \geq \beta$. Now let $\hat{k}, \hat{\ell}$ dangling edges of u, v be selected, respectively, such that $\hat{k} > 1$ or $\hat{\ell} > 1$. W.l.o.g. assume $\hat{k} > 1$. Then at least one edge between u and a $\text{HW}_{=2}^{(2)}$ node is not selected, as $\max B - 1 + \hat{k} > \max B$. Hence, the $\text{HW}_{=2}^{(2)}$ node is not incident to two edges and we lose a factor of $\beta + k + \ell$. As $\hat{k} + \hat{\ell} \leq k + \ell$, we still lose β compared to the optimal solution in the good case. ◀

For the case $\max B - 1 \in B$, we use an approach that is similar to the decision version, when B contains even and odd numbers. But as we cannot use an EQ_3 node, the construction gets slightly more complicated as we have to handle the additional edges of a EQ_{d+1} node.

► **Lemma 6.10.** *There is a $f : \mathbb{N} \rightarrow \mathbb{N}$ such that the following holds. If $\max B - 1 \in B$, we can B -realize a node $\text{HW}_{=1}^{(k)}$ for $k \in \{1, 2, 3\}$ with arbitrary penalty β with simple graphs using at most $f(\beta)$ vertices of degree at most $\max B + 2$.*

Proof. We first prove the claim for $k = 1$, which we need for the proof of the other cases.

▷ **Claim 6.11.** *There is a $f' : \mathbb{N} \rightarrow \mathbb{N}$ such that we can B -realize $\text{HW}_{=1}^{(1)}$ with arbitrary penalty β with simple graphs using at most $f'(\beta)$ vertices of degree at most $\max B$.*

Proof. We use the same approach as for the decision version and let v be a new vertex. Let o be the odd number of $\max B - 1$ and $\max B$. We force $o - 1$ edges to the vertex by adding $\frac{o-1}{2}$ $\text{HW}_{=2}^{(2)}$ nodes to it. We introduce one more $\text{HW}_{=2}^{(2)}$ node u . We add one edge between u and v and add one dangling edge to u . We replace all nodes by their realization according to Lemma 6.6 with penalty $\beta + 1$. The target value is the sum of all target values of the $\text{HW}_{=2}^{(2)}$ nodes.

If the dangling edge is selected, then we can select all other edges. Vertex v is then incident to $2 \cdot \frac{o-1}{2} + 1 = o \in B$ edges. But if the dangling edge is not selected, the node u cannot be in a valid state and we lose at least β compared to the optimal solution. ◀

Now we prove the construction for $k = 2, 3$. See Figure 6a for an example of the construction. We create vertices u_1, \dots, u_{d-1} and v . We force $\max B - 1$ edges on u_j for all $j \in [d - 1]$ and $a + d$ edges on v with nodes from the previous claim. We further introduce nodes s_1, \dots, s_k with relation EQ_{d+1} . We make each of the s_i adjacent to the vertices u_1, \dots, u_{d-1}, v . Finally, we add one dangling edge to each s_i . The vertices u_j ensure that *at most one* dangling edge is selected while v makes sure that *at least one* is selected. We replace all nodes by their realization with a penalty of $\beta + 3$. The target value is the sum of all target values of the realizations for the nodes, plus $d + 1$ accounting for the selected edges, when one dangling edge is selected. Observe that the edges forced by the $\text{HW}_{=1}^{(1)}$ nodes are usually part of any solution. Hence, we only have to focus on the edges incident to the nodes with EQ_{d+1} , as they are only internally realized. Note, this simplification can lead to solutions of negative size, when considering the penalty.

Assume only the dangling edge of s_i is selected. Then we select the edges incident to s_i as a solution of size $d + 1$.

If no dangling edge is selected, then the vertex v cannot be in a valid state or one of the s_i is not in a valid state. This bounds the solution size by $d - (\beta + 3) \leq d + 1 - \beta$.

Now assume $\ell > 1$ dangling edges are selected. W.l.o.g. we can assume that none of the s_i is in an invalid state, as this would lead to a solution smaller than for some appropriate ℓ' .

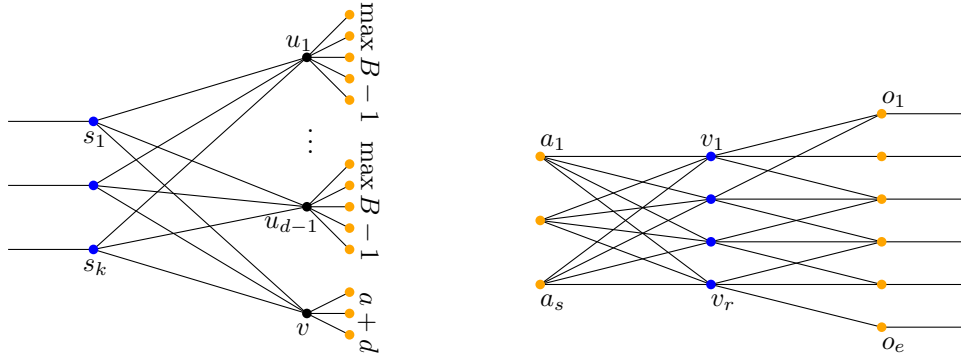

(a) Example construction for the proof of Lemma 6.10.

(b) Graph for the relation R with $R(000111) = R(010011) = R(110001) = R(111000) = 1$ and zero otherwise.

■ **Figure 6** Blue nodes have $\text{EQ}_{k(d+1)}$ as relation, light blue nodes have EQ_1 , black ones $\text{HW}_{\in B}$, and orange nodes have $\text{HW}_{=1}$.

As each of the $d-1$ vertices u_j cannot be incident to more than $\max B$ edges in any solution, for each selected dangling edge except the first one there must be an edge to an adjacent $\text{HW}_{=1}^{(1)}$ node that is not in the solution, i.e. the $\text{HW}_{=1}^{(1)}$ node is not in a valid state. This bounds the solution size by: $\ell(d+1) - (d-1)(\ell-1)(\beta+3)$. If we can bound this by $d+1-\beta$, the claim follows. But this is equivalent to show $(\ell-1)(d+1) + \beta \leq (d-1)(\ell-1)(\beta+3)$. As $\ell > 1$ and $d > 1$, it is easy to check that this claim holds true. ◀

Following the approach from the decision version, it remains to realize EQ_k nodes for even k . But the construction for the decision version cannot be transferred directly as it does not give us a realization. Recall, that we use a $d+2$ -clique of EQ_{d+1} nodes and split one edge into two dangling edges to realize EQ_2 . But if both dangling edges are selected, the solution has $\Theta(d^2)$ more edges compared to the solution when no dangling edge is selected. But surprisingly for $\text{EQ}_{k(d+1)}$ nodes a realization can be constructed. So we use them for our construction.

► **Lemma 6.12.** *There is a function $f : \mathbb{N}^2 \rightarrow \mathbb{N}$ such that the following holds. For arbitrary $k \geq 1$ we can B -realize $\text{EQ}_{k(d+1)}$ with arbitrary penalty β by simple graphs using $f(k, \beta)$ vertices of degree at most $\max B + 2$.*

Proof. Construct a d -regular connected bipartite graph with $k(d+1)$ nodes of type EQ_{d+1} on each side. Let L be the set of nodes on the left side and R of the right side. Subdivide each edge by placing one $\text{HW}_{=1}^{(2)}$ node on each edge. Add one dangling edge to each node in L . On the right side we introduce k new nodes of type EQ_{d+1} . Make each node in R adjacent to exactly one of these nodes such that every node has degree $d+1$. Finally, replace all nodes by their (internal) realization that are guaranteed to exist as $d(d+1)$ is always even. Use $\beta + 2k(d+1)^2$ as penalty for all nodes. The target value is the sum of all target values of the realizations plus $k(d+1)$.

If all $k(d+1)$ dangling edges are selected, we can select all $k(d+1)^2$ edges on the left side of the graph and none of the edges on the right side as optimal solution. The converse holds for the case when no dangling edges are selected. No solution can select more edges than this, as each additionally selected edge, leads to one additional node in an invalid state, whose penalty can compensate that edge.

Now assume $0 < \ell < k(d+1)$ dangling edges are selected for some solution. Assume for contradictions sake that all nodes in L are in a valid state. But then there is a node in L that is in the 0-state and one node is in the $d+1$ -state. As our bipartite graph is connected, there are two such nodes that are additionally connected to the same node in R (by two subdivided edges). This implies that this node on the right side is not in a valid state. Hence, its penalty can even compensate the selection of all edges. \blacktriangleleft

Now we have everything together to realize almost arbitrary relations and prove the main theorem for the maximization version. See Figure 6b for an example of the construction.

Proof of Theorem 6.2. We use a slight variation of our construction for the decision version in Theorem 5.2 and hence the construction in [13] as we cannot realize EQ_k for arbitrary even k . We resolve this issue by using nodes with larger degree and add nodes that take care of the additional edges.

Let $R = \{x_1, \dots, x_r\} \subseteq \{0, 1\}^e$ be a relation, $c_R \in 2\mathbb{N}$ be the constant such that for all $x \in R$ we have $\text{hw}(x) = c_R$, and let $h := e - c_R$ be the number of 0s of each x_i . There is a unique integer $\ell > 0$ such that $2(\ell - 1)(d+1) < h + 1 \leq 2\ell(d+1)$. Let $s := 2\ell(d+1) - h$. We define the graph realizing R as follows:

1. Create nodes o_k for all $k \in [e]$ and assign the relation $\text{HW}_{=1}$ to them. Their degree is determined later, and by Lemma 6.7 not relevant for us.
2. Create nodes a_j for all $j \in [s]$ with relation $\text{HW}_{=1}$.
3. For all $i \in [r]$:
 - a. Create a node v_i with relation $\text{EQ}_{2\ell(d+1)}$.
 - b. Make v_i adjacent to a_j for all $j \in [s]$.
 - c. Let $O_i = \{n_1^{(i)}, \dots, n_h^{(i)}\} = \{k \in [e] \mid x_i[k] = 0\}$ and connect v_i to $o_{n_j^{(i)}}$ for all $j \in [h]$.

To get a B -homogeneous graph, we replace the nodes v_i by the realization from Lemma 6.12 which is possible since $h + s = 2\ell(d+1)$. All $\text{HW}_{=1}$ nodes, i.e. a_i and o_k , are replaced by their realization from Lemma 6.7. This is possible as $s + e = 2\ell(d+1) - h + e = 2\ell(d+1) + c_R$ is an even number. For all realizations we define the penalty to be β . Observe that we can see the nodes with $\text{HW}_{=1}$ as internal realizations. That is the target value for their realization does not include the incident edges in the count. Then the target value is the sum of all target values of the realizations plus c_R to account for the dangling edges.

When the selected dangling edges correspond to some element $x_i \in R$, we select all edges incident to v_i and the extension to the realizations of the nodes. Then all nodes are in a valid state. There is no larger solution, as then one of the $\text{HW}_{=1}$ nodes would be in an invalid state. Further, for the $\text{EQ}_{2\ell(d+1)}$ nodes it makes no difference if all incident edges are selected or not, as they are realized. As the number of selected dangling edges is always the same, the solution size is always the same.

Now assume we are given a solution, where the dangling edges do not corresponds to some $x \in R$. We show that this solution must be smaller by at least β compared to the optimal solution size. We can assume that all v_i nodes are in a valid state. Otherwise we would directly lose a factor of β for each of these node in an invalid state, as these are realized. Assume there is no v_i where all dangling edges are selected. Then all nodes a_j are in an invalid state, as each a_j is connected to all v_i . Hence, we lose a factor of at least β . If there is more than one v_i where all incident edges are selected, then by the same argument all a_j are in an invalid state as they are connected to at least two edges and we lose β . Hence, there must be exactly one v_i where all incident edges are selected. Then all nodes a_j are in a valid state. Let O' be the set of the remaining nodes adjacent to v_i in the solution. By design, this corresponds to a $x \in R$ with $x[k] = 0$ iff $k \in O'$. Let O'' be the nodes incident

to a dangling edge in the solution. Assume there is a $o \in O' \cap O''$. Then this node would be incident to two edges and we lose β . The same argument holds for nodes $o \notin O' \cup O''$. Hence, O' is the complement of O'' and the dangling edges correspond to an element of R , a contradiction. Thus, some node must be in an invalid state and the solution is smaller by at least β . \blacktriangleleft

7 Counting Version

From a certain perspective the optimization version can be seen as a relaxation of the decision version: The assumption $\min B > 0$ is dropped while still assuming $\max\text{-gap } B > 1$. For the counting version we now even drop this last assumption such that there might be no gap at all in B . Thus the only polynomial-time solvable cases for the counting version are $B = \{0\}$ and $B = \emptyset$ with one and zero solutions, respectively. This implies that we additionally must realize equality relations. Surprisingly this also reduces to realizing $\text{HW}_{=1}^{(1)}$ nodes in the end, i.e. forcing edges.

We use the Holant framework and lemmas and definitions analogous to those from [13]. A signature graph Ω is a graph with weights w_e for all edges e and all vertices are labeled by *signatures* $f_v : \{0, 1\}^{I(v)} \rightarrow \mathbb{Q}$, which are rational functions on the incidence vector $I(v)$ of the edges adjacent to v . We define $\text{Holant}(\Omega)$ to be the quantity

$$\sum_{x \in \{0,1\}^{E(\Omega)}} \prod_{e \in x} w_e \prod_{v \in V(\Omega)} f_v(x|_{I(v)}).$$

The Holant framework can be seen as a natural generalization of GENFAC. If each signature f_v is a symmetric Boolean function and each edge weight is 1, then it is exactly $\#\text{GENFAC}$. If additionally each vertex has signature $\text{HW}_{\in B}$, this corresponds to $\#B\text{-FACTOR}$.

► **Definition 7.1** ($\text{Holant}(F)$). *If F is a set of rational functions, we say that $\text{Holant}(F)$ is the set of all Holant problems where the signature graph has signatures only from F .*

► **Definition 7.2** (Gate). *A gate is a signature graph Γ , possibly containing a set $D \subseteq E(\Gamma)$ of dangling edges, all of which have edge weight 1. The signature realized by Γ is the function $\text{SIG}(\Gamma) : \{0, 1\}^D \rightarrow \mathbb{Q}$ that maps an assignment of dangling edges $x \in \{0, 1\}^D$ to*

$$\text{SIG}(\Gamma, x) = \sum_{y \in \{0,1\}^{E(\Gamma) \setminus D}} \left(\prod_{e \in E(\Gamma)} w(e) \prod_{v \in V(\Gamma)} f_v((x \cup y)|_{I(v)}) \right)$$

Note that unless mentioned otherwise, we restrict ourselves to signature graphs with unit edge weights and hence they are usually omitted.

In essence, gates in the Holant framework play the role of realizations in the previous sections. Given these definitions, we are now ready to state our main theorem, which can then be used to prove Theorem 1.6.

► **Theorem 7.3.** *For all fixed, finite $B \subseteq \mathbb{N}$ with $B \neq \{0\}$ there is a $f : \mathbb{N} \rightarrow \mathbb{N}$ such that the following holds. Let $G = (V_S \dot{\cup} V_C, E)$ be an instance of $\#B\text{-FACTOR}^{\mathcal{R}}$ with a path decomposition of width pw such that $\Delta^* = \max_{\text{bag}} X \sum_{v \in X \cap V_C} \deg(v)$. Then there is a $f(\Delta^*)n^{\mathcal{O}(1)}$ time Turing reduction from $\#B\text{-FACTOR}^{\mathcal{R}}$ to $\#B\text{-FACTOR}$ such that for every constructed instance of $\#B\text{-FACTOR}$ pathwidth and cutwidth increase at most by $f(\Delta^*)$.*

We postpone the proof of this reduction and first show the lower bound for the counting version.

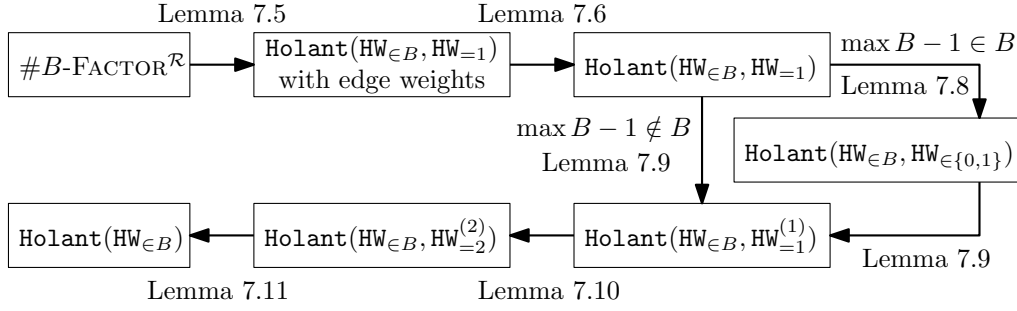

■ **Figure 7** The chain of reductions that starts with $\#B\text{-FACTOR}^{\mathcal{R}}$ and ends at $\#B\text{-FACTOR}$ (i.e. $\text{Holant}(\text{HW}_{\in B})$). Arrows show the direction of Turing or many-one reductions.

Proof of Theorem 1.6. Let H be a $\#B\text{-FACTOR}^{\mathcal{R}}$ instance with n_H nodes, pathwidth pw_H , and $\Delta^* = \max_{\text{bag } X} \sum_{v \in V_C \cap X} \deg(v)$. Then by Theorem 7.3, we get polynomially many instances of $\#B\text{-FACTOR}$ such that $n_G \in (n_H + \Delta^* + f(\Delta^*))^{\mathcal{O}(1)}$ with the f from the above theorem where $\text{pw}_G \leq \text{pw}_H + f(\Delta^*)$. Now, suppose that we can solve $\#B\text{-FACTOR}$ in the claimed running time. Then we can solve $\#B\text{-FACTOR}^{\mathcal{R}}$ in time

$$\begin{aligned} (\max B + 1 - \epsilon)^{\text{pw}_G} \cdot n_G^{\mathcal{O}(1)} &\leq (\max B + 1 - \epsilon)^{\text{pw}_H + f(\Delta^*)} \cdot (n_H + f(\Delta^*))^{\mathcal{O}(1)} \\ &\leq (\max B + 1 - \epsilon)^{\text{pw}_H + f(\Delta^*)} \cdot f'(\Delta^*) \cdot n_H^{\mathcal{O}(1)} \\ &\leq (\max B + 1 - \epsilon)^{\text{pw}_H + f''(\Delta^*)} \cdot n_H^{\mathcal{O}(1)} \end{aligned}$$

for some f' and f'' . But this immediately contradicts $\#\text{SETH}$ by Corollary 4.7. ◀

We can think of $\#B\text{-FACTOR}^{\mathcal{R}}$ as a Holant problem where the allowed signatures are either $\text{HW}_{\in B}$ or restricted even relations. We first use a lemma from [13] to realize these relations through nodes with signature $\text{HW}_{=1}$. Since their constructions are in the perfect matching setting, they can equivalently be seen as gates that use vertices with signature $\text{HW}_{=1}$. After using this lemma to reduce from $\#B\text{-FACTOR}^{\mathcal{R}}$ to a Holant problem, we give a chain of reductions (see Figure 7) that ends at $\#B\text{-FACTOR}$ and preserves the pathwidth up to an additive constant.

► **Lemma 7.4** (Lemma 3.3 from [13]). *Let $R \subseteq \{0, 1\}^e$ be an even relation. Then there is a gate Γ that can realize it such that*

- Γ only uses vertices with signature $\text{HW}_{=1}$.
- Γ has $\mathcal{O}(|R| \cdot e)$ vertices and edges.
- Γ has maximum degree at most $|R| + \mathcal{O}(1)$.
- the edges of Γ have weights from $\{-1, \frac{1}{2}, 1\}$.
- given R as input, we can construct Γ in time $\mathcal{O}(|R| \cdot e)$.

► **Lemma 7.5.** $\#B\text{-FACTOR}^{\mathcal{R}}$ reduces in polynomial time to $\text{Holant}(\text{HW}_{\in B}, \text{HW}_{=1})$ with edge weights from $\{-1, \frac{1}{2}, 1\}$ such that the pathwidth and cutwidth increase at most by a constant c_{Δ^*} depending only on Δ^* , where Δ^* is the maximum total degree of the complex nodes in any bag of the path decomposition, and the maximum degree is unaffected, or increases to 6.

Proof. We replace the complex nodes with the appropriate gates from Lemma 7.4. This gives us an instance of $\text{Holant}(\text{HW}_{\in B}, \text{HW}_{=1})$ with edge weights from $\{-1, \frac{1}{2}, 1\}$. Further, this only alters the pathwidth and cutwidth by an additive factor depending only on Δ^* . However, the construction via Lemma 7.4 can result in large degree $\text{HW}_{=1}$ nodes. These can be replaced by smaller degree $\text{HW}_{=1}$ nodes (see the construction for the decision version in Figure 4). ◀

Since $\#B$ -FACTOR does not have edge weights, removing them is the next step in our chain of reductions. We do this through polynomial interpolation. This technique was first used by Valiant [43]. We will also use this idea further down our chain of reductions, and give a general statement Proposition 7.7 to aid us in this process. The idea is that we can recover the coefficients of a polynomial $P(\cdot)$ if we know the value of $P(x)$ for sufficiently many x . We represent the solution of one problem as the value of a polynomial $P(\cdot)$ and represent the value of a second problem as some function $f(P)$ of the polynomial itself. Then, we can recover the value of the second problem through sufficiently many invocations to an oracle of the first problem. This gives us a Turing reduction from the second problem to the first.

► **Lemma 7.6.** *There is a polynomial time Turing reduction from $\text{Holant}(\text{HW}_{\in B}, \text{HW}_{=1})$ with edge weights from $\{-1, \frac{1}{2}, 1\}$ to $\text{Holant}(\text{HW}_{\in B}, \text{HW}_{=1})$ on unweighted graphs such that the pathwidth and cutwidth increase only by a fixed constant and the maximum degree increases to at least three.*

Proof. We follow the arguments from Theorem 4.1 of [13]. We replace $-1, \frac{1}{2}$ weight edges with weights x, y and treat $\text{Holant}(\Omega)$ as a polynomial in x, y . Then, we can recover this polynomial by interpolating with various values of x, y . We can choose the values for x, y from $\{2^i \mid i \in \mathbb{N}\}$ through the constructions from [13]: We replace the edges with weight 2^i by a path with $2i + 3$ edges where edges number $3, 5, \dots, 2i + 1$ have weight 2 and the other edges have weight 1. Then we replace these edges with weight 2 by two parallel edges and divide both edges by two nodes. All new nodes are labeled with $\text{HW}_{=1}$. Observe that this construction increases pathwidth and cutwidth only by a constant factor and the degree increases to at least 3. ◀

► **Proposition 7.7.** *Suppose we have two non-zero sequences $\{A_n\}_{n \in \mathbb{N}}, \{B_n\}_{n \in \mathbb{N}}$ that are related as*

$$\begin{bmatrix} A_n \\ B_n \end{bmatrix} = M \begin{bmatrix} A_{n-1} \\ B_{n-1} \end{bmatrix} = M^n U \quad , \text{ where } U = \begin{bmatrix} A_0 \\ B_0 \end{bmatrix}$$

and M is a symmetric and invertible 2×2 matrix such that U is not an eigenvector of M . Then $\{\frac{B_n}{A_n}\}_{n \in \mathbb{N}}$ is a sequence which does not contain any repetitions.

Proof. Suppose not. Then we have $\frac{B_n}{A_n} = \frac{B_{n+r}}{A_{n+r}}$ for some positive integers n, r . Then since $\{A_n\}, \{B_n\}$, are both non-zero sequences we have

$$k \begin{bmatrix} A_n \\ B_n \end{bmatrix} = \begin{bmatrix} A_{n+r} \\ B_{n+r} \end{bmatrix}$$

for some k . Then we have

$$k \begin{bmatrix} A_n \\ B_n \end{bmatrix} = k M^n U = M^{n+r} U = \begin{bmatrix} A_{n+r} \\ B_{n+r} \end{bmatrix} \xrightarrow{M \text{ invertible}} kU = M^r U$$

implying that U is an eigenvector of M^r . Now, since M is symmetric, it has two eigenvectors that are linearly independent. Since these are also eigenvectors of M^r and they are linearly independent, these are the only eigenvectors of M^r . Thus, U must also be an eigenvector of M , giving a contradiction. ◀

We will see why we need the following lemma in Lemma 7.9. Observe that a $\text{HW}_{=1}$ node can be thought of as a vertex with list $\{1\}$. To see the problem, consider the case when the list does not have gaps, for example like in $\{0, 1, 2, 3, 4\}$. Then it is not immediate how to get a node whose list has 1 but does not have 0. We avoid this by doing interpolation.

► **Lemma 7.8.** *There is a polynomial time Turing reduction from $\text{Holant}(\text{HW}_{\in B}, \text{HW}_{=1})$ to $\text{Holant}(\text{HW}_{\in B}, \text{HW}_{\in\{0,1\}})$ such that pathwidth and cutwidth increase at most by 1.*

Proof. Suppose we have an instance Ω of $\text{Holant}(\text{HW}_{\in B}, \text{HW}_{=1})$. We construct a new signature grid Ω' by replacing all $\text{HW}_{=1}$ vertices with $\text{HW}_{\in\{0,1\}}$ vertices. Let this set of $\text{HW}_{\in\{0,1\}}$ vertices be U . We note that $\text{Holant}(\Omega')$ can be thought of as the summation of $2^{|U|}$ Holants, where each vertex in U is assigned to either $\text{HW}_{=0}$ or $\text{HW}_{=1}$. Define A_i as the partial summation of the Holants on Ω' where i vertices from U are assigned $\text{HW}_{=1}$ and the rest are assigned $\text{HW}_{=0}$. That is, we have that $\text{Holant}(\Omega') = \sum_{i=0}^{|U|} A_i$.

Now for an integer $d \geq 1$, we construct a new graph Ω'_d by attaching a length- d path of $\text{HW}_{\in\{0,1\}}$ to every node in U . Let $P_1(d)$ be the number of solutions when the leading edge of the path is selected, and similarly let $P_0(d)$ be the number of solutions when the leading edge of the path is not selected. Then we have

$$\text{Holant}(\Omega'_d) = \sum_{i=0}^{|U|} A_i (P_0(d))^i (P_0(d) + P_1(d))^{|U|-i} = (P_0(d))^{|U|} \sum_{i=0}^{|U|} A_i \left(\frac{P_0(d) + P_1(d)}{P_0(d)} \right)^i.$$

We claim that by interpolation on d , we can recover the values of A_i for any i . In particular, $A_{|U|}$ will correspond to $\text{Holant}(\Omega)$. To show this, we only need to argue that $\frac{P_0(d) + P_1(d)}{P_0(d)}$ will take at least $|U|$ unique values, and that these are computable in polynomial time. Now, since P_0, P_1 can be defined for any integral path length d , we have the relation

$$P_0(d) = P_1(d-1) + P_0(d-1) \quad \text{and} \quad P_1(d) = P_0(d-1).$$

Then, applying Proposition 7.7 with $M = \begin{bmatrix} 1 & 1 \\ 1 & 0 \end{bmatrix}$ and $U = \begin{bmatrix} 1 \\ 1 \end{bmatrix}$, and since $P_0(d), P_1(d) > 0$ for every d , we get the required statement. Since we are only attaching a path to certain vertices, this does not alter the pathwidth or cutwidth by more than 1. ◀

► **Lemma 7.9.** *For every finite list $B \subseteq \mathbb{N}$, there is a polynomial time many-one reduction from*

- $\text{Holant}(\text{HW}_{\in B}, \text{HW}_{\in\{0,1\}})$ if $\max B - 1 \in B$,
- $\text{Holant}(\text{HW}_{\in B}, \text{HW}_{=1})$ if $\max B - 1 \notin B$,

to $\text{Holant}(\text{HW}_{\in B}, \text{HW}_{=1}^{(1)})$ increasing pathwidth and cutwidth by a fixed constant and increasing the degrees of the $\text{HW}_{\in\{0,1\}}$ or $\text{HW}_{=1}$ nodes by at most $\max B$.

Proof. Consider any instance Ω of $\text{Holant}(\text{HW}_{\in B}, \text{HW}_{=1})$ or $\text{Holant}(\text{HW}_{\in B}, \text{HW}_{\in\{0,1\}})$. It suffices to alter the nodes labeled with $\text{HW}_{=1}$ or $\text{HW}_{\in\{0,1\}}$: We replace each of them by a new node with relation $\text{HW}_{\in B}$ and force $\max B - 1$ edges by adding the same number of pendant nodes with relation $\text{HW}_{=1}^{(1)}$. Depending on whether $\max B - 1 \in B$ or not, we get a $\text{HW}_{\in\{0,1\}}$ or a $\text{HW}_{=1}$ node. Since we are adding $\max B - 1$ pendant nodes to certain vertices, the pathwidth increases at most by 1 and the cutwidth increases by at most $\max B - 1$. ◀

At this stage, we only need to realize $\text{HW}_{=1}^{(1)}$ nodes. We will see that this is possible, but that there are some caveats. Like before, in the case where B only has even integers, some parity issues force us to be able to realize only an even number of $\text{HW}_{=1}^{(1)}$ nodes. This can be seen as realizing $\text{HW}_{=2}^{(2)}$ nodes instead.

► **Lemma 7.10.** *For every fixed, finite list $B \subseteq \mathbb{N}$, there is a polynomial time many-one reduction from $\text{Holant}(\text{HW}_{\in B}, \text{HW}_{=1}^{(1)})$ to $\text{Holant}(\text{HW}_{\in B}, \text{HW}_{=2}^{(2)})$ increasing pathwidth and cutwidth only by a fixed constant and leaving the maximum degree unaffected, or increasing it to at most $\max B$.*

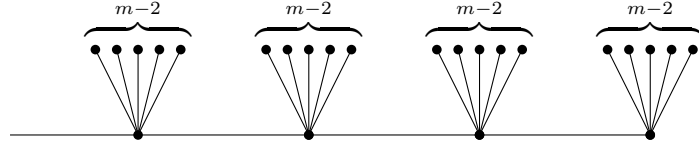

■ **Figure 8** The gadget for case 1: Black nodes are $\text{HW}_{\in B}$ nodes.

Proof. We claim that without loss of generality, we can assume that we have an even number of $\text{HW}_{=1}^{(1)}$ nodes. Suppose not. Then we consider two cases.

- If B has some odd number k , then we add a separate component with one $\text{HW}_{\in B}$ node connected to k $\text{HW}_{=1}^{(1)}$ nodes. This brings the total number of $\text{HW}_{=1}^{(1)}$ nodes to be even. As this component is a star graph, pathwidth does not change. Cutwidth increases by at most $\max B$.
- If B only has even numbers, then we claim that $\text{Holant}(G)$ is zero. Consider the sum of the degrees of the nodes in any solution. The nodes with relation $\text{HW}_{=1}^{(1)}$ contribute an odd number, whereas the other nodes with relation $\text{HW}_{\in B}$ can only contribute an even number. Thus, their sum must be odd. This contradicts the fact that the sum of the degrees of the vertices in any graph must be even.

Let X_1, X_2, X_3, \dots be the bags of some nice path decomposition of G , i.e. there is especially a unique introduce node for every vertex. Let $U = \{v_1, \dots, v_{|U|}\}$ be the set of $\text{HW}_{=1}^{(1)}$ nodes of G , such that $\text{int}(i) < \text{int}(i+1)$ for all i , where $\text{int}(i)$ is the index of the bag introducing v_i . For all $i \in [|U|]$, replace v_i by a $\text{HW}_{=2}^{(2)}$ node keeping the incident edge. Then connect v_{2i-1} and v_{2i} by an edge. We add v_{2i-1} to the bags $X_{\text{int}(2i-1)+1}, \dots, X_{\text{int}(2i)}$. By assumption, there is no v_ℓ introduced in these bags and hence, the pathwidth increases by at most 1. Further, the degree of the graph does not increase as we can assume w.l.o.g. that it is already at least 2.

The result directly transfers to cutwidth when using a linear layout instead. ◀

The following lemma completes the chain of reductions by handling $\text{HW}_{=2}^{(2)}$ relations. For the proof, we need to consider different cases depending on whether B contains 0, 1, or some odd number.

► **Lemma 7.11.** *Let $B \subseteq \mathbb{N}$ be a fixed finite set. There is a polynomial-time Turing reduction from $\text{Holant}(\text{HW}_{\in B}, \text{HW}_{=2}^{(2)})$ to $\text{Holant}(\text{HW}_{\in B})$ increasing pathwidth and cutwidth only by a fixed constant and leaving the max degree unaffected, or increasing it to $2 \max B + 6$.*

Proof. If $0 \notin B$, we can use the construction from Lemma 5.4 to get a $\text{HW}_{=2}^{(2)}$ node. For the case when $0 \in B$, we do a case-by-case analysis depending on B . In either case, we attach a subgraph with a constant pathwidth and cutwidth to vertices. This does not affect either of them by more than $2 \max B + 6$, a fixed constant.

Case 1: B contains 1

Define $m \geq 2$ to be the smallest integer not in B . Consider the gadget in Figure 8. Suppose there are d such vertices with $m - 2$ pendant nodes each. Let all of them have the relation $\text{HW}_{\in B}$. Let $P_1(d)$ be the number of solutions of the gadget where the dangling edge is selected in the solution. Similarly define $P_0(d)$ when the dangling edge is not selected. We claim that the gadget described can be effectively used to force edges, i.e. a $\text{HW}_{=1}^{(1)}$ node. Two such

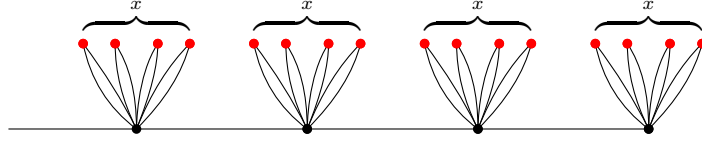

■ **Figure 9** Gadget for case 2: Red nodes are EQ_2 nodes and black nodes are $\text{HW}_{\in B}$ nodes.

gadgets will give us a $\text{HW}_{=2}^{(2)}$ node. Suppose any graph G contains t such gadgets. We have

$$\text{Holant}(G) = \sum_{i=0}^t A_i (P_0(d))^{t-i} (P_1(d))^i = (P_0(d))^t \sum_{i=0}^t A_i \left(\frac{P_1(d)}{P_0(d)} \right)^i$$

where A_i is the number of ways of extending the solution in G when i of the gadgets choose to match their dangling edge. Through standard interpolation techniques, we can recover the A_i s, and thus A_t will give us the solution where each gadget behaves like a $\text{HW}_{=1}^{(1)}$. Now, we can replace $\text{HW}_{=2}^{(2)}$ nodes in the $\text{Holant}(\text{HW}_{\in B}, \text{HW}_{=2}^{(2)})$ instance with pairs of $\text{HW}_{=1}^{(1)}$ nodes.

To argue that we can do the interpolation, we need to show that $\frac{P_1(d)}{P_0(d)}$ will take at least t unique values, and that these are computable in polynomial time. Since we can define such a gadget for any integer d we have

$$P_0(d) = kP_0(d-1) + kP_1(d-1) \quad \text{and} \quad P_1(d) = kP_0(d-1) + (k-1)P_1(d-1)$$

for $k = 2^{m-2}$. We now apply Proposition 7.7 with $M = \begin{bmatrix} k & k \\ k & k-1 \end{bmatrix}$ and $U = \begin{bmatrix} k \\ k \end{bmatrix}$.

Case 2: B does not contain 1, but contains some odd number

In this case, we first observe that we can realize EQ_2 nodes. Let m be the smallest non-zero number in the list B . Then we make an $m+1$ -clique of vertices with signature $\text{HW}_{\in B}$ and remove one edge, say (u, v) . We add one dangling edge each to u, v . This gives us a EQ_2 node. We construct the gadget in Figure 9 to get a $\text{HW}_{=1}^{(1)}$ node. Note that any double edges can be removed by placing EQ_2 nodes on them.

We will fix the value of x later. Suppose there are d $\text{HW}_{\in B}$ nodes. Let $P_1(d)$ be the number of solutions of the gadget where the dangling edge is selected in the solution. Similarly define $P_0(d)$ when the dangling edge is not selected. We claim that this can be used to force edges. Suppose any graph G contains t such gadgets. Then like before, we have

$$\text{Holant}(G) = \sum_{i=0}^t A_i (P_0(d))^{t-i} (P_1(d))^i = (P_0(d))^t \sum_{i=0}^t A_i \left(\frac{P_1(d)}{P_0(d)} \right)^i$$

where A_i is the number of ways of extending the solution in G when i of the gadgets choose to match their dangling edge. We need to show that $\frac{P_1(d)}{P_0(d)}$ will take at least t unique values, and that these are computable in polynomial time.

We first define the following quantities.

$$F_0 = \sum_{i: 2i \in B} \binom{x}{i} \quad F_1 = \sum_{i: 2i+1 \in B} \binom{x}{i} \quad F_2 = \sum_{i: 2i+2 \in B} \binom{x}{i}.$$

Note, when these quantities are interpreted as a polynomial in x , each has degree at most $\lfloor \frac{\max B}{2} \rfloor$. For $j \in \{0, 1, 2\}$, F_j can be interpreted as the number of ways a $\text{HW}_{\in B}$ node can choose EQ_2 nodes given that j of its adjacent edges in the horizontal path are selected. Since

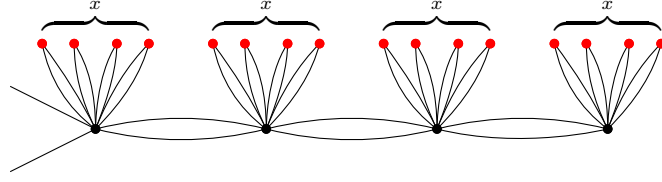

■ **Figure 10** Gadget for case 3: Red nodes are EQ_2 nodes constructed like before and black nodes are $\text{HW}_{\in B}$ nodes.

B contains some odd integer and some even integer (since $0 \in B$), we immediately get that $F_0, F_1 \geq 1$. This ensures that $P_0(d), P_1(d) > 0$ for every d . Then we have that the gadget follows the recurrence relation

$$P_0(d) = F_0 P_0(d-1) + F_1 P_1(d-1) \quad \text{and} \quad P_1(d) = F_1 P_0(d-1) + F_2 P_1(d-1).$$

To apply Proposition 7.7, we need to show that $M = \begin{bmatrix} F_0 & F_1 \\ F_1 & F_2 \end{bmatrix}$ is invertible and that $U = \begin{bmatrix} F_0 \\ F_1 \end{bmatrix}$ is not an eigenvector of M . To argue that M is invertible, we can consider $F_0 F_2 - (F_1)^2 = 0$ as a polynomial in x . Since it has degree at most $\max B$, it can have at most that many solutions. We pick x to be the smallest positive integer that is not a solution to the above polynomial. Then we have that $x \leq \max B + 1$. Now, to show that U is not an eigenvector of M , we show a contradiction. Consider the equation

$$\begin{bmatrix} F_0 & F_1 \\ F_1 & F_2 \end{bmatrix} \begin{bmatrix} F_0 \\ F_1 \end{bmatrix} = \lambda \begin{bmatrix} F_0 \\ F_1 \end{bmatrix} \quad \implies \quad \begin{aligned} (F_0)^2 + (F_1)^2 &= \lambda F_0 \\ (F_0 + F_2)F_1 &= \lambda F_1 \end{aligned}$$

Since $F_1 > 0$, we get $\lambda = F_0 + F_2$ from the last equation. This gives

$$(F_0)^2 + (F_1)^2 = F_0(F_0 + F_2) \quad \implies \quad (F_1)^2 = F_0 F_2.$$

This is a contradiction since we already chose x such that $F_0 F_2 - (F_1)^2 \neq 0$.

Case 3: B does not contain any odd number

We can use similar arguments as for the previous case, except that we modify the gadget. We replace the single edges with double edges to get the gadget from Figure 10. Like before, we can construct a EQ_2 node in this case and we can similarly remove any double edges by placing EQ_2 nodes on them.

The only thing that needs to be taken care of is the possibility that a solution might select one of the double edges of the horizontal path. But this is not possible since B does not contain any odd number and thus the terminal node must be incident to an even number of selected edges. Similarly, there is no solution where exactly one of the dangling edges is selected.

Let $P_2(d)$ be the number of solutions of the gadget where both the dangling edge are selected in the solution. Defining $P_1(d), P_0(d)$ the same way as before, we can argue that $P_1(d) = 0$ for any d . We can interpolate on $\frac{P_2(d)}{P_0(d)}$. To show that we can do this, define F_0, F_2 similarly. Let

$$F_4 = \sum_{i: 2i+4 \in B} \binom{x}{i}.$$

Then we have

$$P_0(d) = F_0 P_0(d-1) + F_2 P_2(d-1) \quad \text{and} \quad P_2(d) = F_2 P_0(d-1) + F_4 P_2(d-1).$$

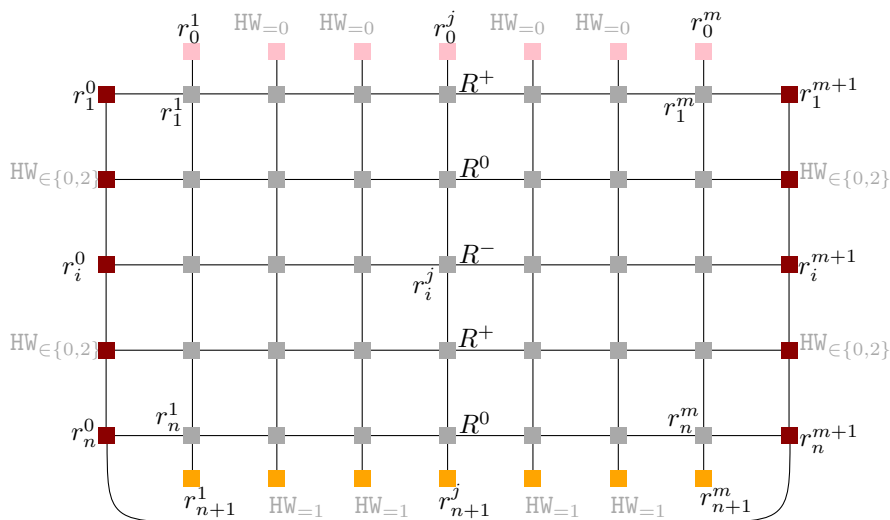

Figure 11 The example graph for a formula containing the clause $(x_1 \vee \bar{x}_3 \vee x_4)$.

We can apply the same arguments as before with $M = \begin{bmatrix} F_0 & F_2 \\ F_2 & F_4 \end{bmatrix}$ and $U = \begin{bmatrix} F_0 \\ F_2 \end{bmatrix}$. ◀

Proof of Theorem 7.3. We prove this through a chain of reductions. Given any instance of $\#B\text{-FACTOR}^{\mathcal{R}}$, we can sequentially apply Lemmas 7.5, 7.6, and 7.8–7.11 to get a polynomial number of instances of $\text{Holant}(\text{HW}_{\in B})$ such that the pathwidth is affected only by some function of Δ^* . As $\text{Holant}(\text{HW}_{\in B})$ is exactly $\#B\text{-FACTOR}$ the theorem follows. ◀

8 Lower Bound when Parameterizing by Cutwidth

The algorithmic result from Theorem 1.8 shows that the pathwidth lower bound breaks when parameterizing by cutwidth. Nevertheless, we can show that this “improved” running time is the best we can hope for assuming SETH and $\#SETH$. For this we use the same high level ideas Curticapean and Marx presented in Figure 6 of [13] where they reduce from $\#SAT$ to computing the Holant and then reduce to counting perfect matchings. But the construction can also be seen as a modification of our reduction for the pathwidth lower bound. We again first reduce to the intermediate problem $B\text{-FACTOR}^{\mathcal{R}}$ and then to $B\text{-FACTOR}$. By this we can reuse the results of realizing relations that we have seen in the previous sections.

► **Theorem 8.1.** *Let $B \subseteq \mathbb{N}$ be a fixed set of finite size. Given a CNF-formula ϕ with n variables and m clauses. We can construct a (simple) $B\text{-FACTOR}^{\mathcal{R}}$ instance G with $\mathcal{O}(nm)$ vertices, bounded degree and a linear layout of width $\text{cutw} \leq n + \mathcal{O}(1)$ in time linear in the output size. Further, the number of solutions for ϕ is equal to the number of solutions for G .*

8.1 High Level Construction

Recall, that for the pathwidth lower bound we grouped variables together. This was needed to keep the pathwidth of the construction low. But this increased the cutwidth of the graph. Now, we do not group variables together but encode each variable on its own. See Figure 11 for an example of the construction we describe formally in the following.

Let x_1, \dots, x_n be the variables and C_1, \dots, C_m the clauses of ϕ . For each $i \in [n]$ and every $j \in [m]$ we create a vertex r_i^j . We assign the relation R^+ to r_i^j if x_i appears positively

in C_j , R^- if it appears negatively, and otherwise R^0 , where R^0 , R^+ , and R^- are defined later. Additionally add vertices r_i^0 and r_i^{m+1} with relation $\text{HW}_{\in\{0,2\}}$ for all $i \in [n]$. We say that the vertices r_i^0, \dots, r_i^{m+1} form the i th *row*, i.e. the row of variable x_i . Create new nodes r_0^j and r_{n+1}^j and assign the relations $\text{HW}_{=0}$ and $\text{HW}_{=1}$ to them for all $j \in [m]$, respectively. We say the vertices $\{r_i^j\}_i$ form the j th *column*. We connect two nodes r_i^j and $r_{i'}^{j'}$ by an edge if $|i - i'| \leq 1$ and $|j - j'| \leq 1$ for all $i, i' \in [0, n + 1]$ and $j, j' \in [0, m + 1]$, i.e. if they are neighbors in the grid.

The idea is the same as for the pathwidth construction, except that selecting the edges of the i th row corresponds to setting the variable x_i to true. The edges between the nodes of a column represent if a clause is already satisfied. The relation $\text{HW}_{=0}$ ensures that we start with an initially unsatisfied clause. At each node r_i^j we check whether the assignment to this variable x_i satisfies the clause C_j and then force the output edge (i.e. the bottom edge) to be selected. Otherwise we propagate the current state (i.e. the selection of edges). Eventually we reach r_{n+1}^j with relation $\text{HW}_{=1}$ where the edge has to be selected and thus the clause must be satisfied.

The relations R^0 , R^+ , and R^- accept exactly those inputs that satisfy all of the following conditions:

1. The left edge is selected if and only if the right edge is selected.
2. If the top edge is selected, the bottom edge is selected.
3. Only for R^+ : If the top edge is unselected and the left edge is selected, then the bottom edge is selected.
4. Only for R^- : If the top edge is selected and the left edge is not selected, then the bottom edge is selected.

Final Modifications of the Construction. As for the pathwidth lower bound this construction does not fulfill all requirements of a $B\text{-FACTOR}^{\mathcal{R}}$ instance. To avoid these problems, we first apply the same set of modifications we had for the pathwidth bound. That is, adding a negated edge between r_i^j and r_{i+1}^j for all i and j . Further, we introduce the nodes \hat{r}_0^j and \hat{r}_{n+1}^j and connect them to the first and last node of a column. Then we modify the relations that always the negated edge is selected if and only if the positive edge is not selected. The last step merges the nodes r_0^j , r_{n+1}^j , \hat{r}_0^j , and \hat{r}_{n+1}^j together into a node r^j with appropriate relation.

But still the Hamming weight of the accepted inputs of the relations R^0 , R^+ , R^- , and $\text{HW}_{\in\{0,2\}}$ is not equal. Strictly speaking, the Hamming weights of the inputs of these relations differs by exactly 2. Hence, we add a loop to each node with such a relation. This loop is counted as two inputs that are set to true if the Hamming weight is too small. One can use $\text{HW}_{=2}^{(4)}$ nodes to replace (parallel edges and) loops to get a simple graph.

These modifications increase cutwidth only by additive terms. As they are mostly only needed for technical reasons we usually ignore them and only consider them when relevant for the proof. It remains to show the correctness of the construction and the bounds for the size and the cutwidth.

► **Lemma 8.2.** *If ϕ is satisfiable, then there is a solution for the $B\text{-FACTOR}^{\mathcal{R}}$ -instance.*

Proof. By the construction and the definition of the relations it directly follows that there is a solution for the $B\text{-FACTOR}^{\mathcal{R}}$ -instance. For this we choose for each clause the first variable that can satisfy it to select the bottom edge. Further observe that we put the edge from r_n^0 to r_n^{m+1} in the solution if the number of variables set to true is odd. ◀

► **Lemma 8.3.** *If there is a solution to the $B\text{-FACTOR}^{\mathcal{R}}$ instance, then ϕ is satisfiable.*

Proof. Observe that the edges in each row are either all selected or all not selected by the definition of R^0 , R^+ , and R^- . Hence, we can define a consistent assignment to the variables as follows: if the edges of the i th row are selected, set x_i to true and otherwise to false. For each j especially the relations at the vertices r_0^j and r_{n+1}^j are satisfied by the solution. Hence, the edges between the nodes of this column are neither all selected nor unselected. This implies that there is some $i \in [n]$ such that the top edge of r_i^j is not selected, but the bottom edge is selected. By definition, r_i^j cannot be labeled with R^0 . If the vertex is labeled with R^+ , this change can only happen if the edges of the row are selected. But then our assignment satisfies clause j . The same argument holds for the case when the vertex has relation R^- and the edges of the row are not selected. Since this holds for all j , all clauses and hence ϕ is satisfied. ◀

To obtain a tight lower bound we need to analyze the cutwidth of the graph.

► **Lemma 8.4.** *The graph has $\mathcal{O}(nm)$ nodes of constant degree. The graph has cutwidth at most $n + \mathcal{O}(1)$.*

Proof. To bound the cutwidth it suffices to give a linear layout with the stated width. For this we go through the graph column by column and enumerate the vertices from the top to the bottom. By this only the vertices of two columns have to be considered to determine the width of the cut. Each vertex has (at most) one edge to the other side of the cut (i.e. the edge to the next column). Only the last visited vertex can contribute more edges to the cut, but only constantly many. The merging of the four nodes into r^j increases cutwidth at most by 4. Including the additional edge from r_n^0 to r_n^{m+1} that is present in almost every cut, we get the claimed bound. ◀

As we have seen there is a one-to-one correspondence between satisfying assignment to the formula and selection of edges in the graph. For this to work, we crucially need that we cannot choose which variable is “responsible” for satisfying the clause as we always must choose the first such possibility in each column. Hence we get the following corollary.

► **Corollary 8.5.** *The reduction is parsimonious, i.e. it preserves the number of solutions.*

In the remaining part of the section we show the proof of the lower bounds by combining this construction with the previous results from Sections 5–7.

8.2 Decision Version

It suffices to combine the above reduction with the realization results from Section 5.

Proof of Theorem 1.9 (1). We use the construction from Theorem 8.1 to transform any formula into a B -FACTOR $^{\mathcal{R}}$ instance. Then we use Theorem 5.2 to replace every relation by its realization. This increases cutwidth at most by a constant factor. Executing the claimed algorithm with running time $(2 - \epsilon)^{\text{cutw}} n^{\mathcal{O}(1)}$ on this graph directly contradicts SETH. ◀

This directly implies the analog lower bound for MIN- B -FACTOR.

8.3 Optimization Version

Once more it suffices to only consider MAX- B -FACTOR if $0 \in B$. For the case $0 \notin B$ the hardness follows from the decision version. We use the same approach as before. Let G be a B -FACTOR $^{\mathcal{R}}$ instance obtained from Theorem 8.1. Replace all relations by their realization

according to Theorem 6.2 with penalty being twice the degree and let the resulting B -FACTOR instance be G' . We make use of the following lemma:

► **Lemma 8.6.** *For all pairs G, G' of graphs resulting from the above modification, there is an efficiently constructible constant γ such that G has a solution if and only if the largest solution for G' has size γ .*

Proof. As G only consists of complex nodes, we split each edge into two half-edges and assign both halves to their corresponding endpoint, to avoid counting edges twice.

Now let v be an arbitrary complex node in G . By the definition of realizations, there is an α_v such that any partial solution in G' that respects the relation of v (i.e. the correct edges are selected) has size exactly α_v (as the Hamming weight of all accepted inputs is equal, the α_v can take care of the half-edges). Otherwise the size of this partial solution is at most $\alpha_v - \beta_v$ where β_v is the penalty for this realization. Recall, that we added loops to most nodes such that we can replace the relations by their realization. We define δ_v for each node to take care of this. For the nodes r^j we have $\delta_v = 0$ while we set $\delta_v = 1$ for all other nodes. We define $\gamma_v = \alpha_v + \delta_v$ and set $\gamma := \sum_{v \in V(G')} \gamma_v$. By assumption the α s are efficiently constructible, so is γ .

The “only if” direction of the claim follows directly by the definition of γ . Now assume there is no solution for G . The solution for G' cannot be larger than γ because then for some node v the partial solution would be larger than γ_v which is not possible by the definition of a realization and α_v .

As G has no solution, for each subset S of selected edges, there must be at least one node v with relation R that is not satisfied. Assume without loss of generality there is just one such node. By assumption we can extend S to a set $S' \subseteq E(G')$ that satisfies the relations at all nodes except for v . By the definition of a realization we know that any partial solution for the graph realizing R must have size at most $\alpha_v - \beta_v$ as the selected dangling edges are not valid for R . Hence, we can bound the size of the partial solution by $\alpha_v - \beta_v + \deg(v)$ as all dangling edges could be selected. But from $\beta_v \geq 2 \deg(v)$ we get that this is strictly smaller than γ_v . Hence, the total solution size is strictly smaller than γ . ◀

Now we have everything ready to prove the $(2 - \epsilon)^{\text{cutw}} n^{\mathcal{O}(1)}$ lower bound for MAX- B -FACTOR when $0 \in B$, assuming SETH.

Proof of Theorem 1.9 (2). Use the construction from Theorem 8.1 to get a B -FACTOR $^{\mathcal{R}}$ instance. Use Theorem 6.2 to replace every relation by a graph, where the penalty of each realization is at least twice the degree of the relation. As each complex node has constant degree, this replacement increases the size only by a constant factor depending only on B . Assume the claimed algorithm with running time $(2 - \epsilon)^{\text{cutw}} n^{\mathcal{O}(1)}$ exists and run it on this graph to get the size of the largest solution. We compare this to the constant from Lemma 8.6 and can decide the satisfiability of the formula which directly contradicts SETH. ◀

8.4 Counting Version

For the counting version we again make use of the chain of Turing-reductions from B -FACTOR $^{\mathcal{R}}$ to # B -FACTOR.

Proof of Theorem 1.9 (3). Use the construction from Theorem 8.1 to transform any formula into a B -FACTOR $^{\mathcal{R}}$ instance. Then we use Theorem 7.3 to get polynomially many instances of # B -FACTOR. Assume the claimed algorithm with running time $(2 - \epsilon)^{\text{cutw}} n^{\mathcal{O}(1)}$ exists and run it on these graphs. This yields a faster algorithm for #SAT contradicting #SETH. ◀

References

- 1 Ashwin Arulsevelan, Ágnes Cseh, Martin Groß, David F. Manlove, and Jannik Matuschke. Matchings with lower quotas: Algorithms and complexity. *Algorithmica*, 80(1):185–208, 2018. doi:10.1007/s00453-016-0252-6.
- 2 Claude Berge. *Graphs and Hypergraphs*. North-Holland mathematical library, Amsterdam, 1973.
- 3 Hans L. Bodlaender, Marek Cygan, Stefan Kratsch, and Jesper Nederlof. Deterministic single exponential time algorithms for connectivity problems parameterized by treewidth. In Fedor V. Fomin, Rusins Freivalds, Marta Z. Kwiatkowska, and David Peleg, editors, *Automata, Languages, and Programming - 40th International Colloquium, ICALP 2013, Riga, Latvia, July 8-12, 2013, Proceedings, Part I*, volume 7965 of *Lecture Notes in Computer Science*, pages 196–207. Springer, 2013. doi:10.1007/978-3-642-39206-1_17.
- 4 Hans L. Bodlaender and Arie M. C. A. Koster. Combinatorial optimization on graphs of bounded treewidth. *Comput. J.*, 51(3):255–269, 2008. doi:10.1093/comjnl/bxm037.
- 5 Jin-Yi Cai, Sangxia Huang, and Pinyan Lu. From holant to #csp and back: Dichotomy for holant c problems. *Algorithmica*, 64(3):511–533, 2012. doi:10.1007/s00453-012-9626-6.
- 6 Jin-yi Cai, Pinyan Lu, and Mingji Xia. A computational proof of complexity of some restricted counting problems. *Theor. Comput. Sci.*, 412(23):2468–2485, 2011. doi:10.1016/j.tcs.2010.10.039.
- 7 Liming Cai and David W. Juedes. On the existence of subexponential parameterized algorithms. *J. Comput. Syst. Sci.*, 67(4):789–807, 2003. doi:10.1016/S0022-0000(03)00074-6.
- 8 Chris Calabro, Russell Impagliazzo, and Ramamohan Paturi. The complexity of satisfiability of small depth circuits. In Jianer Chen and Fedor V. Fomin, editors, *Parameterized and Exact Computation, 4th International Workshop, IWPEC 2009, Copenhagen, Denmark, September 10-11, 2009, Revised Selected Papers*, volume 5917 of *Lecture Notes in Computer Science*, pages 75–85. Springer, 2009. doi:10.1007/978-3-642-11269-0_6.
- 9 Gérard Cornuéjols. General factors of graphs. *J. Comb. Theory, Ser. B*, 45(2):185–198, 1988. doi:10.1016/0095-8956(88)90068-8.
- 10 Bruno Courcelle. The monadic second-order logic of graphs. I. Recognizable sets of finite graphs. *Information and Computation*, 85(1):12 – 75, 1990. URL: <http://www.sciencedirect.com/science/article/pii/089054019090043H>, doi:[https://doi.org/10.1016/0890-5401\(90\)90043-H](https://doi.org/10.1016/0890-5401(90)90043-H).
- 11 Bruno Courcelle. The monadic second-order logic of graphs III: tree-decompositions, minor and complexity issues. *RAIRO Theor. Informatics Appl.*, 26:257–286, 1992. doi:10.1051/ita/1992260302571.
- 12 Radu Curticapean. Parity separation: A scientifically proven method for permanent weight loss. In Ioannis Chatzigiannakis, Michael Mitzenmacher, Yuval Rabani, and Davide Sangiorgi, editors, *43rd International Colloquium on Automata, Languages, and Programming, ICALP 2016, July 11-15, 2016, Rome, Italy*, volume 55 of *LIPICs*, pages 47:1–47:14. Schloss Dagstuhl - Leibniz-Zentrum für Informatik, 2016. doi:10.4230/LIPICs.ICALP.2016.47.
- 13 Radu Curticapean and Dániel Marx. Tight conditional lower bounds for counting perfect matchings on graphs of bounded treewidth, cliquewidth, and genus. In Robert Krauthgamer, editor, *Proceedings of the Twenty-Seventh Annual ACM-SIAM Symposium on Discrete Algorithms, SODA 2016, Arlington, VA, USA, January 10-12, 2016*, pages 1650–1669. SIAM, 2016. doi:10.1137/1.9781611974331.ch113.
- 14 Marek Cygan, Holger Dell, Daniel Lokshtanov, Dániel Marx, Jesper Nederlof, Yoshio Okamoto, Ramamohan Paturi, Saket Saurabh, and Magnus Wahlström. On problems as hard as CNF-SAT. *ACM Trans. Algorithms*, 12(3):41:1–41:24, 2016. doi:10.1145/2925416.
- 15 Marek Cygan, Fedor V. Fomin, Lukasz Kowalik, Daniel Lokshtanov, Dániel Marx, Marcin Pilipczuk, Michal Pilipczuk, and Saket Saurabh. *Parameterized Algorithms*. Springer, 2015. doi:10.1007/978-3-319-21275-3.

- 16 Marek Cygan, Stefan Kratsch, and Jesper Nederlof. Fast hamiltonicity checking via bases of perfect matchings. *J. ACM*, 65(3):12:1–12:46, 2018. doi:10.1145/3148227.
- 17 Marek Cygan, Jesper Nederlof, Marcin Pilipczuk, Michal Pilipczuk, Johan M. M. van Rooij, and Jakub Onufry Wojtaszczyk. Solving connectivity problems parameterized by treewidth in single exponential time. In Rafail Ostrovsky, editor, *IEEE 52nd Annual Symposium on Foundations of Computer Science, FOCS 2011, Palm Springs, CA, USA, October 22-25, 2011*, pages 150–159. IEEE Computer Society, 2011. doi:10.1109/FOCS.2011.23.
- 18 Xavier Dahan. Regular graphs of large girth and arbitrary degree. *Comb.*, 34(4):407–426, 2014. doi:10.1007/s00493-014-2897-6.
- 19 V́ctor Dalmau and Daniel K. Ford. Generalized satisfiability with limited occurrences per variable: A study through delta-matroid parity. In Branislav Rován and Peter Vojtás, editors, *Mathematical Foundations of Computer Science 2003, 28th International Symposium, MFCS 2003, Bratislava, Slovakia, August 25-29, 2003, Proceedings*, volume 2747 of *Lecture Notes in Computer Science*, pages 358–367. Springer, 2003. doi:10.1007/978-3-540-45138-9_30.
- 20 Holger Dell, Thore Husfeldt, Dániel Marx, Nina Taslaman, and Martin Wahlen. Exponential time complexity of the permanent and the Tutte polynomial. *ACM Trans. Algorithms*, 10(4):21:1–21:32, 2014. doi:10.1145/2635812.
- 21 Szymon Dudycz and Katarzyna Paluch. Optimal general matchings. In Andreas Brandstädt, Ekkehard Köhler, and Klaus Meer, editors, *Graph-Theoretic Concepts in Computer Science - 44th International Workshop, WG 2018, Cottbus, Germany, June 27-29, 2018, Proceedings*, volume 11159 of *Lecture Notes in Computer Science*, pages 176–189. Springer, 2018. Full version: arXiv:1706.07418. doi:10.1007/978-3-030-00256-5_15.
- 22 Jack Edmonds. Paths, trees, and flowers. *Canadian Journal of Mathematics*, 17:449–467, 1965. doi:10.4153/CJM-1965-045-4.
- 23 Paul Erdős and Horst Sachs. Reguläre Graphen gegebener Tailenweite mit minimaler Knotenzahl. *Wiss. Z. Martin-Luther-Univ. Halle-Wittenberg Math.-Natur. Reihe*, 12(251-257):22, 1963.
- 24 Geoffrey Exoo and Robert Jajcay. Recursive constructions of small regular graphs of given degree and girth. *Discret. Math.*, 312(17):2612–2619, 2012. doi:10.1016/j.disc.2011.10.021.
- 25 Tomás Feder. Fanout limitations on constraint systems. *Theor. Comput. Sci.*, 255(1-2):281–293, 2001. doi:10.1016/S0304-3975(99)00288-1.
- 26 Fedor V. Fomin, Daniel Lokshtanov, and Saket Saurabh. Efficient computation of representative sets with applications in parameterized and exact algorithms. In Chandra Chekuri, editor, *Proceedings of the Twenty-Fifth Annual ACM-SIAM Symposium on Discrete Algorithms, SODA 2014, Portland, Oregon, USA, January 5-7, 2014*, pages 142–151. SIAM, 2014. doi:10.1137/1.9781611973402.10.
- 27 Heng Guo and Pinyan Lu. On the complexity of holant problems. In Andrei A. Krokhin and Stanislav Zivný, editors, *The Constraint Satisfaction Problem: Complexity and Approximability*, volume 7 of *Dagstuhl Follow-Ups*, pages 159–177. Schloss Dagstuhl - Leibniz-Zentrum für Informatik, 2017. doi:10.4230/DFU.Vol7.15301.6.
- 28 Arne Hoffmann and Lutz Volkmann. On unique k -factors and unique $[1, k]$ -factors in graphs. *Discret. Math.*, 278(1-3):127–138, 2004. doi:10.1016/S0012-365X(03)00248-6.
- 29 Russell Impagliazzo and Ramamohan Paturi. On the complexity of k -SAT. *J. Comput. Syst. Sci.*, 62(2):367–375, 2001. doi:10.1006/jcss.2000.1727.
- 30 Wilfried Imrich. Explicit construction of regular graphs without small cycles. *Comb.*, 4(1):53–59, 1984. doi:10.1007/BF02579157.
- 31 Ton Kloks. *Treewidth, Computations and Approximations*, volume 842 of *Lecture Notes in Computer Science*. Springer, 1994. doi:10.1007/BFb0045375.
- 32 Sanjana Kolisetty, Linh Le, Ilya Volkovich, and Mihalis Yannakakis. The complexity of finding S -factors in regular graphs. *Electron. Colloquium Comput. Complex.*, 26:40, 2019. URL: <https://eccc.weizmann.ac.il/report/2019/040>.

- 33 Michael Kowalczyk and Jin-Yi Cai. Holant problems for 3-regular graphs with complex edge functions. *Theory Comput. Syst.*, 59(1):133–158, 2016. doi:10.1007/s00224-016-9671-7.
- 34 Felix Lazebnik, Vasilij A Ustimenko, and Andrew J Woldar. A new series of dense graphs of high girth. *Bulletin of the American mathematical society*, 32(1):73–79, 1995.
- 35 Daniel Lokshtanov, Dániel Marx, and Saket Saurabh. Lower bounds based on the exponential time hypothesis. *Bull. EATCS*, 105:41–72, 2011. URL: <http://eatcs.org/beatcs/index.php/beatcs/article/view/92>.
- 36 Daniel Lokshtanov, Dániel Marx, and Saket Saurabh. Known algorithms on graphs of bounded treewidth are probably optimal. *ACM Trans. Algorithms*, 14(2):13:1–13:30, 2018. doi:10.1145/3170442.
- 37 László Lovász. The factorization of graphs. II. *Acta Mathematica Hungarica*, 23(1-2):223–246, 1972.
- 38 Pinyan Lu. Complexity dichotomies of counting problems. *Electron. Colloquium Comput. Complex.*, 18:93, 2011. URL: <http://eccc.hpi-web.de/report/2011/093>.
- 39 Silvio Micali and Vijay V. Vazirani. An $O(\sqrt{|v|} |E|)$ algorithm for finding maximum matching in general graphs. In *21st Annual Symposium on Foundations of Computer Science, Syracuse, New York, USA, 13-15 October 1980*, pages 17–27. IEEE Computer Society, 1980. doi:10.1109/SFCS.1980.12.
- 40 Michal Pilipczuk. Problems parameterized by treewidth tractable in single exponential time: A logical approach. In Filip Murlak and Piotr Sankowski, editors, *Mathematical Foundations of Computer Science 2011 - 36th International Symposium, MFCS 2011, Warsaw, Poland, August 22-26, 2011. Proceedings*, volume 6907 of *Lecture Notes in Computer Science*, pages 520–531. Springer, 2011. doi:10.1007/978-3-642-22993-0_47.
- 41 Yossi Shiloach. Another look at the degree constrained subgraph problem. *Inf. Process. Lett.*, 12(2):89–92, 1981. doi:10.1016/0020-0190(81)90009-0.
- 42 Leslie G. Valiant. The complexity of computing the permanent. *Theor. Comput. Sci.*, 8:189–201, 1979. doi:10.1016/0304-3975(79)90044-6.
- 43 Leslie G. Valiant. The complexity of enumeration and reliability problems. *SIAM J. Comput.*, 8(3):410–421, 1979. doi:10.1137/0208032.
- 44 Leslie G. Valiant. Holographic algorithms (extended abstract). In *45th Symposium on Foundations of Computer Science (FOCS 2004), 17-19 October 2004, Rome, Italy, Proceedings*, pages 306–315. IEEE Computer Society, 2004. doi:10.1109/FOCS.2004.34.
- 45 Johan M. M. van Rooij. Fast algorithms for join operations on tree decompositions. In Fedor V. Fomin, Stefan Kratsch, and Erik Jan van Leeuwen, editors, *Treewidth, Kernels, and Algorithms - Essays Dedicated to Hans L. Bodlaender on the Occasion of His 60th Birthday*, volume 12160 of *Lecture Notes in Computer Science*, pages 262–297. Springer, 2020. doi:10.1007/978-3-030-42071-0_18.
- 46 Johan M. M. van Rooij, Hans L. Bodlaender, and Peter Rossmanith. Dynamic programming on tree decompositions using generalised fast subset convolution. In Amos Fiat and Peter Sanders, editors, *Algorithms - ESA 2009, 17th Annual European Symposium, Copenhagen, Denmark, September 7-9, 2009. Proceedings*, volume 5757 of *Lecture Notes in Computer Science*, pages 566–577. Springer, 2009. doi:10.1007/978-3-642-04128-0_51.