

# SEMANTIC PROOF OF CONFLUENCE OF THE CATEGORICAL REDUCTION SYSTEM FOR LINEAR LOGIC

RYU HASEGAWA

**ABSTRACT.** We verify a confluence result for the rewriting calculus of the linear category introduced in our previous paper. Together with the termination result proved therein, the generalized coherence theorem for linear category is established. Namely, we obtain a method to determine if two morphisms are equal up to a certain equivalence.

## 1. Introduction

The link between the type theory and the category theory is bidirectional. The type theory is a theoretical framework for the abstract formalization of programming languages, mainly developed in computer science. It is known that categories are suitable machinery to elucidate the mathematical structure of type systems, providing a large pool of the mathematical models of the artificial languages designed for programming purposes. Conversely, the type theory is employed as the internal languages of categories, replacing the lengthy diagram chasing with intuitive arguments using familiar logical constructions [17]. In various cases, categories give the sound and complete semantics of type systems. This means that the equational theory determined by commutative diagrams in the categories exactly correspond to the one determined by the equality rules between terms of the type systems. Namely, categories and type systems are not quite similar in their appearances, but they are equivalent in their essences. For example, it is well-known that cartesian closed categories give the sound and complete semantics of the simply typed lambda calculus with products [21]. In this paper, we consider the categorical semantics of linear logic. It is also sound and complete.

Dynamism is lost in the link between two theories. The type theory is developed as a mathematical formalization of computation on programs. Naturally, thus, most type systems possess the mechanism of calculi. The simply typed lambda calculus is typical. The notion of reductions is incorporated, by which we can perform mechanical calculations. This calculus satisfies the most desirable properties demanded to formalized calculi: termination and confluence. A sequence of reductions is assured of terminating in a normal form that allows reductions no more. As the calculus admits non-determinism in the order of reductions, different routes of computation may exist. The confluence ensures that the normal form is unique no matter which routes are taken. Unfortunately, however, the categorical semantics so far fails to capture the dynamic aspect of the calculus. Equivalence between categories and type systems holds only up to equalities. We must

---

2010 Mathematics Subject Classification: 03B40, 68N18.

Key words and phrases: type theory, linear logic, confluence.

© Ryu Hasegawa, . Permission to copy for private use granted.

neglect the orientation of reductions to validate the correspondence. There is no obvious way to transfer the reductions in type systems into categories. For example, although we are not unable to introduce reductions on the free cartesian closed category, the obtained calculus is far from being as good as the lambda calculus with regard to computational properties.

The main finding in our previous paper is that we can install a natural, good calculus on the categorical model of linear logic, the free linear category [14]. Linear logic is a refinement of the lambda calculus. What we have disclosed is that the cartesian closed category corresponding to the lambda calculus is too coarse. The fine granularity of linear logic enables us to turn the linear category into a calculus. We have developed a rewriting system modulo congruence by choosing twenty-three from the defining commutative diagrams and making them the rewriting rules. One can rewrite morphisms only in the direction specified by the rules. In the previous paper, we verified a termination property for the calculus.

The theme of this paper is confluence, the other half of the two properties naturally demanded to reasonable computational systems. We show that our rewriting system is almost confluent. The exact meaning of being almost confluent is explained in a later section. In brief, a normal form is unique, except how and where the isomorphisms related to tensor/cotensor units are used. The (classical) linear category is based on the  $*$ -autonomous category. The manipulation of the units in the  $*$ -autonomous category is notoriously difficult [3, 16, 15]. Speaking a little audaciously, however, the problem of the units is relatively a minor point. Hence it may be allowable to say that our calculus is almost confluent.

We provide a semantical proof of confluence. The parallel reduction is known as a standard syntactic method to verify confluence. As the name suggests, it takes all possible parallel combinations of reductions as single-step rewritings. As our calculus has twenty-three rules, however, the taking of all combinations is daunting. We should find other means. In this paper, we provide a semantical method for confluence. The link between the syntax and the semantics is usually directional. Models are used to abstract the properties of the syntax to obtain semantical information. However, the other direction is occasionally possible. Syntactic information can be squeezed out from models. The evaluation-free normalization by Berger and Schwichtenberg extracts a normal form of a term of the typed lambda calculus from a model [2]. The coherence proof by Joyal and Street finds canonical morphisms from concrete categories [19]. A series of results for differential nets by de Carvalho and Tortora de Falco et al. is based on a similar idea [4, 6, 11]. We use the normal functor model to obtain the information of normal forms in our calculus.

Remark: After completing the current work, we noticed the work by de Carvalho [5]. It shares similar ideas with ours, and it is plausible that his method can be applied to our calculus. However, we hope that this paper still has some values, since (1) the systems are different, (2) the models are different, (3) our method relying on the enumerative combinatorics and the number theory may have novelty. We use the linear normal functors,

the coefficients of which are non-negative integers. Therefore we can apply the number theory to the coefficients. In our proof, Fermat's little theorem plays a key role.

We can establish a kind of coherence for the linear category. The classic coherence theorem by Mac Lane ensures that the diagram chasing in certain categories, such as the monoidal category, is trivial [20]. Any morphisms sharing a domain and a codomain must equal. Most categories, though, fail in having coherence. However, we occasionally have a certain type of characterization of morphisms, which may be regarded as the generalization of coherence. The coherence theorem for the braided monoidal category by Joyal and Street relates the morphisms to standard braid diagrams [19]. Another direction to generalize coherence is to seek an effective method to determine if given morphisms are equal. Blute et al. have shown that the  $*$ -autonomous category satisfies the generalized coherence in this sense [3]. There is a mechanical way to check if two morphisms equal, freeing us from the cumbersome task of forming large commutative diagrams. The confluence result in this paper, accompanied with a termination result in our previous paper, entails that the linear category fulfills the generalized coherence in the latter sense. We have a systematic way to determine whether two morphisms are almost equal. Here "almost equal" means that they are equal if we ignore where and how the isomorphisms related to units are used. Our algorithm is simple. Given two morphisms, turn them to normal forms and just compare.

## 2. Rewriting system for the linear category

In our previous paper, we have reformulated the free linear category into a rewriting system so that the diagram chasing is realized by essentially one-way sequence of computations [14]. A (classical) *linear category* is a  $*$ -autonomous category  $(\mathbf{C}, \otimes, \wp, \mathbf{1}, \perp, (-)^*)$  having the following additional data [23]:

- (i) The category  $\mathbf{C}$  is equipped with a symmetric monoidal endofunctor  $(!, \tilde{\varphi}, \varphi_0)$ .
- (ii) The functor  $!$  has the structure of comonad  $(!, \delta, \varepsilon)$  where  $\delta : ! \rightarrow !!$  and  $\varepsilon : ! \rightarrow Id$ . Moreover,  $\delta$  and  $\varepsilon$  are monoidal natural transformations.
- (iii) Each object of the form  $!A$  has the structure of commutative comonoid  $(!A, d_A, e_A)$  where  $d_A : !A \rightarrow !A \otimes !A$  and  $e_A : !A \rightarrow \mathbf{1}$ . Moreover, the family of  $d_A$  and the family of  $e_A$  are collectively monoidal natural transformations.

These data should fulfill the following constraints:

- (iv) Each  $d_A$  and each  $e_A$  are coalgebra morphisms.
- (v) Each  $\delta_A$  is a comonoid morphism.

As the formalization of the underlying  $*$ -autonomous category, we take the one having two symmetric monoidal structures  $(\otimes, \mathbf{1})$  and  $(\wp, \perp)$  with linear distribution  $\partial : A \otimes (B \wp C) \rightarrow (A \otimes B) \wp C$ , tautology  $\tau : \mathbf{1} \rightarrow A \wp A^*$ , and contradiction  $\gamma : A^* \otimes A \rightarrow \perp$  [7].

The definition can be written down as a number of commutative diagrams. We reformulate twenty-three diagrams among them as rewriting rules. In the rules (18) to (21)

below,  $f$  denotes an arbitrary morphism.

$$\begin{array}{ccc} !A & \xrightarrow{\delta} & !!A \\ \delta \downarrow & \swarrow & \downarrow \delta \\ !!A & \xrightarrow{! \delta} & !!!A \end{array} \quad \cdots (1)$$

$$\begin{array}{ccc} !A & \xrightarrow{\delta} & !!A \\ \searrow 1 & \swarrow \varepsilon & \\ & !A & \end{array} \quad \cdots (2)$$

$$\begin{array}{ccc} !A & \xrightarrow{\delta} & !!A \\ \searrow 1 & \swarrow !\varepsilon & \\ & !A & \end{array} \quad \cdots (3)$$

$$\begin{array}{ccc} !A & \xrightarrow{\delta} & !!A \\ d \downarrow & \swarrow & \downarrow d \\ !A \otimes !A & \xrightarrow{\delta \otimes \delta} & !!A \otimes !!A \end{array} \quad \cdots (4)$$

$$\begin{array}{ccc} & !A & \\ d \swarrow & & \searrow \delta \\ !A \otimes !A & & !!A \\ \delta \otimes \delta \searrow & \swarrow & \downarrow !d \\ !!A \otimes !!A & \xrightarrow{\tilde{\varphi}} & !(A \otimes !A) \end{array} \quad \cdots (5)$$

$$\begin{array}{ccc} !A & \xrightarrow{\delta} & !!A \\ \searrow e & \swarrow \varepsilon & \\ & \mathbf{1} & \end{array} \quad \cdots (6)$$

$$\begin{array}{ccc} !A & \xrightarrow{\delta} & !!A \\ e \downarrow & \swarrow & \downarrow !e \\ \mathbf{1} & \xrightarrow{\varphi_0} & !\mathbf{1} \end{array} \quad \cdots (7)$$

$$\begin{array}{ccc} !A & \xrightarrow{d} & !A \otimes !A \\ \searrow \sim & \swarrow \varepsilon \otimes \mathbf{1} & \\ & \mathbf{1} \otimes !A & \end{array} \quad \cdots (8)$$

$$\begin{array}{ccc} & !A \otimes !B & \\ \delta \otimes \delta \swarrow & & \searrow \tilde{\varphi} \\ !!A \otimes !!B & & !(A \otimes B) \\ \tilde{\varphi} \searrow & \swarrow & \downarrow \delta \\ !(A \otimes !B) & \xrightarrow{! \tilde{\varphi}} & !(A \otimes B) \end{array} \quad \cdots (9)$$

$$\begin{array}{ccc} !A \otimes !B & \xrightarrow{\tilde{\varphi}} & !(A \otimes B) \\ \varepsilon \otimes \varepsilon \searrow & \swarrow \varepsilon & \\ & A \otimes B & \end{array} \quad \cdots (10)$$

$$\begin{array}{ccc} & !A \otimes !B & \\ d \otimes d \swarrow & & \searrow \tilde{\varphi} \\ (!A \otimes !A) \otimes (!B \otimes !B) & & !(A \otimes B) \\ \sim \searrow & \swarrow & \downarrow d \\ (!A \otimes !B) \otimes (!A \otimes !B) & \xrightarrow{\tilde{\varphi} \otimes \tilde{\varphi}} & !(A \otimes B) \otimes !(A \otimes B) \end{array} \quad \cdots (11)$$

$$\begin{array}{ccc} !A \otimes !B & \xrightarrow{\tilde{\varphi}} & !(A \otimes B) \\ e \otimes e \downarrow & \swarrow & \downarrow e \\ \mathbf{1} \otimes \mathbf{1} & \xrightarrow{\sim} & \mathbf{1} \end{array} \quad \cdots (12)$$

$$\begin{array}{ccc} \mathbf{1} & \xrightarrow{\varphi_0} & !\mathbf{1} \\ \varphi_0 \downarrow & \swarrow & \downarrow \delta \\ !\mathbf{1} & \xrightarrow{! \varphi_0} & !!\mathbf{1} \end{array} \quad \cdots (13)$$

$$\begin{array}{ccc} \mathbf{1} & \xrightarrow{\varphi_0} & !\mathbf{1} \\ \searrow 1 & \swarrow \varepsilon & \\ & \mathbf{1} & \end{array} \quad \cdots (14)$$

$$\begin{array}{ccc}
\mathbf{1} & \xrightarrow{\varphi_0} & !\mathbf{1} \\
\sim \downarrow & \not\Leftarrow & \downarrow d \\
\mathbf{1} \otimes \mathbf{1} & \xrightarrow{\varphi_0 \otimes \varphi_0} & !\mathbf{1} \otimes !\mathbf{1}
\end{array} \quad \dots (15)$$

$$\begin{array}{ccc}
\mathbf{1} & \xrightarrow{\varphi_0} & !\mathbf{1} \\
\searrow 1 & \not\Leftarrow & \swarrow e \\
& & \mathbf{1}
\end{array} \quad \dots (16)$$

$$\begin{array}{ccc}
\mathbf{1} \otimes !A & \xrightarrow{\varphi_0 \otimes 1} & !\mathbf{1} \otimes !A \\
\sim \downarrow & \not\Leftarrow & \downarrow \tilde{\varphi} \\
!A & \xrightarrow{\sim} & !(1 \otimes A)
\end{array} \quad \dots (17)$$

$$\begin{array}{ccc}
!A & \xrightarrow{!f} & !B \\
\delta \downarrow & \not\Leftarrow & \downarrow \delta \\
!!A & \xrightarrow{!!f} & !!B
\end{array} \quad \dots (18)$$

$$\begin{array}{ccc}
!A & \xrightarrow{!f} & !B \\
\varepsilon \downarrow & \not\Leftarrow & \downarrow \varepsilon \\
A & \xrightarrow{f} & B
\end{array} \quad \dots (19)$$

$$\begin{array}{ccc}
!A & \xrightarrow{!f} & !B \\
d \downarrow & \not\Leftarrow & \downarrow d \\
!A \otimes !A & \xrightarrow{!f \otimes !f} & !B \otimes !B
\end{array} \quad \dots (20)$$

$$\begin{array}{ccc}
!A & \xrightarrow{!f} & !B \\
\searrow e & \not\Leftarrow & \swarrow e \\
& & \mathbf{1}
\end{array} \quad \dots (21)$$

$$\begin{array}{ccc}
\mathbf{1} \otimes A & \xrightarrow{\tau \otimes 1} & (A \wp A^*) \otimes A \\
\sim \swarrow & \not\Leftarrow & \searrow \partial' \\
A & & A \wp (A^* \otimes A) \\
\sim \swarrow & & \nwarrow 1 \wp \gamma \\
& & A \wp \perp
\end{array} \quad \dots (22)$$

$$\begin{array}{ccc}
A^* \otimes \mathbf{1} & \xrightarrow{1 \otimes \tau} & A^* \otimes (A \wp A^*) \\
\sim \swarrow & \not\Leftarrow & \searrow \partial \\
A^* & & (A^* \otimes A) \wp A^* \\
\sim \swarrow & & \nwarrow \gamma \wp 1 \\
& & \perp \wp A^*
\end{array} \quad \dots (23)$$

The double arrow  $\Rightarrow$  means the rewriting relation. For example, let us consider rule (1), which is one of the coherence conditions for comonad. Usually, it is interpreted as a commutative diagram. Namely,  $\delta_A; \delta_{!A}$  and  $\delta_A; !\delta_A$  are regarded to be equal. We can replace the former with the latter, or the latter with the former. Under the interpretation as a rewriting relation, we allow only one-way modification. We can replace  $\delta_A; \delta_{!A}$  with  $\delta_A; !\delta_A$ , not the other way round. In this way, the modification of morphisms is constrained.

There are still a number of diagrams not listed above in the definition of the linear category. They are regarded as commutative diagrams in an ordinary sense. Two legs of a commutative diagram, say  $f$  and  $g$ , are regarded to be equal. We can replace either  $f$  with  $g$ , or  $g$  with  $f$ . Hence our calculus is actually a rewriting system modulo congruence. The diagram in Fig. 1 is an example of rewriting in our calculus, reproduced from our previous paper. It contains rewritings by (5), (9), and (11), and one congruence. All the diagrams defining the linearly distributive category is regarded to be congruent. The diagrams related to  $(-)^*$  are handled as rewriting rules (22) and (23). For the symmetric monoidal functor  $!$ , only one diagram (17) gives rise to a rewriting relation. The others

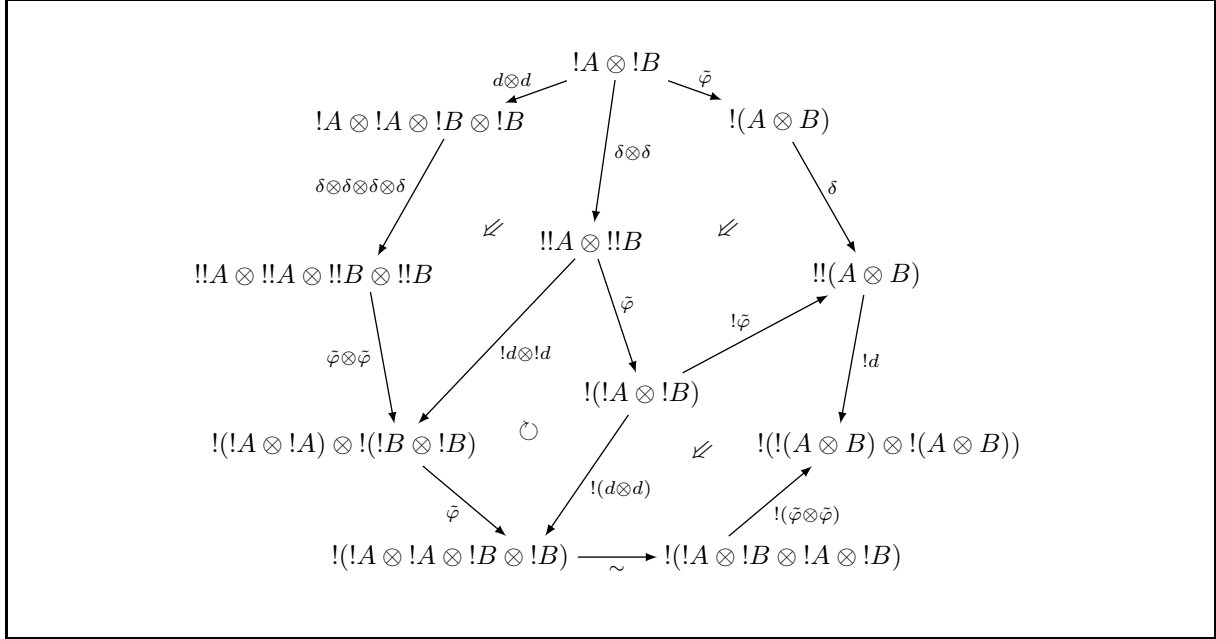

Figure 1: An example of rewriting

give congruent relations:

$$\begin{array}{ccc}
 !A \otimes !B & \xrightarrow{\bar{\varphi}} & !(A \otimes B) \\
 !f \otimes !g \downarrow & \circlearrowleft & \downarrow !(f \otimes g) \\
 !A' \otimes !B' & \xrightarrow{\bar{\varphi}} & !(A' \otimes B')
 \end{array}$$

$$\begin{array}{ccc}
 (!A \otimes !B) \otimes !C & & !(A \otimes B) \otimes !C \\
 \alpha \swarrow & & \searrow \bar{\varphi} \otimes 1 \\
 !A \otimes (!B \otimes !C) & \circlearrowleft & !A \otimes !(B \otimes !C) \\
 1 \otimes \bar{\varphi} \downarrow & & \downarrow \bar{\varphi} \\
 !A \otimes !(B \otimes !C) & & !((A \otimes B) \otimes !C) \\
 \bar{\varphi} \searrow & & \swarrow !\alpha \\
 !(A \otimes (B \otimes !C)) & & 
 \end{array}$$

$$\begin{array}{ccc}
 !A \otimes !B & \xrightarrow{\bar{\varphi}} & !(A \otimes B) \\
 \sigma \downarrow & \circlearrowleft & \downarrow !\sigma \\
 !B \otimes !A & \xrightarrow{\bar{\varphi}} & !(B \otimes A)
 \end{array}$$

where  $f$  and  $g$  are arbitrary, and where  $\alpha$  and  $\sigma$  are structural isomorphisms. The defining diagrams of comonad and symmetric comonoid comprise twenty rewriting rules, except the following two congruent diagrams:

$$\begin{array}{ccc}
 & !A & \\
 & \swarrow d & \searrow d \\
 !A \otimes !A & & !A \otimes !A \\
 \downarrow d \otimes 1 & \circlearrowleft & \downarrow 1 \otimes d \\
 (!A \otimes !A) \otimes !A & \xrightarrow{\alpha} & !A \otimes (!A \otimes !A)
 \end{array}$$

$$\begin{array}{ccc}
 !A & \xrightarrow{d} & !A \otimes !A \\
 \downarrow d & \circlearrowleft & \downarrow \sigma \\
 !A \otimes !A & & 
 \end{array}$$

For the complete list, we refer the reader to [14]. Our policy is to reformulate as many diagrams as possible to one-way rewriting. Only those diagrams which lead to an unreasonable system if we enforce rewriting are left as congruence.

### 3. Linear normal functor model

Multisets are frequently used below. In this paper, only finite multiset appears. The multiset union is denoted by  $\alpha + \beta$ .

The confluence of the calculus on the linear category is proved via a specific model  $\mathcal{M}$  given in [13]. It is an adaptation of the quantitative model of Girard [9]. This model is based on normal functors, which are special cases of Joyal's analytic functors [18]. The category of normal functors can be regarded as a coKleisli category of the exponential comonad given below. This comonad satisfies all the conditions of the linear category. In the following definition,  $\mathbf{Set}^A$  denotes the category of presheaves where  $A$  is a set regarded as a discrete category.

**3.1. DEFINITION.** The objects of  $\mathcal{M}$  are sets  $A$ . A morphism from  $A$  to  $B$  is a linear normal functor from  $\mathbf{Set}^A$  to  $\mathbf{Set}^B$ . Here linear normal functors are defined as the functors preserving equalizers, pullbacks of possibly infinite legs, and all colimits [13].

We comment that, if we replace colimits with filtered colimits in the definition, we obtain the definition of normal functors [9]. In place of universality, it is convenient to use a concrete presentation, which we explain shortly.

An object  $x \in \mathbf{Set}^A$  has an analogy to a vector in the ordinary linear algebra. To each  $a \in A$ , a component  $x[a]$  corresponds. Since  $A$  is infinite in general, it may be a vector of infinite dimension. In linear algebra, each component is a member of the underlying field. Here,  $x[a]$  is an object of  $\mathbf{Set}$ , i.e., a set. If we identify a set with its cardinality,  $x$  is a vector having cardinal numbers as its components. In particular, if they are finite sets, the components are non-negative integers. We can perform addition and multiplication of components, but no subtraction as they are cardinal numbers.

Linear normal functors have the following characterization. Suppose that  $f : \mathbf{Set}^A \rightarrow \mathbf{Set}^B$  is a linear normal functor. If we write  $y = f(x)$ , there is  $M \in \mathbf{Set}^{A \times B}$  such that  $y[b] = \sum_a M[a; b]x[a]$ , where  $M[a; b]$  denotes the set that is the value of  $M$  at  $(a, b) \in A \times B$ . The sum is a possibly infinite disjoint sum of sets over  $a \in A$ , and the concatenation signifies the cartesian product. The equality is not exactly correct, as it usually holds only up to isomorphism. We abuse the equality to emphasize the analogy with linear algebra. In  $\mathbf{Set}$ , two sets having the same cardinality are isomorphic. So, if we identify them, the sum and the product obey the ordinary cardinal arithmetic. In particular, if only finite sets are involved, they are elementary arithmetic on integers. In this way, a linear normal functor has an analogy with the linear map given by the multiplication of a matrix  $M$ . We write  $y = Mx$ . Conversely, if a functor is naturally equivalent to the functor of the form  $y = Mx$  then it is a linear normal functor. All

linear normal functors from  $\mathbf{Set}^A$  to  $\mathbf{Set}^B$  are determined by  $M \in \mathbf{Set}^{A \times B}$  up to natural equivalences.

The coefficient matrix  $M \in \mathbf{Set}^{A \times B}$  is also regarded as a span (a profunctor). If we abuse the same symbol  $M$ , a diagram

$$\begin{array}{ccc} & M & \\ \swarrow & & \searrow \\ A & & B \end{array}$$

in  $\mathbf{Set}$  corresponds. Regarding this diagram as a function into  $A \times B$ , the coefficient  $M[a; b]$  is the inverse image of  $(a, b)$  under the function. The composition of linear normal functors correspond to the composition of profunctors, i.e., the pullback. The coefficient matrices or spans give only equivalent presentations of linear normal functors. They do not form a category in an exact sense. For example, if we consider the category of spans,  $(L \times_A M) \times_B N$  and  $L \times_A (M \times_B N)$  are isomorphic, but not exactly equal in general. This type of subtle difference, however, is not problematic in this paper. So let us identify them naively.

Now we install a structure of the linear category on  $\mathcal{M}$ . First of all, the duality is simply ignored. Namely,  $A^* = A$ . Tensor and cotensor are both the cartesian product. Namely, both of  $A \otimes B$  and  $A \wp B$  are given as  $A \times B$ . The morphism maps are given as the tensor of matrices. Namely, if  $f$  and  $g$  correspond to the matrices  $M$  and  $N$  respectively,  $f \otimes g$  and  $f \wp g$  both correspond to  $M \otimes N$  given as  $(M \otimes N)[(a, a'); (b, b')] = M[a; b]N[a'; b']$ . The tensor unit and cotensor unit are both a singleton  $\mathbf{1}$ . Its element is denoted by  $*$ .

We give the endofunctor  $! : \mathcal{M} \rightarrow \mathcal{M}$ . The object map is  $A \mapsto \exp A$ . Here,  $\exp A$  denotes the set of all finite multisets of members of  $A$ . This is an analytic functor in the sense of Joyal and this notation is introduced there [18]. It is instructive to identify the multisets in  $\exp A$  with monomials in the variables that have a one-to-one correspondence to the member of  $A$ . With each  $a \in A$ , we associate a variable  $x_a$ . Then, for example, the multiset  $\alpha = \{a, a, b\}$  is identified with the monomial  $x^\alpha = x_a^2 x_b$ . The morphism  $!f : \mathbf{Set}^{\exp A} \rightarrow \mathbf{Set}^{\exp B}$  is naturally defined under this identification. Suppose that  $f$  is given by  $M \in \mathbf{Set}^{A \times B}$ . Substituting for each variable in the monomial  $y^\beta$  by  $y_b = \sum_a M[a, b]x_a$ , we obtain a linear combination of monomials  $x^\alpha$ . Namely, we can write  $y^\beta = \sum_\alpha \tilde{M}[\alpha, \beta]x^\alpha$ . This matrix  $\tilde{M} \in \mathbf{Set}^{\exp A \times \exp B}$  gives the definition of  $!f$ . For the reader's convenience, we give a sketch in a simple case. Suppose that  $A = \{1, 2\} = B$  and  $M = \begin{pmatrix} a & b \\ c & d \end{pmatrix}$ . Namely,  $y_1 = ax_1 + bx_2$  and  $y_2 = cx_1 + dx_2$ . Let us enumerate the members of  $\exp A$  in the order of  $1, x_1, x_2, x_1^2, x_1x_2, x_2^2, \dots$  and those of  $\exp B$  similarly.



Then the matrix  $\tilde{M}$  is given as

$$\begin{pmatrix} 1 & & & & & & & \\ & a & b & & & & & \\ & c & d & & & & & \\ & & & a^2 & 2ab & b^2 & & \\ & & & ac & ad + bc & bd & & \\ & & & c^2 & 2cd & d^2 & & \\ & & & & & & \dots & \end{pmatrix}.$$

For example, the fourth row comes from  $y_1^2 = a^2x_1^2 + 2abx_1x_2 + b^2x_2^2$ . Since  $!f$  is defined by substitution,  $!(f \circ g) = !f \circ !g$  is immediate. Hence  $!$  turns out to be a functor.

We should observe asymmetry of the matrix. When we view the  $3 \times 3$  block of degree two monomials in the example of  $\tilde{M}$  above, the  $(1, 2)$ -component  $2ab$  has the coefficient 2, whereas the  $(2, 1)$ -component is  $ac$ , the coefficient of which is 1. In terms of spans, this phenomenon is explained as follows. Suppose that  $f$  corresponds to the span  $M$  over

$A$  and  $B$ . Then  $!f$  does *not* correspond to  $\begin{matrix} \text{exp } M \\ \swarrow \quad \searrow \\ \text{exp } A \quad \text{exp } B \end{matrix}$ . In fact, the analytic functor

$\text{exp } A$  does not preserve pullbacks. Hence, if we adopted this symmetric span as the definition,  $!$  would not preserve composition. Therefore, the definition must intrinsically be asymmetric on two legs. Joyal's analytic functors are introduced in order to give a mathematical foundation to the generating functions in the enumerative combinatorics. This asymmetry is the origin that complicates and, at the same time, enriches the theory of enumeration. If the symmetry held, the world of enumerative combinatorics would be much more languid.

Each function  $f : A \rightarrow B$  induces the linear normal functor  $f^* : \mathbf{Set}^B \rightarrow \mathbf{Set}^A$  defined by  $f^*(y)[a] = x[f(a)]$ . In terms of spans, it corresponds to

$$\begin{matrix} & A & \\ f \swarrow & & \searrow \\ B & & A \end{matrix}$$

In terms of matrices, it corresponds to the matrix  $M[b; a]$  that equals 1 whenever  $b = f(a)$ ; otherwise equals 0.

Using  $f^*$ , we can give the structures of the linear category to  $!$ . The morphism  $\delta_A : \mathbf{Set}^{\text{exp } A} \rightarrow \mathbf{Set}^{\text{exp exp } A}$  is induced from the function  $\text{exp exp } A \rightarrow \text{exp } A$  carrying  $\{\alpha_1, \alpha_2, \dots, \alpha_p\}$  to the multiset union  $\alpha_1 + \alpha_2 + \dots + \alpha_p$ . The morphism  $\varepsilon_A : \mathbf{Set}^{\text{exp } A} \rightarrow \mathbf{Set}^A$  is induced from the function  $A \rightarrow \text{exp } A$  carrying  $a$  to the singleton  $\{a\}$ . The morphism  $d_A : \mathbf{Set}^{\text{exp } A} \rightarrow \mathbf{Set}^{\text{exp } A \times \text{exp } A}$  is induced from the function  $\text{exp } A \times \text{exp } A \rightarrow \text{exp } A$  carrying  $(\alpha, \alpha')$  to the multiset union  $\alpha + \alpha'$ . The morphism  $e_A : \mathbf{Set}^{\text{exp } A} \rightarrow \mathbf{Set}^{\mathbf{1}}$  is induced from the function  $\mathbf{1} \rightarrow \text{exp } A$  carrying  $*$  to the empty multiset  $\emptyset$ . We can directly check that these are natural transformations. The morphism  $\tilde{\varphi} : \mathbf{Set}^{\text{exp } A \times \text{exp } A} \rightarrow \mathbf{Set}^{\text{exp}(A \times A)}$  is induced from the function  $\text{exp}(A \times A) \rightarrow \text{exp } A \times \text{exp } A$

carrying  $\{(a_1, a'_1), (a_2, a'_2), \dots, (a_p, a'_p)\}$  to the pair  $(\{a_1, a_2, \dots, a_p\}, \{a'_1, a'_2, \dots, a'_p\})$ . The morphism  $\varphi_0 : \mathbf{Set}^{\mathbf{1}} \rightarrow \mathbf{Set}^{\exp \mathbf{1}}$  is induced from the unique function  $\exp \mathbf{1} \rightarrow \mathbf{1}$ . The naturality of  $\tilde{\varphi}$  is directly checked. Since all morphisms are of the shape  $f^*$  for functions  $f$ , the coherence conditions are easily derived from the corresponding equalities between the associated functions.

Our calculus is based on the free linear category. The objects and morphisms of the calculus are thus interpreted in the linear category  $\mathcal{M}$ , once the interpretations of the atomic objects  $X$  are provided. In particular, every syntactic morphism  $f : A \rightarrow B$  is interpreted by  $\llbracket f \rrbracket : \llbracket A \rrbracket \rightarrow \llbracket B \rrbracket$  in  $\mathcal{M}$ . When we are involved in the matrix representation, we write  $M_f \in \mathbf{Set}^{\llbracket A \rrbracket \times \llbracket B \rrbracket}$ . The sets interpreting the atomic objects are arbitrary. To our aim, however, we assume infinite sets.

In order to distinguish the objects of the model from the objects of the syntactic rewriting system, we call the latter objects *types*. Namely  $\llbracket A \rrbracket$  is the object of  $\mathcal{M}$  interpreting the type  $A$ .

The elements of the interpretation of an atomic type are called *atoms*. The interpretations of types are either those associated with atomic types,  $\mathbf{1}$ ,  $\llbracket A \rrbracket \times \llbracket B \rrbracket$ , or  $\exp \llbracket A \rrbracket$ . Hence, an element of the interpretation of a type is either an atom,  $*$ , a pair  $(a, b)$ , or a finite multiset  $\{a_1, a_2, \dots, a_n\}$ . Although the category  $\mathcal{M}$  does not distinguish between  $A$  and  $A^*$ , if we have the information of types, we can recover positive and negative occurrences. To this end, we introduce the notion of signed elements using overbars. Provided that  $\alpha$  is a signed element of  $\llbracket A \rrbracket$ , we write  $\bar{\alpha}$  if we regard it as a signed element of  $\llbracket A^* \rrbracket$ . Note that  $\alpha$  and  $\bar{\alpha}$  are equal as the members of  $\llbracket A \rrbracket = \llbracket A^* \rrbracket$ . We say that an occurrence of  $\alpha$  is positive (or negative) if it occurs under an even (or odd) number of nested overbars. For example,  $\alpha$  is positive and  $\beta$  is negative in  $(\bar{\alpha}, \beta)$ . In the coming argument, signed atoms and positive multiset occurrences play important roles. When we are concerned with  $\llbracket f \rrbracket : \llbracket B \rrbracket \rightarrow \llbracket C \rrbracket$  or  $M_f \in \mathbf{Set}^{\llbracket B \rrbracket \times \llbracket C \rrbracket}$ , we give signs as  $(\bar{\beta}; \gamma)$  for  $\beta \in \llbracket B \rrbracket$  and  $\gamma \in \llbracket C \rrbracket$ . Accordingly,  $\alpha$  occurs positively in  $(\beta; \gamma)$  if it occurs positively in  $\gamma$  or negatively in  $\beta$ .

## 4. Graphics

We give a graphical presentation of normal forms of our calculus. It is an extension of Blute-Cockett-Seely-Trimble graphs for the  $*$ -autonomous category [3]. The graphical presentation absorbs equivalences of the calculus, thus facilitates arguments modulo congruence. We can dispense with diagram chasing with regard to the coherence equivalences. We emphasize that constructing a graphical calculus is not our purpose. Indeed, we associate graphs with normal forms only.

Graphs are obtained by linking parts by wires (rough analogy with electric circuits). The directions up/down and left/right matter. Each wire has a type. It is often omitted as it is restored from the shape of the graph. The tensor parts with the wires attaching

to them are the following two:

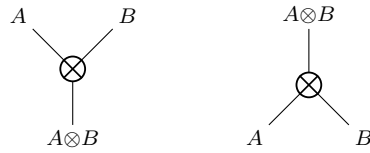

The cotensor parts are the following two:

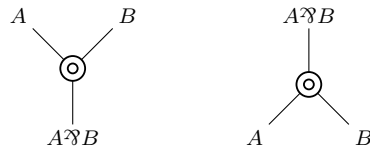

We use the double circle in place of  $\circ$ . The unit parts are

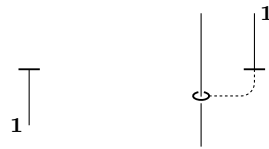

The counit parts are

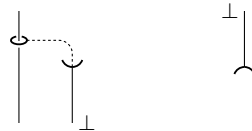

The duality parts are



In all of these, the left graph is called the introduction rule and the right the elimination rule. Wires can cross. However, the choice of which wire lays over the other does not matter as we consider symmetric monoidal categories:



It may be intuitive to regard the dotted wire as a fishing line. It is difficult to see, but certainly exists to connect the part to another wire. A rubberband gives a good analogy for the ring connecting the fishing line to a wire. It is elastic, can move around, and can rotate around a wire:



This completes the definition of the graphs of the  $*$ -autonomous category. The modification rules of graphs corresponding to the coherence conditions of units are given in [3]. Two graphs transferring to one another are regarded to be equal. Not all graphs are legitimate. We consider only the graphs subject to the well-known switching condition [8].

We extend the graph to the classical linear category. We add the following  $\delta$ -part,  $\varepsilon$ -part,  $d$ -part, and  $e$ -part:

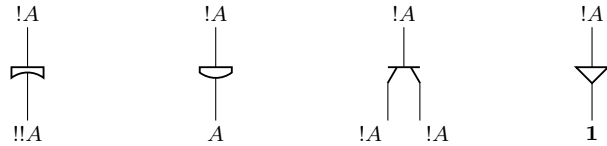

The optic lense symbols for  $\delta$  and  $\varepsilon$  are borrowed from [1, 22]. The  $d$ -part is also called a duplicator, and the  $e$ -part an eliminator. By one of the coherence conditions, the duplicator satisfy

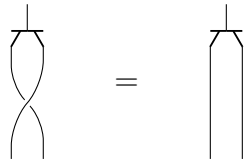

Namely, a duplicator can rotate around the axis. Moreover, the following equality holds:



Namely, the order of duplications does not matter. Accordingly, it is sometimes convenient to introduce the following multi-duplicator:



by integrating successive occurrences of duplicators. A *board* organizes a new part from an already constructed graph. If we have a graph  $G'$  having  $m$  wires upward and a single wire downward, a board is given as

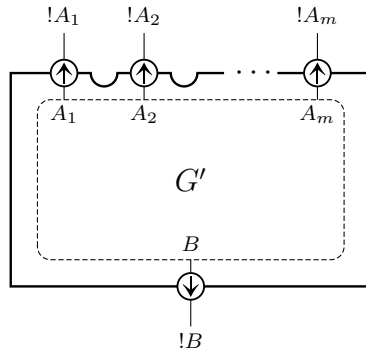

Here a dotted line signifies the subgraph  $G'$  and it is not drawn in practice. The thick arrows with surrounding circles located on the boundary are called the *gates* of the board. The single gate on the bottom is a positive gate, and the ones on the top are negative gates. The boards are the two-sided version of the boxes in proof-nets [10].

The switching condition is extended. The  $d$ -part is similar to the tensor introduction, thus obeys the switching. The board may be regarded as a sequence of the tensor introduction. Hence the switching is not involved.

The morphisms  $\delta_A, \varepsilon_A, d_A$ , and  $e_A$  are interpreted by the corresponding parts. The structural morphisms  $\tilde{\varphi}_{A,B}$  and  $\varphi_0$  are interpreted by

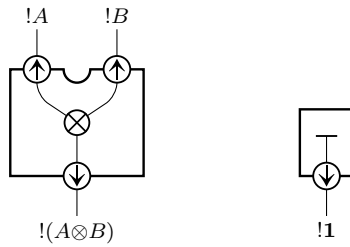

The following give the  $\beta$ -elimination rules:

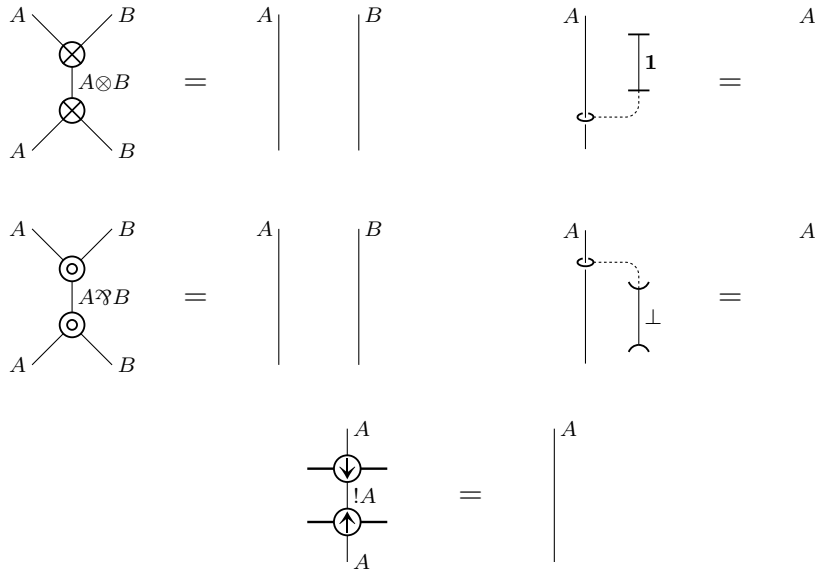

The elimination contracts the left-hand side to the right-hand side. The contraction is applied whenever they are possible. We omit the  $\beta$ -rule for the duality parts. It does not occur since we are concerned only with normal forms, in which duality  $\beta$ -redexes have been contracted. The following are the  $\eta$ -expansion rules:

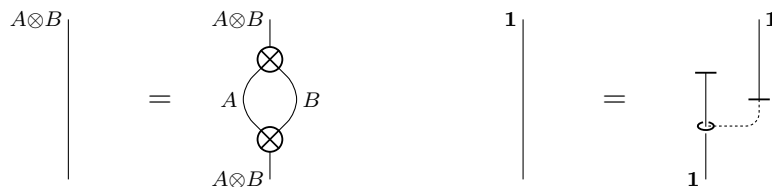

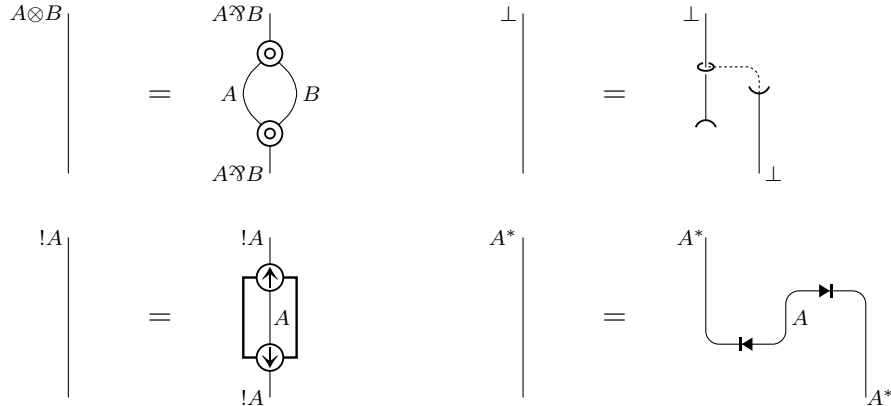

The expansion rules transform the left graphs to the right graphs. The rules are applied as far as they do not create new redexes. First, if the  $\eta$ -expansion creates a new  $\beta$ -redex (including those of the duality), the expansion is not applied. Second, the rule for  $!A$  is not applied immediately above (i.e., the flat side of) a  $\delta$ -part, an  $\varepsilon$ -part, a  $d$ -part, or an  $e$ -part, since it creates a new naturality redex, i.e., a redex of rules (18) to (21).

The equivalence between morphisms is absorbed by graphical equivalence under the  $\beta$ -rules. For example, the naturality of  $\tilde{\varphi}$  turns out to be the following sequence of equivalences:

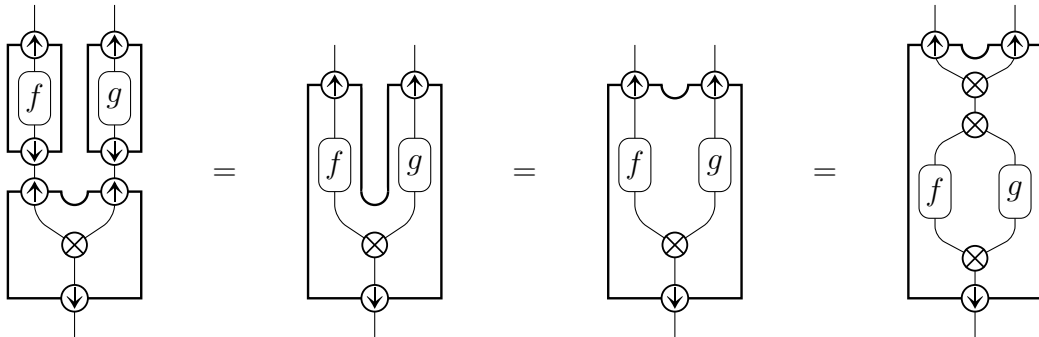

Here the first and the last equalities are  $\beta$ -rules and the middle simply changes the depth of the slit (we implicitly assume that the depths of slits do not matter). For the coherences involved in  $\mathbf{1}$  and  $\perp$ , the equivalence rules for the  $*$ -autonomous case should be appropriately extended. We leave these to the reader since the results in this paper are not concerned with them.

We transform only normal forms into graphs. Hence not all combinations are legitimate. For example, an  $e$ -part is not allowed to be linked to a leg of a  $d$ -part. In particular, by the rewriting rules (1) to (7) and the convention of the  $\eta$ -expansions,  $\delta$ -parts always

occur in the shape

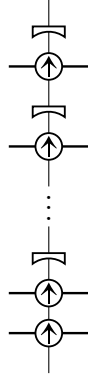

Namely, the leg of each  $\delta$ -part must be linked to a negative gate of a board. Moreover, the lowest  $\delta$ -part must have two negative gates in a row. This corresponds to  $\delta; !\delta; \dots; !^{n-1}\delta$ .

Remark: We explain why dimples are put on the upper edge of a board. We recall that we associate graphs only with normal forms. For a moment, however, suppose that we are trying to develop a graphical rewriting system, and let us see how the  $(\varphi_0; \tilde{\varphi})$ -type rule (17) looks. It contracts  $\mathbf{1} \otimes !A \xrightarrow{\varphi_0} !\mathbf{1} \otimes !A \xrightarrow{\tilde{\varphi}} !(1 \otimes A)$ . This sequence of morphisms translates into

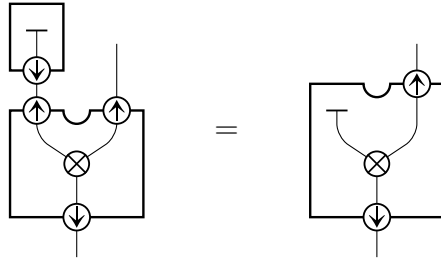

Observe that the dimple is not sandwiched between two gates. In contrast, every dimple has a gate on each side if the graph comes from a normal form. Namely, the rule (17) would be regarded as a rule eliminating an isolated dimple that does not lay between two gates.

We can restore a morphism from a legitimate graph by the process of sequentialization. It is naturally defined by extending the definition in [3]. The process is not unique but yields equivalent morphisms regardless of the choice. Although we do not give details here, let us address a point not stressed in [3]. A crossing of wires does not make sense in its own right. We have two symmetries  $A \otimes B \cong B \otimes A$  and  $A \wp B \cong B \wp A$ , both represented by crossing. Indeed, some crossing is unable to be interpreted by any of these. Suppose that we have

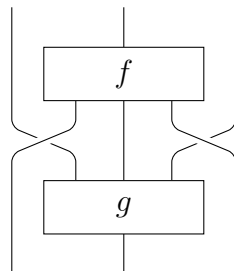

We have trouble if we want to compose  $f$  and  $g$  as a step of sequentialization, since wires of  $f$  cross over wires of  $g$ . Two crossings are neither that of  $\otimes$  nor  $\wp$ . We should redraw the graph as follows:

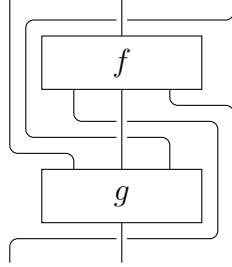

Now the crossing wires between two boxes are both connected to  $f$  or both connected to  $g$ . The former is interpreted as the symmetry of cotensor, and the latter as that of tensor. The outer crossings are handled after composing  $f$  and  $g$ .

Figure 2 gives an example of a graph. It is the translation of the following morphisms. To facilitate the parsing, we denote the dual by  $\overline{A}$  in place of  $A^*$ . Let  $f$  be<sup>1</sup>

$$\begin{aligned} &!(A \wp \overline{!(A \wp \overline{A})}) \otimes \overline{!(A \wp \overline{A})} \xrightarrow{\tilde{\varphi}} \overline{!(A \wp \overline{!(A \wp \overline{A})}) \otimes \overline{!(A \wp \overline{A})}} \xrightarrow{!d'} \\ &\quad \overline{!(A \wp \overline{!(A \wp \overline{A})}) \otimes \overline{!(A \wp \overline{A})}} \xrightarrow{!(\cdot\gamma)} \overline{!(A \wp \perp)} \xrightarrow{\sim} \overline{!A} \xrightarrow{\sim} \overline{!(A \otimes \mathbf{1})} \xrightarrow{!(\cdot\tau)} \\ &\quad \overline{!(A \otimes \overline{!(A \wp \overline{A})})} \xrightarrow{!(\cdot e)} \overline{!(A \otimes \overline{!(\mathbf{1} \wp \overline{A})})} \xrightarrow{!d} \overline{!(A \otimes \mathbf{1}) \wp \overline{A}} \xrightarrow{\sim} \overline{!(A \wp \overline{A})} \end{aligned}$$

and let  $g$  be the following, which uses  $f$ :

$$\begin{aligned} &\overline{!(A \wp \overline{!(A \wp \overline{A})})} \otimes \overline{!(A \wp \overline{!(A \wp \overline{A})})} \otimes \overline{!(A \wp \overline{A})} \xrightarrow{\tilde{\varphi}^2} \\ &\quad \overline{!(A \wp \overline{!(A \wp \overline{A})})} \otimes \overline{!(A \wp \overline{!(A \wp \overline{A})})} \otimes \overline{!(A \wp \overline{A})} \xrightarrow{!(\cdot\delta)} \\ &\quad \overline{!(A \wp \overline{!(A \wp \overline{A})})} \otimes \overline{!(A \wp \overline{!(A \wp \overline{A})})} \otimes \overline{!(A \wp \overline{A})} \xrightarrow{!(\cdot f)} \\ &\quad \overline{!(A \wp \overline{!(A \wp \overline{A})})} \otimes \overline{!(A \wp \overline{A})} \xrightarrow{!d'} \overline{!(A \wp \overline{!(A \wp \overline{A})})} \otimes \overline{!(A \wp \overline{A})} \xrightarrow{!(\cdot\gamma)} \\ &\quad \overline{!(A \wp \perp)} \xrightarrow{\sim} \overline{!A}. \end{aligned}$$

The figure is the graph of the following morphism containing  $g$ :

$$\begin{aligned} &\overline{!(A \wp \overline{!(A \wp \overline{A})})} \otimes \overline{!(A \wp \overline{A})} \xrightarrow{!d} \\ &\quad \overline{!(A \wp \overline{!(A \wp \overline{A})})} \otimes \overline{!(A \wp \overline{!(A \wp \overline{A})})} \otimes \overline{!(A \wp \overline{A})} \otimes \overline{!(A \wp \overline{A})} \xrightarrow{\sim} \\ &\quad \overline{!(A \wp \overline{A})} \otimes \overline{!(A \wp \overline{!(A \wp \overline{A})})} \otimes \overline{!(A \wp \overline{!(A \wp \overline{A})})} \otimes \overline{!(A \wp \overline{A})} \xrightarrow{\varepsilon \cdot \delta \tilde{\delta}} \\ &\quad \overline{!(A \wp \overline{A})} \otimes \overline{!(A \wp \overline{!(A \wp \overline{A})})} \otimes \overline{!(A \wp \overline{!(A \wp \overline{A})})} \otimes \overline{!(A \wp \overline{A})} \xrightarrow{!g} \\ &\quad \overline{!(A \wp \overline{A})} \otimes \overline{!A} \xrightarrow{!d'} \overline{!(A \wp \overline{!(A \wp \overline{A})})} \otimes \overline{!A} \xrightarrow{!\gamma} \overline{!(A \wp \perp)} \xrightarrow{\sim} \overline{!A} \end{aligned}$$

The morphism  $f$  corresponds to the second board from the outermost, while  $g$  to the outermost. The inner two boards are created by  $\eta$ -expansions. The types of wires are omitted in part by space restriction. Although the morphisms are long, they are derived from the typing judgment  $\Gamma \vdash y(x(\lambda z. xy))$  of the lambda calculus. Here  $\Gamma$  consists of  $x : (A \Rightarrow A) \Rightarrow A$  and  $y : A \Rightarrow A$ .

4.1. DEFINITION. The graphs  $G$  and  $G'$  are *almost equal* if they are equal when all the dotted lines and the attached rings of units/countits are erased. We write  $G \sim G'$ .

<sup>1</sup>We use dots in place of appropriate identity morphisms in order to save space and promote readability.



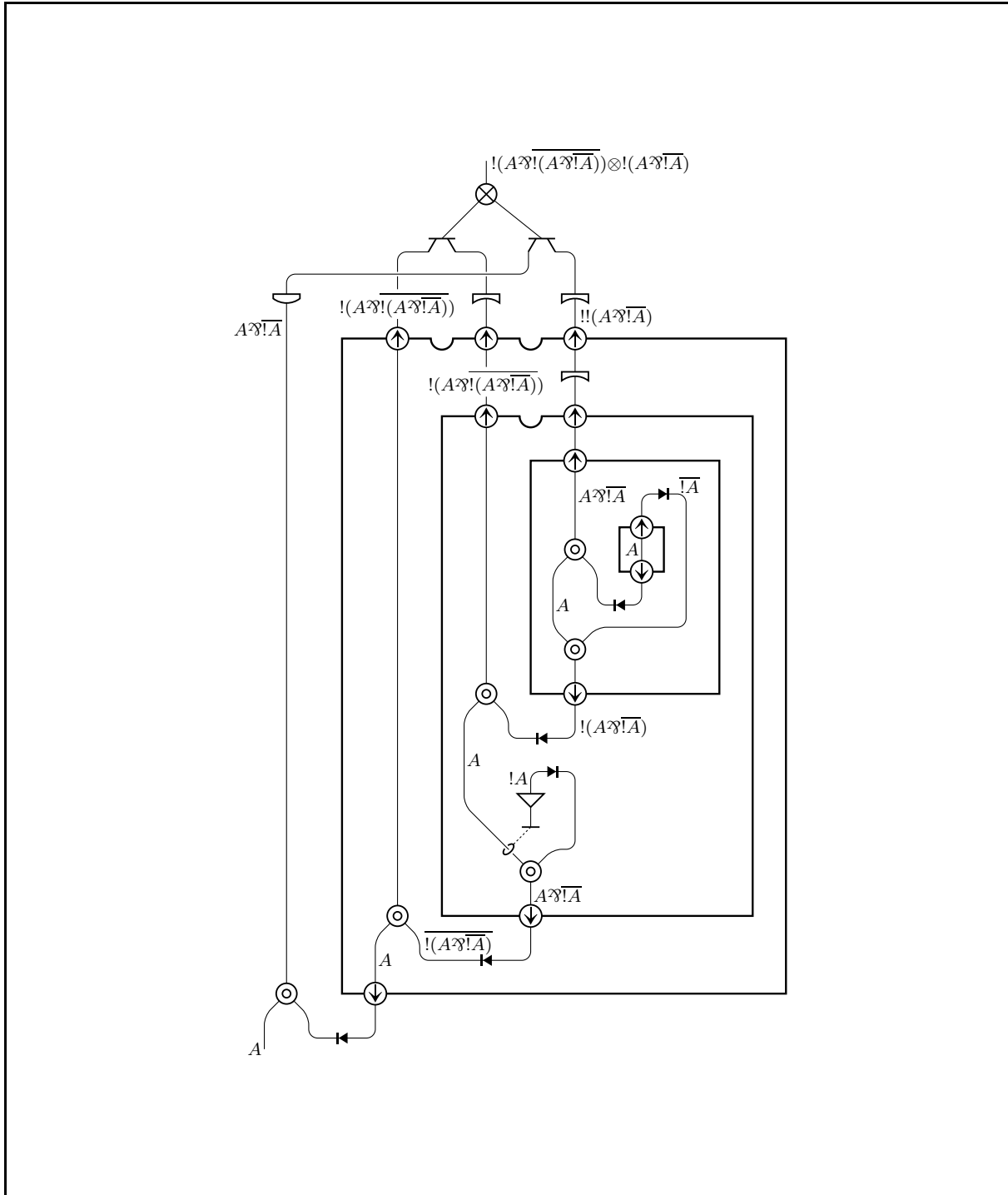

Figure 2: An example of a graph

Accordingly, if  $f$  and  $f'$  are morphisms in normal forms and their associated graphs are almost equal, we write  $f \sim f'$ .

Namely,  $f \sim f'$  holds if they are equal except how the isomorphisms  $A \otimes \mathbf{1} \cong A$  and  $A \wp \perp \cong A$  are used. The goal of this paper is to show  $f \sim f'$  whenever  $f$  and  $f'$  are the normal forms obtained by contracting a common morphism.

## 5. Enumeration

We return to the analysis of the model  $\mathcal{M}$ . Hereafter, we often omit the brackets in  $\llbracket A \rrbracket$ , simply writing  $A$ . This is not harmful since we are not concerned with equalities between objects. In contrast, brackets enclosing morphisms should not be omitted, since we are motivated to relate the equality of morphisms of the free linear category with that of the model  $\mathcal{M}$ .

In general, it is difficult to compute the matrix component of  $M_f$ . In fact,  $M_f$  may be involved in the matrix multiplication  $(NM)[a, c] = \sum_b N[b, c]M[a, b]$  in which  $b$  ranges over an infinite set, thus not computable in finite time. However, we have an effective method to compute the matrix components. We first contract  $f$  to a normal form, then translate it to a graph, whence the following process works.

The effective method is given by an enumeration process on the graph. Suppose that the graph

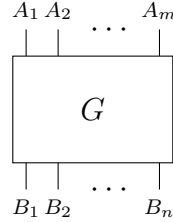

is obtained from a normal form  $f : A_1 \otimes A_2 \otimes \cdots \otimes A_m \rightarrow B_1 \wp B_2 \wp \cdots \wp B_n$ . We want to compute the component  $M_f[(\alpha_1, \alpha_2, \dots, \alpha_m); (\beta_1, \beta_2, \dots, \beta_n)]$  for  $\alpha_i \in A_i$  and  $\beta_j \in B_j$ . We define a process  $\pi(G)_{\beta_1 \beta_2 \dots \beta_n}^{\alpha_1 \alpha_2 \dots \alpha_m}$ . The return value of the process is a non-negative integer. We have  $M_f[(\alpha_1, \alpha_2, \dots, \alpha_m); (\beta_1, \beta_2, \dots, \beta_n)] = \pi(G)_{\beta_1 \beta_2 \dots \beta_n}^{\alpha_1 \alpha_2 \dots \alpha_m}$ . The process may fork meantime, spawning several subprocesses to run concurrently. Moreover, speculative executions are carried out, thus some processes may fail at some point and are aborted. The aborted processes are enforced to return 0. In other words, they do not contribute to the enumeration. Successful processes return positive integers.

We start with annotating the outermost wires by the elements as

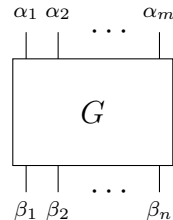

The process  $\pi(G) = \pi(G)_{\beta_1 \beta_2 \dots \beta_n}^{\alpha_1 \alpha_2 \dots \alpha_m}$  decomposes the graph in the reverse order of sequentialization. The decomposition is occasionally non-deterministic, though it is deterministic in many cases. If the annotated graph  $G$  is the left of the following

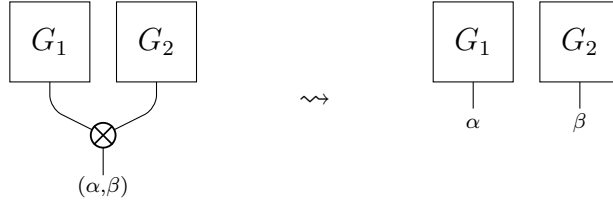

then it is deterministically decomposed into the right annotated graph. Here the graphs may have more outgoing wires, which are suppressed for simplicity. The same comment is applied to all of the following cases, and is repeated no more. Given the return values of the processes  $\pi(G_1)_\alpha$  and  $\pi(G_2)_\beta$ , we set  $\pi(G)_{(\alpha, \beta)} = \pi(G_1)_\alpha \cdot \pi(G_2)_\beta$ . If the graph  $G$  is the left of the following,

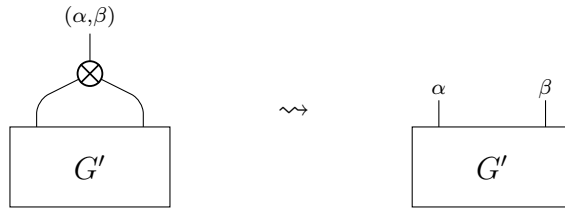

it is decomposed into the right, and  $\pi(G)^{(\alpha, \beta)} = \pi(G')^{\alpha\beta}$ . In the case of cotensor, the decomposition is similar except the graphs are turned upside down. The unit introduction is manipulated as follows:



We set  $\pi(G) = \pi(G')^*$ . The unit elimination rule is manipulated as follows:

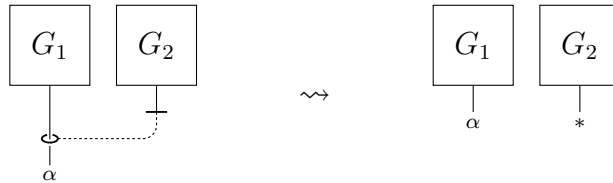

We set  $\pi(G)_\alpha = \pi(G_1)_\alpha \cdot \pi(G_2)_*$ . The counit rules are symmetric. The duality introduction rule is handled as follows:

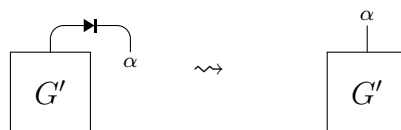

We set  $\pi(G)_\alpha = \pi(G')^\alpha$ . The elimination rule is symmetric.

Next, we consider the parts related to  $!$ . Here the speculative executions matter. In the case of an  $e$ -part, if  $G$  is the left-hand side of

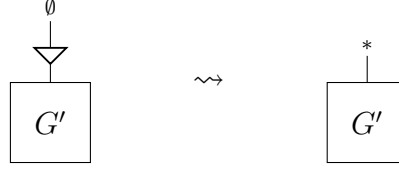

then it is modified to the right graph. We set  $\pi(G)^\emptyset = \pi(G')^*$ . If the wire in the left graph is annotated by  $\alpha \neq \emptyset$ , the process fails and is aborted immediately. We impose  $\pi(G)^\alpha = 0$ , not proceeding to  $G'$ . The case of an  $\varepsilon$ -part is handled as follows:

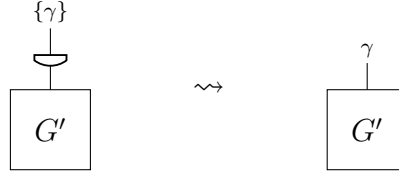

We set  $\pi(G)^{\{\gamma\}} = \pi(G')^\gamma$ . If the wire in the left graph is annotated by  $\alpha$  that is not a singleton, the process is aborted immediately and returns  $\pi(G)^\alpha = 0$ . The remaining three cases are involved in non-determinacy. The decomposition for a  $d$ -part is given as

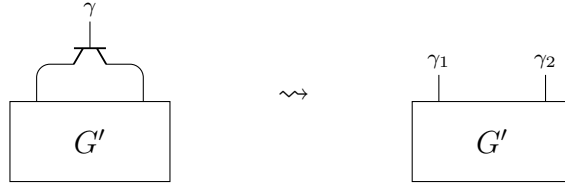

where the sub-multisets  $\gamma_1$  and  $\gamma_2$  are chosen so that  $\gamma = \gamma_1 + \gamma_2$  holds. For each of such pairs, a subprocess  $\pi(G')^{\gamma_1\gamma_2}$  is invoked. The number of created subprocesses is equal to the number of different ordered pairs  $(\gamma_1, \gamma_2)$ . We remark that  $\gamma_1 + \gamma_2$  and  $\gamma_2 + \gamma_1$  are separately handled unless  $\gamma_1 = \gamma_2$ . Given the returns of the subprocesses, we set  $\pi(G)^\gamma = \sum \pi(G')^{\gamma_1\gamma_2}$ . The sum ranges over all successful subprocesses. The process  $\pi(G)$  succeeds if one of the subprocesses succeeds. As the failing subprocess returns 0, we may equivalently take the sum to range over all different ordered pairs  $(\gamma_1, \gamma_2)$ . The decomposition of a  $\delta$ -part is given as follows:



We suppose  $\gamma = \gamma_1 + \gamma_2 + \dots + \gamma_n$  where  $n \geq 0$ . The order of  $\gamma_i$  is irrelevant. We invoke  $\pi(G')^{\{\gamma_1, \gamma_2, \dots, \gamma_n\}}$  for each of such decompositions. We set  $\pi(G)^\gamma = \sum \pi(G')^{\{\gamma_1, \gamma_2, \dots, \gamma_n\}}$ .

Next, We consider the decomposition of a board. Suppose that the outgoing wires of a board are annotated as follows:

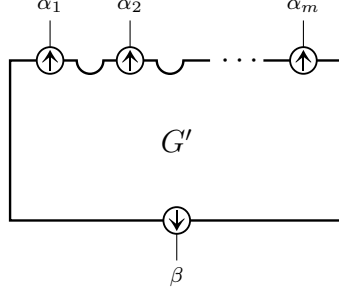

First, we check whether all of  $\alpha_1, \alpha_2, \dots, \alpha_m$  and  $\beta$  have the same number of elements. Otherwise the process fails and returns  $\pi(G')_{\beta}^{\alpha_1 \alpha_2 \dots \alpha_m} = 0$ . Provided that the multisets have the same cardinality  $n \geq 0$ , let us put  $\alpha_i = \{a_{i1}, a_{i2}, \dots, a_{in}\}$  and  $\beta = \{b_1, b_2, \dots, b_n\}$ . We choose and fix a linear ordering  $b_1, b_2, \dots, b_n$  once and for all. A *linear disposition* of  $\alpha_i$  is a linear order obtained by shuffling the  $n$  element of  $\alpha_i$ . Namely, if  $\sigma$  is a permutation over  $n$  letters, a linear disposition of  $\alpha_i$  is  $a_{i\sigma(1)}, a_{i\sigma(2)}, \dots, a_{i\sigma(n)}$ . Let  $l_i$  denote the number of all linear dispositions of  $\alpha_i$ . For instance, if the elements of  $\alpha_i$  are all different then  $l_i = n!$ ; if all are identical then  $l_i = 1$ . We form an  $m \times n$  matrix

$$\begin{array}{cccc} a'_{11} & a'_{12} & \cdots & a'_{1n} \\ a'_{21} & a'_{22} & \cdots & a'_{2n} \\ \vdots & \vdots & & \vdots \\ a'_{m1} & a'_{m2} & \cdots & a'_{mn} \end{array}$$

where the  $i$ -th row is a linear disposition of  $\alpha_i$ . The number of different matrices is equal to  $l_1 l_2 \cdots l_m$ . Given a matrix, we spawn a subprocesses per column. Namely, we invoke  $n$  processes  $\pi(G')_{b_1}^{a'_{11} a'_{21} \dots a'_{m1}}$ ,  $\pi(G')_{b_2}^{a'_{12} a'_{22} \dots a'_{m2}}$ ,  $\dots$ ,  $\pi(G')_{b_n}^{a'_{1n} a'_{2n} \dots a'_{mn}}$ . Then we set

$$\pi(G)_{\beta}^{\alpha_1 \alpha_2 \dots \alpha_m} = \sum \pi(G')_{b_1}^{a'_{11} a'_{21} \dots a'_{m1}} \pi(G')_{b_2}^{a'_{12} a'_{22} \dots a'_{m2}} \dots \pi(G')_{b_n}^{a'_{1n} a'_{2n} \dots a'_{mn}}.$$

The sum ranges over the different matrices. We note that the order of the elements of  $\beta$  is fixed, whereas the elements of  $\alpha_i$  are shuffled. This corresponds to the asymmetry of  $!f$  in the model  $\mathcal{M}$ .

Finally, suppose that the process reaches a wire of an atomic type

$$\left| \begin{array}{c} a \\ b \end{array} \right.$$

If  $a = b$ , we set  $\pi(G)_a^a = 1$ ; otherwise  $\pi(G)_b^a$  fails and returns 0.

Two types of concurrency appear. One is non-determinacy, which is invoked at  $d$ -parts,  $\delta$ -parts, and boards by the choices of decomposition. In the terminology of alternating computation models, it is the  $\exists$ -type non-determinism. Namely, a process succeeds if one of the subprocesses succeeds. In the decomposition of boards, we also have the  $\forall$ -type

concurrency that succeeds only when all of the subprocesses succeed. At a board  $G$ , the process create subprocesses by  $\exists$ -type non-determinism, which in turn create further subprocesses by the  $\forall$ -type concurrency. Hence the value of  $\pi(G)$  is defined by a sum of multiplications.

5.1. LEMMA. *Let  $G$  denote the graph associated with  $f : A \rightarrow B$  in normal form. Then  $\pi(G)_\beta^\alpha = M_f[\alpha; \beta]$  holds.*

PROOF. The definition of  $\pi(G)$  simply rephrases the structure of  $\mathcal{M}$  in the terminology of processes. ■

5.2. LEMMA. *Every components  $M_f[\alpha; \beta]$  is finite for every  $f$  of the calculus.*

PROOF. Contract  $f$  to a normal form and turn it into a graph. The process  $\pi(G)$  only decomposes the graph. The number of subprocesses is bounded by the tally of multiset decompositions. Hence the numbers are finite. ■

## 6. Generic forms

We introduce the notion of the generic form  $\varphi(G)$  of a graph  $G$ . It is a kind of regular expressions. In the theory of automata, we can restore an automaton from a regular expression [25]. Moreover, the latter can be used as machinery to enumerate the language recognized by the automaton [24]. The generic form has similar functionality. It can be used to restore the graph  $G$  to some extent, as well as it gives information of  $M[\alpha; \beta]$  for the corresponding matrix. Our goal is to explore the relation between the syntax of the linear category and the model  $\mathcal{M}$ . The generic form is a hinge between syntax and semantics.

We define the orientation of wires of a graph, then we associate the generic forms on the wires along the flows determined by the orientation. To save space, however, we simultaneously give the orientation and the association of generic forms.

First of all, we assign different identifiers  $i, j, \dots$  to the boards occurring in the graph. To each wire of an atomic type, we put arrowheads in both ends. It is called a bioriented wire. The generic form is given as

$$\updownarrow x_{i_1 i_2 \dots i_n}$$

where  $x$  is a variable  $i_1, i_2, \dots, i_n$  are the list of the boards that contain this wire, ordered from the innermost. We assume that different bioriented wires have different variables. We often call the whole  $x_{i_1 i_2 \dots i_n}$  a variable. The orientation and generic form of tensor parts are

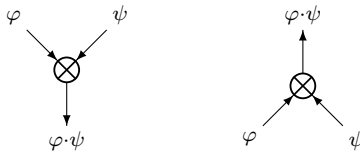

For the cotensor parts, we similarly set as follows:

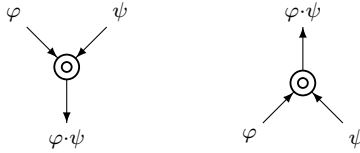

For the units and counits, we set

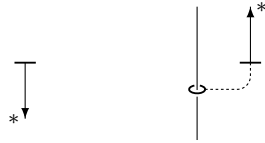

and

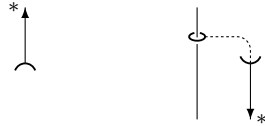

For the duality parts, we set



The generic form does not alter, while the orientation of the flow rotates 180°. The orientations and the generic forms for a  $\delta$ -part, an  $\varepsilon$ -part, a  $d$ -part, and an  $e$ -part is

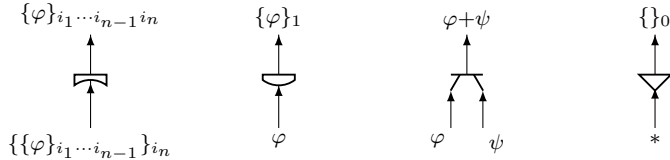

We recall that a  $\delta$ -part must have a gate of a board immediately below. Hence the generic form beneath the  $\delta$ -part is justified from the case of a board below. For the  $d$ -part, we do not distinguish between  $\varphi + \psi$  and  $\psi + \varphi$ . For a board  $i$ , we set

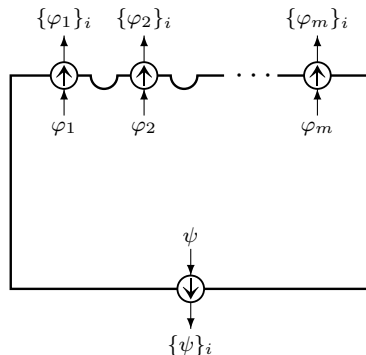

6.1. LEMMA. *Flows never collide and never loop.*

PROOF. Collision occurs at a  $\beta$ -redex or at a board located immediately above a  $\delta$ -part, an  $\varepsilon$ -part, a  $d$ -part, or an  $e$ -part. By our convention on graphs, there are no  $\beta$ -redexes and no  $\eta$ -expansion is applied above these four parts. So there is no collision. The changes of directions up/down are caused only by duality parts, which changes the type  $A$  to more complex  $A^*$ . Hence, if a flow returned to the same place, the type of the wire could not be equal to the original. So there is no loop. ■

Therefore, flows spring at the ridges of bioriented wires or unit parts, run down into the ocean through the outgoing wires, occasionally joining with one another. If the generic forms assigned to the outgoing wires are

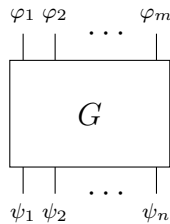

then the *generic form*  $\varphi(G)$  is defined to be  $(\varphi; \psi)$  where  $\varphi = (\varphi_1, \varphi_2, \dots, \varphi_m)$  and  $\psi = (\psi_1, \psi_2, \dots, \psi_n)$ . Figure 3 gives the generic form of the graph in Fig. 2.

6.2. LEMMA. *From the generic form  $(\varphi; \psi)$  together with the types of the outgoing wires, we can restore the graph  $G$  up to  $\sim$ .*

PROOF. We decompose the generic form one by one, restoring the graph. Although the duality is not reflected by the generic form, its information is covered by the types. For example, when  $\varphi \cdot \psi$  is decomposed, the type of wires determines whether it comes from tensor or cotensor. No information of the dotted lines of units/counits is reflected in generic forms, thus the restoration is up to  $\sim$ . ■

As seen in the lemma above, a generic form almost reflects the structure of a graph. Simultaneously, the generic form behaves as a template the instances of which give information of the interpretation in  $\mathcal{M}$ . An instance is provided by an assignment pair, which we explain shortly.

As  $\exp A$  occurs in the interpretation of boards, and as boards can be nested, we have to manipulate iterative applications of the functor  $\exp A$ . For instance, an element of  $\exp(\exp A)$  is a multiset of multisets, e.g.,  $\{\{a, b\}, \{c, d, e\}\}$ . This is represented by the tree

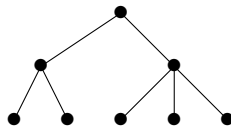



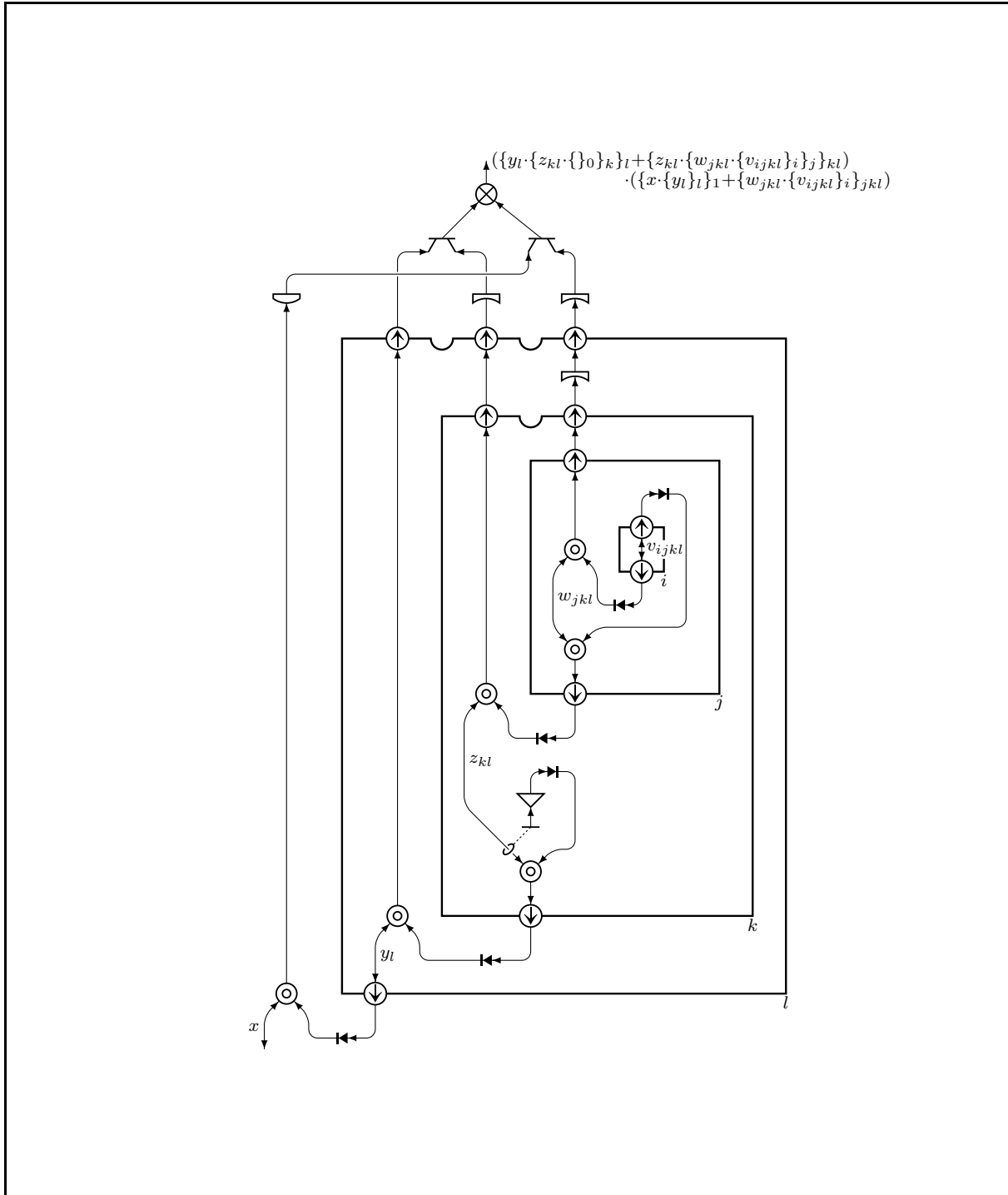
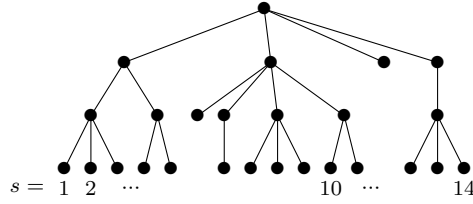

Figure 3: An example of a generic form

where the leaves are annotated by the elements  $a$  through  $e$  in this order. We assign a sequence of non-negative integers to each board. Suppose that  $i$  is the identifier of the board. The sequence is denoted by  $\langle m_i(s); s = 1, 2, \dots, q_i \rangle$ . The length  $q_i$  is determined recursively as follows. If  $i$  is an outermost board, we set  $q_i = 1$ . If  $i$  is the innermost board containing  $j$ , we set  $q_j = \sum_{s=1}^{q_i} m_i(s)$ . The tree above is the case of  $m_i(1) = 2$  and  $m_j(s) = 2, 3$  for  $s = 1, 2$  respectively, for a graph that has two nested boards  $i$  and  $j$ , where  $i$  is outer. The number  $s$  enumerates the nodes at a fixed height. We identify  $s$  with a finite sequence  $(r_1, r_2, \dots, r_n)$  of positive integers. For instance, in the following tree



the leaf  $s = 10$  is identified with  $(2, 4, 1)$  since it is reached from the root by taking the second, the fourth, and the first children successively. At the root level,  $s = 1$  is identified with an empty sequence  $()$ . In general, suppose that  $i_n, \dots, i_2, i_1$  are the boards nesting from the outermost  $i_n$  in this order. For the sequence  $(r_1, r_2, \dots, r_n)$ , the components range over

$$\begin{aligned} 1 &\leq r_1 \leq m_{i_n}() \\ 1 &\leq r_2 \leq m_{i_{n-1}}(r_1) \\ 1 &\leq r_3 \leq m_{i_{n-2}}(r_1, r_2) \\ &\vdots \end{aligned}$$

We note that  $s$  enumerates the nodes of a fixed level. If levels are different, the same number  $s$  corresponds to sequences of different lengths.

Let  $x_{i_1 i_2 \dots i_n}$  be a variable for a wire of an atomic type  $A$ . We recall that  $i_1, i_2, \dots, i_n$  are the boards containing the wire, listed from the innermost. We consider an assignment  $\eta(x_{i_1 i_2 \dots i_n}, s)$ . It assigns an element of the interpretation of  $A$  for each of  $s = 1, 2, \dots, q_{i_1}$ .

An *assignment pair* is defined as  $P = (\{m_i\}_i, \eta)$  where  $i$  ranges over all boards of a graph. Given  $s = (r_1, r_2, \dots, r_k)$ , an assignment pair  $P(s)$  is naturally induced. It is the pair  $(\{m'_j\}_j, \eta')$  where  $m'_j(s) = m_j(s \hat{\ } s')$  and  $\eta'(x_{i_1 i_2 \dots i_n}, s') = \eta(x_{i_1 i_2 \dots i_n}, s \hat{\ } s')$ . Here  $s \hat{\ } s'$  denotes the concatenation of sequences.

We associate  $|\varphi|_P$  with each generic form  $\varphi$  and each assignment pair  $P$ . If  $\varphi$  annotates a wire of type  $A$ , then  $|\varphi|_P$  is an element of the interpretation of the type  $A$ . We define  $|\varphi|_{P(s)}$  recursively.

- (i)  $|x_{i_1 i_2 \dots i_n}|_{P(s)} = \eta(x_{i_1 i_2 \dots i_n}, s)$ .
- (ii)  $|*|_{P(s)}$  is the unique element  $*$  of  $\mathbf{1}$ .
- (iii)  $|\varphi \cdot \psi|_{P(s)}$  is the pair of  $|\varphi|_{P(s)}$  and  $|\psi|_{P(s)}$ .
- (iv)  $|\varphi + \psi|_{P(s)}$  is the multiset union of  $|\varphi|_{P(s)}$  and  $|\psi|_{P(s)}$ .
- (v)  $|\{\}_0|_{P(s)}$  is the empty multiset  $\emptyset$ .
- (vi)  $|\{\varphi\}_1|_{P(s)}$  is the singleton the member of which is  $|\varphi|_{P(s)}$ .

(vii)  $|\{\varphi\}_{i_1 i_2 \dots i_l}|_{P(s)}$  is the multiset consisting of  $|\varphi|_{P(s \sim s')}$  where  $s' = (r'_1, r'_2, \dots, r'_l)$  ranges over the sequences in which the domain of  $r'_j$  is determined by  $\{m_i\}_i$ .

Suppose that  $\varphi(G) = (\varphi; \psi)$  is the generic form of the graph  $G$ . Then  $(\alpha; \beta)$  is an *instance* of  $\varphi(G)$  if there is an assignment pair  $P$  such that  $\alpha = |\varphi|_P$  and  $\beta = |\psi|_P$ .

6.3. **REMARK.** A simple but important observation is the invariance of positive multiset occurrences. The unions of multisets occur only in (iv) and (vii) above, that is, at the upper ends of a  $d$ -part and a  $\delta$ -part. They are negative multisets. In fact, the flows traverse upward in these parts. Each positive multiset is created at the positive gate of a board. It is never reformed afterward, thus appears exactly in the same shape at an outermost wire.

6.4. **LEMMA.** *Suppose that  $G$  is the graph obtained from a morphism  $f$  in normal form. Then  $M_f[\alpha; \beta] \neq \emptyset$  if and only if  $(\alpha; \beta)$  is an instance of  $\varphi(G)$ .*

**PROOF.** We consider the process  $\pi(G)_\beta^\alpha$ . We show that the process succeeds if and only if  $(\alpha; \beta)$  is an instance. Suppose that the process succeeds. At a board, concurrent subprocesses are invoked. We provide process numbers  $s$  by appropriately ordering the subprocesses. If the  $s$ -th subprocess finds another box  $i$ , the multisets for its gates must have the same cardinality, say  $n$ . We assign  $m_i(s) = n$ . If the  $s$ -th process reaches a bioriented wire of  $x_{i_1 i_2 \dots i_k}$ , its both ends must be annotated by the same element, say  $a$ . We assign  $\eta(x_{i_1 i_2 \dots i_k}, s) = a$ . Conversely, suppose that the given tuple is an instance. Successful non-deterministic choices at  $d$ -parts, and  $\delta$ -parts and boards in the process are guided by the instance. For example, if an element above a  $\delta$ -part is  $\gamma = |\{\varphi\}_{i_1 i_2 \dots i_n}|_{P(s)}$ , it is decomposed into the multiset of multisets,  $\{\gamma_1, \gamma_2, \dots, \gamma_{m_i(s)}\}$ , where  $\gamma_j$  is given as  $|\{\varphi\}_{i_1 i_2 \dots i_{n-1}}|_{P(s \cdot j)}$ . Here  $s \cdot j$  denotes the sequence obtained by adjoining  $j$  to the right of the sequence  $s$ . ■

6.5. **REMARK.** We can also use the generic forms to count the number  $M_f[\alpha; \beta]$ , not only to know whether it is non-zero. To this end, we must modify the definitions of generic forms and instances to cope with the matter of asymmetry discussed in §3. In instances, we replace each positive multiset occurrence  $\{\gamma_1, \gamma_2, \dots, \gamma_n\}$  by a list  $[\gamma_1, \gamma_2, \dots, \gamma_n]$ , the order of elements in which is fixed arbitrarily. Negative multisets are not altered. We let  $\alpha'$  and  $\beta'$  denote the result of such modification. Accordingly, we replace the form  $\{\varphi\}_i$  at a positive position with  $[\varphi]_i$ . The instance  $|\{\varphi\}_i|_P$  is redefined as a list, instead of a multiset. Then  $M_f[\alpha; \beta]$  is equal to the number of the assignment pairs that yield  $(\alpha'; \beta')$  as instances. This method is not suitable to actually compute the matrix components, since we must screen the matching instances after generating all possible instances. We prefer the method discussed in §5. In the proof of our main theorem, we are concerned only with the instances in which the difference between multisets and lists does not matter. See Def. 7.1.

## 7. Confluence

Confluence is the objective of this paper. It is verified via the model  $\mathcal{M}$ . We focus on special instances, called  $p$ -echo instances. We show that the generic forms can be uniquely rebuilt from such special instances. Suppose that a morphism has two normal forms,  $f$  and  $f'$ , the graphs of which are denoted by  $G$  and  $G'$  respectively. Then, the generic form  $\varphi(G)$  must equal  $\varphi(G')$ , provided that they share a common  $p$ -echo instance. Then  $G \sim G'$  is concluded by Lem. 6.2. Namely, the normal forms  $f$  and  $f'$  must be almost equal. This establishes the confluence up to  $\sim$ . A non-trivial part of this proof strategy is how to assure the existence of a common  $p$ -echo instance. This is achieved via the elementary number theory applied to the interpretation in  $\mathcal{M}$ .

7.1. DEFINITION. Let  $p$  be a prime number. A  $p$ -echo assignment pair of the generic form  $\varphi(G)$  is defined as  $P = (\{m_i\}_i, \eta)$  subject to the following conditions:

- (i) The value of  $m_i(s)$  does not depend on  $s$ , and  $m_i(s) = p^{p^k}$  for some  $k \geq 0$ . Moreover, if  $p^{p^k}$  and  $p^{p^l}$  are the values for distinct boards  $i \neq j$ , then  $k \neq l$ .
- (ii) The assignment  $\eta(x_{i_1 i_2 \dots i_n}, s)$  does not depend on  $s$ . Moreover, for distinct variables  $x_{i_1 i_2 \dots i_n} \neq y_{j_1 j_2 \dots j_m}$ , the assigned elements are different:  $\eta(x_{i_1 i_2 \dots i_n}, s) \neq \eta(y_{j_1 j_2 \dots j_m}, s')$ .

An instance is  $p$ -echo if it is an instance produced by a  $p$ -echo assignment pair.

The first halves of the conditions are called the *uniformity* condition: neither  $m_i(s) = p^{p^k}$  nor  $\eta(x_{i_1 i_2 \dots i_n}, s)$  does depend on  $s$ . The second halves are called the *discernibility* condition:  $m_i(s) \neq m_j(s')$  for different boards and  $\eta(x_{i_1 i_2 \dots i_n}, s) \neq \eta(y_{j_1 j_2 \dots j_m}, s')$  for different variables. A  $p$ -echo pair assigns the same number to the same board, and the same element to the same variable. It assigns different things to different boards or different variables. In a word, a  $p$ -echo assignment gives an “echoing” repercussion of the graph  $G$ .

7.2. DEFINITION. A multiset is *homogeneous* if it is of the shape  $\{\alpha, \alpha, \dots, \alpha\}$ . We write  $n\{\alpha\}$  regarding it as  $\{\alpha\} + \{\alpha\} + \dots + \{\alpha\}$  ( $n$  is the number of elements).

The positive multisets occurring in a  $p$ -echo instance are all homogeneous. We recall that positive multisets are never modified from the moments of creation at the positive gates of boards. By the uniformity condition, the positive multisets are homogeneous at the positive gates. Thus it remains so at the outermost wires. The set of different positive multisets in the  $p$ -echo instance has a one-to-one correspondence to the set of boards in the graph. It is an immediate consequence of the discernibility condition. Different positive multisets have different numbers of elements.

We give an example of a  $p$ -echo instance of the generic form in Fig. 3. We assign  $m_i(s) = p^{p^{k_1}}$ ,  $m_j(s) = p^{p^{k_2}}$ ,  $m_k(s) = p^{p^{k_3}}$ ,  $m_l(s) = p^{p^{k_4}}$  from the innermost boards. For the variables, we assign  $\eta(x, s) = a$ ,  $\eta(y_l, s) = b$ ,  $\eta(z_{kl}, s) = c$ ,  $\eta(w_{jkl}, s) = d$ ,  $\eta(v_{ijkl}, s) = e$ . Then the  $p$ -echo instance is the pair of

$$(p^{p^{k_1}} \{ \overline{(b, p^{p^{k_2}} \{ (c, \overline{\emptyset}) \})} \} + p^{p^{k_1+p^{k_2}}} \{ (c, \overline{p^{p^{k_3}} \{ (d, \overline{p^{p^{k_4}} \{ e \}}) \}}) \} \}, \\ p^0 \{ (a, p^{p^{k_1}} \{ b \}) \} + p^{p^{k_1+p^{k_2}+p^{k_3}}} \{ (d, \overline{p^{p^{k_4}} \{ e \}}) \} \})$$

and  $a$ . We add overbars to clarify the distinction between positive and negative. The first component of the pair corresponds to the source of a morphism, thus regarded to be contravariant. So its negative occurrences are positive. The list of different positive multisets is  $p^{p^{k_1}} \{ b \}$ ,  $p^{p^{k_2}} \{ (c, \emptyset) \}$ ,  $p^{p^{k_3}} \{ (d, p^{p^{k_4}} \{ e \}) \}$ , and  $p^{p^{k_4}} \{ e \}$ . These have a one-to-one correspondence to the boards. Moreover, all are homogeneous. We observe that the number of occurrences of these multisets are  $p^0$ ,  $p^{p^{k_1}}$ ,  $p^{p^{k_1+p^{k_2}}}$ ,  $p^{p^{k_1+p^{k_2}+p^{k_3}}}$  respectively.

**7.3. DEFINITION.** The *size* of a graph  $G$  is defined as the number of wires. It is denoted by  $\text{size}(G)$ .

For the following argument, indeed, a tighter bound works. It suffices that  $\text{size}(G)$  is not less than the number of legs of any multi-duplicators, the number of boards, and the number of bioriented wires. We choose this definition as is simple.

A  $p$ -echo instance directly reflects the structure of the underlying graph. As naturally expected, thus, the generic form can be restored from such an instance. We show that this is true if the graph is not too big.

**7.4. LEMMA.** *We consider the class of graphs  $G$  satisfying that  $\text{size}(G) < p$ . If  $(\alpha; \beta)$  is a  $p$ -echo instance of some generic form, then the form  $\varphi(G)$  is uniquely determined up to the renaming of the identifies of boards and the variables.*

**PROOF.** Let  $\delta_1, \delta_2, \dots, \delta_m$  enumerate all different positive multisets in  $(\alpha; \beta)$ . As explained above, they have one-to-one correspondence to the boards  $i_1, i_2, \dots, i_m$ . We put  $m_{i_j}(s) = p^{p^{k_j}}$ . The information of the nesting among boards is recovered from the number of occurrences of each  $\delta_j$ . Let us suppose that  $i_{u_1}, i_{u_2}, i_{u_3}, \dots$  nests from the outermost in this order. Then,  $\delta_{u_1}$  occurs exactly once,  $\delta_{u_2}$  occurs  $p^{p^{k_{u_1}}}$  times,  $\delta_{u_3}$  occurs  $p^{p^{k_{u_1}+p^{k_{u_2}}}}$  times, and so on. Namely, divisibility exactly corresponds to the nesting. There is only one way to rewrite  $p^l$  into  $p^{p^{k_{u_1}+p^{k_{u_2}+\dots+p^{k_{u_t}}}}$  except the order of the sum, since all  $k_j$  are different by the discernibility condition. By comparing the numbers by the divisibility, therefore, we can retain the complete information of nesting. Here the hypothesis about the size is not needed.

We reconstruct the generic form from the instance, one by one, from the outside. We replace a positive multiset  $p^{p^{k_j}} \{ \gamma' \}$  with  $\{ \gamma' \}_j$  and we continue from  $\gamma'$ . For a negative multiset  $\gamma$ , we first decompose it into  $\gamma = \gamma_1 + \gamma_2 + \dots + \gamma_n$ . Here,  $n < p$  and each  $\gamma_i$  is a homogeneous multiset of  $p^{l_i}$  elements for some  $l_i \geq 0$ . As  $n$  turns out to be the number of legs of a multi-duplicator, this constraint is justified as  $n \leq \text{size}(G) < p$ . We do not exclude the case  $\gamma_i = \gamma_j$ . For example, if  $p = 3$  and  $\gamma = \{ \alpha, \alpha, \alpha, \alpha, \alpha, \alpha \}$ , it is decomposed into  $\gamma_1 = \{ \alpha, \alpha, \alpha \} = \gamma_2$ . It is disallowed to decompose  $\gamma$  into the sum of six  $\{ \alpha \}$  since  $n < p$ . The decomposition of  $\gamma$  is, thus, unique up to the shuffles of the sum. We rewrite the number  $p^{l_i}$  to  $p^{p^{k_{u_1}+p^{k_{u_2}+\dots+p^{k_{u_t}}}}$ . Provided that the boards  $i_{u_1}, i_{u_2}, \dots, i_{u_t}$

nest from the outside in this order, we transform  $\gamma_i = p^{l_i}\{\gamma'\}$  to  $\{\gamma'\}_{i_{u_1}\dots i_{u_2}i_{u_1}}$ . If  $l_i = 0$ , we transform it to  $\{\gamma'\}_1$ . Then we continue from  $\gamma'$ . If  $\gamma = \emptyset$ , we transform it to  $\{\}_0$ . We transform  $(\alpha, \beta)$  to  $\alpha \cdot \beta$  and continue from each of  $\alpha$  and  $\beta$ . Finally, if we reach an atom, we translate it to a variable with appropriate indices. We choose different variables for different atoms. ■

This is not a deep result. If we know that an instance is  $p$ -echo from the outset, we can rebuild the generic form. What really matters is how to judge if a given instance is  $p$ -echo. Before discussing this problem, we give an immediate consequence of the lemma.

**7.5. COROLLARY.** *Suppose that  $\varphi(G)$  and  $\varphi(G')$  shares a common  $p$ -echo instance. If  $\text{size}(G), \text{size}(G') < p$ , then  $G \sim G'$  holds.*

**PROOF.** By Lem. 7.4 and 6.2. ■

We want to verify that, if  $\llbracket f \rrbracket = \llbracket g \rrbracket$  in the model  $\mathcal{M}$ , then  $\varphi(G_f)$  and  $\varphi(G_g)$  shares a  $p$ -echo instance. Here  $G_f$  denotes the graph associated with  $f$ . If  $f$  and  $g$  are normal forms of a common morphism,  $\llbracket f \rrbracket = \llbracket g \rrbracket$  is true. So we have  $G_f \sim G_g$  by Cor. 7.5. Namely  $f \sim g$  is concluded. This establishes confluence up to  $\sim$ .

To this end, we give a characterization of  $p$ -echo instances with no reference to the assignment pairs. We consider the following five conditions for a matrix  $M = M_f$  in  $\mathbf{Set}^{A \times B}$  and  $(\alpha; \beta) \in A \times B$ :

- (★1)  $M[\alpha; \beta] \not\equiv 0 \pmod{p}$ .
- (★2) Every positive multisets occurring in  $(\alpha; \beta)$  is homogeneous and has  $p^{p^k}$  elements for some  $k \geq 0$ .
- (★3) If two positive multisets  $\gamma, \gamma'$  occurring in  $(\alpha; \beta)$  has the same  $p^{p^k}$  elements, then  $\gamma = \gamma'$ .
- (★4) If a multiset occurs positively in  $(\alpha; \beta)$ , then it occurs positively exactly  $p^l$  times for some  $l \geq 0$ .
- (★5) Each signed atom has exactly  $p^l$  occurrences in  $(\alpha; \beta)$  for some  $l \geq 0$ .

The first condition is involved in the matrix. The rest address only the elements  $(\alpha; \beta)$ . We show that, for sufficiently large  $p$ , all  $p$ -echo instances satisfy the five conditions, and vice versa.

Whenever we mention a graph  $G$  and a matrix  $M$  in the following, we implicitly assume that they come from a morphism  $f$  in normal form as  $G = G_f$  and  $M = M_f$ .

**7.6. LEMMA.** *A  $p$ -echo instance  $(\alpha; \beta)$  of  $\varphi(G)$  satisfies (★2) through (★5).*

Comment: we postpone (★1) since it requires a sensitive argument and  $p$  must be taken large.

**PROOF.** Each positive multiset is the one created by the positive gate of a board. Thus it must be homogeneous and contains  $p^{p^k}$  elements. This is the condition (★2). By the discernibility condition, (★3) holds. Moreover, if a board (a bioriented wire) occurs

in boards  $i_{u_1}, i_{u_2}, \dots, i_{u_t}$ , then the number of occurrences of the corresponding positive multisets (signed atoms) is of the form  $p^{p^{k_{u_1}} + p^{k_{u_2}} + \dots + p^{k_{u_t}}}$ . Hence  $(\star 4)$  and  $(\star 5)$  hold. ■

Fermat's little theorem asserts that  $a^p \equiv a \pmod p$  for prime  $p$ . The theorem is extended to the following.

7.7. LEMMA. *Let  $p$  be a prime number and  $l$  a positive integer.*

- (i)  $a^{p^l} \equiv a \pmod p$  holds.
- (ii) Whenever  $j \neq 0, p^l$ ,  $\binom{p^l}{j} \equiv 0 \pmod p$  holds.

(i) is obtained by iterating Fermat's little theorem  $l$  times. Contrary to its name, Fermat's little theorem was first verified by Euler [12, p. 63]. He proved (ii) first (for  $l = 1$ ), from which he derived the theorem. Conversely, we can derive (ii) from Fermat's little theorem as follows. We have  $1 + x^p \equiv 1 + x \equiv (1 + x)^p \pmod p$  by the theorem. Thus  $(1 + x)^p - (1 + x^p)$  is constant 0 as a function of  $\mathbb{Z}/p\mathbb{Z}$ . Since the polynomial of degree  $p - 1$  has  $p$  roots, we have  $(1 + x)^p = 1 + x^p$  as polynomials over  $\mathbb{Z}/p\mathbb{Z}$ . Iterating twice, we have  $(1 + x)^{p^2} = (1 + x^p)^p = 1 + x^{p^2}$ . In this way, we obtain  $(1 + x)^{p^l} = 1 + x^{p^l}$  by iteration. Namely, all coefficients  $\binom{p^l}{j}$  vanish to modulus  $p$  except in the constant and the leading term. The statements (i) and (ii) of the lemma are essentially equivalent.

The next lemma is a key in all of the following arguments.

7.8. LEMMA. *Let  $G$  be a board. We consider  $\pi(G)_\beta^{\alpha_1, \alpha_2, \dots, \alpha_m}$ , where  $\beta = \{b, b, \dots, b\}$  is a homogeneous multiset having  $p^l$  copies of  $b$  for some  $l \geq 1$ .*

- (i)  $\pi(G)_\beta^{\alpha_1, \alpha_2, \dots, \alpha_m} \equiv 0 \pmod p$  holds unless all  $\alpha_i$  are homogeneous multisets having  $p^l$  elements.
- (ii)  $\pi(G)_\beta^{\alpha_1, \alpha_2, \dots, \alpha_m} \equiv \pi(G')_b^{a_1, a_2, \dots, a_m} \pmod p$  holds if all  $\alpha_i$  are homogeneous multisets  $\{a_i, a_i, \dots, a_i\}$  having  $p^l$  elements. Here  $G'$  denotes the graph inside the board.

PROOF. We put  $n = p^l$ . By definition,  $\pi(G)_\beta^{\alpha_1, \alpha_2, \dots, \alpha_m}$  equals 0 unless all  $\alpha_i$  have  $n$  elements. If all have  $n$  elements, we have

$$\pi(G)_\beta^{\alpha_1, \alpha_2, \dots, \alpha_m} = \sum \pi(G')_b^{a'_{11} a'_{21} \dots a'_{m1}} \pi(G')_b^{a'_{12} a'_{22} \dots a'_{m2}} \dots \pi(G')_b^{a'_{1n} a'_{2n} \dots a'_{mn}}.$$

since  $\beta = \{b, b, \dots, b\}$ . The summation ranges over different  $m \times n$  matrices

$$\begin{array}{cccc} a'_{11} & a'_{12} & \cdots & a'_{1n} \\ a'_{21} & a'_{22} & \cdots & a'_{2n} \\ \vdots & \vdots & & \vdots \\ a'_{m1} & a'_{m2} & \cdots & a'_{mn} \end{array}$$

where the  $i$ -th row is a linear disposition of  $\alpha_i$ . If all  $\alpha_i$  are homogeneous, there is only

one matrix

$$\begin{array}{cccc} a_1 & a_1 & \cdots & a_1 \\ a_2 & a_2 & \cdots & a_2 \\ \vdots & \vdots & & \vdots \\ a_m & a_m & \cdots & a_m \end{array}$$

thus  $\pi(G)_\beta^{\alpha_1\alpha_2\cdots\alpha_m} = (\pi(G')_b^{a_1a_2\cdots a_m})^n$ . Since  $n = p^l$ , Lem. 7.7,(i) implies  $\pi(G)_\beta^{\alpha_1\alpha_2\cdots\alpha_m} \equiv \pi(G')_b^{a_1a_2\cdots a_m} \pmod{p}$ . This proves (ii). If any  $\alpha_i$  is not homogeneous, the matrix has different column vectors. We note that a shuffle of column vectors do not change the value  $\pi(G')_b^{a'_{11}a'_{21}\cdots a'_{m1}} \pi(G')_b^{a'_{12}a'_{22}\cdots a'_{m2}} \cdots \pi(G')_b^{a'_{1n}a'_{2n}\cdots a'_{mn}}$ . The number of different matrices obtained by shuffles is given by a multinomial coefficient  $\binom{n}{k_1, k_2, \dots, k_q}$  where  $q \geq 2$  is the number of different column vectors,  $k_j \geq 1$ , and  $k_1 + k_2 + \cdots + k_q = n$ . The multinomial coefficient is factored by  $\binom{n}{k_1}$ , thus it vanishes to modulus  $p$  by Lem. 7.7, (ii). Therefore  $\pi(G)_\beta^{\alpha_1\alpha_2\cdots\alpha_m} \equiv 0 \pmod{p}$ . This ends the proof of (i).  $\blacksquare$

Under the hypothesis that all positive multisets are homogeneous, Lem. 7.8 signifies that, as long as we count  $\pi(G)$  to modulus  $p$ , we can ignore non-homogeneous instances on a board  $G$ . Moreover, if they are all homogeneous, it suffices to consider the single subprocess  $\pi(G')_b^{a_1a_2\cdots a_m}$ .

**7.9. LEMMA.** *If  $M$  and  $(\alpha; \beta)$  satisfy  $(\star 1)$  and  $(\star 2)$ , then  $(\alpha; \beta)$  is the instance of  $\varphi(G)$  yielded by an assignment pair subject to the uniformity condition.*

Comment: The lemma asserts that there is an assignment pair satisfying the uniformity condition. It does not negate the existence of the assignment pairs that breach the condition but yield the same  $(\alpha; \beta)$ .

PROOF. Since  $M[\alpha; \beta] \neq 0$ , the process  $\pi(G)_\beta^\alpha$  succeeds. Namely, there is at least one non-deterministic branch that succeeds. We show that a successful branch keeps the condition  $\pi(G')_{\beta'}^{\alpha'} \not\equiv 0 \pmod{p}$ , and that we can extract an assignment pair satisfying the uniformity condition from the branch.

For the tensor introduction  $\pi(G)_{(\alpha, \beta)} = \pi(G_1)_\alpha \cdot \pi(G_2)_\beta$ , if the left-hand side is not congruent to 0 to modulus  $p$ , then neither of  $\pi(G_1)_\alpha$  or  $\pi(G_2)_\beta$  is congruent to 0. The case of cotensor elimination is similar. For the duplicator case  $\pi(G)^\gamma = \sum \pi(G')^{\gamma_1, \gamma_2}$ , there is decomposition  $\gamma = \gamma_1 + \gamma_2$  such that  $\pi(G')^{\gamma_1, \gamma_2}$  is not congruent to 0. The case of a  $\delta$ -part is similar. Finally, we consider the case of a board. By the condition  $(\star 2)$ , the positive gate is annotated by a homogeneous multiset of  $p^{p^k}$  elements. As we count the numbers to modulus  $p$ , we can assume that the negative gates are also associated with homogeneous multisets of  $p^{p^k}$  elements by Lem. 7.8. Moreover,  $\pi(G)_\beta^{\alpha_1\alpha_2\cdots\alpha_m} = \pi(G')_b^{a_1a_2\cdots a_m} \pmod{p}$  implies that the right-hand side is not congruent to 0 to modulus  $p$ .

We show that there is an assignment  $\eta(x_{i_1 i_2 \cdots i_n}, s)$  that does not depend on  $s = (r_1, r_2, \dots, r_n)$ . We walk along a flow, departing from the bioriented wire marked by  $x_{i_1 i_2 \cdots i_n}$ . We choose either of the two directions. Eventually, we reach one of the positive and negative gates of the board  $i_1$ . Since the instance associated with the gate is a homogeneous multiset, we have an assignment that does not depend on  $r_n$  (the suffixes are



reversed, since  $i_1, i_2, \dots$  are from the innermost while  $r_1, r_2, \dots$  are from the outermost). If we proceed further, we reach a gate of the board  $i_2$ . Since it is associated with a homogeneous multiset, we have an assignment that does not depend on  $r_{n-1}$ . Repeating this, we conclude that the value is irrelevant of  $s$ . The uniformity for  $m_i$  is similarly verified. In this case, we start from the positive gate of the board  $i$  and proceed. ■

7.10. LEMMA. *Suppose that  $\text{size}(G) < p$  holds. If an assignment pair subject to the uniformity condition yields the instance  $(\alpha; \beta)$  that fulfills  $(\star 3)$ ,  $(\star 4)$ , and  $(\star 5)$ , then the assignment pair satisfies the discernibility condition.*

PROOF. By the uniformity condition,  $m_i = m_i(s)$  does not depend on  $s$ . Let  $\delta_i$  denote the multiset associated with the positive gate of the board  $i$ . Assume that  $m_i$  is equal to another  $m_j$ . Then  $\delta_i$  equals  $\delta_j$  by the condition  $(\star 3)$ . The number of positive occurrences of each  $\delta_j$  is of the shape  $p^l = p^{p^{k_1} + p^{k_2} + \dots + p^{k_t}}$  in the instance subject to the uniformity condition, as mentioned in the proof of Lem. 7.6. Hence,  $\delta_i$  occurs  $p^{l_1} + p^{l_2} + \dots + p^{l_n}$  times positively for some  $n \geq 2$ . This violates the condition  $(\star 4)$ , since  $n \leq \text{size}(G) < p$  holds as  $n$  is bounded by the number of boards. Namely, all  $m_i$  are distinct. Likewise, we have different assignments to different variables. We use that the number of bioriented wires is not greater than  $\text{size}(G)$ . ■

By two lemmata above, one direction of the implication is completed. Namely, we have the following proposition.

7.11. PROPOSITION. *Suppose that  $\text{size}(G) < p$  holds. If  $M$  and  $(\alpha; \beta)$  satisfy  $(\star 1)$  through  $(\star 5)$ , then  $(\alpha; \beta)$  is a  $p$ -echo instance of  $\varphi(G)$ .*

What remains is to prove that  $p$ -echo instances satisfy the condition  $(\star 1)$ . We must take  $p$  large. The size of  $G$  is not sufficient.

We introduce the notion of *duplication scale*  $d(G)$ . The definition follows the reverse of sequentialization. We consult the reader to the construction of the process  $\pi(G)$  in §5, and reuse the symbols therein. If the graph is decomposed into two graphs  $G_1$  and  $G_2$  as in the case of tensor introduction, we set  $d(G) = d(G_1)d(G_2)$ . For duplicators, we use the multi-duplicators integrating successive duplicators as much as possible. If  $G$  equals

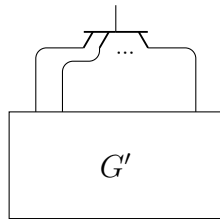

we set  $d(G) = n! \cdot d(G')$ . Here  $n$  is the number of legs of the multi-duplicator. For all other parts, we set  $d(G) = d(G')$ . In particular, if  $G$  is a board containing a subgraph  $G'$ , we have  $d(G) = d(G')$ . If we reach a bioriented wire, we set  $d(G) = 1$ .

7.12. LEMMA. *Suppose  $\max\{\text{size}(G), d(G)\} < p$  holds. If  $(\alpha; \beta)$  is a  $p$ -echo instance of  $\varphi(G)$ , then  $M[\alpha; \beta]$  is congruent to one of  $1, 2, \dots, d(G)$  to modulus  $p$ .*

PROOF. We explore all non-deterministic branches of the process  $\pi(G)_{\beta}^{\alpha}$  to modulus  $p$ . We can ignore branches that vanish to modulus  $p$ . Viewing Lem. 7.8, thus, we can assume that the instance at a gate of a board is a homogeneous multiset of  $p^{p^k}$  elements. Accordingly, the instance above a  $\delta$ -part is a homogeneous multiset of  $p^l$  elements. We verify that  $p$  is so large that no carry-over happens when counting in base  $p$ . Non-deterministic branches may occur at  $d$ -parts,  $\delta$ -parts and boards. By Lem. 7.8, the value of  $\pi(G)$  at a board is congruent to  $\pi(G')$ , where  $G'$  is the inside of the board, to modulus  $p$ . At a  $\delta$ -part, the decomposition is uniquely determined by divisibility relation, as shown in Lem.7.4. Only  $d$ -parts have non-deterministic choices. The multiset  $\gamma$  associated with the upper side of a multi-duplicator is decomposed into a sum  $\gamma = \gamma_1 + \gamma_2 + \dots + \gamma_n$  of homogeneous multisets where  $n$  is the number of legs. Each  $\gamma_i$  has  $p^{l_i}$  elements. Since  $n < p$ , the collection of  $\gamma_1, \gamma_2, \dots, \gamma_n$  is unique up to permutation, as discussed in the proof of Lem. 7.4. For generic forms, the permutation does not matter, since  $\varphi + \psi = \psi + \varphi$ . For the process  $\pi(G)$ , however,  $\alpha + \beta$  and  $\beta + \alpha$  are separately counted unless  $\alpha = \beta$ . Hence the shuffles of  $\gamma_1, \gamma_2, \dots, \gamma_n$  matter. Not all of the shuffles lead to the successful processes in general. In the worst case, however, all of  $n!$  shuffles may succeed. Recall  $d(G) = n! \cdot d(G')$ . Hence, provided that each subprocess  $\pi(G')$  returns a value up to  $d(G')$  to modulus  $p$ , the value of  $\pi(G)$  is up to  $d(G)$ . Finally, the value of  $\pi(G)$  is not congruent to 0, since the  $p$ -echo assignment pair leads to a successful branch. ■

The following gives an example where  $M[\alpha; \beta] \neq 1$ .

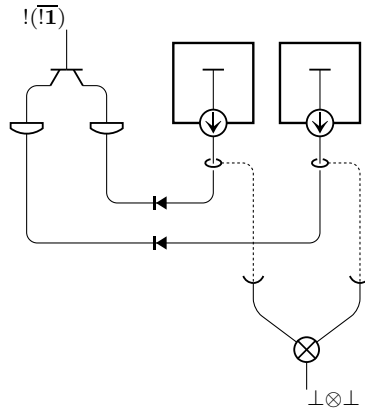

Let  $\alpha$  be  $\{p^{p^k}\{*\}, p^{p^l}\{*\}\}$  with  $k \neq l$  and let  $\beta$  be  $(*, *)$ .  $\alpha$  is a two-point multiset. At the  $d$ -part, both  $\{p^{p^k}\{*\}\} + \{p^{p^l}\{*\}\}$  and  $\{p^{p^l}\{*\}\} + \{p^{p^k}\{*\}\}$  succeed. Therefore  $M[\alpha; \beta]$  equal  $2! = 2$ . This example generalize to  $n!$  and tells why we need the duplication rate  $d(G)$ .

Now we have the other direction of implications, provided that  $p$  is sufficiently large:

7.13. PROPOSITION. *Suppose that  $\max\{\text{size}(G), d(G)\} < p$  holds. If  $(\alpha; \beta)$  is a  $p$ -echo instance of  $\varphi(G)$ , then all of the conditions  $(\star 1)$  through  $(\star 5)$  hold.*

PROOF.  $(\star 1)$  is a consequence of Lem. 7.12. All others come from Lem. 7.6. ■

7.14. THEOREM. *If  $f$  and  $f'$  are normal forms satisfying  $\llbracket f \rrbracket = \llbracket f' \rrbracket$ , then  $f \sim f'$  holds.*

PROOF. Let  $G$  and  $G'$  denote the graphs obtained from  $f$  and  $f'$ . We take a prime number so that  $\max\{\text{size}(G), \text{size}(G'), d(G)\} < p$  holds. We take a  $p$ -echo instance  $(\alpha; \beta)$  of  $\varphi(G)$ . It satisfies five conditions by Prop. 7.13. Since  $\llbracket f \rrbracket = \llbracket f' \rrbracket$  holds, the associated matrices  $M$  are the same. The five conditions are unaltered. Hence  $(\alpha; \beta)$  is a  $p$ -echo instance of  $\varphi(G')$  by Prop. 7.11. Therefore  $G \sim G'$  by Cor. 7.5. ■

So we have the confluence of our system up to the equivalence:

7.15. COROLLARY. *The normal form of a morphism is determined uniquely up to  $\sim$ .*

Let us write  $f = g$  if these morphisms are equal in the free linear category in the ordinary sense, that is, when all defining diagrams are understood to be commutative as usual, rather than rewriting.

7.16. COROLLARY. *If  $f = g$  in the free classical linear category, their normal forms are almost equal.*

In a previous paper, we have verified a termination property [14]. Although it is weak termination, we have a certain strategy leading to normal forms definitely. Together with the result in this paper, we can derive a procedure to determine whether given two morphisms in the free linear category are equal up to the equivalence  $\sim$ . Namely, we first transfer them to normal forms, and just check the equivalence. In [3], the existence of a procedure to determine the equality between morphisms is regarded as the generalization of coherence. We have shown that the classical linear category satisfies the generalized coherence up to the equivalence  $\sim$ .

The current result remains partial. We have not succeeded in handling the isomorphisms related to the units appropriately. Seemingly, the structure involved in the units in the  $*$ -autonomous category is more intricate than one naturally imagines. Two units,  $\mathbf{1}$  and  $\perp$ , interact delicately. We leave the problem related to the units to future work. The linear normal functor model  $\mathcal{M}$  is not enough to disentangle the intricacy caused by the existence of two distinct units.

## Acknowledgements

We are grateful to Kazushige Terui to make us notice [6]. The author is supported by JSPS Kakenhi Grant Number JP15500003.

## References

- [1] A. Asperti, Linear logic, comonads and optimal reductions, *Fundamenta Informaticae*, 22(1-2):3–22, 1995.
- [2] U. Berger and H. Schwichtenberg, An inverse of the evaluation functional for typed lambda calculus, *Proceedings of the Sixth Annual Symposium on Logic in Computer Science, LICS '91*, Amsterdam, The Netherlands, July, 1991, pages 203–211, IEEE, 1991.
- [3] R. F. Blute, J. R. B. Cockett, R. A. G. Seely, and T. H. Trimble, Natural deduction and coherence for weakly distributive categories, *Journal of Pure and Applied Algebra*, 113(3):229–296, 1996.
- [4] D. de Carvalho, Execution time of  $\lambda$ -terms via denotational semantics and intersection types, *Mathematical Structures in Computer Science*, 28(7):1169–1203, 2006.
- [5] D. de Carvalho, Taylor expansion in linear logic is invertible, *Logical Methods in Computer Science*, 14(4:21):1-73, 2018.
- [6] D. de Carvalho and L. Tortora de Falco, The relational model is injective for Multiplicative Exponential Linear Logic (without weakenings), preprint, Computing Research Repository - CORR, 2010.
- [7] J. R. B. Cockett and R. A. G. Seely, Weakly distributive categories, *Journal of Pure and Applied Algebra*, 114(2):133–173, 1997.
- [8] V. Danos and L. Regnier, The structure of multiplicatives, *Archive for Mathematical Logic* 28:181–203. 1989.
- [9] J.-Y. Girard, The system  $F$  of variable types, fifteen years later, *Theoretical Computer Science*, 45:159–192, 1986.
- [10] J.-Y. Girard, Linear logic, *Theoretical Computer Science*, 50(1):1–101, 1987.
- [11] G. Guerrieri, L. Pellissier and L. Tortora de Falco, Computing connected proof(-structure)s from their Taylor expansion, In D. Kesner, B. Pientka (eds.), *1st International Conference on Formal Structures for Computation and Deduction, FSCD 2016*, Vol. 52, LIPIcs : Leibniz International Proceedings in Informatics, 2016.
- [12] G. H. Hardy and E. M. Wright, *An Introduction to the Theory of Numbers*, Fifth Edition, Oxford Science Publications, 1979.
- [13] R. Hasegawa, Two applications of analytic functors, *Theoretical Computer Science*, 272(1-2):113–175, 2002.
- [14] R. Hasegawa, A categorical reduction system for linear logic, *Theory and Applications of Categories*, 35:1833-1870, 2020.
- [15] W. Heijltjes and R. Houston, No proof nets for MLL with units: Proof equivalence in MLL is PSPACE complete, in *Proceedings of the Joint Meeting of the Twenty-Third EACSL Annual Conference on Computer Science Logic and the Twenty-Ninth Annual ACM/IEEE Symposium on Logic in Computer Science, CSL-LICS '14*, ACM, 2014.
- [16] D. J. D. Hughes, Simple free star-autonomous categories and full coherence, *Journal of Pure and Applied Algebra*, 216(11):2386–2410, 2012.
- [17] B. Jacobs, *Categorical Logic and Type theory*, Elsevier, 2001.
- [18] A. Joyal, Foncteurs analytiques et espèces de structures, *Combinatoire Enumérative*, Proceedings, Montreal, Québec, Canada, 1985, G. Labelle, P. Leroux, eds., Lecture Notes in Mathematics 1234, (Springer, 1986) pp. 126–159.

- [19] A. Joyal and R. Street, Braided tensor categories, *Advances in Mathematics*, 102:20-78, 1993.
- [20] G. M. Kelly, On MacLane's conditions for coherence of natural associativities, commutativities, etc., *Journal of Algebra*, 1(4):397-402, 1964.
- [21] J. Lambek and P. J. Scott, *Introduction to Higher-Order Categorical Logic*, Cambridge University Press, 1988.
- [22] J. Lamping. An algorithm for optimal lambda calculus reductions. *Proceedings of the 17th Symposium on Principles of Programming Languages (POPL 90)*, San Francisco, C.A., U.S.A., 1990, pp.16-30.
- [23] M. E. Maietti, P. Maneggia, V. de Paiva, and E. Ritter, Relating categorical semantics for intuitionistic linear logic, *Applied Categorical Structures*, 13(1):1-36, 2005.
- [24] R. Sedgewick and P. Flajolet, *An Introduction to the Analysis of Algorithms*, Addison-Wesley Publishing Company, 1996.
- [25] M. Sipser, *Introduction to the Theory of Computation*, PWS Publishing Company, 1997.

*Graduate School of Mathematical Sciences, The University of Tokyo, Komaba 3-8-1, Meguro-ku, Tokyo 153-8914, Japan*