

Aspects of functoriality in homological mirror symmetry for toric varieties

Andrew Hanlon and Jeff Hicks

Abstract

We study homological mirror symmetry for toric varieties, exploring the relationship between various Fukaya-Seidel categories which have been employed for constructing the mirror to a toric variety. In particular, we realize tropical Lagrangian sections as objects of a partially wrapped category and construct a Lagrangian correspondence mirror to the inclusion of a toric divisor. As a corollary, we prove that tropical sections generate the Fukaya-Seidel category, completing a Floer-theoretic proof of homological mirror symmetry for projective toric varieties. In the course of the proof, we develop techniques for constructing Lagrangian cobordisms and Lagrangian correspondences in Liouville domains, which may be of independent interest.

1 Introduction

Mirror symmetry, first observed in the work of [Can+91], is now a broad-reaching set of proposed equivalences between symplectic geometry on a Calabi-Yau manifold X and complex geometry on a mirror space \check{X} . In this article, we'll explore the interplay between three aspects of this theory. The work of [SYZ96] predicts that mirror spaces X and \check{X} can be constructed as dual Lagrangian torus fibrations (SYZ-fibrations) over a common affine base Q . The homological mirror symmetry (HMS) conjecture from [Kon95] proposes that the Fukaya category of X is derived equivalent to the category of coherent sheaves on \check{X} . Finally, [HV00] states that when we replace a space \check{X} with a compactification, we should modify the geometric model considered on the mirror space X via incorporation of a “superpotential” $W : X \rightarrow \mathbb{C}$ whose behavior at the boundary of X encodes the compactifying divisors added to \check{X} .

Toric varieties have become a central object of study in mirror symmetry as they provide a set of examples to test all three of these features. The presence of a moment map gives them a Lagrangian torus fibration, and the additional combinatorial structure makes the derived category of coherent sheaves particularly amenable to computation. Additionally, toric varieties naturally present themselves as a compactification of the algebraic torus, which we denote by $X = \check{X} = (\mathbb{C}^*)^n$. Consider the compactification of \check{X} to a toric variety \check{X}_Σ given by fan $\Sigma \subset \mathbb{R}^n$ with $A \subset \mathbb{Z}^n$ indexing the primitive generators of Σ . In [HV00] it was deduced from physical considerations that the compactification is mirror to the incorporation of the Hori-Vafa superpotential (a Laurent polynomial) on X ,

$$W_\Sigma = \sum_{\alpha \in A} c_\alpha z^\alpha$$

where $z^\alpha = z_1^{\alpha_1} \dots z_n^{\alpha_n}$ and $c_\alpha \in \mathbb{C}^*$ are coefficients encoding the Kähler structure of X . The superpotential W_Σ is a holomorphic function on $X = (\mathbb{C}^*)^n$, and the pair (X, W_Σ) is a Landau-Ginzburg model mirror to \check{X}_Σ . Since (X, W_Σ) has the same underlying symplectic manifold as X , to understand the HMS conjecture for toric varieties we need to state how the superpotential modifies the geometry as computed by the Fukaya category. Additionally, it would be satisfying to understand this superpotential from an SYZ perspective.

There are now a variety of perspectives on the equivalence between the category of coherent sheaves on \check{X}_Σ and a Fukaya category associated to the pair $((\mathbb{C}^*)^n, W_\Sigma)$. In particular, there are several different flavors of the Fukaya category associated to the pair $((\mathbb{C}^*)^n, W_\Sigma)$, each useful for studying a different aspect of the mirror relation between \check{X}_Σ and $((\mathbb{C}^*)^n, W_\Sigma)$. We now briefly summarize some of these approaches from the existing literature.

Following ideas of Kontsevich, [Sei01] defined the Fukaya-Seidel category, $\mathcal{FS}(Y, W)$, of a holomorphic function W on an exact Kähler manifold Y . Objects of $\mathcal{FS}(Y, W)$ are supported on Lagrangian submanifolds which, outside of a compact subset, project to the real positive axis of \mathbb{C} under W . Using this framework, Seidel deduced HMS for $\check{X}_\Sigma = \mathbb{P}^2$; this argument was later generalized by [AKO06] to del Pezzo surfaces (including the non-toric ones) and weighted projective planes.

Further input on the construction of these mirror pairs came from the SYZ conjecture. By deforming the superpotential W_Σ to its “tropical localization,” [Abo09] produced a subcategory of “tropical Lagrangian sections” of $\mathcal{FS}(Y, W)$ equivalent to line bundles on \check{X}_Σ for any smooth and projective toric variety. The first author in [Han19] developed a variant of Seidel’s construction called the monomially admissible Fukaya-Seidel category and proved an analog of Abouzaid’s result. Short of a generation gap, this approach provides an entirely geometric (i.e., sheaf-free) proof of homological mirror symmetry for toric varieties. Using tropical Lagrangian sections has the advantage of following an “SYZ-first” viewpoint on HMS, where relations between affine geometry of toric varieties, tropical geometry, and symplectic geometry of $(\mathbb{C}^*)^n$ inform the HMS identification.

A separate approach to HMS for toric varieties comes from [Fan+11], which associated to the data of the fan Σ a Lagrangian skeleton for X ,

$$\mathbb{L}_\Sigma = \bigcup_{\sigma \in \Sigma} \sigma^\perp \times \sigma \subset T^*T^n = (\mathbb{C}^*)^n,$$

and proposed that the category of constructible sheaves on T^n with microsupport in \mathbb{L}_Σ is a suitable stand-in for the Fukaya category of $((\mathbb{C}^*)^n, W_\Sigma)$. In this setting, they were able to prove an equivariant version of HMS for projective toric varieties. This result was extended to the non-equivariant setting and to arbitrary toric varieties by [Kuw20].

Recent developments in Fukaya categories in the non-compact setting open the prospect of unifying these different categories associated with the pair (X, W_Σ) . [Syl19a] introduced the partially wrapped Fukaya category, a general construction of a category associated to the data of a Landau-Ginzburg pair. This category has been additionally studied by [GPS19]. In the greatest generality, the partially wrapped Fukaya category, $\mathcal{W}(Y, \mathfrak{f})$, is defined for a symplectic manifold Y which is conical at infinity and a closed subset \mathfrak{f} in the contact boundary of Y . Objects are supported on Lagrangians that are conical at infinity and do not intersect \mathfrak{f} .

There are known relations between the partially wrapped Fukaya category, the Fukaya-Seidel category, and sheaves with microlocal support on the FLTZ skeleton. To recover the Fukaya-Seidel category, we look at the partially wrapped Fukaya category $\mathcal{W}((\mathbb{C}^*)^n, W_\Sigma^{-1}(-\infty))$. To relate the partially wrapped Fukaya category to the FLTZ skeleton, we can also consider $\mathcal{W}((\mathbb{C}^*)^n, \mathfrak{f}_\Sigma)$ where \mathfrak{f}_Σ is the intersection of \mathbb{L}_Σ with the boundary at infinity. A general result of [GPS19], along with a result particular to the toric setting due to [GS17; Zho20] implies that they are equivalent when \check{X}_Σ is Fano. Inspired by the work of [NZ09], [GPS18a] shows that $\mathcal{W}((\mathbb{C}^*)^n, \mathfrak{f}_\Sigma)$ is equivalent to the sheaf theoretic category considered by [Fan+11], giving a very general proof of HMS when combined with the aforementioned work of Kuwagaki. [KK17] have also defined a variant of $\mathcal{W}((\mathbb{C}^*)^n, \mathfrak{f}_\Sigma)$ to

A-side	B-side
Monodromy of FLTZ skeleton	Tensor product with line bundles
Lagrangian correspondences	Toric morphisms and inclusions
Stop removal	Blow-down and localization

Table 1. Aspects of functoriality in toric HMS.

give a proof of HMS for quasi-affine toric varieties. An overview of the current state of the field is included in [Han19, Section 1.3].

1.1 Statement of results

The results of this paper are best summarized working backwards from applications, where we investigate mirror symmetry for the functors described in Table 1. In order to understand these functors through homological mirror symmetry, we are required to reexamine homological mirror symmetry for toric varieties with the newly developed machinery of partially wrapped Fukaya categories.

Our first result encodes previous HMS results for toric varieties in this new language.

Theorem A (Restatement of Theorem 3.5). Let Δ be a monomial division adapted to Σ and let \mathcal{F}_Δ^s be the monomially admissible Fukaya-Seidel category of sections associated to Δ . There is a fully faithful embedding

$$\mathcal{F}_\Delta^s \hookrightarrow \mathcal{W}((\mathbb{C}^*)^n, \mathfrak{f}_\Sigma).$$

As a consequence, the subcategory of $\mathcal{W}((\mathbb{C}^*)^n, \mathfrak{f}_\Sigma)$ generated by tropical Lagrangian sections is derived equivalent to the subcategory of line bundles on the mirror toric variety. We then show that these tropical Lagrangian sections generate $\mathcal{W}((\mathbb{C}^*)^n, \mathfrak{f}_\Sigma)$. The proof of generation relies on constructing the mirror to the inclusion of a toric divisor.

Theorem B (Restatement of Theorem 5.1). Let $\text{star}(\alpha)/\alpha$ be the fan of a toric divisor of \check{X}_Σ . There is a Lagrangian correspondence $L_{\alpha 0} : ((\mathbb{C}^*)^{n-1}, \mathfrak{f}_{\text{star}(\alpha)/\alpha}) \Rightarrow ((\mathbb{C}^*)^n, \mathfrak{f}_\Sigma)$ which is mirror to the inclusion of a toric divisor $i_{\alpha 0} : \check{X}_{\text{star}(\alpha)/\alpha} \hookrightarrow \check{X}_\Sigma$ on the level of the Grothendieck groups $K_0(\mathcal{W}((\mathbb{C}^*)^n, \mathfrak{f}_\Sigma))$ and $K_0(D^b \text{Coh}(\check{X}_\Sigma))$.

Provided that the expected functoriality of Lagrangian correspondences extends to the partially wrapped setting, Theorem 5.1 gives a functor between Fukaya categories mirror to the derived push-forward of the inclusion; see Remark 5.2. This Lagrangian correspondence allows us to inductively construct the linking disks to the FLTZ skeleton via Lagrangian cobordisms and tropical Lagrangian sections, proving generation.

Corollary C (Restatement of Theorem 6.2). The subcategory of tropical Lagrangian sections generates $\mathcal{W}((\mathbb{C}^*)^n, \mathfrak{f}_\Sigma)$.

The generation result is mirror to generation of $D^b \text{Coh}(\check{X}_\Sigma)$ by line bundles [Abo09, Proposition 1.3]. In combination with Theorem A, generation immediately gives a proof of HMS for toric varieties that is completely Floer-theoretic.

Corollary D. Let \check{X}_Σ be a smooth projective toric variety. There is a quasi-equivalence

$$\text{Tw } \mathcal{W}((\mathbb{C}^*)^n, \mathfrak{f}_\Sigma) \simeq D_{\text{dg}}^b \text{Coh}(\check{X}_\Sigma).$$

Under this equivalence, Lagrangian sections $L(F)$ associated to support functions F are identified with line bundles $\mathcal{O}(F)$.

Remark 1.1. The embedding from Theorem A can also be constructed using Abouzaid’s category of tropical Lagrangian sections (see Remark 3.8). Combined with Corollary C and the equivalence $\mathcal{W}((\mathbb{C}^*)^n, W_\Sigma^{-1}(-\infty)) \simeq \mathcal{W}((\mathbb{C}^*)^n, \mathfrak{f}_\Sigma)$ mentioned above, this implies that Abouzaid’s tropical sections generate the Fukaya-Seidel category¹ when \check{X}_Σ is Fano.

Remark 1.2. An obvious question is how the equivalence of Corollary D relates to the one obtained in [GPS18a, Corollary 6.16] by passing to the category of microlocal sheaves. It is reasonable to expect that they coincide. In order to verify this, one needs to check only that the images of the tropical Lagrangian sections corresponding to ample line bundles in the category of microlocal sheaves is the costandard constructible sheaf on the moment polytope of this line bundle [Fan+11]. In general, tropical Lagrangian sections should then correspond to twisted polytope sheaves [Zho19].

Remark 1.3. Although the FLTZ skeleton has been defined and studied for toric stacks [Fan+14], we work only with toric varieties in this paper. This is done largely for clarity and to simplify the exposition. We expect that all of our results can be extended to toric Deligne-Mumford stacks in the sense of [BCS05].

Corollary D provides a version of homological mirror symmetry that can leverage the additional structure and flexibility of the partially wrapped Fukaya category. We use these structures to obtain the desired mirror relationships listed in Table 1. As specific applications, we show for projective toric varieties:

Restatement of Theorem 3.13: The monodromy action on the monomially admissible Fukaya category considered in [Han19] extends to the partially wrapped Fukaya category. These autoequivalences of $\mathcal{W}((\mathbb{C}^*)^n, \mathfrak{f}_\Sigma)$ are mirror to tensor-product with line bundles on $D^b \text{Coh}(\check{X}_\Sigma)$.

Restatement of Proposition 5.21: Under the mirror identification, linking disks L_σ are mirror to line bundles supported on the toric orbit indexed by σ .

Restatement of Proposition 6.8 and Corollary 6.17: The stop removal functors associated to the appropriate components of the FLTZ skeleton on $\mathcal{W}((\mathbb{C}^*)^n, \mathfrak{f}_\Sigma)$ are mirror to toric blow-down, and localization away from toric strata.

Restatement of Corollary 6.9: We can extend Corollary D to the more general setting of quasi-projective smooth toric varieties.

The construction of the mirror correspondence to inclusion and the inductive argument for generation use new methods for building Lagrangian surgeries, cobordisms, and correspondences in Liouville domains. We lay some groundwork for working with Lagrangian cobordisms and correspondences in Liouville domains in the appendices. These tools are kept separate from the main results and may be of interest to those constructing Lagrangian submanifolds inside Liouville domains.

¹At least, the partially wrapped version of the Fukaya-Seidel category, which differs from that considered in [Abo09] in its technical setup, but is expected to be quasi-equivalent.

1.2 Outline

The paper is roughly organized as follows: background and notation in Section 2; embedding of tropical sections into the partially wrapped Fukaya category in Section 3; the construction of the inclusion correspondence and subsequent generation of the partially wrapped Fukaya category in Sections 4, 5 and 6.1; and applications and extension in Section 6. Finally, Appendices A to D cover constructions of Lagrangian correspondences and cobordisms in Liouville domains.

A review of notation and existing literature is included in Section 2. We set notation for the partially wrapped Fukaya category in Section 2.1, mostly following [GPS18b]. Sections 2.2 to 2.5 overview mirror symmetry for toric varieties. Our emphasis on SYZ mirror symmetry will color our notation used for toric varieties. Section 2.3 fixes our choices for notation, which views line bundles and toric divisors as arising from the data of a support function on the SYZ base. This description becomes useful in Section 2.4, which recaps the construction of the monomially admissible Fukaya-Seidel category from [Han19], and the FLTZ skeleton from [Fan+11]. The objects in the monomially admissible Fukaya-Seidel category that are of primary interest to us are tropical Lagrangian sections, which are similarly described in Section 2.5.

In Section 3, we produce conical tropical Lagrangian sections from support functions by modifying the construction of tropical Lagrangian sections in the monomially admissible setting. Then, we show that this modification does not change their Floer theory, which results in Theorem A. We also see that the conical twisting Hamiltonians used in defining the conical tropical Lagrangian sections act on $\mathcal{W}((\mathbb{C}^*)^n, \mathfrak{f}_\Sigma)$ and that this action is mirror to tensoring by the corresponding line bundle on the mirror as in the monomially admissible setting. In Section 3.3, we prove that the cocores of the FLTZ skeleton are all tropical Lagrangian sections.

In Sections 4 and 5, we construct various Lagrangian submanifolds for $\mathcal{W}((\mathbb{C}^*)^n, \mathfrak{f}_\Sigma)$ which realize mirror symmetry predictions. Section 4 constructs a Lagrangian submanifold $L_{\alpha>0} \subset ((\mathbb{C}^*)^n, \mathfrak{f}_\Sigma)$ which is mirror to the structure sheaf of a toric divisor $\mathcal{O}_{\alpha>0} \in D^b \text{Coh}(\check{X}_\Sigma)$. The construction is based on the surgery methods used to build tropical Lagrangian submanifolds from the second author's thesis [Hic20]. These Lagrangians provide an example of an advantage of working in the partially wrapped Fukaya category, as they cannot be constructed in the monomially admissible Fukaya category. In Section 4.2, an explicit example is given for homological mirror symmetry for $\mathbb{C}\mathbb{P}^1$ for the purpose of exposition.

These methods are extended in Section 5, which looks at constructions of Lagrangian correspondences. We explore two kinds of Lagrangian correspondences: correspondences mirror to toric morphisms and correspondences mirror to the inclusion of a toric divisor. In Section 5.2, we construct the Lagrangian correspondence mirror to a toric morphism. We additionally prove that this correspondence intertwines the twisting Hamiltonians of the domain and codomain and that it sends Lagrangian sections to Lagrangian sections. Section 5.3 uses this construction and the surgery method from Section 4 to build a Lagrangian correspondence $L_{\alpha 0} : ((\mathbb{C}^*)^{n-1}, \mathfrak{f}_{\text{star}(\alpha)/\alpha}) \Rightarrow ((\mathbb{C}^*)^n, \mathfrak{f}_\Sigma)$, the mirror to inclusion of a toric divisor. The main result of this section, Theorem 5.1, is the construction and description of $L_{\alpha 0}$. We prove that $L_{\alpha 0}$ intertwines the twisting Hamiltonians, sends linking disks to linking disks, pulls Lagrangian sections back to Lagrangian sections, and can be constructed by a Lagrangian cobordism.

We explore some immediate applications in Section 6. In Section 6.1, we use the inclusion correspondence to show that tropical Lagrangian sections generate the Fukaya category. We give a sketch of the argument for the mirror to $\mathbb{C}\mathbb{P}^2$ using piecewise linear pictures in Section 6.1.1. These PL Lagrangians are replaced with smooth Lagrangians in Section 6.1.2, which uses the inclusion

correspondence to inductively show that tropical Lagrangian sections generate linking disks of the FLTZ skeleton. This completes the proof of Corollary C. Using the same techniques, we show that the mirror to the Beilinson exceptional collection for $\mathbb{C}P^n$ in generates in Section 6.1.3. We then leverage Corollary C to examine the stop removal functor under homological mirror symmetry for toric varieties. Section 6.2 shows that homological mirror symmetry holds for quasi-projective smooth toric varieties. This is achieved by checking that localization at a stop is mirror to working in the complement of the corresponding toric stratum. In Section 6.3, we show that the blow-down functor associated to toric blowup at a smooth orbit can also be realized by stop removal.

Finally, we include several appendices containing constructions for Lagrangian cobordisms and correspondences in Liouville domains. These provide tools that may be of independent interest beyond the homological mirror symmetry results of this paper. Appendix A extends the surgery cobordism construction of [Hic20] to the setting of Liouville domains. Appendix B describes a Lagrangian cobordism between cobordisms of Legendrians; we recover as an application the generation result of [GPS18b]. Appendix C proves an interchange relation of Lagrangian cobordisms and Lagrangian correspondences; this result is known to experts but (to our knowledge) has not yet appeared in the literature. As an application, we observe that the Lagrangian cobordism class under geometric composition of Lagrangian correspondences is independent of perturbations taken to achieve transversality. Finally, Appendix D lays some groundwork for Lagrangian correspondences between Liouville domains, highlighting why “totally wrapped to the stop” is an important condition to ensure admissibility of geometric composition.

1.3 Acknowledgements

We would like to thank Denis Auroux and Sheel Ganatra for useful discussions. We are also grateful to the anonymous referee whose many helpful comments improved this paper.

AH is partially supported by NSF RTG grant DMS-1547145. JH is supported by EPSRC Grant (EP/N03189X/1, Classification, Computation, and Construction: New Methods in Geometry).

2 Background

In this section, we set our notation and review some of the necessary background on toric varieties and the Fukaya categories relevant to homological mirror symmetry for toric varieties. As a general rule:

- Symplectic objects in this paper are written with unadorned characters (so $\phi : X \rightarrow X$ is a symplectomorphism).
- Complex geometric objects in this paper are decorated with checks (so $\check{f} : \check{X}_1 \rightarrow \check{X}_2$ is a map of varieties).
- Piecewise linear / tropical objects are marked with an underline (so $\underline{i} : Q_1 \rightarrow Q_2$ is a linear function). A notable exception is for support functions $F : Q \rightarrow \mathbb{R}$.

2.1 Partially wrapped Fukaya categories

The notation that we use for partially wrapped Fukaya categories follows [GPS18b]. The symplectic objects which are the center of our study are *Liouville domains*. A Liouville domain is a pair (X^{int}, λ) , where

- X^{int} is a $2n$ -manifold with boundary ∂X^{int} and,
- $\lambda \in \Omega^1(X^{int}, \mathbb{R})$ is a one form on $\Omega^1(X^{int}, \mathbb{R})$ so that $\omega = d\lambda$ is a symplectic form for X^{int} .

To this data we can associate a *Liouville vector field* Z defined by the property $\iota_Z \omega = \lambda$. We require that this vector field transversely points outward along ∂X . The boundary of a Liouville domain is a contact manifold $(\partial X^{int}, \lambda)$. Liouville domains admit completions to a non-compact symplectic manifold X by attaching the symplectization $\partial X^{int} \times [0, \infty)_t$ to the contact boundary. The symplectic form that we take on the cylindrical end is $d(e^t \lambda)$; we note that this is an exact symplectic form. Since we will mostly work with the completions of Liouville domains, we² will use X^{int} to refer to any Liouville domain which completes to X .

Outside of the appendix, the only Liouville domain which we will consider is $X = (\mathbb{C}^*)^n$, where X^{int} is the unit cotangent bundle of the product torus $\{(e^{i\theta_1}, \dots, e^{i\theta_n}), \theta_i \in S^1\}$. We summarize some general properties of Liouville domains. The Liouville vector field gives a flow $\phi_Z^t : X \rightarrow X$ which expands the symplectic form. The *core* of a Liouville manifold, which we denote by \mathfrak{c}_X , is the set of points which do not escape under the flow of Z . Given x_0 belonging to an n -dimensional strata of \mathfrak{c}_X , we can look at the cocore,

$$\mathfrak{u}(x_0) := \left\{ x \in X : \lim_{t \rightarrow -\infty} \phi_Z^t(x) = x_0 \right\}.$$

The Liouville vector field provides a taming condition on Lagrangian submanifolds of X . We say that a Lagrangian submanifold $L \subset (X, \lambda)$ is *conical at infinity* if it is parallel to Z outside of some compact set $V \subset X$. We say a Lagrangian submanifold is *admissible* if it is exact and conical at infinity.

Associated to (X, λ) is a *wrapped Fukaya category* $\mathcal{W}(X)$ whose objects are admissible Lagrangians with extra data. We sketch the construction of the morphisms here, and refer the reader to [GPS19, Section 3] for a full definition of the category. $\mathcal{W}(X)$ is constructed as the localization of a directed A_∞ -category. For each admissible Lagrangian $L \subset X$, this directed A_∞ category contains a sequence of Lagrangians L^i . The L^i are obtained by applying successively larger positive wrapping Hamiltonians to the underlying Lagrangian L . Morphisms are then defined between Lagrangians of decreasing wrapping. The wrapped category is obtained by localizing the directed category at the continuation elements, which are canonical morphisms $L \rightarrow L^k$. In summary, to compute (the cohomology of) morphism complexes $\text{Hom}_{\mathcal{W}(X)}(L_1, L_2)$, one must compute the limit of $\text{CF}^\bullet(L_1^i, L_2)$, where L_1^i is a cofinal sequence of Lagrangian submanifolds starting with L_1 , and related by positive Hamiltonian isotopies (see [GPS19, Lemma 3.37]).

There is also a version of the Fukaya category that does not completely wrap the ends of admissible Lagrangian submanifolds. A *stop* for X is a mostly Legendrian ([GPS18b, Definition 1.6]) closed subset $\mathfrak{f} \subset \partial X^{int}$. An admissible Lagrangian submanifold in (X^{int}, \mathfrak{f}) is an admissible Lagrangian submanifold of X^{int} whose boundary is disjoint from \mathfrak{f} .

The *skeleton* of a stopped Liouville manifold is the union of the conicalization of the stop and the core,

$$\mathbb{L}_{\mathfrak{f}} := \{x \in X : \phi_Z^t(x) \in \mathfrak{f} \text{ for some } t \in \mathbb{R}\} \cup \mathfrak{c}. \quad (1)$$

We can recover the stop from the skeleton by taking the intersection of $\mathbb{L}_{\mathfrak{f}}$ with ∂X^{int} . We can equivalently characterize an admissible Lagrangian submanifold of (X, \mathfrak{f}) as an admissible Lagrangian submanifold of X which avoids $\mathbb{L}_{\mathfrak{f}}$ outside of a compact set X^{int} .

²This notation places a preference for the completion of a Liouville domain rather than the Liouville domain itself.

From the data of a stopped Liouville domain, [Syl19a; GPS18b] constructs a *partially wrapped Fukaya category* $\mathcal{W}(X, \mathfrak{f})$. We follow the conventions from [GPS18b] where $\mathcal{W}(X, \mathfrak{f})$ is defined in the generality that we need. The category $\mathcal{W}(X, \mathfrak{f})$ has admissible Lagrangian submanifolds as objects. Again morphisms $\text{Hom}_{\mathcal{W}(X, \mathfrak{f})}(L_1, L_2)$ are computed by taking an appropriate limit of Lagrangian intersection Floer theory over a set of positively Hamiltonian isotopic and admissible Lagrangians L_1^i .

At a point x in the interior of n -dimensional strata of $\mathbb{L}_{\mathfrak{f}}$, we can take a Lagrangian disk D_x^n that intersects the skeleton transversely at x . By applying the Liouville flow to the boundary of D_x^n , we obtain an admissible Lagrangian disk which only intersects \mathbb{L} at x . This disk is called the *linking disk of \mathbb{L} at x* and we will also denote it by $\mathfrak{u}(x)$.³ The admissible Hamiltonian isotopy class of the linking disk is only dependent on the stratum of the skeleton \mathbb{L} which contains x .

Theorem 2.1 (Theorem 1.1 of [GPS18b],[Cha+17]). *$\mathcal{W}(X, \mathfrak{f})$ is generated by the linking disks $\mathfrak{u}(x)$ of the skeleton, $\mathbb{L}_{\mathfrak{f}}$.*

We provide a Lagrangian cobordism argument for this generation result in Appendix B, which is based on the work of [Bos21] extending Biran and Cornea's cobordism iterated exact sequence to the setting of Liouville manifolds.

2.2 SYZ mirror symmetry for toric varieties

For accessibility, we provide a dictionary between notation used in algebraic geometry for toric varieties, and notation from symplectic geometry. We denote by \check{X}_{Σ} the toric variety of dimension n over \mathbb{C} corresponding to a fan $\Sigma \subset N \otimes \mathbb{R}$ where N is an n -dimensional lattice. By definition, \check{X}_{Σ} is a (partial) compactification of the algebraic torus $\check{X}_0 := N \otimes \mathbb{C}^* = (\mathbb{C}^*)^n$. Σ encodes the strata of compactification in terms of convergence of 1-parameter subgroups of the algebraic torus [CLS11, Proposition 3.2.2].⁴ Unless explicitly stated otherwise, we will assume that \check{X}_{Σ} is smooth, that is, every n -dimensional cone of Σ is generated by a basis of N . We will denote primitive generators of Σ by α and set A to be the set of all primitive generators. Additionally, $\langle \alpha_1, \dots, \alpha_k \rangle$ denotes the cone generated by the primitive generators $\alpha_1, \dots, \alpha_k$.

We first describe mirror symmetry for the algebraic torus \check{X}_0 . The algebraic torus \check{X}_0 has a natural fibration over the affine space $Q := N \otimes \mathbb{R} \simeq \mathbb{R}^n$ with fibers that are real n -dimensional tori. From Q , we can also construct a symplectic manifold $X = T^*Q/M$ where M is the dual lattice to N acting fiberwise via the natural splitting $T^*Q \simeq Q \times (M \otimes \mathbb{R})$. The algebraic variety \check{X}_0 and the symplectic manifold X are mirror dual. These dual torus fibrations serve as the foundational example of Strominger-Yau-Zaslow (SYZ) mirror symmetry [SYZ96], and this example is often referred to as semi-flat mirror symmetry (see, for example, [Gro13]).

We now give the symplectic notation which we will use for the remainder of the paper. It is natural to consider Q with the additional structure of an integral affine manifold; this trivializes the tangent and cotangent bundles by identifying \mathbb{Z}^n lattice subbundles $T_{2\pi\mathbb{Z}}Q \subset TQ$ and $T_{2\pi\mathbb{Z}}^*Q \subset T^*Q$. The lattice structure on toric varieties can be recovered from the affine structure on Q , giving

³This is slightly different than the standard notation, which usually reserves the word linking disk to mean a disk which intersects the skeleton at a single point in the symplectization. However, we will use linking disk to mean both these disks, and cocores. We will use cocore to specifically mean a linking disk which intersects the core of X

⁴Here we are making a change in sign from [CLS11] to be more compatible with our later conventions for Lagrangian sections and the FLTZ skeleton.

us the following dictionary:

$$\begin{array}{lll} Q := N \otimes \mathbb{R} & N \simeq (T_{2\pi\mathbb{Z}})_q Q & \check{X}_0 = (\mathbb{C}^*)^n \simeq TQ/T_{2\pi\mathbb{Z}}Q \\ & M \simeq (T_{2\pi\mathbb{Z}}^*)_q Q & X = T^*Q/M \simeq T^*Q/T_{2\pi\mathbb{Z}}^*Q. \end{array}$$

In particular, the torus fibration $\check{X}_0 \rightarrow Q$ becomes the complex SYZ fibration

$$\begin{aligned} \check{\text{Log}} : \check{X}_0 = (\mathbb{C}^*)^n &\rightarrow Q \\ (z_1, \dots, z_n) &\mapsto (\log |z_1|, \dots, \log |z_n|) \end{aligned}$$

induced by the standard holomorphic volume form. The torus fibration on $T^*Q/T_{2\pi\mathbb{Z}}^*Q$ is the symplectic SYZ fibration, i.e., moment map $u : X \rightarrow Q$, of the symplectic form

$$\omega = \sum_{i=1}^n du_i \wedge dp_i$$

where u_i are our chosen coordinates on $Q \simeq \mathbb{R}^n$ and p_i are the dual coordinates on the fibers. In Sections 4 and 5, we will use the coordinates (q_i, p_i) inherited from T^*Q .

We now discuss how equipping \check{X}_0 with a toric Kähler form yields a complex structure on X . Let $h : Q \rightarrow \mathbb{R}$ be a strictly convex function on Q with nondegenerate Hessian. This gives a potential $h \circ \check{\text{Log}}$ on \check{X}_0 , whose associated Kähler form is toric. As first observed by Hitchin [Hit97], the Legendre transform ∇h :

- takes the complex SYZ fibration on \check{X}_0 to the symplectic SYZ fibration coming from the Kähler form and
- takes the symplectic SYZ fibration on X to the complex SYZ fibration coming from a complex structure naturally arising from h .

In other words, we obtain an isomorphism of X with \check{X}_0 where

$$\text{Log} = \nabla h \circ u.$$

From the perspective of tropical geometry, Log should be viewed as the valuation map.

In this particular example, the cotangent bundle and affine structure are trivializable. As a result, there is another map which we will frequently use: the argument projection $\arg : T^*Q/M \rightarrow (M \otimes \mathbb{R})/M$. In coordinates, we have $\arg(u, p) = p$ so that under the identification with $(\mathbb{C}^*)^n$, \arg is the usual argument map, or identifying with T^*T^n , projection to the base. The diagram below summarizes various maps involved in semi-flat mirror symmetry.

$$\begin{array}{ccccc} (\mathbb{C}^*)^n \simeq N \otimes \mathbb{C}^* & \xleftarrow{\text{SYZ mirror}} & T^*Q/M \simeq T^*\mathbb{R}^n/T_{2\pi\mathbb{Z}}^*\mathbb{R}^n & \xrightarrow{\arg} & (M \otimes \mathbb{R})/M \simeq T^n \\ \downarrow \check{\text{Log}} & & \downarrow \wr & & \downarrow \text{Log} \\ & \swarrow u & (\mathbb{C}^*)^n & & \\ Q = N \otimes \mathbb{R} \simeq \mathbb{R}^n & \xrightarrow[\text{Legendre transform}]{\nabla h} & M \otimes \mathbb{R} \simeq \mathbb{R}^n & & \end{array}$$

Remark 2.2. We will often implicitly identify $T^*Q/T_{2\pi\mathbb{Z}}^*Q$ with $(\mathbb{C}^*)^n$ as outlined above for brevity of notation. In some constructions of Fukaya categories mirror to toric varieties, the holomorphic structure plays an important role while in others, namely the partially wrapped category, it does not. We will emphasize this distinction when it is important. See for instance Remarks 2.7 and 3.7.

It remains to understand mirror symmetry for the toric variety \check{X}_Σ from semi-flat mirror symmetry for the pair \check{X}_0, X . This amounts to understanding how compactifying by toric divisors modifies the mirror space. An expectation for symplectic Calabi-Yau manifolds \check{X} is that compactification is mirror to the addition of a “superpotential” function $W : X \rightarrow \mathbb{C}$ on the SYZ mirror. We first work in the setting where \check{X}_Σ is equipped with a Kähler potential. One route to constructing this superpotential function (studied in detail by [Aur07]) comes from identifying the points of X with SYZ fibers of \check{X}_0 . The open Gromov-Witten invariants count the holomorphic disks in the compactification \check{X}_Σ with boundary on SYZ fibers and record the deformation from $\text{Fuk}(\check{X}_0)$ to the weakly unobstructed curved A_∞ category $\text{Fuk}(\check{X}_\Sigma)$. This amounts to equipping X with a holomorphic function. It is expected that each compactifying divisor on the space \check{X}_Σ presents the possibility for additional holomorphic disks to appear on the boundary of SYZ fibers of \check{X}_Σ , giving a correspondence between the toric divisors of \check{X}_Σ and the terms to this superpotential. This expectation has been verified from the viewpoint that a projective toric variety \check{X} is a compactification of $(\mathbb{C}^*)^n$ with the induced Kähler form (see, for instance, [Cha20]). In particular, by choosing coordinates and using the mirror Kähler form to obtain a complex structure, we can construct the mirror superpotential which to first order is the Hori-Vafa potential

$$W_\Sigma : (\mathbb{C}^*)^n \rightarrow \mathbb{C}$$

$$(z_1, \dots, z_n) \mapsto \sum_{\alpha \in A} c_\alpha z^\alpha. \quad (2)$$

Here $z^\alpha = z_1^{\alpha_1} \dots z_n^{\alpha_n}$ and $c_\alpha \in \mathbb{C}^*$ are coefficients that depend on the Kähler structure of \check{X}_Σ . When \check{X}_Σ is Fano, this is the correct mirror holomorphic function in the sense of SYZ mirror symmetry, but in general, the potential requires higher-order corrections. Although this construction of W_Σ employs the symplectic structure on \check{X}_Σ coming from the Kähler form, it is commonplace to also treat the pair $((\mathbb{C}^*)^n, W_\Sigma)$ as a mirror when \check{X}_Σ is considered as an algebraic/complex object due to the expected involutive nature of mirror symmetry. One palatable feature of this treatment is that W_Σ is unchanged as a singular symplectic fibration when varying the $c_\alpha \in \mathbb{C}^*$.

However, it is more natural to only use the complex algebraic structure on \check{X}_Σ . As in the case of semi-flat mirror symmetry, it should be possible to understand an SYZ mirror symmetry construction without the choice of a Kähler structure for \check{X}_Σ . Recall that after taking a choice of coordinates, an element $u = (u_1, \dots, u_n) \in N$ lies in a cone $\sigma \in \Sigma$ if and only if the limit

$$\lim_{z \rightarrow \infty} (z^{u_1}, \dots, z^{u_n})$$

exists in \check{X}_Σ and converges to a point in the toric strata corresponding to σ . As $\check{\text{Log}}(z^{u_1}, \dots, z^{u_n}) = (\log |z|)u$, we can view this limiting point as lying at infinity along the ray spanned by u , determining a circle $\arg(z)u$ in the fiber which is collapsed to a point in the boundary stratum. Thus, we obtain a boundary condition on the mirror T^*Q/M to $N \otimes \mathbb{C}^*$: above a cone $\sigma \in \Sigma$, $u \cdot p$ should be asymptotically constant for all $u \in \sigma$ where $p = (\arg(z_1), \dots, \arg(z_n))$. Writing $\sigma = \langle \alpha_1, \dots, \alpha_k \rangle$ for primitive generators $\alpha_1, \dots, \alpha_k$, this condition is equivalent to $\alpha_1 \cdot p, \dots, \alpha_k \cdot p$ being asymptotically constant. Moreover, thinking of p as parameterizing a dual torus, we see that the limiting

constant should be 0, that is, the unit in $S^1 = \mathbb{R}/2\pi\mathbb{Z}$. These conditions begin to resemble the data of the Hori-Vafa potential, and can be interpreted in several ways to construct Fukaya categories and study homological mirror symmetry. Two such approaches are explored in Section 2.4.

2.3 Notation for toric varieties: Support functions, morphisms, and sheaves

Let $\Sigma_1 \subset Q_1, \Sigma_2 \subset Q_2$ be two fans. A *map of fans* is a linear map $\underline{f} : Q_1 \rightarrow Q_2$ with the property that for every cone $\sigma_1 \in \Sigma_1$, there exists a cone $\sigma_2 \in \Sigma_2$ with $\underline{f}(\sigma_1) \subset \sigma_2$. The data of a map of fans is equivalent to the data of a toric morphism $\check{f} : \check{X}_{\Sigma_1} \rightarrow \check{X}_{\Sigma_2}$.

For a cone $\sigma \in \Sigma$, we define the star of σ as the subfan of all cones containing σ , that is,

$$\text{star}(\sigma) := \{\tau \in \Sigma : \tau \geq \sigma\}.$$

We will often abuse this notation by conflating $\text{star}(\sigma)$ with the subset of $N \otimes \mathbb{R}$ covered by $\text{star}(\sigma)$ and by writing $\text{star}(\alpha)$ in place of $\text{star}(\langle \alpha \rangle)$. Note that when $\sigma = 0$, the star of σ is the whole fan; when σ is top dimensional, then $\text{star}(\sigma) = \sigma$. The standard inclusion $\text{star}(\sigma) \hookrightarrow \Sigma$ is a map of fans and the corresponding map of toric varieties $\check{X}_{\text{star}(\sigma)} \hookrightarrow \check{X}_{\Sigma}$ identifies $\check{X}_{\text{star}(\sigma)}$ as the normal bundle to the closure of the toric orbit indexed by σ .

The toric orbit closure associated with the cone σ is itself a toric variety, which has a description in terms of $\text{star}(\sigma)$. Let $Q_{\sigma} := Q/(\mathbb{R} \cdot \langle \sigma \rangle)$ be the quotient of the cocharacter lattice by the real span of σ . The *orbit closure fan* of σ is the fan⁵

$$\text{star}(\sigma)/\sigma := \{\tau/(\mathbb{R} \cdot \langle \sigma \rangle) : \sigma < \tau\} \subset Q_{\sigma}.$$

With this notation, the toric varieties $\check{X}_{\text{star}(\alpha)/\alpha}$ correspond to toric divisors of \check{X}_{Σ} . $\check{X}_{\text{star}(\sigma)/\sigma}$ is the closure of the toric orbit associated with σ . For the inclusion of a toric orbit, we will write $i_{\sigma\tau} : \check{X}_{\text{star}(\sigma)/\sigma} \hookrightarrow \check{X}_{\text{star}(\tau)/\tau}$. Note that this is not a toric map. Accordingly, $\check{X}_{\text{star}(\sigma)} = N_{\check{X}_{\Sigma}} \check{X}_{\text{star}(\sigma)/\sigma}$, and the map of fans $\text{star}(\sigma) \rightarrow \text{star}(\sigma)/\sigma$ yields the projection of toric varieties

$$\check{X}_{\text{star}(\sigma)} \rightarrow \check{X}_{\text{star}(\sigma)/\sigma}.$$

We now provide a mirror-symmetry biased set of notation for discussing line bundles and divisors on toric varieties.

Definition 2.3. A support function $F : Q \rightarrow \mathbb{R}$ is a piecewise linear map whose domains of linearity are the cones of the fan Σ , and whose differentials (over the domains of linearity where it is defined) are contained in $T_{\mathbb{Z}}^*Q$. Equivalently in the smooth setting, we take the piecewise linear maps whose domains of linearity are the cones of Σ , and $F(\alpha) \in \mathbb{Z}$ for all $\alpha \in A$.

Let α be a 1-dimensional cone. We will write F_{α} for the support function which is 1 on α , and 0 on all other 1-dimensional cones in A . We will denote the set of support functions $\text{Supp}(\Sigma)$. We favor support functions rather than divisors for encoding the geometry of \check{X}_{Σ} as they rely only on the affine geometry of Q , and are therefore more natural objects to consider from a mirror-symmetry perspective. From this viewpoint, divisors, line bundles, and sheaves on \check{X}_{Σ} are the B -model extensions of the underlying tropical geometry given by Q and support functions $F : Q \rightarrow \mathbb{R}$. To recover a toric divisor D on \check{X}_{Σ} from a support function, we take $D_F = \sum_{\alpha \in \Sigma} -(F(\alpha)) \cdot D_{\alpha}$. To obtain a line bundle on \check{X}_{Σ} from a support function, we take

⁵This is slightly different than the notation in [CLS11], where $\text{star}(\sigma)$ is used to denote what we call $\text{star}(\sigma)/\sigma$.

$\mathcal{O}_\Sigma(F) := \mathcal{O}_\Sigma(D_F)$.⁶ Two support functions F_1, F_2 represent linearly equivalent divisors if and only if the difference $F_1 - F_2$ is a linear function. A map of fans $\underline{f} : \Sigma_1 \rightarrow \Sigma_2$ induces a pullback map on support functions $\underline{f}^* : \text{Supp}(\Sigma_2) \rightarrow \text{Supp}(\Sigma_1)$. This means that we have a well-defined pullback map for toric divisors. This pullback intertwines with the toric morphism in the sense that

$$\check{f}^* \mathcal{O}_{\Sigma_2}(F) = \mathcal{O}_{\Sigma_1}(\underline{f}^* F).$$

When $\check{X}_{\text{star}(\sigma)/\sigma}$ is an orbit closure, the (non-toric) map of varieties $\check{i}_{\sigma 0} : \check{X}_{\text{star}(\sigma)/\sigma} \hookrightarrow \check{X}_\Sigma$ does not have a well-defined pullback map on divisors. However, there is a well-defined pullback map on line bundles, and therefore a pullback map on linear equivalence classes of support functions.

Proposition 2.4. *Let $\sigma \in \Sigma$ be a cone. There is a surjective linear map*

$$\check{i}_{\sigma 0}^* : (\text{Supp}(\Sigma)/\sim) \rightarrow (\text{Supp}(\text{star}(\sigma)/\sigma)/\sim)$$

where \sim is the relation of linear equivalence.

At times we will not want to work on the level of support functions modulo linear equivalence, but still make sense of pullback. In that case, we will restrict ourselves to the support functions which give divisors transverse to a toric orbit closure. Let $\sigma \in \Sigma$ be a fan. The *transverse support functions* are those which vanish on σ ,

$$\text{Supp}_\sigma(\Sigma) := \{F : F(q) = 0 \text{ for all } q \in \sigma\}$$

and there is a well-defined map from $\text{Supp}_\sigma(\Sigma) \rightarrow \text{Supp}(\text{star}(\sigma)/\sigma)$. Finally, we fix some notation for sheaves on toric varieties and toric orbit closures. We note that a toric orbit closure of \check{X}_Σ is a toric variety and a subvariety of \check{X}_Σ , but not a toric subvariety of \check{X}_Σ . Having fixed a fan Σ , the sheaf $\mathcal{O}_\sigma(F)$ will be a line bundle on the space $\check{X}_{\text{star}(\sigma)/\sigma}$, where F is either a support function on $\text{star}(\sigma)/\sigma$, or is pulled back from a support function $F \in \text{Supp}_\sigma(\Sigma)$. The line bundles on \check{X}_Σ are denoted $\mathcal{O}_0(F)$ — however, when it is unambiguous that we are referring to a line bundle on \check{X}_Σ , we will simply write $\mathcal{O}(F)$. The pullback map on transverse support functions $\check{i}_{\sigma 0}^* : \text{Supp}_\sigma(\Sigma) \rightarrow \text{Supp}(\text{star}(\sigma)/\sigma)$ agrees with the pullback of line bundles in the sense that

$$\check{i}_{\sigma 0}^*(\mathcal{O}_0(F)) = \mathcal{O}_\sigma(\check{i}_{\sigma 0}^*(F)).$$

We denote the pushforward of a line bundle along $i_{\sigma 0} : \check{X}_{\text{star}(\sigma)/\sigma} \hookrightarrow \check{X}_\Sigma$ by:

$$\mathcal{O}_{\sigma > 0}(F) := (i_{\sigma 0})_* \mathcal{O}_\sigma(i_{\sigma 0}^* F) \in \text{Coh}(\check{X}_\Sigma).$$

We will denote by $\pi_\sigma : \check{X}_{\text{star}(\sigma)} \rightarrow \check{X}_{\text{star}(\sigma)/\sigma}$ the standard projection of the normal bundle to the base. Similarly, when $\sigma > \tau$ we write $\mathcal{O}_{\sigma > \tau}$ for the pushforward of \mathcal{O}_σ to $\check{X}_{\text{star}(\tau)/\tau}$.

2.4 Toric HMS: FLTZ skeleton and monomial admissibility

We now apply the conclusions of Section 2.2 to construct Fukaya categories homologically mirror to the derived category of coherent sheaves on \check{X}_Σ . All definitions involve imposing conditions on Lagrangian objects *near infinity*, that is, outside of a compact subset. There are two dual ways to constrain Lagrangians: require them to be contained in or to avoid a closed subset at infinity.

⁶This leads to the somewhat unfortunate convention that $D_{F_\alpha} = -D_\alpha$.

The first approach results in what is usually called an infinitesimally wrapped category; the second gives a partially wrapped category. Under mirror symmetry, these are expected to correspond to the categories of compactly supported perfect complexes and coherent sheaves, respectively. If \check{X}_Σ is smooth and complete, then these two categories are the same.

The traditional approach for toric varieties is to take the closed subset to be a fiber over a very large positive number, $W_\Sigma^{-1}(\infty)$. Then, the infinitesimally wrapped category is the Fukaya-Seidel category as envisioned by Seidel [Sei08], and the partially wrapped category is the Fukaya-Seidel category as defined in [Syl19a; GPS19]. As both categories are generated by Lefschetz thimbles, it is expected that these categories are equivalent in the case that \check{X}_Σ is smooth and projective. A proof of this equivalence requires an argument similar to that of Theorem 3.5 with some extra considerations on the choice of symplectic form used to define each category. However, these categories are not homological mirrors to \check{X}_Σ when the anticanonical bundle on \check{X}_Σ is not nef [AKO08; Bal+15].

As noted in Section 2.2, a more natural boundary condition instead involves a collection of subtori determined by Σ when considering \check{X}_Σ on the B-side of mirror symmetry. Namely, near infinity⁷ in a cone $\sigma = \langle \alpha_1, \dots, \alpha_k \rangle \in \Sigma$, we should have a boundary condition of the form

$$p \cdot \alpha_1 = \dots = p \cdot \alpha_k = 0.$$

Thinking in terms of these generators, we are immediately led to a stop of the form

$$\mathfrak{f}_\Sigma = \{(u, p) \in \partial((\mathbb{C}^*)^n)^{int} : p \cdot \alpha = 0 \text{ for all } \alpha \in A \text{ such that } u \in \text{int}(\text{star}(\alpha))\}$$

whose skeleton is the *FLTZ skeleton*

$$\begin{aligned} \mathbb{L}_\Sigma &= \{(u, p) \in (\mathbb{C}^*)^n : p \cdot \alpha = 0 \text{ for all } \alpha \in A \text{ such that } u \in \text{int}(\text{star}(\alpha))\} \cup \{(0, p) \in (\mathbb{C}^*)^n\} \\ &= \bigcup_{\sigma \in \Sigma} \{(u, p) \in (\mathbb{C}^*)^n : u \in \sigma \text{ and } p \cdot v = 0 \text{ for all } v \in \sigma\} \\ &= \bigcup_{\sigma \in \Sigma} \sigma \times \sigma^\perp \subset N \times (M \otimes \mathbb{R})/M = T^*Q/T_{2\pi\mathbb{Z}}Q \simeq (\mathbb{C}^*)^n \end{aligned} \tag{3}$$

introduced in [Fan+11] using similar SYZ considerations. We will denote a stratum of the FLTZ skeleton by $\mathbb{L}_\sigma = \sigma \times \sigma^\perp$, and similarly denote corresponding stratum of the stop by $\mathfrak{f}_\sigma \subset \mathfrak{f}_\Sigma$. Thus, it is clear from this perspective that the appropriate partially wrapped category to consider is $\mathcal{W}((\mathbb{C}^*)^n, \mathfrak{f}_\Sigma)$.

It is then tempting to also construct a Fukaya-Seidel type category consisting of Lagrangian branes that lie in \mathfrak{f}_Σ near infinity. However, such a category would not contain many interesting objects due to the singular nature of \mathfrak{f}_Σ . Instead, we must allow some room for Lagrangians to twist. One way to implement this is to use a monomial admissibility condition (introduced in [Han19]). We will need only a particular instance of monomial admissibility and work towards defining it now.

In order to restrict Lagrangians near infinity, we introduce sets in the base Q over which certain arguments must be controlled. We begin with the following definition which will also be useful for later exposition.

⁷Here, we have traded the asymptotic condition justified in Section 2.2 for a condition achieved near infinity in order to establish compactness in the Floer theory. Alternatively, an asymptotic condition becomes a condition near infinity when working with conical Lagrangians. However, restricting to conical Lagrangians is also largely done for technical reasons.

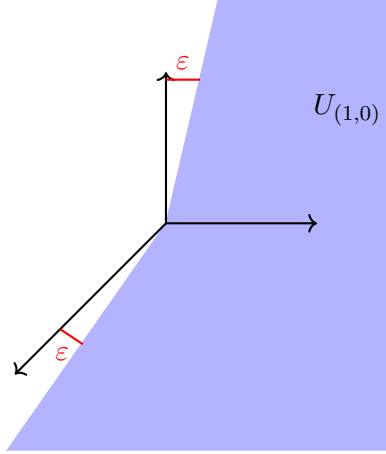

Figure 1. The open set $U_{1,0}$ in the ε -star open cover for a fan corresponding to \mathbb{P}^2 . Taking the closure of this set gives the cone $C_{1,0}$ in the ε combinatorial division, Δ_ε .

Definition 2.5. The ε -star open cover for Σ and $\varepsilon > 0$ is the collection of sets $\{U_\alpha\}_{\alpha \in A}$ where each $U_\alpha \subset \mathbb{R}^n$ is the open cone over the set

$$\{u \in \mathbb{R}^n : \|u\| = 1, u \in \text{star}(\alpha), \text{ and } d(u, \sigma) > \varepsilon \text{ for all } \sigma \in \Sigma \text{ such that } \alpha \notin \sigma\}$$

where distance and length are taken with respect to the Euclidean metric.

Note that the ε -star open cover for Σ is a cover of $\mathbb{R}^n \setminus \{0\}$ for ε sufficiently small when Σ is a complete fan, and we will always assume that we choose ε small enough for this to be true.

Definition 2.6. The ε combinatorial division Δ_ε for Σ is the collection of closed sets $\{C_\alpha\}_{\alpha \in A}$ where $C_\alpha = \overline{U_\alpha}$ is the closure of the corresponding subset of the ε -star open cover.

For any fan corresponding to a smooth projective toric variety, it was shown in [Han19, Corollary 2.40] that there exists a choice of toric Kähler form on $(\mathbb{C}^*)^n$ such that the ε combinatorial division is a *monomial division adapted to Σ* in the sense that it satisfies the following properties:

1. The closed subsets $\{C_\alpha\}_{\alpha \in A}$ cover \mathbb{R}^n ;
2. there are constants $k_\alpha \in \mathbb{R}_{>0}$ such that

$$\max_{\alpha \in A} |z^\alpha|^{k_\alpha} = |z^\beta|^{k_\beta}$$

implies that $u(z) \in C_\beta$;

3. $C_\alpha \setminus \{0\} \subset \text{int}(\text{star}(\alpha))$ for all $\alpha \in A$.

Remark 2.7. The difficulty in the above statement lies only in verifying the second property, which involves the complex structure on $(\mathbb{C}^*)^n$ and is used to obtain a maximum principle on holomorphic discs. Therefore, the monomially admissible Fukaya-Seidel category depends on the Kähler structure on $(\mathbb{C}^*)^n$ rather than just the symplectic structure. In particular, the choice of toric Kähler form only manifests through the expression of u in terms of holomorphic coordinates.

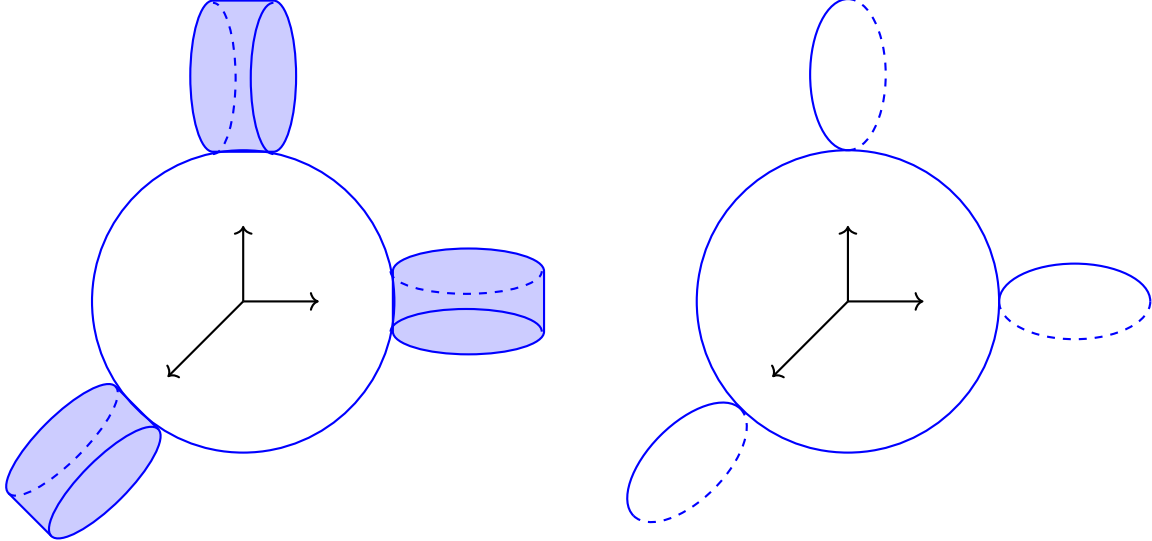

Figure 2. The region of $\partial_\infty(\mathbb{C}^*)^2$ that monomially admissible Lagrangian sections are permitted to intersect (left) and the stop \mathfrak{f}_Σ of the FLTZ skeleton for $\check{X}_\Sigma = \mathbb{P}^2$.

After choosing such a toric Kähler form, we can then associate to Δ_ε a monomially admissible Fukaya-Seidel category $\mathcal{F}_{\Delta_\varepsilon}$ as detailed in [Han19]. Whenever discussing this category, we will always assume we have chosen such a Kähler form. Objects of $\mathcal{F}_{\Delta_\varepsilon}$ are supported on *monomially admissible Lagrangians*, that is, exact Lagrangians that are required to satisfy $z^\alpha \in \mathbb{R}_{>0}$ for $z \in L$ such that $u(z) \in C_\alpha$ near infinity. In other words, if $(u, p) \in L$ and $u \in C_\alpha$ lies outside a compact set, then $p \cdot \alpha = 0$. Roughly, morphisms are computed by applying a Hamiltonian K that increases $p \cdot \alpha$ near infinity in C_α for all $\alpha \in A$. In practice, the category is obtained by localization at the continuation elements coming from the Hamiltonian K . The category of Lagrangian sections (with respect to u) form an important and computable subcategory as explained in the next section.

Remark 2.8. More generally, [Han19] associates a Fukaya-Seidel category to any *monomial division*, i.e., collection Δ of closed subsets satisfying the conditions above. For the purposes of this paper, we will only need to work with Δ_ε , which in the language of [Han19] corresponds to working with a monomial division *adapted to* Σ .

2.5 Tropical Lagrangian sections

It is well-understood that Lagrangian sections of an SYZ fibration should be mirror to line bundles, and this philosophy carries through to the toric setting despite the compactification. In the context of HMS for toric varieties, Lagrangian sections of Log were first studied in [Abo06] where Abouzaid computes the Floer cohomology of the mirror to powers of an ample line bundle. Applying the Legendre transform and working with sections of the SYZ fibration u is more amenable to constructing and computing a category of all sections as done in [Abo09]. Abouzaid studied sections lying over a region in Q modeled on the moment polytope of \check{X}_Σ and with boundary on a fiber of the tropical localization of W_Σ . To pass to the partially wrapped setting, it will be more convenient for us to work with the variant of Abouzaid's approach introduced in [Han19] and motivated above.

Namely, we consider the subcategory $\mathcal{F}_{\Delta_\varepsilon}^s \subset \mathcal{F}_{\Delta_\varepsilon}$ of Lagrangian sections of u . Note that $\mathcal{F}_{\Delta_\varepsilon}^s$ is independent of small ε by [Han19, Proposition 3.19]. The Hamiltonian isotopy classes of

monomially admissible Lagrangian sections have particularly nice representatives, which we will refer to as *tropical Lagrangian sections*. Indeed, given a support function F_D corresponding to a toric divisor $D = \sum n_\alpha D_\alpha$, we can smooth F_D to a function H_D . By abuse of notation, we will also use H_D to denote the Hamiltonian for $H \circ u : (\mathbb{C}^*)^n \rightarrow \mathbb{R}$, which we call a *twisting Hamiltonian* for D . This Hamiltonian also satisfies

$$dH_D(\alpha) = -2\pi n_\alpha$$

near infinity in C_α for all $\alpha \in A$ by setting

$$H_D(u) = -2\pi \int_{\mathbb{R}^n} F_D(u-x)\eta_\varepsilon(x) dx$$

where η_ε is a smooth symmetric mollifier supported on the ball of radius ε as in [Han19, Proposition 2.13]. From a twisting Hamiltonian H_D , we obtain a tropical Lagrangian section $L(D)$ as the projection of the graph of dH_D to $T^*Q/T_{2\pi\mathbb{Z}}^*Q$ or, equivalently, the time-1 flow of the real positive locus $\mathbb{R}_{>0}^n \subset (\mathbb{C}^*)^n$ under the Hamiltonian isotopy. The Floer theory of these Lagrangians can be shown to behave exactly as expected.

Theorem 2.9 (Corollary 3.41 of [Han19] following [Abo09]). *There is a quasi-equivalence*

$$\mathcal{F}_{\Delta_\varepsilon}^s \simeq \text{Pic}_{\text{dg}}(\check{X}_\Sigma)$$

for small ε where $\text{Pic}_{\text{dg}}(\check{X}_\Sigma)$ is a dg-enhancement of the category of line bundles on \check{X}_Σ .

In fact, this construction gives slightly more as the time-1 flow of H_D preserves monomial admissibility with respect to Δ_ε . Thus, these Hamiltonian diffeomorphisms act on $\mathcal{F}_{\Delta_\varepsilon}$, and it can be checked that on $\mathcal{F}_{\Delta_\varepsilon}^s$ these functors are mirror to the functors $(\cdot) \otimes \mathcal{O}(D)$ as done in [Han19, Theorem 4.5].

Remark 2.10. In [Abo09], tropical Lagrangian sections are defined as sections over a subset P of $(\mathbb{C}^*)^n$, which is roughly the polytope of \check{X}_Σ for some ample line bundle, with boundary on a deformation of the Hori-Vafa superpotential. This makes Abouzaid's category of tropical Lagrangian sections⁸, $\mathcal{T}\text{Fuk}$, a subcategory of a more traditionally defined Fukaya-Seidel category. Abouzaid's tropical Lagrangian sections are closely related to those considered above. Indeed, assuming that we can work with the standard Kähler form to define $\mathcal{F}_{\Delta_\varepsilon}^s$ (see Remark 2.7), then there is an equivalence between $\mathcal{T}\text{Fuk}$ and $\mathcal{F}_{\Delta_\varepsilon}^s$ given by restricting $L(D)$ to $\text{Log}^{-1}(P)$ as shown in [Han19, Proposition 3.23]. Even without that assumption, it can be deduced from [Han19, Proposition 2.36] that the restriction of $L(D)$ to $\text{Log}^{-1}(P)$ are objects in $\mathcal{T}\text{Fuk}$ even though they are not the smoothing of a support function in the Log coordinates. Of course, combining [Abo09, Theorem 1.2] and [Han19, Corollary 3.41] also gives a less direct equivalence between $\mathcal{T}\text{Fuk}$ and $\mathcal{F}_{\Delta_\varepsilon}^s$ regardless of the Kähler form used to define the latter.

3 Conical Lagrangian sections and twisting Hamiltonians

This section consists of producing the embedding in Theorem A, translating the action of twisting Hamiltonians from [Han19] to the partially wrapped setting, and realizing cocores of \mathbb{L}_Σ as tropical Lagrangian sections. The main ingredient is the observation that tropical Lagrangian sections (sections very close to their piecewise-linear/tropical limit) exist in both categories. Furthermore, these sections have matching Floer theory.

⁸This is defined in [Abo09] as an A_∞ -pre-category, but using localization, one can define a quasi-equivalent A_∞ -category.

3.1 Construction and embedding

We will now construct a full and faithful embedding of $\mathcal{F}_{\Delta_\varepsilon}^s$ into $\mathcal{W}((\mathbb{C}^*)^n, \mathfrak{f}_\Sigma)$ for small ε . Although objects of $\mathcal{F}_{\Delta_\varepsilon}$ naturally lie in the complement of the FLTZ skeleton when perturbed by the Hamiltonian K , there are three difficulties in passing from monomially admissible Floer theory to partially wrapped Floer theory. Monomially admissible Lagrangians, which in general are not conical at infinity, must be modified to obtain objects of the partially wrapped category. Then, we must check that this modification does not change the Floer theory of the Lagrangians when now computed with a cylindrical almost complex structure. Finally, we need to prove that the (conical version of) the Hamiltonian K gives a cofinal wrapping and thus can be used to compute morphisms in $\mathcal{W}((\mathbb{C}^*)^n, \mathfrak{f}_\Sigma)$.

Although it is not clear how to produce a conical Lagrangian submanifold from a monomially admissible Lagrangian submanifold in general, we can modify the construction of tropical Lagrangian sections summarized in Section 2.5 from support functions of toric divisors to obtain tropical Lagrangian sections in $\mathcal{W}((\mathbb{C}^*)^n, \mathfrak{f}_\Sigma)$. As the Liouville vector field is the radial vector field on the SYZ base, this amounts to smoothing the piecewise linear support function F_D of a toric divisor so that the gradient is invariant under rescaling in the complement of a compact set. As observed in Remark 3.4 of [Han19], this is not possible while preserving monomial admissibility. We therefore will need to allow some distortion of $p \cdot \alpha$ even close to the ray $\langle \alpha \rangle \in \Sigma$.

Lemma 3.1. *Suppose that F_D is the piecewise-linear support function of a toric divisor $D = \sum_{\alpha \in A} n_\alpha D_\alpha$, $\{U_\alpha\}$ is the ε -star open cover for Σ , $\varepsilon > 0$ is sufficiently small, and $V \subset \mathbb{R}^n$ is any compact set for which the origin is an interior point. Then, there exists a smooth function \widehat{H}_D satisfying the following.*

1. \widehat{H}_D is positively homogeneous of degree 1 outside of V .
2. In the complement of V , $\widehat{H}_D = 2\pi F_D$ on any non-empty intersection of the form $U_{\alpha_1} \cap \dots \cap U_{\alpha_n}$.⁹
3. There is a constant C_D , independent of ε and V , such that

$$|\nabla \widehat{H}_D \cdot \alpha + 2\pi n_\alpha| \leq \varepsilon C_D$$

in $U_\alpha \setminus V$ for all $\alpha \in A$.

Proof. Let $\eta : \mathbb{R}^n \rightarrow \mathbb{R}$ be a smooth symmetric ($\eta(u) = \eta(-u)$) mollifier function supported on the ball of radius 1 centered at the origin. For any $t > 0$ define a t -scaled mollifier $\eta_t : \mathbb{R}^n \rightarrow \mathbb{R}$ by $\eta_t(u) = t^{-n} \eta(u/t)$.

Define $G : \mathbb{R}^n \setminus \{0\} \rightarrow \mathbb{R}$ by

$$G(u) = 2\pi \int_{\mathbb{R}^n} F_D(u - x) \cdot \eta_{\varepsilon r}(x) dx = 2\pi \int_{\mathbb{R}^n} F_D(u - rx) \cdot \eta_\varepsilon(x) dx$$

where $r = \|u\|$ is the radial coordinate with respect to the Euclidean metric. It is straightforward to see that G is smooth and homogeneous of degree 1. It also follows from a direct computation that $G = F_D$ on any set of the form $U_{\alpha_1} \cap \dots \cap U_{\alpha_n}$ using the fact that F_D is a linear function on the open ball of radius εr around any point in the intersection.

⁹We never use this condition, but it is somewhat reassuring to make the Lagrangian sections as close to their tropical counterparts as possible.

We can then compute that

$$\nabla G(u) = 2\pi \int_{\mathbb{R}^n} \left[\nabla F_D(u - rx) - \frac{\nabla F_D(u - rx) \cdot x}{r} u \right] \eta_\varepsilon(x) dx. \quad (4)$$

The gradient of the support function is given by $\nabla F_D \cdot \alpha = -n_\alpha$ on the open ball of radius εr around any point in U_α . Thus, if we set $E^\alpha(u) = (\nabla G(u) \cdot \alpha + 2\pi n_\alpha)/2\pi$, we have

$$E^\alpha(u) = \frac{u \cdot \alpha}{r} \int_{\mathbb{R}^n} (\nabla F_D(u - rx) \cdot x) \eta_\varepsilon(x) dx$$

for all $u \in U_\alpha$, and

$$\begin{aligned} |E^\alpha(u)| &= \frac{|u \cdot \alpha|}{r} \left| \int_{\mathbb{R}^n} (\nabla F_D(u - rx) \cdot x) \eta_\varepsilon(x) dx \right| \\ &\leq \|\alpha\| \int_{\mathbb{R}^n} \|\nabla F_D(u - rx)\| \|x\| \eta_\varepsilon(x) dx \\ &\leq \varepsilon \|\alpha\| \int_{\mathbb{R}^n} \|\nabla F_D(u - rx)\| \eta_\varepsilon(x) dx \\ &\leq \varepsilon \|\alpha\| \max_{\sigma \in \Sigma^n} \|\nabla F_D|_\sigma\| \end{aligned}$$

using the Cauchy-Schwarz inequality and that $\eta_\varepsilon(x)$ is supported on the ball of radius ε . This gives us the bound

$$|E^\alpha(u)| \leq \varepsilon C_D / 2\pi$$

for all $\alpha \in A$ where the constants C_D are given by

$$C_D = 2\pi \max_{\alpha \in A} \|\alpha\| \max_{\sigma \in \Sigma^n} \|\nabla F_D|_\sigma\|.$$

To obtain the smooth function $\widehat{H}_D : \mathbb{R}^n \rightarrow \mathbb{R}$, we use a bump function with support contained within V to smoothly interpolate between G and a smooth function. \square

The previous lemma allows us to construct Lagrangian sections in $\mathcal{W}((\mathbb{C}^*)^n, \mathfrak{f}_\Sigma)$ corresponding to divisors on \check{X}_Σ by modifying the procedure outlined in Section 2.5. We begin by fixing a compact set $V \subset \mathbb{R}^n$ containing the origin as an interior point. For any $\delta > 0$ and toric divisor D on \check{X}_Σ , we let \widehat{H}_D^δ be a smooth function as guaranteed by Lemma 3.1 for our fixed compact set V and $\varepsilon = \delta/C_D$. We will refer to such functions as *conical twisting Hamiltonians with defect* δ . We will denote the time t flow of $\widehat{H}_D^\delta \circ u$ by $\phi_{D,\delta}^t : (\mathbb{C}^*)^n \rightarrow (\mathbb{C}^*)^n$. For the canonical divisor $K = \sum_{\alpha \in A} -D_\alpha$, we will simplify the notation to ψ_δ^t for its flow.

To obtain Lagrangian sections, we set \mathcal{L} to be the zero section (equivalently, $\mathcal{L} = (\mathbb{R}_{>0})^n \subset (\mathbb{C}^*)^n$) and

$$L^\delta(D) := \psi_{\delta/4}^{-\frac{\delta}{2\pi}} \phi_{D,\delta/4}^1(\mathcal{L}).$$

In other words, $L^\delta(D)$ is the image of the graph of

$$d \left(\widehat{H}_D^{\delta/4} + \left(-\frac{\delta}{2\pi} \right) H_K^{\delta/4} \right)$$

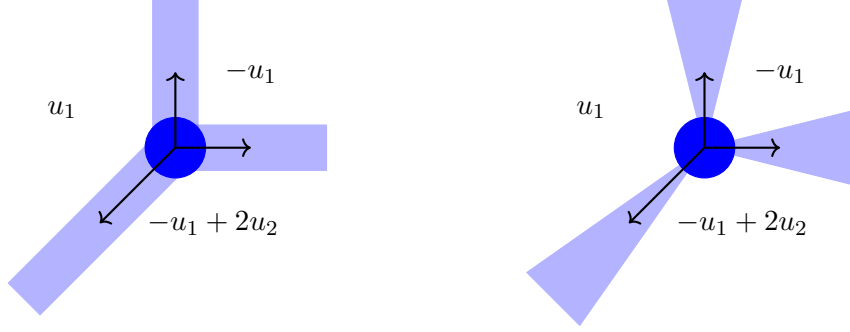

Figure 3. The monomial admissible smoothing, $\frac{1}{2\pi}H_D$, and the conical smoothing, $\frac{1}{2\pi}\widehat{H}_D^\delta$, of the support function F_D for $D = D_{(1,0)} + D_{(-1,-1)}$ on \mathbb{P}^2 are shown on the left and right, respectively. The dark blue circle represents $u(V)$ while the shaded regions represent where the piecewise linear function is smoothed with strict and approximate control of the corresponding angles, respectively.

under the projection from $T^*\mathbb{R}^n$ to $T^*\mathbb{R}^n/T_{2\pi\mathbb{Z}}^*\mathbb{R}^n \simeq (\mathbb{C}^*)^n$. We will, at times, call $L^\delta(D)$ a *conical tropical Lagrangian section with defect δ* . We will also sometimes use the notation $L^\delta(F) := L^\delta(D_F)$, where F is a support function for the divisor D . We base our choice of notation on the notation used for line bundles on the toric variety \check{X}_Σ . Taking Arg to denote the branch of \arg taking values in $[-\pi, \pi)$, note that Lemma 3.1 implies that

$$\left| \text{Arg} \left(z^\alpha|_{L^\delta(D)} \right) + \delta \right| \leq \delta/2 < \delta \quad (5)$$

in $U_\alpha \setminus V$ for all $\alpha \in A$. Now, we observe that for every cone $\sigma \in \Sigma$ and point $u \in \sigma \setminus V$, there is an $\alpha \in \sigma$ such that $u \in U_\alpha$ for sufficiently small choice of δ . It follows that

$$L^\delta(D) \setminus V \subset (\mathbb{C}^*)^n \setminus \mathbb{L}_\Sigma$$

for all D and sufficiently small δ (see Eq. (3)). Thus, $L^\delta(D)$ supports an object of $\mathcal{W}((\mathbb{C}^*)^n, \mathfrak{f}_\Sigma)$, which has a canonical grading as a Lagrangian section (see [Sei00, Example 2.10]) and a unique relative spin structure as a contractible manifold. We will abuse notation and also denote this object by $L^\delta(D)$. Note that as an object of $\mathcal{W}((\mathbb{C}^*)^n, \mathfrak{f}_\Sigma)$, $L^\delta(D)$ is independent of the choices (η, δ, \dots) made in its construction as different choices result in a Lagrangian that differs by a Hamiltonian isotopy that does not meet \mathfrak{f}_Σ .

Remark 3.2. Conical tropical Lagrangian sections corresponding to a divisor $D = \sum n_\alpha D_\alpha$ are characterized by the fact that they have lifts to $T^*\mathbb{R}^n$ that satisfy

$$-2\pi(n_\alpha - 1) < \alpha \cdot p < -2\pi n_\alpha$$

in the coordinates $(u, p = p(u))$ whenever $u \in U_\alpha$ near infinity. Thus, unlike in the monomially admissible setting, there are many admissible Lagrangian sections that are not tropical or even admissibly Hamiltonian isotopic to a tropical section. See Example 6.18.

It remains to understand the Floer theory of these objects. Note first that when δ is chosen in a smooth family, we can take the functions guaranteed by Lemma 3.1 to vary smoothly by smoothly choosing the interpolation bump functions on V . Below, we will always assume that we have done so.

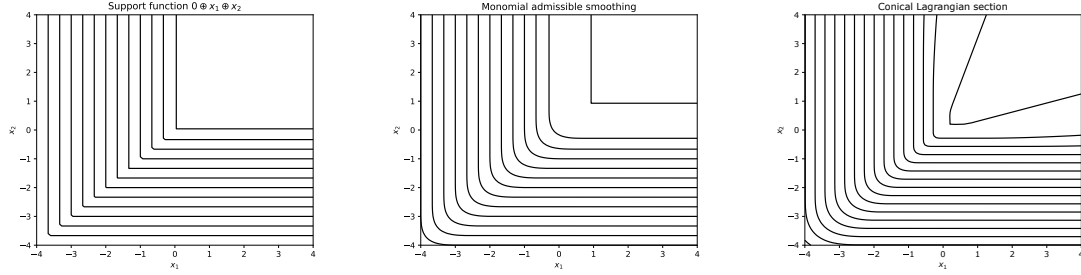

(a) Contour plot of the support function $F_D = \max(0, x_1, x_2)$ (b) Contour plot of the monomial admissible smoothing H_D (c) Contour plot of the conically admissible smoothing \hat{H}_D

Figure 4. Contour plots of a monomial admissible smoothing and a conical smoothing.

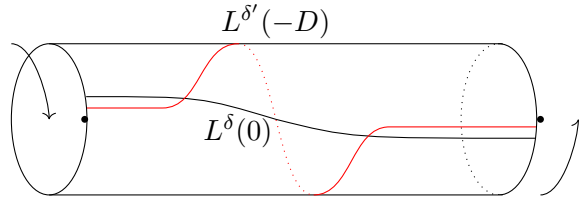

Figure 5. Here, $\check{X}_\Sigma = \mathbb{C}\mathbb{P}^1$, the divisor D is a point, and the Lagrangians are in position to compute $\text{Hom}_{\mathcal{W}(\mathbb{C}^*, \mathfrak{f}_\Sigma)}(L(-D), L(0))$. Note that $\delta' < \delta$.

Lemma 3.3. *If δ_0 is sufficiently small and $\delta(t)$ is a smooth monotonically decreasing function on $[0, \infty)$ satisfying $\delta(0) = \delta_0$ and*

$$\lim_{t \rightarrow \infty} \delta(t) = 0,$$

then $\{L_t\}_{t \geq 0}$ defined by

$$L_t = L^{\delta(t)}(D)$$

is a cofinal wrapping of $L^{\delta_0}(D)$ in $((\mathbb{C}^)^n, \mathfrak{f}_\Sigma)$.*

Proof. By the comments preceding the statement of the lemma, $\{L_t\}$ is a smooth family of exact Lagrangians in $(\mathbb{C}^*)^n \setminus \mathfrak{f}_\Sigma$. We now need to check this is a positive isotopy at infinity. Recall that we take the contact boundary to be $\|u\| = R$ for large R (with V in the interior) and the contact form is given by

$$\lambda = \sum_{i=1}^n u_i dp_i.$$

In those coordinates,

$$L_t(u) = \left(u, \frac{\partial \hat{H}_D^{\delta(t)/4}}{\partial u} - \frac{\delta(t)}{2\pi} \frac{\partial H_K^{\delta(t)/4}}{\partial u} \right)$$

and thus

$$\lambda(\partial_t L_t)(u) = u \cdot \frac{d}{dt} \left(\nabla \hat{H}_D^{\delta(t)/4}(u) - \frac{\delta(t)}{2\pi} \nabla H_K^{\delta(t)/4}(u) \right).$$

Combining the above with Eq. (4) and the fact that F_K and F_D are piecewise-linear, we have

$$\begin{aligned}\lambda(\partial_t L_t)(u) &= -\delta'(t) \int_{\mathbb{R}^n} F_K(u - Rx) \eta_{\varepsilon_K(t)}(x) dx \\ &\quad + 2\pi \frac{d}{dt} \int_{\mathbb{R}^n} F_D(u - Rx) \eta_{\varepsilon_D(t)}(x) dx \\ &\quad - \delta(t) \frac{d}{dt} \int_{\mathbb{R}^n} F_K(u - Rx) \eta_{\varepsilon_K(t)}(x) dx\end{aligned}$$

where $\varepsilon_K(t) = \delta(t)/4C_K$ and $\varepsilon_D(t) = \delta(t)/4C_D$. For the second term, we have

$$\begin{aligned}\frac{d}{dt} \int_{\mathbb{R}^n} F_D(u - Rx) \eta_{\varepsilon_D(t)}(x) dx &= \frac{d}{dt} \int_{\mathbb{R}^n} F_D(u - R\varepsilon_D(t)x) \eta(x) dx \\ &= -R\varepsilon'_D(t) \int_{\mathbb{R}^n} \nabla F_D(u - R\varepsilon_D(t)x) \cdot x \eta(x) dx.\end{aligned}$$

Applying the same calculation to the third term gives

$$\begin{aligned}\lambda(\partial_t L_t)(u) &= -\delta'(t) R \left(\int_{\mathbb{R}^n} F_K(u/R - x) \eta_{\varepsilon_K(t)}(x) dx \right. \\ &\quad + \frac{2\pi}{4C_D} \int_{\mathbb{R}^n} \nabla F_D(u - R\varepsilon_D(t)x) \cdot x \eta(x) dx \\ &\quad \left. - \frac{\delta(t)}{4C_K} \int_{\mathbb{R}^n} \nabla F_K(u - R\varepsilon_K(t)x) \cdot x \eta(x) dx \right).\end{aligned}$$

As $\delta(t)$ is monotonically decreasing, $-\delta'(t)$ is positive. The first term inside the parentheses is positive as F_K is positive on $\mathbb{R}^n \setminus \{0\}$. Moreover, since Σ is complete, for $x \in B_{\varepsilon_K(t)}(0)$ we may write

$$u/R - x = \sum_{\alpha \in \sigma} c_\alpha \frac{\alpha}{\|\alpha\|}$$

where σ is a top-dimensional cone and $c_\alpha \in \mathbb{R}_{\geq 0}$ satisfy $\sum c_\alpha \geq 1 - \varepsilon_K(t) \geq 1 - \varepsilon_K(0)$. It follows that

$$\int_{\mathbb{R}^n} F_K(u/R - x) \eta_{\varepsilon_K(t)}(x) dx \geq \frac{1 - \varepsilon_K(0)}{\max_{\alpha \in A} \|\alpha\|}.$$

For the second term, we have

$$\left| \frac{1}{4C_D} \int_{\mathbb{R}^n} \nabla F_D(u - R\varepsilon_D(t)x) \cdot x \eta(x) dx \right| \leq \frac{1}{4C_D} \max_{\sigma \in \Sigma^n} \|\nabla F_D|_\sigma\| = \frac{1}{8\pi \max_{\alpha \in A} \|\alpha\|}.$$

By the same argument, the norm of the third term has the same upper bound. Thus, $\lambda(\partial_t L_t)(u)$ is positive as long as δ_0 is small enough so that $1 - \varepsilon_K(0) \geq 1/4\pi$.

It then follows from [GPS18b, Lemma 2.1] that the wrapping is cofinal as every point in $L_t \cap B_R(0)$ converges to a point in \mathfrak{f}_Σ as shown by Eq. (5). \square

By modifying these constructions slightly and using monotonicity estimates, we can deduce that Floer cohomology of tropical Lagrangian sections is independent of the method of implementing them in a Fukaya category.

Lemma 3.4. *Suppose that D_1 and D_2 are toric divisors on \tilde{X}_Σ , Δ_ε is the ε combinatorial division for Σ , and $\delta > 0$ is small. If $L(D_1), L(D_2)$ are the corresponding monomially admissible tropical Lagrangian sections and $L^\delta(D_1), L^\delta(D_2)$ are the corresponding conical tropical Lagrangian sections with defect δ , then*

$$H^\bullet \text{Hom}_{\mathcal{F}_\Delta^s}(L(D_1), L(D_2)) \cong H^\bullet \text{Hom}_{\mathcal{W}((\mathbb{C}^*)^n, f_\Sigma)}(L^\delta(D_1), L^\delta(D_2))$$

Proof. By [GPS19, Lemma 3.21], Lemma 3.3, and Eq. (5), we have

$$H^\bullet \text{Hom}_{\mathcal{W}((\mathbb{C}^*)^n, f_\Sigma)}(L^\delta(D_1), L^\delta(D_2)) \cong HF(L^{\delta-d}(D_1), L^\delta(D_2))$$

for generically chosen $d \in (\delta/2, \delta)$ and small δ .¹⁰ Fix a compact set $V \subset \mathbb{R}^n$ as in the definition of the conical twisting Hamiltonians. Using a priori energy bounds from exactness and monotonicity (as in [GPS19, Proposition 3.19]), there is an $R > 0$ such that for any almost complex structure J that is conical on $u^{-1}(B_R(0) \setminus V)$, all J -holomorphic discs contributing to the differential in $CF(L^{\delta-\varepsilon}(D_1), L^\delta(D_2))$ are contained in $u^{-1}(B_R(0))$. Moreover, this property is preserved when modifying J and the Lagrangians outside of $B_R(0)$ without creating additional intersection points. We can then interpolate between the two flavors of tropical sections as follows.

Let $f_a : [0, \infty) \rightarrow \mathbb{R}$ be a smooth, non-decreasing concave function that satisfies $f_a(t) = t$ for $t \leq a$ and $f_a(t) = a + \varepsilon$ for $t \geq a + \varepsilon$ for some small $\varepsilon > 0$ as drawn in Fig. 6. We define an interpolating tropical Lagrangian section of radius a associated to a toric divisor D to be a Lagrangian section of the form $L_a(D) = dH_D^a$ where

$$H_D^a(u) = 2\pi \int_{\mathbb{R}^n} F_D(u-x) \eta_{\varepsilon f_a(r)}(x) dx$$

outside of a compact set V with small $\varepsilon > 0$. Calculating as in the proof of Lemma 3.1, we obtain that

$$|\nabla H_D^a + 2\pi n_\alpha| \leq \varepsilon f'_a(r) C_D.$$

in $U_\alpha \setminus V$ for all $\alpha \in A$. Proceeding as in the case of the conical tropical Lagrangian sections we can then construct an interpolating tropical Lagrangian section of radius a and defect δ , $L_a^\delta(D)$, satisfying

$$\left| \text{Arg} \left(z^\alpha |_{L_a^\delta(D)(a)} \right) + \delta \right| < f'_a(r) \delta. \quad (6)$$

Moreover, $L_a^\delta(D) = L^\delta(D)$ in $u^{-1}(B_a(0))$ and is equal to $\psi^{-\frac{\delta}{2\pi}}(L_a(D))$ where $L_a(D)$ is a monomially admissible Lagrangian section corresponding to D with respect to Δ_ε . Finally, observe that Eq. (6) and concavity of f_a imply that all intersection points between $L_a^\delta(D_1)$ and $L_a^{\delta-d}(D_2)$ lie in V for all a such that $V \subset B_a(0)$. After choosing $a > R$ and a monomially admissible almost complex structure J that is conical on $u^{-1}(B_R(0) \setminus V)$, we have a canonical identification

$$CF^\bullet(L^{\delta-d}(D_1), L^\delta(D_2)) = CF^\bullet(L_a^{\delta-d}(D_1), L_a^\delta(D_2)) = CF^\bullet(\psi^{d/2\pi}(L_a(D_1)), L_a(D_2))$$

as chain complexes. Finally, from Propositions 2.17 and 3.3 of [Han19], we get

$$HF^\bullet(\psi^{d/2\pi}(L_a(D_1)), L_a(D_2)) \cong HF^\bullet(\psi^{d/2\pi}(L(D_1)), L(D_2)) \cong H^\bullet \text{Hom}_{\mathcal{F}_\Delta^s}(L(D_1), L(D_2))$$

as desired. \square

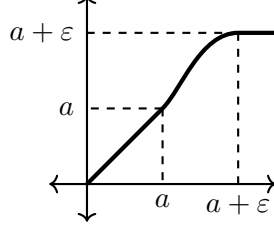

Figure 6. The graph of the function f_a used in the proof of Lemma 3.4.

We now upgrade Lemma 3.4 to verify that we have an A_∞ embedding using an argument similar to the proof of Corollary 4.36 in [Abo09].

Theorem 3.5. *The subcategory of $\mathcal{W}((\mathbb{C}^*)^n, \mathfrak{f}_\Sigma)$ consisting of conical tropical Lagrangian sections is quasi-equivalent to $\mathcal{F}_{\Delta_\varepsilon}^s$.*

Proof. We will establish the quasi-equivalence by relating the categories prior to localization. For a sequence $\{\delta_n\}_{n \in \{0\} \cup \mathbb{N}}$ with δ_0 small, $\delta_{n+1} \in (0, \delta_n/2)$, so that $\delta_n \rightarrow 0$ as $n \rightarrow \infty$, we can construct the conical tropical Lagrangian sections $L^{\delta_n}(D)$ for all toric divisors D on \tilde{X}_Σ so that $L^{\delta_n}(D_1)$ and $L^{\delta_k}(D_2)$ intersect transversely for $k > n$. Note that all of these intersections occur in the fixed compact set V by the assumption that $\delta_{n+1} \in (0, \delta_n/2)$. Clearly, the subcategory $\mathcal{A} \subset \mathcal{W}((\mathbb{C}^*)^n, \mathfrak{f}_\Sigma)$ consisting of the $L^{\delta_0}(D)$ is quasi-equivalent to the subcategory of conical tropical Lagrangian sections. Moreover, by Lemma 3.3, the sequence $L^{\delta_n}(D)$ is cofinal for each toric divisor D . Thus, we can construct \mathcal{A} by localizing the directed category $\mathcal{O}_\mathcal{A}$ whose objects are the pairs $(L^{\delta_n}(D), n)$ and appropriately ordered morphisms are computed with conical almost complex structures. By [Han19, Proposition 3.19], we can assume that $\varepsilon = \delta_0 / \min_D(C_D)$.¹¹ As a consequence, the interpolating tropical Lagrangian sections $L_a^{\delta_n}(D)$ as defined in the proof of Lemma 3.4 are monomially admissible with a large enough so that $u(V) \subset B_a(0)$. Set \mathcal{O}_Δ to be the directed category whose objects are the pairs $(L_a^{\delta_n}(D), n)$ (with large enough a in the sense of the preceding sentence) and appropriately ordered morphisms

$$m^k: CF\left(L_{a_{k-1}}^{\delta_{n_{k-1}}}(D_{k-1}), L_{a_k}^{\delta_{n_k}}(D_k)\right) \otimes \dots \otimes CF\left(L_{a_0}^{\delta_{n_0}}(D_0), L_{a_1}^{\delta_{n_1}}(D_1)\right) \rightarrow CF\left(L_{a_0}^{\delta_0}(D_0), L_{a_k}^{\delta_{n_k}}(D_k)\right)$$

are computed with monomially admissible almost complex structures that are conical on the subset $u^{-1}(B_{\min a_j}(0) \setminus V)$. The localization of \mathcal{O}_Δ at continuation elements is quasi-equivalent to \mathcal{F}_Δ^s . Note that \mathcal{O}_Δ has a “filtration” by subcategories \mathcal{O}_Δ^k whose objects are pairs $(L_a^{\delta_n}(D), n)$ with $a \geq k$. As changes in a are implemented by compactly-supported Hamiltonian isotopies of each object, the inclusion $\mathcal{G}_{k \rightarrow \ell}: \mathcal{O}_\Delta^k \hookrightarrow \mathcal{O}_\Delta^\ell$ for $k \geq \ell$ is a quasi-equivalence with a Floer-theoretically defined inverse $\mathcal{G}_{\ell \rightarrow k}$ taking $(L_a^{\delta_n}(D), n)$ with $a < k$ to $(L_k^{\delta_n}(D), n)$ (see, for example, Section 10a of [Sei08]).

Now, we define a strictly unital functor $\mathcal{F}: \mathcal{O}_\Delta \rightarrow \mathcal{O}_\mathcal{A}$ as follows. On objects, we set

$$\mathcal{F}(L_a^{\delta_n}(D), n) = (L^{\delta_n}(D), n)$$

for all a . For any finite set of objects $L^{\delta_{n_0}}(D_0), \dots, L^{\delta_{n_k}}(D_k)$ with $n_0 > \dots > n_k$, there is an $R > 0$ such that all pseudo-holomorphic disks computing A_∞ structure maps $m_{\mathcal{O}_\mathcal{A}}^j$ with $j \leq k$ on these

¹⁰Choosing $d > \delta/2$ guarantees that these Lagrangians do not intersect near infinity by Eq. (5).

¹¹This minimum is achieved by C_{D_α} for some $\alpha \in A$.

objects in appropriate order are contained in $u^{-1}(B_R(0))$ by the same monotonicity argument as in the proof of Lemma 3.4. In particular, the moduli spaces computing these structure maps are identical to those computing the structure maps $m_{\mathcal{O}_\Delta}^j$ for $j \leq k$ on the objects $L_{a_0}^{\delta_{n_0}}(D_0), \dots, L_{a_k}^{\delta_{n_k}}(D_k)$ for any $a_0, \dots, a_k \geq R$. Thus, for arbitrary a_0, \dots, a_k , we get a well-defined A_∞ -functor by taking

$$\mathcal{F}^k : CF\left(L_{a_{k-1}}^{\delta_{n_{k-1}}}(D_{k-1}), L_{a_k}^{\delta_{n_k}}(D_k)\right) \otimes \dots \otimes CF\left(L_{a_0}^{\delta_{n_0}}(D_0), L_{a_1}^{\delta_{n_1}}(D_1)\right) \rightarrow CF\left(L^{\delta_0}(D_0), L^{\delta_{n_k}}(D_k)\right)$$

to be the composition of the identification $CF\left(L_{a_0}^{\delta_0}(D_0), L_{a_k}^{\delta_{n_k}}(D_{n_k})\right) = CF\left(L^{\delta_0}(D_0), L^{\delta_{n_k}}(D_k)\right)$ with $\mathcal{G}_{\min a_j \rightarrow R}^k$. Moreover, \mathcal{F} is a quasi-equivalence as it induces an isomorphism on cohomology by definition.

To deduce a quasi-equivalence between \mathcal{F}_Δ^s and \mathcal{A} from one between \mathcal{O}_Δ and $\mathcal{O}_\mathcal{A}$, we need to verify that the continuation elements in $H^\bullet \mathcal{O}_\Delta$ are sent to continuation elements in $H^\bullet \mathcal{O}_\mathcal{A}$ (see Proposition 3.39 in [GPS19]). This follows from the fact that the underlying chain complexes are always identical as we have chosen all the interpolation parameters, a_i , to be large enough and hence identifications for small positive isotopies coincide and these identifications characterize continuation elements as in [GPS19, Definition 3.25]. Alternatively, observe that $HF(L^{\delta_{n+k}}(D), L^{\delta_n}(D)) \cong \mathbb{C}$ for all conical tropical Lagrangian sections, and thus localizing at any system of continuation elements (which must be nonzero) gives the same result. \square

It immediately follows from Theorem 2.9 and Theorem 3.5 that the conical tropical Lagrangian sections are mirror to line bundles.

Corollary 3.6. *There is an embedding*

$$\text{Pic}_{\text{dg}}(\check{X}_\Sigma) \hookrightarrow \mathcal{W}((\mathbb{C}^*)^n, \mathfrak{f}_\Sigma)$$

taking a line bundle $\mathcal{O}(D)$ to the conical tropical Lagrangian section $L^\delta(D)$ for small δ .

Remark 3.7. Recall from Section 2.4 that we need to choose a possibly nonstandard Kähler form on $(\mathbb{C}^*)^n$ to ensure that $\mathcal{F}_{\Delta_\varepsilon}^s$ is well-defined. However, $\mathcal{W}((\mathbb{C}^*)^n, \mathfrak{f}_\Sigma)$ does not depend on the holomorphic structure, and the underlying symplectic forms are all the standard form on $T^*\mathbb{R}^n/T_{2\pi\mathbb{Z}}^*\mathbb{R}^n$. Thus, Theorem 3.5 allows us to compute the subcategory of conical tropical Lagrangian sections in $\mathcal{W}((\mathbb{C}^*)^n, \mathfrak{f}_\Sigma)$ without any additional assumptions.

Remark 3.8. From Remark 2.10, we also have an embedding $\mathcal{T}\text{Fuk} \hookrightarrow \mathcal{W}((\mathbb{C}^*)^n, \mathfrak{f}_\Sigma)$ where $\mathcal{T}\text{Fuk}$ is Abouzaid's category of tropical Lagrangian sections from [Abo09] either immediately in the case that $\mathcal{F}_{\Delta_\varepsilon}^s$ is well-defined for the standard Kähler form or by slightly modifying the proof.

Remark 3.9. The construction of conical tropical Lagrangian sections from support functions works for any toric variety \check{X}_Σ , and the wrapping lemma, 3.3, requires only that Σ is complete. However, the Floer-theoretic arguments used to prove Theorem 2.9 require smoothness and projectivity (cf. [Han19, Remark 3.33]).

We end this section with a technical question. In Theorem 6.2, we will show that the image of the embedding from Theorem 3.5 generates. However, we do not show that $\mathcal{F}_{\Delta_\varepsilon}^s$ generates $\mathcal{F}_{\Delta_\varepsilon}$, which would be implied by an embedding $\mathcal{F}_{\Delta_\varepsilon} \hookrightarrow \mathcal{W}((\mathbb{C}^*)^n, \mathfrak{f}_\Sigma)$. Such an embedding is natural to expect due to the highly constrained nature of monomially admissible Lagrangians and the expected duality between partially wrapped and infinitesimally wrapped categories.

Question 3.10. *Is there a more general ‘‘conicalization’’ procedure that produces a conical Lagrangian in $(\mathbb{C}^*)^n \setminus \mathfrak{f}_\Sigma$ from a Lagrangian that is monomially admissible with respect to Δ_ε that preserves Floer theory?*

3.2 Action of conical twisting Hamiltonians

As in the monomially admissible Fukaya-Seidel category, twisting Hamiltonians should act on $\mathcal{W}((\mathbb{C}^*)^n, \mathfrak{f}_\Sigma)$ in addition to giving a construction of tropical Lagrangian sections. The only difficulty in constructing this action is that the flows of conical twisting Hamiltonians do not preserve the stop \mathfrak{f}_Σ , but this can be remedied as follows.

Let D be a toric divisor on \check{X}_Σ and \widehat{H}_D^δ a corresponding conical twisting Hamiltonian. If L is a conical Lagrangian in $(\mathbb{C}^*)^n$ that satisfies¹²

$$|\text{Arg}(z^\alpha|_L)| > \delta \tag{7}$$

in $U_\alpha \setminus V$ for all $\alpha \in A$ where $\{U_\alpha\}$ is the ε -star open cover for Σ , then the third condition of Lemma 3.1 implies that

$$\phi_{D,\delta}^1(L) \cap \mathbb{L}_\Sigma = \emptyset$$

outside of V where $\phi_{D,\delta}^1$ is the time-1 flow of \widehat{H}_D^δ . Thus, if we set

$$\mathfrak{f}_\Sigma^\delta = \{(u, p) \in \partial_\infty(\mathbb{C}^*)^n : |2\pi k - p \cdot \alpha| \leq \delta \text{ for some } k \in \mathbb{Z} \text{ if } u \in U_\alpha\},$$

the objects of $\mathcal{W}((\mathbb{C}^*)^n, \mathfrak{f}_\Sigma^\delta)$ satisfy Eq. (7).¹³ Thus, carefully applying standard techniques (for example, see [Sei08, Section 10b] and [Han19, Section 4.1]), we get a functor

$$\mathcal{F}_D^\delta : \mathcal{W}((\mathbb{C}^*)^n, \mathfrak{f}_\Sigma^\delta) \rightarrow \mathcal{W}((\mathbb{C}^*)^n, \mathfrak{f}_\Sigma)$$

induced by the flow $\phi_{D,\delta}^1$. Since $\mathfrak{f}_\Sigma \subset \mathfrak{f}_\Sigma^\delta$, there is also an inclusion functor

$$\mathcal{W}((\mathbb{C}^*)^n, \mathfrak{f}_\Sigma^\delta) \xrightarrow{\sim} \mathcal{W}((\mathbb{C}^*)^n, \mathfrak{f}_\Sigma)$$

which is an equivalence for small δ because $\mathcal{W}((\mathbb{C}^*)^n, \mathfrak{f}_\Sigma)$ is finitely generated by objects (either linking disks or as we later prove, tropical Lagrangian sections) whose morphisms can be computed in the complement of $\mathfrak{f}_\Sigma^\delta$. As a result, we obtain an autoequivalence \mathcal{F}_D of $\mathcal{W}((\mathbb{C}^*)^n, \mathfrak{f}_\Sigma)$ for each toric divisor D on \check{X}_Σ .

Remark 3.11. The requirement that objects not be too close to the stop in order to define \mathcal{F}_D^δ above is an indication that we need to be careful with wrapping when working with Lagrangian correspondences. We encounter this issue again when working with toric morphisms in Sections 5.2 and 5.3 and explore it in some generality in Appendix D.

When D is an effective divisor, we can also define a natural transformation $T_D : \mathcal{F}_{-D} \rightarrow \text{id}$ as in [Han19, Section 4.2] following [Sei08, Section 10c] and using the following lemma.¹⁴

Lemma 3.12. *If D is an effective toric divisor, the flow ϕ_{-D}^t is everywhere non-negative at infinity.*

Proof. This is a similar (but simpler) calculation to Lemma 3.3. Using the same coordinates and notation, we have

$$X_{\widehat{H}_{-D}^\delta} = (0, \nabla \widehat{H}_{-D}^\delta).$$

¹²Recall that Arg takes values in $[-\pi, \pi)$.

¹³We could also take $\mathfrak{f}_\Sigma^\delta$ to be somewhat smaller because of condition 2 in Lemma 3.1.

¹⁴As we are working in a stopped Liouville domain rather than a Liouville sector, compactness can be obtained by a standard maximum principle argument in the radial coordinate as opposed to careful monotonicity estimates.

Thus, using Eq. (4) and the fact that F_{-D} is piecewise-linear, we have

$$\begin{aligned}\lambda(\partial_t \phi_D^t(u, p)) &= \lambda\left(X_{\widehat{H}_{-D}^\delta}\right) \\ &= 2\pi \int_{\mathbb{R}^n} F_{-D}(u - Rx) \eta_{\varepsilon_{-D}(t)}(x) dx.\end{aligned}$$

However, F_{-D} is non-negative because D is effective. \square

The mirrors of the corresponding functors and natural transformations were computed on $\mathcal{F}_{\Delta_\varepsilon}^s$ in [Han19, Theorems 4.5 and 4.9]. Combining those calculations with our Theorem 6.2, which appears later but does not rely on this section, we obtain the following.

Theorem 3.13. *Under the quasi-equivalence of Corollary D, the functor \mathcal{F}_D corresponds to*

$$- \otimes \mathcal{O}(D) : D_{\text{dg}}^b \text{Coh}(\check{X}_\Sigma) \rightarrow D_{\text{dg}}^b \text{Coh}(\check{X}_\Sigma)$$

and the natural transformation T_D to

$$- \otimes s_D : - \otimes \mathcal{O}(-D) \rightarrow \text{id}$$

where s_D is a defining section of D .

3.3 Cocores

The cotangent fibers of T^*T^n form another natural set of Lagrangian sections in $\mathcal{W}((\mathbb{C}^*)^n, \mathfrak{f}_\Sigma)$. In fact, these are the cocores of the \mathbb{L}_0 components of \mathbb{L}_Σ . Note that while \mathbb{L}_0 is a smooth T^n , the intersections of the FLTZ components with \mathbb{L}_0 subdivide it into a collection of smaller strata. More generally, define the singular locus of the stratum to be $\mathbb{L}_{\Sigma, \perp} := \bigcup_{\substack{\sigma_1, \sigma_2 \in \Sigma \\ \sigma_1 \neq \sigma_2}} \mathbb{L}_{\sigma_1} \cap \mathbb{L}_{\sigma_2}$. We define $\text{Conn}(\Sigma, \sigma) := \{\mathbb{I}_{\sigma; i}\}$ to be the set of connected components of $\mathbb{L}_\sigma \setminus \mathbb{L}_{\Sigma, \perp}$. We call the points $x \in \mathbb{I}_{\sigma; i}$ the internal points of the FLTZ skeleton. Associated to each internal point, we have a linking disk $\mathbf{u}(x)$. If x, x' are in the same connected component, $\mathbb{I}_{\sigma; i}$, then the linking disks $\mathbf{u}(x)$ and $\mathbf{u}(x')$ are isotopic. For our purposes, it will be important to know that these objects in $\mathcal{W}((\mathbb{C}^*)^n, \mathfrak{f}_\Sigma)$ are all represented by conical tropical Lagrangian sections when $\sigma = 0$.

Lemma 3.14. *If $x \in \mathbb{I}_{0; i}$ for some i , then the cocore $\mathbf{u}(x)$ is admissibly Hamiltonian isotopic to a conical tropical Lagrangian section.*

Proof. We lift to $T^*\mathbb{R}^n$ with coordinates (u, p) and write $x = (0, p_o)$ for some p_o such that $\alpha \cdot p_o \notin 2\pi\mathbb{Z}$ for all $\alpha \in A$. Then, for each $\alpha \in A$, there exists $m_\alpha \in \mathbb{Z}$ such that

$$2\pi(m_\alpha - 1) < \alpha \cdot p_o < 2\pi m_\alpha.$$

Let $D = \sum_{\alpha \in A} -m_\alpha D_\alpha$. By Eq. (5), we have

$$2\pi m_\alpha - 2\delta < \nabla H_D^\delta(u) < 2\pi m_\alpha$$

for all $u \in U_\alpha$ near infinity. Thus,

$$2\pi(m_\alpha - 1) \leq 2\pi(m_\alpha - 1) + t(1 - 2\delta) < (1 - t)(p_o \cdot \alpha) + t\nabla \widehat{H}_D^\delta(u) < 2\pi m_\alpha$$

for all $u \in U_\alpha$ near infinity, δ small, and $t \in [0, 1]$ so that

$$L_t = \left(u, tp_o + (1-t)\nabla\widehat{H}_D^\delta(u) \right)$$

gives an admissible Hamiltonian isotopy from $\mathbf{u}(x)$ to the tropical Lagrangian section $L^\delta(D)$ after passing to the quotient $T^*\mathbb{R}^n/T_{2\pi\mathbb{Z}}^*\mathbb{R}^n$. \square

Remark 3.15. One may ask about the Lagrangian “zero” section $L^\delta(0)$. This Lagrangian is not a cocore or linking disk, as it is not contained in the interior of any of the $\mathbb{I}_{\sigma;k}$ strata. Rather, it is something like a linking disk to all FLTZ strata simultaneously. This distinction (that it is not actually a linking disk) will become important in the later discussion of generation and localization (Section 6).

Example 3.16. To illustrate Lemma 3.14, we will characterize these cocores in the example of mirror symmetry for $\mathbb{C}\mathbb{P}^n$. Let Σ_n be the fan for $\mathbb{C}\mathbb{P}^n$ with generators $e_1, \dots, e_n, -e_1 - \dots - e_n$ where e_i are standard basis vectors. Let $\mathbb{L}_0 = T^n$ be the core of the FLTZ skeleton. The decomposition of $\mathbb{L}_0 \subset \mathbb{L}_{\Sigma_n}$ into Lagrangian stratum

$$\mathbb{L}_0 \setminus \bigcup_{\alpha \in A} \mathbb{L}_\alpha$$

has n connected components. Furthermore, the components can be indexed $\mathbb{I}_{0;1}, \dots, \mathbb{I}_{0;n}$ so that the cocore $\mathbf{u}(x_i)$ at $x_i \in \mathbb{I}_{0;i}$ is Hamiltonian isotopic to a tropical section mirror to $\mathcal{O}(-n-1+i)$.

To see this, observe first that

$$\mathbb{L}_0 \setminus \bigcup_{\alpha \in A} \mathbb{L}_\alpha = (0, 2\pi)^n \setminus (H_{\langle 1, \dots, 1 \rangle} + 2\pi\mathbb{Z}^n)$$

where $H_{\langle 1, \dots, 1 \rangle}$ is the plane perpendicular to the $\langle 1, \dots, 1 \rangle$ direction. The $2\pi\mathbb{Z}^n$ translates of this plane intersect the cube $n-1$ times. The n components $\mathbb{I}_{0;i}$ of $(0, 2\pi)^n \setminus (H_{\langle 1, \dots, 1 \rangle} + 2\pi\mathbb{Z}^n)$ can be indexed in the order which they appear in the $e_1 + \dots + e_n$ direction. As a result, the cocore for the stratum $\mathbb{I}_{0;i}$ can be taken at the point

$$2\pi \left(\frac{i-1/2}{n} \right) (e_1 + \dots + e_n) \in T^n.$$

In the proof of Lemma 3.14, we can then take $m_{e_j} = 1$ and $m_{-e_1 - \dots - e_n} = 1-i$ so that D is in the class of $-n-1+i$ times a hyperplane.

We draw examples of these sections in Fig. 7. For simplicity, we use the notation

$$L^\delta(-1) = L^\delta(-D_{e_1} - D_{e_2} + D_{-e_1-e_2})$$

and

$$L^\delta(-2) = L^\delta(-D_{e_1} - D_{e_2})$$

for the two tropical Lagrangian sections Hamiltonian isotopic to $\mathbf{u}(x_1)$ and $\mathbf{u}(x_2)$, respectively. The “zero section” $L^\delta(0)$ has been drawn in Fig. 7a. This corresponds to taking the cotangent fiber above the origin in T^2 and pushing off the stop slightly in the negative direction. In Fig. 7b, notice that wrapping $L^\delta(-1)$ to $L^\delta(0)$ involves passing through several stop components at the origin. Finally, in Fig. 7c we see that there is a positive wrapping from $L^\delta(-2)$ to $L^\delta(-1)$ which passes through a single FLTZ skeleton component. It follows that the mapping cone of $L^\delta(-2) \rightarrow L^\delta(-1)$ is a linking disk to the FLTZ skeleton.

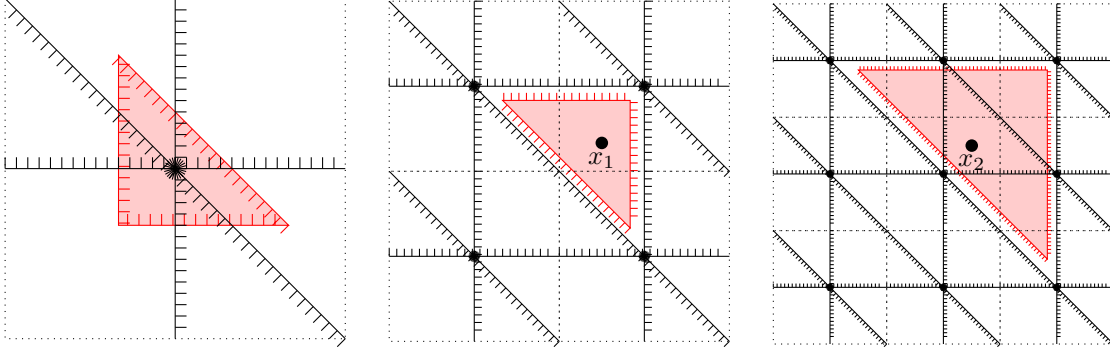

(a) A piecewise linear approximation of the argument projection of the Lagrangian “zero section” $L^\delta(0)$. (b) A piecewise linear approximation of the argument projection of $L^\delta(-1)$ to a cover of T^2 . (c) A piecewise linear approximation of the argument projection of $L^\delta(-2)$ to a cover of T^2 .

Figure 7

The intuition from this example is the basis for the argument generating linking disks in Section 6.1.

We end this section with a characterization of tropical Lagrangian sections Hamiltonian isotopic to cocores.

Lemma 3.17. *Let $D = \sum_{\alpha \in A} m_\alpha D_\alpha$ be a toric divisor. Then $L^\delta(D)$ is Hamiltonian isotopic to a cocore if and only if the set*

$$Q(D) := \bigcap_{\alpha \in A} \{p : 2\pi(m_\alpha - 1) < \alpha \cdot p < 2\pi m_\alpha\}$$

is nonempty for some $p \in M \otimes \mathbb{R}$.

Proof. Suppose that the intersection is nonempty. Then pick some p_0 in the intersection. By Lemma 3.14, we obtain a Hamiltonian isotopy between $L^\delta(D)$ and $\mathfrak{u}((0, p_0))$.

Now suppose that $L^\delta(D)$ is admissibly Hamiltonian isotopic to a $\mathfrak{u}((0, p_0))$. There exists $D' = \sum_{\alpha \in A} m_\alpha D_\alpha$ so that $p_0 \in Q(D')$, and $L^\delta(D)$ is admissibly Hamiltonian isotopic to $\mathfrak{u}((0, p_0))$. By homological mirror symmetry (Corollary 3.6), D and D' are linearly equivalent. The sets $Q(D)$ and $Q(D')$ are then related by a linear transformation; in particular, $Q(D)$ is non-empty. \square

4 Mirror to a toric divisor

We now fix an n -dimensional toric variety \check{X}_Σ and its mirror space $(X = (\mathbb{C}^*)^n, \mathfrak{f}_\Sigma)$. We construct a Lagrangian submanifold $L_{\alpha > 0} \subset (X, \mathfrak{f}_\Sigma)$ which is mirror to the structure sheaf of a toric divisor $\mathcal{O}_{\alpha > 0}$. This is a warm-up for the next section, where we will construct a Lagrangian correspondence $L_{\alpha 0} : (X_2, \mathfrak{f}_{\text{star}(\alpha)/\alpha}) \Rightarrow (X_1, \mathfrak{f}_\Sigma)$ mirror to the inclusion $i_{\alpha 0} : \check{X}_{\text{star}(\alpha)/\alpha} \rightarrow \check{X}_\Sigma$. The later construction will recover $L_{\alpha > 0}$ as a special case by taking pushforward of the mirror to the structure sheaf,

$$L_{\alpha > 0} = L_{\alpha 0} \circ L_\alpha(0).$$

4.1 The mirror Lagrangian

The Lagrangian submanifold $L_{\alpha>0}$ is constructed in a similar fashion to the tropical Lagrangian submanifolds considered in [Hic20]. Given a tropical polynomial¹⁵ $F : Q \rightarrow \mathbb{R}$, the tropical Lagrangian submanifold L_F was constructed by taking two monomially admissible sections of an SYZ fibration and surgering them along their common overlap. Since the overlap approximates the complement of the tropical locus of F , the image $u(L_F)$ is contained in a small neighborhood of the tropical locus of F . The constructed tropical Lagrangian submanifold is monomially admissible and mirror to a sheaf supported on a complex hypersurface with matching tropicalization. Our current goal is to construct the mirror to a toric divisor by the same technique.

Theorem 4.1 (Mirror to a toric divisor). *Let Σ be a smooth fan, and let $\alpha \in A$ generate a 1-dimensional cone.*

- (Definition 4.4) *There exists an admissible Lagrangian disk $L_{\alpha>0}(0) \subset (X, \mathfrak{f}_\Sigma)$, along with a Lagrangian cobordism:*

$$K_\alpha : (L_0(F_\alpha), L_0(0)) \rightsquigarrow L_{\alpha>0}(0).$$

- (Proposition 4.5) *Under the mirror quasi-equivalence from Corollary 3.6, $L_{\alpha>0}(0)$ is mirror to a toric divisor $\mathcal{O}_D(0) \subset \check{X}_\Sigma$.*
- (Proposition 4.6) *In the complement of a compact set $X^{int} \subset X$*

$$(u(L_{\alpha>0}(0) \setminus X^{int})) \subset \text{star}(\alpha).$$

There are some differences between our construction of the mirror to a toric divisor and the construction of tropical Lagrangian submanifolds from [Hic20]. A toric divisor does not tropicalize, and thus the valuation of the Lagrangian we construct will not approximate the tropicalization of D ; instead, the Lagrangian we build is Hamiltonian displaceable from all SYZ fibers. The Lagrangian sections considered for tropical Lagrangian submanifolds came from tropical polynomials $F : Q \rightarrow \mathbb{R}$. These are convex, and thus represent sections of base-point free divisors. As toric divisors are not necessarily ample or base-point free, the support function F_α need not be convex. Finally, we will work in the conically admissible setting rather than the monomially admissible one; as the definition of a conically admissible Lagrangian section is a bit messier than the monomially admissible section, we will have to do a bit of additional book-keeping to obtain surgery data similar to that used in [Hic20].

Let $\alpha \in A$ be a cone, to which we can associate the divisor $-D_\alpha$, the support function F_α , and the Lagrangian section $L^\delta(F_\alpha) = L^\delta(-D_\alpha) \subset (X, \mathfrak{f}_\Sigma)$. We will always use the same δ between all Lagrangians, and therefore drop the superscript δ . We would like to apply Lagrangian surgery to the sections $L(F_\alpha)$ and $L(0)$. If the function F_α is convex, it immediately follows that the intersection of $L_0(F_\alpha)$ with $L_0(0)$ satisfies the conditions of Definition A.4. Generally, this need not be the case; consider the example of the toric blowup of $\mathbb{C}\mathbb{P}^2$ at a point, whose fan has generators $A = \{e_1, e_2, e_1 + e_2, -e_1 - e_2\}$. Let $\alpha = e_1 + e_2$ so that the divisor D_α is the exceptional divisor of the blow-up of $\mathbb{C}\mathbb{P}^2$, which is a (-1)-curve. The support function F_α , whose contour sets are drawn in Fig. 9a, fails to be convex. However, F_α satisfies a property which can be used as a substitute for convexity, which is that when restricted along an α -parallel ray going through a fixed point q ,

$$F_\alpha(q + t \cdot \alpha) = \max(0, (t - t_0))$$

¹⁵Tropical polynomials are piecewise affine convex, as opposed to support functions which are piecewise linear.

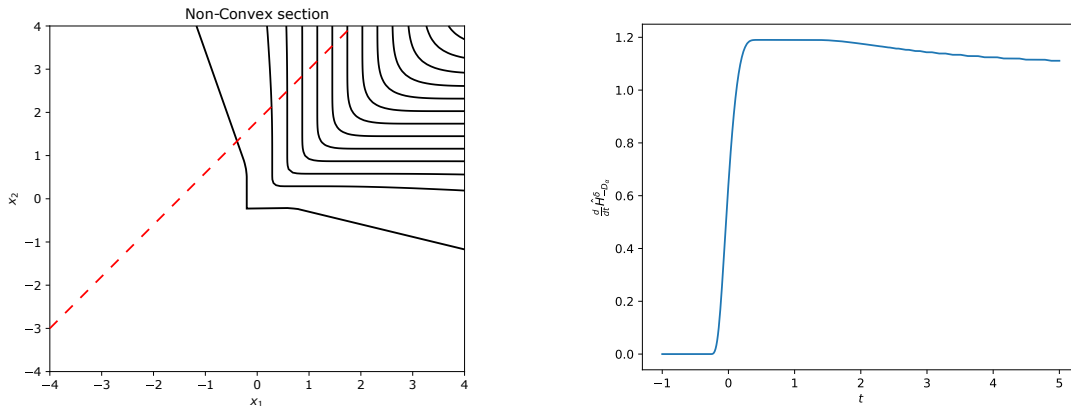

(a) The smoothing of a non-convex F_α . Here, D_α is the exceptional divisor of the blow-up of $\mathbb{C}\mathbb{P}^2$ at a point. Note that there is a neighborhood of the ray α where this is non-convex. The dotted line parameterizes $q + t \cdot \alpha$, along which we slice function.

(b) The graph of $\frac{d}{dt} \widehat{H}_\alpha^\delta(q + t \cdot \alpha)$, where $\alpha = e_1 + e_2$. The dotted portion of the domain represents an interval where we expect $\widehat{H}_\alpha^\delta(q + t \cdot \alpha)$ to be convex. There is only a slight amount of non-convexity, which occurs when $q + t \cdot \alpha$ enters the $\varepsilon|r|$ cone of α .

Figure 8. How we work with tropical sections when F_α is non-convex.

for some t_0 . Having convex slices along the α -parallel rays also implies the existence of a surgery data (Definition A.4).

The Lagrangian section $L(F_\alpha)$ is obtained by smoothing F_α with a variable radius smoothing kernel. Unfortunately, the slices of the resulting smoothing, $\widehat{H}_\alpha^\delta(q + t \cdot \alpha)$, will generally not be convex. See, for example, Fig. 8 which plots the slice $\frac{d}{dt} \widehat{H}_\alpha^\delta(q + t \cdot \alpha)$ where α is the exceptional divisor of the one point blow-up above. Note that for small values of t the slice $\frac{d}{dt} \widehat{H}_\alpha^\delta(q + t \cdot \alpha)$ approximates a smoothing of the step function — which would be increasing. However, at large t the function becomes concave as the radius of smoothing kernel for $\widehat{H}_\alpha^\delta$ increases to the point where it intersects the non-convexity locus of F_α .

Ultimately, this is not too problematic as the non-convexity of $\widehat{H}_\alpha^\delta(q + t \cdot \alpha)$ occurs away from where $L(F_\alpha)$ and $L(0)$ intersect. Without loss of generality, we can assume that in the description of the slice, we choose the point q so that $F_\alpha(q) = 0$ and q is on the locus of non-linearity; equivalently, q belongs to the boundary of $\text{star}(\alpha)$. With this choice of q ,

$$F_\alpha(q + t \cdot \alpha) = \max(0, t).$$

Lemma 4.2. *Slices of $\widehat{H}_\alpha^\delta$ in the α direction are increasing, so that $\frac{d}{dt} \widehat{H}_\alpha^\delta(q + t \cdot \alpha) \geq 0$. Furthermore, the set on which $d\widehat{H}_\alpha^\delta = 0$ is exactly the locus where $\widehat{H}_\alpha^\delta = 0$.*

Before we prove this lemma, we would like to state that if we additionally assume that F_α is convex, then $\widehat{H}_\alpha^\delta(q + t \cdot \alpha)$ is convex. The proof in this setting is also dramatically simpler.

Proof. We first show that $\frac{d}{dt} \widehat{H}_\alpha^\delta(q + t \cdot \alpha) \geq 0$. Recall that $\eta_t(q) = \frac{1}{t^n} \eta\left(\frac{q}{t}\right)$. Take $\rho : \mathbb{R}_{\geq 0} \rightarrow \mathbb{R}$ a smooth function which convexly interpolates between the following two domains of definition:

$$\rho(t) = 1 \text{ if } t < 1 \qquad \rho(t) = \varepsilon t \text{ if } t \gg 1$$

The function $\widehat{H}_\alpha^\delta$ is defined by smoothing the function F_α with a variable radius smoothing kernel $\eta_{\rho(|q|)}$. Let $A(t) = \rho(|q + t \cdot \alpha|)$, which has the property that $A'(t) < |\alpha|\varepsilon$. Mimicking the argument of Lemma 3.3:

$$\begin{aligned} \frac{1}{2\pi} \frac{d}{dt} \widehat{H}_\alpha^\delta(q + t \cdot \alpha) &= \frac{d}{dt} \int_{\mathbb{R}^n} F_\alpha(q + t \cdot \alpha - x) \cdot \eta_A(x) dx \\ &= \frac{d}{dt} \int_{\mathbb{R}^n} F_\alpha(q + t\alpha - A(t)x) \eta(x) dx \\ &= \int_{\mathbb{R}^n} \nabla F_\alpha(q + t\alpha - A(t)x) \cdot (\alpha - A'(t)x) \eta(x) dx \\ &= \int_{\mathbb{R}^n} ((\chi_{\text{star}(\alpha)}(q + t\alpha - A(t)x)) - A'(t) (\nabla F_\alpha(q + t\alpha - A(t)x) \cdot x)) \cdot \eta(x) dx \end{aligned}$$

Since $-\nabla F_\alpha(q + t\alpha - A(t)x)$ is supported on $\text{star}(\alpha)$

$$= \int_{\mathbb{R}^n} ((\chi_{\text{star}(\alpha)}(q + t\alpha - A(t)x)) \cdot (1 - A'(t) (\nabla F_\alpha(q + t\alpha - A(t)x) \cdot x))) \cdot \eta(x) dx$$

Here $\chi_{\text{star}(\alpha)}$ is the characteristic function for the star of α . It suffices to show that $A'(t)\nabla F_\alpha(q + t\alpha - A(t)x)$ is sufficiently small.¹⁶ Since $\eta(x)$ has bounded support, we are only integrating over $x \in B_1(0)$. Therefore, the absolute value of $\nabla F_\alpha(q + t\alpha - A(t)x) \cdot x \eta(x)$ is bounded by the maximal norm of ∇F_α . It follows that

$$\begin{aligned} \left| A'(t) \int_{\mathbb{R}^n} \nabla F_\alpha(q + t\alpha - A(t)x) \cdot x \eta(x) dx \right| &\leq |A'(t)| \int_{B_1(0)} |\nabla F_\alpha(q + t\alpha - A(t)x) \cdot x| dx \\ &\leq |A'(t)| \cdot \text{Vol}(B_1(0)) \cdot \max_{q \in \mathbb{R}^n} \|\nabla F_\alpha(q)\|. \end{aligned}$$

Since $A'(t) < \varepsilon\|\alpha\|$, and ε can be chosen as small as desired, this quantity is as small as desired. We therefore conclude that $\frac{d}{dt} \widehat{H}_\alpha^\delta(q + t \cdot \alpha) \geq 0$. Because the support of $\frac{d}{dt} \widehat{H}_\alpha^\delta(q + t \cdot \alpha)$ matches the support of $\widehat{H}_\alpha^\delta(q + t \cdot \alpha)$, we can also conclude from this computation that $d\widehat{H}_\alpha^\delta = 0$ if and only if $\widehat{H}_\alpha^\delta = 0$. \square

It will also be useful to think of this in the following way:

Corollary 4.3. *For $C > 0$, we can parameterize the level set $\widehat{H}_\alpha^\delta = C$ by $\mathfrak{i} : \mathcal{Q}_{\text{star}(\alpha)/\alpha} \rightarrow \mathcal{Q}_{\text{star}(\alpha)}$, which is a smooth section¹⁷ of the projection $\pi_\alpha : \mathcal{Q}_{\text{star}(\alpha)} \rightarrow \mathcal{Q}_{\text{star}(\alpha)/\alpha}$.*

The locus where $d\widehat{H}_\alpha^\delta = 0$ is highlighted in Fig. 9a. By Lemma 4.2, there exists a surgery data (Definition A.4) for the Lagrangians $L_0(F_\alpha)$ and $L_0(0)$, with surgery region $U_{\widehat{H}_\alpha^\delta}$ defined to be the locus where $\widehat{H}_\alpha^\delta \leq \rho c_\varepsilon$. Here, $\rho : X \rightarrow \mathbb{R}$ is a function which increases in the symplectization coordinate and c_ε is a constant, both defined in the proof of Proposition A.5. Proposition A.5 constructs for us an admissible surgery of these two sections.

¹⁶We use this footnote to point out that in the monomial admissible setting, the radius of the smoothing kernel has no dependence on q and the last term vanishes.

¹⁷Regarding the unusual choice of notation: $\mathfrak{i} : \mathcal{Q}_{\text{star}(\alpha)/\alpha} \rightarrow \mathcal{Q}_{\text{star}(\alpha)}$ is not a piecewise linear function, but it is a smooth approximation of the PL parameterization of $\partial(\text{star}(\alpha)) + C\alpha$.

Definition 4.4. The mirror to the divisor D_α is the Lagrangian submanifold

$$L_{\alpha>0}(0) := L_0(F_\alpha) \#_{U_{\widehat{H}_\alpha^\delta}} L_0(0).$$

which comes with an exact Lagrangian surgery cobordism

$$K_\alpha : (L_0(F_\alpha), L_0(0)) \rightsquigarrow L_{\alpha>0}(0).$$

We will now justify the name in Proposition 4.5. The surgery of $L_0(F_\alpha)$ and $L_0(0)$ is homotopic to gluing them along their boundary. Since these are both disks, the Lagrangian surgery cobordism K_α has the topology of a disk. It follows that both K_α and $L_{\alpha>0}$ are exact Lagrangian submanifolds. In addition, Proposition A.5 guarantees admissibility of these Lagrangian submanifolds.

Proposition 4.5. *The Lagrangian $L_{\alpha>0}(0)$ is mirror to $\mathcal{O}_{\alpha>0}(0)$.*

Proof. By Theorem A.3, there exists an exact triangle in the Fukaya category,

$$L_0(F_\alpha) \xrightarrow{a} L_0(0) \xrightarrow{b} L_{\alpha>0}(0).$$

Under Corollary 3.6, this is identified with an exact sequence:

$$\mathcal{O}_{\widehat{X}_\Sigma}(F_\alpha) \rightarrow \mathcal{O}_{\widehat{X}_\Sigma} \rightarrow \mathcal{O}_D(0)$$

where $\mathcal{O}_{\widehat{X}_\Sigma}(-D) = \mathcal{O}_{F_\alpha}$. Before we identify a , we note that the exact triangle determines D up to linear equivalence. Furthermore, since $L_{\alpha>0}$ is disjoint from every SYZ fiber, it must be mirror to a toric divisor.

The morphism a can be identified up to a scalar as a certain continuation element. The Floer complex $HF^\bullet(L_0(F_\alpha), L_0(F_\alpha))$ has a single generator in degree zero, which we call e . The continuation element a is the image of e under the continuation map

$$\Phi : HF^\bullet(L_0(F_\alpha), L_0(F_\alpha)) \rightarrow HF^\bullet(L_0(F_\alpha), L_0(0)).$$

Note that we only identify this intersection between $L_0(F_\alpha)$ and $L_0(0)$ by choosing a support function F_α which determines the continuation Hamiltonian. The support function also identifies a as the intersection corresponding to the minimum (after possibly simplifying H_K^δ to have a unique minimum) of $\widehat{H}_\alpha^\delta$. Since we are surgering at a single intersection region, we can use [Hic20, Proposition 4.27] to identify this surgery with the mapping cone at this intersection as in [Fuk+07].

It remains to identify the morphism a under Corollary D. However, a is simply the leading order term of the natural transformation in Theorem 3.13 and thus is a defining section of D_α . \square

Proposition 4.6. *Outside of a compact set X^{int} , $u(L_{\alpha>0} \setminus X^{int}) \subset \text{star}(\alpha)$.*

Proof. $L_{\alpha>0}$ is constructed by surgering away the overlap of $L_0(F_\alpha)$ and $L_0(0)$. These are both SYZ sections, and the surgery region is where $\widehat{H}_\alpha^\delta \leq \rho c_\varepsilon$. The remaining region, where $\widehat{H}_\alpha^\delta \geq \rho c_\varepsilon$, lies in a small conical neighborhood of where $F_\alpha > \rho c_\varepsilon$, which is a subset of $\text{star}(\alpha)$ (see Fig. 9b). \square

This last property — that the valuation projection of this Lagrangian is contained within the star of α — should be compared to [Hic20, Proposition 3.1], which shows that the valuation projection of a tropical Lagrangian submanifold lives in a small neighborhood of the defining tropical subvariety. One should interpret $\text{star}(\alpha) \subset Q$ as a best attempt at tropicalizing the divisor $D_\alpha \subset X_\Sigma$.

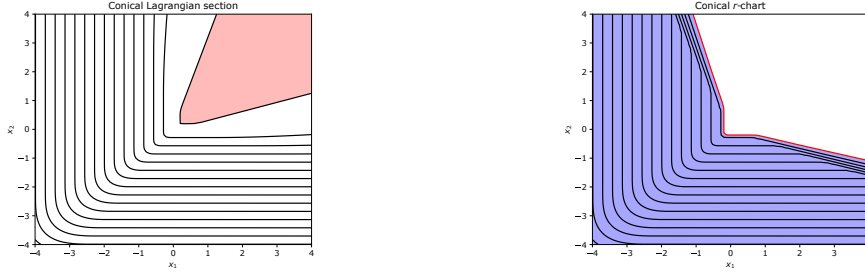

(a) The conical Lagrangian section, associated to $F_{-e_1-e_2}$ for $\mathbb{C}\mathbb{P}^2$ with region of intersection with the zero section highlighted in red.

(b) The valuation post-surgery. Note that $u(L_{\alpha>0})$ is contained within $\text{star}(\alpha)$ outside of a compact set. The image of $i : Q_1 \rightarrow Q_2$ is the red line.

Figure 9. Valuation of overlap region and resulting surgery.

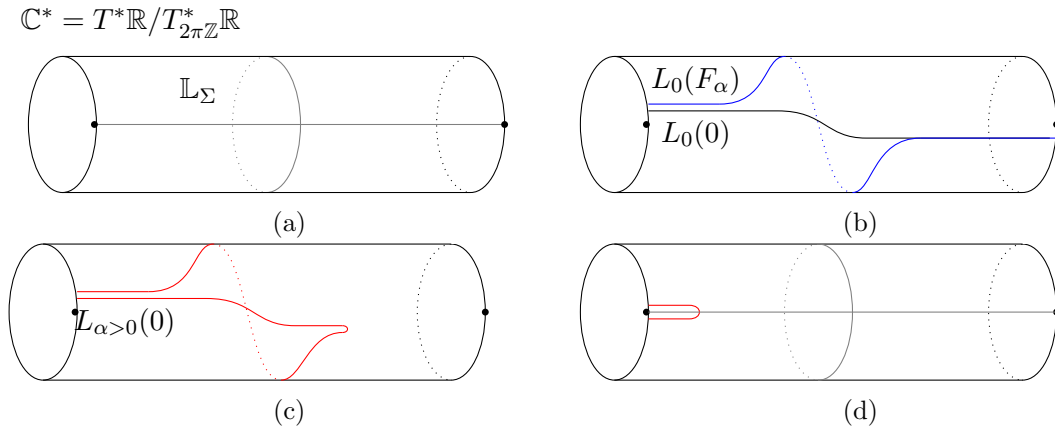

Figure 10. The surgery procedure for the mirror to $\mathbb{C}\mathbb{P}^1$.

4.2 Example: Toric divisors of $\mathbb{C}\mathbb{P}^1$

The construction of the mirror to a toric divisor can be drawn out for $\check{X}_\Sigma = \mathbb{C}\mathbb{P}^1$. The fan for $\mathbb{C}\mathbb{P}^1$ has two 1-dimensional cones. We label the generators as $A = \{\alpha = -e_1, \beta = e_1\}$. The stop \mathfrak{f}_Σ is a point on each of the 2 contact boundaries. The skeleton \mathbb{L}_Σ has three components (indexed by the cones of the fan) and is the union of the unit circle and the real axis as shown in Fig. 10a. With our choice of push-off, the Lagrangian zero section is the black curve drawn in Fig. 10b, which is nearly wrapped to the stop.

We consider the ray α and $L_0(F_\alpha)$. This Lagrangian section intersects \mathbb{L}_0 . We then wrap from $L_0(0)$ to $L_0(F_\alpha)$ by translating the left end nearly a full rotation and leaving the right end fixed. The surgery of $L_0(F_\alpha)$ and $L_0(0)$, drawn in Fig. 10c, removes the overlap on the right hand side of the figure. As a result, the surgery is disjoint from the skeleton components on the right-hand side. In this particular example, we can take a further Hamiltonian isotopy to identify $L_{\alpha>0}$ with a linking disk living in a neighborhood of \mathbb{L}_α (Fig. 10d). Generally this is not the case, and in Remark 5.22, we discuss what is special about the example of $\mathbb{C}\mathbb{P}^1$.

5 Inclusion of a toric divisor

In Section 4, we showed that the Lagrangian $L_{\alpha>0}$ is mirror to $\mathcal{O}_{\alpha>0}$. On the B -side, one can construct $\mathcal{O}_{\alpha>0}$ as the pushforward of a line bundle along the inclusion $\check{i}_{\alpha 0} : \check{X}_{\text{star}(\alpha)/\alpha} \rightarrow \check{X}_\Sigma$. The goal of this section is to construct the mirror to this inclusion, thereby extending the previous discussion to line bundles supported on any toric stratum.

The mirror relation between A - and B -model morphisms is understood by representing a morphism of symplectic or complex manifolds by the submanifold in the product equal to the graph of the morphism. Given a morphism $\check{f} : \check{X}_1 \rightarrow \check{X}_2$, the graph is a subvariety $\Gamma(\check{f}) \subset \check{X}_1 \times \check{X}_2$. Similarly, given a symplectomorphism $f : X_1 \rightarrow X_2$, the graph is a Lagrangian submanifold $\Gamma(f) \subset X_1^- \times X_2$, where X_1^- is equipped with its negative symplectic form. We expect that maps f, \check{f} are mirror if the Lagrangian $\Gamma(f)$ is mirror to the sheaf $\mathcal{O}_{\Gamma(\check{f})}$. More generally, the appropriate set of morphisms between symplectic manifolds are *Lagrangian correspondences*. We refer to Appendix D for the definition of Lagrangian correspondences in the partially wrapped setting. Lagrangian correspondences are predicted to give functors between the Fukaya category of X_1 and X_2 via geometric composition. The expected mirrors to Lagrangian correspondences are *Fourier-Mukai kernels*, which are coherent sheaves on $\check{X}_1 \times \check{X}_2$ that provide a functor between the derived category of coherent sheaves via the associated Fourier-Mukai transform.

From here on, we will fix a complete smooth projective fan Σ of dimension n . Let $\alpha \in \Sigma$ be a 1-dimensional cone, and let $\check{i}_{\alpha 0} : \check{X}_{\text{star}(\alpha)/\alpha} \rightarrow \check{X}_\Sigma$ be the inclusion of the toric orbit closure into \check{X}_Σ . $\check{X}_{\text{star}(\alpha)/\alpha}$ is a toric variety as well, and our goal for this section is to describe a Lagrangian correspondence $L_{\alpha 0} : ((\mathbb{C}^*)^{n-1}, \mathfrak{f}_{\text{star}(\alpha)/\alpha}) \Rightarrow ((\mathbb{C}^*)^n, \mathfrak{f}_\Sigma)$ which is mirror to $\mathcal{O}_{\Gamma(\check{i}_{\alpha 0})} \in D^b \text{Coh}(\check{X}_{\text{star}(\alpha)/\alpha} \times \check{X}_\Sigma)$. We will also describe how this correspondence acts on Lagrangian sections and linking disks. We write $L_\sigma(F)$ for a conical tropical Lagrangian section of $((\mathbb{C}^*)^{n-k}, \mathfrak{f}_{\text{star}(\sigma)/\sigma})$, and we will write $L_{\tau>\sigma}$ for a linking disk of the $\mathbb{L}_{\tau/\sigma}$ component of the $\mathbb{L}_{\text{star}(\sigma)/\sigma}$ skeleton. We now summarize the construction and results of this section in a theorem.

Theorem 5.1. *Let $\alpha \in \Sigma$ be a 1-dimensional cone. There exists a toric inclusion Lagrangian correspondence (Definition 5.13)*

$$L_{\alpha 0} : ((\mathbb{C}^*)^{n-1}, \mathfrak{f}_{\text{star}(\alpha)/\alpha}) \Rightarrow ((\mathbb{C}^*)^n, \mathfrak{f}_\Sigma)$$

which satisfies the following properties:

- (Proposition 5.15) $L_{\alpha 0}$ and $L_{\alpha 0}^{-1}$ are admissible Lagrangian correspondences.
- (Proposition 5.16) If $L \subset ((\mathbb{C}^*)^{n-1}, \mathfrak{f}_{\text{star}(\alpha)/\alpha})$ is an admissible Lagrangian, the geometric composition $L_{\alpha 0} \circ L$ is topologically $L \times \mathbb{R}$.
- (Corollary 5.11 and Proposition 5.18) Let $F \in \text{Supp}_\alpha(\Sigma)$ be a support function transverse to α . The inclusion correspondence relates tropical Lagrangian sections

$$L_\alpha(\check{i}_{\alpha 0}^* F) \in \mathcal{W}((\mathbb{C}^*)^{n-1}, \mathfrak{f}_{\text{star}(\alpha)/\alpha})$$

and $L_0(F) \in \mathcal{W}((\mathbb{C}^*)^n, \mathfrak{f}_\Sigma)$ by

$$L_{\alpha 0}^{-1} \circ (L_0(F)) = L_\alpha(\check{i}_{\alpha 0}^* F).$$

- (Proposition 5.19) There exists an admissible Lagrangian cobordism (Definition A.1)

$$(L_0(F + F_\alpha), L_0(F)) \rightsquigarrow L_{\alpha 0} \circ L_\alpha(\check{i}_{\alpha 0}^* F) = L_{\alpha > 0}(\check{i}_{\alpha 0}^* F).$$

The topology of this cobordism is a disk.

- (Proposition 5.21) Let $\sigma > \alpha$ be a cone. Let $x \in \mathbb{L}_{\check{i}_{\alpha 0}^* \sigma} \subset \mathbb{L}_{\text{star}(\alpha)/\alpha}$ be an internal point, giving us a linking disk $\mathbf{u}(x)$. Then $L_{\alpha 0} \circ \mathbf{u}(x)$ is a linking disk for $\mathbb{L}_\sigma \subset \mathbb{L}_\Sigma$.

Remark 5.2. The Lagrangian correspondence $L_{\alpha 0} : ((\mathbb{C}^*)^{n-1}, \mathfrak{f}_{\text{star}(\alpha)/\alpha}) \Rightarrow ((\mathbb{C}^*)^n, \mathfrak{f}_\Sigma)$ is expected to give a functor between $\mathcal{W}((\mathbb{C}^*)^{n-1}, \mathfrak{f}_{\text{star}(\alpha)/\alpha}) \rightarrow \mathcal{W}((\mathbb{C}^*)^n, \mathfrak{f}_\Sigma)$. We now give an argument for why if such functors (as considered by [WW07]) can be constructed for Lagrangian correspondences between stopped Liouville domains, then the functor arising from $L_{\alpha 0}$ is mirror to the derived pushforward $(\check{i}_{\alpha 0})_* : D^b \text{Coh}(\check{X}_{\text{star}(\alpha)/\alpha}) \rightarrow D^b \text{Coh}(\check{X}_\Sigma)$. By Theorem 6.2, the partially wrapped Fukaya categories in discussion are generated by Lagrangian sections, and geometric composition with $L_{\alpha 0}$ maps generators to generators in a way consistent with the mirror functor. This shows that $L_{\alpha 0}$ gives a homomorphism between the Grothendieck groups $K_0(\mathcal{W}((\mathbb{C}^*)^{n-1}, \mathfrak{f}_{\text{star}(\alpha)/\alpha})) \rightarrow K_0(\mathcal{W}((\mathbb{C}^*)^n, \mathfrak{f}_\Sigma))$, which is mirror to the corresponding map on the mirror. In addition to knowing how $L_{\alpha 0}$ acts on Lagrangian sections, we know that $L_{\alpha 0}$ maps linking disks to linking disks in a way consistent with mirror symmetry. We now sketch why this implies that an extension of $L_{\alpha 0}$ to a functor will be mirror to $\mathcal{R}(\check{i}_{\alpha 0})_*$.

Since $\mathcal{W}((\mathbb{C}^*)^{n-1}, \mathfrak{f}_{\text{star}(\alpha)/\alpha})$ and $\mathcal{W}((\mathbb{C}^*)^n, \mathfrak{f}_\Sigma)$ are generated by Lagrangian sections, it suffices to check that this correspondence acts appropriately on homomorphisms between Lagrangian sections. In fact, we need only compute $HF^\bullet(L_\alpha(0), L_\alpha(F))$, with $-D_F$ base-point free. In this setting, a generating set for $CF^\bullet(L_\alpha(0), L_\alpha(F))$ is given by morphisms f_v , where $v \in \Delta_F$ is a lattice point contained in the Newton polytope of F . These morphisms are characterized by the short exact sequences

$$L_\alpha(0) \xrightarrow{f_v} L_\alpha(F) \rightarrow \bigoplus_{\substack{\sigma_i > \alpha \\ |\sigma| = |\alpha + 1|}} L_{\sigma_i > \alpha}$$

for some collection of Lagrangian disks $L_{\sigma_i > \alpha}$ with $|\sigma_i| = |\alpha + 1|$. Because $L_{\alpha 0}$ is a triangulated functor which sends mirrors to toric strata to mirror to toric strata, we can conclude that $L_{\alpha 0}$ is mirror to $\check{i}_{\alpha 0}$.

In this case, we can also conclude that the functor associated to geometric composition with $L_{\alpha 0}^{-1}$ is the mirror to derived pullback $\mathcal{L}i^* : D^b \text{Coh}(\check{X}_\Sigma) \rightarrow D^b \text{Coh}(\check{X}_{\text{star}(\alpha)/\alpha})$ by adjunction. We expect that a similar strategy will yield a mirror symmetry statement for the Lagrangian correspondences defined from the data of a toric morphism in Definition 5.6.

5.1 Construction of $\check{i}_{\alpha 0}$: On the B -side

We now outline a construction of the structure sheaf of the graph of $\check{i}_{\alpha 0} : \check{X}_{\text{star}(\alpha)/\alpha} \rightarrow \check{X}_\Sigma$ which is the Fourier-Mukai kernel giving the map $(R\check{i}_{\alpha 0})_* : D^b \text{Coh}(\check{X}_{\text{star}(\alpha)/\alpha}) \rightarrow D^b \text{Coh}(\check{X}_\Sigma)$. This exposition serves as a template for our symplectic arguments. The tools that we use to build $\mathcal{O}_{\Gamma(\check{i}_{\alpha 0})}$ will be restricted to inclusion of toric subvarieties, tensor products with line bundles, mapping cones, and composition of Fourier-Mukai kernels. Restricting ourselves to these methods gives a roundabout path to constructing $\mathcal{O}_{\Gamma(\check{i}_{\alpha 0})}$, but one which we can replicate on the A -side.

Our first step is to factor the inclusion $\check{i}_{\alpha 0}$ as

$$\check{X}_{\text{star}(\alpha)/\alpha} \hookrightarrow \check{X}_{\text{star}(\alpha)} \hookrightarrow \check{X}_\Sigma$$

The map $\check{i}_{\text{star}(\alpha), 0} : \check{X}_{\text{star}(\alpha)} \hookrightarrow \check{X}_\Sigma$ is a toric morphism. While the map $\check{i}_{\alpha, \text{star}(\alpha)} : \check{X}_{\text{star}(\alpha)/\alpha} \hookrightarrow \check{X}_{\text{star}(\alpha)}$ is not toric, there is a toric morphism $\tilde{\pi}_{\text{star}(\alpha), \alpha} : \check{X}_{\text{star}(\alpha)} \rightarrow \check{X}_{\text{star}(\alpha)/\alpha}$. The structure sheaf of the graph $\mathcal{O}_{\Gamma(\tilde{\pi}_{\text{star}(\alpha), \alpha})} \in \text{Sh}(\check{X}_{\text{star}(\alpha)/\alpha} \times \check{X}_{\text{star}(\alpha)})$ is a toric subvariety.¹⁸ The line bundle $\mathcal{O}_{\text{star}(\alpha)}(F_\alpha)$ on $\check{X}_{\text{star}(\alpha)}$ pulls back to a line bundle on $\check{X}_{\text{star}(\alpha)/\alpha} \times \check{X}_{\text{star}(\alpha)}$. There exists an exact sequence of sheaves in $\check{X}_{\text{star}(\alpha)/\alpha} \times \check{X}_{\text{star}(\alpha)}$

$$\left(\mathcal{O}_{\Gamma(\tilde{\pi}_{\text{star}(\alpha), \alpha})} \otimes \mathcal{O}_{\text{star}(\alpha)}(F_\alpha) \right) \rightarrow \left(\mathcal{O}_{\Gamma(\tilde{\pi}_{\text{star}(\alpha), \alpha})} \right) \rightarrow \left(\mathcal{O}_{\Gamma(\check{i}_{\alpha, \text{star}(\alpha)})} \right). \quad (8)$$

Finally, we obtain the Fourier-Mukai kernel of $\check{i}_{\alpha 0} : \check{X}_{\text{star}(\alpha)/\alpha} \rightarrow \check{X}_\Sigma$ by the composition:

$$\mathcal{O}_{\Gamma(\check{i}_{\alpha 0})} = \mathcal{O}_{\Gamma(\check{i}_{\text{star}(\alpha), 0})} \circ \mathcal{O}_{\Gamma(\check{i}_{\alpha, \text{star}(\alpha)})}.$$

We now discuss the properties of the associated Fourier-Mukai transform. Let $F \in \text{Supp}_\alpha(\Sigma)$ be a support function transverse to α . First, we observe that this transform intertwines pullbacks for line bundles and the linear pullback of support functions:

$$\check{i}_{\alpha 0}^* \mathcal{O}_0(F) = \mathcal{O}_\alpha(\check{i}_{\alpha 0}^* F). \quad (\text{Mirror to Proposition 5.18})$$

Additionally, there is an exact triangle

$$\mathcal{O}_0(F + F_\alpha) \rightarrow \mathcal{O}_0(F) \rightarrow \mathcal{O}_{\alpha > 0}(\check{i}_{\alpha 0}^* F). \quad (\text{Mirror to Proposition 5.19})$$

Finally, we remark that the inclusion of toric orbit is again a toric orbit, that is if $\sigma > \alpha$, then

$$(\check{i}_{\alpha 0})_* \mathcal{O}_{\sigma > \alpha} = \mathcal{O}_{\sigma > 0}. \quad (9)$$

¹⁸We note that this is not a Fourier-Mukai kernel for the derived category between $\check{X}_{\text{star}(\alpha)/\alpha}$ and $\check{X}_{\text{star}(\alpha)}$, as the projection $\tilde{\pi}_{\text{star}(\alpha), \alpha} : \check{X}_{\text{star}(\alpha)} \rightarrow \check{X}_{\text{star}(\alpha)/\alpha}$ is not proper, so it does not give a map of coherent sheaves.

5.2 Lagrangian correspondences from toric morphisms

We first fix some notation for this section. $(X_1, \mathfrak{f}_{\Sigma_1})$ and $(X_2, \mathfrak{f}_{\Sigma_2})$ will always be the mirrors to the toric varieties $\check{X}_{\Sigma_1}, \check{X}_{\Sigma_2}$, and we will oftentimes refer to them by simply X_1, X_2 and suppress the notation of the stop. We will frequently use the argument-valuation decomposition, identifying

$$X_1 = (\mathbb{C}^*)^n = T^*Q_1/T_{2\pi\mathbb{Z}}^*Q_1 = Q_1 \times P_1$$

where $Q_1 = \mathbb{R}^n$ and $P_1 = T^n$. We give T^*Q_1 the standard symplectic coordinates (q_1, p_1) ; we will also use these as coordinates on X_1 as well (where the p_1 coordinate is taken up to the period of $T_{2\pi\mathbb{Z}}^*Q_1$). Recall that a Lagrangian section given by support function $F \in \text{Supp}(\Sigma)$ can be parameterized by

$$L(F) = (q, d(\widehat{H}_F + (-\varepsilon K))) \subset (X, \mathfrak{f}_{\Sigma}).$$

The constructions in this section do not use the parameter δ , and we drop it from our notation.

Our construction will use an SYZ mirror symmetry description of Lagrangian correspondences. A Lagrangian torus fibration $u : X \rightarrow Q$ locally provides coordinates (q, p) to X . The fiberwise sum of Lagrangian submanifolds $L', L'' \subset X$ is defined (in local coordinates) by

$$L' +_Q L'' := \{(q, p) : p = p' + p'', (q, p') \in L', (q, p'') \in L''\}.$$

This operation on Lagrangian submanifolds of X in the Fukaya category is conjecturally mirror to the tensor product of coherent sheaves on \check{X} [Sub10]. This holds for Lagrangian sections, where

$$L_0(F') + L_0(F'') = \psi_K^t(L_0(F' + F'')) \sim L_0(F' + F'').$$

If the fiberwise sum is cut out transversely, then it is a Lagrangian submanifold of X .

Proposition 5.3. *Let $\bar{L}_{01} : X_0^- \times X_1$ and $\bar{L}_{12} : X_1^- \times X_2$ be Lagrangian correspondences between SYZ fibrations $u : X_i \rightarrow Q_i$. Let $L_{01} \subset X_0 \times X_1$ and $L_{12} \subset X_1 \times X_2$ be the Lagrangians defined in local coordinates by:*

$$\begin{aligned} L_{01} &= \{(p_0, p_1, q_0, q_1) : (q_0, q_1, -p_0, p_1) \in \bar{L}_{01}\} \\ L_{12} &= \{(p_1, p_2, q_1, q_2) : (q_1, q_2, -p_1, p_2) \in \bar{L}_{12}\} \end{aligned}$$

We can rewrite the geometric composition $\bar{L}_{02} : X_0^- \times X_2$ (see Appendix C) using fiberwise sum:

$$L_{02} := \pi_{02}((X_0 \times Q_1 \times X_2) \cap ((Q_0 \times L_{12}) +_Q (L_{01} \times Q_2))) \subset X_2. \quad (10)$$

$$L_{02} = \{(q_0, q_1, p_0, p_1) : (q_0, q_2, -p_0, p_2) \in \bar{L}_{12} \circ \bar{L}_{01}\}$$

Here, $\pi_{02} : X_0 \times X_1 \times X_2 \rightarrow X_0 \times X_2$.

Proof. We compute that

$$\begin{aligned} & \pi_{02}((X_0 \times Q_1 \times X_2) \cap ((Q_0 \times L_{12}) +_Q (L_{01} \times Q_2))) \\ &= \pi_{02} \left((X_0 \times Q_1 \times X_2) \cap \left\{ (q_0, q_1, q_2, p_0, p_1, p_2) \left| \begin{array}{l} p_0 = p'_0 + p''_0, p_1 = p'_1 + p''_1, p_2 = p'_2 + p''_2 \\ (q_0, q_1, q_2, p''_0, p''_1, p''_2) \in L_{01} \times Q_2 \\ (q_0, q_1, q_2, p'_0, p'_1, p'_2) \in Q_0 \times L_{12} \end{array} \right. \right\} \right) \\ &= \pi_{02}(\{(q_0, q_1, q_2, p_0, 0, p_2) : -p'_1 = p''_1, (q_0, q_1, p_0, p''_1) \in L_{01}, (q_1, q_2, p'_1, p_2) \in L_{12}\}) \\ &= \{(q_0, q_2, -p_0, p_2) : (q_1, q_2, -p_1, p_2) \in L_{12}, (q_0, q_1, p_0, p_1) \in \bar{L}_{01}\} \\ &= \{(q_0, q_2, p_0, p_2) : (q_0, q_1, -p_0, p_1) \in \bar{L}_{12} \circ \bar{L}_{01}\} \end{aligned}$$

as desired. \square

This is a description of the Fourier-Mukai transform from a SYZ mirror symmetry perspective, where fiberwise sum is replacing tensor product on $\check{X}_1 \times \check{X}_2$.

Notation 5.4. *Since we are always working in the setting where X_1, X_2 come from SYZ fibrations, we will (for Sections 5 and 6) write $L_{12} : X_1 \Rightarrow X_2$ as a Lagrangian $L_{12} \subset X_1 \times X_2$, with composition of Lagrangian correspondences as defined in Proposition 5.3.*

Example 5.5 ([Sub10]). Let $K_1 \subset X$ be a Lagrangian submanifold, whose points can be given coordinates $(q, p) \in K_1$. Then there is a Lagrangian correspondence $L_{+Q}K_1 : X \Rightarrow X$ parameterized by

$$\begin{aligned} P \times K_1 &\rightarrow X \times X \\ (\tilde{p}, (q, p)) &\mapsto (q, q, \tilde{p} + p, -\tilde{p}) \end{aligned}$$

which has the property that for any Lagrangian $K \subset X$,

$$L_{+Q}K_1 \circ K = K_1 +_Q K$$

thus recovering the operation of fiberwise sum with K_1 .

Let $\check{f} : \check{X}_{\Sigma_1} \rightarrow \check{X}_{\Sigma_2}$ be a toric morphism. Then there exists a linear map associated with this toric morphism $\underline{f} : Q_1 \rightarrow Q_2$, which maps the cones of Σ_1 to subsets of cones of Σ_2 . We use $\underline{f} : Q_1 \rightarrow Q_2$ to construct the Lagrangian correspondence by first constructing the graph $\Gamma(\underline{f}) \subset Q_1 \times Q_2$, taking the associated tropical Lagrangian submanifold (conormal torus), and finally wrapping slightly by the wrapping Hamiltonian K_{12} for $X_1 \times X_2$.

Definition 5.6. Let $\check{f} : \check{X}_{\Sigma_1} \rightarrow \check{X}_{\Sigma_2}$ be a toric morphism. The mirror correspondence is:

$$L_{f^*} := \psi_{\delta}^{-\varepsilon}(N^*\Gamma(\underline{f})/N_{2\pi\mathbb{Z}}^*\Gamma(\underline{f})) \subset (X_1 \times X_2).$$

Consider the map $\underline{f}^* : (P_2)_{f(q_1)} \rightarrow (P_1)_{q_1}$, which comes from periodizing the map $\underline{f}^* : T_{f(q_1)}^*Q_2 \rightarrow T_{q_1}^*Q_1$. We can explicitly parameterize L_{f^*} by:

$$\begin{aligned} Q_1 \times P_2 &\rightarrow Q_1 \times Q_2 \times P_1 \times P_2 \\ (q_1, p_2) &\mapsto (q_1, \underline{f}(q_1), -\underline{f}^*p_2 + d(-\varepsilon K_{12})|_1, p_2 + d(-\varepsilon K_{12})|_2). \end{aligned}$$

here $d(-\varepsilon K_{12})|_i$ are the P_i components of $d(-\varepsilon K_{12})$.

Lemma 5.7. *Let $\check{f} : \check{X}_{\Sigma_1} \rightarrow \check{X}_{\Sigma_2}$ be a toric morphism. The Lagrangian L_{f^*} gives a Lagrangian correspondence*

$$L_{f^*} : ((\mathbb{C}^*)^{|\Sigma_2|}, \mathfrak{f}_{\Sigma_2}) \Rightarrow ((\mathbb{C}^*)^{|\Sigma_1|}, \mathfrak{f}_{\Sigma_1}).$$

Proof. We need to show that this Lagrangian is conical at infinity and disjoint from the stop.

The Liouville structure on $X_1 \times X_2$ comes from identifying it with $T^*(P_1 \times P_2)$, where $P_1 \times P_2$ is the SYZ fiber over the origin $(0, 0) \in Q_1 \times Q_2$. Our Lagrangian graph can also be expressed as

$$L_{f^*} = \psi_{K_{12}}^{\varepsilon}(N_{P_1 \times P_2}^*(f^*(P_2), P_2)).$$

As all conormal bundles are conical at infinity, and the wrapping Hamiltonian is admissible, the Lagrangian L_{f^*} is conical at infinity. Therefore, L_{f^*} is conical at infinity as well.

Similarly, we show that L_{f^*} is disjoint from the stop of $X_1 \times X_2$. Here, we use that the stop of the product (Eq. (16)) is the FLTZ stop of the product toric variety. Let $\mathbb{L}_{\sigma_1 \times \sigma_2} \in \mathbb{L}_{\Sigma_1 \times \Sigma_2}$ be a FLTZ skeleton component. The points $(q_1, p_2) \in P_2 \times Q_1$ which intersect the FLTZ skeleton component $\mathbb{L}_{\sigma_1} \times \mathbb{L}_{\sigma_2}$ under the parameterization of L_{f^*} must satisfy the constraint:

$$(-\underline{f}^* p_2 + d(-\varepsilon K_{12})|_1, p_2 + d(-\varepsilon K_{12})|_2) \cdot (\sigma_1 \times \sigma_2)|_{(q_1, f(q_1))} = 0.$$

Let \vec{v}_q be the unit vector which points in the q -direction, for a point $q \in \sigma_1$. We test the condition on the vector $(\vec{v}_q, \underline{f}(\vec{v}_q))$. Since f is a toric morphism, $(\vec{v}_q, \underline{f}(\vec{v}_q))$ belongs to a cone, so $d(-\varepsilon K_{12})(\vec{v}_q, \underline{f}(\vec{v}_q)) < 0$. Therefore, L_{f^*} avoids the stop. \square

Remark 5.8. This Lagrangian correspondence does a remarkably good job of preserving the skeleton. Let $\check{f} : \check{X}_1 \rightarrow \check{X}_2$ be a toric morphism which *preserves cones*, so that $\underline{f}(\sigma_1) \in \Sigma_2$ for all $\sigma_1 \in \Sigma_1$. Consider $\tilde{L}_{f^*} := N^* \Gamma(f) / N_{2\pi\mathbb{Z}}^* \Gamma(\underline{f})$, which should be considered as the ‘‘monomially admissible’’ version of our correspondence.¹⁹ Let $\mathbb{L}_{\sigma_1} \subset X_1$ be the component of the FLTZ skeleton associated to $\sigma_1 \in \Sigma_1$, and $\mathbb{L}_{\underline{f}(\sigma_1)} \subset X_2$ be the component of the FLTZ skeleton associated to its image.

$$\tilde{L}_{f^*}^{-1} \circ \mathbb{L}_{\sigma_1} = \pi_2 \circ (\pi_1^{-1}(\mathbb{L}_{\sigma_1}) \cap L_{f^*})$$

Decomposing $X_1 \times X_2 = (Q_1 \times Q_2) \times (P_1 \times P_2)$,

$$\begin{aligned} &= \pi_2 \circ (((\sigma_1 \times Q_2)) \times (\sigma_1^\perp \times P_2) \cap ((Q_1, f(Q_1)) \times (Q_1, f(Q_1))^\perp)) \\ &= \left\{ (q_2, p_2) \mid \begin{array}{l} -p_1 \cdot Q_1 + p_2 \cdot f(Q_1) = 0 \\ q_2 = f(q_1), q_1 \in \sigma_1, p_1 \cdot Q_1 = 0 \end{array} \right\} \\ &= (\underline{f}(\sigma_1)) \times (\underline{f}(\sigma_1))^\perp = \mathbb{L}_{\underline{f}(\sigma_1)}. \end{aligned}$$

This Lagrangian \tilde{L}_{f^*} is more rigid than L_{f^*} , which only preserves a neighborhood of the stop as opposed to the stop itself. The Lagrangian \tilde{L}_{f^*} can be obtained from L_{f^*} by taking the wrapping Hamiltonian $-\varepsilon K_{12}$ to zero. As \tilde{L}_{f^*} has a cleaner description than L_{f^*} , we will use it in proofs where taking the wrapping Hamiltonian $-\varepsilon K_{12}$ to zero does not impact the argument.

We’ve chosen the convention that $\check{f} : \check{X}_{\Sigma_1} \rightarrow \check{X}_{\Sigma_2}$ gives a Lagrangian correspondence $L_{f^*} : X_2 \Rightarrow X_1$ for reasons related to admissibility of the geometric composition. We quickly highlight some reasons for this choice; a full discussion of the admissibility of Lagrangian correspondences is found in Proposition D.3. When Σ_2 is complete, then the inverse image functor gives a map from the derived category of coherent sheaves on Σ_2 to that of Σ_1 . Geometric correspondence similarly gives us a map from (Hamiltonian isotopy classes of) admissible Lagrangian submanifolds of (X_1, \mathfrak{f}_1) to those of (X_2, \mathfrak{f}_2) . However, there need not be a well-defined map on Hamiltonian isotopy classes of Lagrangian submanifolds in the other direction. For example, if Σ_1 is a subfan of Σ_2 , then there is a morphism $((\mathbb{C}^*)^n, \Sigma_2) \Rightarrow ((\mathbb{C}^*)^n, \Sigma_1)$ arising from stop removal, but not necessarily a map in the other direction. The stop removal morphism is mirror to localization at a toric stratum. An analogous situation occurs in the mirror, where (without a properness condition) the Fourier-Mukai transform only preserves coherence in one direction. As an example, consider

¹⁹When f does not preserve cones, this is not monomially admissible.

on the B -side the map $i : \mathbb{C}^* \rightarrow \mathbb{C}$. This induces a pullback map $i^* : \text{Sh}(\mathbb{C}) \rightarrow \text{Sh}(\mathbb{C}^*)$ on the level of coherent sheaves. However $i_* : \text{Sh}(\mathbb{C}^*) \rightarrow \text{Sh}(\mathbb{C})$ only preserves quasi-coherence.

However, even if $L_{f^*}^{-1}$ does not give an admissible Lagrangian correspondence from $X_1 \Rightarrow X_2$, it is possible that for some $L \in X_1$, the composition $L_{f^*}^{-1} \circ L$ remains admissible. In particular, if L is totally stopped (and conjecturally mirror to a compactly supported perfect complex) then $L_{f^*}^{-1} \circ L$ is admissible. For example, in the mirror, there are plenty of coherent sheaves on \mathbb{C}^* which pushforward to coherent sheaves on \mathbb{C} . We will, on occasion, use a Lagrangian correspondence in the non-admissible direction to build Lagrangian submanifolds on X_2 from Lagrangian submanifolds on X_1 , and we will point out if we need check the admissibility of the composition in these situations.

The next two claims prove that this correspondence appropriately “pulls back” Lagrangian sections.

Proposition 5.9. *Let $L_2(0) \subset X_2$ be the admissible Lagrangian zero section of the Lagrangian torus fibration $u : X_2 \rightarrow Q_2$. Then $L_{f^*} \circ L_2(0)$ is Hamiltonian isotopic to the zero section of $X_1 \rightarrow Q_1$.*

In the construction of the geometric composition for admissible Lagrangian correspondences (Proposition D.4), we’re required to take an additional Hamiltonian isotopy to obtain admissibility of the composition. This is denoted by $\Phi(\pi^{-1}(L_1))$ in Proposition D.4. For this section, we will ignore this additional Hamiltonian (whose incorporation does not modify the admissible Hamiltonian class of our computations).

Proof.

$$\begin{aligned} L_{f^*} \circ L_2(0) &= \pi_1 \left((Q_2 \times X_1) \cap \left\{ (q_1, q_2, p_1, p_2) \left| \begin{array}{l} p_1 = p'_1 + p''_1, p_2 = p'_2 + p''_2 \\ (q_1, q_2, p'_1, p'_2) \in L_{f^*} \\ (q_1, q_2, p''_1, p''_2) \in Q_1 \times L_2 \end{array} \right. \right\} \right) \\ &= \left\{ (q_1, p_1) \left| \begin{array}{l} p_1 = p'_1 + p''_1, 0 = p'_2 + p''_2 \\ p'_1 = -\underline{f}^*(p) + d(-\varepsilon K_{12})|_1, p'_2 = p + d(-\varepsilon K_{12})|_2, q_2 = \underline{f}(q_1) \\ p''_2 = d(-\varepsilon K_2), p \in P_2, q_1 \in Q_1 \end{array} \right. \right\} \\ &= \{(q_1, d(-\varepsilon K_{12})|_1 + \underline{f}^*(d(-\varepsilon K_{12})|_2 + d(-\varepsilon K_2))) \mid q_1 \in Q_1\}, \end{aligned}$$

which is a Lagrangian section of X_1 . It remains to show that this section is admissibly Hamiltonian isotopic to $(d(-\varepsilon K_1), q_1)$. Outside of a compact set, for all σ , and $q \in \sigma, \vec{v} \in \sigma, |\vec{v}| = 1$,

$$-1 < (d(-\varepsilon K_{12})|_1 + \underline{f}^*(d(-\varepsilon K_{12})|_2 + d(-\varepsilon K_2))) \cdot (\vec{v})|_q < 0.$$

Therefore, the isotopy of Lagrangian submanifolds which is parameterized by

$$\{(q_1, td(-\varepsilon K_1) + (1-t)(d(-\varepsilon K_{12})|_1 + \underline{f}^*(d(-\varepsilon K_{12})|_2 + d(-\varepsilon K_2)))) \mid q_1 \in Q_1\}$$

avoids the stop, giving us an admissible Hamiltonian isotopy between $L_{f^*} \circ L_2(0)$ and $L_1(0)$. \square

For any support function $F : Q_2 \rightarrow \mathbb{R}$, the pullback function \underline{f}^*F is a support function on Q_1 . Let $\phi_{F,\delta}^t$ be the time t flow of the associated conical twisting Hamiltonian \widehat{H}_F , with δ chosen small enough so that the Lagrangians we consider are still admissible.

Proposition 5.10. *Let $f : Q_1 \rightarrow Q_2$ be a toric morphism and consider a support function $F_2 \in \text{Supp}(\Sigma_2)$. Let $F_1 = \underline{f}^* F_2$ and $L_2 \subset Q_2$ be an admissible Lagrangian submanifold. Then there is an admissible Hamiltonian isotopy*

$$L_{f^*} \circ (\phi_{F_2, \delta}^t(L_2)) \sim \phi_{F_1, \delta}^t(L_{f^*} \circ L_2).$$

Proof.

$$\begin{aligned} L_{f^*} \circ (\phi_{F_2, \delta}^t(L_2)) &= \pi_1 \left((Q_2 \times X_1) \cap \left\{ (q_1, q_2, p_1, p_2) \left| \begin{array}{l} p_1 = p'_1 + p''_1, p_2 = p'_2 + p''_2 \\ (p'_1, p'_2, q_1, q_2) \in L_{f^*} \\ (q_1, q_2, p''_1, p''_2) \in Q_1 \times \phi_{F_2, \delta}^t(L_2) \end{array} \right. \right\} \right) \\ &= \left(\left\{ (q_1, p_1) \left| \begin{array}{l} p_1 = p'_1 + p''_1, 0 = p'_2 + p''_2 \\ p'_1 = d(-\varepsilon K_{12})|_1 - \underline{f}^*(p_2) \\ p'_2 = d(-\varepsilon K_{12})|_2 + p_2, q_2 = \underline{f}(q_1), (q_1, p_2) \in Q_1 \times P_2 \\ p''_2 = d\widehat{H}_{F_2} + \tilde{p}''_2, (q''_2, \tilde{p}''_2) \in L_2 \end{array} \right. \right\} \right) \end{aligned}$$

Letting $\tilde{p}'_2 = p'_2 + d\widehat{H}_{F_2}$, $\tilde{p}_2 = p_2 - d\widehat{H}_{F_2}$, $\tilde{p}'_1 = p'_1 + \underline{f}^*(d\widehat{H}_{F_2})$, $\tilde{p}_1 = p_1 - \underline{f}^*(d\widehat{H}_{F_2})$

$$= \left(\left\{ (q_1, \tilde{p}_1 + \underline{f}^* d\widehat{H}_{F_2}) \left| \begin{array}{l} \tilde{p}_1 = \tilde{p}'_1 + p''_1, 0 = \tilde{p}'_2 + \tilde{p}''_2 \\ \tilde{p}'_1 = d(-\varepsilon K_{12})|_1 - \underline{f}^*(\tilde{p}_2) \\ \tilde{p}'_2 = d(-\varepsilon K_{12})|_2 + \tilde{p}_2, q_2 = \underline{f}(q_1), (q''_2, \tilde{p}''_2) \in L_2 \end{array} \right. \right\} \right)$$

Letting $\tilde{H}_2 = \underline{f}^* \widehat{H}_{F_2}$

$$= \phi_{\tilde{H}_2, \delta}^t(L_{f^*} \circ L_2).$$

By a similar argument to Proposition 5.9, this is admissibly Hamiltonian isotopic to $\phi_{\underline{f}^* F_2, \delta}^t(L_{f^*} \circ L_2)$. \square

Corollary 5.11. *If $L_{\Sigma_2}(F_2) \subset X_2$ is a tropical section, $L_{f^*} \circ L_{\Sigma_2}(F_2) \sim L_{\Sigma_1}(\underline{f}^* F_2)$.*

5.3 Construction of the inclusion correspondence

We now construct a correspondence mirror to the inclusion $\check{i}_{\alpha 0} : \check{X}_{\text{star}(\alpha)/\alpha} \hookrightarrow \check{X}_\Sigma$. As before, we fix some notation. In this subsection, we reserve $X_1 = (\mathbb{C}^*)^n$, $X_2 = (\mathbb{C}^*)^{n-1}$ for symplectic tori, which can be equipped with stops to give us $(X_1, \mathfrak{f}_\Sigma)$, $(X_1, \mathfrak{f}_{\text{star}(\alpha)})$ and $(X_2, \mathfrak{f}_{\text{star}(\alpha)/\alpha})$. These come with Lagrangian torus fibrations $X_1 = Q_1 \times P_1$, and $X_2 = Q_2 \times P_2$. Denote by $\underline{\pi}_\alpha : Q_1 \rightarrow Q_2$ the linear map whose corresponding toric morphism is the projection $\check{X}_{\text{star}(\alpha)} \rightarrow \check{X}_{\text{star}(\alpha)/\alpha}$. We write $\underline{\pi}_\alpha^* : P_2 \rightarrow P_1$ for the dual map on the fibers.

The idea of the construction is to use Section 5.2 to build the mirror to $\Gamma(\underline{\pi}_\alpha) \subset \check{X}_{\text{star}(\alpha)} \times X_{\text{star}(\alpha)/\alpha}$, and then mimic Section 5.1.

Proposition 5.12. *Let α be a 1-dimensional cone of Σ . Consider the morphism of fans $\underline{\pi}_\alpha : \text{star}(\alpha) \rightarrow \text{star}(\alpha)/\alpha$. Let $L_{\underline{\pi}_\alpha^*} : (X_2, \mathfrak{f}_{\text{star}(\alpha)/\alpha}) \Rightarrow (X_1, \mathfrak{f}_{\text{star}(\alpha)})$ be the associated Lagrangian correspondence built in Lemma 5.7. Let $\phi_{F_\alpha}^{1-\varepsilon} : X_1 \rightarrow X_1$ be the wrapping Hamiltonian for the support function F_α which is 1 on the generator α , and 0 on all other 1-dimensional cones. Then the intersection of the Lagrangians $L_{\underline{\pi}_\alpha^*}$ and $\phi_{F_\alpha}^{1-\varepsilon}(L_{\underline{\pi}_\alpha^*})$ has a surgery data (as in Definition A.4).*

Before we prove the claim, we note that by taking the $1 - \varepsilon$ flow $\phi_{F_\alpha}^{1-\varepsilon}$, the Lagrangians $L_{\pi_\alpha^*}$ and $\phi_{F_\alpha}^{1-\varepsilon}(L_{\pi_\alpha^*})$ only intersect over the region where $\frac{d}{dt}\phi_{F_\alpha}^t = 0$.

Proof. The Lagrangian submanifold $L_{\pi_\alpha^*} : (X_2, \mathfrak{f}_{\text{star}(\alpha)/\alpha}) \Rightarrow (X_1, \mathfrak{f}_{\text{star}(\alpha)})$ is topologically a $P_2 \times Q_1$, parameterized by

$$L_{\pi_\alpha^*} = \{((q, \underline{\pi}_\alpha(q)), (-\underline{\pi}_\alpha^* p + d(-\varepsilon K_{12})|_1, p + d(-\varepsilon K_{12})|_2)) : q \in Q_1, p \in P_2\} \subset Q_1 \times Q_2 \times P_1 \times P_2$$

The wrapping Hamiltonian acts on the P_1 factor, and sends this Lagrangian submanifold to

$$\phi_{F_\alpha}^{1-\varepsilon}(L_{\pi_\alpha^*}) = \{((q, \underline{\pi}_\alpha(q)), (-\underline{\pi}_\alpha^* p + d(-\varepsilon K_{12})|_1 + d(1 - \varepsilon)\widehat{H}_\alpha^\delta, p + d(-\varepsilon K_{12})|_2)) : q \in Q_1, p \in P_2\}.$$

Here, $\phi_{F_\alpha}^{1-\varepsilon}$ is the conical smoothing of F_α , which in Section 3 was denoted $\widehat{H}_{-D_\alpha}^\delta$. The intersection between $L_{\pi_\alpha^*}$ and $\phi_{F_\alpha}^{1-\varepsilon}(L_{\pi_\alpha^*})$ is determined by the intersection between the zero section and the Lagrangian section $d\widehat{H}_\alpha^\delta$ in $T^*Q_1/T_{2\pi\mathbb{Z}}^*Q_1$. By Lemma 4.2, the intersection of the zero section and the graph of $d\widehat{H}_\alpha^\delta$ form a surgery data (Definition A.4). \square

This allows us to use Proposition A.5 to build the mirror to the graph of the inclusion $i_{\alpha 0} : \check{X}_{\text{star}(\alpha)/\alpha} \rightarrow \check{X}_\Sigma$.

Definition 5.13. Let $\alpha \in \Sigma$ be a 1-dimensional cone. The local model for the toric orbit inclusion is the Lagrangian correspondence $L_{\alpha 0}^{pre} : (X_2, \mathfrak{f}_{\text{star}(\alpha)/\alpha}) \Rightarrow (X_1, \mathfrak{f}_{\text{star}(\alpha)})$ defined by the surgery

$$L_{\alpha 0}^{pre} = \phi_{F_\alpha}^{1-\varepsilon}(L_{\pi_\alpha^*}) \#_{U_{\widehat{H}_\alpha^\delta}} L_{\pi_\alpha^*}.$$

We additionally obtain a Lagrangian surgery cobordism,

$$K_{\alpha 0}^{pre} : (\phi_{F_\alpha}^{1-\varepsilon}(L_{\pi_\alpha^*}), L_{\pi_\alpha^*}^{pre}) \rightsquigarrow L_{\alpha 0}.$$

Let $\check{i}_{\text{star}(\alpha), 0} : \check{X}_{\text{star}(\alpha)/\alpha} \rightarrow \check{X}_\Sigma$ be the inclusion of the normal bundle to $\check{X}_{\text{star}(\alpha)/\alpha}$, and $L_{i_{\text{star}(\alpha), 0}^*} : (X_1, \mathfrak{f}_\Sigma) \Rightarrow (X_1, \mathfrak{f}_{\text{star}(\alpha)})$ be the mirror correspondence.²⁰ The toric orbit inclusion is the Lagrangian correspondence

$$L_{\alpha 0} := ((L_{\alpha 0}^{pre})^{-1} \circ L_{i_{\text{star}(\alpha), 0}^*})^{-1} : (X_2, \mathfrak{f}_{\text{star}(\alpha)/\alpha}) \Rightarrow (X_1, \mathfrak{f}_\Sigma),$$

which similarly comes with a surgery cobordism.

The correspondence $L_{i_{\text{star}(\alpha), 0}^*}$ does not significantly modify the local model of the toric orbit inclusion. In fact, if we naively include $L_{\alpha 0}^{pre}$ as a subset of $(X_1, \mathfrak{f}_\Sigma)$, it is admissibly Hamiltonian isotopic to $L_{\alpha 0}$.

Proposition 5.14. *The valuation of the X_1 component of $L_{\alpha 0}$ is contained within the star of α :*

$$u(\pi_1(L_{\alpha 0})) \subset \text{star}(\alpha).$$

Proof. Analogous to Proposition 4.6. \square

Proposition 5.15. $L_{\alpha 0} : (X_2, \mathfrak{f}_{\text{star}(\alpha)/\alpha}) \Rightarrow (X_1, \mathfrak{f}_\Sigma)$ is an admissible Lagrangian correspondence.

²⁰This is a stop removal correspondence, which will be explored further in Section 6.2.

Proof. Since $L_{\pi_\alpha^*}, \phi_{F_\alpha}^{1-\varepsilon}(L_{\pi_\alpha^*})$ are both admissible, the surgery $L_{\alpha 0}$ is admissible (Proposition A.5). \square

From here on, for the sake of notational clarity, we write $\widehat{H}_\alpha^\delta$ for $(1-\varepsilon)\widehat{H}_\alpha^\delta$. From its construction in Proposition A.5, $L_{\alpha 0}$ comes with two charts which sit inside $Q_1 \times Q_2 \times P_1 \times P_2$ as

$$\begin{aligned} L_r &:= \left\{ \left((q_1, \pi_\alpha(q_1)), (\pi_\alpha^* p_2 + d(-\varepsilon K_{12})|_1 + d(r_{\rho c_\varepsilon} \circ \widehat{H}_\alpha^\delta), p_2 + d(-\varepsilon K_{12})|_2) \right) : q_1 \in Q_1, \widehat{H}_\alpha^\delta \geq \rho c_\varepsilon \right\} \\ L_s &:= \left\{ \left((q_1, \pi_\alpha(q_1)), (\pi_\alpha^* p_2 + d(-\varepsilon K_{12})|_1 + d(s_{\rho c_\varepsilon} \circ \widehat{H}_\alpha^\delta), p_2 + d(-\varepsilon K_{12})|_2) \right) : q_1 \in Q_1, \widehat{H}_\alpha^\delta \geq \rho c_\varepsilon \right\} \end{aligned}$$

which we will call the r and s -charts. In the same way that the addition of the wrapping Hamiltonian $d(-\varepsilon K)$ made using coordinate charts for L_{f^*} a bit unwieldy in computations in Section 5.2, the presence of the wrapping Hamiltonian can clutter computations here. As before, the $d(-\varepsilon K_{12})$ terms which are required to disjoin $L_{\alpha 0}$ from the stop can be chosen to be very small, and for some computations, we can set them equal to 0 without impacting the result; equivalently, this is the same as working with the Lagrangian $\psi_{K_{12}, \delta}^\varepsilon(L_{\alpha 0})$. We work with this simplified Lagrangian frequently enough that we will call it $\tilde{L}_{\alpha 0}$; we will similarly use the charts \tilde{L}_r, \tilde{L}_s .

Proposition 5.16. *Let $L \subset (X_2, \mathfrak{f}_{\text{star}(\alpha)/\alpha})$ be an admissible Lagrangian submanifold. Then $L_{\alpha 0} \circ L$ has the topology of $L \times \mathbb{R}$.*

Proof. This computation can be simplified by using $\tilde{L}_{\alpha 0}$ instead of $L_{\alpha 0}$. We use the r and s -charts to compute the geometric composition, as $\tilde{L}_r \circ L$ and $\tilde{L}_s \circ L$ form charts for $\tilde{L}_{\alpha 0} \circ L$. By Corollary 4.3, we can choose a section $i : Q_2 \hookrightarrow Q_1$ which parameterizes the ρc_ε level set of $\widehat{H}_\alpha^\delta$. See Fig. 9b. We look at one of these charts:

$$\tilde{L}_r \circ L = \left\{ (q_1, \pi_\alpha^*(p_2) + d(r_{\rho c_\varepsilon} \circ \varepsilon \widehat{H}_\alpha^\delta)) : \widehat{H}_\alpha^\delta(q_1) \geq \rho c_\varepsilon, (\pi_\alpha(q_1), p_2) \in L \right\}$$

We wish to replace $\pi_\alpha(q_1) = q_2$ with $q_1 \in \pi_\alpha^{-1}(q_2)$. Since the set $\widehat{H}_\alpha^\delta(q_1) \geq \rho c_\varepsilon$ fibers over the image of i under the projection π_α , we can parameterize this preimage as:

$$= \left\{ (i(q_2) + \alpha \cdot t, \pi_\alpha^*(p_2) + d(r_{\rho c_\varepsilon} \circ \varepsilon \widehat{H}_\alpha^\delta)) : (q_2, p_2) \in L, t \in \mathbb{R}_{>0} \right\}. \quad (r\text{-parameterization})$$

This chart has the topology of $L \times \mathbb{R}_{\geq 0}$. A similar argument shows that $\tilde{L}_s \circ L$ has the topology of $L \times \mathbb{R}_{\leq 0}$. These two charts are identified along their boundaries, so that $\tilde{L}_{\alpha 0} \circ L \cong L \times \mathbb{R}$. \square

Remark 5.17. There are a few constructions in the literature similar to $L_{\alpha 0} \circ L$. Particularly relevant examples come from Lagrangian cobordisms and Lefschetz fibrations.

- In Lagrangian cobordisms, there is an inclusion of Fukaya categories:

$$\begin{aligned} \text{Fuk}(X) &\rightarrow \text{Fuk}(X \times \mathbb{C}) \\ L &\mapsto L \times \gamma \end{aligned}$$

where $\gamma \subset \mathbb{C}$ is a curve. Parallel transport along a u -shaped curve around a stop of the cobordism is used in [BC14] to give $\text{Fuk}(X \times \mathbb{C})$ the structure of a module over $\text{Fuk}(X)$.

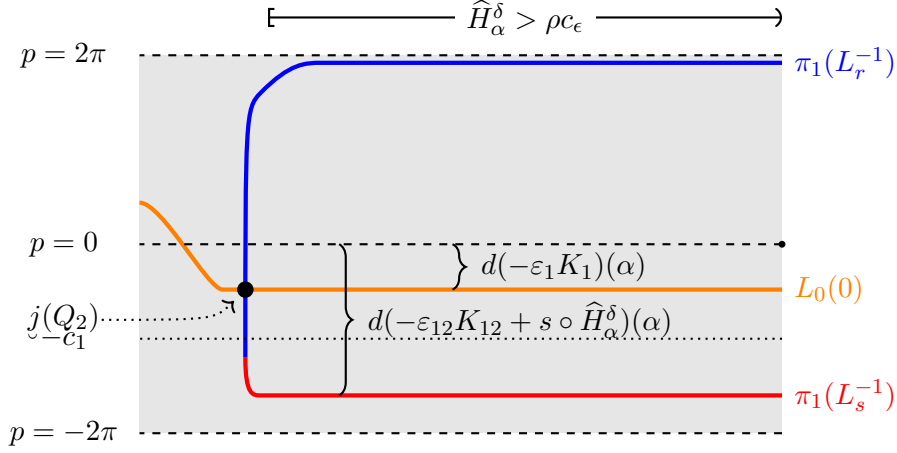

Figure 11. A $\mathbb{C}^* = \{(q\alpha, p\alpha)\}/(p \sim p + 2\pi)$ slice of X_1 , exhibiting the choices of $c_\varepsilon, \varepsilon_{12}, \varepsilon_1$.

- In Lefschetz fibrations, there is a “cup functor” from $\text{Fuk}(W^{-1}(z)) \rightarrow \text{Fuk}(X, W)$, which includes Lagrangians by parallel transport along a curve in the base of the Lefschetz fibration. It is called the cup functor as the shape of the curve has a \cup shape. This functor is also sometimes referred to as the Orlov functor and the image objects as u -shaped Lagrangians. The Orlov functor for stopped Liouville domains where the stop is a smooth hypersurface is well-understood [Syl19b]. Our construction can be viewed as (a special case of) the Orlov functor for singular stops.

Our Lagrangian $L_{\alpha 0}$ gives an interpretation to these constructions as arising from a Lagrangian correspondence.

Proposition 5.18. *Let $L_0 \subset (X_1, \mathfrak{f}_\Sigma)$ be the Lagrangian zero section. Then $L_{\alpha 0}^{-1} \circ L_0$ is a Lagrangian zero section of $(X_2, \mathfrak{f}_{\text{star}(\alpha)/\alpha})$.*

Proof. We compute $L_r^{-1} \circ L_0(0)$ and $L_s^{-1} \circ L_0(0)$. Recall that $L_0(0)$ is given by taking the zero section and pushing it off slightly by the Hamiltonian flow of $-\varepsilon_1 K_1$. For any $c_1 > 0$, there exists a choice of ε_1 small enough so that $|d(\varepsilon_1 K_1)(\alpha)| < c_1$. The charts L_r and L_s are determined by choices of wrapping Hamiltonian $\varepsilon_{12} K_{12}, \widehat{H}_\alpha^\delta$ and surgery parameter c_ε . We choose ε_{12} to be large enough and c_ε small enough so that over the region $\widehat{H}_\alpha^\delta \geq \rho \cdot c_\varepsilon$,

$$d(-\varepsilon_{12} K_{12} + s_{\rho c_\varepsilon} \widehat{H}_\alpha^\delta)(\alpha) < -c_1. \quad (11)$$

For these choices, the L_s^{-1} correspondence does not intersect $L_0(0)$, as

$$\arg(\pi_1(L_s^{-1})) \subset \{p_1 \text{ such that } p_1(\alpha) < -c_1\} \quad \arg(L_0(0)) \subset \{p_1 \text{ such that } |p_1(\alpha)| < c_1\}.$$

Therefore $L_s^{-1} \circ L_0(0) = \emptyset$. It remains to compute $L_r^{-1} \circ L_0(0)$:

$$L_r^{-1} \circ L_0(0) = \pi_2 \circ \left(\left((q_1, q_2, 0, p_2) \left| \begin{array}{l} 0 = p'_1 + p''_1, p_2 = p'_2 + p''_2 \\ p'_1 = -\pi_\alpha^*(p) + d(-\varepsilon_{12} K_{12})|_1 + d(r_{\rho c_\varepsilon} \widehat{H}_\alpha^\delta) \\ p_2 = p + d(-\varepsilon_{12} K_{12})|_2, p \in P_2 \\ q_2 = f(q_1), \widehat{H}_\alpha^\delta(q_1) \geq \rho c_\varepsilon \\ p''_1 = d(-\varepsilon_1 K_1), p''_2 = 0, q_2 \in Q_2 \end{array} \right. \right) \right)$$

We examine the condition $(\pi_\alpha^*(p) + d(-\varepsilon_{12}K_{12})|_1 + d(r_{\rho c_\varepsilon}\widehat{H}_\alpha^\delta) = d(-\varepsilon_1K_1)$. This states that $d(-\varepsilon_{12}K_{12})|_1 + d(r_{\rho c_\varepsilon}\widehat{H}_\alpha^\delta) - d(-\varepsilon_1K_1)$ is the pullback of a differential form from P_2 ; equivalently, that $d(-\varepsilon_{12}K_{12})|_1 + d(r_{\rho c_\varepsilon}\widehat{H}_\alpha^\delta) + d(\varepsilon_1K_1)$ vanishes on α .

$$= \left\{ (p_1, \pi_\alpha(q_1)) \mid \begin{array}{l} p_1 = d(-\varepsilon_{12}K_{12})|_1 + d(r_{\rho c_\varepsilon}\widehat{H}_\alpha^\delta) + d(\varepsilon_1K_1) \\ p_1(\alpha) = 0, p_2 = \pi_\alpha^*(p), \widehat{H}_\alpha^\delta(q_1) \geq \rho c_\varepsilon \end{array} \right\}$$

This reduces us to computing the locus on which $(d(-\varepsilon_{12}K_{12})|_1 + d(r_{\rho c_\varepsilon}\widehat{H}_\alpha^\delta) + d(\varepsilon_1K_1))(\alpha) = 0$.

We now construct $j : Q_2 \rightarrow Q_1$, a section of $\pi_\alpha : Q_1 \rightarrow Q_2$ which parameterizes the locus $\{q_1 : (d(-\varepsilon_{12}K_{12})|_1 + d(r_{\rho c_\varepsilon}\widehat{H}_\alpha^\delta) + d(\varepsilon_1K_1))(\alpha) = 0\}$. This is equivalent to showing that the function $r_{\rho c_\varepsilon} \circ \widehat{H}_\alpha^\delta(q + t \cdot \alpha)$ is *convex* in t when $d(r_{\rho c_\varepsilon} \circ \widehat{H}_\alpha^\delta)(\alpha) = 0$. By Lemma 4.2, $\frac{d}{dt} \left(\widehat{H}_\alpha^\delta(q + t \cdot \alpha) \right) \geq 0$ in this region. We have that

$$\frac{d^2}{dt^2}(r_{\rho c_\varepsilon} \circ \widehat{H}_\alpha^\delta(q + t \cdot \alpha)) = r_{\rho c_\varepsilon}'' \cdot \frac{d}{dt} \widehat{H}_\alpha^\delta(q + t \cdot \alpha) + r_{\rho c_\varepsilon}' \cdot \frac{d^2}{dt^2} \widehat{H}_\alpha^\delta(q + t \cdot \alpha)$$

In the region near the level set, $r_{\rho c_\varepsilon}''$ is arbitrarily large (see profile curve Fig. 20), $\frac{d}{dt} \widehat{H}_\alpha^\delta(q + t \cdot \alpha)$ is positive, and $r_{\rho c_\varepsilon}'$ and $\frac{d^2}{dt^2} \widehat{H}_\alpha^\delta(q + t \cdot \alpha)$ are bounded. See Fig. 11 to see the set parameterized by $j(Q_2)$

We obtain a parameterization of the geometric composition:

$$L_r^{-1} \circ L_0(0) = \left\{ (q_2, p) \mid \begin{array}{l} p_1 = d((-\varepsilon K_{12})|_1 + (r_{\rho c_\varepsilon}\widehat{H}_\alpha^\delta) - (-\varepsilon K_1)) \\ q_1 = j(q_2), p_2 = \pi_\alpha^*(p) \end{array} \right\} \quad (12)$$

which is a Lagrangian section admissibly Hamiltonian isotopic to the zero section. \square

Proposition 5.19. *Let $F \in \text{Supp}_\alpha(\Sigma)$ be a support function transverse to the divisor D_α . There exists a Lagrangian cobordism in $(X_1, \mathfrak{f}_\Sigma) \times \mathbb{C}$, whose topology is that of a disk and whose ends are*

$$(L_0(F + F_\alpha), L_0(F)) \rightsquigarrow L_{\alpha 0} \circ L_\alpha(i_{\alpha 0}^* F) \quad (13)$$

Proof. We combine Definition 5.13, which describes the surgery used to build our Lagrangian correspondence, and Proposition C.2, which proves that Lagrangian cobordism and geometric correspondence can be interchanged. We first consider the setting where $\check{X}_\Sigma = \check{X}_{\text{star}(\alpha)}$. We can construct a sequence of Lagrangian cobordisms

$$(\phi_{F_\alpha}^{1-\varepsilon}(L_{\pi_\alpha^*}), L_{\pi_\alpha^*}) \rightsquigarrow L_{\alpha 0} \quad (\text{Definition 5.13})$$

$$(\phi_{F_\alpha}^{1-\varepsilon}(L_{\pi_\alpha^*}) \circ L_\alpha(i_{\alpha 0}^* F), L_{\pi_\alpha^*} \circ L_\alpha(i_{\alpha 0}^* F)) \rightsquigarrow L_{\alpha 0} \circ L_\alpha(i_{\alpha 0}^* F) \quad (\text{Proposition C.2})$$

By Corollary 5.11, the pullbacks $\phi_{F_\alpha}^{1-\varepsilon}(L_{\pi_\alpha^*}) \circ L_\alpha(i_{\alpha 0}^* F)$ and $L_{\pi_\alpha^*} \circ L_\alpha(i_{\alpha 0}^* F)$ are the desired Lagrangian sections of $(X_1, \mathfrak{f}_{\text{star}(\alpha)})$ giving

$$(L_0(F + F_\alpha), L_0(F)) \rightsquigarrow L_{\alpha 0} \circ L_\alpha(i_{\alpha 0}^* F). \quad (\text{Proposition 5.10})$$

To obtain the same statement when \check{X}_Σ is a completion of $X_{\text{star}(\alpha)}$, we naively include $(X_1, \mathfrak{f}_{\text{star}(\alpha)})$ into $(X_1, \mathfrak{f}_\Sigma)$. This normally cannot be done (as stop addition usually does not preserve admissibility) however we have already checked that all of the Lagrangians considered are disjoint from \mathfrak{f}_Σ . \square

Proposition 5.20. *Let $\sigma > \alpha$ be a cone, and let $\mathbb{L}_{\underline{i}_{\alpha 0}^* \sigma} \subset \mathbb{L}_{\text{star}(\alpha)/\alpha}$ be the stratum of the skeleton associated to σ . Let $L \subset (X_2, \mathbb{L}_{\text{star}(\alpha)/\alpha})$ be an admissible Lagrangian intersecting $\mathbb{L}_{\underline{i}_{\alpha 0}^* \sigma}$ transversely at k points. Then $(L_{\alpha 0} \circ L)$ intersects \mathbb{L}_σ transversely at k points.*

Proof. The proof is very similar to that of Proposition 5.9. We use Eq. (r -parameterization), and the analogous parameterization of the s -chart.

$$\begin{aligned} L_r \circ L &= \{(j(q_2) + \alpha \cdot t, \pi_\alpha^*(p_2) + d(-\varepsilon K_{12})|_1 + d(r_{\rho c_\varepsilon} \circ \widehat{H}_\alpha^\delta), (q_2, p_2) \in L, t \in \mathbb{R}_{\geq 0}\} \\ L_s \circ L &= \{(j(q_2) + \alpha \cdot t, \pi_\alpha^*(p_2) + d(-\varepsilon K_{12})|_1 + d(s_{\rho c_\varepsilon} \circ \widehat{H}_\alpha^\delta), (q_2, p_2) \in L, t \in \mathbb{R}_{\geq 0}\} \end{aligned}$$

As the condition that $j(q_2) + \alpha \cdot t \in \sigma$ holds for all q_2 and t , the intersection between $L_r \circ L$ and \mathbb{L}_σ is given by the points $(q_2, p_2) \in L$ satisfying

$$\{(q_2, p_2) : \forall \vec{v} \in \sigma, (\pi_\alpha^*(p_2) + d(-\varepsilon K_{12})|_1 + d(r_{\rho c_\varepsilon} \circ \widehat{H}_\alpha^\delta))(\vec{v}) = 0\}.$$

When restricted to the image of j (from Eq. (12)), we can find $\tilde{H}_2 : Q_2 \rightarrow \mathbb{R}$ so that

$$d(-\varepsilon K_{12})|_1 + d(r_{\rho c_\varepsilon} \circ \widehat{H}_\alpha^\delta) \Big|_{j(x)} = \pi_\alpha^* d\tilde{H}_2|_x.$$

We note that for any compact set $V \subset Q_2$, we can choose ε small enough and $r_{\rho c_\varepsilon}$ so that $|\tilde{H}_2|, \|d\tilde{H}_2\|$ are as small as desired. Geometrically, this means that $L_r \circ L_{\alpha 0}$ can be made to approximate \mathbb{L}_α very closely. We can describe the intersection between $L_r \circ L$ and the skeleton component \mathbb{L}_σ by:

$$\begin{aligned} \{(q_2, p_2) : \forall \vec{v} \in \sigma, (\pi_\alpha^*(p_2) + \pi_\alpha^* d\tilde{H}_2)(\vec{v}) = 0, (q_2, p_2) \in L\} \\ = \{(q_2, p_2) : \forall w \in \underline{i}_{\alpha 0}^* \sigma, (p_2 + d\pi_\alpha^* \tilde{H}_2)(w) = 0, (q_2, p_2) \in L\}. \end{aligned}$$

This is the intersection between the \tilde{H}_2 perturbed L , and $\mathbb{L}_{\underline{i}_{\alpha 0}^* \sigma}$. Because we can choose \tilde{H}_2 to be very small, this is in bijection with intersections of L and $\mathbb{L}_{\underline{i}_{\alpha 0}^* \sigma}$.

For the s -chart, we note that the bound from Eq. (11) implies that $L_s \circ L$ is disjoint from the stop. \square

Proposition 5.21. *Let $\sigma > \alpha$ be a cone, and let $(q, p) \in \mathbb{L}_{\underline{i}_{\alpha 0}^* \sigma} \subset \mathbb{L}_{\text{star}(\alpha)/\alpha}$ be a point away from the singular locus of $\mathbb{L}_{\text{star}(\alpha)/\alpha}$, giving us a linking disk $\mathbf{u}(x)$. The Lagrangian $L_{\alpha 0} \circ \mathbf{u}(x)$ is a linking disk or cocore for \mathbb{L}_σ .*

Proof. By Proposition 5.20 we know that $L_{\alpha 0} \circ \mathbf{u}(x)$ intersects \mathbb{L}_σ transversely at a single point. It remains to show that $L_{\alpha 0} \circ \mathbf{u}(x)$ is disjoint from all other skeleton components \mathbb{L}_τ . This can be achieved by computing the valuation and argument of $L_{\alpha 0} \circ \mathbf{u}(x)$. We break into two cases: $\sigma < \tau$ or $\sigma \not\leq \tau$. Denote the $Q_2 \times P_2$ coordinates of x by (q, p)

- If $\sigma < \tau$, then $\alpha < \tau$. See Fig. 12. Because p was chosen outside of the singular locus, $p \in \underline{i}_{\alpha 0}^*(\sigma^\perp) \setminus \underline{i}_{\alpha 0}^*(\tau^\perp)$. Then $\pi_\alpha^*(p) \notin \tau^\perp$, which we will show is enough to separate $L_{\alpha 0} \circ \mathbf{u}(x)$ from \mathbb{L}_τ . We will compute $\arg(L_r \circ \mathbf{u}(x))$ to show that these two sets are disjoint.

$$\arg(L_r \circ \mathbf{u}(x)) = \{\pi_\alpha^*(p_2) + d(-\varepsilon K_{12})|_1 + d(r_{\rho c_\varepsilon} \circ \widehat{H}_\alpha^\delta), (q_2, p_2) \in \mathbf{u}(x)\}.$$

Since $\mathbf{u}(x)$ is a cocore of $\mathbb{L}_{\underline{i}_{\alpha 0}^* \sigma}$, the image of $\arg(\mathbf{u}(x)) \subset P_2$ is contained within a neighborhood of the point p , which is an interior point of $\mathbb{L}_{\underline{i}_{\alpha 0}^* \sigma}$:

$$\{p_2 : (q_2, p_2) \in \mathbf{u}(x)\} \subset B_\varepsilon(p).$$

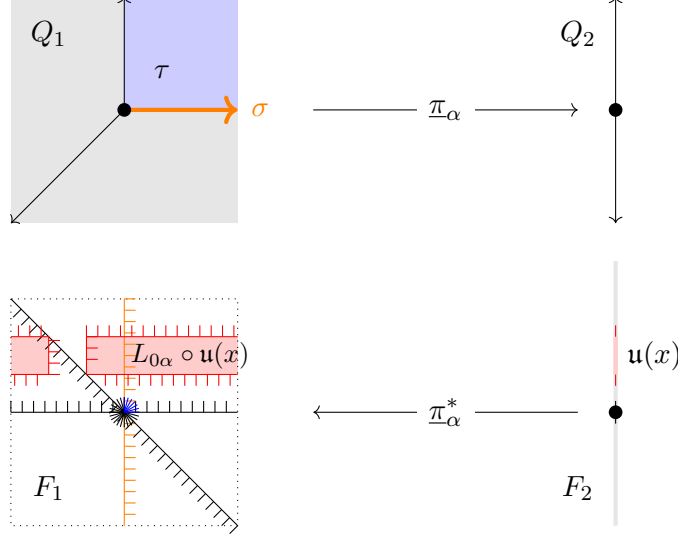

Figure 12. The pushforward of a linking disk is a linking disk.

It follows that the image $\pi_\alpha^*(\arg(\mathbf{u}(x)))$ is contained within a neighborhood of $\pi_\alpha^*(p)$:

$$\{\pi_\alpha^*(p_2) : (q_2, p_2) \in \mathbf{u}(x)\} \subset B_\varepsilon(\pi_\alpha^*(p)).$$

Since $d(-\varepsilon K_{12})|_1$ is small, $|d(r_{\rho c_\varepsilon} \circ \widehat{H}_\alpha^\delta)(\alpha)| < 2\pi$, and $d(r_{\rho c_\varepsilon} \circ \widehat{H}_\alpha^\delta)(v)$ is approximately $\alpha \cdot v$, we obtain that $\arg(L_r \circ \mathbf{u}(x))$ is contained within a small neighborhood $(\pi_\alpha^*(p) + t\alpha)$. This is disjoint from τ^\perp , so $L_{0\alpha} \circ \mathbf{u}(x)$ is disjoint from \mathbb{L}_τ .

- If $\sigma \not\leq \tau$, then observe that

$$u(\tilde{L}_r \mathbf{u}(x)) = i(q_2) + \alpha \cdot \mathbb{R}_{>0}$$

is contained within the interior of $\text{star}(\sigma)$. Since $\sigma \not\leq \tau$, $u(\mathbb{L}_\tau) = \tau$ does not intersect the interior of $\text{star}(\sigma)$.

A similar argument holds for L_s . □

Remark 5.22. The picture from Fig. 10d can lead to the misconception that the Lagrangian $L_{\alpha>0} := L_{\alpha 0} \circ L_\alpha(0)$ is the linking disk to \mathbb{L}_α . This is usually *not* a linking disk, as the Lagrangian $L_\alpha(0)$ is not a cocore or linking disk of the skeleton of $\mathbb{L}_{\text{star}(\alpha)/\alpha}$ as the origin is contained in the singular locus. After applying a Hamiltonian perturbation, $L_\alpha(0)$ is seen to hit several skeleton components. Furthermore, it is inaccurate to say that \mathbb{L}_α has a linking disk, as the linking disks of \mathbb{L}_α are in general not admissibly Hamiltonian isotopic.

In the particular case where $\check{X}_\Sigma = \mathbb{C}\mathbb{P}^1$, it is a coincidence that $L_\alpha(0) \subset X_{\text{star}(\alpha)/\alpha} = \{pt\}$ is a point, so it trivially is a linking disk. Therefore its pushforward as drawn in Fig. 10d is the linking disk.

Corollary 5.23. *Let $\alpha \in \Sigma$ be a one-dimensional cone, and $\sigma \in \text{star}(\alpha)$ a cone. Let $x \in \mathbb{L}_\sigma$ be a point of the FLTZ skeleton that does not lie in the singular locus. Then there exists a linking disk which is admissibly Hamiltonian isotopic to $\mathbf{u}(x)$, and is contained in the image of $L_{\alpha 0}$.*

Proof. Let $\gamma : [0, 1] \rightarrow \mathbb{L}_\sigma$ be a path. The Lagrangian linking disks $\mathbf{u}(\gamma(t))$ are Lagrangian isotopic if the path γ is disjoint from \mathbb{L}_τ , with $\tau > \sigma$ and $|\tau| = |\sigma| + 1$. Since σ is contained in the star of α , $\tau > \sigma \geq \alpha$. Therefore, the line $(x_0 + \alpha\mathbb{R}) \cap \mathbb{L}_\sigma$ is disjoint from all of the \mathbb{L}_τ . Since $(x_0 + \alpha\mathbb{R}) \cap \mathbb{L}_\sigma$ intersects every section of $\pi_\alpha : Q_1 \rightarrow Q_2$, it follows that there always exists a path from x to the image of $j : Q_2 \rightarrow Q_1$ which is disjoint from the singular locus of the FLTZ skeleton. We may therefore assume that after taking an admissible Hamiltonian isotopy, the cocore $\mathbf{u}(x)$ is centered at a point $x = (q_1, p_1)$, where q_1 is contained within the image of $j : Q_2 \rightarrow Q_1$. Let q_2 be the point in Q_2 so that $j(q_2) = q_1$. Since $x \in \mathbb{L}_\sigma$, $p_1 \cdot \alpha = 0$ and there exists p_2 so that $\pi_\alpha^* p_2 = p_1$. The point $x' = (q_2, p_2) \in X_2$ lies in the FLTZ component $\mathbb{L}_{i^*_{\alpha 0} \sigma}$. Construct a linking disk $\mathbf{u}_{\mathbb{L}_{\text{star}(\alpha)/\alpha}}(x')$ for this point. The pushforward $L_{\alpha 0} \circ (\mathbf{u}_{\mathbb{L}_{\text{star}(\alpha)/\alpha}}(x'))$ is a linking disk for \mathbb{L}_σ , which by design intersects \mathbb{L}_σ at x . \square

6 Applications

We now look at applications of the constructions from Sections 3 and 5. The main idea is to combine Corollary 3.6, which proves homological mirror symmetry for the subcategory generated by tropical Lagrangian sections, with Theorem 5.1, which constructs Lagrangian correspondences acting on those tropical Lagrangian sections.

In Section 6.1, we leverage those two theorems to show that tropical Lagrangian sections generate the partially wrapped Fukaya category. This proves Corollary D, identifying the partially wrapped Fukaya category of $((\mathbb{C}^*)^n, \mathfrak{f}_\Sigma)$ with the derived category of coherent sheaves on smooth projective \check{X}_Σ . We look at the specific example of $\mathbb{C}\mathbb{P}^n$ in Section 6.1.3, recovering the mirror to the Beilinson exceptional collection. We then examine how the stop removal functor on \mathfrak{f}_Σ behaves under this mirror identification. In Sections 6.2 and 6.3, we use our matching of linking disks to line bundles supported on toric strata to identify the mirror operations to localization away from a toric orbit of \check{X}_Σ and toric blow-up of \check{X}_Σ . The former allows us to deduce homological mirror symmetry for smooth quasi-projective toric varieties.

6.1 Generation by tropical sections

In this section, we show that the partially wrapped Fukaya category, $\mathcal{W}((\mathbb{C}^*)^n, \mathfrak{f}_\Sigma)$ is generated by the tropical sections $L_0(F)$.

Definition 6.1. Let \mathcal{C} be a triangulated category. We say that objects $A_1, \dots, A_k \in \mathcal{C}$ generate $A_0 \in \mathcal{C}$ if there exist objects $Z_1, \dots, Z_k \in \mathcal{C}$, and exact triangles

$$A_i \rightarrow Z_{i-1} \rightarrow Z_i \quad \forall 2 \leq i \leq k$$

with $Z_1 = A_1$ and $Z_k = A_0$. If every object of a subcategory \mathcal{C}' can be generated by objects A_1, \dots, A_k , we write $\mathcal{C}' = \langle A_1, \dots, A_k \rangle$.

Theorem 6.2. *Tropical sections generate $\mathcal{W}((\mathbb{C}^*)^n, \mathfrak{f}_\Sigma)$.*

The idea of the proof is as follows. We will use an inductive argument with Theorem 5.1 to show that there are Lagrangian cobordisms with left ends Lagrangian sections $L(F)$ and right end a given linking disk $\mathbf{u}(x_i)$ with $x_i \in \mathbb{L}_\sigma$ and $\sigma > \alpha$. By Theorem A.3, this means that Lagrangian sections generate the linking disks of $((\mathbb{C}^*)^n, \mathfrak{f}_\Sigma)$. We then use [GPS18b, Theorem 1.1] to obtain generation of $\mathcal{W}((\mathbb{C}^*)^n, \mathfrak{f}_\Sigma)$. We obtain homological mirror symmetry by identifying the category

$$\begin{array}{ccc}
\langle L(F) \rangle & \xleftarrow{[\text{Abo09}]} \longrightarrow & \langle \mathcal{O}(F) \rangle \\
\downarrow & & \downarrow \\
\text{Corollary 5.23, [BC14]} & & \text{Proposition 6.3} \\
\downarrow & & \downarrow \\
\langle \mathbf{u}(x) \rangle & & \langle (i_{\sigma,0})_* \mathcal{O}_{\sigma>0} \rangle \\
\downarrow & & \downarrow \\
[\text{GPS18b, Thm. 1.1}] & & [\text{Abo09, Prop. 1.3}] \\
\downarrow & & \downarrow \\
\mathcal{W}((\mathbb{C}^*)^n, \mathfrak{f}_\Sigma) & \xleftarrow{\text{-----}} \longrightarrow & D^b \text{Coh}(\check{X}_\Sigma)
\end{array}$$

Figure 13. Theorems for generation of $D^b \text{Coh}(\check{X}_\Sigma)$ and its mirror.

generated by Lagrangian sections with the category of line bundles on the mirror, and [Abo09, Proposition 1.3] which states that line bundles generate $D^b \text{Coh}(\check{X}_\Sigma)$. A summary of the steps is given in Fig. 13.

Proposition 6.3 is a standard fact for toric varieties, whose proof is in the same spirit as the proof of Theorem 6.2.

Proposition 6.3 (B-generation). *Suppose that the following statement holds for all smooth toric varieties \check{X}_Σ with $\dim(\Sigma) < n$: For every cone $\sigma \in \Sigma$ and line bundle $\mathcal{O}_\sigma(F)$ on $\check{X}_{\text{star}(\sigma)/\sigma}$, there are line bundles $\mathcal{O}_0(F_1), \dots, \mathcal{O}_0(F_{2^{|\Sigma|-|\sigma|}})$ generating $\mathcal{O}_{\sigma>0}(F)$ in $D^b \text{Coh}(\check{X}_\Sigma)$.*

Then the same statement holds for all smooth toric varieties \check{X}_Σ with $\dim(\Sigma) = n$.

Proof. Let $\sigma \in \Sigma$ be a cone, $|\Sigma| = n, |\sigma| = k$ and $F \in \text{Supp}_\sigma(\Sigma)$ be a support function whose support is transverse to σ . Let $\alpha > \sigma$ be a 1-dimensional cone. Recall that $\mathcal{O}_{\sigma>0}(\check{i}_{\sigma 0}^* F) := (i_{\alpha 0})_*(\mathcal{O}_{\sigma>\alpha}(\check{i}_{\sigma 0}^* F))$. By the inductive hypothesis, there exists support functions $\tilde{F}_1, \dots, \tilde{F}_{2^{n-1-k}} \in \text{Supp}(\text{star}(\alpha)/\alpha)$ with $F(\alpha) \neq 0$ only if $\alpha' \in \check{i}_{\sigma 0}^* \sigma$, so that $\{\mathcal{O}_\alpha(F_i)\}$ generate $\mathcal{O}_{\sigma>\alpha}(F) \in D^b \text{Coh}(X_{\text{star}(\alpha)/\alpha})$. Take $F_1, \dots, F_{2^{n-1-k}} \in \text{Supp}_\alpha(\Sigma)$ so that $(i_{\alpha 0})^*(F_i) = \tilde{F}_i$. The exact sequence

$$\mathcal{O}_0(F_i + F_\alpha) \rightarrow \mathcal{O}_0(F_i) \rightarrow (i_{\alpha 0})_*(\mathcal{O}_\alpha(\tilde{F}_i))$$

shows that the line bundles with support functions $\{F_i, F_i + F_\alpha\}_{i=1}^{2^{n-1-k}}$ generate $\mathcal{O}_{\alpha>0}(\tilde{F}_i)$. As triangles in the derived category are preserved by $(i_{\alpha 0})_*$, we get that $\{\mathcal{O}_0(F_i), \mathcal{O}_0(F_i + F_\alpha)\}_{i=1}^{2^{n-1-k}}$ generate $\mathcal{O}_{\sigma>0}(\check{i}_{\sigma 0}^* F)$ as desired. \square

Another way to see that $\mathcal{O}_\sigma(F)$ can be generated from line bundles is to build them entirely inside $D^b \text{Coh}(\check{X}_\Sigma)$ by iterating the exact sequence:

$$\mathcal{O}_\sigma(F + F_\alpha) \rightarrow \mathcal{O}_\sigma(F) \rightarrow \mathcal{O}_\tau(\check{i}_{\tau\sigma}^* F) \tag{14}$$

where $F \in \text{Supp}_\tau(\text{star}(\sigma)/\sigma)$, and $\langle \tau, \alpha \rangle = \sigma$ with $\alpha \notin \tau$. Understanding the mirror to this exact sequence is the basis for the (motivational and expository) Section 6.1.1, where we build the linking disks in the mirror of $\mathbb{C}\mathbb{P}^2$ using piecewise linear representations of Lagrangian sections and linking disks. Later, in Section 6.1.2, we prove Corollary 5.23, which is the A -model analogue to Proposition 6.3.

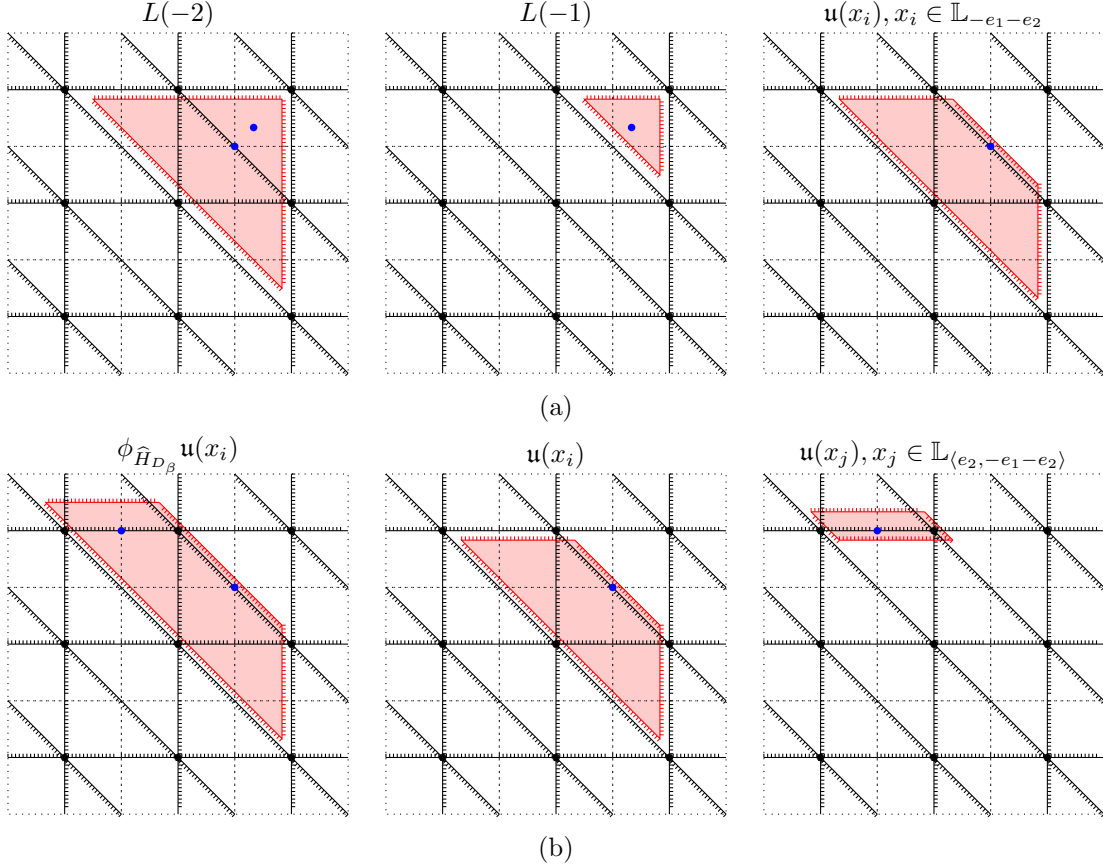

Figure 14. Generating a linking disk for the mirror of $\mathbb{C}\mathbb{P}^2$ from twists of linking disks. Here $x_i \in \mathbb{L}_\alpha$, $\beta \neq \alpha \in A$ and x_j is in $\mathbb{L}_{\langle \alpha, \beta \rangle}$.

6.1.1 Warm up: Generation of the mirror to $\mathbb{C}\mathbb{P}^2$.

We now explain Fig. 14, which demonstrates how tropical Lagrangian sections generate linking disks in the mirror to $\mathbb{C}\mathbb{P}^2$. The basic principle is to use Lagrangian surgery to inductively remove intersection points with the FLTZ skeleton. We consider the fan whose one-dimensional cones are e_1, e_2 and $-e_1 - e_2$. The Lagrangian $L(-2)$ intersects²¹ the FLTZ skeleton components \mathbb{L}_0 and $\mathbb{L}_{-e_1-e_2}$, while the Lagrangian $L(-1)$ is a cocore for \mathbb{L}_0 . The surgery of these two Lagrangian submanifolds yields a Lagrangian which only intersects $\mathbb{L}_{-e_1-e_2}$; a candidate linking disk. This process will generate all of the linking disks of the \mathbb{L}_α for $\alpha \in A$. However, to generate the linking disks to strata indexed by larger cones, one has to repeat this process with twists of $u(x_i)$, where $x_i \in \mathbb{L}_\alpha$. For example Fig. 14b, shows how the linking disk to $\mathbb{L}_{\langle \alpha_2, -\alpha_1 - \alpha_2 \rangle}$ is generated, where $\langle \alpha_2, -\alpha_1 - \alpha_2 \rangle$ is a maximal cone. These pictures, while instructional, quickly become unwieldy; furthermore, checking that these Lagrangian disks all intersect appropriately to generate surgery data is difficult. For those reasons, we instead use the machinery developed in Section 5 to build the Lagrangian disks.

²¹As drawn, $L(-2)$ is not a cocore. However, it is Hamiltonian isotopic to a cocore.

6.1.2 Generation

Proposition 6.4 (A-generation). *Let $\sigma \in \Sigma$ be a cone with $|\sigma| = k$. Let $x \in \mathbb{L}_\sigma$ be an internal point of the FLTZ skeleton. Then there exists Lagrangian sections $L_0(F_1), \dots, L_0(F_{2^k})$ and a Lagrangian cobordism $K : (L_0(F_1), \dots, L_0(F_{2^k})) \rightsquigarrow \mathbf{u}(x_i)$, where $\mathbf{u}(x_i)$ is the linking disk to \mathbb{L}_σ . Furthermore, K has the topology of a disk.*

Proof. We prove by induction on the dimension of the fan. If \check{X}_Σ is 0 dimensional, then the FLTZ stop is empty, concluding the proof.

Now suppose that $((\mathbb{C}^*)^n, \mathfrak{f}_\Sigma)$ is the mirror to a toric variety. Suppose that $|\sigma| \geq 1$. Then there exists a 1-dimensional cone α with $\alpha \leq \sigma$. By the induction hypothesis, there is a Lagrangian cobordism

$$K' : (L_\alpha(F_1), \dots, L_\alpha(F_{2^{k-1}})) \rightsquigarrow L_{\sigma > \alpha}$$

where $L_{\sigma > \alpha}$ is the linking disk to $\mathbb{L}_{\underline{i}_{\alpha 0}^* \sigma} \subset \mathbb{L}_{\text{star}(\alpha)/\alpha}$. Furthermore, K' is a disk. We can construct a cobordism using Proposition C.2,

$$L_{\alpha 0} \circ K' : (L_{\alpha 0} \circ L_\alpha(F_1), \dots, L_{\alpha 0} \circ L_\alpha(F_{2^{k-1}})) \rightsquigarrow L_{\alpha 0} \circ L_{\sigma > \alpha}.$$

From Proposition 5.21 and Corollary 5.23, $L_{\alpha 0} \circ L_{\sigma > \alpha}$ is a linking disk to \mathbb{L}_σ . By Proposition 5.16, $L_{\alpha 0} \circ K'$ has the topology of a disk. Because support functions on $\text{star}(\alpha)/\alpha$ all arise by pulling back support functions on Σ , we can take $\tilde{F}_i \in \text{Supp}(\Sigma)$ so that $\underline{i}_{\alpha 0}^* \tilde{F}_i = F_i$. By Proposition 5.19, there exists for every F_i a Lagrangian cobordism

$$K_i : (L(\tilde{F}_i + F_\alpha), L(\tilde{F}_i)) \rightsquigarrow L_{\alpha 0} \circ L_\alpha(\underline{i}_{\alpha 0}^* \tilde{F}_i) = L_{\alpha 0} \circ L_\alpha(F_i).$$

We define K to be the composition of $L_{\alpha 0} \circ K'$ with all of the K_i . □

Proof of Theorem 6.2. From Proposition 6.4 there exists a Lagrangian cobordism with the topology of a disk, right ends on a linking disk $L_{\sigma > 0}$ of \mathbb{L}_σ , and left ends on sections $L_0(F)$. By Theorem A.3, the Lagrangian sections $L_0(F_i)$ generate $L_{\sigma > 0}$, which in turn generate $\mathcal{W}((\mathbb{C}^*)^n, \mathfrak{f}_\Sigma)$ by [GPS18b, Theorem 1.10]. □

We expect the argument of Proposition 4.5 can be pushed through the inductive construction of the linking disks to identify $L_{\sigma > 0}$ with $\mathcal{O}_{\sigma > 0}$ under the derived equivalence between $\mathcal{W}((\mathbb{C}^*)^n, \mathfrak{f}_\Sigma)$ and $\text{Coh}(\check{X}_\Sigma)$.

6.1.3 Returning to generation of the mirror to $\mathbb{C}\mathbb{P}^n$.

Recall from Section 3.3 that we gave an explicit description of the cocores in the mirror to $\mathbb{C}\mathbb{P}^n$. We now examine the subcategory generated by these Lagrangian sections.

Proposition 6.5. *Consider $((\mathbb{C}^*)^n, \mathfrak{f}_{\Sigma_n})$, the mirror to the toric variety $\mathbb{C}\mathbb{P}^n$. Let τ be a cone of codimension at least k , and let $x \in \mathbb{L}_\tau$ be an interior point. The Lagrangians $L(-k), \dots, L(-n)$ generate $\mathbf{u}(x)$.*

Proof. We proceed by induction. For the mirror to $\mathbb{C}\mathbb{P}^1$, it is clear. Now assume that the statement holds for $((\mathbb{C}^*)^{n-i}, \mathfrak{f}_{\Sigma_{n-1}})$. Let $\tau \in \Sigma_n$ be a non-maximal cone. In the case where $\tau = 0$, this is Lemma 3.14. Otherwise, let $\alpha < \tau$ be a 1-dimensional cone. By Corollary 5.23, we know that there exists $y \in \mathbb{L}_{\underline{i}_{\alpha 0}^* \tau} \subset \mathbb{L}_{\text{star}(\alpha)/\alpha}$ so that $L_{\alpha 0} \circ \mathbf{u}(y)$ is Hamiltonian isotopic to $\mathbf{u}(x)$. Furthermore, $\mathbf{u}(y)$ can be generated by $L_\alpha(-k), \dots, L_\alpha(n-1)$. Since $L_{\alpha 0} \circ L_\alpha(-i)$ is generated by $L(-i), L(-i-1)$, we conclude that $\mathbf{u}(x)$ can be generated by $L(-k), \dots, L(-n)$. □

When adding the zero section, we obtain the mirror to the well-known Beilinson exceptional collection for $\mathbb{C}\mathbb{P}^n$.

Corollary 6.6. *Let Σ_n be the fan for $\mathbb{C}\mathbb{P}^n$. The Lagrangian cocores $L(-n), \dots, L(-1)$ and the zero section $L(0)$ are a full exceptional collection for $\mathcal{W}((\mathbb{C}^*)^n, \mathfrak{f}_{\Sigma_n})$*

It may be interesting to study in what sense the line bundles corresponding to cocores in an arbitrary \check{X}_Σ generalize this example.

6.2 Removing toric strata

We now examine the relation between Theorem 5.1 and stop removal. We say that a stopped Liouville domain (X, \mathfrak{f}') is obtained by stop removal from (X, \mathfrak{f}) if $\mathfrak{f}' \subset \mathfrak{f}$ and $\mathfrak{f}' \setminus \mathfrak{f}$ is mostly Legendrian.

Theorem 6.7 ([GPS18b]). *Let (X, \mathfrak{f}) be a stopped Liouville domain, which is obtained from another stopped Liouville domain (X, \mathfrak{f}') by stop removal. Let \mathcal{D} be the subcategory generated by Lagrangian linking disks of $\mathfrak{f}' \setminus \mathfrak{f}$. There is an exact sequence*

$$\mathcal{D} \rightarrow \mathcal{W}(X, \mathfrak{f}') \rightarrow \mathcal{W}(X, \mathfrak{f}).$$

We are interested in stop removal for the FLTZ skeleton. Consider the upward closure of σ , $\text{star}(\sigma) = \{\tau \in \Sigma : \tau \geq \sigma\}$. The stop $\mathfrak{f}_{\Sigma \setminus \text{star}(\sigma)}$ is obtained from \mathfrak{f}_Σ by stop removal at the set $\mathfrak{g} := \left(\bigcup_{\tau \subset \text{star}(\sigma)} \mathfrak{f}_\tau \setminus \bigcup_{\tau' \neq \tau} \mathfrak{f}_{\tau'} \right)$. The linking disks of \mathfrak{g} are in bijection with the linking disks of $\bigcup_{\tau \subset \text{star}(\sigma)} \mathfrak{f}_\tau$. The toric variety $\check{X}_{\Sigma \setminus \text{star}(\sigma)}$ is $\check{X}_\Sigma \setminus \check{X}_{\text{star}(\sigma)/\sigma}$, the complement of the toric orbit closure associated to σ .

Proposition 6.8. *$\mathcal{W}(X, \mathfrak{f}_{\Sigma \setminus \text{star}(\sigma)})$ is derived equivalent to $D^b \text{Coh}(\check{X}_{\Sigma \setminus \text{star}(\sigma)})$, and the acceleration functor*

$$\mathcal{W}(X, \mathfrak{f}_\Sigma) \rightarrow \mathcal{W}(X, \mathfrak{f}_{\Sigma \setminus \text{star}(\sigma)})$$

is mirror to the pullback functor

$$\check{i}^* : D^b \text{Coh}(\check{X}_\Sigma) \rightarrow D^b \text{Coh}(\check{X}_{\Sigma \setminus \text{star}(\sigma)})$$

Proof. Let $\mathcal{D}_{\text{star}(\sigma)}$ be the full subcategory generated by linking disks of \mathfrak{g} . We must identify $\check{\mathcal{D}}$, the mirror of $\mathcal{D}_{\text{star}(\sigma)}$ in $D^b \text{Coh}(\check{X}_\Sigma)$. By Corollary 5.23, the generating set of $\mathcal{D}_{\text{star}(\sigma)}$ is contained within the image of $L_{\sigma 0} : ((\mathbb{C}^*)^{n-k}, \mathfrak{f}_{\text{star}(\sigma)/\sigma}) \Rightarrow ((\mathbb{C}^*)^n, \mathfrak{f}_\Sigma)$. These linking disks can therefore be generated by Lagrangians of the form $L_{\sigma > 0}(F)$. Similarly, the linking disks in $\mathcal{D}_{\text{star}(\sigma)}$ are pushforwards of linking disks in $((\mathbb{C}^*)^{n-k}, \mathfrak{f}_{\text{star}(\sigma)/\sigma})$, and therefore generate the Lagrangians $L_{\sigma > 0}(F)$. In summary,

$$\mathcal{D}_{\text{star}(\sigma)} = \langle L_{\sigma > 0}(F) \rangle.$$

For notational brevity, let $\check{X} = \check{X}_\Sigma$, and let $\check{Z} = \check{X}_{\text{star}(\sigma)/\sigma} \subset \check{X}_\Sigma$. On the mirror, $\check{i}_*(D^b \text{Coh}(\check{Z}))$ is generated by the sheaves $\mathcal{O}_{\sigma > 0}(F)$, which are mirror to the Lagrangians $L_{\sigma > 0}(F)$. It follows that $\text{Ob}(\check{i}_*(D^b \text{Coh}(\check{Z}))) = \text{Ob}(\check{\mathcal{D}})$.

Let $D^b \text{Coh}_{\check{Z}}(X)$ denote the Serre subcategory of sheaves whose cohomology sheaves are supported on \check{Z} . Then by [AB10, Lemma 2.13], $\text{Ob}(D^b \text{Coh}_{\check{Z}}(\check{X})) \subseteq \text{Ob}(\check{i}_*(D^b \text{Coh}(\check{Z})))$. It is

clear that the cohomology sheaf of any $\mathcal{F} \in \check{\mathcal{D}}$ will be supported in \check{Z} , so $\text{Ob}(D^b \text{Coh}_{\check{Z}}(X)) = \text{Ob}(\check{i}_*(D^b \text{Coh}(\check{Z}))) = \text{Ob}(\check{\mathcal{D}})$, and in particular

$$D^b \text{Coh}_{\check{Z}}(\check{X}) = \check{\mathcal{D}}.$$

By [Rou10, Remark 3.14], there exists an exact sequence of categories

$$D^b \text{Coh}_{\check{Z}}(\check{X}) \rightarrow D^b \text{Coh}(\check{X}) \rightarrow D^b \text{Coh}(\check{X} \setminus \check{Z}),$$

which is then mirror to

$$\mathcal{D}_{\text{star}(\sigma)} \rightarrow \mathcal{W}(X, \mathfrak{f}_\Sigma) \rightarrow \mathcal{W}(X, \mathfrak{f}_{\Sigma \setminus \text{star}(\sigma)})$$

using the universal property of quotients of A_∞ categories and that exact dg-Verdier sequences are also universal in the ∞ -category of A_∞ categories as shown in [OT20]. \square

By iterating this stop removal, we can extend Corollary D to quasi-projective toric varieties. Note that the resulting equivalence still takes tropical Lagrangian sections to line bundles, but the tropical Lagrangian sections now must be wrapped to compute their morphisms.

Corollary 6.9. *Let \check{X}_Σ be a smooth quasi-projective toric variety. The toric variety \check{X}_Σ is homologically mirror to (X, \mathfrak{f}_Σ) .*

Remark 6.10. Unlike projective toric varieties, quasi-projective toric varieties can be Calabi-Yau, and thus, can have mirrors that are spaces. Moreover, homological mirror symmetry for these mirrors has been studied in some examples (see, for instance, [CPU16]). It would be interesting to geometrically relate the Fukaya categories of the Calabi-Yau mirrors with those of the stopped domains in Corollary 6.9. One reasonable approach may be to use the dual fan constructions of [Cla16].

6.3 Blow-up functors

We briefly discuss toric blow-up in order to fix notation. Consider a smooth projective toric variety \check{X}_Σ with $\Sigma \subset Q$. Let $\tau = \langle \alpha_i \rangle_{i=1}^{n-k}$ be a codimension k cone of Σ , so that $\check{X}_{\text{star}(\tau)/\tau}$ is a k -dimensional compact subvariety of \check{X}_Σ . Let $A_{\text{star}(\tau)/\tau} = \{\beta_j/\tau\}_{j=1}^m$ be the one-dimensional cones of $\text{star}(\tau)/\tau$, and to each β_j/τ let β_j be the corresponding primitive generator of Σ . As $\text{star}(\tau)/\tau$ is complete, there are at least k such cones.

The normal bundle $N_{\check{X}_\Sigma, \check{X}_{\text{star}(\tau)/\tau}}$ is a toric variety with fan $\text{star}(\tau) \subset \Sigma$. We now describe a splitting of $N_{\check{X}_\Sigma, \check{X}_{\text{star}(\tau)/\tau}}$ as the sum of toric line bundles $\bigoplus_{i=1}^{n-k} \mathcal{O}_{\text{star}(\tau)/\tau}(F_i)$. The support functions $F_i : Q/\tau \rightarrow \mathbb{R}$ are constructed by choosing an identification $Q = \mathbb{R}\langle \beta_j \rangle_{j=1}^k \times \mathbb{R}\langle \alpha_i \rangle_{i=1}^{n-k}$. Using the splitting, write each primitive lift β of $\beta/\tau \in A_{\text{star}(\tau)/\tau}$ as

$$\beta = \left(\sum_{j=1}^k b_j \beta_j \right) + \left(\sum_{i=1}^{n-k} a_i \alpha_i \right).$$

We define $F_i(\beta) := a_i$. From this construction, we see that the total space $\bigoplus_{i=1}^{n-k} \mathcal{O}_{\text{star}(\tau)/\tau}(F_i)$ is the toric variety $\check{X}_{\text{star}(\tau)}$.

There is a \mathbb{C}^* action on $\check{X}_{\text{star}(\tau)}$ coming from the primitive element $\alpha := \alpha_1 + \dots + \alpha_{n-k} \in \mathbb{R}\langle \beta_j \rangle_{j=1}^k \times \mathbb{R}\langle \alpha_i \rangle_{i=1}^{n-k}$. We note that the toric strata fixed by this action are indexed by cones which

contain α . These are exactly the cones dominating $\tau = \langle \alpha_1, \dots, \alpha_{n-k} \rangle$, i.e., the cones of $\text{star}(\tau)/\tau$. It will be convenient for us to write

$$\mathbb{R}\langle \beta_j \rangle_{j=1}^k \times \mathbb{R}\langle \alpha_i \rangle_{i=1}^{n-k} = (Q/\tau) \times (\mathbb{R}\langle \alpha_i/\alpha \rangle_{i=2}^{n-k}) \times \mathbb{R}\langle \alpha \rangle$$

In these coordinates, the primitives $\beta/\tau \in A_{\text{star}(\tau)/\tau}$ lift to primitives $\beta \in A_{\text{star}(\tau)}$ as

$$\beta = \left(\sum_{j=1}^k b_j \beta_j, \sum_{i=2}^{n-k} (F_i(\beta/\tau) - F_1(\beta/\tau)) \alpha_i/\alpha, F_1(\beta/\tau) \alpha \right).$$

These should be compared to the coordinates chosen in the top right and top middle diagrams of Fig. 15. The quotient by the $(\mathbb{C}^*)^\alpha$ action is the projectivization $\mathbb{P}(N_{\check{X}_\Sigma} \check{X}_{\text{star}(\tau)/\tau}) = \check{X}_{\text{star}(\tau)/\alpha}$. The α -coordinate gives a support function $F_\alpha : Q/\alpha \rightarrow \mathbb{R}$, which on one-dimensional cones $\alpha_i/\alpha, \beta/\alpha \in A_{\text{star}(\tau)/\alpha}$ takes values

$$F_\alpha(\alpha_i/\alpha) = \begin{cases} 0 & i \neq 1 \\ 1 & i = 1 \end{cases} \quad F_\alpha(\beta) = F_1(\beta/\tau)$$

The associated line bundle $\mathcal{O}_{\text{star}(\tau)/\alpha}(F_\alpha)$ is the tautological bundle of the projectivization. The total space of the associated line bundle is the blow-up of $N_{\check{X}_\Sigma} \check{X}_{\text{star}(\tau)/\tau}$ at $\check{X}_{\text{star}(\tau)/\tau}$, and has cones given by the graph of F_α

$$\text{Bl}_\alpha(\text{star}(\tau)) : \{(\sigma, F_\alpha(\sigma)) : \sigma \in \text{star}(\tau)/\alpha\} \cup \{(\sigma', F_\alpha(\sigma')), \alpha\} : \sigma' \in \text{star}(\tau)/\alpha\}$$

The blow-up of Σ at τ can also be described by the α -subdivision of the fan Σ ,

$$\text{Bl}_\alpha(\Sigma) := \{\sigma \in \Sigma : \alpha \notin \sigma\} \cup \{(\sigma', \alpha) : \sigma' \in \Sigma, \alpha \notin \sigma', \exists \sigma \in \Sigma \text{ with } \langle \sigma', \alpha \rangle \subset \sigma\}.$$

We'll be interested in the symplectic and complex lifts of this blow-up of fans.

$$\begin{array}{ccc} D^b \text{Coh}(\check{X}_{\text{star}(\alpha)/\alpha}) & \xrightarrow{\check{j}_*} & D^b \text{Coh}(\check{X}_{\text{Bl}_\alpha(\Sigma)}) & ((\mathbb{C}^*)^{n-1}, \mathfrak{f}_{\text{star}(\alpha)/\alpha}) & \xrightarrow{L_{\alpha 0}} & ((\mathbb{C}^*)^{n-1}, \mathfrak{f}_{\text{Bl}_\alpha(\Sigma)}) \\ \check{p}^* \uparrow & & \check{\pi}^* \uparrow & L_{p^*} \uparrow & & L_{\pi^*} \uparrow \\ D^b \text{Coh}(\check{X}_{\text{star}(\tau)/\tau}) & \xrightarrow{\check{i}_*} & D^b \text{Coh}(\check{X}_\Sigma) & ((\mathbb{C}^*)^k, \mathfrak{f}_{\text{star}(\tau)/\tau}) & \xrightarrow{L_{\tau > 0}} & ((\mathbb{C}^*)^n, \mathfrak{f}_\Sigma). \end{array}$$

On the B -side, Orlov's blow-up formula gives a semi-orthogonal decomposition for the derived category of the blow-up.

Theorem 6.11 ([Orl93]). *Let $\check{X}_{\text{Bl}_\alpha(\Sigma)} \rightarrow \check{X}_\Sigma$ be the blow-up at a smooth center $\check{Z} := \check{X}_{\text{star}(\tau)/\tau}$ of dimension k . The derived functors*

$$\begin{aligned} \Phi_{-k} &:= \mathcal{O}_{\check{X}_{\text{star}(\alpha)/\alpha}}(kF_\alpha) \otimes \check{j}_* \check{p}^* : D^b \text{Coh}(\check{Z}) \rightarrow D^b \text{Coh}(\check{X}_{\text{Bl}_\alpha(\Sigma)}) \\ \check{\pi}^* &: D^b \text{Coh}(\check{X}_\Sigma) \rightarrow D^b \text{Coh}(\check{X}_{\text{Bl}_\alpha(\Sigma)}) \end{aligned}$$

are fully faithful. Furthermore, $D^b \text{Coh}(\check{X}_{\text{Bl}_\alpha(\Sigma)})$ has semi-orthogonal decomposition

$$D^b \text{Coh}(\check{X}_{\text{Bl}_\alpha(\Sigma)}) = \left\langle \Phi_{-(n-k)} D^b \text{Coh}(\check{Z}), \dots, \Phi_{-1} D^b \text{Coh}(\check{Z}), \check{\pi}^* D^b \text{Coh}(\check{X}_\Sigma) \right\rangle^\perp.$$

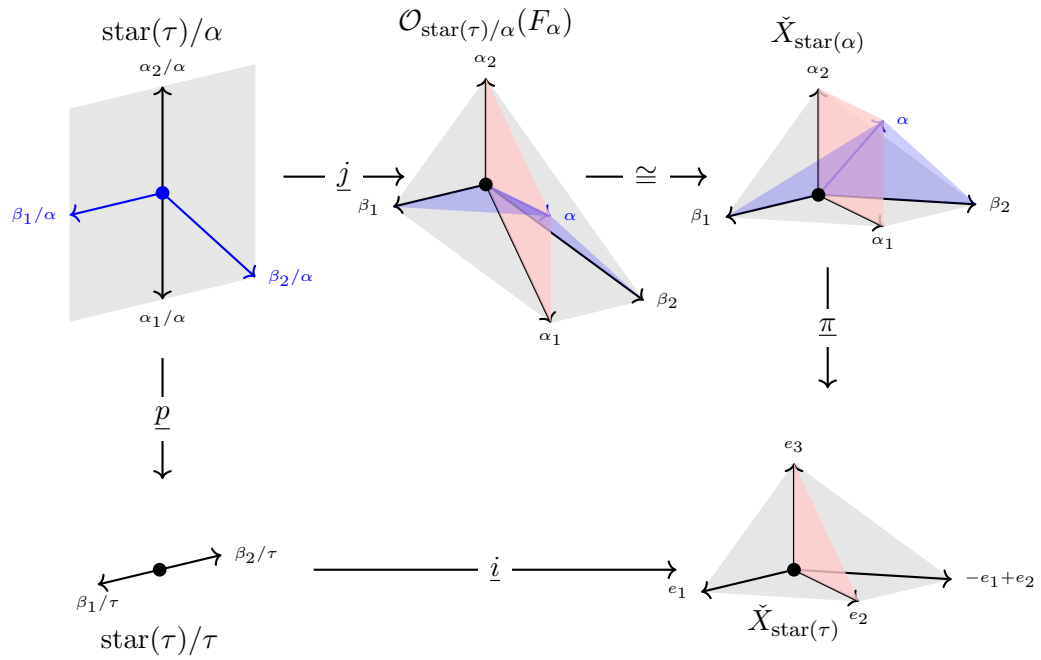

Figure 15. Blow-up of the curve τ , highlighted in red in the bottom right. The cones of T and T/α are marked in blue. In this example, all of the cones of T have fiber codimension 0.

We will now work towards an the analogous result on the mirror side. We begin by examining the FLTZ skeleton of the blow-up. Since $\text{Bl}_\alpha(\Sigma)$ is obtained from Σ by removing the cones $\sigma \geq \tau$ and adding in cones of the form $\langle \sigma, \alpha \rangle$, we can cover the FLTZ stop by

$$\mathfrak{f}_{\text{Bl}_\alpha(\Sigma)} = \left(\mathfrak{f}_\Sigma \setminus \bigcup_{\sigma \geq \tau} \mathfrak{f}_\sigma \right) \cup \left(\bigcup_{\sigma \in \text{Bl}_\alpha(\Sigma), \sigma \geq \alpha} \mathfrak{f}_\sigma \right).$$

For each $\sigma > \tau$ spanned by $\sigma = \langle \alpha_1, \dots, \alpha_{n-k}, \beta_{j_1}, \dots, \beta_{j_l} \rangle$, let

$$\sigma_{\alpha_i, \alpha} := \langle \alpha, \alpha_1, \dots, \alpha_{i-1}, \alpha_{i+1}, \dots, \alpha_{n-k}, \beta_{j_1}, \dots, \beta_{j_l} \rangle \in \text{star}(\alpha)$$

The set of all such cones can be characterized as

$$\{\sigma_{\alpha_i, \alpha}\} = \{\sigma' \in \text{star}(\alpha) : \sigma' \subset \sigma'' \in \Sigma, |\sigma'| = |\sigma''|\}.$$

Partition the cones of $\text{Bl}_\alpha(\Sigma)$ as

$$\text{Bl}_\alpha(\Sigma) = \{\sigma \in \Sigma : \alpha \notin \sigma\} \sqcup \{\sigma' \in \text{star}(\alpha) : \sigma' \subset \sigma'' \in \Sigma, |\sigma'| = |\sigma''|\} \sqcup T$$

The cones of T are drawn in blue in Fig. 15, and are in bijection with the cones of $\text{star}(\tau)/\tau$. We obtain a decomposition of the FLTZ skeleton for the blowup as sets,

$$\mathfrak{f}_{\text{Bl}_\alpha(\Sigma)} = \mathfrak{f}_\Sigma \cup \left(\bigcup_{\sigma \in T} \mathfrak{f}_\sigma \right). \quad (15)$$

From this, we conclude that $\mathfrak{f}_\Sigma \subset \mathfrak{f}_{\text{Bl}_\alpha(\Sigma)}$ and deduce that the blow-down is given by stop removal. In particular, we obtain the mirror statement to part of Theorem 6.11 as the adjoint inclusion functor is easily defined on tropical Lagrangian sections and does not affect their Floer theory.

Proposition 6.12. *The Lagrangian correspondence $(L_\pi^*)^{-1} : ((\mathbb{C}^*)^n, \mathfrak{f}_{\text{Bl}_\alpha(\Sigma)}) \Rightarrow ((\mathbb{C}^*)^n, \mathfrak{f}_\Sigma)$ is a stop removal. The adjoint $L_\pi^* : ((\mathbb{C}^*)^n, \mathfrak{f}_\Sigma) \rightarrow ((\mathbb{C}^*)^n, \mathfrak{f}_{\text{Bl}_\alpha(\Sigma)})$ induces a fully faithful functor.*

Define

$$\mathfrak{g} := \mathfrak{f}_{\text{Bl}_\alpha(\Sigma)} \setminus \mathfrak{f}_\Sigma,$$

and let $\mathbb{L}_\mathfrak{g}$ be the set of points which flow to the set \mathfrak{g} under the Liouville flow. Equation (15) does not describe the set \mathfrak{g} . Rather, for each $\sigma \in T$, let $\text{Conn}(\Sigma, \sigma) := \{\mathbb{I}_{\sigma, i}\}$ index the connected components of \mathbb{L}_σ in the complement of the singular locus of the FLTZ skeleton. We may then write

$$\mathbb{L}_\mathfrak{g} = \bigcup_{\sigma \in T, i \in \text{Conn}(\Sigma, \sigma)} \mathbb{I}_{\sigma, i}.$$

To understand the localization $\mathcal{W}(X, \mathfrak{f}_{\text{Bl}_\alpha(\Sigma)}) \rightarrow \mathcal{W}(X, \mathfrak{f}_\Sigma)$, we must understand the linking disks of the $\mathbb{I}_{\sigma, i}$.²² We first need a general lemma for stop removal:

²²We apologize for conflating stops and skeleton components when describing these linking disks; while we are performing a localization at the linking disks of the stop, our argument will describe these linking disks as cocores of the FLTZ skeleton associated to a lower dimensional toric variety.

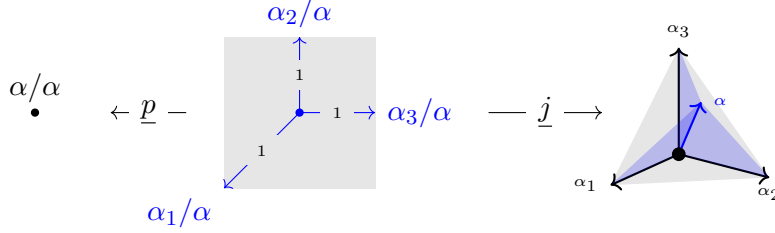

Figure 16. Blowup of \mathbb{C}^3 at the origin, with elements of T highlighted in blue. The cone α has fiber codimension 0, while the cones $\langle \alpha, \alpha_i \rangle$ all have fiber codimension 1.

Lemma 6.13. *Let \mathfrak{f} be a stop. Let Λ be a connected Legendrian submanifold whose interior is disjoint from \mathfrak{f} . Suppose that $\partial\Lambda \not\subset \mathfrak{f}$. Then $\mathcal{W}(X, \mathfrak{f} \cup \Lambda) \simeq \mathcal{W}(X, \mathfrak{f})$.*

Proof. Since $\mathcal{W}(X, \mathfrak{f})$ is obtained from $\mathcal{W}(X, \mathfrak{f} \cup \Lambda)$ by stop removal, we need only prove that the linking disk to $x \in \Lambda$ is a trivial object of $\mathcal{W}(X, \mathfrak{f} \cup \Lambda)$. Let y be any point in the boundary of Λ which is not contained in \mathfrak{f} . Consider a path $\gamma : I \rightarrow \Lambda$ from x to y , and linking disks $\mathbf{u}(\gamma(t))$. Then, $\mathbf{u}(\gamma(1))$ is Lagrangian nullcobordant and Hamiltonian isotopic to $\mathbf{u}(x)$. \square

Each cone $\sigma \in T$ corresponds to a toric fixed stratum with both base and fiber components. Define the *fiber codimension* of a cone to be $|\sigma/\alpha| - |\underline{p}(\sigma/\alpha)|$; alternatively, this is the number of α_i in the primitive generators of σ . See Fig. 16.

Proposition 6.14. *Let \mathfrak{g}^l be the collection of $\mathbb{L}_{\sigma, i}$ with $\sigma \in T$ and fiber codimension at most l . For all $0 \leq l \leq n - k - 2$, we have an equivalence of categories.*

$$\mathcal{W}((\mathbb{C}^*)^{n-1}, \mathfrak{f}_{\text{star}(\alpha)/\alpha} \setminus \mathfrak{g}^0) \cong \mathcal{W}((\mathbb{C}^*)^{n-1}, \mathfrak{f}_{\text{star}(\alpha)/\alpha} \setminus \mathfrak{g}^l).$$

Proof. We proceed inductively. The collection of Legendrians $\mathfrak{g}^l \setminus \mathfrak{g}^{l-1}$ is a disjoint union of Legendrians belonging to \mathfrak{f}_σ , where σ has fiber dimension l . For each such \mathfrak{f}_σ , there exists $\mathfrak{f}_{\sigma'} \subset \mathfrak{g}^{l-1}$ whose boundary is partially contained inside the intersection $\partial(\mathfrak{f}_\sigma) \cap \mathfrak{f}_{\sigma'}$. Therefore by Lemma 6.13 stop removal at \mathfrak{g}^{l-1} and \mathfrak{g}^l produce quasi-isomorphic categories. \square

We now need to show that the localization at the linking disks of T is the mirror to blowdown. By Proposition 6.14, it suffices to consider the localization at linking disks of fiber codimension 0 strata. Let $T^0 \subset T$ be the set of fiber codimension 0 cones. Consider now the Lagrangian correspondence $L_{\alpha 0} : ((\mathbb{C}^*)^n, \mathfrak{f}_{\text{star}(\alpha)/\alpha}) \Rightarrow (X, \mathfrak{f}_{\text{Bl}_\alpha(\Sigma)})$ which is mirror to inclusion of the exceptional divisor. By Corollary 5.23, for every interior point $x \in \mathbb{L}_\sigma$ with $\sigma > \alpha$, there exists an interior point $y \in \mathbb{L}_{i^*\sigma} \subset \mathbb{L}_{\text{star}(\alpha)/\alpha}$ such that $L_{\alpha 0} \circ \mathbf{u}(y)$ is admissibly Hamiltonian isotopic to $\mathbf{u}(x)$. Since every cone $\sigma \in T^0$ contains α , there exists a set of cones $T^0/\alpha \subset \text{star}(\alpha)/\alpha$ such that stop removal at \mathfrak{g} is given by localization at the Lagrangians

$$\{L_{\alpha 0} \circ \mathbf{u}(y) : y \in \mathbb{L}_{\sigma/\alpha}, \sigma/\alpha \in T^0/\alpha\}.$$

It remains to generate these linking disks by pullback from $((\mathbb{C}^*)^k, \text{star}(\tau)/\tau)$. The cones of T^0/α are in bijection with the cones of $\text{star}(\tau)/\tau$ via the projection $\underline{p} : \text{star}(\alpha)/\alpha \rightarrow \text{star}(\tau)/\tau$. However, the set of linking disks $\text{Conn}(\text{star}(\alpha)/\alpha, \sigma/\alpha) := \{\mathbb{L}_{\sigma/\alpha; i}\}$ of $\mathbb{L}_{\sigma, i}, i \in \text{Conn}(\text{star}(\tau)/\tau, \sigma)$ differ from the linking disks of $\mathbb{L}_{\underline{p}(\sigma)} \subset \mathbb{L}_{\text{star}(\tau)/\tau}$.

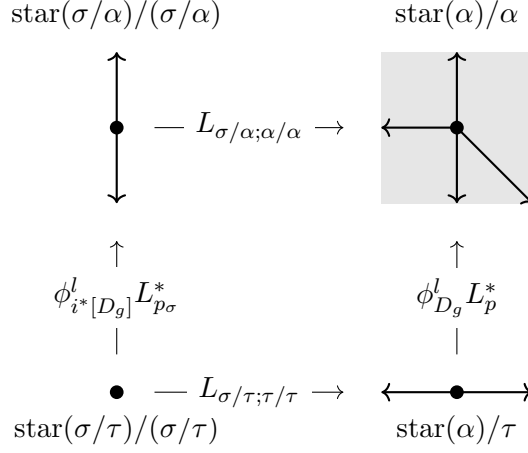

Figure 17. The relation between linking disks of $\mathbb{L}_{\sigma/\alpha}$ for $\sigma \in T^0$ to linking disks of components of $\text{star}(\alpha)/\tau$ is similar to that between linking disks of $\text{star}(\sigma/\alpha)/(\sigma/\alpha)$ and $\text{star}(\sigma/\tau)/\text{star}(\sigma/\tau)$.

For notational clarity, whenever $L_{\delta\delta'}$ is unclear (due to the possibility that δ and/or δ' are quotient cones), we will write $L_{\delta;\delta'}$. By Lemma 3.14, a linking disk $\mathbf{u}(y)$ for $\mathbb{L}_{\sigma/\alpha} \subset ((\mathbb{C}^*)^{n-1}, \mathfrak{f}_{\text{star}(\alpha)/\alpha})$ can be expressed as the image of a cocore $\mathbf{u}(z) \subset ((\mathbb{C}^*)^{n-1-j}, \mathfrak{f}_{\text{star}(\sigma/\alpha)/(\sigma/\alpha)})$ under the correspondence

$$L_{\sigma/\alpha;\alpha/\alpha} : ((\mathbb{C}^*)^{n-1-|\sigma/\alpha|}, \mathfrak{f}_{\text{star}(\sigma/\alpha)/(\sigma/\alpha)}) \Rightarrow ((\mathbb{C}^*)^{n-1}, \mathfrak{f}_{\text{star}(\alpha)/\alpha}).$$

Let F_z be a support function for $\check{X}_{\text{star}(\sigma/\alpha)/(\sigma/\alpha)}$ corresponding to the cocore $\mathbf{u}(z)$ so that

$$L_{\sigma/\alpha;\alpha/\alpha} \circ L^\delta(F_z) = \mathbf{u}(y).$$

Let $[\mathfrak{z}_{\sigma 0}^* F_\alpha]$ be a linear equivalence class of support function arising from pullback of F_α . Write $F_z = \sum_{i=1}^{n-k} m_{\alpha_i} F_{\alpha_i/\sigma} + \sum_{\beta_j/\sigma} m_{\beta_j/\sigma} F_{\beta_j/\sigma}$. By taking a linear transformation, we may assume that the $m_{\alpha_i} = 0$ for $i \neq 1$. Then, there exists a point which satisfies the inequalities $-1 < \alpha_i/\alpha \cdot p < 0$ for all $i \neq 2$, and $m_{\alpha_1} - 1 < \alpha_1/\alpha \cdot p < m_{\alpha_1}$. In the α_i coordinates, this implies that $0 < m_{\alpha_1} \leq n - k$; this computation should be compared to Proposition 6.5. Write $l = m_{\alpha_1}$ and set $[\mathfrak{z}_{\sigma 0}^* F_\alpha] = F_{\alpha_1} + \sum_{\beta/\sigma} F_1(\beta/\alpha) F_{\beta/\sigma}$. Then

$$F_z - l([\mathfrak{z}_{\sigma 0}^* F_\alpha]) = \sum_{\beta/\sigma} (lF_1(\beta/\alpha) + m_{\beta/\sigma}) F_{\beta/\sigma}.$$

As this has no F_{α_i} component, $L^\delta(F_z - l([\mathfrak{z}_{\sigma 0}^* F_\alpha])) = \phi_{[\mathfrak{z}_{\sigma 0}^* F_\alpha]}^{-l} \circ L^\delta(F_z)$ arises as the pullback of a tropical section $L^\delta(F_w) \subset ((\mathbb{C}^*)^{n-1-j}, \mathfrak{f}_{\text{star}(\sigma/\tau)/(\tau)})$ along $L_{p\sigma}^* : ((\mathbb{C}^*)^{n-1-j}, \mathfrak{f}_{\text{star}(\sigma/\tau)/(\tau)}) \Rightarrow ((\mathbb{C}^*)^{n-1}, \mathfrak{f}_{\text{star}(\sigma/\alpha)/(\sigma/\alpha)})$. Using the commutativity of the square in Fig. 17, we obtain the following:

Proposition 6.15. *Let $\mathbf{u}(x)$ be a linking disk to \mathbb{L}_σ for some $\sigma \in T^0$. Then there exists a cocore $L^\delta(F_w)$ of $((\mathbb{C}^*)^{n-1-j}, \mathfrak{f}_{\text{star}(\sigma/\tau)/(\tau)})$, and $0 < l \leq n - k$ so that*

$$\mathbf{u}(x) \sim L_{\alpha 0} \circ \phi_{F_\alpha}^l \circ L_p^* \circ L_{\sigma/\tau;\tau/\tau} \circ L^\delta(F_w).$$

It follows that the subcategory generated by these cocores is contained within the subcategory generated by the image of $L_{\alpha 0} \circ \phi_{F_\alpha}^l \circ L_p^*$,

$$\langle \mathbf{u}(x) : x \in \mathbb{L}_\sigma, \sigma \in T^0 \rangle \subset \langle L_{\alpha 0} \circ \phi_{F_\alpha}^l \circ L_p^*(\mathcal{W}((\mathbb{C}^*)^k, \mathfrak{f}_{\text{star}(\tau)/\tau})) \rangle.$$

To show that these subcategories agree, we compute the intersection of the disks $(L_{\alpha 0} \circ \phi_{F_\alpha}^l \circ L_p^*)(L^\delta(F))$ with the FLTZ skeleton.

Proposition 6.16. *The Lagrangian $(\phi_{F_\alpha}^l \circ L_p^*)(L^\delta(F))$ is generated by linking disks of $\mathbb{L}_{\sigma/\alpha}$ where $\sigma/\alpha \in T$.*

Proof. We follow Example 3.16. Rewrite the tropical section as

$$L^\delta(\underline{p}^*F + lF_\alpha).$$

For fixed t , consider the Lagrangian submanifolds

$$L_t(l, F) = \left(u, \nabla H_{\underline{p}^*(F)}^\delta + \left(\frac{tl}{n-k} \right) (\alpha_1/\alpha) + (1-t) \nabla H_{lF_\alpha}^\delta \right).$$

This is not an admissible Lagrangian submanifold for all t , and crosses several of the stops. However, let σ/α be a stop which contains some α_i/α . Then for $i \geq 2$,

$$\left(\frac{tl}{n-k} \right) \alpha_1/\alpha \cdot (\alpha_i/\alpha) + (1-t) \nabla \widehat{H}_{lF_\alpha}^\delta(\alpha_i/\alpha) \approx \frac{tl}{n-k}$$

and for $i = 1$,

$$\left(\frac{tl}{n-k} \right) \alpha_1/\alpha \cdot (\alpha_1/\alpha) + (1-t) \nabla \widehat{H}_{lF_\alpha}^\delta(\alpha_1/\alpha) \approx tl + (1-t)l = l.$$

Since the projection of these value avoid the set $\mathbb{Z} - \delta$, $L_t(l, F)$ does not cross $\mathfrak{f}_{\sigma/\alpha}$ whenever σ/α contains α_i . Therefore, $L_0(l, F)$ and $L_1(l, F)$ differ by the linking disks $\mathbf{u}(x)$ with $x \in \mathbb{L}_\sigma$, for choices of cones $\sigma \in T$. Alternatively, we may write

$$L_0(l, F) \in \langle L_1(l, F), \mathbf{u}(x) : x \in \mathfrak{f}_\sigma, \sigma \in T \rangle.$$

The function $\underline{p}^*(F + lF_\alpha)$ has the property that for every α/α_i , $\nabla \widehat{H}_{\underline{p}^*(F+lF_\alpha)}^\delta(\alpha/\alpha_i) \approx 0$. The cones of $\sigma/\alpha \in (\text{star}(\tau)/\alpha) \setminus (T^0/\alpha)$ all contain at least one of the α_i , for which we have

$$\left(\left(\nabla \widehat{H}_{\underline{p}^*(F+lF_\alpha)}^\delta \right) + \frac{tl}{n-k} \alpha \right) (\alpha_i) \approx \left(\frac{l}{n-k} \right).$$

In conclusion, $L_1(l, F)$ intersects only $\mathbb{L}_{\sigma/\alpha}$ for $\sigma/\alpha \in T$, giving us the inclusion

$$\langle L_{\alpha 0} \circ \phi_{F_\alpha}^l \circ L_p^*(\mathcal{W}((\mathbb{C}^*)^k, \mathfrak{f}_{\text{star}(\tau)/\tau})) \rangle \subset \langle \mathbf{u}(x) : x \in \mathbb{L}_\sigma, \sigma \in T^0 \rangle.$$

□

From this, we can conclude that blowup is mirror to a stop removal.

Corollary 6.17. *The stop removal functor $L_{\pi_*} : \mathcal{W}(X, \mathfrak{f}_{\text{Bl}_\alpha(\Sigma)}) \rightarrow \mathcal{W}(X, \mathfrak{f}_\Sigma)$ is mirror to the derived pushforward $\pi_* : D^b \text{Coh}(\check{X}_{\text{Bl}_\alpha(\Sigma)}) \rightarrow D^b \text{Coh}(\check{X}_\Sigma)$.*

Example 6.18. It is possible to pictorially check Corollary 6.17 for $\check{X}_\Sigma = \mathbb{C}\mathbb{P}^2$ using similar pictures to those in Section 6.1.1. See Fig. 18. Note that $L_{\pi_*}(L(-E))$ is an admissible Lagrangian section in the mirror to $\mathbb{C}\mathbb{P}^2$ that is not Hamiltonian isotopic to a tropical Lagrangian section (Fig. 18c).

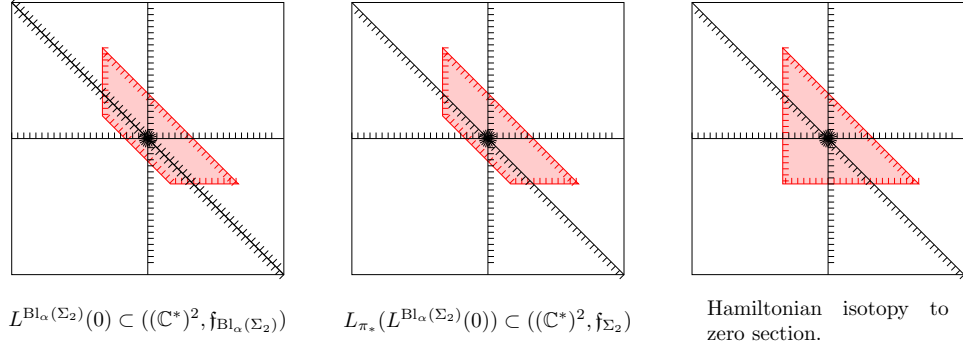

(a) The mirror to $\tilde{\pi}_* \mathcal{O}_{\tilde{X}^{\text{Bl}(\alpha)\Sigma}} = \mathcal{O}_{\tilde{X}^\Sigma}$

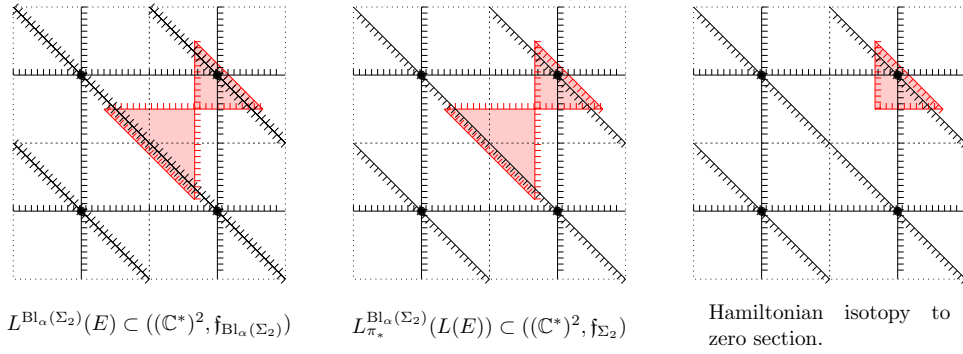

(b) The mirror to $\tilde{\pi}_* \mathcal{O}_{\tilde{X}^{\text{Bl}(\alpha)\Sigma}}(-E) = \mathcal{O}_{\tilde{X}^\Sigma}$

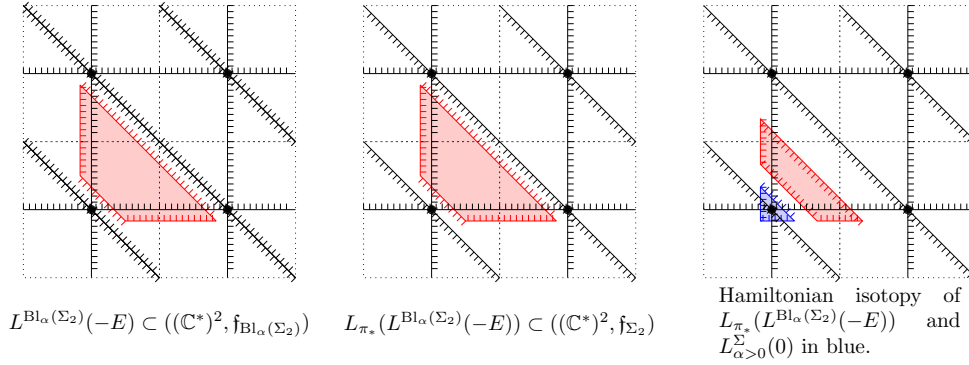

(c) A Lagrangian section which is not tropical. Note that in the right most image, $(L_{\pi_*} \circ L^{\text{Bl}(\alpha)\Sigma}(-E)) \# L_{\alpha>0}^\Sigma = L^\Sigma(0)$, identifying $L_{\pi_*} \circ L^{\text{Bl}(\alpha)\Sigma}(-E)$ with the ideal sheaf of a point in \tilde{X}^Σ .

Figure 18. Piecewise-linear approximations of argument images of Lagrangian sections under stop removal in the mirror to the blow up of a point in $\mathbb{C}\mathbb{P}^2$

Remark 6.19. For a more general star-subdivision, it is easy to see that the FLTZ skeleton for Σ can also be obtained from that of $\text{Bl}_\alpha(\Sigma)$ by stop removal. Thus, the discussion above should generalize to any star-subdivision, but this is combinatorially involved and requires a generalization of Orlov’s theorem in the toric setting. In fact, every complete fan can be transformed by a sequence of star-subdivisions to a fan corresponding to a smooth projective toric variety by [CLS11, Theorem 11.1.9] and [Ewa12, V Theorem 4.5]. Thus, realizing the general star subdivision functor as an appropriate quotient would allow one to deduce homological mirror symmetry for any toric variety from homological mirror symmetry for projective toric varieties. However, this seems to require significant new ideas beyond the smooth case presented here.

A Lagrangian cobordisms in Liouville manifolds

The words “Lagrangian cobordism” have come to mean two related but slightly different kinds of Lagrangian submanifolds in symplectic geometry: *Lagrangian cobordisms with Lagrangian ends* and *cobordisms between Legendrians*. Unless otherwise specified, Lagrangian cobordisms will refer to a Lagrangian cobordism with Lagrangian ends. We first look at Lagrangian cobordisms with Lagrangian ends, taking the viewpoint that a Lagrangian cobordism is a Lagrangian in an appropriately stopped Fukaya category [Tan18; DJL19; BC14; GPS19].

Definition A.1 ([Arn80; Bos21]). Let $\{L_0, \dots, L_k\}$ be admissible Lagrangian submanifolds of (X, \mathfrak{f}) , and let $(\mathbb{C}, \mathfrak{f}_n)$ be a Liouville domain with n disjoint stops whose flow makes the collection of rays

$$\mathbb{L}_n = \{\mathbb{R}_{\gg 0}, i + \mathbb{R}_{\gg 0}, \dots, (k-1)i + \mathbb{R}_{\gg 0}\}$$

admissible Lagrangian submanifolds. A *Lagrangian cobordism with Lagrangian ends* L_0, \dots, L_k is an admissible Lagrangian submanifold $K \subset (X \times \mathbb{C}, \mathfrak{f} \times \mathfrak{f}_n)$ which for which there exists an open set $V \subset \mathbb{C}$ so that

- $\mathbb{C} \setminus V$ is the normal neighborhood of the non-compact rays $\{(j - \frac{i}{2}) + \mathbb{R}_{>0}\}_{j=0}^k$.
- When K is restricted to the complement of V ,

$$K \setminus \pi_{\mathbb{C}}^{-1}(V) = \bigcup_{j=0}^k \left(L_j \times \left(\left(j - \frac{i}{2} \right) + \mathbb{R}_{>0} \right) \right).$$

We denote such a cobordism by $K : (L_1, \dots, L_k) \rightsquigarrow L_0$.

When X is compact, a Lagrangian $K \subset X \times \mathbb{C}$ which fibers over real rays in \mathbb{C} outside of a compact set will necessarily be a Lagrangian cobordism for some set of ends.

Example A.2. An important example to consider which highlights the need to work with Lagrangians with non-compact projections to the base comes from Hamiltonian isotopy. Let $H_t : X \times \mathbb{R} \rightarrow \mathbb{R}$ be a time-dependent Hamiltonian, compactly supported in t . Let $\theta_{H_t}^s$ be the time s Hamiltonian flow. We can parameterize a Lagrangian submanifold by

$$\begin{aligned} L \times \mathbb{R} &\rightarrow X \times \mathbb{C} \\ (x, s) &\mapsto (\theta_{H_t}^s(x), s + iH_s). \end{aligned}$$

Notice that if H_s is unbounded in the L -direction, then the $\pi_{\mathbb{C}}$ -projection of this cobordism will be unbounded in the imaginary direction. After rotating the ends so that they point all in the positive direction, we obtain a Lagrangian cobordism, called the suspension of H_t .

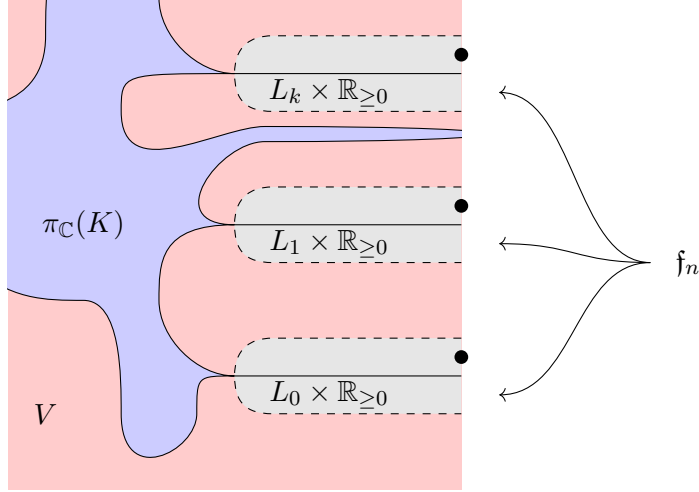

Figure 19. A cobordism between admissible Lagrangians need not be compact in the projection to \mathbb{C} , however it must fiber over rays near the stops.

One reason to use Lagrangian cobordisms is that they provide algebraic relations between the ends of the cobordism. If $K : (L_1 \dots, L_k) \rightsquigarrow L_0$ is a monotone Lagrangian cobordism, then a result of Biran and Cornea states that the right end can be expressed as an iterated mapping cone of the Lagrangians on the left end. There is current work of Valentine Bosshard extending the results of Biran and Cornea to the setting of Liouville sectors by using the GPS framework. We will use the following version of their results, which can be understood in terms of the wrapping triangle from [GPS18b].

Theorem A.3 ([BC14], [Bos21]). *Suppose that $K : (L_1, \dots, L_k) \rightsquigarrow L_0$ is an admissible exact Lagrangian cobordism. Then (L_1, \dots, L_k) generate L_0 in the Fukaya category.*

The Lagrangian cobordism that we will be using the most is the *surgery trace* cobordism. We show here that the surgery construction presented in [Hic20] carries over to the setting of Liouville domains with stops.

Definition A.4. Let L_1 and L_2 be two admissible Lagrangian submanifolds of (X, \mathfrak{f}) . A surgery data is

- $U \subset L_1$, an open neighborhood of $L_1 \cap L_2$ called the *surgery region*, and
- a function $f : U \rightarrow \mathbb{R}$ called the collar function

with the following properties:

- $f \geq 0$, and $f = 0$ exactly on $L_1 \cap L_2$.
- There exists a Weinstein neighborhood of U symplectomorphic to the radius c cotangent ball $B_c^*(U)$, so that the Lagrangian $L_2|_{B_c^*(U)}$ is the graph of the section df .

Given a subset $U \subset X$, and fixed $X^{int} \subset X$ a Liouville domain, the conicalization of U (relative to X^{int}) is the attachment of the downward flow space outside X^{int} to U .

$$U^{cone} := U \cup \{\phi_Z^t(x) : x \in U \setminus X^{int}, t \in \mathbb{R}_{>0}\}.$$

Proposition A.5. *Let L_1, L_2 be admissible Lagrangian submanifolds of (X, f) with surgery data (U, f) . For all sufficiently small ε , there exists a Lagrangian surgery at U contained within a conical neighborhood of the symmetric difference between L_1 and L_2 :*

$$L_1 \#_U L_2 \subset B_\varepsilon^{\text{cone}}((L_1 \cup L_2) \setminus (L_1 \cap L_2)).$$

Furthermore, there is a Lagrangian surgery trace cobordism

$$K : (L_1, L_2) \rightsquigarrow (L_1 \#_U L_2).$$

The surgery $L_1 \#_U L_2$ is conical at infinity. Furthermore, if L_1, L_2 are exact, and U is connected, then $L_1 \#_U L_2$ is exact. In particular, if U is connected, then $L_1 \#_U L_2$ is admissible.

Proof. We first construct a new surgery neighborhood and collar function from the data of U and f . This new surgery data will be invariant under the Liouville flow outside of a compact set. Let $X = X^{\text{int}} \cup (\partial X^{\text{int}}) \times \mathbb{R}_{>0}$ be a decomposition of X into a compact symplectic manifold with contact boundary and the symplectization of that boundary. Assume that X^{int} was chosen so that $L_i|_{(\partial X^{\text{int}}) \times \mathbb{R}_{>0}} = \Lambda_i \times \mathbb{R}_{>0}$ for choices of Legendrian submanifolds Λ_i . Write $L_i = L_i^{\text{int}} \cup (\Lambda_i \times \mathbb{R}_{>0})$, and take $\Upsilon \subset \Lambda_1$ to be the restriction of the surgery region to a Legendrian slice of L_1 at ∂X^{int} . Because 0 is the minimum of f , there exists a value c_ε so that $f|_{X^{\text{int}}}$ has no critical values for $f < 3c_\varepsilon$ except at 0. By choosing a smaller subset of U and a smaller value c_ε , we can assume that $(\partial U) \cap X^{\text{int}}$ is the level set $f^{-1}(3c_\varepsilon)$.

Over the conical end we can take a symplectic neighborhood of $J_{c_1}^1(\Upsilon) \times \mathbb{R}_{>0} \supset \Upsilon \times \mathbb{R}_{>0}$, where $J_{c_1}^1(\Upsilon)$ is a small neighborhood of the zero section in the jet bundle. The radius c_1 of this jet bundle can be chosen small enough so that $\Lambda_2 \cap J_{c_1}^1(\Upsilon)$ is a section of the jet bundle. Since L_2 is admissible, this section is invariant in the $\mathbb{R}_{>0}$ direction and there exists a primitive $g : \Lambda_1 \rightarrow \mathbb{R}$ so that $L_2|_{J_{c_1}^1(\Upsilon) \times \mathbb{R}_{>0}} \rightarrow \mathbb{R}$ is the graph of $J^1 g \times [0, \infty)$, where $J^1 g$ is the 1-jet of g . Note that there is not necessarily an inclusion (in either direction) of $J_{c_1}^1(\Upsilon) \times [0, \infty)$ and $B_c^*(U)$. The function g satisfies similar properties to f , that is

- $g \geq 0$, and $g = 0$ exactly where $\Lambda_1 \cap \Lambda_2$,
- g achieves a minimal value of $3c_\varepsilon$ on the boundary of Υ .

This gives us a ‘‘conical’’ version of the collar function over the contact end. We now combine this conical collar function with the original collar function. Take a Weinstein neighborhood W of an open set of L_1 containing the intersection $L_1 \cap L_2$. This Weinstein neighborhood can be chosen so that inside of X^{int} , W is a subneighborhood of $B_c^*(U)$. Furthermore, we can take W so that outside of a compact set X^{int} , W splits as $B_{c_1}^*(\Upsilon) \times B_{c_2}^*(\mathbb{R}_{>0})$ and is a subneighborhood of $J_{c_1}^1(\Upsilon) \times \mathbb{R}_{>0}$. Finally, we note that we may pick W small enough so that it avoids $\mathbb{L}_f \setminus X^{\text{int}}$ (defined in Eq. (1)). In this Weinstein neighborhood, $L_2|_W = dh$, where h satisfies the following properties:

- $h \geq 0$, and $h = 0$ exactly where $L_1 \cap L_2$,
- Outside of a compact set, $h = e^t \cdot g$ where t is the symplectization coordinate.
- h achieves a minimal value of $3c_{\varepsilon'}$ on the boundary of $W \cap L_1$ inside X^{int} for some value $c_{\varepsilon'}$,

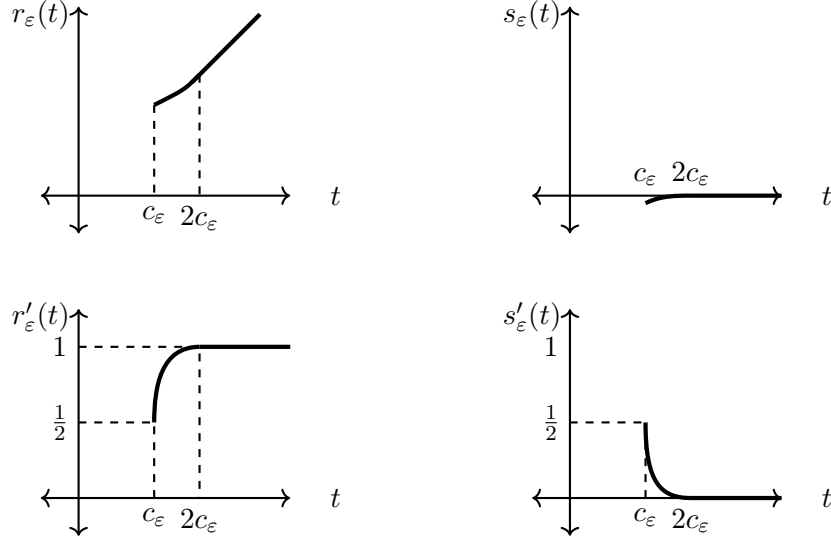

Figure 20. The r and s surgery profiles

We now follow [Hic20, Proposition 3.1]. Define surgery profile functions $r, s : \mathbb{R}_{>c_\varepsilon} \rightarrow \mathbb{R}$ which satisfy the following properties:

- $r(a) = a$ for $a \geq 2c_\varepsilon$ and $s_\varepsilon(a) = 0$ for $a \geq 2c_\varepsilon$.
- $r'(c_\varepsilon) = s'(c_\varepsilon) = \frac{1}{2}$.
- $r(a)$ is convex, while $s(a)$ is concave.
- The concatenation of curves $(a, r'(a))$ and $(a, s'(a))$ is a smooth plane curve.

We now adapt these surgery profiles to give admissible Lagrangians in the symplectization region by choosing a rescaling function $\rho : L_1 \rightarrow \mathbb{R}$ satisfying:

- $\rho|_{L_1 \cap X^{int}} = 1$
- $\rho|_{L_1 \setminus X^{int}}$ depends only on the symplectization coordinate. When restricted to $\partial X^{int} \times [1, \infty)$, ρ is equal to e^t , where t is the symplectization coordinate.

The rescaled surgery profile functions are

$$r_\rho(a) := \rho \cdot r(a/\rho) \qquad s_\rho(a) := \rho \cdot s(a/\rho).$$

This rescaling is similar to the rescaling of convolution kernel used in Section 3 which was needed to make tropical Lagrangian sections admissible objects of the category. The surgery neck is built from two Lagrangian sections of $W|_{h \geq \rho c_\varepsilon}$,

$$L'_r := d(r_\rho \circ h) \qquad L'_s := d(s_\rho \circ h).$$

The union of these two charts is the surgery neck, which is a smooth Lagrangian submanifold $L'_r \cup L'_s \subset W$. Near the boundary of W where $h > 2\rho c_\varepsilon$, we obtain,

$$r_\rho \circ h|_{h > 2\rho c_\varepsilon} = h \qquad s_\rho \circ h|_{h > 2\rho c_\varepsilon} = 0,$$

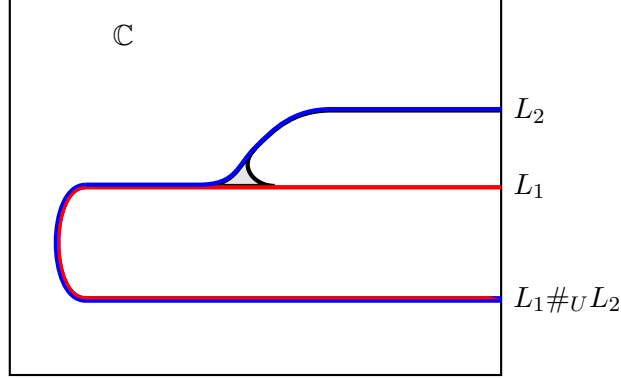

Figure 21. The surgery trace is given by surgering $L_1 \times \gamma_1$ and $L_2 \times \gamma_2$, where γ_1 and γ_2 are the blue and red curve drawn.

so we can glue these to our L_1, L_2 to form Lagrangian submanifolds with common boundary,

$$L_r := L'_r \cup (L_2 \setminus W) \quad L_s := L'_s \cup (L_1 \setminus W).$$

We call these the r and s charts of the surgery, and define the surgery $L_1 \#_U L_2 := L_r \cup L_s$.

It remains to show that this is a conical Lagrangian submanifold. Outside of the set X^{int} , the section is $d(r_\rho \circ h) = d(e^t \cdot (r \circ g))$, and so the r -chart restricted to this portion $L'_r \setminus X^{int}$ is parameterized by $J^1(r \circ g) \times [1, \infty)$. Similarly, the L_s chart in the conical region is given by $J^1(s \circ g) \times [1, \infty)$. $L_1 \#_U L_2$ is conical at infinity Lagrangian because union of conical at infinity charts is conical at infinity.

Finally, suppose that L_1, L_2 are exact, and the surgery region U is connected. Then the L_s and L_r charts are exact, and there is no obstruction to gluing the primitives to obtain a primitive for λ over $L_1 \#_U L_2$.

The Lagrangian surgery trace cobordism is constructed following [Hic20, Proposition 3.1]. Let L_1, L_2 be Lagrangians with surgery data U, f . Pick curves $\gamma_1, \gamma_2 \subset \mathbb{C}$ which intersect over the negative real axis (as drawn in Fig. 21.) Then $L_1 \times \gamma_1, L_2 \times \gamma_2 \subset X \times \mathbb{C}$ can be surgered along their intersection $(L_1 \cap L_2) \times \mathbb{R}_{<0}$, giving a Lagrangian cobordism as desired. \square

B Generation of $\text{Fuk}(X, f)$

B.1 Lagrangian cobordisms with Legendrian ends

Let $\partial X^{int} \times \mathbb{R}$ be the symplectization of a contact manifold ∂X^{int} . We denote by $\pi_{\mathbb{R}} : \partial X^{int} \times \mathbb{R} \rightarrow \mathbb{R}$ the projection to the symplectization coordinate.

Definition B.1. Let ∂X^{int} be a contact manifold, $\Lambda^-, \Lambda^+ \subset X$ be Legendrian submanifolds. A *Lagrangian cobordism with Legendrian ends* Λ^-, Λ^+ is a Lagrangian submanifold of $\partial X^{int} \times \mathbb{R}$ whose ends are conical in the sense that there exists an interval $[t_-, t_+] \subset \mathbb{R}$ outside which

$$L \setminus \pi_{\mathbb{R}}^{-1}([t_-, t_+]) = (\Lambda^- \times (-\infty, t_-)) \sqcup (\Lambda^+ \times (t_+, \infty)).$$

In this case, we say that L is a Lagrangian cobordism from Λ_+ to Λ_- and write $L : \Lambda_+ \rightsquigarrow \Lambda_-$.

Given two Lagrangian cobordisms with Legendrian ends,

$$L_{01} : \Lambda_0 \rightsquigarrow \Lambda_1$$

$$L_{12} : \Lambda_1 \rightsquigarrow \Lambda_2$$

there exists a concatenation Lagrangian cobordism with Legendrian ends $L_{01} \circ L_{12} : \Lambda_0 \rightsquigarrow \Lambda_2$. This cobordism is canonically defined up to Hamiltonian isotopy. In some circumstances, we can also decompose a Lagrangian cobordism between Legendrians into simpler pieces along the symplectization coordinate t . We start by describing cobordisms of Legendrians which arise from Legendrian isotopies.

Lemma B.2 (Sliceability Criteria). *Let ∂X^{int} be a $2n - 1$ dimensional contact manifold with contact form λ . Suppose Λ is an $n-1$ dimensional submanifold of ∂X^{int} with isotopy parameterized by*

$$\phi(x, s) : \Lambda \times \mathbb{R}_s \rightarrow \partial X^{int}.$$

The following are equivalent:

1. The pullback $\iota_{\partial_s}(\phi^*d\lambda) = 0$ vanishes so that L_ϕ , the submanifold parameterized by

$$\begin{aligned} \Phi : \Lambda \times \mathbb{R}_s &\rightarrow \partial X^{int} \times \mathbb{R}_t \\ (x, s) &\mapsto (\phi(x, s), s), \end{aligned}$$

is a Lagrangian cobordism with Legendrian ends.

2. For each s_0 , the manifold $\Lambda_{s_0} \subset \partial X^{int}$ parameterized by $\phi(x, s_0)$ is a Legendrian submanifold. Furthermore, the isotopy $\phi(x, s)$ is generated by

$$H_s := \iota_{\partial_s}(\phi^*(\lambda)) : \Lambda \times \mathbb{R}_s \rightarrow \mathbb{R}$$

which is constant across slices, in the sense that for all $\partial_w \in T\Lambda$,

$$\partial_w H_s = 0.$$

Finally, we require that the generating function H_s is compactly supported in the s coordinate.

Proof. We will prove one direction: that Item 1 implies Item 2. First, we show that $(\phi^*\lambda)|_{\Lambda \times \{s_0\}} = 0$. Let $\partial_w \in T_p(\Lambda \times \{s_0\})$ be any vector. Let $\partial_s \in T_p(\Lambda \times \mathbb{R}_s)$ be the vector arising from the \mathbb{R}_s coordinate so that $\Phi^*dt(\partial_s) = 1$. Because Φ is a Lagrangian embedding,

$$\begin{aligned} 0 &= \Phi^*\omega(\partial_s, \partial_w) = e^{s_0} \cdot (\Phi^*dt \wedge \Phi^*\lambda)(\partial_s, \partial_w) + e^{s_0} \cdot (\Phi^*d\lambda)(\partial_s, \partial_w) \\ &= e^{s_0} \cdot (\Phi^*dt(\partial_s)) \cdot (\Phi^*\lambda(\partial_w)) + \iota_{\partial_s}(\Phi^*d\lambda)(\partial_w) \\ &= e^{s_0} \cdot \Phi^*\lambda(\partial_w) = e^{s_0} \cdot \phi^*\lambda(\partial_w)|_{s=s_0} \end{aligned}$$

Therefore, λ vanishes on $T_p\Lambda_{s_0}$ and we conclude that Λ_{s_0} is Legendrian.

To check that $\iota_{\partial_t}(\phi^*(\lambda))$ is solely a function of t , we extend $\partial_w \in T\Lambda$ and $\partial_s \in T\Lambda \times \mathbb{R}_s$ to vector fields on $\Lambda \times \mathbb{R}_s$ so that $[\partial_w, \partial_s] = 0$. The identity comes from the computation

$$\begin{aligned} 0 &= \iota_{\partial_s}(d\lambda)(\partial_w) \\ &= \partial_s \phi^*\lambda(\partial_w) + \partial_w \phi^*\lambda(\partial_s) + \lambda([\partial_s, \partial_w]) \\ &= \partial_w(\iota_{\partial_s} \phi^*\lambda). \end{aligned}$$

The reverse direction is analogous. □

With Lemma B.2 in mind:

Definition B.3. We say that a cobordism of Legendrians $L \subset \partial X^{int} \times \mathbb{R}_t$ is *sliceable* at $t_0 \in \mathbb{R}_s$ if:

- t_0 is a regular value of $\pi_{\mathbb{R}} : L \rightarrow \mathbb{R}$ and;
- There exists a vector field ∂_t on L transverse to $\pi^{-1}(t_0)$ with

$$\iota_{\partial_t} \phi^*(d\lambda) = 0.$$

We call the Legendrian $\Lambda_{t_0} := L \cap \pi_{\mathbb{R}}^{-1}(t_0)$ the Legendrian slice of L at t_0 .

Lemma B.4 (Decomposition Lemma). *Consider a Lagrangian cobordism with Legendrian ends $L_{+-} : \Lambda_+ \rightsquigarrow \Lambda_-$ inside the symplectization $\partial X^{int} \times \mathbb{R}$. Suppose that L_{+-} is sliceable for all $s \in [-\varepsilon, \varepsilon]$, and so in particular we obtain a Legendrian slice Λ_0 . Then there exist cobordisms of Legendrians in $X \times \mathbb{R}$*

$$\begin{aligned} L_{+0} : \Lambda_+ &\rightsquigarrow \Lambda_0 \\ L_{0-} : \Lambda_0 &\rightsquigarrow \Lambda_- \end{aligned}$$

whose concatenation is Hamiltonian isotopic to L_{+-} .

Proof. We need only show that it is possible to smooth out the ends created by cutting L_{+-} in two pieces along 0. Consider the slice parameterization

$$\begin{aligned} \Phi : \Lambda_0 \times [-\varepsilon, \varepsilon]_s &\rightarrow \partial X^{int} \times [\varepsilon, \varepsilon] \\ (p, s) &\mapsto (\phi(p, s), s) \end{aligned}$$

where $\phi(p, s_0) : L_{s_0} \rightarrow \partial X^{int}$ is the parameterization of $\Lambda_{s_0} \subset \partial X^{int}$.

We now create a new isotopy by reparameterization of the s coordinate. Pick a smooth increasing function $\rho_+ : [-\infty, \varepsilon] \rightarrow [0, \varepsilon]$ which satisfies the following properties:

$$\rho_+(s) = \begin{cases} 0 & s < 0 \\ s & s > \frac{\varepsilon}{2} \end{cases}$$

and consider the embedding

$$\begin{aligned} \Phi_+ : \Lambda_0 \times [-\infty, \varepsilon]_s &\rightarrow \partial X^{int} \times [-\infty, \varepsilon] \\ (p, s) &\mapsto (\phi(p, \rho(s)), s) \end{aligned}$$

As Item 2 of Lemma B.2 holds, $\phi_+(p, s) := (\phi(p, \rho(s)))$ satisfies the relation

$$\partial_w \iota_{\partial_s} (\phi_+^*(\lambda)) = \frac{d\rho}{ds} \partial_w \iota_{\partial_s} (\phi^*(\lambda)|_{\rho(s)}) = 0.$$

Also, by Lemma B.2, Φ_+ parameterizes a Lagrangian submanifold. The cobordisms of Legendrians L_{+0} is parameterized by gluing $\Phi_+|_{s < \varepsilon}$ and $\Phi_+|_{s \geq \varepsilon}$ together. One can similarly construct L_{0-} in this fashion.

By reducing the parameter ε to zero, we obtain a Hamiltonian isotopy between the composition $L_{0-} \circ L_{+0} \rightarrow L_{+-}$. \square

A great source of sliceable Lagrangian cobordisms with Legendrian ends comes from exact Lagrangians. On an exact Lagrangian, $e^t d\lambda$ vanishes, and Definition B.3 is automatically satisfied at all regular points of the projection $\pi_{\mathbb{R}} : L \rightarrow \mathbb{R}$.

B.2 Using both Legendrian and Lagrangian ends

We now will look at Lagrangian cobordisms of non-compact Lagrangians – specifically, Lagrangian cobordisms of Lagrangian cobordisms with Legendrian ends. Let L_- be a Lagrangian in X with boundary Λ_- . Suppose that we have a Lagrangian $L_{+-} \subset \partial X^{int} \times \mathbb{R}$ with Legendrian ends Λ_+, Λ_- . Let $L_+ = L_- \circ L_{+-}$. We will show that there is a Lagrangian cobordism with Lagrangian ends $K : L_- \rightsquigarrow L_+$.

Theorem B.5. *Let $L_{+0} : \Lambda_+ \rightsquigarrow \Lambda_0$ and $L_{0-} : \Lambda_0 \rightsquigarrow \Lambda_-$ be exact Lagrangian cobordisms in $\partial X^{int} \times \mathbb{R}$ with Legendrian ends. Suppose that L_{+0} is disjoint from $\mathfrak{f} \subset \partial X^{int} \times \{\infty\}$. Let $L_{+-} := L_{0-} \circ L_{+0} : \Lambda_+ \rightsquigarrow \Lambda_-$ be the composition of these two cobordisms. There exists an exact Lagrangian cobordism with Lagrangian ends $K : L_{+0} \rightsquigarrow L_{+-}$ in $(\partial X^{int} \times \mathbb{R}) \times \mathbb{C}$ which is disjoint from $\mathfrak{f} \times \mathbb{R}$.*

Proof. Pick R sufficiently large so that L_{+0} and L_{0-} are conical outside of the regions $\pi_{\mathbb{R}}^{-1}([0, R])$ and $\pi_{\mathbb{R}}^{-1}([-R, 0])$ respectively, and choose the concatenation which identifies these two Lagrangians by their Legendrian boundaries at $\pi^{-1}(0)$. Consider the isotopy

$$\begin{aligned} \Phi_r : \partial X^{int} \times \mathbb{R}_t \times \mathbb{R}_r &\rightarrow \partial_0 X \times \mathbb{R} \\ (x, t) &\mapsto (x, e^{\rho(r)}t) \end{aligned}$$

where $\rho(r)$ is a function interpolating between 0 and R whose derivative has bounded support in r . The induced isotopy on exact Lagrangians is Hamiltonian. The flux of the isotopy is explicitly given by $\rho(r)\lambda = d\rho(r)H$, where $H : L \rightarrow \mathbb{R}$ is the primitive providing exactness of $\lambda|_L$.

The choice of $\rho(r)$ means that $\Phi_1(\pi_{\mathbb{R}}^{-1}([R, R])) \cap \pi_{\mathbb{R}}^{-1}(0) = \emptyset$. Therefore, this symplectic isotopy displaces the non-conical portion of the Lagrangians L_{-0} and L_{0+} from itself.

Let $K_{pre} \subset ((\partial X^{int} \times \mathbb{R}) \times \mathbb{C})$ be the suspension of this Hamiltonian isotopy. As a topological space, $K_{pre} = L_{+-} \times \mathbb{R}$. The suspension is an exact Lagrangian submanifold. In addition to being a cobordism with Lagrangian ends, K_{pre} is a Lagrangian cobordism with Legendrian ends $\Lambda_+ \times \mathbb{R}$ and $\Lambda_- \times \mathbb{R}$. $K_{pre} : \Lambda_+ \times \mathbb{R}_u \rightsquigarrow \Lambda_- \times \mathbb{R}$ is exact, as it is Hamiltonian isotopic to $L_{+-} \times \mathbb{R}$ (which is itself exact).

We now take K_{pre} and slice it along $\pi_{\mathbb{R}} : (X \times \mathbb{C}) \times \mathbb{R} \rightarrow \mathbb{R}$ at 0 (see Fig. 22). Because K_{pre} is exact, it suffices to show that this is a regular value of the map $\pi_{\mathbb{R}}$. For points $(p, u) \in K_{pre}$ with $u \in (0, 1)$, we have $(\pi_{\mathbb{R}})_* \partial_u = \rho'(u) \neq 0$. Outside of this region, the slice can be computed explicitly as

$$\begin{aligned} \pi_{\mathbb{R}}^{-1}(0) \cap (K_{pre}|_{u \leq 0}) &= \Lambda_0 \times (-\infty, 0] \\ \pi_{\mathbb{R}}^{-1}(0) \cap (K_{pre}|_{u \geq 1}) &= \Lambda_0 \times [1, \infty). \end{aligned}$$

By Lemma B.4, K_{pre} is the composition of cobordisms of with Legendrian ends, $K_{L_{0-} \rightsquigarrow L_{id}} \circ K_{L_{+0} \rightsquigarrow L_{+-}}$. Each half is exact, and the top half of this composition provides the desired cobordism. \square

An application of this decomposition is a canonical cobordism associated to admissible Lagrangian submanifolds in Liouville domains with stops.

Proposition B.6 (Decomposition into linking disks). *Let $L \subset (X, \mathbb{L}_{\mathfrak{f}})$ be a Lagrangian submanifold with primitive $dH = \lambda|_L$. Suppose that L intersects $\mathbb{L}_{\mathfrak{f}}$ transversely at the points x_1, \dots, x_k , ordered so that $H(x_1) < H(x_2) < \dots < H(x_k)$. There is an exact Lagrangian cobordism $K : (\mathbf{u}(x_1), \dots, \mathbf{u}(x_k)) \rightsquigarrow L$, where $\mathbf{u}(x_1), \dots, \mathbf{u}(x_k)$ are the linking disks and cocores of the x_i .*

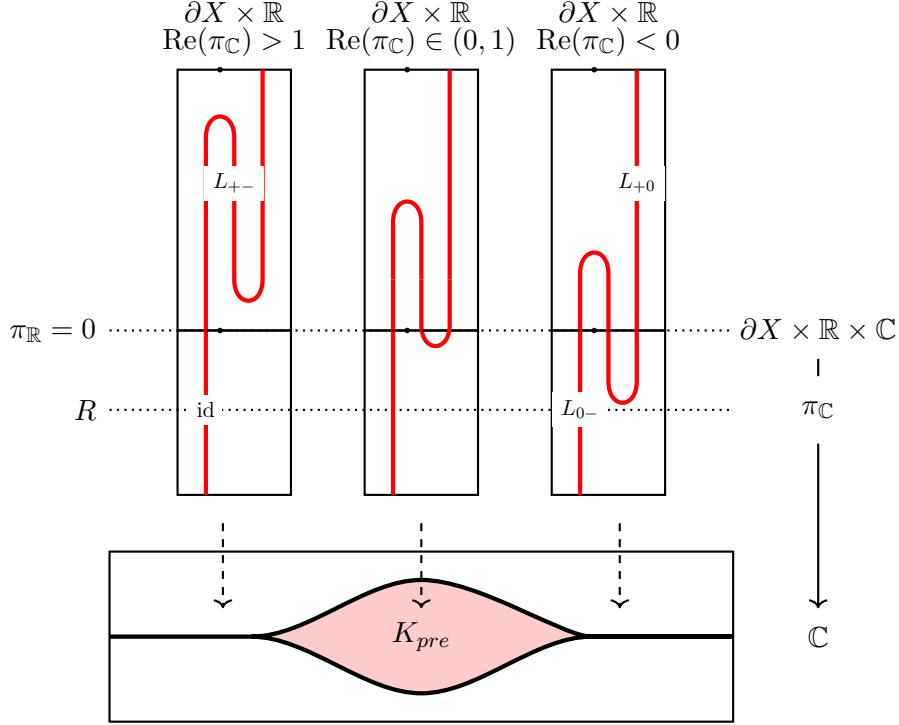

Figure 22. Construction of the Lagrangian cobordism K_{pre} , drawn in the fibers of the map $\pi_{\mathbb{C}} : (\partial X^{int} \times \mathbb{R} \times \mathbb{C}) \rightarrow \mathbb{C}$

Proof. There exists a neighborhood $B_{\varepsilon}(\mathbb{L}_f)$ so that after applying a Hamiltonian isotopy,

$$L \cap B_{\varepsilon}(\mathbb{L}_f) = \bigcup_{i=1}^k \mathbf{u}(x_i).$$

Let $\Phi_t : X \times \mathbb{R} \rightarrow \mathbb{R}$ be the time t Liouville flow. Pick $X^{int} \subset X$ so that L is cylindrical outside of X^{int} . Since the Liouville flow eventually displaces all points in $X^{int} \setminus \mathbb{L}$ from X^{int} , there exists a time t_0 so that for all $t > t_0$,

$$\bigcup_{i=1}^k \mathbf{u}(x_i)|_{X^{int}} = \Phi_{t_0}(L)|_{X^{int}}.$$

Consider a function $\rho : \mathbb{R} \rightarrow \mathbb{R}$ which is increasing, $\rho(t) = 0$ for $t \ll 0$, and $\rho(t) = t_0$ for $t > t_0$. This means that the restriction of the isotopy to X^{int} is constant after time t_0 . The isotopy $\Phi_{\rho(t)}(L)$ is an exact isotopy whose primitive is $\rho(t)H$.

Let $K^{pre} \subset X \times \mathbb{C}$ be the suspension of this Hamiltonian isotopy. Consider now the Lagrangian cobordism K obtained by taking K^{pre} and slicing it at $\partial_0 X^{int}$. This is an exact Lagrangian cobordism whose

- Negative end is the completion of $L|_{X^{int}}$, which is L and;
- Positive ends are at completions of the $\mathbf{u}(x_i)|_{X^{int}}$. Since these complete to linking disks and cocores, the right end is a collection of cocores and linking disks. Notice that the imaginary

coordinate of a Lagrangian suspension is determined by the primitive H for the Hamiltonian isotopy.

In this case, the primitive is primitive for the Liouville form. Therefore, at points x inside the right ends of the Lagrangian cobordism, we have that the imaginary coordinate is

$$H(x) = H(x_i) \text{ if } x \in D_{x_i}^n,$$

which gives us the ordering of the ends of the Lagrangian cobordism. \square

This proposition, along with Theorem A.3, gives a repackaging of the generation statement from [GPS18b; Cha+17; Tan18].

Corollary B.7. *Linking disks (and cocores) generate $\mathcal{W}(X, \mathfrak{f})$.*

C Correspondences and cobordisms

A Lagrangian correspondence $L : X_0 \rightrightarrows X_1$ between two compact symplectic manifolds X_0, X_1 is a Lagrangian submanifold L_{01} in $(X_0^- \times X_1, (-\omega_0) \oplus \omega_1)$. Given a Lagrangian correspondence $L_{01} : X_0 \rightrightarrows X_1$ and a Lagrangian correspondence $L_{12} : X_1 \rightrightarrows X_2$, one can obtain a set called the *geometric composition* $L_{12} \circ L_{01} : X_0 \rightrightarrows X_2$ by taking the intersection inside $X_0 \times X_1 \times X_2$

$$L_{12} \circ L_{01} := \pi_{02}(\pi_{01}^{-1}(L_{01}) \cap \pi_{12}^{-1}(L_{12})).$$

Here, $\pi_{ij} : X_0 \times X_1 \times X_2 \rightarrow X_i \times X_j$ is the standard projection. When the intersection $\pi_{01}^{-1}(L_{01}) \cap \pi_{12}^{-1}(L_{12}) \cap \pi_{01}^{-1}(x)$ is transverse for all $x \in X_0 \times X_1^{-1}$, this is an immersed Lagrangian submanifold. One can always achieve transversality by taking a Hamiltonian isotopy.

Proposition C.1. *Given submanifolds $M \subset X_0 \times X_1$ and $N \subset X_1 \times X_2$, there exist Hamiltonian isotopies $\theta_{12} : X_1 \times X_2 \rightarrow X_1 \times X_2$ and $\theta_{01} : X_0 \times X_1 \rightarrow X_0 \times X_1$ so that $\pi_{01}^{-1}(\theta_{01}(M)), \pi_{12}^{-1}(\theta_{12}(N)) \subset X_0 \times X_1 \times X_2$ intersect transversely. Furthermore, if the intersection $M \cap N$ is transverse outside of $U \subset X_0 \times X_1 \times X_2$, the support of H_{ij} can be chosen to lie inside $\pi_{ij}(U)$.*

Proof. This is similar to the standard proof of transversality for Lagrangian submanifolds. Let $C^\infty(X_0 \times X_1), C^\infty(X_1 \times X_2)$ be the space of Hamiltonian functions for $X_0 \times X_1$ and $X_1 \times X_2$. Consider the map from

$$\begin{aligned} M \times C^\infty(X_0 \times X_1) \times C^\infty(X_1 \times X_2) &\rightarrow X_0 \times X_1 \times X_2 \\ (x, f, g) &\mapsto \theta_f^1 \circ \theta_g^1 \circ i(x) \end{aligned}$$

where $i : M \rightarrow X_0 \times X_1$ is the given parameterization, and θ_f, θ_g are the time 1-Hamiltonian flows of f, g on their corresponding components. This map is a submersion, and therefore transverse to N . It follows that for generic f, g , the inclusion $\theta_f^1 \circ \theta_g^1 \circ i : M \rightarrow X_0 \times X_1 \times X_2$ is transverse to N . \square

In this subsection, we'll show that the Lagrangian cobordism class of $(\theta_{12}(L_{12})) \circ (\theta_{01}(L_{01}))$ is independent of the choice of perturbation θ_{01}, θ_{12} . In fact, we show that the Lagrangian cobordism class is preserved by Lagrangian correspondence.

Proposition C.2. *Let X_0, X_1, X_2 be compact and*

$$K_{01} : (L_{01}^1, \dots, L_{01}^k) \rightsquigarrow L_{01}^0$$

be a cobordism of correspondences with $K_{01} \subset X_0^- \times X_1 \times \mathbb{C}$. Let $L_{12} \subset X_1^- \times X_2$ be another Lagrangian correspondence. Suppose that the geometric compositions $L_{02}^i = L_{12} \circ L_{01}^i$ are immersed Lagrangian submanifolds. Then there is an immersed Lagrangian cobordism $L_{12} \circ K_{01} \subset X_0^- \times X_2 \times \mathbb{C}$ with ends

$$L_{12} \circ K_{01} : (L_{02}^1, \dots, L_{02}^k) \rightsquigarrow L_{02}^0.$$

Proof. The cobordism is defined by taking the intersection of the $\pi_{01\mathbb{C}}^{-1}(K_{01})$ and $\pi_{12}^{-1}(L_{12})$ in $X_0 \times X_1 \times X_2 \times \mathbb{C}$ and projecting down

$$L_{12} \circ K_{01} := \pi_{02\mathbb{C}}(\pi_{01\mathbb{C}}^{-1}(K_{01}) \cap \pi_{12}^{-1}(L_{12}))$$

We first compute the ‘‘ends’’ of this prospective Lagrangian cobordism. Let $r + jt_i$ be a point contained in the i th ray of K_{01} . Then for any $r \ll 0$, we have

$$\begin{aligned} \pi_{02} \circ (\pi_{\mathbb{C}}^{-1}(r + jt_i) \cap (L_{12} \circ K_{01})) &= \pi_{02}(\pi_{\mathbb{C}}^{-1}(r + jt_i) \cap \pi_{01\mathbb{C}}^{-1}(K_{01}) \cap \pi_{12}^{-1}(L_{12})) \\ &= \pi_{02}(\pi_{01\mathbb{C}}^{-1}(\pi_{\mathbb{C}}(r + jt_i) \cap K_{01}) \cap \pi_{12}^{-1}(L_{12})) \\ &= \pi_{02}(\pi_{01}^{-1}(L_{01}^i) \cap \pi_{12}^{-1}(L_{12})) \\ &= L_{01}^i \circ L_{12}. \end{aligned}$$

This shows that the intersection defining $L_{12} \circ K_{01}$ is transverse for $r \ll 0$. Therefore, we can apply a compactly supported Hamiltonian isotopy to make the intersection $\pi_{01\mathbb{C}}^{-1}(K_{01}) \cap \pi_{12}^{-1}(L_{12})$ transverse so that $L_{12} \circ K_{01}$ is an immersed submanifold.

To see that this is a Lagrangian submanifold, we use the Lagrangian conditions of K_{01} and L_{12} :

$$(-\omega_0 + \omega_1 + \omega_z)|_{\pi_{12\mathbb{C}}^{-1}(K_{01})} = 0 \qquad (-\omega_1 + \omega_2)|_{\pi_{12}^{-1}(L_{12})} = 0$$

from which it follows that $(-\omega_0 + \omega_2 + \omega_z)|_{\pi_{12\mathbb{C}}^{-1}(K_{01}) \cap \pi_{12}^{-1}(L_{12})} = 0$ □

Under the additional hypothesis that $L_{02}^i = L_{12} \circ L_{01}^i$ are embedded, the Lagrangian submanifold $L_{12} \circ K_{01}$ is embedded away from a compact set. We can subsequently take a compact Lagrangian homotopy to obtain $(L_{12} \circ K_{01})'$ which has transverse self-intersections. Applying Polterovich surgery at these self intersections yields $(L_{12} \circ K_{01})'' : (L_{02}^1, \dots, L_{02}^k) \rightsquigarrow L_{02}^0$ which is an embedded Lagrangian cobordism.

Corollary C.3. *Let $\theta_{01}, \theta'_{01} : X_0^- \times X_1 \rightarrow X_0^- \times X_1$ be two Hamiltonian isotopies, chosen so that the geometric compositions $L_{12} \circ \theta_{01}(L_{01})$ and $L_{12} \circ \theta'_{01}(L_{01})$ are defined from a transverse intersection. The two geometric compositions are cobordant.*

Proof. Take the suspension cobordism $K : \theta_{01}(L_{12}) \rightsquigarrow \theta'_{01}(L_{12})$. The composition $L_{12} \circ K$ may not be cut out transversely. Since $L_{12} \circ \theta_{01}(L_{01})$ and $L_{12} \circ \theta'_{01}(L_{01})$ are cut out transversely, we only have a failure of transversality away from the ends. Therefore, there exists another Lagrangian cobordism $K' : \theta_{01}(L_{12}) \rightsquigarrow \theta'_{01}(L_{12})$, Hamiltonian isotopic to K , for which $L_{12} \circ K'$ is cut out transversely. It follows from Proposition C.2 that $L_{12} \circ \theta_{01}(L_{01})$ and $L_{12} \circ \theta'_{01}(L_{01})$ are cobordant. □

It is conjectured that a Lagrangian correspondence in $X_0^- \times X_1$ provides a functor between the Fukaya categories of X_0 and X_1 which acts on objects by geometric composition (and Lagrangians $L_0 \subset X_0$ are interpreted as Lagrangian correspondences in $\{\text{pt}\} \times X_0$). We obtain two interpretations of the correspondence/cobordism relation by either putting the cobordism on the objects L_0 or the morphisms L_{01} . From an algebraic standpoint, these cobordisms tell us something about the Weinstein Fukaya 2-category $\mathbf{Floer}^\#$, which is a conjectured A_∞ -2-category whose objects are symplectic manifolds, and morphisms are Lagrangian correspondences. The 2-morphisms $\text{hom}(L_{01}, L'_{01})$ are given by Floer theory, and one recovers the Fukaya category of a symplectic manifold X by looking at the category $\text{Hom}(\text{pt}, X) = \text{Fuk}(\text{pt} \times X) = \text{Fuk}(X)$. A version of this category is constructed in [WW07] on the level of cohomology.

We now describe a decategorified version of this 2-category. We define $\mathcal{Cob}(\mathbf{Floer}^\#)$ to be the category whose objects are symplectic manifolds, and whose morphisms $\mathcal{Cob}(X_1, X_2)$ are formal linear combinations of Lagrangian submanifolds in $(X_1^- \times X_2)$ mod cobordance equivalence, that is $[L_{12}^1] + [L_{12}^2] = [L_{12}^0]$ whenever there is a Lagrangian cobordism $K : (L_{12}^1, L_{12}^2) \rightsquigarrow L_{12}^0$. The vertical composition comes from the abelian group structure on the cobordism group. In this category, horizontal composition is the geometric composition of Lagrangian correspondence. Proposition C.2 shows us that geometric composition with a Lagrangian correspondence $L_{23} \in X_2^- \times X_3$ gives us a well defined map over the equivalence class relation

$$L_{23} : \mathcal{Cob}(X_1, X_2) \rightarrow \mathcal{Cob}(X_1, X_3).$$

By applying Proposition C.2 to the morphism side of the composition, we obtain the 2-category relation,

$$[(L_{23}^1 + L_{23}^2) \circ L_{12}] = [L_{23}^1 \circ L_{12}] + [L_{23}^2 \circ L_{12}].$$

We remark that this contains less data than the Donaldson-Fukaya 2-category. One interpretation of Theorem A.3 given in [BC14] is that $\mathcal{Cob}(\mathbf{Floer}^\#)$ behaves like the group $K_0(\mathbf{Floer}^\#)$. On the mirror side, the appropriate comparison is the derived category of coherent sheaves with functors given by Fourier-Mukai kernel versus the Chow groups with morphisms given by push-pull and intersection. We learned of this interpretation of Lagrangian cobordisms as the mirror to rational equivalence from [SS21, Section 1.3].

D Lagrangian correspondence and admissibility

We look at extending Lagrangian correspondences to the setting of stopped Liouville domains. The main difficulty is solved by [GPS19, Lemma 2.21] which constructs from the data of Liouville manifolds $(X_1^{\text{int}}, \mathfrak{f}_1)$ and $(X_2^{\text{int}}, \mathfrak{f}_2)$ a product Liouville manifold with a product stop,

$$(X_1^{\text{int}} \times X_2^{\text{int}}, \overline{\mathfrak{f}_1 \times \mathfrak{f}_2}).$$

Here, the contact boundary of $X_1^{\text{int}} \times X_2^{\text{int}}$ is obtained by smoothing out the corner strata of $\partial(X_1^{\text{int}} \times X_2^{\text{int}})$. This smoothing covers $\partial(X_1^{\text{int}} \times X_2^{\text{int}})$ with charts which resemble $X_1^{\text{int}} \times (\partial X_2^{\text{int}})$, $(\partial X_1^{\text{int}}) \times X_2^{\text{int}}$, and $(\partial X_1^{\text{int}}) \times (\partial X_2^{\text{int}}) \times (\mathbb{R})$. The \mathbb{R} component of the last chart from taking a neighborhood of the boundaries of X_1^{int} and X_2^{int} , and identifying the symplectization coordinate t_1 for X_1 with $-t_2$ for X_2 .

The product stop is given by [GPS18b, Equation 6.1]:

$$\overline{\mathfrak{f}_1 \times \mathfrak{f}_2} = (\mathfrak{f}_1 \times \mathfrak{c}_1) \cup (\mathfrak{f}_1 \times \mathfrak{f}_2 \times \mathbb{R}) \cup (\mathfrak{c}_2 \times \mathfrak{f}_1). \quad (16)$$

where $\mathfrak{f}_1 \times \mathfrak{c}_1, \mathfrak{c}_2 \times \mathfrak{f}_1$ lay in the boundary strata of $X_1 \times X_2$, and $\mathfrak{f}_1 \times \mathfrak{f}_2 \times \mathbb{R}$ lives in the corner smoothing chart.

Example D.1. The simplest example of this product smoothing can be seen in toric varieties. Let $\check{X}_1, \check{X}_2 = \mathbb{C}$, and let $(X_1^{int}, \mathfrak{f}_1), (X_2^{int}, \mathfrak{f}_2)$ be the mirror stopped domains, so that $X_i = \{z \in \mathbb{C}^* : -1 < \log |z| < 1\}$. The FLTZ stop is the point $e^{-1} \in \mathbb{C}^*$. The contact boundary for $X_1 \times X_2$ with rounded corners can be obtained by first considering the product of the symplectic completions, $X_1 \times X_2 \subset (\mathbb{C}^*)^2 = T^*T^2$, and taking the unit conormal bundle $S_1^*(T^2) = T^2 \times S^1$. The boundary stratification given by [GPS19] covers this with three charts: $(S^1 \times S^0) \times X_2, X_1 \times (S^1 \times S^0)$, and $(S^0 \times S^1) \times (S^1 \times S^0) \times \mathbb{R}$. The product stop is made of three components, and is topologically:

$$\overline{\mathfrak{f}_1 \times \mathfrak{f}_2} = (\{e^{-1}\} \times S^1) \cup (S^1 \times \{e^{-1}\}) \cup (\{e^{-1}\} \times \{e^{-1}\} \times \mathbb{R}).$$

This last portion gives us the real quarter circle $(e^{-1} \cdot \cos \theta, e^{-1} \cdot \sin \theta) \subset S^1 \times T^2$ with $\theta \in [0, \pi/2]$. We can complete the product stop to a skeleton, which has four components, $S^1 \times S^1, \mathbb{R}_{>0} \times S^1, S^1 \times \mathbb{R}_{>0}$, and $\mathbb{R}_{>0} \times \mathbb{R}_{>0}$. The obtained skeleton matches the FLTZ skeleton for the mirror to \mathbb{C}^2 . More generally, the product of FLTZ skeletons is the FLTZ skeleton of the product fan.

A stopped Liouville domain (X, \mathfrak{f}) is called *totally stopped* if there is a positive flow from any point of $(\partial X^{int}) \setminus \mathfrak{f}$ to the stop. In this case, there exists a sequence of admissible positive wrappings so that for every point $x \in \partial X^{int}$, $\lim_{t \rightarrow \infty} \theta^t(x) \in \mathfrak{f}$. Similarly, we say that an admissible Lagrangian $L \subset (X, \mathfrak{f})$ is *totally stopped* if there is a Reeb chord from every point $x \in \partial_0 L$ to \mathfrak{f} . Conjecturally, totally stopped Liouville domains should have compact mirrors. If a Lagrangian L is totally stopped, it is expected to be mirror to a perfect complex with compact support.

Definition D.2. An admissible Lagrangian correspondence $L_{12} : (X_1, \mathfrak{f}_1) \Rightarrow (X_2, \mathfrak{f}_2)$ is an admissible Lagrangian submanifold $L_{12} \subset (X_1^- \times X_2, \overline{\mathfrak{f}_1 \times \mathfrak{f}_2})$.

Proposition D.3. *Suppose that $L_{12} \subset (X_1^- \times X_2, \overline{\mathfrak{f}_1 \times \mathfrak{f}_2})$ is a Lagrangian correspondence and that $L_1 \subset (X_1, \mathfrak{f}_1)$ is a totally stopped Lagrangian. There exists L'_1 , admissibly Hamiltonian isotopic to L_1 , and $X_2^{int} \subset X_2$ compact so that $L_{12} \circ L'_1$ avoids $\mathbb{L}_2 \setminus X_2^{int}$.*

Proof. As L_{12} is admissible, L_{12} is disjoint from $(\mathbb{L}_1 \times \mathbb{L}_2) \setminus (X_1^{int} \times X_2^{int})$. Therefore $\pi_1(L_{12} \cap (X_1 \times \mathbb{L}_2))$ is disjoint from X_1^ε , a small neighborhood of \mathbb{L}_1 . Since L_1 is totally stopped, there exists L'_1 , admissibly Hamiltonian isotopic to L_1 , so that $L'_1 \subset X_1^\varepsilon$. Therefore, $\pi_1^{-1}(L'_1)$ is disjoint from $L_{12} \cap \pi_2^{-1}(\mathbb{L}_2 \setminus X_2^{int})$, and we conclude that $L_{12} \circ L'_1$ is disjoint from $\mathbb{L}_2 \setminus X_2^{int}$. \square

We note that “totally stopped” is not a necessary requirement for making sense of Lagrangian correspondences of Liouville domains. For instance, any symplectomorphism of a Liouville domain which preserves the stop should give rise to a Lagrangian correspondence which preserves admissible Lagrangian submanifolds. A more general set of examples come from stop removal in FLTZ skeletons; in particular the functors explored in Section 6 mirror to localization away from a divisor and toric blowdown.

Proposition D.4. *Suppose that $L_{12} \subset X_1^- \times X_2$ is an admissible Lagrangian correspondence between Liouville domains. Let $L_1 \subset X_1$ be an admissible Lagrangian submanifold. Then there exists a Lagrangian submanifold L_2 , Hamiltonian isotopic to $L_{12} \circ L_1$, which is an admissible Lagrangian submanifold of X_2 .*

The proof we give follows [GPS18b, Section 6.2], which discusses admissibility of a product Lagrangian in a product Liouville manifold.

Proof. Let $f_1 : L_1 \rightarrow \mathbb{R}$ be the primitive for $\lambda_{X_1}|_{L_1}$. We look at compact sets $X_1^{int} \subset X_1, X_2^{int} \subset X_2$ so that L_1 is conical outside of X_1^{int} , and L_{12} is conical outside of $X_1^{int} \times X_2^{int}$. Following [GPS18b, Lemma 6.1], we will assume that f_1 has compact support. Extend f_1 to a compactly supported function $f_1 : X_1 \rightarrow \mathbb{R}$. Pick a bump function $\rho_2 : X_2 \rightarrow \mathbb{R}$ with the property that $\rho_2 \circ \pi_{X_2}((X_1 \times X_2) \setminus B_\epsilon(X_1^{int} \times X_2^{int})) = 1$, and vanishes inside $X_1^{int} \times X_2^{int}$.

From the primitives $d\lambda_i = \omega_i$ for X_i , we construct a modified primitive for $\omega_1 \oplus (-\omega_2)$ on $X_1 \times X_2$ given by

$$\tilde{\lambda} = \lambda_1 - \lambda_2 + d(\rho_2 f_1).$$

For this modified $\tilde{\lambda}$ we show that the Liouville vector field $\tilde{Z}_{X_1 \times X_2}$ is parallel to the submanifold $\pi_1^{-1}(L_1) \subset X_1 \times X_2$ outside of a compact set:

- Over $X_1 \times X_2 \setminus \pi_1^{-1}(X_1^{int})$, the function f_1 vanishes, so the Liouville vector field reduces to

$$\tilde{Z}_{X_1 \times X_2}|_{\pi_1^{-1}(X_1^{int})} = Z_{X_1} - Z_{X_2}$$

As L_1 is conical outside of X_1^{int} , the tangent space $T(\pi_1^{-1}(L \setminus X_1^{int}))$ contains $\langle Z_X \rangle \times TX_2$; in particular, $\pi_1^{-1}(L_1)$ is parallel to $\tilde{Z}_{X_1 \times X_2}$ outside of $\pi_1^{-1}(X_1^{int})$.

- Over $X_1 \times X_2 \setminus \pi_2^{-1}(X_2^{int})$ the bump function is $\rho_2 = 1$, so

$$\tilde{Z}_{X_1 \times X_2} = Z_{X_1} - Z_{X_2} + Z_{f_1}$$

where Z_{f_1} is the Hamilton vector field of $f_1 : X_1 \rightarrow \mathbb{R}$. By design $Z_{X_1} + Z_{f_1}$ is parallel to L_1 everywhere. Therefore, the tangent space to $\pi_1^{-1}(L_1)$ contains $\langle Z_{X_1} + Z_{f_1} \rangle \times TX_2$ outside of $\pi_2^{-1}(X_2 \setminus X_2^{int})$; in particular, this is parallel to $\tilde{Z}_{X_1 \times X_2}$.

Therefore $\pi_1^{-1}(L_1)$ is $\tilde{\lambda}$ -conical at infinity. Continuing to follow [GPS18b, Section 6.3], the linear interpolation $\tilde{\lambda}_t$ between the Liouville structures $\lambda_{X_1 \times X_2}$ and $\tilde{\lambda}_{X_1 \times X_2}$ is a Liouville homotopy; therefore by [CE12, Proposition 11.8], there exists an exact symplectic isotopy Φ_t of $X_1 \times X_2$ inducing this Liouville homotopy.

We now give a short outline of [CE12, Proposition 11.8] to additionally show that this exact symplectic isotopy can be chosen with support in a neighborhood of $\pi^{-1}(L_1)$. This will allow us to choose this exact symplectic isotopy in such a way that we continue to avoid the stop. For notational convenience, we will write $X = X_1 \times X_2$ and $\lambda_t = \tilde{\lambda}_t$. A Liouville homotopy consists of a family of domains $X_t^k \subset X$ which exhaust X along which Z_{λ_t} points outward. For each t , there exists a contactomorphism $f_t^k : Y_0^k \rightarrow Y_t^k$, where Y_t^k is the contact boundary to (X_t^k, λ_t) . This contactomorphism arises from Gray's theorem, and is the identity outside of the support of $\frac{d}{dt}\lambda_t$. This contactomorphism does not preserve the contact form, which differs from the original contact form by a scaling factor given by a function $\rho_t^k : Y_t^k \rightarrow \mathbb{R}$.

Let $Y_t^{k,c} = \phi_{Z_{\lambda_t}^c}^c(Y_t^k)$, the time c flow of the contact boundary Y_t^k along the Liouville vector field Z_{λ_t} . Since the Z_{λ_t} agree where $\frac{d}{dt}\lambda_t = 0$, the compositions

$$\phi_t^{k,c} := \phi_{Z_{\lambda_t}^c}^c \circ f_t^k \circ \phi_{Z_{\lambda_t}^c}^{-c} : Y_0^{k,c} \rightarrow Y_t^{k,c}$$

are equal to the identity on the region where $\frac{d}{dt}\lambda_t = 0$. Then, [CE12] uses these diffeomorphisms on the contact slices of X to build a family of symplectomorphisms on disjoint open neighborhoods of the $Y_t^{k,c}$ in X . This is accomplished by scaling the neck coordinate of an open neighborhood of $Y_t^{k,c}$ by the ρ_t^k .

The portion of a symplectomorphism defined over a neighborhood of contact slices is extended to a family of diffeomorphisms of $\Phi_s : X \rightarrow X$, where $s \in [0, 1]$. This extension can be done in such a way that it is the identity on $\frac{d}{dt}(\lambda_t) = 0$. From here, Moser's stability is applied to obtain a symplectic isotopy $\tilde{\Phi}_s : X \rightarrow X$ which agree with $\phi_t^{k,c}$ on the slices, and are identity where $\frac{d}{dt}(\lambda_t) = 0$.

Returning to our setup, there exists Hamiltonian symplectomorphism $\tilde{\Phi}_1 : X_1 \times X_2 \rightarrow X_1 \times X_2$, constant over $X_1^{int} \times X_2^{int}$, so that $(\tilde{\Phi}_1)_*(\tilde{Z}_{X_1 \times X_2}) = Z_{X_1 \times X_2}$, and $\tilde{\Phi}_1 = \text{id}$ outside the support of f_1 . With this Hamiltonian isotopy, $\tilde{\Phi}_1(\pi_1^{-1}(L_1))$ is parallel to $Z_{X_1 \times X_2}$ outside of a compact set.

The corrected geometric composition of L_{12} and L_1 is defined to be:

$$L_{12}\tilde{\circ}(L_1) := \pi_2(\tilde{\Phi}_1(\pi_1^{-1}(L_1)) \cap L_{12}).$$

Since $\tilde{\Phi}_1(\pi_1^{-1}(L_1)), K_{12}$ are both parallel to $Z_{X_1 \times X_2} = (Z_{X_1}, Z_{X_2})$ outside of $\pi_2^{-1}(X_2^{int})$, the corrected geometric composition is parallel to Z_{X_2} outside of the set X_2^{int} . \square

Corollary D.5. *Suppose (X_1, \mathfrak{f}_1) is totally stopped. Let $L_1 \in (X_1, \mathfrak{f}_1)$ be an admissible Lagrangian, and $L_{12} : (X_1, \mathfrak{f}_1) \Rightarrow (X_2, \mathfrak{f}_2)$ be an admissible Lagrangian correspondence. Then there exists L'_1 , admissibly Hamiltonian isotopic to L_1 , so that the geometric composition $L_{12}\tilde{\circ}L'_1$ is an admissible Lagrangian submanifold of (X_2, \mathfrak{f}_2) .*

Proof. Pick L'_1 as in the proof of Proposition D.3. From the proof of Proposition D.3, $L'_1 \subset X_1^\varepsilon$. The construction of the isotopy to correct the geometric composition in Proposition D.4 relied on a choice of extension of f_1 , the primitive of λ_1 on L'_1 to X_1 . Choose such an extension so that the support of f_1 is contained in X_1^ε . Then by the argument above, the image of $\Phi(\pi_1^{-1}(L'_1))$ lies within the preimage of the support of f_1 , which is contained inside $\pi_1^{-1}(X_1^\varepsilon)$. This is sufficient to carry out the remainder of the proof Proposition D.3 showing that $\pi_2(\Phi(\pi_1^{-1}(L_1)) \cap L_{12})$ is disjoint from $\mathbb{L}_2 \setminus X_2^{int}$. \square

References

- [AB10] Dmitry Arinkin and Roman Bezrukavnikov. "Perverse coherent sheaves." *Moscow Mathematical Journal* 10.1 (2010), pp. 3–29.
- [Abo06] Mohammed Abouzaid. "Homogeneous coordinate rings and mirror symmetry for toric varieties." *Geometry and Topology* 10 (2006), pp. 1097–1156.
- [Abo09] Mohammed Abouzaid. "Morse homology, tropical geometry, and homological mirror symmetry for toric varieties." *Selecta Mathematica* 15 (2009), pp. 189–270.
- [AKO06] Denis Auroux, Ludmil Katzarkov, and Dmitri Orlov. "Mirror symmetry for del Pezzo surfaces: vanishing cycles and coherent sheaves." *Inventiones Mathematicae* 166.3 (2006), pp. 537–582.
- [AKO08] Denis Auroux, Ludmil Katzarkov, and Dmitri Orlov. "Mirror symmetry for weighted projective planes and their noncommutative deformations." *Annals of Mathematics* 167 (3 2008), pp. 867–943.
- [Arn80] Vladimir Arnol'd. "Lagrange and Legendre cobordisms. I." *Functional Analysis and Its Applications* 14.3 (1980), pp. 167–177.
- [Aur07] Denis Auroux. "Mirror symmetry and T -duality in the complement of an anticanonical divisor." *Journal of Gökova Geometry Topology. GGT* 1 (2007), pp. 51–91.

- [Bal+15] Matthew Ballard, Colin Diemer, David Favero, Ludmil Katzarkov, and Gabriel Kerr. “The Mori program and non-Fano toric homological mirror symmetry.” *Transactions of the American Mathematical Society* 367 (12 2015), pp. 8933–8974.
- [BC14] Paul Biran and Octav Cornea. “Lagrangian cobordism and Fukaya categories.” *Geometric and functional analysis* 24.6 (2014), pp. 1731–1830.
- [BCS05] Lev A. Borisov, Linda Chen, and Gregory G. Smith. “The orbifold Chow ring of toric Deligne-Mumford stacks.” *Journal of the American Mathematical Society* 18.1 (2005), pp. 193–215.
- [Bos21] Valentin Bosshard. “On Lagrangian Cobordisms in Liouville manifolds.” *arXiv:2105.14821* (2021).
- [Can+91] Philip Candelas, C Xenia, Paul S Green, and Linda Parkes. “A pair of Calabi-Yau manifolds as an exactly soluble superconformal theory.” *Nuclear Physics B* 359.1 (1991), pp. 21–74.
- [CE12] Kai Cieliebak and Yakov Eliashberg. *From Stein to Weinstein and back: symplectic geometry of affine complex manifolds*. Vol. 59. American Mathematical Society, 2012.
- [Cha+17] Baptiste Chantraine, Georgios Dimitroglou Rizell, Paolo Ghiggini, and Roman Golovko. “Geometric generation of the wrapped Fukaya category of Weinstein manifolds and sectors.” *arXiv:1712.09126* (2017).
- [Cha20] Kwokwai Chan. “SYZ mirror symmetry for toric varieties.” *Handbook for Mirror Symmetry of Calabi-Yau and Fano Manifolds, Adv. Lect. Math.* Vol. 47. Int. Press, Somerville, MA, 2020, pp. 1–32.
- [Cla16] Patrick Clarke. “Dual fans and mirror symmetry.” *Advances in Mathematics* 301 (2016), pp. 902–933.
- [CLS11] David A Cox, John B Little, and Henry K Schenck. *Toric Varieties*. Vol. 124. American Mathematical Soc., 2011.
- [CPU16] Kwokwai Chan, Daniel Pomerleano, and Kazushi Ueda. “Lagrangian sections on mirrors of toric Calabi-Yau 3-folds.” *arXiv:1602.07075* (2016).
- [DJL19] Tobias Dyckerhoff, Gustavo Jasso, and Yankı Lekili. “The symplectic geometry of higher Auslander algebras: Symmetric products of disks.” *arXiv:1911.11719* (2019).
- [Ewa12] Günter Ewald. *Combinatorial convexity and algebraic geometry*. Vol. 168. Springer Science & Business Media, 2012.
- [Fan+11] Bohan Fang, Chiu-Chu Melissa Liu, David Treumann, and Eric Zaslow. “A categorification of Morelli’s theorem.” *Inventiones mathematicae* 186.1 (2011), pp. 79–114.
- [Fan+14] Bohan Fang, Chiu-Chu Melissa Liu, David Treumann, and Eric Zaslow. “The coherent-constructible correspondence for toric Deligne-Mumford stacks.” *International Mathematics Research Notices. IMRN* 4 (2014), pp. 914–954.
- [Fuk+07] Kenji Fukaya, Yong-Geun Oh, Hiroshi Ohta, and Kaoru Ono. “Lagrangian surgery and holomorphic discs.” *Lagrangian Intersection Floer Theory: Anomaly and Obstruction* (2007).
- [GPS18a] Sheel Ganatra, John Pardon, and Vivek Shende. “Microlocal Morse theory of wrapped Fukaya categories.” *arXiv:1809.08807* (2018).

- [GPS18b] Sheel Ganatra, John Pardon, and Vivek Shende. “Sectorial descent for wrapped Fukaya categories.” *arXiv:1809.03427* (2018).
- [GPS19] Sheel Ganatra, John Pardon, and Vivek Shende. “Covariantly functorial wrapped Floer theory on Liouville sectors.” *Publications mathématiques de l’IHÉS* (2019), pp. 1–128.
- [Gro13] Mark Gross. “Mirror symmetry and the Strominger-Yau-Zaslow conjecture.” *Current developments in mathematics 2012*. Int. Press, Somerville, MA, 2013, pp. 133–191.
- [GS17] Benjamin Gammage and Vivek Shende. “Mirror symmetry for very affine hypersurfaces.” *arXiv:1707.02959* (2017).
- [Han19] Andrew Hanlon. “Monodromy of monomially admissible Fukaya-Seidel categories mirror to toric varieties.” *Advances in Mathematics* 350 (2019), pp. 662–746.
- [Hic20] Jeffrey Hicks. “Tropical Lagrangian hypersurfaces are unobstructed.” *Journal of Topology* 13.4 (2020), pp. 1409–1454.
- [Hit97] Nigel J. Hitchin. “The moduli space of special Lagrangian submanifolds.” *Annali della Scuola Normale Superiore di Pisa. Classe di Scienze. Serie IV* 25.3-4 (1997). Dedicated to Ennio De Giorgi, 503–515 (1998). ISSN: 0391-173X.
- [HV00] Kentaro Hori and Cumrun Vafa. “Mirror symmetry.” *arXiv:hep-th/0002222* (2000).
- [KK17] Ludmil Katzarkov and Gabriel Kerr. “Partially wrapped Fukaya categories of simplicial skeleta.” *arXiv:1708.06038* (2017).
- [Kon95] Maxim Kontsevich. “Homological algebra of mirror symmetry.” *Proceedings of the international congress of mathematicians*. Springer, 1995, pp. 120–139.
- [Kuw20] Tatsuki Kuwagaki. “The nonequivariant coherent-constructible correspondence for toric stacks.” *Duke Mathematical Journal* (2020).
- [NZ09] David Nadler and Eric Zaslow. “Constructible sheaves and the Fukaya category.” *Journal of the American Mathematical Society* 22.1 (2009), pp. 233–286.
- [Orl93] Dmitri Orlov. “Projective bundles, monoidal transformations, and derived categories of coherent sheaves.” *Russian Academy of Sciences. Izvestiya Mathematics* 41.1 (1993), p. 133.
- [OT20] Yong-Geun Oh and Hiro Lee Tanaka. “ A_∞ -categories, their ∞ -category, and their localizations.” *arXiv:2003.05806* (2020).
- [Rou10] Raphaël Rouquier. “Derived categories and algebraic geometry.” *Triangulated Categories*. Ed. by Thorsten Holm, Peter Jørgensen, and Raphaël Rouquier. London Mathematical Society Lecture Note Series. Cambridge University Press, 2010, 351–370. DOI: 10.1017/CB09781139107075.008.
- [Sei00] Paul Seidel. “Graded Lagrangian submanifolds.” *Bulletin de la Société Mathématique de France* 128.1 (2000), pp. 103–149.
- [Sei01] Paul Seidel. “More about vanishing cycles and mutations.” *Symplectic Geometry And Mirror Symmetry*. World Scientific, 2001, pp. 429–465.
- [Sei08] Paul Seidel. *Fukaya categories and Picard-Lefschetz theory*. European Mathematical Society, 2008.

- [SS21] Nick Sheridan and Ivan Smith. “Lagrangian cobordism and tropical curves.” *Journal für die reine und angewandte Mathematik (Crelles Journal)* 2021.774 (2021), pp. 219–265.
- [Sub10] Aleksandar Subotic. “A monoidal structure for the Fukaya category.” PhD thesis. Harvard University, 2010.
- [Syl19a] Zachary Sylvan. “On partially wrapped Fukaya categories.” *Journal of Topology* 12.2 (2019), pp. 372–441.
- [Syl19b] Zachary Sylvan. “Orlov and Viterbo functors in partially wrapped Fukaya categories.” *arXiv:1908.02317* (2019).
- [SYZ96] Andrew Strominger, Shing-Tung Yau, and Eric Zaslow. “Mirror symmetry is T-duality.” *Nuclear Physics B* 479 (1996), pp. 243–259.
- [Tan18] Hiro Lee Tanaka. “Generation for Lagrangian cobordisms in Weinstein manifolds.” *arXiv:1810.10605* (2018).
- [WW07] Katrin Wehrheim and Chris T Woodward. “Functoriality for Lagrangian correspondences in Floer theory.” *arXiv:0708.2851* (2007).
- [Zho19] Peng Zhou. “Twisted polytope sheaves and coherent-constructible correspondence for toric varieties.” *Selecta Mathematica* 25.1 (2019).
- [Zho20] Peng Zhou. “Lagrangian Skeleta of Hypersurfaces in $(\mathbb{C}^*)^n$.” *Selecta Mathematica* 26.26 (2020).

A. Hanlon, DEPARTMENT OF MATHEMATICS, STONY BROOK UNIVERSITY AND SIMONS CENTER FOR GEOMETRY AND PHYSICS

E-mail address: `andrew.hanlon@stonybrook.edu`

J. Hicks, SCHOOL OF MATHEMATICS, UNIVERSITY OF EDINBURGH

E-mail address: `jeff.hicks@ed.ac.uk`