

# Semantic Relations Between Nominals

## Second Edition

Vivi Nastase, Stan Szpakowicz,  
Preslav Nakov and Diarmuid Ó Séaghdha

Morgan & Claypool, 2021 (to appear)

[www.morganclaypool.com/toc/hlt/1/1](http://www.morganclaypool.com/toc/hlt/1/1)

### *Chapter 5*

## Semantic Relations and Deep Learning

Vivi Nastase\* and Stan Szpakowicz\*\*

\* Institute for Natural Language Processing

University of Stuttgart, Germany  
[vivi.nastase@ims.uni-stuttgart.de](mailto:vivi.nastase@ims.uni-stuttgart.de)

\*\* School of Electrical Engineering

and Computer Science  
University of Ottawa, Canada  
[szpak@eecs.uottawa.ca](mailto:szpak@eecs.uottawa.ca)

by the kind permission of Morgan & Claypool

# Semantic Relations and Deep Learning

## 5.1 The new paradigm

The theoretical foundations of artificial neural networks, inspired by biological processes, were laid in the 1940s [McCulloch and Pitts, 1943]. The firing of a neuron would represent a proposition, simulating logical calculus in a (neural) network by the activation or inhibition of connections. The perceptron, the algorithm behind the functioning of a single artificial neuron, was invented in the late 1950s [Rosenblatt, 1958]. There followed the layered structure of the networks familiar to us now, and the back-propagation mechanism, the core of the learning process in this paradigm. Rumelhart et al. [1986] showed how the back-propagation mechanism can lead to a useful representation on intermediate hidden layers, when they encoded people and family relationships.

The term *deep learning* is rather new, and the “take-over” of NLP is quite recent, driven mostly by the advances in hardware that have made the theoretical models computationally feasible and efficient on NLP’s large-scale corpora, including the induction of semantic representations of words [Mikolov et al., 2013c]. Neural networks were fully formed by the time NLP adopted them. They came with many architectures and with mathematical models which the machine learning community developed over the intervening decades. The interplay goes both ways: the particular requirements of NLP tasks have spurred further developments and innovations.

The adoption of deep learning in work on semantic relations has led to methods and modelling assumptions unlike those explored in the previous chapters. There are differences at several levels.

**Modelling.** In the work described in the preceding chapters, the process of building representations for relation instances is separate from the model which learns to predict relations. First, relation instances are represented by a specially designed set of features; next, a machine-learning algorithm works on the training data represented by the chosen formalism. This two-step process is not necessary in the neural framework. Semantic relations and their arguments can be, and often are, encoded (that is to say, modelled) together. The encoding of entities depends on the semantic relations in which they

participate, while the encoding of semantic relations depends on the arguments they connect.

**Assumptions about relations.** Disjointness was one of the desiderata for a “good” list of semantic relations. The set of semantic relations would in effect partition the space of relation instances. This constraint was useful in traditional learning, where one seldom allowed an instance to belong to multiple classes. When relations which express world knowledge were added to the mix (*e.g.*, *bornIn*, *diedIn*), it became common to have two entities connected by more than one semantic relation. In deep learning, the loss of this constraint is not troublesome. Neural networks can deal quite easily with multi-class learning. This means that one can use richer inventories of semantic relations, such as those coming from knowledge graphs, which are often multi-graphs: two vertices can be connected by edges of more than one type.

**Data sources.** Traditional machine learning usually acts on a collection of instances, represented in a systematic manner. Information from different sources can be combined in one feature vector, but the production of feature values for pre-specified features may lead to loss of valuable structural or contextual information. In deep learning, hybrid models easily combine different sources of information such as free-form text and structured knowledge graphs. The use of data as a knowledge graph—a set of interconnected relation triples—affects the modelling of the arguments and of the relations.

We begin the chapter with a very high-level overview of deep learning in Section 5.2. We then revisit the research problems relevant to semantic relations. Deep learning for semantic relations often combines in one architecture the processing of an entire sentence which contains a candidate relation. The matter of representing the meaning of the arguments will be intertwined with the representation of the context and the relational clues—the expression which connects the relation arguments, and the surrounding text. To make things clearer, and to allow for untried combinations, word representations (attributional features, Section 5.3) are presented separately from relation clues and context (relational features, Section 5.4). Section 5.5 discusses concerns around datasets, notably deep-learning solutions to distant supervision: how to get automatically, and handle, large amounts of noisy training data. Section 5.6 deals with the learning and modelling of semantic relations, either as particular structures or as neural models; it shows how argument representations and contextual clues are interwoven in various learning models.

The new possibilities in the learning of semantic relations have led to a wide variety of solutions; we survey them here. But new methods crop up even as we write, so this chapter is doomed to remain incomplete. The goal is to give the reader a solid overview of the current topics in relation learning, to elaborate on some of the solutions in the

literature, and to point her, whenever possible, toward a reference which presents some of these matters in more detail.

## 5.2 A high-level view of deep learning for semantic relations

Our presentation relies on the reader’s exposure to the theory and methods of deep learning. For the uninitiated, there are tutorials and books online. For example, Goodfellow et al. [2016] give an excellent account of deep learning paradigms and methods.<sup>1</sup> This section is a brief overview of the main concepts relevant to the task at hand.

A deep-learning algorithm accepts an input, usually represented as a real-valued vector, and applies to it a function which maps it onto some output values; those values determine the classification decision. In the case of semantic relations, the input represents a relation’s arguments, its sentential context, additional relational information from a corpus, or a combination thereof. The output represents the prediction: does the posited relation hold between these arguments? The function and its parameters are the relation model, and it depends on the modelling assumptions and the underlying architecture. This sounds like traditional machine learning but there is an essential difference. In deep learning, model derivation (*i.e.*, learning the parameter values) takes multiple steps of back-and-forth processing through the layers of the neural network. As a result, even the input state can be transformed according to the neural architecture, the parameters and the discrepancy between the expected and the computed output.

Consider an example. We can choose to give our neural network information only about a relation’s arguments, as a concatenation of the representations of these arguments as real-valued vectors. If there is little training data, the representation can consist of vectors which were pretrained on very large corpora—now commonly known as *word embeddings* (see Section 5.3). They can be adjusted during training, or kept fixed. If a large amount of training data is available, the vectors can be seeded with random values which are then adjusted during training, so that in combination with the mapping function, *i.e.*, the model, they produce a good approximation of the output, *i.e.*, relation labels.

The mapping function can be a scoring function. Such a function combines the input vector  $\mathbf{i}$  with the parameters  $\mathbf{r}$  which model a target relation  $r$ ,<sup>2</sup> with the output as a real value between 0 and 1:

$$f(\mathbf{i}, \mathbf{r}) \in [0, 1] \tag{5.1}$$

To continue with our example, let us make the following assumptions:

<sup>1</sup>[www.deeplearningbook.org](http://www.deeplearningbook.org).

<sup>2</sup>Throughout this chapter, representations—*e.g.*, embeddings of entities and relations—are written in **bold**, and entities and relations in *italics*.

#### 4 5. SEMANTIC RELATIONS AND DEEP LEARNING

- the input  $\mathbf{i}$  consists of the embeddings for the relation's two arguments  $\mathbf{v}_1$  and  $\mathbf{v}_2$ , which are real-valued vectors of size  $d$ :  $\mathbf{v}_1, \mathbf{v}_2 \in \mathbb{R}^d$ ;
- the relation  $r$  is modelled as a  $d \times d$  matrix  $\mathbf{r}$ :  $\mathbf{r} \in \mathbb{R}^{d \times d}$ ;
- multiplication is chosen to model the interaction between the arguments and the relation.

In this case, the mapping function will look as follows ( $^\top$  is matrix transposition):

$$f : \mathbb{R}^d \times \mathbb{R}^d \times \mathbb{R}^{d \times d} \rightarrow [0, 1] \quad (5.2)$$

$$f(\mathbf{v}_1, \mathbf{v}_2, \mathbf{r}) = \mathbf{v}_1^\top \mathbf{r} \mathbf{v}_2 \quad (5.3)$$

This is actually a model called RESCAL [Nickel et al., 2011].  $f$  should return 1 if relation  $r$  holds between these arguments, 0 otherwise. In practice, the function will return a real value in  $[0,1]$ .<sup>3</sup> During training, the parameters will be adjusted in order to bring the value as close to the actual expected value as possible. During testing, a preset threshold usually helps determine if a new combination  $(\mathbf{v}_i, \mathbf{r}, \mathbf{v}_j)$  represents the instance of a relation  $r$  which holds between arguments  $i$  and  $j$  represented by their corresponding vectors.

A mapping function can be almost arbitrarily complex, and can be implemented by various neural network architectures. Let us engage for a while in name-dropping—and acronym-dropping. At our disposal, there are recurrent neural networks (RNN), convolutional neural networks (CNN) or stacks of different types of neural networks, so as to model different types of interactions between the various parts of the input. Each architecture has its own implementation choices, *e.g.*, long short-term memory units (LSTM), rectified linear activation units (ReLU) or gated recurrent units (GRU), each with its own specific properties which make them more suitable for some applications than for others. Long sequences are often encoded with, *e.g.*, a bi-directional RNN using LSTM (BiLSTM). The latest advance is the Transformer architecture, starting with the Bidirectional Encoder Representations from Transformers (BERT) [Devlin et al., 2018, 2019]<sup>4</sup> and Generative Pretrained Transformer (GPT).<sup>5</sup> The input vector itself can be the output of a neural network.

The parameters of the model are learned during training. The output of a computational unit is a function over the input combined with the unit's weights—its internal parameters. The algorithm uses a *loss function* to compare the predicted output of the entire network to the expected output (referred to as the gold standard). The difference

<sup>3</sup>A softmax function may be necessary to map the actual value into the  $[0,1]$  interval.

<sup>4</sup>Devlin et al.'s [2018] truly seminal paper on BERT has started a veritable cottage industry. There are versions named SpanBERT, StructBERT, DistilBERT, BERTje, CamemBERT, FlauBERT, RobBERT, KnowBERT, MobilBERT, BERTweet, RuBERT—with certainly **much** more to come.

<sup>5</sup>[openai.com/blog/language-unsupervised/](https://openai.com/blog/language-unsupervised/)

between the expected output and the one actually produced, together with a learning rate, determines the amount by which the internal parameters should change so that the error will be reduced. To avoid overfitting the training data, the loss function can include a *regularization* factor. This factor biases the model towards a simpler one which obeys specific constraints on the parameters: representations close in the Euclidean space, fewer non-zero weights, and so on.

Dropout [Srivastava et al., 2014] can also help avoid overfitting. The idea of dropout is that nodes in the network (both their inputs and outputs) are randomly ignored during training. This, in effect, resembles training in parallel a large number of configurations for a neural network. Such a random configuration of nodes makes the training process noisy, and that forces each of the nodes in a layer to contribute more to the final output, to compensate for the inactive ones. It also simulates sparse activation from a given layer, and that encourages the network to actually learn a sparse representation as a side-effect.

When people look at a sentence with an instance of a semantic relation, they see which parts of the sentence are relevant in deciding if the relation holds. The *attention mechanism*—an important enhancement to the neural machinery—allows us to model this insight. An implementation of attention filters the representation of the relation instance through a set of weights, and so boosts the contribution of certain parts of a layer in the network (*e.g.*, specific words in the context on the input layer) while limiting the effect of others. These weights, as everything in the model, are learned during training.

This chapter will present several options for each of these aspects of deep learning in the task of semantic relation classification. Section 5.3 and 5.4 describe types of input. Section 5.3 shows how to represent a relation’s arguments given only an unstructured text collection, only a knowledge graph or a wordnet, or both. Section 5.4 shows how to represent the relational features when taking into account individual words, word sequences, or phrases with grammatical information. Section 5.6 describes architectures which combine the input with internal parameters in a variety of models useful in detecting and classifying semantic relations.

In this chapter, we often write that a representation of words or relations obtained by deep learning is *induced*. We want to clarify the term here, because it helps distinguish between what is deliberately learned, and what is a felicitous side-effect. As noted in the foregoing, learning in neural networks means determining iteratively the best values of internal parameters which lead to a good mapping of the input onto the expected output. The process has “side-effects”, such as the adjustment of the starting input representations, the representation computed by a hidden layer which summarizes the larger-sized input in a useful and compressed manner, and so on. Such side-effects are not the target of the learning process, and their emergence (as it comes about in working

with the data provided) can be seen as not deliberate. When a deep-learning formalism discovers semantic relations, the aim is to map an input instance (*e.g.*, a sentence) onto a relation type. The representations of arguments, relations or even sentences are a useful by-product.

### 5.3 Attributional features: word embeddings

The identification of the semantic relation for a given pair of arguments relies heavily on a good representation of the meaning of the arguments, and of the context in which they appear—if such context is available. Word embeddings in continuous vector spaces are a type of distributional representation. The vectors are no longer indexed by specific words but by more abstract dimensions, assumed to model some underlying latent semantic characteristics of words or entities. Such a representation projects words/entities/morphemes into a multi-dimensional space, in which distance is a proxy for relatedness or similarity. Depending on the data to be modelled or the task at hand, the source of word embeddings can be distributional information (Section 5.3.1), graphs which capture a relational model of meaning (Section 5.3.2), or a combination thereof (Section 5.3.3).

#### 5.3.1 Word embeddings from texts

When a large corpus is available, word meaning can be encoded in a very informative way by distributional representations based on co-occurrences in a window or on grammatical relations. The beauty of such representations is that they are easy to interpret given that the dimensions are themselves words. There are, however, considerable drawbacks.

- The vectors are very large: the vocabulary is often on the order of at least  $10^5$ .
- The dimensions are words, so they are ambiguous. *e.g.*, *run* can refer to exercising, standing for office or executing a program.
- Multiple dimensions can refer to the same thing or perhaps to closely related things, *e.g.*, *buy* and *purchase*.
- Words as dimensions do not solve the sparseness problem because only the same shared dimension indicates an overlap in meaning between words.

A number of methods have been proposed to induce a representation for words in a space with fewer dimensions, much lower than the dimensions in a distributional representation. The number  $d$  of dimensions is a preset parameter. A high value of  $d$  will lead to a larger but more precise representation, while a lower value will yield a more abstract representation. Finding the best balance between these options often depends on the task; commonly chosen values for  $d$  are in the hundreds.

Furnas et al. [1988] applied Singular Value Decomposition (SVD) to the approximation of a word-document co-occurrence matrix. In the process, they uncovered the

latent semantic structure of words and documents as low-dimensional vectors in a new space with orthogonal dimensions.<sup>6</sup> SVD is presented schematically in Figure 5.1. This was a step towards projecting words (and documents) into a continuous low-dimensional vector space.

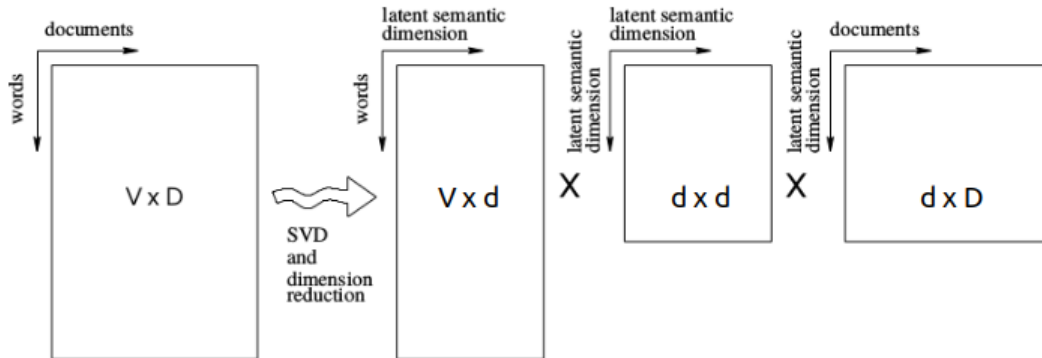

**Figure 5.1:** A schematic representation of approximating a word-document matrix by means of Singular Value Decomposition;  $V$  is the size of the vocabulary,  $D$  is the number of documents in the corpus, and  $d$  is the chosen reduced number of dimensions.

In follow-up work, Jolliffe [2002] showed that Principal Component Analysis (PCA), a variation of SVD, can project the word-document vectors into a lower-dimensional space, and that can help reveal the hidden structure of the data.

SVD and PCA rely on a mathematical theory of decomposing a matrix into a product of matrices, each taken to correspond to some part of the input. These methods are applied to fully specified matrices, *i.e.*, matrices whose every cell has a defined value.<sup>7</sup> To induce word or document representations using SVD and PCA, one most commonly works with word-document or word-word co-occurrence matrices. The values in such matrices can be either binary (recording simple co-occurrence), or real-valued (getting frequency, perhaps normalized, tf-idf or PMI scores).

Topic modelling seldom has the express purpose of deriving vector representations for words. Even so, topics can be viewed as high-level, abstract, semantic dimensions, and they can be used to produce a representation of words in terms of the probability of their appearance under each of the posited topics [Steyvers and Griffiths, 2006, Blei et al., 2003].

<sup>6</sup>The dimensions were low in comparison with the size of the vocabulary, which was the base for standard distributional bag-of-words representations.

<sup>7</sup>This contrasts with adjacency matrices for knowledge graphs—presented later in the chapter—which have mostly unspecified values.



## 8 5. SEMANTIC RELATIONS AND DEEP LEARNING

Bengio et al. [2003] developed a probabilistic framework for predicting a word from the previously seen words. Every word is encoded as a vector, and a window-based context surrounds a target word. After random initialization, the word representations are adjusted to maximize the probability of the seen text. Bengio et al.’s innovation was that they used a neural network to encode the probability function of word sequences in terms of the feature vectors of the words in the sequence. This allowed the system to learn together the vector representations of the words and the parameters of the function. Collobert and Weston [2008] expanded this framework to multi-task learning.

Real-valued vectors which represent word meanings have been more widely adopted since deep-learning methods became widespread in NLP, and renamed as *word embeddings*; see Figure 5.2. Mikolov et al. [2013b,c] developed two complementary techniques of inducing word embeddings, *i.e.*,  $d$ -dimensional real-valued vector representations of words. The *skip-gram model* induces the “true” vector for each word by learning to predict the context (the surrounding words) given a word. The *continuous bag-of-words (BOW) model* induces word representations while learning to predict a word given its context.

It has also been noted that the word embeddings induced by this method acquire several types of syntactic and semantic information about words. Such information is reflected as regularities in the relative position of words in the low-dimensional vector space: plurals, derivations, analogies, and so on [Ethayarajh et al., 2019]. That allows one to use vector arithmetics on word embeddings as proxies for syntactic and semantic operations on words.

These operations can also be useful in establishing that different argument pairs are in the same semantic relation. For example, it can be verified that the relative positions of the first and the second arguments are consistent, *e.g.*, that the vectors connecting capital cities to their respective countries tend to be parallel; see Figure 5.3. Most of the time, there is a more complicated connection between the

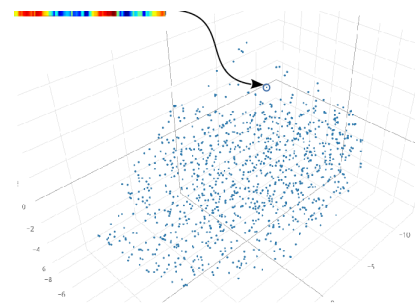

**Figure 5.2:** Example of a word embedding as a real-valued vector, projected into a 3D-space for visualization.

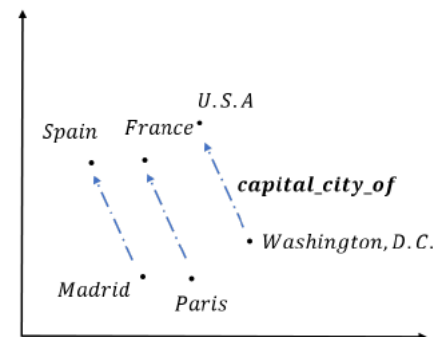

**Figure 5.3:** Semantic relations as relative positions of their arguments.

arguments’ position in this space and the relation between them. Nonetheless, even a complex model of relations relies on there being a degree of similarity (maybe only along certain dimensions) between a relation’s arguments across numerous instances.

There are many methods of inducing word embeddings. Each method leverages slightly differently the information in a word’s context, emphasizes different aspects of a word’s meaning, or produces a context-specific embedding. The earliest methods produced “stand-alone” embeddings. Mikolov et al. [2013c] worked with a context window, Pennington et al. [2014] with grammatical collocations. Neelakantan et al. [2014], Iacobacci et al. [2015] and Pilehvar and Collier [2016] derive word-sense embeddings.

Sennrich et al. [2016] produce embeddings below the word level. To segment words, they use character n-gram models and a byte-pair encoding compression algorithm. The motivation comes from the problem of out-of-vocabulary words in machine translation.

Word embeddings are, in effect, projections of words into a multi-dimensional space; the words’ coordinates in the new space preserve their specific properties. For example, semantically or functionally similar words should be close in such a space. Most models project words onto a Euclidean space, and take various distance metrics as proxies for word similarity.

Other types of spaces may be even more appropriate for meaning representation. Nickel and Kiela [2017] embed words into a hyperbolic space, or more precisely into a Poincaré ball; that is a topologically open space bounded by a  $d$ -dimensional sphere with unit radius,  $B^d = \{x \in \mathbb{R}^d \mid \|x\| < 1\}$ .

Distances in this space are measured along its equivalent of straight lines: arcs orthogonal to the space’s surface boundary. Nickel and Kiela show that the properties of hyperbolic spaces make this kind of representation particularly suited to the modelling of hierarchical data. Distances between words in the hyperbolic space mirror distances between nodes in a tree: distances between words closer to the root (situated somewhere close to the center of the ball) will be larger than distances between words closer to the leaves. Figure 5.4 shows the projection in two dimensions of the embeddings in the Poincaré space



**Figure 5.4:** Two-dimensional Poincaré embeddings of transitive closure of WordNet’s mammal subtree [Nickel and Kiela, 2017].

for words in WordNet. Nickel and Kiela [2018] further optimize this by embedding the taxonomy in the Lorentz model of hyperbolic space.

Contextualized word embeddings are the most recent development. Embeddings from Language Models (ELMo) [Peters et al., 2018] employ a neural architecture based on BiLSTMs. ELMo captures different characteristics of the input words at different levels of the neural architecture, corresponding roughly to characters, syntax and semantics; the representation of a word is a combination of the representations at these levels. Bidirectional Encoder Representations from Transformers (BERT) [Devlin et al., 2018, 2019] dynamically produce word representations informed by the surrounding words. BERT’s architecture—the transformer architecture—is based on attention. Improvements on these models keep coming, for example A Lite BERT (ALBERT) [Lan et al., 2020] (it separates a “general” and lower-dimensional word embeddings from a higher-dimension contextualized representation on the upper levels of the network), Robustly Optimized BERT Pretraining (ROBERTa) [Liu et al., 2019c], and Text-To-Text Transfer Transformer (T5) [Raffel et al., 2019].

Many of the embedding methods supply pretrained word embeddings in a number of languages, or even cross-lingual data such as XLM [Conneau et al., 2019]. These representations, built from very large corpora, can be used as-is, or they can be fine-tuned (or retrofitted) during the relation-learning process. If the relation dataset is large enough—as are some knowledge graphs—the representation of the arguments can be fine-tuned or even learned together with the relation models.

### 5.3.2 Word/entity embeddings from knowledge graphs

The word embeddings discussed thus far came from distributional representations of words in unstructured texts. Words/entities can also be represented by relational models: their meaning is identified by their relations with other words (as in a wordnet) or other entities (as in a knowledge graph). Wordnets and knowledge graphs are symbolic structures but they can be cast into continuous low-dimensional vector spaces. Representations for nodes (words/entities) and edges (relations) can be derived jointly, and these representations encode the relational (graph) structure. Such representations arise from matrix factorization or can be learned by various types of neural networks.

Matrix factorization works on the adjacency matrix or matrices, representing the graph. The factorization operation has a parallel scoring function which combines the representation of entities and relations, and mirrors the factorization split. For example, the bilinear model RESCAL [Nickel et al., 2011] described briefly in Section 5.2 is a matrix factorization model. The adjacency matrix  $A_k$  for relation  $r_k$  is factorized as  $A_k = E^\top M_k E$ ; every column of matrix  $E$  corresponds to an entity embedding, and  $M_k$  is the representation of relation  $r_k$ . The scoring function parallels this expression; each

entry in matrix  $A_k$  corresponding to a triple  $(e_i, r_k, e_j)$  is computed as

$$f_{ijk} = \mathbf{v}_i^\top M_k \mathbf{v}_j \quad (5.4)$$

This function has a clear mathematical expression in terms of the representations of the entities and the relation. The scoring function can also be learned by a neural network, and then it is modelled by the chosen architecture and its learned parameters.

Formally, a graph  $G = \{\mathcal{V}, \mathcal{R}, \mathcal{E}\}$  is a triple: vertices, relation types and edges.<sup>8</sup>

$$\begin{aligned} \mathcal{V} &= \{x_i \mid i = 1, n\} \\ \mathcal{R} &= \{r_k \mid k = 1, m\} \\ \mathcal{E} &= \{(x_i, r_k, x_j) \mid x_i, x_j \in \mathcal{V}, r_k \in \mathcal{R}\} \end{aligned} \quad (5.5)$$

To embed a graph is to find a representation  $\mathbf{v}_x$  for each vertex  $x \in \mathcal{V}$ , and a representation  $\mathbf{r}_k$  for each relation  $r_k \in \mathcal{R}$ . This is based on information about edges—the relation instances  $(x_i, r_k, x_j)$ . The usual assumption is that each  $\mathbf{v}_x \in \mathbb{R}^d$  is a  $d$ -dimensional real-valued vector, with  $d$  chosen *a priori*. The relation can be a vector, a matrix, a higher-order tensor (for  $n$ -ary relations,  $n > 2$ ), and so on.

Other representations are possible. For example, in a knowledge graph built from grammatical relations—so that an edge represents a *(subject, verb, object)* triple—it could make sense to represent these as pairs with composite arguments: *(subject–verb, object)* or *(subject, verb–object)*, and so constrain the representation of the arguments with the given relation. Consider an example. If the subject and the verb in *(man, climb, mountain)* are combined, the pair to be represented will be *(man–climb, mountain)*. That will constrain the (composite) first argument *man–climb* only to objects which a man can climb, as opposed to the more general and separate representations of *man* and *climb*. Figure 5.5 shows the different types of graph representations as adjacency matrices obtained when following these various representations of a relation triple.

The adjacency matrix or tensor of a graph,  $A$ , contains information about the connectivity structure. For a graph containing relation types  $r_k$ ,  $A$ 's elements are:

$$a_{ijk} = \begin{cases} 1 & \text{if } (i, r_k, j) \in \mathcal{E} \\ \text{NaN} & \text{if } (i, r_k, j) \notin \mathcal{E} \end{cases} \quad (5.6)$$

1 is the only defined value in  $A$  (Not-a-Number is the other). That is because knowledge graphs represent only positive instances, *i.e.*, only known relation instances. To learn a non-trivial model, some negative instances are required. Section 5.6.1 will explain the assumptions needed to produce negative relation instances, as a set  $\mathcal{E}'$  of “negative edges”.

<sup>8</sup>There are various terms in graph theory. A *vertex* can also be called a *node*, and an *edge* referred to as an *arc*. We will not try to standardize the terminology because the context is quite unambiguous.

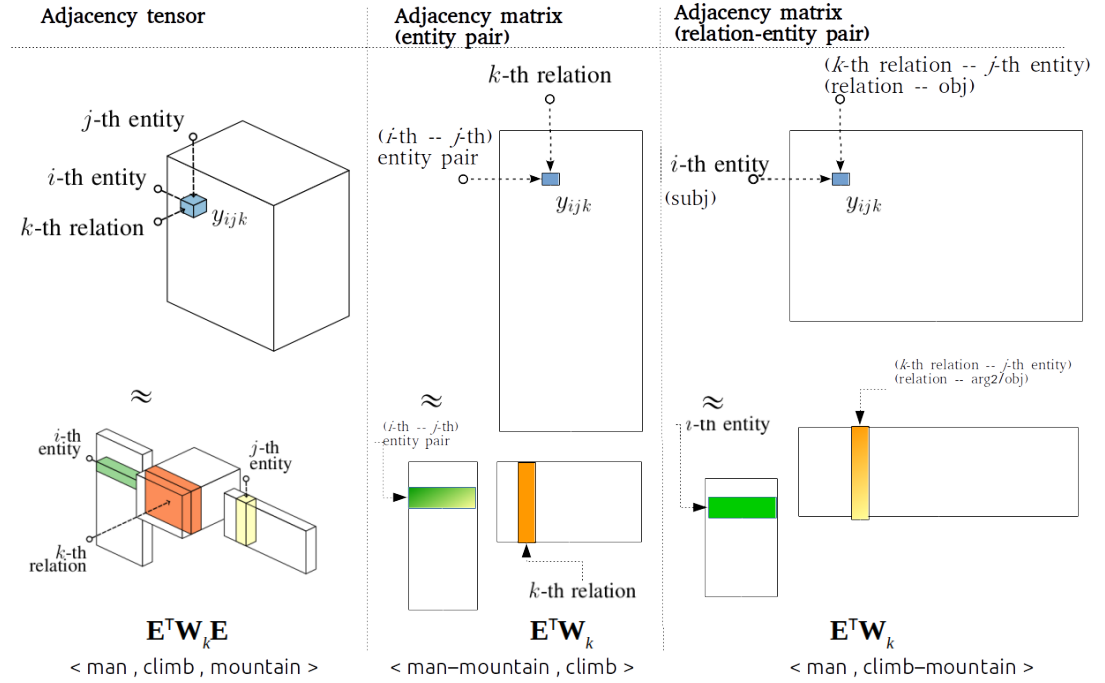

**Figure 5.5:** Representations of vertices and relations in a graph for different views of relation tuples. The adjacency tensor illustration comes from [Nickel et al., 2016a].

The corresponding *scoring function*  $f_{i,j,k}$  parallels the information in the adjacency matrix, and uses the negative edges to learn non-trivial models:

$$f_{ijk} = f(\mathbf{v}_i, \mathbf{r}_k, \mathbf{v}_j) = \begin{cases} 1 & \text{if } (i, r_k, j) \in \mathcal{E} \\ 0 & \text{if } (i, r_k, j) \in \mathcal{E}' \end{cases} \quad (5.7)$$

The function can combine the representation of the entities and relations in various ways. Table 5.2 in Section 5.6.1 shows examples.

Depending on the assumptions about the mathematical form of the representations of entities and relations, and the function  $f$ , these representations can be induced by matrix factorization, as illustrated in Figure 5.5, or by deep-learning methods, as shown on two concrete examples in Figure 5.6. Levy and Goldberg [2014a] very nicely explain the equivalences among some of these methods. Comprehensive overviews of such methods appear in [Nickel et al., 2016b], [Wang et al., 2017] and [Ji et al., 2020]. Section 5.6.1 discusses the effect of these representation on relation learning.

The structure of the knowledge graph directly affects the representations of entities and relations in it. More frequent relations have more informative representations be-

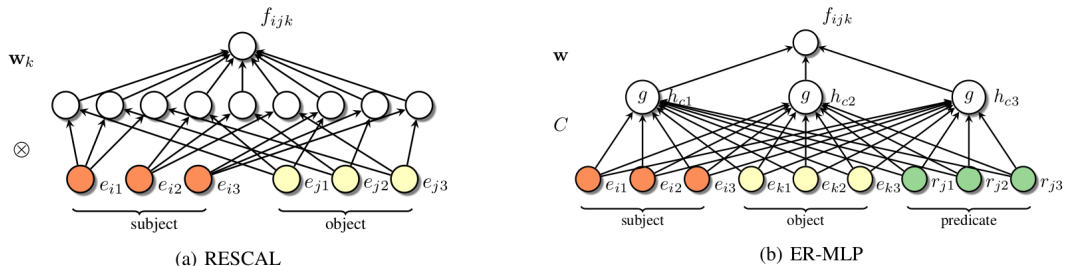
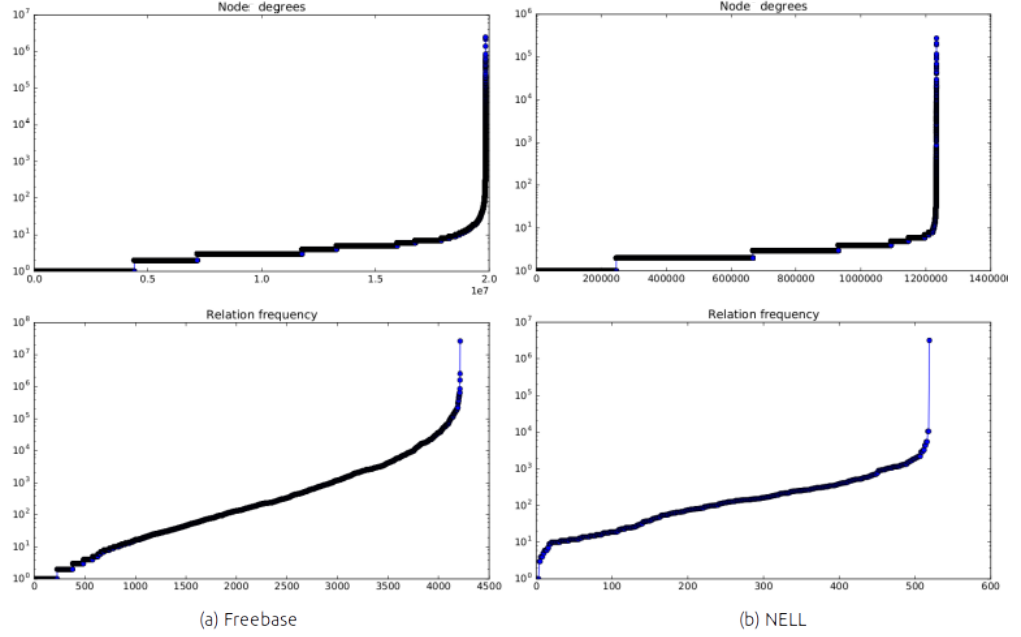

**Figure 5.6:** Embedding graphs with neural networks, two examples from [Nickel et al., 2016a]. In essence, they learn/implement the scoring function  $f_{ijk}$ . (a) A neural network implements the RESCAL matrix factorization model; the representation of the relation is given by the parameters of the hidden layer. (b) A neural network implementation takes a  $(subject, predicate, object)$  triple as an input; the embedding of the relation (*i.e.*, the *predicate*) is learned in parallel with the representation of the *subject* and the *object*.

cause their adjacency matrices are denser. Low-frequency relations, particularly when they connect low-frequency entities, have less informative representations. An analysis of the profile of some of the most frequently used knowledge graphs shows that this is a real concern. Figure 5.7 illustrates it for Freebase and NELL: most of the nodes appear in very few relations, numerous relations have very few instances. This imbalance can be partially countered by the use of entity type information and relation schemata. Such information can be included as an additional factor in the scoring function and in the loss function [Ren et al., 2017, Kotnis and Nastase, 2017], or can help organize and optimize adjacency matrix factorization [Chang et al., 2014].

The origins of graph embedding go back a few decades. Rumelhart et al. [1986] used a neural network with several hidden layers to learn and predict family relationships. They noted that the network weights and the hidden layers capture representations for the entities (people) and their relationships; that allowed them to predict the second argument of a relation given the first argument and the relation. The weights and node values in the network were not used outside the specific experiment.

Paccanaro and Hinton [2002] deliberately set out to induce concept representations from binary relations between concepts in a process they call *linear relational embedding*. They aim for  $n$ -dimensional vector representations of concepts, and  $n \times n$  matrix representations of relations. When a relation is  $R^c$  applied to a concept  $a^c$ —multiplying the corresponding matrix  $\mathbf{R}^c$  by the vector  $\mathbf{a}^c$ —the result is expected to be a related concept  $b^c$  with representation  $\mathbf{b}^c$ . Paccanaro and Hinton obtain the concept and relation representations by maximizing a *discriminative goodness function*  $G$ . It rewards all concepts which can fill the same  $(a^c, R^c, *)$  spot, while maximizing each concept’s



**Figure 5.7:** Knowledge graph statistics on a logarithmic scale: relation and node frequencies for frequently used subsets of Freebase and NELL (data from [Gardner et al., 2014]). Every data point is the degree of a node (top plots), or the frequency of a relation (bottom plots). The data points are ordered monotonically. The  $x$  axis is just an index.

distance to other concepts nearby (to avoid collapsing all representations to zero).

$$G = \sum_{c=1}^C \frac{1}{K_c} \log \frac{e^{-\|\mathbf{R}^c \mathbf{a}^c - \mathbf{b}^c\|_2}}{\sum_{\mathbf{v}_i \in \mathbf{V}} e^{-\|\mathbf{R}^c \mathbf{a}^c - \mathbf{v}_i\|_2}} \quad (5.8)$$

$K_c = |\{(a^c, R^c, *)\}|$  and  $\mathbf{V}$  is the set of all vector representations. This discriminative goodness function is approximated using gradient ascent.

Matrix factorization for the representation of entities in interconnected data was initially motivated by the goal of clustering multi-type interrelated data objects, for example papers, keywords, authors and venues in the domain of scientific publications, or movies, actors and genres in the movie domain [Long et al., 2006]. Clustering was achieved by collective factorization of matrices which represent each relation type (e.g., *movie\_genre*, *movie\_rating*). Two matrices are related if their row or column indices (i.e., their first or second arguments) refer to the same set of objects. Long et al.’s focus was on clustering, reflected in the matrix factorization as a product of cluster and

cluster association information. The representation of concepts—their association with the induced clusters—is a side-effect not explicitly applied outside these experiments.

Singh and Gordon [2008] address directly the task of relation learning for similar multi-type interrelated data. Unlike Long et al., they use matrix factorization to derive entity and relation representations, and focus on predicting new relation instances in a dataset which covers information about movies (genres, rating, and so on). Each matrix to be factorized represents instances of one relation type. Like in Long et al.’s work, Singh and Gordon’s collective matrix factorization relies on shared arguments among relations to connect the factors of the different matrices.

The left and right arguments of a relation can have different roles. It may be useful for an entity  $a$  to have two different representations,  $a_L$  and  $a_R$ , depending on the role it plays. Sutskever and Hinton [2009] induce such a representation by combining topic modelling with matrix factorization. The latent variables in the topic model represent entity and relation clusters. A cluster is represented by its mean and diagonal covariance, and the dual representations for an entity are sampled as vectors from the corresponding cluster. The score of a triple  $(a_L, r, b_R)$  is determined by the product of their representations  $\mathbf{a}_L^\top \mathbf{R} \mathbf{b}_R$ , and that is determined by the clusters to which  $a$ ,  $R$  and  $b$  belong.

Bordes et al. [2011] use a neural network to induce entity and relation representations. Entities are represented as  $d$ -dimensional vectors, and each relation as two  $d \times d$  matrices  $R_k \approx (\mathbf{R}_k^{lhs}, \mathbf{R}_k^{rhs})$ . Bordes et al. hypothesize that if a transformation is applied to each of the two relation arguments  $e_i, e_j$ , then they should become similar. The scoring function, then, is this:

$$f(e_i, r_k, e_j) = \|\mathbf{R}_k^{lhs} \mathbf{v}_i - \mathbf{R}_k^{rhs} \mathbf{v}_j\| \quad (5.9)$$

Knowledge graphs can also be embedded in non-Euclidean spaces. Balazevic et al. [2019] introduce a method of embedding a multi-relational graph in a Poincaré space. Their Multi-Relation Poincaré (MuRP) model learns relation-specific parameters which transform the embeddings of source/target entities. If a relation holds between a source and a target entity, their transformed embeddings are close in the Poincaré space.

Weber and Nickel [2018] discuss and compare the types of embedding spaces with respect to their sectional curvature  $\kappa$ : Euclidean ( $\kappa = 0$ ), spherical ( $\kappa = 1$ ), and hyperboloid ( $\kappa = -1$ ). They note that none of these spaces is optimal for all relational structures. There arises the question of identifying the most suitable embedding space for a given knowledge graph. Weber and Nickel analyze the characteristics of local graph neighbourhoods, which they call “motifs”. A matching space is the space in which the graph motifs can be embedded with the least distortion (or with none). Here are the spaces particularly suited to certain embeddings: hyperbolic spaces (such as the Poincaré space) for tree structures, spherical spaces for  $n$ -cycles, and Euclidean spaces for grid structures. The match is apt because the growth rate of these structures matches the



growth rate and curvature of the space with respect to its parameters (*e.g.*, radius). Weber and Nickel compute a heuristic which estimates the growth rate of a graph from its motifs, and map it onto a curvature value. This determines the best space for embedding the graph.

Nodes in a graph, as well as relations, can also be encoded by methods similar to language models. Perozzi et al. [2014] transform a (social) network into a set of “sentences”: sequences of nodes obtained by random walks started on different nodes of the network. Every such sentence represents part of a node’s neighbourhood information. They are processed by a method similar to the SkipGram model; the obtained node embeddings maximize the probability that the nodes appear in the observed sequences. Wang et al.’s [2020] method is similar; it combines “sentences”—random walks over the graph—with a multi-layered BiLSTM which encodes contextual information. The entity and relation embeddings are weighted linear combinations of the model’s internal states from each layer of the model.

A graph contains various types of structural information which should be reflected in a node’s representation. The neighbourhood of a node can help describe its structural role (*e.g.*, as hubs), while dense paths among nodes define node communities. Grover and Leskovec [2016] aim to develop a graph embedding method in which the node representations reflect all these structural characteristics. Nodes in a closely connected community should be close in the embedding space. Nodes with the same structural roles should have similar representations, too. The proposed node2vec model finds node representations which maximize the probability of their neighbourhoods. The local neighbourhood of a node is best described by paths found using breadth-first search (BFS), whereas more distant connections and community structure are best captured by depth-first search (DFS). Random walks can produce paths which combine characteristics of BFS and DFS to various degrees. Grover and Leskovec experiment with two parameters which can bias a random walker towards BFS or DFS. The node representations based on the random walks so obtained lead to state-of-the-art results on a variety of applications, including link prediction on Facebook and a protein-protein interaction network.

### 5.3.3 Word/entity embeddings from texts and knowledge graphs

The distributional model and the relational model of language complement each other. Their combination could create a richer and more informative representation of meaning: it would identify both the syntagmatic and the paradigmatic information about words.

There are differences between the unstructured language of texts and the consistent—normalized/canonical—representation of nodes and relations in structured knowledge graphs. The differences must be reconciled to take advantage of the information from both these sources. It would be good to be able to “recognize”, or leverage

somehow, concepts from knowledge graphs which surface in texts with different lexicalizations; the same goes for relations.

One can add text co-occurrence information—(*subject, verb, object*) triples extracted by an open information extraction system (Open IE)<sup>9</sup>—to the adjacency matrix, and factorize this enhanced matrix to learn shared embeddings of entities and relations in knowledge graphs and in text [Riedel et al., 2013]. Each argument pair, whether from the graph or from the text, has a corresponding row in the matrix; each relation and predicate has a column. The scoring function for modelling the adjacency information in this matrix combines a few kinds of data: latent feature compatibility between an argument tuple and a relation, neighbourhood information which benefits from relation similarity, and selectional preferences of relations expressed by the entity models of their arguments.

Riedel et al. take the atomic view of nodes and relations from the graph, and of arguments and predicates from texts. This means that the procedure relies on (exact) overlaps between arguments and relations in the knowledge graph and triples extracted by Open IE. The lexical expressions of predicates and arguments from texts, as well as the forms of relations and nodes from structured knowledge repositories, can be leveraged to find deeper similarities. For example, the knowledge base relation *person/organizations\_founded* between a person and the organization which they founded can occur in texts as *founder of*, *co-founded*, *one of the founders of*, *helped establish*, and so on. Toutanova et al. [2015] use a convolutional neural network to get a vector representation for all textual and knowledge base relations based on their expressions. From these representations, they compute the similarity between predicates and relations, and between nodes and arguments from texts. This similarity is further exploited in the loss function which finds an approximation of the adjacency matrix combining knowledge base information and textual relations.

Alsuhaibani et al. [2019] learn hierarchical word embeddings from a corpus and a taxonomy. The taxonomy supplies data about all the ancestors of a word in the taxonomy, and the corpus provides information on the co-occurrence of a word and those ancestors. The signal for tuning the embeddings comes from both sources. The objective function on the taxonomy tries to push the embedding of a word in the taxonomy towards a distance-weighted average of the embeddings of its ancestors. The objective function on the corpus tries to push the embeddings of co-occurring words towards more similarity.

Section 5.6.3 gives a deeper overview of the combination of knowledge graphs and unstructured texts which aims to derive entity and relation representations for learning semantic relations.

<sup>9</sup>*e.g.*, [stanfordnlp.github.io/CoreNLP/openie.html](https://stanfordnlp.github.io/CoreNLP/openie.html)

## 5.4 Relational features: modelling the context

In the pre-deep-learning work on semantic relations, relational features characterize the relation either directly (*e.g.*, via an expression or a dependency path between the two relation arguments in a given context), or by background relational features, *i.e.*, a collection of patterns from a large corpus. The length and the syntactic complexity of such expressions vary, so it is problematic to model them formally in order to provide a learning system with a consistent form. Convolution and tree kernels are frequent solutions in traditional machine learning methods. One can also project background relational features into a fixed-size low-dimensional space. There are solutions particularly suitable to deep learning: learning a composition function which produces a representation of fixed dimensions—usually a vector, a matrix, or both—for any input string (Section 5.4.1 discusses compositionality), or representing and using directly a complex tree or graph structure (Section 5.4.2 discusses graph neural networks).

### 5.4.1 Compositionality

The context—and even the relation arguments—can have variable length. The relevant clues for relation learning can be spread across one or more words, which can appear in different positions and in different grammatical roles. Various methods have been developed to represent such information as a fixed-size data structure and to use it efficiently for relation classification. They assemble the representation of a text fragment, taking into account different types of information, *e.g.*, the word sequence, the grammatical information, direct dependency paths, or the entire dependency structure. One can also make assumptions about what the final representation will be (a vector, a matrix, or both), and so design an architecture which models an appropriate composition function. This section presents several ways of assembling the textual clues and the context of a relation instance. It focuses on compositionality not as a general concept and set of techniques but as specific techniques already tried in the context of relation extraction or classification. That is why it will not discuss configurations of recurrent and recursive neural networks, convolutional neural networks or transformers not yet applied in relation learning. In theory, at least, one can use any technique which builds a semantic representation for a text fragment of variable length to represent this kind of contextual information.

#### Averaged representation

The representation of a phrase as the average of the (distributional) representations of its words is a good approximation of the meaning of a phrase, despite the simplicity and the obvious disregard for word order [Mitchell and Lapata, 2010]. A phrase  $x$  of  $n$

words  $x = w_1, w_2, \dots, w_n$ , would be represented as

$$\mathbf{v}_x = \frac{\sum_{i=1}^n \mathbf{v}_{w_i}}{n} \quad (5.10)$$

where  $\mathbf{v}_{w_i}$  is the embedding of word  $w_i$ . It is trivial to get such a representation for word embeddings, which are real-valued vectors.

Part-of-speech (POS) information and the grammatical role which a word plays in a sentence can add knowledge useful for representing the meaning of a word in context. So, word embeddings can be combined with additional features, *e.g.*, syntactic roles or a word’s POS, to represent sentence substructures. Gormley et al. [2015] compute *substructure embeddings*  $h_{w_i} = f_{w_i} \otimes v_{w_i}$ , where  $f_{w_i}$  is a vector of hand-crafted features, and  $\otimes$  is the outer product. The *annotated phrase embedding* sums over the substructure embeddings:

$$\mathbf{v}_x = \sum_{i=1}^n h_{w_i} = \sum_{i=1}^n f_{w_i} \otimes \mathbf{v}_{w_i} \quad (5.11)$$

Such a model can integrate in the low-dimensional continuous representation of words either additional information from those words’ (local or global) context, or general information such as types or categories.

### Recurrent Neural Networks

Taking into account the word order, a phrase can be encoded as a sequence of words. The representation of a phrase can be derived by a recurrent neural network (RNN) which combines at each (time) step  $t$  the representation of words  $w_1, w_2, \dots, w_{t-1}$  with the current word  $w_t$  [Mikolov et al., 2010]. An RNN has an input layer connected to one or more hidden layers, and an output layer. The activation on the hidden layer at the last step is customarily taken as the sequence encoding. The output layer depends on the task (*e.g.*, at each step  $t$  it is a word in a target language, or the type or topic of the sentence in a classification task), and feedback trains or fine-tunes the input word representations and the weights of the hidden layers. The hidden state is updated at each step  $t$  with the representation  $\mathbf{v}_{w_t}$  of the current word  $w_t$ :

$$h_t = f(h_{t-1}, \mathbf{v}_{w_t}) \quad (5.12)$$

$f$  is a non-linear activation function, *e.g.*, an element-wise logistic sigmoid function, or an LSTM/GRU/ReLU unit.

A bi-directional RNN can also be used. At each time step  $t$ , the hidden layer combines two representations: one for the forward sequence (as for the regular RNN), the other for the backward sequence (the input phrase in reverse order, to allow the model to see the “future”, *i.e.*, the upcoming words).

A recurrent neural network helps ensure that word order is accounted for, and that a word sequence of arbitrary length can be encoded as a fixed-length vector which then serves as an input to a relation classifier, typically another neural network. In practice, RNN units such as LSTMs [Hochreiter and Schmidhuber, 1997] or GRUs [Cho et al., 2014] are used to address such matters as vanishing (or exploding) gradients during back-propagation.<sup>10</sup>

### Recursive Neural Networks

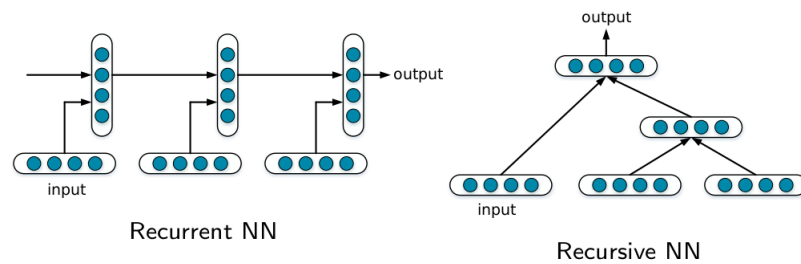

**Figure 5.8:** Recurrent and recursive neural networks [Socher et al., 2011b].

While RNNs model word order, word relations beyond linear order, *e.g.*, grammatical structure, might also be worth modelling. The next level of complexity are recursive neural networks, which can create a bottom-up representation for a tree-structured context by recursively combining representations of sibling nodes—see Figure 5.8.

Given a phrase  $x$  of  $n$  words,  $x = w_1, \dots, w_n$ , and a tree which represents its syntactic structure in some formalism, a recursive neural network assembles the representation of the phrase bottom-up:

$$\mathbf{a}_{i,j} = f(\mathbf{a}_i, \mathbf{a}_j) \quad (5.13)$$

$\mathbf{a}_{i,j}$  is the representation of the node  $a_{i,j}$  in the hierarchical structure of the phrase, with children  $a_i$  and  $a_j$ . A child can be an internal node in this structure, assembled from the representation on *its* children, or a leaf node. For the latter, the representation will be the embedding of the corresponding word:  $\mathbf{a}_i = \mathbf{v}_{w_i}$ . The function  $f$  can take different forms, just as it does for RNNs.

### Incorporating dependency paths

The methods noted before—the averaged representation and the composition via RNNs and recursive neural networks—have slowly incorporated more and more of the available

<sup>10</sup>[www.cs.toronto.edu/~rgrosse/courses/csc321\\_2017/readings/L15%20Exploding%20and%20Vanishing%20Gradients.pdf](http://www.cs.toronto.edu/~rgrosse/courses/csc321_2017/readings/L15%20Exploding%20and%20Vanishing%20Gradients.pdf)

contextual information, including grammatical structural information. The next step is to include information about the type of grammatical relations which connect the nodes in the tree or graph representation of the context of a relation instance.

Relational features in earlier work on semantic relations pick out evidence about two entities' interaction in a given context. One of the successfully applied types of relational features is the dependency path which connects the potential relation arguments.

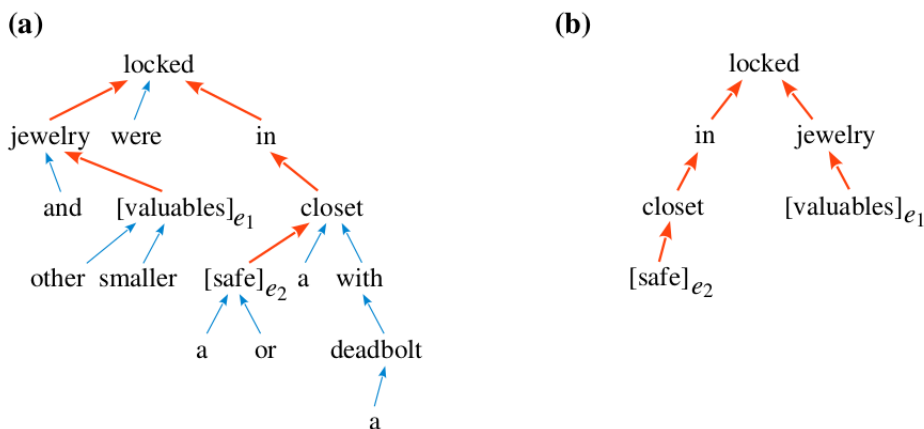

**Figure 5.9:** The dependency path (red) between entities  $e_1$  and  $e_2$  in the sentence “Jewelry and other small [valuables] $_{e_1}$  were locked in a [safe] $_{e_2}$  or a closet with a deadbolt.” [Xu et al., 2016].

When it comes to the dependency structure, several levels of information can describe the connection between two words in a sentence. The first level is the dependency path, a linear chain or a tree with two linear branches. The nodes on this basic path can have more dependencies, which lie outside the path of interest but may add information relevant to their meaning or role in the path. Such “side” dependencies makes it an *augmented dependency path* [Liu et al., 2015], with a more complex tree structure which can be encoded with string/tree/graph kernels. In deep learning, it can also be encoded with various types of neural networks which gradually assemble the context into a fixed-size input, and in effect implement a compositionality function.

The dependency path can be viewed as two branches which join the relation arguments with a common ancestor [Xu et al., 2016]. Either branch can be encoded separately, and with various types of information: words, parts of speech, grammatical relations, WordNet hypernyms, and so on. The dependency relations depicted in Figure 5.9 are encoded by means of deep RNNs, as shown in Figure 5.10. Relation prediction

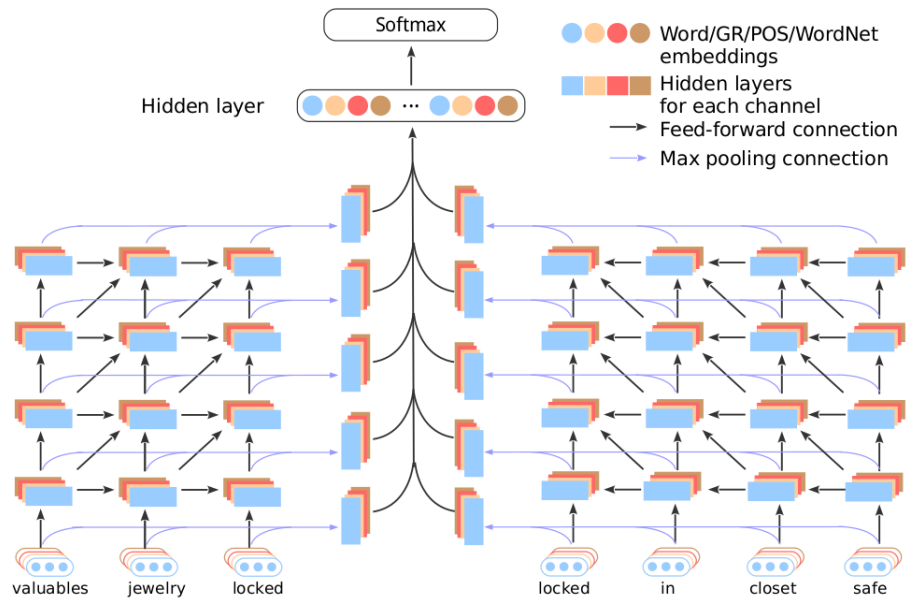

**Figure 5.10:** The two parts of the dependency path—separated by the common ancestor—are encoded by RNNs over four information channels: words, part-of-speech tags, grammatical relations, and WordNet hypernyms [Xu et al., 2016]. Relation prediction is based on a final hidden layer, in which these representations are combined.

is based on a vector representation which combines the outputs of the encoding of this multi-layered information of the dependency paths.

Each word in a dependency path may have additional relations which clarify its semantics and its role in the phrase. Some of this information may help recognize the semantic relation between the target arguments. Can et al. [2019] use the richer-but-smarter shortest dependency path—augmented with dependent nodes selected by various attention mechanisms with kernel filters. This smartly augmented path is then processed by a CNN.

### Compositionality models

The methods just discussed approach compositionality gradually, by combining semantic representations of words. This ranges from simple averaging to the use of grammatical structure in assembling the meaning of a phrase. Grammatical relations, while also used, are not modelled explicitly. This next step models the grammatical relations themselves, either as part of word semantics or separately.

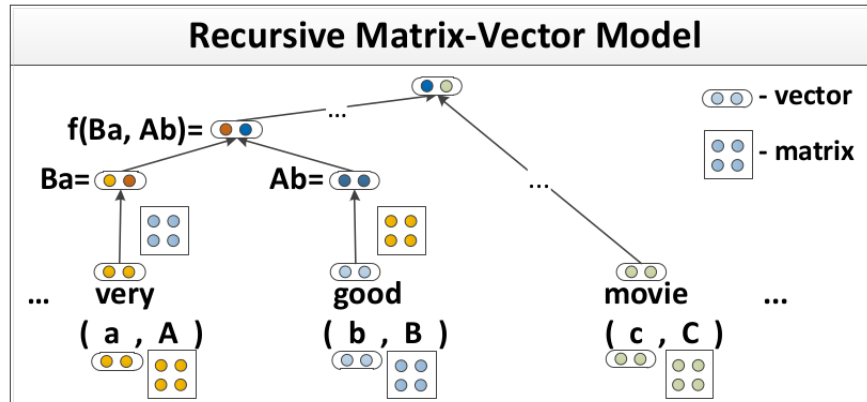

**Figure 5.11:** A recursive neural network which learns semantic vector representations of phrases in a tree structure. Each word and each phrase is represented by a vector and a matrix, e.g., *very* =  $(a, A)$ . The construction of the representation of a phrase, e.g., *very good*, is based on the representations of its words [Socher et al., 2012].

A word’s embedding is induced from the contexts in which it appears. This represents a variety of aspects related to the word’s form and meaning, as properties of its position in the embedding space relative to the position of its morphologically inflected forms, or other words [Mikolov et al., 2013c, Levy and Goldberg, 2014b, Finley et al., 2017, Ethayarajh et al., 2019]. It may be desirable to build word representations which address specific aspects relevant to assembling the representation of a phrase. In particular, they can have separate components to model the meaning of a word and its “composition function”, essentially an operator which encodes how the word modifies the meaning of another word it combines with. The meaning vector and the composition function of a phrase can be recursively assembled from their constituents in *recursive matrix-vector spaces* [Socher et al., 2012]. The word’s meaning is modelled as a vector, and its composition function as a matrix, as shown in Figure 5.11.

These representations are induced during training. Words whose semantic component is stronger (e.g., content words such as nouns or verbs) will have a more informative semantic component. Words with a more structural role (e.g., function words such as prepositions or conjunctions) will have a more informative compositional component. Both components would probably be equally strong for any content-altering modifier (such as *fake*) or for a verb which functions as a hub for the event it signals.

Dependency relations can also be encoded explicitly. This keeps the composition information outside a word’s representation, and allows different combinations to take syntactic information into account. Liu et al. [2015] encode augmented dependency



paths. They use vector encodings of dependency relations and dual representations for words: a word's semantics, and the subtree it dominates. The (shortest) dependency path between two entities is augmented with the subtrees dominated by each head word along the path. The network recursively assembles the representation of a phrase which connects two entities, using the augmented dependency path and the dependency relation representations. Figure 5.12 illustrates.

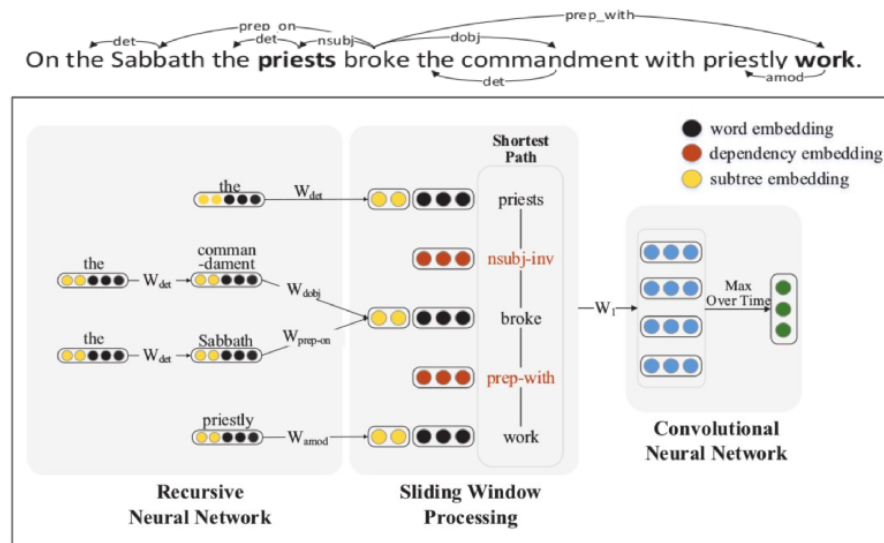

**Figure 5.12:** Recursive representation of a phrase based on the augmented dependency path and on the dependency relations [Liu et al., 2015].

### Transformer-based sentence embeddings

The methods we have reviewed thus far assemble the representation of a text fragment gradually from pre-trained or learned word representations. The representation of a word is fixed, regardless of the context in which the word appears. Transformer-based methods tackle the problem differently: a text fragment (often a sentence) is directly encoded, and a word may have different representations for different contexts. An adaptation of transformers for relation learning poses the problem of providing information on the relation's arguments. Such information enables the system to learn the targeted relation, and to assemble the fixed-length relation representation from the various layers of information in the transformer.

Soares et al. [2019] change a transformer into such a relation encoder. They experiment with various ways of supplying information about the location of the arguments

in the input text, and with different learning set-ups. The first set-up was relation classification from manually annotated data. The results were the best when entity markers (special tokens  $[E1_{start}]$ ,  $[E1_{end}]$ ,  $[E2_{start}]$ ,  $[E2_{end}]$ ) signaled the start and end positions of the two relation arguments in the text fragment, and when the concatenation of the final hidden states corresponding to  $[E1_{start}]$  and  $[E2_{start}]$  was taken as a relation instance representation. This mirrors the use of the output state which corresponds to the special [CLS] token as the sentence representation [Devlin et al., 2018, 2019].<sup>11</sup>

In the second set-up, distant supervision, Soares et al. take the transformer configuration developed for the classification task, and aim to produce and then compare the relation representations for pairs of entities in context. The loss function in this case is adjusted to lead to similar representations for relations which link the same pairs of entities. To encourage the system to incorporate contextual information and avoid excessive reliance on the entities in a pair, a special [BLANK] token replaces one or both of them in the automatically annotated corpus. For each positive instance, Soares et al. sample negative examples which do not contain the same entity pair, and use contrastive estimation to learn to rank positive instances higher than those presumed negative.

#### 5.4.2 Graph Neural Networks for encoding syntactic graphs

The foregoing was a survey of the mapping of a phrase relevant to relation classification onto a fixed-sized representation, which can be used as input to a neural network for relation classification. The success of such mappings depends on the method of composing the meaning of the larger phrase from its atomic components and from structural information. The encoding of a phrase can also be based on its constituency or dependency graph structure. Previous neural architectures which expect a sequence as input require preprocessing to linearize the graph. This is troublesome: a graph does not have one natural order, unless it is a linear chain. The output of a model which encodes a graph should not depend on the input order of the nodes. Since the patterns possibly relevant to relation learning may in fact be structural patterns in the graph, it is advantageous to encode the graph structure rather than one of its linear projections.

The recursive neural networks discussed in the preceding section do encode a non-linear structure: the directed acyclic graph (DAG). They still require preprocessing of the input to decide how this information is to be presented to the neural network. They also can only process certain types of graph structures.

Scarselli et al. [2009] introduced a connectionist model, *graph neural networks*, which subsumes recursive neural networks. A GNN models the structure of a graph via functions which aggregate a node's local or even wider neighbourhood, and it iteratively updates an initial graph representation. To learn the representation of the graph, the GNN minimizes a loss function which captures the difference between the task-dependent

<sup>11</sup>The first token of every sequence in BERT is a special classification token [CLS].

predicted output and the gold standard. Scarselli et al.'s GNN model works on homogeneous undirected graphs. Further work has produced models for directed, heterogeneous, dynamic and other types of graphs; there is an overview in [Zhou et al., 2018].

Our discussion here focuses on a few models which have been applied to encoding the structured textual context for relation instances, in particular on dependency graphs. (Section 5.6.1, in the segment of the book devoted to relation learning, will look at the encoding of large knowledge graphs using GNNs.) From the point of view of structured textual context, of particular interest are the aggregation functions which encode a node's neighbourhood, and the update steps. The aggregation functions, apart from capturing the neighbourhood structure of the nodes, can incorporate additional information, such as attributes of the nodes and of the edges, *e.g.*, bags of words, geolocation, timestamps, images.

The dependency path between the arguments of a relation can be regarded as a tree rooted in a common ancestor. From the standpoint of deep learning, such a structure can be encoded as a bidirectional (top-down and bottom-up) tree-structured LSTM-RNN [Miwa and Bansal, 2016]. The bidirectional model ensures that the information from the root of the path and from the leaves is propagated to each node. Weight matrices for same-type children are shared, and they allow for a variable number of children. This model can encode either the full dependency tree, or the shortest path between the relation arguments and the sub-tree, *i.e.*, the tree below the lowest common ancestor of the target nodes.

As noted earlier, the augmented dependency path includes dependency information on the words on the path. Too much of such information can distract from the relevant portions. One way to control the path is to prune the augmented dependency path: the syntactic tree is pruned below the lowest common ancestor by removing tokens further than  $k$  steps away from the dependency path between the target words. This ensures that negation and relevant modifiers are kept, while the size of the tree is reduced [Zhang et al., 2018].

Graph neural networks can also help tackle cross-sentence relations. Links beyond the sentence level can be established by sequential or discourse relations. Figure 5.13 shows a document representation which incorporates intra- and inter-sentential dependencies, such as sequential, syntactic and discourse relations.

This structure can be encoded with graph LSTMs by partitioning the document graph into two directed acyclic graphs (DAGs). One DAG contains the left-to-right linear chain and other forward-pointing dependencies. The other DAG covers the right-to-left linear chain and the backward-pointing dependencies. The effect is a mapping of the graph structure into a BiLSTM formalism [Peng et al., 2017]. This representation is used to learn a contextual representation for each word. Such representations give the

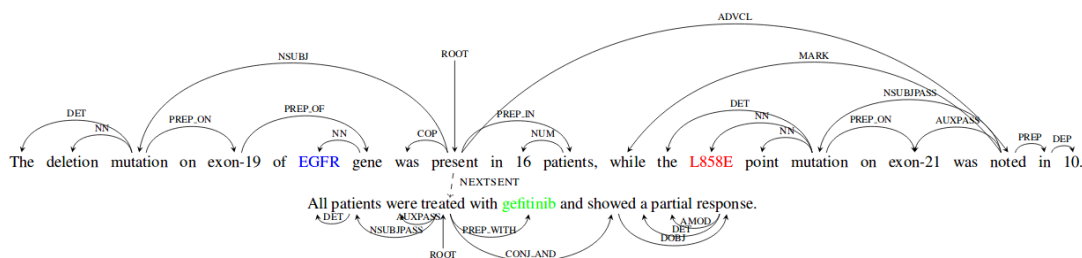

**Figure 5.13:** Example of a document relation graph, obtained using sequential and syntactic relations; discourse relations are omitted for clarity [Peng et al., 2017].

input to a relation classifier either by simple concatenation, if the arguments are single words, or by first building an averaged representation for multi-word terms.

## 5.5 Data

Neural networks are powerful but they require copious training data because they must learn many parameters. Some datasets constructed earlier have been used in deep learning, although mostly as test data because of their small size. Section 5.5.1 reviews additional datasets created and applied in this framework. Just as in traditional learning, distant supervision methods have been developed, taking advantage of particular characteristics of deep learning to deal with automatically annotated noisy data. Section 5.5.3 describes a few of the deep-learning methods of coping with noisy data, such as adversarial networks and reinforcement learning.

### 5.5.1 Datasets

Wikipedia infoboxes were one of the sources of clean relation instances needed in relation extraction. This was the starting point of Freebase, a collaboratively built database, currently available from Wikidata.<sup>12</sup> Various subsets of these data have been in use, frequently for link prediction methods, *e.g.*, [Socher et al., 2011a, Trouillon et al., 2017, Gardner and Mitchell, 2015], or for distant supervision based on knowledge graphs. Other knowledge graphs, taken from such resources such as NELL and WordNet, have also played a role in link prediction and as sources for distant supervision. Table 5.1 shows the statistics of some of the datasets most commonly used in relation learning.

Sun et al. [2013] discuss the Google Relation Extraction (RE) corpus.<sup>13</sup> It consists of instances of five binary relations: *perGraduatedFromInstitution*, *perHasDegree*, *perPlaceOfBirth*, *perPlaceOfDeath*, and *NA* (none of the above). The corresponding sentences come from

<sup>12</sup>[www.wikidata.org/](http://www.wikidata.org/)

<sup>13</sup>[code.google.com/p/relation-extraction-corpus/](http://code.google.com/p/relation-extraction-corpus/)

**Table 5.1:** Knowledge graph datasets used for link prediction or as sources for distant supervision. (The question marks signal the absence of published statistics. 79.5% of TACRED instances are “no relation”.)

Data set	# entities	# relation instances	# relation types
FB	20M	67M	4,215
FB15K	14,951	600k	1,345
FB [Mintz et al., 2009]	940k	1.8M	102
FB [Riedel et al., 2010]	?	743k	53
NELL	1.2M	3.4M	520
WN18	40,943	150k	18
Google RE	?	54k	5
GDS	?	18,824	5
FewRel	?	70,000	100
FewRel 2.0	?	72,500	125
TACRED	?	106,264	42
DocRED	132,375	63,427	96
DocRED (DS)	2,558,350	1,508,320	96

Wikipedia. Annotation was manual but the instances do contain noise, also in the test partition. Jat et al. [2018] introduced a variation of this dataset, the Google Distant Supervision dataset. It starts with the Google RE relation triples, and adds sentences which contain the relation’s arguments in the triple, found by searching the Web.

Zhang et al. [2017] present TACRED.<sup>14</sup> This dataset consists of sentences extracted from data created for the TAC Knowledge Base Population tasks. Sentences containing one of 100 target entities were extracted. The annotators were asked to mark subject and object entity spans, and the relation between them. The dataset, split into training, development and test subsets, contains both positive and negative instances.

Yao et al.’s [2019] dataset, DocRED,<sup>15</sup> represents both intra-sentence and cross-sentence relations. There are instances of 96 relation types from Wikidata. The dataset has several types of annotations apart from relations: mentions, coreference links, and text fragments marked as supporting evidence for the annotated relations.

Several datasets are available for n-ary relations. There are Wiki-90k and WF-20k,<sup>16</sup> built from binary relation instances in Wikidata and Freebase. Akimoto et al. [2019] defined ternary relations by combining binary relations. Instances of these relations were mapped onto paragraphs consisting of at most three sentences from the English

<sup>14</sup>[nlp.stanford.edu/projects/tacred/](http://nlp.stanford.edu/projects/tacred/)

<sup>15</sup>[github.com/thunlp/DocRED](https://github.com/thunlp/DocRED)

<sup>16</sup>[github.com/aurtg/n-ary-dataset](https://github.com/aurtg/n-ary-dataset)

Wikipedia, processed with Stanford CoreNLP for dependency parsing and coreference resolution, and with DBpedia Spotlight for entity detection.

*Few-shot learning* is a new direction of research in relation extraction/classification: learning from a small number of examples. Han et al.’s [2018] dataset FewRel serves this specific purpose.<sup>17</sup> It consists of 70,000 instances, 700 instances for each of 100 relation types. The relations are derived from Wikidata and matched with Wikipedia articles, and then crowd-sourced for annotation. FewRel 2.0,<sup>18</sup> developed by Gao et al. [2019], adds a test set from the biomedical domain for exploring few-shot domain adaptation. It also provides a few-shot none-of-the-above detection setting.

A catalogue of annotated datasets for relation extraction—reference papers and links—appears in a very useful GitHub repository.<sup>19</sup>

### 5.5.2 The quality of data

The datasets we describe in Section 5.5.1 were all built manually. There arises a natural question: how good are relation annotations in those sets? A useful answer should give the reader an idea about the difficulty of the annotation task—and possibly an upper bound on the performance of an NLP system using annotated data—as well as about the quality of annotated datasets.

Small datasets contain material for a specific experiment or task, and often arise from in-house effort which employs NLP specialists or domain experts. Inter-annotator agreement measured by some form of the kappa coefficient [Artstein and Poesio, 2008] is rather regularly reported in the resulting research papers. The agreement reported for the construction process for the surveyed datasets is between 0.6 and 0.9, depending on the relation; it turns out that some relations are easier to annotate. It is a challenge to compute agreement, because, as Hendrickx et al. [2010] note, chance agreement, required in the calculation of kappa, may be difficult to estimate. Agreement on the final versions of small datasets may be moot: they often contain only adjudicated items, or items on which all annotators agree; this has been discussed, *e.g.*, by Girju et al. [2009] and Hendrickx et al.

Larger datasets are often the result of crowd-sourced annotation. Good annotations make for a good dataset. There are methods of measuring, and keeping track of, the quality of annotations. Some form of quality control is embedded in crowd-sourcing platforms such as Amazon Mechanical Turk or Figure Eight (formerly known as Crowd-Flower). They allow the task organizers to evaluate candidate workers before and during the main annotation task. After reading the annotation guidelines, workers are tested on a small set of annotated instances, and those who score low can be rejected. Annotated

<sup>17</sup>[zhuhaome.com/fewrel](http://zhuhaome.com/fewrel)

<sup>18</sup>[thunlp.github.io/fewrel.html](http://thunlp.github.io/fewrel.html)

<sup>19</sup>[github.com/davidsbatista/Annotated-Semantic-Relationships-Datasets](https://github.com/davidsbatista/Annotated-Semantic-Relationships-Datasets)

instances can also be sprinkled throughout the task to monitor workers' performance. Information thus gathered goes into the reliability scores which accompany an annotator's work. Annotation task organizers can also plan their own quality control, for example by duplicating instances to help quantify the consistency of each rater's annotation.

Annotations obtained on a large scale from the public at large are only part of the solution. To build a reliable dataset from individual annotations is itself a complex problem [Qing et al., 2014]. Despite best effort, subsequent analysis may still uncover errors and inconsistencies. Alt et al. [2020] analyze the quality of relation labels in the TACRED dataset, and corrected instance labels in the development and test splits. They also show that such corrections affect model evaluation significantly.

And then there are repositories of collective knowledge, very large indeed. Annotation information for those datasets does not exist as such: they were built as repositories of collective knowledge, and not specifically (and perhaps somewhat narrowly) for scientific study. NLP adopted such datasets enthusiastically, but once they became the object of scientific study, their quality had to be assessed. Färber et al. [2018] present an in-depth analysis of Freebase, DBpedia, Wikidata, OpenCyc and YAGO, and give many references to additional work concerned with evaluating the quality of knowledge repositories. Based on a sample of instances, these resources are judged in terms of accuracy, trustworthiness, consistency and other such measures. Färber et al. also propose a framework for selecting the most suitable knowledge graph for a given setting based on the computed measures.

People who judge linguistics phenomena can rarely be in complete agreement. Even so, while a dataset may never be perfect, someone has built it in order to give the community a *reliable* resource. In the end, then, one must live with imperfect annotations, and factor their flaws into any honest analysis of research results.

### 5.5.3 Distant supervision

Distant supervision is a popular method of acquiring additional (large amounts of) training data starting with (a small set of) annotated data from some related tasks. For relation extraction in particular, large amounts of automatically annotated data—in the form of sentences with source and relation targets marked—can be obtained using out-of-context (*source, relation, target*) relation triples in knowledge repositories. The sources and targets in these triples are mapped onto unstructured texts. The assumption is that all or most of the newly found sentences will carry the target relation. This naturally produces noisy data. Dealing with noise—or reducing it during the data generation process—is a thorny problem. There are several traditional methods of countering it. The switch to deep learning has led to new solutions of this problem; we survey them in this section.

### Structured learning

Evidence that a sentence contains an instance of a targeted relation can come from the sentence itself or from a larger corpus. One can filter out false positives by establishing similarity between the phrase which connects potential relation arguments in a corpus and the name of the relation in the knowledge base [Ru et al., 2018]. The evidence from the sentence and from the corpus can be further aggregated to induce latent variables helpful in predicting if a relation has an instance in the given sentence [Hoffmann et al., 2011]. Such latent variables which model relational information can be induced from a low-dimensional representation of a sentence produced by a convolutional neural network [Bai and Ritter, 2019].

An entity pair from a knowledge graph can be connected by relations of several types. Relation learning in such cases is therefore often treated as a multi-instance multi-label learning problem [Hoffmann et al., 2011, Surdeanu et al., 2012]. The labels themselves, *i.e.*, the relations, can also have semantic connections. For example, the Freebase relation */location/location/capital* connecting a capital city with its country is subsumed by */location/location/contains*. Information of this kind can be harnessed to learn the filtering of the automatically annotated sentences.

An efficient way of filtering automatically generated data is to filter sets—usually bags—of instances rather than individual instances. Automatically annotated sentences can be grouped in bags in various ways. For example, a bag may contain all sentences extracted for a given relation triple. Zeng et al. [2015] learn such a filter; their objective function applied at the bag level incorporates the uncertainty of the instance labels. The function assigns each bag a positive label (the bag has at least one positive instance) or a negative label (the bag has no positive instances). Su et al. [2018] build an encoder-decoder model for each bag to predict a sequence of relations—starting with the most specific one—instantiated in the bag. The encoder produces a semantic representation of the whole bag of instances; to do that, it considers a representation of the source and target entities, and a semantic representation of the sentences assembled using a CNN. The decoder is a neural model which learns dependencies between the semantic relations in the entire set from the representation of the bags. For each input bag representation, it produces a sequence of relation predictions, starting with the most specific relation which can be instantiated in the sentences in the bag.

Distant supervision can be seen as the filling of entries in the label section of an entity-pair  $\times$  sentence co-occurrence matrix—see Figure 5.14. The matrix combines gold-standard training instances and automatically labelled instances: rows represent entity pairs, columns represent (noisy) textual features from the corresponding sentences and (incomplete) relation labels.



To fill in the incomplete relation labels, the matrix is factorized into two low-rank matrices:  $\text{item} \times \text{feature}$  and  $\text{item} \times \text{label}$ . The assumption is that the noisy features and the incomplete labels are semantically correlated [Fan et al., 2014]. The resulting low-dimensional feature and label representations can help compute the relation labels for the test data.

A knowledge graph (KG)—the usual source in distant supervision—provides much more information than just individual relation triples. Wang et al. [2018] do not use the labels associated with automatically extracted sentences. Instead, they devise a relation-learning process which relies on the fact that multiple entity pairs from a knowledge graph communicate the same relations, and that some pairs may appear in only one kind of relation (*e.g.*, the relation between Toronto and Canada can be */location/location/contains* but not */location/location/capital*); there also is information about the type of entities connected by a given relation and an encoding of the KG relation. From the relation triples in the KG, the system induces entity and relation representations using the TransE model. The model approximates each relation type as a translation vector in a low-dimensional space:  $\text{source} + \text{relation} \approx \text{target}$  (this will be shown in Table 5.2 in Section 5.6.1). In the extracted sentences, source and target entities are replaced with their types as supplied by the KG. A neural network with attention learns sentence embeddings such that the embedding of a sentence is close to the target-source pair, so ultimately close to the representation of a relation. At test time, a sentence is assigned a relation label dictated by its embedding and its closest relation induced with TransE.

Vashishth et al. [2018] also take advantage of entity type information from Freebase and relation alias information—different relation names in  $(\text{subject}, \text{verb}, \text{object})$  triples extracted from texts—to impose soft constraints on relation prediction. A graph convolution network formalism is used to encode syntactic information from candidate sentences and to produce sentence embeddings. From these representations, the system induces representations of bags of instances, which are then combined with relation embeddings and entity type embeddings, and a softmax classifier predicts the relation.

#### Adversarial networks

Generative adversarial networks (GANs) have had much success in dealing with the lack of training data, because they automatically generate new data to match a small

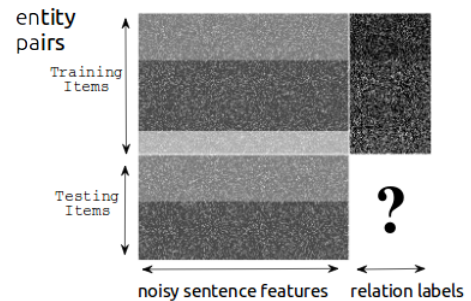

**Figure 5.14:** Entity-pair  $\times$  sentence matrix in distant supervision [Fan et al., 2014].

set of gold-standard annotated data. In this formalism, a generator is pitted against a discriminator. The generator tries to generate data according to an underlying (unknown) distribution, and the discriminator tries to distinguish automatically generated data from the (relatively little) gold standard data with the desired distribution. The generator works best when the discriminator fails; this shows that it can generate data from the desired distribution. While this idea is not new [Schmidhuber, 1999], and has been implemented for traditional learning paradigms [Dalvi et al., 2004, Zhou et al., 2012], it has proven particularly fruitful in deep learning [Goodfellow et al., 2014].

The training of a generator and a discriminator has been applied in filtering instances for the distance supervision of relation classification. Here, the generator need not actually generate new instances; it can just sample from the set of sentences automatically annotated for relations. The problem is to sample the true positives from the automatically generated noisy data. The discriminator is tested on a small amount of gold-standard annotated data. According to Goodfellow et al., the process “wins” when the discriminator cannot distinguish between its gold-standard true positives and the sentences selected from the automatically annotated data.

The sampling of true positives can be based on a computed probability that a given sentence contains an instance of the target relation [Qin et al., 2018a]; the sentences with the highest probability are passed on to the discriminator. Normally, a GAN’s discriminator would pitch the automatically selected instances against a gold-standard annotated set. Qin et al. forgo supervision. They assume a rough split of the automatically annotated data, based on the overlap with the source of distant supervision. A set  $P$  of “true positive” data comprises sentences with both arguments of an existing relation in Freebase. In the sets  $N^G$  and  $N^D$  (negative data for the generator and the discriminator, respectively), the entities in the sentence do not appear in a relation instance in Freebase.

Qin et al. use  $P$  and  $N^G$  to pretrain a generator model; the model is updated until a stopping criterion has been met, as in typical GANs. Unlike a typical GAN, the discriminator is also pretrained, and this configuration is restored at the beginning of each epoch. The generator assigns a probability score to every instance in  $P$ . The set of instances is split into  $T$  (instances with a high probability) and  $F = P \setminus T$ . The parameters of the discriminator are adjusted in such a way that  $T$  plays the role of negative data,  $F$  of the positive data. The loss function of the discriminator computes a signal which is only used to determine the reward function for adjusting the parameters of the generator. The performance of the discriminator is evaluated on  $N^D$ , the set of negative examples. The intuition seems to be as follows: if the discriminator learns to assign lower probability to instances of  $T$  (which it treats as negative), then it will become worse at distinguishing positive and negative instances, so it will perform poorly at scoring the negative data  $N^D$ .

Information in a sentence often ends up compressed into a single probability value. Such compression obscures the various facets of the sentence. There is an alternative: construct a vector representation of the sentence, perhaps using a convolutional neural network; next, use it to build and train the generator and the discriminator [Li et al., 2019a]. This procedure, illustrated in Figure 5.15, can be combined with additional methods of filtering the automatically annotated data. Li et al. produce a cleaner training set from entity descriptions collected from Wikipedia. As positives instances, they take the sentences with entity mentions which appear not only in a relation in the source of distant supervision, but in each other’s description. If they do not, the sentence is considered a negative instance.

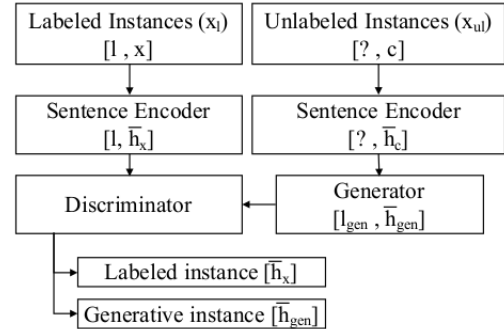

**Figure 5.15:** Li et al.’s [2019a] GAN architecture: the same encoder for gold-standard and automatically annotated sentences.

#### Neural networks with attention

Automatically generated true positive and false positive sentences may share features which can be exploited to filter the distantly supervised dataset. To find such features, the meaning of the sentences should be represented in a systematic manner, by a mechanism which reveals shared patterns.

Convolutional neural networks are good at finding patterns. The induced sentence representations can be used directly with a sentence-level attention model which reduces the weights of noisy (false positive) sentences [Lin et al., 2016]. They can also lead to aggregate representations of groups of sentences, in particular bags of sentences extracted for each relation  $r$  and  $(source, target)$  pair.

Ye and Ling [2019] apply a bag-level attention mechanism to relation-aware representations built for each bag as (attention-)weighted sums of sentence representations matched against each relation. Sentence representations are built by CNNs over word embeddings, taking into account positional information about the source and the target. This weighted sum of sentence representations is matched against every possible relation, not just the target relation: the same entity pair can have different relations in different contexts (e.g., Barack Obama was born in the United States and Barack Obama was the 44th President of the United States). Bags which share a relation label are assembled into a bag group. An attention mechanism helps weight sentences for the construction of the bag representation. The mechanism is expected to give smaller weight—pay less attention—to noisy sentences. A similar attention mechanism should give lower weight

to noisy bags in a bag group. The attention model is trained to weight more highly sentences more likely to express the desired relations.

Beltagy et al. [2019] combine adversarial training with attention; that improves the automatic selection of positive instances from automatically selected—therefore noisy—sentences which contain the target relations. Beltagy et al.’s work improves the model’s ability to assign lower weights to noisy sentences, those which do not contain the target relation.

Another trouble with distant supervision is that sentences contain more information than just the target relation, and such additional phrases may conceal the target relation. Filtering out some of the noise can make it easier for an attention model to find, and properly weight, relevant features. Liu et al. [2018] implement such a filter. In word-level distant supervision for relation extraction, where filtering is based on syntactic information, a robust entity-wise attention model will give more weight to semantic features of relational words in a sentence.

Attention models are usually implemented as weight vectors. This one-dimensional view may insufficiently account for complex interactions in textual contexts. Du et al. [2018] propose a multi-level multi-dimensional attention model in a multi-instance learning framework. A 2D attention matrix identifies aspects of the interaction of two entities in a sentential context, while another 2D attention matrix picks up relevant sentence-level features.

The attention mechanism relies on the neural model for the encoding of relevant and noteworthy features. With respect to relation extraction, some such features should capture semantic aspects of the entities involved. The sentential context may not contain enough information for this, so one could give the model additional information in the form of entity descriptions. Ji et al. [2017] extract entity descriptions from Freebase and Wikipedia pages, and give those to a model which includes sentence-level attention.

### Reinforcement learning

The decision which instance is useful—is a true positive—can be treated as a game. In a game, generally speaking, an agent starts in an initial state, chooses a series of actions which lead to a final state, and is rewarded or penalized depending on whether the final state is good or bad. This reward/penalty controls the adjustment of the agent’s model, which dictates what actions to take in a given state.

In relation extraction, the purpose of the game is to find true positive sentences among those automatically extracted and annotated. At each step, the agent chooses an instance from this automatically generated set. When it reaches the final state, the set of instances gathered is considered to be a training set of properly labelled instances. A model is built from this training set, and evaluated on a small set of gold-standard data. A good training set yields a good model for learning to predict relations, and a

noisy training set leads to poor performance on the task. The result of this evaluation determines the agent’s reward or penalty; based on that, the agent adjusts its method of choosing instances and assigning each of them a positive or negative label.

Formally, *state*  $s_t$  corresponds to the training data selected until time  $t$ , the target relation  $r_i$ , and the relation arguments—*source* and *target*—in the currently considered instance. Three *actions* are possible: accept it as true positive and include it in the training data; include it as a negative instance; or reject it. The *reward* is computed after the instances in the automatically generated dataset (or in a bag corresponding to a given *source-target* pair) have been processed, and the final relation classification model built and evaluated.

Feng et al. [2018] and Qin et al. [2018b] apply this form of reinforcement learning in the selection of training data for relation learning. When the agent decides on the action, it relies on a relation classification model, implemented as a convolutional neural network. The reward/penalty feedback guides the adjustment of the parameters of this CNN. Figure 5.16 illustrates.

The process can be improved if the focus is not only on false positives but on false negatives. (A false positive is an automatically generated sentence which does not actually have one of the target relations, despite containing both arguments of a relation. A false negative is a sentence discarded because it did not contain an exact expression of the arguments of a relation.) Yang et al. [2019] focus on identifying both false positives and false negatives. They treat this as a reinforcement problem, in which an agent should decide if an instance is mislabelled. The task is split between two agents: one of them detects false positives, the other false negatives.

The adjustment of action selection as a result of feedback is a critical step in reinforcement learning. Earlier work relied on a relation classifier to take an action, and the reward/penalty indicated how to adjust the parameters of the model. The action can also be the result of more complex processing. Liu et al. [2019b] developed a reinforcement learning process in which a GAN-like method performs a *policy* improvement step. A policy is a probability distribution which maps states to actions. The improvement of a policy was modelled as a form of imitation learning.<sup>20</sup> It takes the current policy

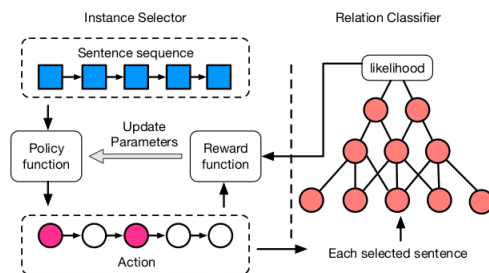

**Figure 5.16:** Example of a reinforcement-learning architecture in which a relation classifier selects instances [Feng et al., 2018].

<sup>20</sup>Imitation learning aims to mimic human behavior in a given task. An agent is trained to perform the task from demonstrations by learning a mapping between observations and actions.

as the prior knowledge, and generates improved policies. The reward is implicit in the policy improvement operator. In the policy evaluation step, the current policy network is rated by a measure of the difference between the probability distribution under the current policy and under the improved policy.

## 5.6 Learning semantic relations

There are many ways of representing the semantics of words/entities, relational clues from the context, and even the relations themselves. Various architectures can combine this information, and in fact it is often derived jointly. This section presents several ways in which such representations can be integrated in a deep-learning method. The methods are grouped by the sources and information support for the relation learned: learning relations in knowledge graphs (Section 5.6.1), learning relations from texts (Section 5.6.2), learning relations from texts and knowledge graphs (Section 5.6.3), n-ary and cross-sentence relations (Section 5.6.4), unsupervised relation extraction (Section 5.6.5), and finally lifelong learning (Section 5.6.6).

### 5.6.1 Learning relations in knowledge graphs

A knowledge graph  $KG = (\mathcal{V}, \mathcal{E}, \mathcal{R})$  contains knowledge in the form of relation triples  $(s, r, t) \in \mathcal{E}$ , where the vertices  $s, t \in \mathcal{V}$  are entities and  $r \in \mathcal{R}$  is a relation type. Knowledge graphs are not complete. Additional links (facts) can be inferred because similar nodes participate in similar relations, *e.g.*, every country has a capital city. This is, in effect, *link prediction*. To do this, a KG may be encoded by a learning model which approximates its connectivity information; or one can apply a graph neural network to encode its structure via node neighbourhoods.

#### Encoding graph connectivity information

Graph embedding methods rely on the idea that the graph's connectivity structure informs the representations of entities and relations. The representation of an entity takes into account the relations it is part of; the representation of a relation takes into account the entities it connects. A few essential design decisions must be made: the type of structure to represent entities and relations (*e.g.*, vectors or matrices); the scoring function to calculate a score for a pair of entities and a relation type based on these representations (the score should be 1 if the edge in question exists); and the loss function to compare the automatic predictions with the gold standard. Nickel et al. [2016a] present a survey of statistical relational learning methods for knowledge graphs, including graph embeddings, path-based algorithms and Markov logic networks. Wang et al. [2017] and Ji et al. [2020] focus on knowledge graph embedding methods, and

present a comprehensive overview. This section summarizes some of those methods; the surveys offer the reader a deeper look.

Knowledge graphs contain only positive instances, *i.e.*, relation instances known to exist. The link prediction task precludes the closed-world assumption, otherwise, every missing link would be a legitimate *not\_related* relation. To produce non-trivial models, “negative” edges are needed. There is variety of methods which sample a number of missing edges for each positive instance [Kotnis and Nastase, 2018]. A scoring function applied to such apparently negative instances should return a score close to 0. Alternatively, since these instances are only presumed to be negative, the scoring and the loss functions can implement *contrastive estimation* [Gutmann and Hyvarinen, 2012]: the score for a positive instance should be higher than the score for all the negative instances sampled for it.

Graph embedding methods learn representations  $\mathbf{v}_x$  for entity  $x$  and  $\mathbf{r}$  for relation  $r$ . The fact that relation  $r$  holds between the source and target nodes  $s$  and  $t$  is modelled by a scoring function  $f$  (discussed briefly in Section 5.3.2). The entity embeddings  $\mathbf{v}_x$  are usually  $d$ -dimensional vectors, where  $d$  is a parameter. The representation of the relation has taken various forms, *e.g.*, a  $d$ -dimensional vector (Trans\* [Bordes et al., 2013, Wang et al., 2014, Lin et al., 2015]), a diagonal matrix (DistMult [Yang et al., 2015]), or a  $d \times d$  matrix (RESKAL and its variations [Nickel et al., 2011]).

The entity and the relation embeddings can be considered to belong to different embedding spaces, and projections can map entity embeddings onto the relation space [Lin et al., 2015, Ji et al., 2015, 2016]. Entities and relations are most commonly modelled as deterministic points or vectors in continuous vector spaces. In contrast, He et al. [2015] and Xiao et al. [2016] propose models which represent both entities and relations as vectors drawn from Gaussian distributions. Such representations allow variations in the meaning of a semantic relation for different (*source*, *target*) pairs, and for sources and targets in different contexts.

Table 5.2 shows examples of graph embedding models. The column *Entity emb.* contains the implementation choice for the entity embeddings: a real- or complex-valued  $d$ -dimensional vector, or a  $d$ -dimensional vector drawn from a normal distribution.<sup>21</sup> The column *Relation emb.* lists the chosen representation structure for the relation: a real- or complex-valued  $d$ -dimensional vector, a real-valued  $d \times d$ -matrix, or a  $d$ -dimensional real-valued vector drawn from a normal distribution. The *Scoring function* column presents the calculation of the score for a relation triple, given the representation choices.

Methods such as RESKAL [Nickel et al., 2011] and Neural Tensor Networks [Socher et al., 2013] learn millions of parameters. That makes them more flexible—they can model a variety of relations well—but there are costs: increased computational complexity and a chance of overfitting. Methods such as TransE [Bordes et al., 2013] and

<sup>21</sup> $\mathcal{N}(\mu, \sigma^2 I)$  represents the normal distribution with mean  $\mu$  and covariance matrix  $\sigma^2 I$ .

**Table 5.2:** A small sample of graph embedding methods. There is a comprehensive overview in [Wang et al., 2017] and [Ji et al., 2020]. References for the methods: TransE [Bordes et al., 2013], DistMult [Yang et al., 2015], RESCAL [Nickel et al., 2011], ComplEx [Trouillon et al., 2017], TransG [Xiao et al., 2016], ConvE [Dettmers et al., 2018], MuRP [Balazevic et al., 2019].

Method	Entity emb.	Relation emb.	Scoring function
TransE	$\mathbf{v}_s, \mathbf{v}_t \in \mathbb{R}^d$	$\mathbf{r} \in \mathbb{R}^d$	$\ \mathbf{v}_s + \mathbf{r} - \mathbf{v}_t\ $
DistMult	$\mathbf{v}_s, \mathbf{v}_t \in \mathbb{R}^d$	$\mathbf{r} \in \mathbb{R}^d$	$\mathbf{v}_s^\top \text{diag}(\mathbf{r}) \mathbf{v}_t$
RESICAL	$\mathbf{v}_s, \mathbf{v}_t \in \mathbb{R}^d$	$\mathbf{M}_r \in \mathbb{R}^{d \times d}$	$\mathbf{v}_s^\top \mathbf{M}_r \mathbf{v}_t$
ComplEx	$\mathbf{v}_s, \mathbf{v}_t \in \mathbb{C}^d$	$\mathbf{r} \in \mathbb{C}^d$	$\text{Re}(\mathbf{v}_s^\top \text{diag}(\mathbf{r}) \bar{\mathbf{v}}_t)$
TransG	$\mathbf{v}_s \sim \mathcal{N}(\mu_s, \sigma_s^2 I)$ $\mathbf{v}_t \sim \mathcal{N}(\mu_t, \sigma_t^2 I)$ $\mu_s, \mu_t \in \mathbb{R}^d$ $\Sigma_s, \Sigma_t \in \mathbb{R}^{d \times d}$	$\mu_r^i \sim \mathcal{N}(\mu_t - \mu_s, (\sigma_s^2 + \sigma_t^2) I)$ $\mathbf{r} = \sum_i \pi_r^i \mu_r^i \in \mathbb{R}^d$ $(\pi_r^i \text{ are weights})$	$\sum_i \pi_r^i \exp\left(-\frac{\ \mu_s + \mu_r^i - \mu_t\ _2^2}{\sigma_s^2 + \sigma_t^2}\right)$
ConvE	$\mathbf{v}_s \in \mathbb{R}^{d_h \times d_w}$ $(d_h d_w = d)$ $\mathbf{v}_t \in \mathbb{R}^d$	$\mathbf{r} \in \mathbb{R}^{d_h \times d_w}$	$f(\text{vec}(f([\mathbf{v}_s; \mathbf{r}] * \omega))W) \mathbf{v}_t$ $(* \text{ is the convolution operator,}$ $\omega \text{ is a CNN filter,}$ $W \text{ is a weight matrix})$
MuRP	$\mathbf{h}_s, \mathbf{h}_t \in \mathbb{B}_c^d$ $\mathbb{B}_c^d = \{x \in \mathbb{R}^d : c \ x\ ^2 < 1\}$	$\mathbf{r} \in \mathbb{B}_c^d$ $\mathbf{R} \in \mathbb{R}^{d \times d}$	$-d_{\mathbb{B}}(\mathbf{h}_s^{(r)}, \mathbf{h}_t^{(r)})^2 + b_s + b_t$

DistMult [Yang et al., 2015] learn simpler models, with far fewer parameters, and are easier to train, but they cannot model certain types of relations, such as many-to-many relations (TransE) and asymmetric relations (DistMult). Nickel et al. [2016b]’s holographic embeddings (HolE) achieve the modelling power of RESCAL with fewer parameters by compressing the tensor product. Complex-valued embeddings (ComplEx) [Trouillon et al., 2017] extend DistMult to model antisymmetric relations.

Nickel and Kiela [2017] first proposed embedding (part of) WordNet’s *is-a* hierarchy in a Poincaré space; their hyperbolic embeddings (of very low dimension:  $d = 5$ ) predicted unseen *is-a* instances. Balazevic et al.’s [2019] model embeds and predicts links in a multi-relational knowledge graph. Their MuRP model, illustrated in Table 5.2, represents entities as points in a Poincaré ball. A scoring function determines if two entities are in a relation  $r$ . The function relies on relation-specific parameters  $\mathbf{r}$  (a hyperbolic translation vector) and  $\mathbf{R}$  (a diagonal relation matrix). The parameters transform the source and target hyperbolic embeddings  $\mathbf{h}_s$  and  $\mathbf{h}_t$  into  $\mathbf{h}_s^{(r)}, \mathbf{h}_t^{(r)}$ . Two biases,  $b_s$  and  $b_t$  (which are among the model’s parameters) define a “sphere of influence” around each of the



transformed vectors. If  $r$  connects the source and target entities, then their spheres of influence should overlap.

A graph-structure encoding approximates, in effect, the adjacency matrix of a graph. The matrix captures the view of a graph as a collection of triples. A graph can also be represented as a collection of paths. Paths in graphs can result from graph traversal (breadth-first, depth-first, and so on) or random walks.

Paths can assist relation learning in various ways. When regarded as a sequences of nodes and relations, a path can serve as a “sentence” for the purpose of deriving node and relation representations. Paths are the input, in lieu of a regular corpus, to word2vec [Mikolov et al., 2013a], and representations of the nodes and relations are produced just as one would do it for words in a sentence [Perozzi et al., 2014].

A path can be treated as a description of the source and target nodes (it contains information about their neighbourhoods) or the relation between them (it shows alternative chains of links from the source to the target). Paths, then, can contribute directly as features to the prediction of new links in a knowledge graph. Lao et al. [2011] show how to obtain and apply bounded-length path types, or meta-paths (sequences of relations): they generalize alternative paths found between the source and the target in the graph connected by the same relation  $r$ . The meta-paths work as features in predicting if relation  $r$  holds between node pairs previously not connected by  $r$ .

Gardner and Mitchell [2015] use paths to describe the source and target nodes, and the relation between them. They extract features from the local subgraphs around each node in a potential pair. The local information around node  $n$  is the set of (*path type*, *end node*) pairs collected by random walks which originate in  $n$ . The representation for a (*source*, *target*) pair combines the two nodes’ subgraphs by merging the paths based on shared end nodes on those paths. This representation is used to learn a corresponding relation for the entity pair.

Guu et al. [2015] show that most latent factor models, notably matrix factorization models, can be modified to learn from paths rather than from individual triples. Recurrent neural networks which learn path representations have also been used for link prediction [Neelakantan et al., 2015, Das et al., 2016].

Relations can also share information. For example, the relation *currency\_of\_film\_budget* can be viewed as a composition of the relations *currency\_of\_country* and *country\_of\_film*. This kind of information may promote better relation representations. Takahashi et al. [2018] use an autoencoder which further processes the relation matrices obtained by matrix factorization with the RESCAL model. The autoencoder compresses the relation matrix into a smaller vector representation, from which the matrix is regenerated. This encoding-decoding process encourages the induction of relation matrices which incorporate similarities and dependencies between the relations.

The previously described graph embeddings took into account the structure of the graph, and encoded entities and relations in various types of structures. The entity and relation representations determine the scoring function used to approximate the graph structure and then to predict new edges.

Information in a knowledge graph can be encoded in other ways, for example when relation triples are taken into account as separate instances. The focus in such a case would be on modelling the interaction between arguments and relations to boost latent patterns, such as shared or interacting dimensions. Dettmers et al. [2018] use a multi-layer CNN, whose input is a 2D encoding of the source entity and relation in a  $(source, relation, target)$  triple. The filters applied to this source-relation “image” are common to all instances in the training data, and so to all relation types. The application of the filters over the 2D representation produces feature maps; a fully connected layer projects the maps onto a hidden layer which represents an entity embedding. The predicted embedding vector is multiplied with the entity matrix and then transformed by a sigmoid function; that, in effect, produces a similarity score between the predicted embedding and the embeddings of the entities in the graph. Dettmers et al.’s method makes it possible to perform a 1-to-N mapping, simultaneously testing all possible targets of a source-relation combination.

Jiang et al. [2019] take Dettmers et al.’s method further. They start from the premise that concatenating the 2D representations of the subject and the relation does not allow for enough interaction between the dimensions of the subject and relation. Jiang et al.’s system takes as input only a 2D representation of the source entity, and the representation of the relation is transformed into a set of filters. This enables a more diverse and comprehensive interaction between the representation of the subject and the relation. In contrast with Dettmers et al.’s work, each relation type has its own filters.

### Graph Neural Networks

The graph encoding methods which we discussed in connection with link prediction do not take full advantage of the graph structure. For example, a node’s neighbourhood should provide useful information. Graph neural networks (GNNs) were designed to acquire such information down to any depth. GNNs, proposed first by Scarselli et al. [2009], aggregate this information into a fixed-sized representation. The aggregation function—message passing—must be invariant in the neighbourhood shape or size. Zhou et al. [2018] present a comprehensive view of GNNs; it is summarized here from the point of view of their connection to semantic relation learning.

GNNs were inspired by convolutional neural networks, which can find patterns at different levels and then compose them into expressive representations. There are three key aspects of CNNs which allow them to produce such representation: local information (in graphs, it is node neighbourhood); shared weights (this reduces the computing cost);

and multi-layer structures which deal with hierarchical patterns and so capture features of various sizes (this maps naturally into the hierarchical structure of graphs). It is an important characteristic of a GNN that its output is invariant in the input order of nodes. The relation information, which represents the dependency between two nodes, can be explicitly integrated into the model, including the relation’s potential attributes.

A node is defined by its features, the related nodes, and the type of relations which connect it with its neighbours. Learning a GNN implies learning a hidden state  $\mathbf{h}_v \in \mathbb{R}^d$  which encodes the neighbourhood information for node  $v$ . This vector can be used to produce an output  $\mathbf{o}_v$  which corresponds, for example, to  $v$ ’s label. The basis for inducing such representations is a *local transition function*  $f$  which combines the features of the node ( $\mathbf{x}_v$ ), the features of its edges ( $\mathbf{x}_{co[v]}$ ), the states of the nodes in its neighbourhood ( $\mathbf{h}_{ne[v]}$ ), and the features of the nodes in its neighbourhood ( $\mathbf{x}_{ne[v]}$ ). Formally, the hidden state is defined as

$$\mathbf{h}_v = f(\mathbf{x}_v, \mathbf{x}_{co[v]}, \mathbf{h}_{ne[v]}, \mathbf{x}_{ne[v]}) \quad (5.14)$$

The output depends on  $v$ ’s hidden state and feature vector. It is defined as

$$\mathbf{o}_v = g(\mathbf{h}_v, \mathbf{x}_v) \quad (5.15)$$

where  $g$  is a local output function. To learn  $g$ ’s and  $f$ ’s internal parameters, GNNs need a loss function. It compares the predicted output  $\mathbf{o}_v$  for a node with the gold-standard  $\mathbf{t}_v$  from a given training set  $\mathcal{V}$ :

$$loss = \sum_{v \in \mathcal{V}} (\mathbf{t}_v - \mathbf{o}_v) \quad (5.16)$$

Not only are knowledge graphs incomplete but they are incomplete in an imbalanced way. The node degrees and relation frequency plots for Freebase and NELL in Figure 5.7 (in Section 5.3.2) illustrate this difficulty. Because of the skewed structure, using graph neural networks to encode large-scale knowledge graphs can give low-quality encodings of nodes and relations. One way of dealing with this skewness is to limit the size of the considered neighbourhood by sampling. Niepert [2016] shows how to map discriminative Gaifman models (a new family of relational machine learning models) onto KGs by learning representations from local bounded-sized neighbourhoods. The model is built bottom up from these neighbourhoods, allowing for the efficient transfer of learned representations between connected objects.

A graph convolution network (GCN) aggregates the signal for each node in the network: it sums over the incoming signals from the node’s predecessor nodes. The signal can be enriched with information about the type of relations between connected nodes, making them Relational Graph Convolution Networks (R-GCN). Schlichtkrull et al.’s [2018] transformation of the incoming signal from a connected node is based on

the connecting relation. The transformation is encoded as matrix multiplication, where each relation is represented by its own matrix. The resulting representations can be used in a link prediction formalism, as discussed in the preceding subsection.

To assist in the task of relation classification/extraction, the GCN formalism can be applied not only to knowledge graphs but to graphs which identify connections between relation types. Freebase relations, for example, have specific names (such as */people/person/ethnicity* or */people/person/nationality*) which help organize the relations themselves into a graph structure. The adoption of such a relation graph as additional information in the KG encoding process encourages similar relations to have similar representations. Zhang et al. [2019b] initialize the representation of the leaf relations with representations induced by matrix factorization, and the representations of internal nodes with averages of the representations of their children. Zhang et al. then use GCN to update these representations, so that similar relations have similar representations. The purpose of this process is to bootstrap additional information from the KG to induce more informative representations for low-frequency relations, and ultimately help link prediction.

The GNN formalism is also particularly adept at including various types of information which express relevant features of the nodes and the edges. Schlichtkrull et al.’s R-GCN has shown how to integrate information about relation types in the model. García-Durán and Niepert [2017] focus on node information, and include a variety of attributes, including numeric and multi-media features.

Hyperbolic spaces have been shown to capture structural properties of graphs better than their Euclidean counterparts; see, *e.g.*, [Nickel and Kiela, 2018]. That is why it is natural to consider an extension of graph neural networks, which exploit structural properties of graphs, to hyperbolic spaces [Liu et al., 2019a, Chami et al., 2019]. This requires tackling a few problems: map the input Euclidean node features to a hyperbolic space, perform set aggregation in hyperbolic space, and choose the hyperbolic spaces with the right curvature. Chami et al. [2019], building upon the GCN architecture, propose hyperbolic graph convolution networks (HGCM). This machinery combines the expressiveness of GCNs with hyperbolic geometry solutions of the issues of input representation and set aggregation for the problem of message-passing in GNNs. Chami et al. show that embeddings which their HGCM learns preserve hierarchical structure. That leads to improved performance, when compared to Euclidean counterparts, on link prediction on several sets of medical data.

### 5.6.2 Learning relations from texts

Relation learning from texts takes two forms. One focuses on relation classification; it assumes that the relation arguments are given, and aims to predict the relation between them. The other is the joint learning of arguments and relations from unmarked texts.

**Relation classification**

A successful model for relation classification relies on detecting shared patterns across a number of instances. Convolutional neural networks (CNNs) do this particularly well. They were initially applied in image processing, and performed very well in noticing patterns distributed over various regions of an image [LeCun and Bengio, 1995]. The idea behind CNNs for relation classification is to find common patterns in the text which surrounds or connects instances of the same relation. The context, which has varying length and complexity, can be input to the CNN in diverse ways. Some systems [Liu et al., 2015, Xu et al., 2016, Can et al., 2019] rely on producing a fixed-length vector using one of the compositional methods (see Section 5.4.1). Another possibility is to have a fixed-size window centered on the relation arguments, or to slide it over the context and pool the representations to produce “summaries” of the context based on various input masks [Zeng et al., 2014, Nguyen and Grishman, 2015].

Once a fixed-sized vector for an input sentence has been acquired, this representation can help calculate a score for the sentence with respect to a semantic relation. The calculation is based on a vector representation for each relation type, which is also a learned parameter of the model [dos Santos et al., 2015].

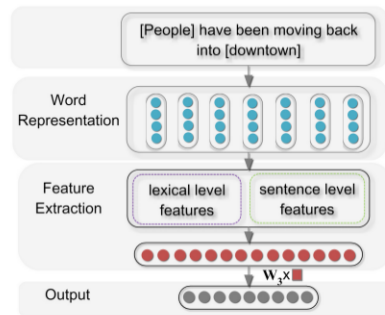

Figure 1: Architecture of the neural network used for relation classification.

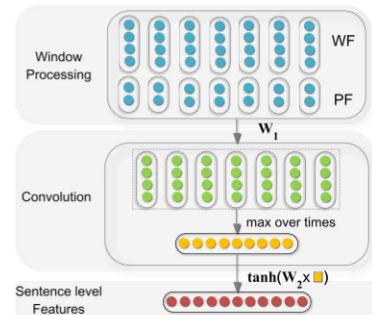

Figure 2: The framework used for extracting sentence level features.

**Figure 5.17:** Learning relations using a CNN [Zeng et al., 2014].

The representation of a sentence can have multiple segments, to find separately information relevant to relation learning. For example, Zeng et al. [2014] produce a representation with two sections, one for the target words, another for sentence-level features. These global features are induced by a convolutional neural network on the words of the input sentence. A word has a two-pronged representation: its embeddings,

and the position features which quantify its distance to the relation arguments. This is illustrated in Figure 5.17.

The arguments and their connecting patterns can be processed separately by a CNN. The arguments could be modelled by CNNs on representations of windows of several sizes centered on those arguments. The connecting phrase can be processed similarly, by applying a CNN to the sentence fragment between the relation arguments. This leads to fixed-sized vectors representing the arguments and the relation, to be used as input to a relation classification step [Zheng et al., 2016].

Dependency paths have been shown to be a useful relation indicator. Because of their varying length and structure, they require particular encoding methods. There exist compositional and graph methods for encoding such features to produce fixed-sized vectors which can serve as input to other neural networks for relation classification.

Consider sentences which contain a pair of entities and are instances of the same semantic relation. The expressions of the relation in the different sentences (*e.g.*, phrases which connect the two entities) are considered mutual paraphrases. In Rossiello et al.'s [2019] work, this assumption supports the fact that if two pairs of entities represent instances of the same relation, then they are analogous. Rossiello et al. compare pairs of entities using hierarchical Siamese networks. An entity pair is represented by all the sentential contexts found for it in a corpus. The Siamese network architecture is trained to minimize the difference between entity pairs with the same relation, even when they appear in (slightly) different contexts in the corpus. In that way, it learns the different paraphrases of the same relation.

Shwartz and Dagan [2018] apply deep learning to the prediction of paraphrases which explain noun-compound relations. They reformulate the paraphrase prediction task as three related subtasks: predict the head, the modifier, or the connecting pattern (found in a corpus). This causes a tuning of pre-computed word embeddings towards a state where modifier-head combinations which share similar patterns are closer in the embedding space, and so are patterns shared by similar modifier-head combinations.

In addition to the model architecture itself, what is essential is a good representation of the relation arguments and their contexts. When a Deep Bidirectional Transformer, or BERT, learns to predict targeted words in a sentence [Devlin et al., 2018, 2019], it builds a deep representation for the entire context by fusing the context on both sides of those words. Such a representation can help predict semantic relations; Shi and Lin [2019] study this hypothesis. BERT works with a masked language model: given a sentence, it masks certain words and then learns to predict them. For relation classification, the word/entity arguments are masked by their grammatical role and their entity type. Shi and Lin show that contextualized embeddings obtained in this manner predict very well the relation type between a given pair of words/entities in a sentence.

All these methods get and process only one path between a targeted pair of entities. In Christopoulou et al.’s [2018] system, the connection between a pair of entities is described by all possible paths between them (of length at most  $L$ ) in a complete graph which connects all entity mentions in a sentence. Christopoulou et al. assume that entity mentions and their types are given. The directed edge connecting a pair of entities in this graph is initialized by a model which combines the representation of the entities and the context around them. An iterative algorithm then builds a representation of the connection between the entities by aggregating the graph walks between them of length at most  $L$ . This representation is used to predict the relation type.

The *is-a* relation is a frequent target of relation extraction. Distributional semantic models give good results, so it is natural to ask what the improved word embeddings and deep learning can bring to this task. The *is-a* relation can be detected from the meaning of the word themselves, or from their connective patterns.

For words projected into an embedding space, the *is-a* relation could ideally be a linear projection from the hyponym to the hypernym, or at least there can be several such projections, depending on the characteristics of the word pairs. Consider, for example, *(cat, animal)* vs. *(table, furniture)* vs. *(Germany, country)*. Fu et al. [2014] propose word embeddings for the discovery of clusters in the set of arguments of the *is-a* relation. The training dataset’s clustering into groups is based on the offset between the vectors of the word pair. The clustering step is expected to uncover hyponymy/hypernymy subrelations. For each cluster, a learned linear projection (in the form of a matrix) represents the hyponymy/hypernymy relation.

Textual patterns between terms in sentences, encoded by deep-learning methods, can also serve to detect *is-a* relations. Shwartz et al. [2016] investigate the effect of combining dependency paths encoded by means of RNNs with the embeddings of the relation’s arguments. All paths between a pair of potential relation arguments participate in producing an averaged representation of the connection between the two arguments. This is assembled from a multi-layered representation of each word on the path. The representation includes the word’s lemma and part-of-speech, the dependency label (for the dependency appearing on the considered path), and the direction of the dependency relation. The method outperforms those based on symbolic distributional models.

Le et al. [2019] learn the *is-a* relation from embeddings in a hyperbolic space and from Hearst patterns [Hearst, 1992], a reliable and resilient heuristic for *is-a* in many domains. Le et al. use Hearst patterns to get *is-a* candidates from a large corpus. From the potential *is-a* instances, they build a “Hearst graph”, and embed it in a Poincaré ball. As Nickel and Kiela [2018] show, Poincaré balls are particularly apt for embedding tree structures, necessary in a taxonomy. Constraints on the hyperbolic space enable the detection of erroneous *is-a* instances and the insertion of new *is-a* links between existing nodes.

### Joint entity and relation extraction

Entities and relations can be acquired jointly if one uses their interaction to mutual advantage. Local decisions are made about the text spans which represent entity mentions, argument types and connections between them. Such decisions constrain named entities and relations, which can then be learned together [Roth and Yih, 2007]. Deep learning also makes it possible to get and combine such information. We will review methods which can be loosely grouped by how they deal with entity mention identification, and by the mention’s varying length:

- use some form of span and entity type labelling: sequence labelling or table-filling with the same style of labels;
- explore all potential spans (or spans which can be quickly recognized as maybe representing entity mentions), link them in various ways, and predict together the correct spans and the relations between them;
- process a text fragment, and output relation instances which appear in the text.

**Entity span and type labelling.** Zheng et al. [2017] adopted a tagging scheme, similar to that in [Li and Ji, 2014], for joint argument identification and relation extraction. Inspired by named entity tagging, which also must identify sequences of various lengths, Zheng et al. combined a larger set of span indicators (BIESO: Begin, Inside, End, Single, Other) with the target relations and numerals which indicate the first or the second argument of the relation. Figure 5.18 depicts the model.

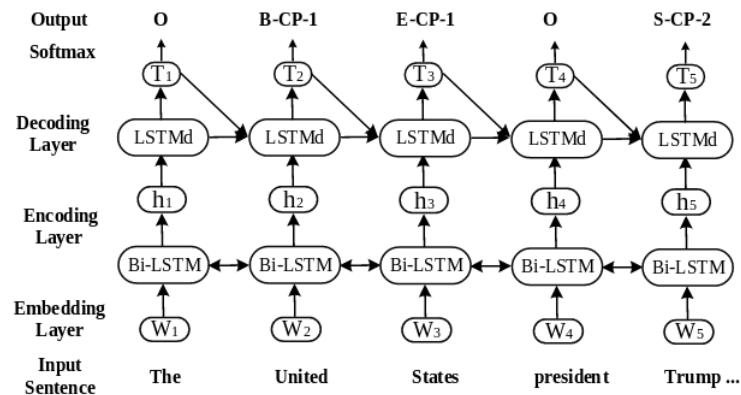

**Figure 5.18:** Zheng et al.’s [2017] joint entity and relation extraction model.

Miwa and Sasaki [2014] were the first to propose table-filling for relation classification. Gupta et al. [2016] reframe this method as a deep-learning problem. It is the same task: fill a word $\times$ word table which corresponds to sentence  $s = \langle w_1, \dots, w_n \rangle$ . The



cells on the diagonal,  $(w_i, w_i)$ , will be assigned the entity mention span and type labels. A “regular” cell  $(w_i, w_j), i \neq j$ , may be assigned a relation label if  $w_i$  and  $w_j$  correspond to the head of an entity mention. To perform this labelling, Gupta et al. choose an ordering of the cells in the table, and process them sequentially with a context-aware bidirectional RNN.

Miwa and Bansal [2016] propose a deep-learning architecture for relation extraction; bidirectional LSTM-RNNs encode the word sequence and the dependency tree. Miwa and Bansal pretrain the entity identification model and then the relation extraction model with scheduled sampling. Such sampling replaces, with certain probability, predicted entity labels with gold-standard labels. The labels predicted for entity identification guide the selection of candidates for relation classification. The entities’ heads are detected using the L and U tags, and the candidate pairs for relation classification are made from these head words. Compared to Li and Ji’s [2014] joint model which gives the ACE04 and ACE05 data to a structured perceptron, Miwa and Bansal’s model has better recall and F-score, while the structured perceptron gives higher precision. Compared to CNNs on the SemEval-2010 Task 8 data [dos Santos et al., 2015, Xu et al., 2015], there is a higher macro F1-score if bidirectional RNNs are used with long short-term memory units (BiLSTM-RNNs) to encode the word sequence and the dependency relations.

**Dynamic spans.** The basic concept here is also the span of an entity mention. Entity mentions are anchored in those spans, and relations connect two spans. The same entity can be mentioned in different places in a text. Linking different mentions of the same entity brings additional context and information to the detection of the correct span for each mention, and to the selection of the correct relation.

Luan et al. [2019] build upon the observation that entity identification, relation classification and coreference resolution share the common layer of entity mention spans. Luan et al. develop a multi-task learning framework to tackle the three tasks together. From unstructured input text, their system produces a set of candidate word spans. Each training step identifies the spans most likely to represent entity mentions; those spans serve as nodes in a graph structure. The system then constructs graph edges to represent coreference or semantic relation links, weighted by a confidence score. Span representation is refined by considering contextual information from the predicted relation and from coreference links. Luan et al. apply their system to four datasets from various domains. Wadden et al. [2019] build upon this method. They encode spans using contextual language models, and work with task-specific message updates passed over the graph of entity mention spans.

**Direct relation extraction.** Zeng et al.’s [2018] *end2end* neural model extracts potentially multiple relation instances directly from a sentence. There is an encoder and a

decoder. The encoder transforms the input sentence into a fixed-length semantic vector. The decoder performs three steps to output relation instances based on this semantic vector. It first predicts a relation type. Taking into account the relation type, it determines the source entity, and then copies this entity from the input sentence. Now, given the relation type and the source entity, the decoder determines the target entity, and copies it from the input sentence. Zeng et al. designed the process in this manner in order to ensure that their system works well if a sentence contains multiple relation instances with overlapping arguments.

### 5.6.3 Learning relations from texts and knowledge graphs

Relation instances in large knowledge repositories often play a role in distant supervision (see Section 5.5.3), in the learning of relation extraction or classification models. It is mutually beneficial to combine evidence from knowledge repositories and unstructured text, and either can help boost the other. This section shows a few examples of successfully combining evidence from unstructured data (either syntactic patterns, or phrases which connect entities/arguments in a text) with relation instances from knowledge repositories. Such methods have been used to enrich knowledge repositories with more triples for existing relations or with more relation types, or even to induce a complete relation schema from scratch.

Information from texts and knowledge graphs can be merged and then word and relation representations derived jointly, or the two sources of information can be processed separately, and then combined in a final classification step.

#### Merging information from texts and knowledge graphs

Knowledge graphs contain structured information, while unprocessed texts have a linear form. To merge them, texts must also be cast into structures. This can be done in a variety of ways, for example using dependency parsing, or by extracting specific structured information such as (*subject, verb, object*) triples. The knowledge graphs and the structured textual information can then be merged by mapping nodes and relations, and this bigger structure is processed to produce word/entity and relation/predicate representations which drive relation learning in this hybrid graph. Nodes from KGs and dependency graphs/triples can be mapped using simple matching, similarity metrics, or more complex entity linking or word sense disambiguation techniques. Relations from the KG can also be mapped to predicates or phrases from texts, either before or after the encoding of the merged graph, depending on their induced representations.

Lao et al. [2012] build such a large graph by combining relation triples from Freebase with text processed by a dependency parser. Pronouns and anaphoric references are clustered with their antecedents, and entity mentions are linked to their corresponding nodes from the knowledge repository by an entity-linking system. To this hybrid graph,

Lao et al. apply the Path Ranking Algorithm (PRA) [Lao et al., 2011] which predicts links from paths in knowledge graphs. In this case, PRA combines syntactic and semantic cues from the parsed text with relation information to build a model which can predict new relation triples for the knowledge repository.

In Lao et al.’s graph, the edges sourced from textual sources are dependency relations. Gardner et al. [2013] note that dependency relation names do not contribute semantic information, unlike relations from knowledge repositories. Instead of dependency graph representations of texts or text fragments, Gardner et al. propose to use  $(subject, verb, object)$  (SVO) triples extracted from texts which parallel  $(source, relation, target)$  triples in knowledge graphs; the link in an SVO triple—the predicate—is a lexicalized relation. For connected nodes in the graph built from the knowledge repository, Gardner et al. add new edges from SVO triples whose arguments match entities in the graph. There is a difficulty, naturally: adding such predicates directly from large-scale data (600 million SVO triples) would cause an explosion in the number of relation types in the graph, and would not catch equivalent expressions. That is why the lexicalized predicates are replaced with edge labels, which are latent features. These representations are learned by factorizing a  $subject \times object$  frequency matrix, built from the SVO data.

The follow-up work gets deeper into the semantic territory, and explores a tighter merging of KGs and texts via the similarity among relations and predicates. Gardner et al. [2014] work with a graph which combines a KG with SVO triples from texts. They take advantage of the similarity between edge types to allow a random walk to follow edges semantically similar to a given edge type. Nodes obtained from texts and KGs are linked by an *alias* relation, which indicates that the two nodes *may* point to the same entity. Edges between subjects and objects extracted from texts are lexicalized predicates, whose vector representation is computed as in [Gardner et al., 2013]. To compute the weight corresponding to a path—a sequence of relations  $r_1, \dots, r_n$ —for a given  $(source, target)$  node pair, at each step  $j$  the algorithm can follow either the exact relation type  $r_j$  in the path, or another relation type (*i.e.*, predicate) close to it in vector space. This allows the score of a “canonical path” to combine the score of all (similar) path variations.

Many relation instances may go unnoticed if one restricts links between entities in text to predicates which connect subjects and objects. Toutanova et al. [2015] treat the lexicalized dependency paths, which they encode using CNNs, as relations. These semantic representations serve as relation embeddings; they are combined with evidence from the KG to predict either the target in a  $(source, relation, ?)$  query, or the source in  $(?, relation, target)$ . The information from the two sources is combined in the model’s loss function. One term accounts for the non-negative log-likelihood of the correct entity filler with respect to the graph, computed from a combination of three graph embedding

models. The other term accounts for the non-negative log-likelihood of the correct entity filler with respect to the text; here, the vector representation of the predicate learned by the CNN replaces the relation representation in the graph embedding models.

Toutanova et al. [2016] include all relation paths of bounded length which connect a source and a target node. The paths' contribution is computed as their weighted sum. The contribution of each path is a score which combines the matrix representation of each relation on the path with the weight of the node it connects to.

There is a quantitative and qualitative difference between the predicates obtained via Open IE, and the relations in knowledge repositories. Riedel et al. [2013] aim to bridge this gap by deriving a *universal schema* which combines surface-form predicates retrieved by Open IE with relations already present in knowledge bases. A very large matrix represents jointly this heterogeneous information: columns correspond to relations from knowledge repositories and predicates found in texts; rows correspond to entity/word pairs. A cell is marked if the corresponding entity pair appears in the given relation or context—see Figure 5.19. Matrix factorization induces representations of the entity pairs and the relations/syntactic patterns, in the manner explained in Section 5.3.2. From such representations, one can determine associations between syntactic patterns and semantic relations, and map these lexical expressions onto the “canonical” relation form. The representations can also help cluster syntactic patterns to indicate new (unnamed) relations, not yet included in the knowledge repository.

Nimishakavi et al. [2016] derive a universal schema and a knowledge repository from unstructured text in a specific domain; they do it without the benefit of a “seed” knowledge repository. Instead of such prior knowledge, Nimishakavi et al. gather two types of “side information” to help structure, and make canonical, candidate (*subject, verb, object*) triples extracted by Open IE methods. The side information consist of hyponym/hypernym candidates extracted using Hearst patterns, and relation similarity (as similarities between verbs in the Open IE triples). The extracted triples

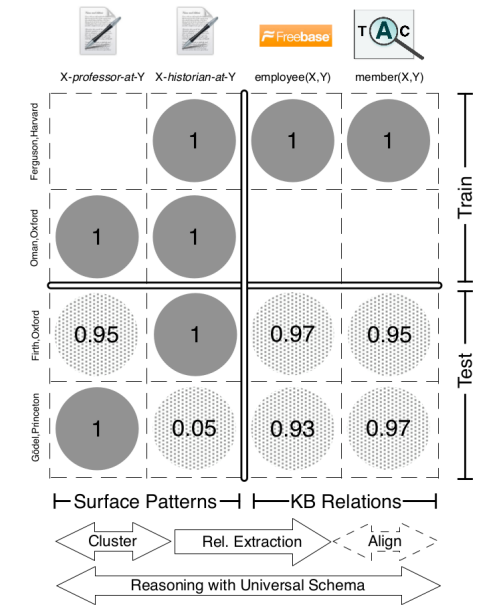

**Figure 5.19:** Induction of a universal schema from knowledge bases and texts [Riedel et al., 2013].

are represented in a tensor, factorized together with the side information to induce the relation schema. Figure 5.20 illustrates the method.

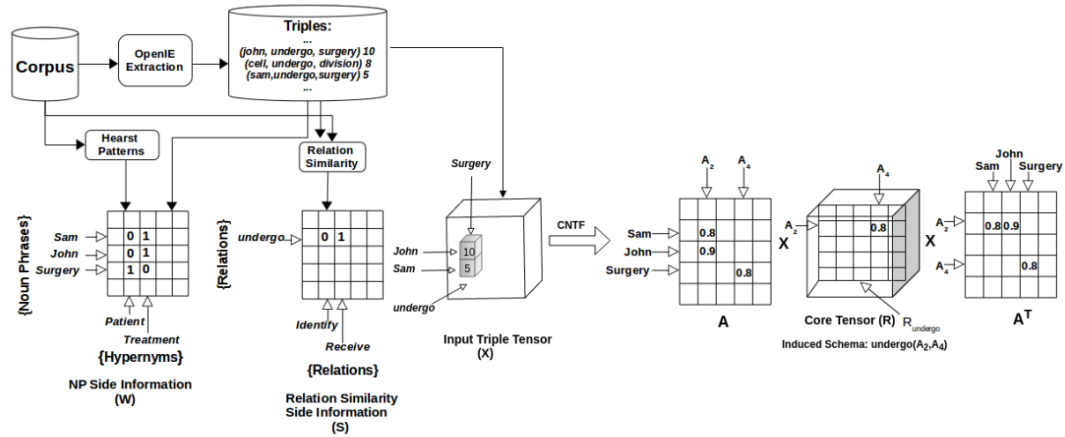

**Figure 5.20:** Relation schema induction from unstructured texts, using Hearst patterns and Open IE triples [Nimishakavi et al., 2016].

Riedel et al. [2013] developed methods based on scoring functions for  $(source, relation, target)$  triples, which combine partial scores on various pairs of the three elements. This limits the applicability of the methods to already seen *source-target*, *source-relation* or *relation-target* pairs. Verga et al. [2017] address this limitation with a representation for a pair of entities based on the textual patterns in which they appear. Verga et al. [2016] extend the application of a universal schema to multilingual data: they leverage common representations for shared entities, and match the textual patterns in the representation with relations in the knowledge repository.

Zhang et al. [2019a] encode every entity; their model combines these representations with vector representations of the target (KB) relations, and with attention methods for relation prediction. The representation of a source or target entity is based on its neighbourhood in the knowledge graph, and on its co-occurrences in the triples extracted from texts. Zhang et al.’s method is applied to Freebase and to a subset of Freebase with film-related relations, as well as to triples extracted from IMDB [Lockard et al., 2019] and ReVerb extractions from ClueWeb whose subject is linked to Freebase [Lin et al., 2012].

### Knowledge graphs and texts as separate information sources

The merging of information from texts and knowledge graphs aims to build a larger graph which can be processed with methods similar to those developed for processing

KGs: link prediction using paths, matrix factorization, and so on. Without casting texts in structured forms, they can provide additional information about the nodes or the relations in the graph, or an additional signal for relation learning in KGs.

Weston et al. [2013] encode information from the knowledge graph and the textual context separately, and use them together for relation extraction. The KG is encoded with Bordes et al.’s [2013] translation model, and TransE’s scoring function provides one part of the information. Information from texts is encoded by a function which computes a similarity measure between a relation mention and a relation embedding. A  $(source, target)$  pair is assigned the relation  $rel$  with the highest score. This score combines the  $(source, rel, target)$  triple’s KG score (TransE) and a text-based score; the latter is the cumulative score for the similarity of  $rel$ ’s embedding to every mention of the arguments (*i.e.*, every sentence which contains  $source$  and  $target$ ).

Xie et al. [2016] combine textual evidence and knowledge base relations by associating textual descriptions with entities in the KB. They encode relational triples with Bordes et al.’s TransE while inducing a representation of the entities which can be useful in predicting their textual descriptions. For the purpose of learning, these textual descriptions (included in Freebase) are encoded with two formalisms: continuous bag-of-words and convolutional neural networks. The method produces entity representations which capture both the relational information and their descriptions, and that affects the encoding of the TransE-derived relations. The representations give link prediction results better than any of the subsumed formalisms.

Fan et al. [2016] follow on Xie et al.’s work. They reduce the number of parameters of the model, and cast it into a probability framework. The improved model measures the probability of each relational triple, and maximizes the log-likelihood of the observed knowledge to learn simultaneously the contextualized embeddings of entities, relations and words in descriptions. Zhang et al. [2019b] apply knowledge graphs (Freebase), texts and pretrained word embeddings to the problem of long-tail relations. The encoding of sentences which include specific relations helps supplement the information about low-frequency entity pairs. Hierarchical information for Freebase relations (as revealed by their names) goes into a graph convolution network to induce similar representations for similar relations. This helps derive informative representations for low-frequency relations.

Natural language understanding—in particular reading comprehension—is one of the high-end tasks to which semantic relations can, or indeed should, contribute. Reading comprehension systems are commonly tested on question answering (QA) [Light et al., 2000]. Levy et al. [2017] show how to model the relation extraction/classification task as a QA task. They adopt a slot-filling framework—look for the entity to complete a triple  $(e_1, rel, ?)$ —where the relation ranges over all relation types plus *no relation*. To frame this as a QA problem, Levy et al. first *querify* the incomplete relation triple: transform it

into a query/question using crowd-sourced templates. To extract a relation instance, a bi-directional attention flow network [Seo et al., 2017] is given as input a sentence with a potential relation instance, together with a query which pairs up a source entity with a relation type. The system outputs a span which corresponds to the target entity, or signals the absence of an answer.

It is an important characteristic of this method that it can generalize to relation types it was not trained on. That is because the model does not learn to associate specific relation types with a given context, but learns to focus on a sentence segment most relevant to the query. There are further developments in this line of research: incorporate relation extraction as a QA task in a multi-task setting [McCann et al., 2018]; and apply multi-turn QA [Li et al., 2019b] which allows sequential discovery of relations, potentially using previous results to answer the current question.

#### 5.6.4 N-ary and cross-sentence relations

Most research focuses on binary semantic relations. Even so, n-ary relations are often necessary to acquire sufficient knowledge, especially in specialized domains such as chemistry or medicine. Such relations may also be expressed over a number of sentences, and that makes their extraction even more difficult. Consider this fragment from the biomedical literature [Heuckmann et al., 2011]:<sup>22</sup>

*We next expressed  $ALK^{F1174L}$ ,  $ALK^{F1174L/L1198P}$ ,  $ALK^{F1174L/G1123S}$ , and  $ALK^{F1174L/G1123D}$  in the original SH-SY5Y cell line.*

[... 15 sentences in 3 paragraphs. ...]

*The 2 mutations that were only found in the neuroblastoma resistance screen (G1123S/D) are located in the glycine-rich loop, which is known to be crucial for ATP and ligand building and are the first mutations described that induce resistance to TAE684, but not to PF02341066.*

Interestingly, n-ary relations were a target at the first Message Understanding Conference.<sup>23</sup> The task was to determine the attributes of an event (who, where, when, and so on), but each of the n-ary relations was split into binary subrelations, and each of those was dealt with via binary relation extraction/classification.

Chen et al. [2019] similarly treat n-ary relation extraction as a collection of binary relation extraction subtasks. They also allow an explicit adjustment of the context win-

<sup>22</sup>The summary results in the paper include the following statement: “An independent resistance screen in *ALK*-mutant neuroblastoma cells yielded the same L1198P resistance mutation but defined two additional mutations conferring resistance to TAE684 but not to PF02341066.” That is to say, the entities *ALK* and *PF02341066* are related.

<sup>23</sup>[ir.nist.gov/muc](http://ir.nist.gov/muc)

dow size up to two sentences. Working in a narrow domain (clinical corpus on breast cancer treatments) with limited data, Chen et al. find that the results improve when the text is modelled in terms of phrases and recognized concepts, and enriched with word embeddings and synonyms. A support vector machine gives better results than a feed-forward neural network with two fully connected layers.

Akimoto et al.'s [2019] system for n-ary relation extraction combines universal schemas and the decomposition of n-ary relations into unary and binary relations. Representations for unary and binary relations found in a knowledge base and in text are learned from the training data. The learning of the model for n-ary relations relies on optimizing a score which aggregates the lower-arity relation scores.

Quirk and Poon [2017], Peng et al. [2017] and Wang and Poon [2018] tackle the cross-sentence relation extraction task by taking into account a context larger than a sentence. They all combine inter-sentential relations (grammatical dependencies and word sequence information) with discourse relations and sentence-level sequence information. Peng et al. give this document-graph structure as input to a BiLSTM, as illustrated in Figure 5.13. The forward pass takes the word sequence information and forward-looking dependencies; the backward pass takes the reversed word sequence information and the backward-looking dependencies. The word representations derived by this formalism become the input to a relation classification step. Peng et al. [2017] classify every entity mention pair in their document graph.

This form of relation extraction does not scale well beyond one document because of the combinatorial explosion of entity mention combinations at such a high level. Jia et al.'s [2019] remedy is an entity-centric model: mentions are first mapped onto entities, and entity combinations are explored.

Christopoulou et al. [2019] build a document graph as well, but rely on different kinds of information. To obviate the need for grammatical properties, they use occurrence or co-occurrence to connect nodes which correspond to mentions, entities and sentences: mentions are connected to the sentences in which they occur, to the entities they correspond to, and to other mentions they cooccur with in a sentence; entities are connected to sentences which contain one of their mentions. Christopoulou et al. construct node descriptions from word descriptions. A mention and a sentence are represented by an average of the representations of their words, while an entity's representation averages the representations of its mentions. The aim is to build and represent edges between pairs of entities. The various paths between two entities are aggregated iteratively into edge representations. These representations are then used to classify every edge into a relation type.

Verga et al.'s [2018] model predicts mentions and relations at document level. Mention identification is simulated with an attention mechanism over tokens whose representation combines the actual token embedding and the positional embedding. This



input is passed through several layers of multi-head attention—to attend to different types of relevant information—and through convolution components. From the output of this process, Verga et al. build two position-specific representations, for the head and the tail (the source and the target) of a relation. These representations yield a pair-wise relation affinity tensor, which drives the final relation prediction.

The work discussed thus far relies on document-level information—entity mentions, and intra- and inter-sentence relations—processed together. Singh and Bhatia [2019] predict single relations which may cross sentence boundaries. They rely on additional context tokens which mediate the targeted relation. The motivation is to deal with entity mention pairs distant in the text. Finding intermediary tokens in a relation with each of the targeted mentions can help address the distance problem, and give clues about the interaction of the original pair. Singh and Bhatia account for these *second-order relations* in a transformer-based model. The model initially scores the first-order relations to intermediary tokens. Next, it scores the second-order relations by aggregating the scores for all first-order relations which mediate the targeted second-order relations.

### 5.6.5 Unsupervised relation extraction

There are several ways of tackling unsupervised relation extraction which predate the deep-learning period. They rely on semantic similarity to group extracted tuples. The similarity is calculated between the arguments of different relation instances or between the patterns which those instances display. Similarities can be used directly to find the closest relation instance match, or to cluster similar instances.

A good representation of a sentence with an instance of a relation  $r$  should be close to the representations of other sentences with other instances of  $r$ . This assumption can lead to “implicit” clusters; Marcheggiani and Titov [2016] rely on it for their variational autoencoder model. The encoder builds a semantic representation for a sentence based on a feature-rich representation. The expectation is that the representation so built will approximate the representation of a relation triple. The decoder can then reconstruct one of the arguments of the relation. The two components are trained together. In the encoding step, the argument to be reconstructed is obscured.

Information from a knowledge base added to this model introduces similarity constraints between relation tuples. Liang et al. [2019] learn to discover instances of previously unseen relations. They expand Marcheggiani and Titov’s model using the similarity between two entity pairs  $x_1 = (x_{11}, x_{12})$  and  $x_2 = (x_{21}, x_{22})$  as the cosine of the angle between the translation vectors connecting the entities in each pair:

$$\text{sim}(x_1, x_2) = \cos(\mathbf{v}_{11} - \mathbf{v}_{12}, \mathbf{v}_{21} - \mathbf{v}_{22}) \quad (5.17)$$

$\mathbf{v}_{ij}$  is the knowledge base embedding of entity  $x_{ij}$ .

Liang et al. compute two variations. One of them represents the *must-link* confidence score  $s^+(x_1, x_2) = [\text{sim}(x_1, x_2)]_{\gamma^+}^+$ , the other the *must-not-link* confidence score  $s^-(x_1, x_2) = [\text{sim}(x_1, x_2)]_{\gamma^-}^-$ , where the thresholds  $\gamma^+, \gamma^- \in [0, 1]$  limit the two scores. ( $[x]_{\gamma^+}^+ = \text{if } x > \gamma^+ \text{ then } x \text{ else } 0$ ;  $[x]_{\gamma^-}^- = \text{if } x < -\gamma^- \text{ then } x \text{ else } 0$ .) These scores, together with the scores which compare the corresponding sentence representations, help determine if the two sentences containing these relation tuples should be in the same cluster, *i.e.*, should represent the same relation. The sentence representations are derived by a system built upon Marcheggiani and Titov’s variational autoencoder.

Papanikolaou et al.’s [2019] method generates its own training data for targeted relations on a pre-specified list. They first extract (*subject, verb, object*) triples, and use pre-trained embeddings to map the verbs onto the given set of target relations. The system drops verbs whose similarity to any given relation falls below a threshold. The triples with the accepted verbs are mapped onto texts, as in distant supervision. The sentences which contain the automatically annotated relation instances then help fine-tune a BERT model for relation classification.

### 5.6.6 Lifelong Learning

Deep learning requires very large training data to build accurate models. The model consists of the network architecture and its parameters—weights in its various units—whose best values are determined during training. Training such a model costs a great deal of computing time and power. A deep-learning system which aims to continue learning faces a dilemma. It can keep retraining on ever-growing datasets, or be doomed to forget much of what it has learned if it gets none, or only a subset, of the old data together with newer instances for training a new model. That is because even a small change in the learned parameters (when the model is updated on new data) may cause unpredictable behaviour on the older data.

Wang et al. [2019] suggest a two-part solution. Inspired by previous research on handwriting and object recognition, they propose a new strategy: maintain a “training memory”, and select instances from previously used data to add to a new training set, and so avoid forgetting the older data. They call their method *episodic memory replay* (EMR). The “memory”  $\mathcal{M}$  consists of a number of training examples selected after each training session. When training on a new dataset, EMR adds a sample of instances from  $\mathcal{M}$  to the current training data, so the model can retain the knowledge of previous data. The second part of the solution arises from the observation that a good model should not distort excessively the embedding space of the model’s parameters when it gets additional training data. For the task of relation extraction in particular, Wang et al. use the sentence embeddings derived by the neural model in previous sessions as anchor points, and constrain the system to only minimally distort these anchor points with the processing of new data.

## 5.7 Summary

This chapter has presented an overview of the recognition and classification of semantic relations in the deep-learning paradigm. The methods developed for the traditional learning of semantic relations can be directly mapped onto this new formalism but the power of deep learning is best unleashed when we can take advantage of its specific characteristics:

- low-dimensional representation of word meaning based on various types of knowledge;
- representation derived simultaneously for arguments and relations;
- the leveraging of multiple information sources;
- the availability of formalisms which encode variable-length sequences and find patterns in them;
- the encoding of graph structures (syntactic or semantic) together with a variety of additional attributes.

Deep learning requires, among other things, large amounts of training data. Some such data can be bootstrapped from existing knowledge repositories by distant supervision. The adoption of deep learning has led to innovative ways of cleaning the automatically annotated data. Many interesting methods have been developed to tackle noise in automatically generated data: people have applied adversarial learning, reinforcement learning and other fun formalisms. The new technology has opened a vast space of exploration. We have presented some of the main trends, but there are new directions to be found, and space in between.

# Bibliography

- Kosuke Akimoto, Takuya Hiraoka, Kunihiko Sadamasa, and Mathias Niepert. Cross-Sentence N-ary Relation Extraction using Lower-Arity Universal Schemas. In *Proc. 2019 Conference on Empirical Methods in Natural Language Processing and the 9th International Joint Conference on Natural Language Processing (EMNLP-IJCNLP)*, pages 6225–6231, Hong Kong, China, 2019. Association for Computational Linguistics. URL [www.aclweb.org/anthology/D19-1645](http://www.aclweb.org/anthology/D19-1645). (Cited on pp. 28 and 55.)
- Mohammed Alsuhaibani, Takanori Maehara, and Danushka Bollegala. Joint Learning of Hierarchical Word Embeddings from a Corpus and a Taxonomy. In *Automated Knowledge Base Construction (AKBC)*, 2019. doi: 10.24432/C50591. URL [openreview.net/forum?id=S1xf-W5paX](http://openreview.net/forum?id=S1xf-W5paX). (Cited on p. 17.)
- Christoph Alt, Aleksandra Gabryszak, and Leonhard Hennig. TACRED Revisited: A Thorough Evaluation of the TACRED Relation Extraction Task. In *Proc. 58th Annual Meeting of the Association for Computational Linguistics*, pages 1558–1569, 2020. URL [www.aclweb.org/anthology/2020.acl-main.142](http://www.aclweb.org/anthology/2020.acl-main.142). (Cited on p. 30.)
- Ron Artstein and Massimo Poesio. Inter-Coder Agreement for Computational Linguistics. *Computational Linguistics*, 34(4):555–596, 2008. URL [www.aclweb.org/anthology/J08-4004](http://www.aclweb.org/anthology/J08-4004). (Cited on p. 29.)
- Fan Bai and Alan Ritter. Structured Minimally Supervised Learning for Neural Relation Extraction. In *Proc. 2019 Conference of the North American Chapter of the Association for Computational Linguistics: Human Language Technologies, Volume 1 (Long and Short Papers)*, pages 3057–3069, Minneapolis, Minnesota, 2019. Association for Computational Linguistics. URL [www.aclweb.org/anthology/N19-1310](http://www.aclweb.org/anthology/N19-1310). (Cited on p. 31.)
- Ivana Balazevic, Carl Allen, and Timothy Hospedales. Multi-relational poincaré graph embeddings. In *Advances in Neural Information Processing Systems*, pages 4463–4473, 2019. (Cited on pp. 15 and 39.)
- Iz Beltagy, Kyle Lo, and Waleed Ammar. Combining Distant and Direct Supervision for Neural Relation Extraction. In *Proc. 2019 Conference of the North American Chapter of the Association for Computational Linguistics: Human Language Technologies, Volume 1 (Long and Short Papers)*, pages 1858–1867, 2019. (Cited on p. 35.)

- Yoshua Bengio, Réjean Ducharme, Pascal Vincent, and Christian Jauvin. A Neural Probabilistic Language Model. *J. Machine Learning Research*, 3:1137–1155, 2003. (Cited on pp. 7 and 8.)
- David M. Blei, Andrew Y. Ng, and Michael I. Jordan. Latent Dirichlet Allocation. *Journal of Machine Learning Research*, 3:993–1022, 2003. ISSN 1532-4435. URL [dl.acm.org/citation.cfm?id=944919.944937](http://dl.acm.org/citation.cfm?id=944919.944937). (Cited on p. 7.)
- Antoine Bordes, Jason Weston, Ronan Collobert, and Yoshua Bengio. Learning Structured Embeddings of Knowledge Bases. In *Proc. Twenty-Fifth AAAI Conference on Artificial Intelligence, AAAI 2011*, pages 301–306, 2011. (Cited on p. 15.)
- Antoine Bordes, Nicolas Usunier, Alberto Garcia-Duran, Jason Weston, and Oksana Yakhnenko. Translating Embeddings for Modeling Multi-relational Data. In C. J. C. Burges, L. Bottou, M. Welling, Z. Ghahramani, and K. Q. Weinberger, editors, *Advances in Neural Information Processing Systems 26*, pages 2787–2795. Curran Associates, Inc., 2013. URL [papers.nips.cc/paper/5071-translating-embeddings-for-modeling-multi-relational-data.pdf](http://papers.nips.cc/paper/5071-translating-embeddings-for-modeling-multi-relational-data.pdf). (Cited on pp. 38, 39, and 53.)
- Duy-Cat Can, Hoang-Quynh Le, Quang-Thuy Ha, and Nigel Collier. A Richer-but-Smarter Shortest Dependency Path with Attentive Augmentation for Relation Extraction. In *Proc. 2019 Conference of the North American Chapter of the Association for Computational Linguistics: Human Language Technologies, Volume 1 (Long and Short Papers)*, pages 2902–2912, Minneapolis, Minnesota, 2019. Association for Computational Linguistics. URL [www.aclweb.org/anthology/N19-1298](http://www.aclweb.org/anthology/N19-1298). (Cited on pp. 22 and 44.)
- Ines Chami, Zhitao Ying, Christopher Ré, and Jure Leskovec. Hyperbolic Graph Convolutional Neural Networks. In *Advances in Neural Information Processing Systems*, pages 4868–4879, 2019. (Cited on p. 43.)
- Kai-Wei Chang, Wen-tau Yih, Bishan Yang, and Christopher Meek. Typed Tensor Decomposition of Knowledge Bases for Relation Extraction. In *Proc. 2014 Conference on Empirical Methods in Natural Language Processing (EMNLP)*, pages 1568–1579. Association for Computational Linguistics, 2014. URL [aclweb.org/anthology/D14-1165](http://aclweb.org/anthology/D14-1165). (Cited on p. 13.)
- Jiyu Chen, Karin Verspoor, and Zenan Zhai. A Bag-of-concepts Model Improves Relation Extraction in a Narrow Knowledge Domain with Limited Data. In *Proc. 2019 Conference of the North American Chapter of the Association for Computational Linguistics: Student Research Workshop*, pages 43–52, Minneapolis, Minnesota,

2019. Association for Computational Linguistics. doi: 10.18653/v1/N19-3007. URL [www.aclweb.org/anthology/N19-3007](http://www.aclweb.org/anthology/N19-3007). (Cited on pp. 54 and 55.)

Kyunghyun Cho, Bart van Merriënboer, Caglar Gulcehre, Dzmitry Bahdanau, Fethi Bougares, Holger Schwenk, and Yoshua Bengio. Learning Phrase Representations using RNN Encoder–Decoder for Statistical Machine Translation. In *Proc. 2014 Conference on Empirical Methods in Natural Language Processing, EMNLP’ 14*, pages 1724–1734, Doha, Qatar, 2014. URL [www.aclweb.org/anthology/D14-1179](http://www.aclweb.org/anthology/D14-1179). (Cited on p. 20.)

Fenia Christopoulou, Makoto Miwa, and Sophia Ananiadou. A Walk-based Model on Entity Graphs for Relation Extraction. In *Proc. 56th Annual Meeting of the Association for Computational Linguistics (Volume 2: Short Papers)*, pages 81–88, Melbourne, Australia, 2018. Association for Computational Linguistics. URL [www.aclweb.org/anthology/P18-2014](http://www.aclweb.org/anthology/P18-2014). (Cited on p. 46.)

Fenia Christopoulou, Makoto Miwa, and Sophia Ananiadou. Connecting the Dots: Document-level Neural Relation Extraction with Edge-oriented Graphs. In *Proc. 2019 Conference on Empirical Methods in Natural Language Processing and the 9th International Joint Conference on Natural Language Processing (EMNLP-IJCNLP)*, pages 4925–4936, 2019. URL [www.aclweb.org/anthology/D19-1498](http://www.aclweb.org/anthology/D19-1498). (Cited on p. 55.)

Ronan Collobert and Jason Weston. A Unified Architecture for Natural Language Processing: Deep Neural Networks with Multitask Learning. In *Proc. 25th International Conference on Machine Learning, ICML ’08*, pages 160–167, New York, NY, USA, 2008. ACM. ISBN 978-1-60558-205-4. URL [doi.acm.org/10.1145/1390156.1390177](https://doi.org/10.1145/1390156.1390177). (Cited on p. 8.)

Alexis Conneau, Kartikay Khandelwal, Naman Goyal, Vishrav Chaudhary, Guillaume Wenzek, Francisco Guzmán, Edouard Grave, Myle Ott, Luke Zettlemoyer, and Veselin Stoyanov. Unsupervised cross-lingual representation learning at scale. *arXiv preprint*, 2019. URL [arxiv.org/abs/1911.02116](https://arxiv.org/abs/1911.02116). (Cited on p. 10.)

Nilesh Dalvi, Pedro Domingos, Mausam, Sumit Sanghai, and Deepak Verma. Adversarial Classification. In *Proc. Tenth ACM SIGKDD International Conference on Knowledge Discovery and Data Mining, KDD ’04*, pages 99–108, New York, NY, USA, 2004. ACM. ISBN 1-58113-888-1. URL [doi.acm.org/10.1145/1014052.1014066](https://doi.org/10.1145/1014052.1014066). (Cited on p. 33.)

Rajarshi Das, Arvind Neelakantan, David Belanger, and Andrew McCallum. Chains of Reasoning over Entities, Relations, and Text using Recurrent Neural Networks. *arXiv preprint*, 2016. URL [arxiv.org/abs/1607.01426](https://arxiv.org/abs/1607.01426). (Cited on p. 40.)

- Tim Dettmers, Pasquale Minervini, Pontus Stenetorp, and Sebastian Riedel. Convolutional 2D Knowledge Graph Embeddings. In *Proc. Thirty-Second AAAI Conference on Artificial Intelligence, (AAAI-18), the 30th innovative Applications of Artificial Intelligence (IAAI-18), and the 8th AAAI Symposium on Educational Advances in Artificial Intelligence (EAAI-18), New Orleans, Louisiana, USA, February 2-7, 2018*, pages 1811–1818, 2018. URL [www.aaai.org/ocs/index.php/AAAI/AAAI18/paper/view/17366](http://www.aaai.org/ocs/index.php/AAAI/AAAI18/paper/view/17366). (Cited on pp. 39 and 41.)
- Jacob Devlin, Ming-Wei Chang, Kenton Lee, and Kristina Toutanova. BERT: Pre-training of deep bidirectional transformers for language understanding. *arXiv preprint*, 2018. URL [arxiv.org/abs/1810.04805](https://arxiv.org/abs/1810.04805). (Cited on pp. 4, 10, 25, and 45.)
- Jacob Devlin, Ming-Wei Chang, Kenton Lee, and Kristina Toutanova. BERT: Pre-training of Deep Bidirectional Transformers for Language Understanding. In *Proc. 2019 Conference of the North American Chapter of the Association for Computational Linguistics: Human Language Technologies, Volume 1 (Long and Short Papers)*, pages 4171–4186, 2019. URL [www.aclweb.org/anthology/N19-1423](http://www.aclweb.org/anthology/N19-1423). (Cited on pp. 4, 10, 25, and 45.)
- Cícero Nogueira dos Santos, Bing Xiang, and Bowen Zhou. Classifying Relations by Ranking with Convolutional Neural Networks. In *Proc. 53rd Annual Meeting of the Association for Computational Linguistics and the 7th International Joint Conference on Natural Language Processing*, pages 626–634, 2015. (Cited on pp. 44 and 48.)
- Jinhua Du, Jingguang Han, Andy Way, and Dadong Wan. Multi-Level Structured Self-Attentions for Distantly Supervised Relation Extraction. In *Proc. 2018 Conference on Empirical Methods in Natural Language Processing*, pages 2216–2225, Brussels, Belgium, 2018. Association for Computational Linguistics. URL [www.aclweb.org/anthology/D18-1245](http://www.aclweb.org/anthology/D18-1245). (Cited on p. 35.)
- Kawin Ethayarajh, David Duvenaud, and Graeme Hirst. Towards Understanding Linear Word Analogies. In *Proc. 57th Annual Meeting of the Association for Computational Linguistics*, pages 3253–3262, Florence, Italy, 2019. Association for Computational Linguistics. doi: 10.18653/v1/P19-1315. (Cited on pp. 8 and 23.)
- Miao Fan, Deli Zhao, Qiang Zhou, Zhiyuan Liu, Thomas Fang Zheng, and Edward Y. Chang. Distant Supervision for Relation Extraction with Matrix Completion. In *Proc. 52nd Annual Meeting of the Association for Computational Linguistics (Volume 1: Long Papers)*, pages 839–849, Baltimore, Maryland, 2014. Association for Computational Linguistics. doi: 10.3115/v1/P14-1079. URL [www.aclweb.org/anthology/P14-1079](http://www.aclweb.org/anthology/P14-1079). (Cited on p. 32.)

- Miao Fan, Qiang Zhou, Thomas Fang Zheng, and Ralph Grishman. Distributed representation learning for knowledge graphs with entity descriptions. *Pattern Recognition Letters*, 93(2017):31–37, 2016. (Cited on p. 53.)
- Michael Färber, Frederic Bartscherer, Carsten Menne, and Achim Rettinger. Linked data quality of dbpedia, freebase, opencyc, wikidata, and yago. *Semantic Web*, 9(1): 77–129, 2018. (Cited on p. 30.)
- Jun Feng, Minlie Huang, Li Zhao, Yang Yang, and Xiaoyan Zhu. Reinforcement learning for relation classification from noisy data. In *Thirty-Second AAAI Conference on Artificial Intelligence*, 2018. (Cited on p. 36.)
- Gregory Finley, Stephanie Farmer, and Serguei Pakhomov. What Analogies Reveal about Word Vectors and their Compositionality. In *Proc. 6th Joint Conference on Lexical and Computational Semantics (\*SEM 2017)*, pages 1–11. Association for Computational Linguistics, 2017. URL [www.aclweb.org/anthology/S17-1001](http://www.aclweb.org/anthology/S17-1001). (Cited on p. 23.)
- Ruiji Fu, Jiang Guo, Bing Qin, Wanxiang Che, Haifeng Wang, and Ting Liu. Learning Semantic Hierarchies via Word Embeddings. In *Proc. 52nd Annual Meeting of the Association for Computational Linguistics (Volume 1: Long Papers)*, pages 1199–1209, Baltimore, Maryland, 2014. Association for Computational Linguistics. URL [www.aclweb.org/anthology/P14-1113](http://www.aclweb.org/anthology/P14-1113). (Cited on p. 46.)
- George W. Furnas, Scott Deerwester, Susan T. Dumais, Thomas K. Landauer, Richard A. Harshman, Lynn A. Streeter, and Karen E. Lochbaum. Information retrieval using a singular value decomposition model of latent semantic structure. In *Proc. 11th Annual International ACM SIGIR Conference on Research and Development in Information Retrieval*, pages 465–480, 1988. (Cited on p. 6.)
- Tianyu Gao, Xu Han, Hao Zhu, Zhiyuan Liu, Peng Li, Maosong Sun, and Jie Zhou. FewRel 2.0: Towards More Challenging Few-Shot Relation Classification. In *Proc. Conference on Empirical Methods in Natural Language Processing and International Joint Conference on Natural Language Processing (EMNLP-IJCNLP 2019)*, pages 6250–6255, 2019. URL [www.aclweb.org/anthology/D19-1649](http://www.aclweb.org/anthology/D19-1649). (Cited on p. 29.)
- Alberto García-Durán and Mathias Niepert. Learning Graph Representations with Embedding Propagation. In *Proc. 31st International Conference on Neural Information Processing Systems*, pages 5125–5136, 2017. (Cited on p. 43.)
- Matt Gardner and Tom Mitchell. Efficient and Expressive Knowledge Base Completion Using Subgraph Feature Extraction. In *Proc. 2015 Conference on Empirical Methods in Natural Language Processing*, pages 1488–1498. Association for Computational Linguistics, 2015. URL [aclweb.org/anthology/D15-1173](http://aclweb.org/anthology/D15-1173). (Cited on pp. 27 and 40.)



- Matt Gardner, Partha Pratim Talukdar, Bryan Kiesel, and Tom Mitchell. Improving Learning and Inference in a Large Knowledge-Base using Latent Syntactic Cues. In *Proc. 2013 Conference on Empirical Methods in Natural Language Processing*, pages 833–838. Association for Computational Linguistics, 2013. URL [www.aclweb.org/anthology/D13-1080](http://www.aclweb.org/anthology/D13-1080). (Cited on p. 50.)
- Matt Gardner, Partha Talukdar, Jayant Krishnamurthy, and Tom Mitchell. Incorporating Vector Space Similarity in Random Walk Inference over Knowledge Bases. In *Proc. 2014 Conference on Empirical Methods in Natural Language Processing (EMNLP)*, pages 397–406, Doha, Qatar, 2014. Association for Computational Linguistics. URL [www.aclweb.org/anthology/D14-1044](http://www.aclweb.org/anthology/D14-1044). (Cited on pp. 14 and 50.)
- Roxana Girju, Preslav Nakov, Vivi Nastase, Stan Szpakowicz, Peter Turney, and Deniz Yuret. Classification of semantic relations between nominals. *Language Resources and Evaluation*, 43(2):105–121, 2009. (Cited on p. 29.)
- Ian Goodfellow, Jean Pouget-Abadie, Mehdi Mirza, Bing Xu, David Warde-Farley, Sherjil Ozair, Aaron Courville, and Yoshua Bengio. Generative adversarial nets. In *Advances in neural information processing systems*, pages 2672–2680, 2014. (Cited on p. 33.)
- Ian Goodfellow, Yoshua Bengio, and Aaron Courville. *Deep Learning*. MIT Press, 2016. [www.deeplearningbook.org](http://www.deeplearningbook.org). (Cited on p. 3.)
- Matthew R. Gormley, Mo Yu, and Mark Dredze. Improved Relation Extraction with Feature-Rich Compositional Embedding Models. In *Proc. 2015 Conference on Empirical Methods in Natural Language Processing*, pages 1774–1784, Lisbon, Portugal, 2015. Association for Computational Linguistics. URL [www.aclweb.org/anthology/D15-1205](http://www.aclweb.org/anthology/D15-1205). (Cited on p. 19.)
- Aditya Grover and Jure Leskovec. node2vec: Scalable Feature Learning for Networks. In *Proc. 22nd ACM SIGKDD International Conference on Knowledge Discovery and Data Mining*, pages 855–864, 2016. (Cited on p. 16.)
- Pankaj Gupta, Hinrich Schütze, and Bernt Andrassy. Table Filling Multi-Task Recurrent Neural Network for Joint Entity and Relation Extraction. In *Proc. COLING 2016, 26th International Conference on Computational Linguistics: Technical Papers*, pages 2537–2547, 2016. (Cited on pp. 47 and 48.)
- Michael Gutmann and Aapo Hyvarinen. Noise-contrastive estimation of unnormalized statistical models, with applications to natural image statistics. *The Journal of Machine Learning Research*, 13(1):307—361, 2012. (Cited on p. 38.)

- Kelvin Guu, John Miller, and Percy Liang. Traversing Knowledge Graphs in Vector Space. In *Proc. 2015 Conference on Empirical Methods in Natural Language Processing*, pages 318–327. Association for Computational Linguistics, 2015. doi: 10.18653/v1/D15-1038. URL [aclweb.org/anthology/D15-1038](http://aclweb.org/anthology/D15-1038). (Cited on p. 40.)
- Xu Han, Hao Zhu, Pengfei Yu, Ziyun Wang, Yuan Yao, Zhiyuan Liu, and Maosong Sun. FewRel: A Large-Scale Supervised Few-Shot Relation Classification Dataset with State-of-the-Art Evaluation. In *Proc. Conference on Empirical Methods in Natural Language Processing (EMNLP 2018)*, pages 4803–4809, 2018. URL [www.aclweb.org/anthology/D18-1514](http://www.aclweb.org/anthology/D18-1514). (Cited on p. 29.)
- Shizhu He, Kang Liu, Guoliang Ji, and Jun Zhao. Learning to Represent Knowledge Graphs with Gaussian Embedding. In *Proc. 24th ACM International on Conference on Information and Knowledge Management, CIKM '15*, pages 623–632, New York, NY, USA, 2015. ACM. ISBN 978-1-4503-3794-6. URL [doi.acm.org/10.1145/2806416.2806502](https://doi.acm.org/10.1145/2806416.2806502). (Cited on p. 38.)
- Marti A. Hearst. Automatic Acquisition of Hyponyms from Large Text Corpora. In *Proc. 14th International Conference on Computational Linguistics (COLING-92)*, Nantes, France, 1992. (Cited on p. 46.)
- Iris Hendrickx, Su Nam Kim, Zornitsa Kozareva, Preslav Nakov, Diarmuid Ó Séaghdha, Sebastian Padó, Marco Pennacchiotti, Lorenza Romano, and Stan Szpakowicz. SemEval-2010 Task 8: Multi-Way Classification of Semantic Relations between Pairs of Nominals. In *Proc. 5th International Workshop on Semantic Evaluation*, pages 33–38, Uppsala, Sweden, 2010. Association for Computational Linguistics. URL [www.aclweb.org/anthology/S10-1006](http://www.aclweb.org/anthology/S10-1006). (Cited on p. 29.)
- Johannes M. Heuckmann, Michael Hölzel, Martin L. Sos, Stefanie Heynck, Hyatt Balke-Want, Mirjam Koker, Martin Peifer, Jonathan Weiss, Christine M. Lovly, Christian Grütter, Daniel Rauh, William Pao, and Roman K. Thomas. ALK Mutations Confering Differential Resistance to Structurally Diverse ALK Inhibitors. *Clinical Cancer Research*, 17(23):7394–7401, 2011. URL [www.ncbi.nlm.nih.gov/pmc/articles/PMC3382103/](http://www.ncbi.nlm.nih.gov/pmc/articles/PMC3382103/). (Cited on p. 54.)
- Sepp Hochreiter and Jürgen Schmidhuber. Long Short-Term Memory. *Neural Computation*, 9(8):1735–1780, 1997. URL [doi.org/10.1162/neco.1997.9.8.1735](https://doi.org/10.1162/neco.1997.9.8.1735). (Cited on p. 20.)
- Raphael Hoffmann, Congle Zhang, Xiao Ling, Luke Zettlemoyer, and Daniel S. Weld. Knowledge-based Weak Supervision for Information Extraction of Overlapping Relations. In *Proc. 49th Annual Meeting of the Association for Computational Linguistics: Human Language Technologies - Volume 1, HLT '11*, pages 541–550, Stroudsburg, PA,

- USA, 2011. Association for Computational Linguistics. ISBN 978-1-932432-87-9. URL [dl.acm.org/citation.cfm?id=2002472.2002541](http://dl.acm.org/citation.cfm?id=2002472.2002541). (Cited on p. 31.)
- Ignacio Iacobacci, Mohammad Taher Pilehvar, and Roberto Navigli. SensEmbed: Learning Sense Embeddings for Word and Relational Similarity. In *Proc. 53rd Annual Meeting of the Association for Computational Linguistics and the 7th International Joint Conference on Natural Language Processing (Volume 1: Long Papers)*, pages 95–105, Beijing, China, 2015. Association for Computational Linguistics. URL [www.aclweb.org/anthology/P15-1010](http://www.aclweb.org/anthology/P15-1010). (Cited on p. 9.)
- Sharmistha Jat, Siddhesh Khandelwal, and Partha P. Talukdar. Improving Distantly Supervised Relation Extraction using Word and Entity Based Attention. *arXiv preprint*, 2018. URL [arxiv.org/abs/1804.06987](http://arxiv.org/abs/1804.06987). (Cited on p. 28.)
- Guoliang Ji, Shizhu He, Liheng Xu, Kang Liu, and Jun Zhao. Knowledge graph embedding via dynamic mapping matrix. In *Proc. 53rd Annual Meeting of the Association for Computational Linguistics and the 7th International Joint Conference on Natural Language Processing (Volume 1: Long Papers)*, pages 687–696, 2015. (Cited on p. 38.)
- Guoliang Ji, Kang Liu, Shizhu He, and Jun Zhao. Knowledge graph completion with adaptive sparse transfer matrix. In *Proc. Thirtieth AAAI Conference on Artificial Intelligence*, 2016. (Cited on p. 38.)
- Guoliang Ji, Kang Liu, Shizhu He, and Jun Zhao. Distant Supervision for Relation Extraction with Sentence-Level Attention and Entity Descriptions. In *Proc. Thirty-First AAAI Conference on Artificial Intelligence (AAAI-17)*, pages 3060–3066, 2017. (Cited on p. 35.)
- Shaoxiong Ji, Shirui Pan, Erik Cambria, Pekka Marttinen, and Philip S. Yu. A Survey on Knowledge Graphs: Representation, Acquisition and Applications. *arXiv preprint*, 2020. URL [arxiv.org/abs/2002.00388](http://arxiv.org/abs/2002.00388). (Cited on pp. 12, 37, and 39.)
- Robin Jia, Cliff Wong, and Hoifung Poon. Document-Level N-ary Relation Extraction with Multiscale Representation Learning. In *Proc. 2019 Conference of the North American Chapter of the Association for Computational Linguistics: Human Language Technologies, Volume 1 (Long and Short Papers)*, pages 3693–3704, Minneapolis, Minnesota, 2019. Association for Computational Linguistics. URL [www.aclweb.org/anthology/N19-1370](http://www.aclweb.org/anthology/N19-1370). (Cited on p. 55.)
- Xiaotian Jiang, Quan Wang, and Bin Wang. Adaptive Convolution for Multi-Relational Learning. In *Proc. 2019 Conference of the North American Chapter of the Association for Computational Linguistics: Human Language Technologies, Volume 1 (Long and Short Papers)*, pages 978–987, Minneapolis, Minnesota, 2019. Association for Computational Linguistics. doi: 10.18653/v1/N19-1103. (Cited on p. 41.)

- Ian T. Jolliffe. *Principal Component Analysis*. Springer Series in Statistics. Springer-Verlag, New York, 2002. (Cited on p. 7.)
- Bhushan Kotnis and Vivi Nastase. Learning Knowledge Graph Embeddings with Type Regularizer. In *Proc. Knowledge Capture Conference, K-CAP 2017*, pages 19:1–19:4. ACM, 2017. ISBN 978-1-4503-5553-7. (Cited on p. 13.)
- Bhushan Kotnis and Vivi Nastase. Analysis of the Impact of Negative Sampling on Link Prediction in Knowledge Graphs. In *Workshop on Knowledge Base Construction, Reasoning and Mining (KBCOM)*, 2018. URL [arxiv.org/abs/1708.06816](https://arxiv.org/abs/1708.06816). (Cited on p. 38.)
- Zhenzhong Lan, Mingda Chen, Sebastian Goodman, Kevin Gimpel, Piyush Sharma, and Radu Soricut. ALBERT: A Lite BERT for Self-supervised Learning of Language Representations. In *International Conference on Learning Representations, ICLR '20*, 2020. (Cited on p. 10.)
- Ni Lao, Tom Mitchell, and William W. Cohen. Random Walk Inference and Learning in A Large Scale Knowledge Base. In *Proc. 2011 Conference on Empirical Methods in Natural Language Processing*, pages 529–539. Association for Computational Linguistics, 2011. URL [www.aclweb.org/anthology/D11-1049](http://www.aclweb.org/anthology/D11-1049). (Cited on pp. 40 and 50.)
- Ni Lao, Amarnag Subramanya, Fernando Pereira, and William W. Cohen. Reading The Web with Learned Syntactic-Semantic Inference Rules. In *Proc. 2012 Joint Conference on Empirical Methods in Natural Language Processing and Computational Natural Language Learning*, pages 1017–1026. Association for Computational Linguistics, 2012. URL [www.aclweb.org/anthology/D12-1093](http://www.aclweb.org/anthology/D12-1093). (Cited on pp. 49 and 50.)
- Matt Le, Stephen Roller, Laetitia Papaxanthos, Douwe Kiela, and Maximilian Nickel. Inferring Concept Hierarchies from Text Corpora via Hyperbolic Embeddings. *arXiv preprint*, 2019. URL [arXiv.org/abs/1902.00913](https://arxiv.org/abs/1902.00913). (Cited on p. 46.)
- Yann LeCun and Yoshua Bengio. Convolutional Networks for Images, Speech, and Time Series. *The Handbook of Brain Theory and Neural Networks*, 3361(10):255–258, 1995. (Cited on p. 44.)
- Omer Levy and Yoav Goldberg. Neural word embedding as implicit matrix factorization. In *Advances in neural information processing systems*, pages 2177–2185, 2014a. (Cited on p. 12.)
- Omer Levy and Yoav Goldberg. Linguistic Regularities in Sparse and Explicit Word Representations. In *Proc. Eighteenth Conference on Computational Natural Language Learning*, pages 171–180. Association for Computational Linguistics, 2014b. URL [www.aclweb.org/anthology/W14-1618](http://www.aclweb.org/anthology/W14-1618). (Cited on p. 23.)

- Omer Levy, Minjoon Seo, Eunsol Choi, and Luke Zettlemoyer. Zero-Shot Relation Extraction via Reading Comprehension. In *Proc. 21st Conference on Computational Natural Language Learning (CoNLL 2017)*, pages 333–342. Association for Computational Linguistics, 2017. URL [www.aclweb.org/anthology/K17-1034](http://www.aclweb.org/anthology/K17-1034). (Cited on p. 53.)
- Pengshuai Li, Xinsong Zhang, Weijia Jia, and Hai Zhao. GAN Driven Semi-distant Supervision for Relation Extraction. In *Proc. 2019 Conference of the North American Chapter of the Association for Computational Linguistics: Human Language Technologies, Volume 1 (Long and Short Papers)*, pages 3026–3035, Minneapolis, Minnesota, 2019a. Association for Computational Linguistics. URL [www.aclweb.org/anthology/N19-1307](http://www.aclweb.org/anthology/N19-1307). (Cited on p. 34.)
- Qi Li and Heng Ji. Incremental Joint Extraction of Entity Mentions and Relations. In *Proc. 52nd Annual Meeting of the Association for Computational Linguistics (Volume 1: Long Papers)*, pages 402–412, Baltimore, Maryland, 2014. Association for Computational Linguistics. URL [www.aclweb.org/anthology/P14-1038](http://www.aclweb.org/anthology/P14-1038). (Cited on pp. 47 and 48.)
- Xiaoya Li, Fan Yin, Zijun Sun, Xiayu Li, Arianna Yuan, Duo Chai, Mingxin Zhou, and Jiwei Li. Entity-Relation Extraction as Multi-Turn Question Answering. In *Proc. 57th Annual Meeting of the Association for Computational Linguistics*, pages 1340–1350, 2019b. URL [www.aclweb.org/anthology/P19-1129](http://www.aclweb.org/anthology/P19-1129). (Cited on p. 54.)
- Yan Liang, Xin Liu, Jianwen Zhang, and Yangqiu Song. Relation Discovery with Out-of-Relation Knowledge Base as Supervision. In *Proc. 2019 Conference of the North American Chapter of the Association for Computational Linguistics: Human Language Technologies, Volume 1 (Long and Short Papers)*, pages 3280–3290, Minneapolis, Minnesota, 2019. Association for Computational Linguistics. URL [www.aclweb.org/anthology/N19-1332](http://www.aclweb.org/anthology/N19-1332). (Cited on p. 56.)
- Marc Light, Eric Brill, Eugene Charniak, Mary Harper, Ellen Riloff, and Ellen Voorhees, editors. *ANLP-NAACL 2000 Workshop: Reading Comprehension Tests as Evaluation for Computer-Based Language Understanding Systems*, 2000. URL [www.aclweb.org/anthology/W00-0600](http://www.aclweb.org/anthology/W00-0600). (Cited on p. 53.)
- Thomas Lin, Oren Etzioni, et al. Entity linking at web scale. In *Proc. Joint Workshop on Automatic Knowledge Base Construction and Web-scale Knowledge Extraction*, pages 84–88. Association for Computational Linguistics, 2012. (Cited on p. 52.)
- Yankai Lin, Zhiyuan Liu, Maosong Sun, Yang Liu, and Xuan Zhu. Learning Entity and Relation Embeddings for Knowledge Graph Completion. In *Proc. Twenty-Ninth AAAI Conference on Artificial Intelligence, AAAI'15*, pages 2181–2187. AAAI Press,

2015. ISBN 0-262-51129-0. URL [dl.acm.org/citation.cfm?id=2886521.2886624](https://dl.acm.org/citation.cfm?id=2886521.2886624). (Cited on p. 38.)

Yankai Lin, Shiqi Shen, Zhiyuan Liu, Huanbo Luan, and Maosong Sun. Neural Relation Extraction with Selective Attention over Instances. In *Proc. 54th Annual Meeting of the Association for Computational Linguistics (Volume 1: Long Papers)*, pages 2124–2133, Berlin, Germany, 2016. Association for Computational Linguistics. URL [www.aclweb.org/anthology/P16-1200](https://www.aclweb.org/anthology/P16-1200). (Cited on p. 34.)

Qi Liu, Maximilian Nickel, and Douwe Kiela. Hyperbolic Graph Neural Networks. In *Advances in Neural Information Processing Systems*, pages 8230–8241, 2019a. (Cited on p. 43.)

Tianyi Liu, Xinsong Zhang, Wanhao Zhou, and Weijia Jia. Neural Relation Extraction via Inner-Sentence Noise Reduction and Transfer Learning. In *Proc. 2018 Conference on Empirical Methods in Natural Language Processing*, pages 2195–2204, Brussels, Belgium, 2018. Association for Computational Linguistics. URL [www.aclweb.org/anthology/D18-1243](https://www.aclweb.org/anthology/D18-1243). (Cited on p. 35.)

Yang Liu, Furu Wei, Sujian Li, Heng Ji, Ming Zhou, and Houfeng Wang. A Dependency-Based Neural Network for Relation Classification. In *Proc. 53rd Annual Meeting of the Association for Computational Linguistics and the 7th International Joint Conference on Natural Language Processing (Volume 2: Short Papers)*, pages 285–290, 2015. URL [www.aclweb.org/anthology/P15-2047](https://www.aclweb.org/anthology/P15-2047). (Cited on pp. 21, 23, 24, and 44.)

Yang Liu, Yifeng Zeng, Yingke Chen, Jing Tang, and Yinghui Pan. Self-Improving Generative Adversarial Reinforcement Learning. In *Proc. 18th International Conference on Autonomous Agents and MultiAgent Systems*, pages 52–60, 2019b. (Cited on p. 36.)

Yinhan Liu, Myle Ott, Naman Goyal, Jingfei Du, Mandar Joshi, Danqi Chen, Omer Levy, Mike Lewis, Luke Zettlemoyer, and Veselin Stoyanov. RoBERTa: A Robustly Optimized BERT Pretraining Approach. *arXiv preprint*, 2019c. URL [arxiv.org/abs/1907.11692](https://arxiv.org/abs/1907.11692). (Cited on p. 10.)

Colin Lockard, Prashant Shiralkar, and Xin Luna Dong. OpenCeres: When Open Information Extraction Meets the Semi-Structured Web. In *Proc. 2019 Conference of the North American Chapter of the Association for Computational Linguistics: Human Language Technologies, Volume 1 (Long and Short Papers)*, pages 3047–3056, Minneapolis, Minnesota, 2019. Association for Computational Linguistics. URL [www.aclweb.org/anthology/N19-1309](https://www.aclweb.org/anthology/N19-1309). (Cited on p. 52.)

Bo Long, Zhongfei (Mark) Zhang, Xiaoyun Wu, and Philip S. Yu. Spectral Clustering for Multi-type Relational Data. In *Proc. 23rd International Conference on Machine*

## 70 BIBLIOGRAPHY

- Learning (ICML '06)*, pages 585–592, 2006. doi: doi.org/10.1145/1143844.1143918. (Cited on pp. 14 and 15.)
- Yi Luan, Dave Wadden, Luheng He, Amy Shah, Mari Ostendorf, and Hannaneh Hajishirzi. A General Framework for Information Extraction using Dynamic Span Graphs. In *Proc. 2019 Conference of the North-American Chapter of the Association for Computational Linguistics: Human Language Technologies, Volume 1 (Long and Short Papers)*, pages 3036–3046, 2019. URL [www.aclweb.org/anthology/N19-1308](http://www.aclweb.org/anthology/N19-1308). (Cited on p. 48.)
- Diego Marcheggiani and Ivan Titov. Discrete-State Variational Autoencoders for Joint Discovery and Factorization of Relations. *Transactions of the Association for Computational Linguistics*, 4:231–244, 2016. doi: 10.1162/tacl\_a\_00095. URL [www.aclweb.org/anthology/Q16-1017](http://www.aclweb.org/anthology/Q16-1017). (Cited on pp. 56 and 57.)
- Bryan McCann, Nitish Shirish Keskar, Caiming Xiong, and Richard Socher. The Natural Language Decathlon: Multitask Learning as Question Answering. *arXiv preprint*, 2018. URL [arxiv.org/abs/1806.08730](http://arxiv.org/abs/1806.08730). (Cited on p. 54.)
- Warren S. McCulloch and Walter H. Pitts. A logical calculus of the ideas immanent in nervous activity. *Bulletin of Mathematical Biophysics*, 5:115–133, 1943. (Cited on p. 1.)
- Tomáš Mikolov, Martin Karafiát, Lukáš Burget, Jan Černocký, and Sanjeev Khudanpur. Recurrent neural network based language model. In *Eleventh annual conference of the international speech communication association*, 2010. (Cited on p. 19.)
- Tomas Mikolov, Kai Chen, Greg Corrado, and Jeffrey Dean. Efficient Estimation of Word Representations in Vector Space. *arXiv preprint*, 2013a. URL [arxiv.org/abs/1301.3781](http://arxiv.org/abs/1301.3781). (Cited on p. 40.)
- Tomas Mikolov, Ilya Sutskever, Kai Chen, Greg S Corrado, and Jeff Dean. Distributed Representations of Words and Phrases and their Compositionality. In C.J.C. Burges, L. Bottou, M. Welling, Z. Ghahramani, and K.Q. Weinberger, editors, *Advances in Neural Information Processing Systems 26*, pages 3111–3119, 2013b. (Cited on p. 8.)
- Tomas Mikolov, Wen-tau Yih, and Geoffrey Zweig. Linguistic Regularities in Continuous Space Word Representations. In *Proc. Conference of the North American Chapter of the Association for Computational Linguistics: Human Language Technologies*, pages 746–751, Atlanta, Georgia, 2013c. (Cited on pp. 1, 8, 9, and 23.)
- Mike Mintz, Steven Bills, Rion Snow, and Dan Jurafsky. Distant supervision for relation extraction without labeled data. In *Proc. Joint Conference of the 47th Annual Meeting*

of the ACL and the 4th International Joint Conference on Natural Language Processing of the AFNLP: Volume 2- Volume 2, ACL '09, pages 1003–1011, 2009. ISBN 978-1-932432-46-6. URL [dl.acm.org/citation.cfm?id=1690219.1690287](http://dl.acm.org/citation.cfm?id=1690219.1690287). (Cited on p. 28.)

Jeff Mitchell and Mirella Lapata. Composition in distributional models of semantics. *Cognitive science*, 34 8:1388–1429, 2010. (Cited on p. 18.)

Makoto Miwa and Mohit Bansal. End-to-End Relation Extraction using LSTMs on Sequences and Tree Structures. In *Proc. 54th Annual Meeting of the Association for Computational Linguistics (Volume 1: Long Papers)*, pages 1105–1116, Berlin, Germany, 2016. Association for Computational Linguistics. URL [www.aclweb.org/anthology/P16-1105](http://www.aclweb.org/anthology/P16-1105). (Cited on pp. 26 and 48.)

Makoto Miwa and Yutaka Sasaki. Modeling Joint Entity and Relation Extraction with Table Representation. In *Proc. 2014 Conference on Empirical Methods in Natural Language Processing (EMNLP)*, pages 1858–1869, Doha, Qatar, 2014. Association for Computational Linguistics. URL [www.aclweb.org/anthology/D14-1200](http://www.aclweb.org/anthology/D14-1200). (Cited on p. 47.)

Arvind Neelakantan, Jeevan Shankar, Alexandre Passos, and Andrew McCallum. Efficient Non-parametric Estimation of Multiple Embeddings per Word in Vector Space. In *Proc. 2014 Conference on Empirical Methods in Natural Language Processing (EMNLP)*, pages 1059–1069, Doha, Qatar, 2014. Association for Computational Linguistics. URL [www.aclweb.org/anthology/D14-1113](http://www.aclweb.org/anthology/D14-1113). (Cited on p. 9.)

Arvind Neelakantan, Benjamin Roth, and Andrew McCallum. Compositional Vector Space Models for Knowledge Base Completion. In *Proc. 53rd Annual Meeting of the Association for Computational Linguistics and the 7th International Joint Conference on Natural Language Processing (Volume 1: Long Papers)*, pages 156–166. Association for Computational Linguistics, 2015. URL [aclweb.org/anthology/P15-1016](http://aclweb.org/anthology/P15-1016). (Cited on p. 40.)

Thien Huu Nguyen and Ralph Grishman. Relation Extraction: Perspective from Convolutional Neural Networks. In *Proc. 1st Workshop on Vector Space Modeling for Natural Language Processing*, pages 39–48, Denver, Colorado, 2015. Association for Computational Linguistics. URL [www.aclweb.org/anthology/W15-1506](http://www.aclweb.org/anthology/W15-1506). (Cited on p. 44.)

Maximilian Nickel and Douwe Kiela. Learning Continuous Hierarchies in the Lorentz Model of Hyperbolic Geometry. *arXiv preprint*, 2018. URL [arXiv.org/abs/1806.03417](http://arXiv.org/abs/1806.03417). (Cited on pp. 10, 43, and 46.)



## 72 BIBLIOGRAPHY

- Maximilian Nickel, Volker Tresp, and Hans-Peter Kriegel. A Three-Way Model for Collective Learning on Multi-Relational Data. In *Proc. ICML*, 2011. (Cited on pp. 4, 10, 38, and 39.)
- Maximilian Nickel, Kevin Murphy, Volker Tresp, and Evgeniy Gabrilovich. A Review of Relational Machine Learning for Knowledge Graphs. *Proc. IEEE*, 104(1):11–33, 2016a. ISSN 0018-9219. doi: 10.1109/JPROC.2015.2483592. (Cited on pp. 12, 13, and 37.)
- Maximilian Nickel, Lorenzo Rosasco, and Tomaso Poggio. Holographic Embeddings of Knowledge Graphs. In *Proc. Thirtieth AAAI Conference on Artificial Intelligence*, AAAI’16, pages 1955–1961. AAAI Press, 2016b. URL [dl.acm.org/citation?id=3016100.3016172](https://dl.acm.org/citation?id=3016100.3016172). (Cited on pp. 12 and 39.)
- Maximilian Nickel and Douwe Kiela. Poincaré embeddings for learning hierarchical representations. In *Advances in neural information processing systems (NIPS-2017)*, pages 6338–6347, 2017. (Cited on pp. 9 and 39.)
- Mathias Niepert. Discriminative Gafman Models. In *Proc. 30th International Conference on Neural Information Processing Systems*, NIPS’16, pages 3413–3421, USA, 2016. Curran Associates Inc. ISBN 978-1-5108-3881-9. URL [dl.acm.org/citation.cfm?id=3157382.3157479](https://dl.acm.org/citation.cfm?id=3157382.3157479). (Cited on p. 42.)
- Madhav Nimishakavi, Uday Singh Saini, and Partha P. Talukdar. Relation Schema Induction using Tensor Factorization with Side Information. *arXiv preprint*, 2016. URL [arxiv.org/abs/1605.04227](https://arxiv.org/abs/1605.04227). (Cited on pp. 51 and 52.)
- Alberto Paccanaro and Geoffrey E. Hinton. Learning Hierarchical Structures with Linear Relational Embedding. In T. G. Dietterich, S. Becker, and Z. Ghahramani, editors, *Advances in Neural Information Processing Systems 14*, pages 857–864. Curran Associates, Inc., 2002. URL [papers.nips.cc/paper/2068-learning-hierarchical-structures-with-linear-relational-embedding.pdf](https://papers.nips.cc/paper/2068-learning-hierarchical-structures-with-linear-relational-embedding.pdf). (Cited on p. 13.)
- Yannis Papanikolaou, Ian Roberts, and Andrea Pierleoni. Deep Bidirectional Transformers for Relation Extraction without Supervision. In *Proc. 2nd Workshop on Deep Learning Approaches for Low-Resource NLP (DeepLo 2019)*, pages 67–75, 2019. URL [www.aclweb.org/anthology/D19-6108](https://www.aclweb.org/anthology/D19-6108). (Cited on p. 57.)
- Nanyun Peng, Hoifung Poon, Chris Quirk, Kristina Toutanova, and Wen-tau Yih. Cross-Sentence N-ary Relation Extraction with Graph LSTMs. *Transactions of the Association for Computational Linguistics*, 5:101–115, 2017. doi: 10.1162/tacl\_a\_00049. URL [www.aclweb.org/anthology/Q17-1008](https://www.aclweb.org/anthology/Q17-1008). (Cited on pp. 26, 27, and 55.)

- Jeffrey Pennington, Richard Socher, and Christopher Manning. Glove: Global Vectors for Word Representation. In *Proc. 2014 Conference on Empirical Methods in Natural Language Processing (EMNLP)*, pages 1532–1543, Doha, Qatar, 2014. Association for Computational Linguistics. URL [www.aclweb.org/anthology/D14-1162](http://www.aclweb.org/anthology/D14-1162). (Cited on p. 9.)
- Bryan Perozzi, Rami Al-Rfou, and Steven Skiena. DeepWalk: Online Learning of Social Representations. In *Proc. 20th ACM SIGKDD International Conference on Knowledge Discovery and Data Mining, KDD '14*, pages 701–710, 2014. ISBN 978-1-4503-2956-9. URL [doi.acm.org/10.1145/2623330.2623732](https://doi.acm.org/10.1145/2623330.2623732). (Cited on pp. 16 and 40.)
- Matthew Peters, Mark Neumann, Mohit Iyyer, Matt Gardner, Christopher Clark, Kenton Lee, and Luke Zettlemoyer. Deep Contextualized Word Representations. In *Proc. 2018 Conference of the North American Chapter of the Association for Computational Linguistics: Human Language Technologies, Volume 1 (Long Papers)*, pages 2227–2237, New Orleans, Louisiana, 2018. Association for Computational Linguistics. URL [www.aclweb.org/anthology/N18-1202](http://www.aclweb.org/anthology/N18-1202). (Cited on p. 10.)
- Mohammad Taher Pilehvar and Nigel Collier. De-Conflated Semantic Representations. In *Proc. 2016 Conference on Empirical Methods in Natural Language Processing*, pages 1680–1690, Austin, Texas, 2016. Association for Computational Linguistics. doi: 10.18653/v1/D16-1174. URL [www.aclweb.org/anthology/D16-1174](http://www.aclweb.org/anthology/D16-1174). (Cited on p. 9.)
- Pengda Qin, Weiran XU, and William Yang Wang. DSGAN: Generative Adversarial Training for Distant Supervision Relation Extraction. In *Proc. 56th Annual Meeting of the Association for Computational Linguistics (Volume 1: Long Papers)*, pages 496–505, Melbourne, Australia, 2018a. Association for Computational Linguistics. URL [www.aclweb.org/anthology/P18-1046](http://www.aclweb.org/anthology/P18-1046). (Cited on p. 33.)
- Pengda Qin, Weiran Xu, and William Yang Wang. Robust Distant Supervision Relation Extraction via Deep Reinforcement Learning. In *Proc. 56th Annual Meeting of the Association for Computational Linguistics (Volume 1: Long Papers)*, pages 2137–2147, Melbourne, Australia, 2018b. Association for Computational Linguistics. URL [www.aclweb.org/anthology/P18-1199](http://www.aclweb.org/anthology/P18-1199). (Cited on p. 36.)
- Ciyang Qing, Ulle Endriss, Raquel Fernández, and Justin Kruger. Empirical analysis of aggregation methods for collective annotation. In *Proc. COLING 2014, the 25th International Conference on Computational Linguistics: Technical Papers*, pages 1533–1542. Dublin City University and Association for Computational Linguistics, 2014. URL [www.aclweb.org/anthology/C14-1145](http://www.aclweb.org/anthology/C14-1145). (Cited on p. 30.)
- Chris Quirk and Hoifung Poon. Distant Supervision for Relation Extraction beyond the Sentence Boundary. In *Proc. 15th Conference of the European Chapter of the*

- Association for Computational Linguistics: Volume 1, Long Papers*, pages 1171–1182, Valencia, Spain, 2017. Association for Computational Linguistics. URL [www.aclweb.org/anthology/E17-1110](http://www.aclweb.org/anthology/E17-1110). (Cited on p. 55.)
- Colin Raffel, Noam Shazeer, Adam Roberts, Katherine Lee, Sharan Narang, Michael Matena, Yanqi Zhou, Wei Li, and Peter J. Liu. Exploring the Limits of Transfer Learning with a Unified Text-to-Text Transformer. *arXiv preprint*, 2019. URL [arxiv.org/abs/1910.10683](https://arxiv.org/abs/1910.10683). (Cited on p. 10.)
- Xiang Ren, Zeqiu Wu, Wenqi He, Meng Qu, Clare R Voss, Heng Ji, Tarek F Abdelzaher, and Jiawei Han. Cotype: Joint extraction of typed entities and relations with knowledge bases. In *Proc. 26th International Conference on World Wide Web*, pages 1015–1024. International World Wide Web Conferences Steering Committee, 2017. (Cited on p. 13.)
- Sebastian Riedel, Limin Yao, and Andrew McCallum. Modeling Relations and Their Mentions Without Labeled Text. In *Proc. 2010 European Conference on Machine Learning and Knowledge Discovery in Databases: Part III, ECML PKDD’10*, pages 148–163, Berlin, Heidelberg, 2010. Springer-Verlag. ISBN 3-642-15938-9, 978-3-642-15938-1. URL [dl.acm.org/citation.cfm?id=1889788.1889799](http://dl.acm.org/citation.cfm?id=1889788.1889799). (Cited on p. 28.)
- Sebastian Riedel, Limin Yao, Andrew McCallum, and M. Benjamin Marlin. Relation Extraction with Matrix Factorization and Universal Schemas. In *Proc. 2013 Conference of the North American Chapter of the Association for Computational Linguistics: Human Language Technologies*, pages 74–84. Association for Computational Linguistics, 2013. URL [aclweb.org/anthology/N13-1008](http://aclweb.org/anthology/N13-1008). (Cited on pp. 17, 51, and 52.)
- Frank. Rosenblatt. The Perceptron: A Probabilistic Model for Information Storage and Organization in The Brain. *Psychological Review*, 65(6):386–408, 1958. (Cited on p. 1.)
- Gaetano Rossiello, Alfio Gliozzo, Robert Farrell, Nicolas Fauceglia, and Michael Glass. Learning Relational Representations by Analogy using Hierarchical Siamese Networks. In *Proc. 2019 Conference of the North American Chapter of the Association for Computational Linguistics: Human Language Technologies, Volume 1 (Long and Short Papers)*, pages 3235–3245, Minneapolis, Minnesota, 2019. Association for Computational Linguistics. URL [www.aclweb.org/anthology/N19-1327](http://www.aclweb.org/anthology/N19-1327). (Cited on p. 45.)
- Dan Roth and Wen-Tau Yih. Global Inference for Entity and Relation Identification via a Linear Programming Formulation. In *Introduction to Statistical Relational Learning*. MIT Press, 2007. (Cited on p. 47.)
- Chengsen Ru, Jintao Tang, Sasha Li, Songxian Xie, and Ting Wang. Using semantic similarity to reduce wrong labels in distant supervision for relation extraction. *Information Processing and Management*, 54(4):593–608, 2018. (Cited on p. 31.)

- David E. Rumelhart, Geoffrey E. Hinton, and Ronald J. Williams. Learning Representations by Back-propagating Errors. *Nature*, 323(6088):533–536, 1986. doi: 10.1038/323533a0. (Cited on pp. 1 and 13.)
- Franco Scarselli, Marco Gori, Ah Chung Tsoi, Markus Hagenbuchner, and Gabriele Monfardini. The Graph Neural Network Model. *IEEE Transactions on Neural Networks and Learning Systems*, 20(1):61–80, 2009. ISSN 1045-9227. URL [dx.doi.org/10.1109/TNN.2008.2005605](https://doi.org/10.1109/TNN.2008.2005605). (Cited on pp. 25, 26, and 41.)
- Michael Schlichtkrull, Thomas N Kipf, Peter Bloem, Rianne Van Den Berg, Ivan Titov, and Max Welling. Modeling relational data with graph convolutional networks. In *European Semantic Web Conference*, pages 593–607. Springer, 2018. (Cited on pp. 42 and 43.)
- Jürgen Schmidhuber. Artificial curiosity based on discovering novel algorithmic predictability through coevolution. In *Proc. 1999 Congress on Evolutionary Computation-CEC99 (Cat. No. 99TH8406)*, volume 3, pages 1612–1618. IEEE, 1999. (Cited on p. 33.)
- Rico Sennrich, Barry Haddow, and Alexandra Birch. Neural Machine Translation of Rare Words with Subword Units. In *Proc. 54th Annual Meeting of the Association for Computational Linguistics (Volume 1: Long Papers)*, pages 1715–1725, 2016. URL [www.aclweb.org/anthology/P16-1162](http://www.aclweb.org/anthology/P16-1162). (Cited on p. 9.)
- Minjoon Seo, Aniruddha Kembhavi, Ali Farhadi, and Hannaneh Hajishirzi. Bidirectional Attention Flow for Machine Comprehension. *arXiv preprint*, 2017. URL [arxiv.org/abs/1611.01603](https://arxiv.org/abs/1611.01603). (Cited on p. 54.)
- Peng Shi and Jimmy Lin. Simple BERT Models for Relation Extraction and Semantic Role Labeling. *arXiv preprint*, 2019. URL [arxiv.org/abs/1904.05255](https://arxiv.org/abs/1904.05255). (Cited on p. 45.)
- Vered Shwartz and Ido Dagan. Paraphrase to Explicate: Revealing Implicit Noun-Compound Relations. In *Proc. 56th Annual Meeting of the Association for Computational Linguistics (Volume 1: Long Papers)*, pages 1200–1211, Melbourne, Australia, 2018. Association for Computational Linguistics. URL [www.aclweb.org/anthology/P18-1111](http://www.aclweb.org/anthology/P18-1111). (Cited on p. 45.)
- Vered Shwartz, Yoav Goldberg, and Ido Dagan. Improving hypernymy detection with an integrated path-based and distributional method. *arXiv preprint*, 2016. URL [arxiv.org/abs/1603.06076](https://arxiv.org/abs/1603.06076). (Cited on p. 46.)

- Ajit Paul Singh and Geoffrey J. Gordon. Relational learning via collective matrix factorization. In *Proc. 14th ACM SIGKDD International Conference on Knowledge Discovery and Data Mining*, 2008. doi: 10.1145/1401890.1401969. (Cited on p. 15.)
- Gaurav Singh and Parminder Bhatia. Relation Extraction using Explicit Context Conditioning. In *Proc. 2019 Conference of the North-American Chapter of the Association for Computational Linguistics: Human Language Technologies, Volume 1 (Long and Short Papers)*, pages 1442–1447, 2019. URL [www.aclweb.org/anthology/N19-1147](http://www.aclweb.org/anthology/N19-1147). (Cited on p. 56.)
- Livio Baldini Soares, Nicholas FitzGerald, Jeffrey Ling, and Tom Kwiatkowski. Matching the Blanks: Distributional Similarity for Relation Learning. In *Proc. 57th Annual Meeting of the Association for Computational Linguistics*, pages 2895–2905, 2019. (Cited on pp. 24 and 25.)
- Richard Socher, Eric H. Huang, Jeffrey Pennington, Andrew Y. Ng, and Christopher D. Manning. Dynamic Pooling and Unfolding Recursive Autoencoders for Paraphrase Detection. In *Proc. 24th International Conference on Neural Information Processing Systems*, NIPS’11, pages 801–809, USA, 2011a. Curran Associates Inc. ISBN 978-1-61839-599-3. URL [dl.acm.org/citation.cfm?id=2986459.2986549](http://dl.acm.org/citation.cfm?id=2986459.2986549). (Cited on p. 27.)
- Richard Socher, Cliff Chiung-Yu Lin, Andrew Y. Ng, and Christopher D. Manning. Parsing Natural Scenes and Natural Language with Recursive Neural Networks. In *Proc. 28th International Conference on Machine Learning*, ICML’11, pages 129–136, USA, 2011b. Omnipress. ISBN 978-1-4503-0619-5. URL [dl.acm.org/citation.cfm?id=3104482.3104499](http://dl.acm.org/citation.cfm?id=3104482.3104499). (Cited on p. 20.)
- Richard Socher, Brody Huval, Christopher D. Manning, and Andrew Y. Ng. Semantic Compositionality Through Recursive Matrix-vector Spaces. In *Proc. 2012 Joint Conference on Empirical Methods in Natural Language Processing and Computational Natural Language Learning*, EMNLP-CoNLL ’12, pages 1201–1211, Stroudsburg, PA, USA, 2012. Association for Computational Linguistics. URL [dl.acm.org/citation.cfm?id=2390948.2391084](http://dl.acm.org/citation.cfm?id=2390948.2391084). (Cited on p. 23.)
- Richard Socher, Danqi Chen, Christopher D Manning, and Andrew Ng. Reasoning With Neural Tensor Networks for Knowledge Base Completion. In C. J. C. Burges, L. Bottou, M. Welling, Z. Ghahramani, and K. Q. Weinberger, editors, *Advances in Neural Information Processing Systems 26*, pages 926–934. Curran Associates, Inc., 2013. URL [papers.nips.cc/paper/5028-reasoning-with-neural-tensor-networks-for-knowledge-base-completion.pdf](http://papers.nips.cc/paper/5028-reasoning-with-neural-tensor-networks-for-knowledge-base-completion.pdf). (Cited on p. 38.)

- Nitish Srivastava, Geoffrey Hinton, Alex Krizhevsky, Ilya Sutskever, and Ruslan Salakhutdinov. Dropout: A Simple Way to Prevent Neural Networks from Overfitting. *Journal of Machine Learning Research*, 15(56):1929–1958, 2014. URL [jmlr.org/papers/v15/srivastava14a.html](http://jmlr.org/papers/v15/srivastava14a.html). (Cited on p. 5.)
- M. Steyvers and T. Griffiths. Probabilistic topic models. In *Latent Semantic Analysis: A Road to Meaning*. Lawrence Erlbaum, 2006. (Cited on p. 7.)
- Sen Su, Ningning Jia, Xiang Cheng, Shuguang Zhu, and Ruiping Li. Exploring Encoder-Decoder Model for Distant Supervised Relation Extraction. In *Proc. Twenty-Seventh International Joint Conference on Artificial Intelligence (IJCAI-18)*, pages 4389–4395, 2018. (Cited on p. 31.)
- Shaohua Sun, Ni Lao, Rahul Gupta, and Dave Orr. 50,000 Lessons on How to Read: a Relation Extraction Corpus, 2013. URL [research.googleblog.com/2013/04/50000-lessons-on-how-to-read-relation.html](http://research.googleblog.com/2013/04/50000-lessons-on-how-to-read-relation.html). (Cited on p. 27.)
- Mihai Surdeanu, Julie Tibshirani, Ramesh Nallapati, and Christopher D. Manning. Multi-instance Multi-label Learning for Relation Extraction. In *Proc. 2012 Joint Conference on Empirical Methods in Natural Language Processing and Computational Natural Language Learning, EMNLP-CoNLL '12*, pages 455–465, Stroudsburg, PA, USA, 2012. Association for Computational Linguistics. URL [dl.acm.org/citation.cfm?id=2390948.2391003](http://dl.acm.org/citation.cfm?id=2390948.2391003). (Cited on p. 31.)
- Ilya Sutskever and Geoffrey E. Hinton. Using matrices to model symbolic relationship. In D. Koller, D. Schuurmans, Y. Bengio, and L. Bottou, editors, *Advances in Neural Information Processing Systems 21*, pages 1593–1600. Curran Associates, Inc., 2009. URL [papers.nips.cc/paper/3482-using-matrices-to-model-symbolic-relationship.pdf](http://papers.nips.cc/paper/3482-using-matrices-to-model-symbolic-relationship.pdf). (Cited on p. 15.)
- Ryo Takahashi, Ran Tian, and Kentaro Inui. Interpretable and Compositional Relation Learning by Joint Training with an Autoencoder. In *Proc. 56th Annual Meeting of the Association for Computational Linguistics (Volume 1: Long Papers)*, pages 2148–2159, Melbourne, Australia, 2018. Association for Computational Linguistics. URL [www.aclweb.org/anthology/P18-1200](http://www.aclweb.org/anthology/P18-1200). (Cited on p. 40.)
- Kristina Toutanova, Danqi Chen, Patrick Pantel, Hoifung Poon, Pallavi Choudhury, and Michael Gamon. Representing Text for Joint Embedding of Text and Knowledge Bases. In *Proc. 2015 Conference on Empirical Methods in Natural Language Processing*, pages 1499–1509, Lisbon, Portugal, 2015. Association for Computational Linguistics. URL [www.aclweb.org/anthology/D15-1174](http://www.aclweb.org/anthology/D15-1174). (Cited on pp. 17 and 50.)

- Kristina Toutanova, Victoria Lin, Wen-tau Yih, Hoifung Poon, and Chris Quirk. Compositional Learning of Embeddings for Relation Paths in Knowledge Base and Text. In *Proc. 54th Annual Meeting of the Association for Computational Linguistics (Volume 1: Long Papers)*, pages 1434–1444. Association for Computational Linguistics, 2016. URL [www.aclweb.org/anthology/P16-1136](http://www.aclweb.org/anthology/P16-1136). (Cited on p. 51.)
- Théo Trouillon, Christopher R Dance, Johannes Welbl, Sebastian Riedel, Éric Gaussier, and Guillaume Bouchard. Knowledge Graph Completion via Complex Tensor Factorization. *arXiv preprint*, 2017. URL [arxiv.org/abs/1702.06879](http://arxiv.org/abs/1702.06879). (Cited on pp. 27 and 39.)
- Shikhar Vashishth, Rishabh Joshi, Sai Suman Prayaga, Chiranjib Bhattacharyya, and Partha Talukdar. RESIDE: Improving Distantly-Supervised Neural Relation Extraction using Side Information. In *Proc. 2018 Conference on Empirical Methods in Natural Language Processing*, pages 1257–1266, Brussels, Belgium, 2018. Association for Computational Linguistics. URL [www.aclweb.org/anthology/D18-1157](http://www.aclweb.org/anthology/D18-1157). (Cited on p. 32.)
- Patrick Verga, David Belanger, Emma Strubell, Benjamin Roth, and Andrew McCallum. Multilingual Relation Extraction using Compositional Universal Schema. In *Proc. 2016 Conference of the North American Chapter of the Association for Computational Linguistics: Human Language Technologies*, pages 886–896, 2016. URL [aclweb.org/anthology/N16-1103](http://aclweb.org/anthology/N16-1103). (Cited on p. 52.)
- Patrick Verga, Arvind Neelakantan, and Andrew McCallum. Generalizing to Unseen Entities and Entity Pairs with Rowless Universal Schema. In *Proc. 15th Conference of the European Chapter of the Association for Computational Linguistics: Volume 1, Long Papers*, pages 613–622, Valencia, Spain, 2017. URL [www.aclweb.org/anthology/E17-1058](http://www.aclweb.org/anthology/E17-1058). (Cited on p. 52.)
- Patrick Verga, Emma Strubell, and Andrew McCallum. Simultaneously Self-Attending to All Mentions for Full-Abstract Biological Relation Extraction. In *Proc. 2018 Conference of the North American Chapter of the Association for Computational Linguistics: Human Language Technologies, Volume 1 (Long Papers)*, pages 872–884, 2018. URL [www.aclweb.org/anthology/N18-1080](http://www.aclweb.org/anthology/N18-1080). (Cited on pp. 55 and 56.)
- David Wadden, Ulme Wennberg, Yi Luan, and Hannaneh Hajishirzi. Entity, Relation, and Event Extraction with Contextualized Span Representations. In *Proc 2019 Conference on Empirical Methods in Natural Language Processing and the 9th International Joint Conference on Natural Language Processing (EMNLP-IJCNLP)*, pages 5784–5789, 2019. URL [www.aclweb.org/anthology/D19-1585](http://www.aclweb.org/anthology/D19-1585). (Cited on p. 48.)

- Guanying Wang, Wen Zhang, Ruoxu Wang, Yalin Zhou, Xi Chen, Wei Zhang, Hai Zhu, and Huajun Chen. Label-Free Distant Supervision for Relation Extraction via Knowledge Graph Embedding. In *Proc. 2018 Conference on Empirical Methods in Natural Language Processing*, pages 2246–2255, Brussels, Belgium, 2018. Association for Computational Linguistics. URL [www.aclweb.org/anthology/D18-1248](http://www.aclweb.org/anthology/D18-1248). (Cited on p. 32.)
- Hai Wang and Hoifung Poon. Deep Probabilistic Logic: A Unifying Framework for Indirect Supervision. In *Proc. 2018 Conference on Empirical Methods in Natural Language Processing*, pages 1891–1902, Brussels, Belgium, 2018. Association for Computational Linguistics. URL [www.aclweb.org/anthology/D18-1215](http://www.aclweb.org/anthology/D18-1215). (Cited on p. 55.)
- Haoyu Wang, Vivek Kulkarni, and William Yang Wang. Dolores: Deep Contextualized Knowledge Graph Embeddings. In *Automated Knowledge Base Construction*, 2020. URL [openreview.net/forum?id=ajrveGQB10](https://openreview.net/forum?id=ajrveGQB10). (Cited on p. 16.)
- Hong Wang, Wenhan Xiong, Mo Yu, Xiaoxiao Guo, Shiyu Chang, and William Yang Wang. Sentence Embedding Alignment for Lifelong Relation Extraction. In *Proc. 2019 Conference of the North American Chapter of the Association for Computational Linguistics: Human Language Technologies, Volume 1 (Long and Short Papers)*, pages 796–806, Minneapolis, Minnesota, 2019. Association for Computational Linguistics. URL [www.aclweb.org/anthology/N19-1086](http://www.aclweb.org/anthology/N19-1086). (Cited on p. 57.)
- Quan Wang, Zhendong Mao, Bin Wang, and Li Guo. Knowledge Graph Embedding: A Survey of Approaches and Applications. *IEEE Transactions on Knowledge and Data Engineering*, 29(12):2724–2743, 2017. ISSN 1041-4347. doi: 10.1109/TKDE.2017.2754499. (Cited on pp. 12, 37, and 39.)
- Zhen Wang, Jianwen Zhang, Jianlin Feng, and Zheng Chen. Knowledge graph embedding by translating on hyperplanes. In *Twenty-Eighth AAAI conference on artificial intelligence*, 2014. (Cited on p. 38.)
- Melanie Weber and Maximilian Nickel. Curvature and Representation Learning: Identifying Embedding Spaces for Relational Data. *NeurIPS Relational Representation Learning*, 2018. (Cited on pp. 15 and 16.)
- Jason Weston, Antoine Bordes, Oksana Yakhnenko, and Nicolas Usunier. Connecting Language and Knowledge Bases with Embedding Models for Relation Extraction. In *Proc. 2013 Conference on Empirical Methods in Natural Language Processing*, pages 1366–1371. Association for Computational Linguistics, 2013. URL [www.aclweb.org/anthology/D13-1136](http://www.aclweb.org/anthology/D13-1136). (Cited on p. 53.)



- Han Xiao, Minlie Huang, and Xiaoyan Zhu. Transg: A generative model for knowledge graph embedding. In *Proc. 54th Annual Meeting of the Association for Computational Linguistics (Volume 1: Long Papers)*, volume 1, pages 2316–2325, 2016. (Cited on pp. 38 and 39.)
- Ruobing Xie, Zhiyuan Liu, Jia Jia, Huanbo Luan, and Maosong Sun. Representation learning of knowledge graphs with entity descriptions. In *Proc. AAAI-2016*, pages 2659–2665, 2016. (Cited on p. 53.)
- Kun Xu, Yansong Feng, Songfang Huang, and Dongyan Zhao. Semantic Relation Classification via Convolutional Neural Networks with Simple Negative Sampling. *arXiv preprint*, 2015. URL [arxiv.org/abs/1506.07650](https://arxiv.org/abs/1506.07650). (Cited on p. 48.)
- Yan Xu, Ran Jia, Lili Mou, Ge Li, Yunchuan Chen, Yangyang Lu, and Zhi Jin. Improved relation classification by deep recurrent neural networks with data augmentation. In *Proc. COLING 2016, the 26th International Conference on Computational Linguistics: Technical Papers*, pages 1461–1470, Osaka, Japan, 2016. The COLING 2016 Organizing Committee. URL [www.aclweb.org/anthology/C16-1138](http://www.aclweb.org/anthology/C16-1138). (Cited on pp. 21, 22, and 44.)
- Bishan Yang, Wen-tau Yih, Xiaodong He, Jianfeng Gao, and Li Deng. Embedding entities and relations for learning and inference in knowledge bases. In *Proc. 2015 International Conference on Representation Learning*, 2015. (Cited on pp. 38 and 39.)
- Kaijia Yang, Liang He, Xin-yu Dai, Shujian Huang, and Jiajun Chen. Exploiting Noisy Data in Distant Supervision Relation Classification. In *Proc. 2019 Conference of the North American Chapter of the Association for Computational Linguistics: Human Language Technologies, Volume 1 (Long and Short Papers)*, pages 3216–3225, Minneapolis, Minnesota, 2019. Association for Computational Linguistics. URL [www.aclweb.org/anthology/N19-1325](http://www.aclweb.org/anthology/N19-1325). (Cited on p. 36.)
- Yuan Yao, Deming Ye, Peng Li, Xu Han, Yankai Lin, Zhenghao Liu, Zhiyuan Liu, Lixin Huang, Jie Zhou, and Maosong Sun. DocRED: A Large-Scale Document-Level Relation Extraction Dataset. In *Proc. ACL 2019*, pages 764–777, 2019. (Cited on p. 28.)
- Zhi-Xiu Ye and Zhen-Hua Ling. Distant Supervision Relation Extraction with Intra-Bag and Inter-Bag Attentions. In *Proc. 2019 Conference of the North American Chapter of the Association for Computational Linguistics: Human Language Technologies, Volume 1 (Long and Short Papers)*, pages 2810–2819, Minneapolis, Minnesota, 2019. Association for Computational Linguistics. URL [www.aclweb.org/anthology/N19-1288](http://www.aclweb.org/anthology/N19-1288). (Cited on p. 34.)

- Daojian Zeng, Kang Liu, Siwei Lai, Guangyou Zhou, Jun Zhao, et al. Relation Classification via Convolutional Deep Neural Network. In *COLING*, pages 2335–2344, 2014. (Cited on p. 44.)
- Daojian Zeng, Kang Liu, Yubo Chen, and Jun Zhao. Distant Supervision for Relation Extraction via Piecewise Convolutional Neural Networks . In *Proc. 2015 Conference on Empirical Methods in Natural Language Processing* , pages 1753–1762. Association for Computational Linguistics, 2015. URL [aclweb.org/anthology/D15-1203](http://aclweb.org/anthology/D15-1203). (Cited on p. 31.)
- Xiangrong Zeng, Daojian Zeng, Shizhu He, Kang Liu, and Jun Zhao. Extracting Relational Facts by an End-to-End Neural Model with Copy Mechanism. In *Proc. 56th Annual Meeting of the Association for Computational Linguistics (Volume 1: Long Papers)*, pages 506–514, Melbourne, Australia, 2018. Association for Computational Linguistics. URL [www.aclweb.org/anthology/P18-1047](http://www.aclweb.org/anthology/P18-1047). (Cited on pp. 48 and 49.)
- Dongxu Zhang, Subhabrata Mukherjee, Colin Lockard, Luna Dong, and Andrew McCallum. OpenKI: Integrating Open Information Extraction and Knowledge Bases with Relation Inference. In *Proc. 2019 Conference of the North American Chapter of the Association for Computational Linguistics: Human Language Technologies, Volume 1 (Long and Short Papers)*, pages 762–772, Minneapolis, Minnesota, 2019a. Association for Computational Linguistics. doi: 10.18653/v1/N19-1083. URL [www.aclweb.org/anthology/N19-1083](http://www.aclweb.org/anthology/N19-1083). (Cited on p. 52.)
- Ningyu Zhang, Shumin Deng, Zhanlin Sun, Guanying Wang, Xi Chen, Wei Zhang, and Huajun Chen. Long-tail Relation Extraction via Knowledge Graph Embeddings and Graph Convolution Networks. In *Proc. 2019 Conference of the North American Chapter of the Association for Computational Linguistics: Human Language Technologies, Volume 1 (Long and Short Papers)*, pages 3016–3025, Minneapolis, Minnesota, 2019b. Association for Computational Linguistics. (Cited on pp. 43 and 53.)
- Yuhao Zhang, Victor Zhong, Danqi Chen, Gabor Angeli, and Christopher D. Manning. Position-aware Attention and Supervised Data Improve Slot Filling. In *Proc. 2017 Conference on Empirical Methods in Natural Language Processing (EMNLP 2017)*, pages 35–45, 2017. URL [nlp.stanford.edu/pubs/zhang2017tacred.pdf](http://nlp.stanford.edu/pubs/zhang2017tacred.pdf). (Cited on p. 28.)
- Yuhao Zhang, Peng Qi, and Christopher D. Manning. Graph Convolution over Pruned Dependency Trees Improves Relation Extraction. In *Proc. 2018 Conference on Empirical Methods in Natural Language Processing*, pages 2205–2215, Brussels, Belgium, 2018. Association for Computational Linguistics. doi: 10.18653/v1/D18-1244. (Cited on p. 26.)

- Suncong Zheng, Jiaming Xu, Peng Zhou, Hongyun Bao, Zhenyu Qi, and Bo Xu. A neural network framework for relation extraction: Learning entity semantic and relation pattern. *Knowledge-Based Systems*, 114:12–23, 2016. ISSN 0950-7051. doi: doi.org/10.1016/j.knosys.2016.09.019. URL [www.sciencedirect.com/science/article/pii/S0950705116303501](http://www.sciencedirect.com/science/article/pii/S0950705116303501). (Cited on p. 45.)
- Suncong Zheng, Feng Wang, Hongyun Bao, Yuexing Hao, Peng Zhou, and Bo Xu. Joint Extraction of Entities and Relations Based on a Novel Tagging Scheme. In *Proc. 55th Annual Meeting of the Association for Computational Linguistics (Volume 1: Long Papers)*, pages 1227–1236, Vancouver, Canada, 2017. Association for Computational Linguistics. doi: 10.18653/v1/P17-1113. URL [www.aclweb.org/anthology/P17-1113](http://www.aclweb.org/anthology/P17-1113). (Cited on p. 47.)
- Jie Zhou, Ganqu Cui, Zhengyan Zhang, Cheng Yang, Zhiyuan Liu, and Maosong Sun. Graph Neural Networks: A Review of Methods and Applications. *arXiv preprint*, 2018. URL [arxiv.org/abs/1812.08434](http://arxiv.org/abs/1812.08434). (Cited on pp. 26 and 41.)
- Yan Zhou, Murat Kantarcioglu, Bhavani Thuraisingham, and Bowei Xi. Adversarial Support Vector Machine Learning. In *Proc. 18th ACM SIGKDD International Conference on Knowledge Discovery and Data Mining*, KDD '12, pages 1059–1067, 2012. ISBN 978-1-4503-1462-6. URL [doi.acm.org/10.1145/2339530.2339697](http://doi.acm.org/10.1145/2339530.2339697). (Cited on p. 33.)

# Index

- adjacency matrix, 10–13, 17, 40
- argument type, 47
- attention, 5, 10, 22, 32, 34, 35, 52, 54–56
- Automatic Content Extraction (ACE), 48
- Bidirectional Encoder Representations from Transformers (BERT), 4, 10, 25, 45, 57
- cluster, clustering, 14, 15, 46, 49, 51, 56, 57
- compositionality, 18, 21–23, 44, 45
- context representation, 2, 21, 26, 44–46
- convolutional neural network (CNN), 4, 17, 18, 22, 31, 34, 36, 41, 44, 45, 48, 50, 51, 53
- Cyc, 30
- DBpedia, 29, 30
- dependency, 26, 55
  - dependency graph, 26, 49, 50
  - dependency parsing, 29, 49
  - dependency path, 18, 21, 22, 24, 26, 45, 46, 50
    - augmented dependency path, 21, 22, 24, 26
  - dependency relation, 21, 23, 24, 42, 46, 48, 50
  - dependency tree, 26, 48
- distributional representation, 6, 10, 16, 18
- embedding
  - contextualized embedding, 10, 45, 53
  - embedding space, 15, 16, 23, 38, 45, 46, 57
  - graph embedding, 11, 13, 15, 16, 37–39, 41, 50, 51
  - hyperbolic space embedding, 9, 15, 39, 43, 46
  - relation embedding, 3, 10, 13, 16, 17, 32, 38, 50, 53
  - sentence embedding, 32, 57
  - word-sense embedding, 9
  - word/entity embedding, 3, 4, 6, 8–10, 16, 17, 19, 20, 23, 32, 34, 38, 41, 44–46, 53, 55, 56
- entity mention span, 28, 47, 48, 54
- feature
  - attributional feature, 2
  - feature vector, 2, 8, 42
  - relational feature, 2, 5, 18, 21
- Freebase, 13, 14, 27, 28, 30–33, 35, 42, 43, 49, 52, 53
- generative adversarial network (GAN), 27, 32
- graph
  - dependency graph, 26, 49, 50
  - directed acyclic graph (DAG), 25, 26
  - knowledge graph (KG), 2, 5, 10–17, 26–28, 30–32, 37–43, 49, 50, 52, 53

- graph convolution network (GCN), 32, 42, 43, 53
- graph neural network (GNN), 18, 25, 26, 37, 41–43
- hyperbolic graph convolution network (HGCN), 43
- kernel
  - convolution kernel, 18
  - tree kernel, 18
- knowledge base (KB), 17, 31, 51, 53, 55, 56
  - knowledge base population (KBP), 28
- knowledge repository, 17, 30, 49–52, 58
- learning
  - adversarial learning, 27, 32, 35, 58
  - distant supervision, 2, 25, 27, 28, 30–35, 49, 57, 58
  - learning algorithm, 1, 3
  - reinforcement learning, 27, 35, 36, 58
  - unsupervised learning, 37, 56
- link prediction, 16, 27, 28, 37, 38, 40, 41, 43, 53
- LSTM
  - bidirectional LSTM, 4, 10, 16, 26, 48, 55
  - graph LSTM, 26
  - tree-structured LSTM-RNN, 26
- matrix factorization, 10, 12–15, 40, 43, 51, 53
- named entity, 47
- Never-Ending Language Learner (NELL), 13, 14, 27, 42
- open information extraction, 17
- paraphrase, 45
- parsing
  - dependency parsing, 29, 49
  - dependency tree, 26, 48
- pattern, 18, 25, 34, 41, 42, 44–46, 49, 51, 52, 56, 58
  - Hearst pattern, 46, 51, 52
- question answering, 53, 54
- recurrent neural network (RNN), 4, 18–22, 40, 46, 48
- recursive neural network, 18, 20, 23, 25
- relation
  - discourse relation, 26, 55
  - hypernymy, 21, 22, 46, 51
  - hyponymy, 46, 51
  - is-a relation, 39, 46
  - paradigmatic relation, 16
  - relation classification, 5, 18, 20, 25, 27, 29, 33, 36, 43–45, 47–49, 53–55, 57
  - relation embedding, 3, 10, 13, 16, 17, 32, 38, 50, 53
  - relation extraction, 18, 27, 29, 30, 35, 37, 43, 46–49, 53–57
  - relation inventory, 2
  - synonymy, 55
  - syntagmatic relation, 16
  - targeted relation, 24, 31, 56, 57
- scoring function, 3, 10–13, 15, 17, 37–39, 41, 52, 53
- semantic representation, 1, 18, 22, 31, 50, 56
- SemEval, 48
- sequential labelling, 47, 48
- Support Vector Machine (SVM), 55
- tensor, 11, 12, 38, 39, 52, 56
- universal schema, 51, 52, 55

Wikidata, 27–30  
Wikipedia, 28, 29, 34, 35  
    Wikipedia infobox, 27

WordNet, 9, 10, 21, 22, 27, 39

YAGO, 30