

COLOURED REFINED TOPOLOGICAL VERTICES AND PARAFERMION CONFORMAL FIELD THEORIES

WEE CHAIMANOWONG AND OMAR FODA

To Professor Mikio Sato on his 90th birthday

ABSTRACT. We extend the definition of the refined topological vertex C to an n -coloured refined topological vertex C_n that depends on n free bosons, and compute the 5D strip partition function made of N pairs of C_n vertices and conjugate C_n^* vertices. Using geometric engineering and the AGT correspondence, the 4D limit of this strip partition function is identified with a (normalized) matrix element of a (primary state) vertex operator that intertwines two (arbitrary descendant) states in a (generically non-rational) 2D conformal field theory with \mathbb{Z}_n parafermion primary states.

1. INTRODUCTION

1.1. **Background.** In a 2D conformal field theory, a correlation function is a sum of (or an integral over) products of holomorphic and anti-holomorphic conformal blocks. Methods to compute the conformal block include **1.** making use of a null state that flows in an internal channel in the block to derive and solve a differential equation for the block [16], **2.** representing the conformal block in terms of a Coulomb gas of charges with a background charge and screening charges, then evaluating the conformal block as an integral over the positions of screening charges [42, 23, 24], and **3.** using the analytic properties of the conformal block to derive and solve a recursion relation that can be solved for the block [49, 50]. These methods are powerful and lead to deep insights into the analytic structure of the conformal blocks, but they are also non-algorithmic in the sense that the answer cannot (in general) be written explicitly and directly, and become complicated to apply in the presence of vertex operators of a sufficiently-large highest-weight charge ¹, and for 5- and higher-point conformal blocks ².

1.2. **Conformal blocks as products of normalized matrix elements.** An algorithmic approach to computing the conformal blocks is to regard them as products of matrix elements \mathcal{M}^{2D} of primary-state vertex operators between arbitrary descendant states, these being normalized by Shapovalov matrix elements. However, no closed-form expressions for these matrix elements are known ³.

1.3. **From 2D conformal blocks to 4D instanton partition functions.** An approach to compute the normalized matrix elements \mathcal{M}^{2D} in closed form is the AGT correspondence [2, 40, 47], which applies to $\mathcal{W}_N \times \mathcal{H}$ conformal field theories, where the \mathcal{W}_N algebra, generated by chiral spin-2, spin-3, \dots , spin- N currents, is augmented by a Heisenberg algebra \mathcal{H} generated by a chiral spin-1 current ⁴. The AGT correspondence identifies matrix element \mathcal{M}^{2D} in 2D $\mathcal{W}_N \times \mathcal{H}$ conformal field theories and

Key words and phrases. Refined topological vertex. Minimal conformal field theories.

¹ Vertex operators that require multiple screening charges in the Coulomb gas approach.

² The more powerful (elliptic) version of the recursion relation is available only for 4-point conformal blocks [50, 45].

³ In \mathcal{W}_2 conformal field theories, the Virasoro algebra \mathcal{W}_2 provides sufficiently-many constraints to allow us to compute any Virasoro matrix element on an element-by-element basis, but in \mathcal{W}_N theories, $N = 3, 4, \dots$, more conditions than those provided by the \mathcal{W}_N algebra are required [35], and the computation of the matrix elements, while still on an element-by-element basis, is more complicated than in the \mathcal{W}_2 case.

⁴ The contributions of the \mathcal{H} algebra factor out in the result of conformal block computations in $\mathcal{W}_N \times \mathcal{H}$ theories, and one obtains conformal blocks in \mathcal{W}_N theories.

instanton partition functions \mathcal{Z}_N^{4D} , in 4D $\mathcal{N} = 2$ supersymmetric Yang-Mills theories with matter in bifundamental $SU(N)$ representations.

1.4. From 4D instanton partition functions to 5D strip partition functions. The 4D instanton partition function \mathcal{Z}_N^{4D} is engineered by taking the 4D limit of a 5D topological string strip partition function \mathcal{S}_N^{5D} [36, 37], obtained by gluing topological vertices [29, 1, 7, 8, 31, 30]. In this sense, a topological vertex is the most fundamental building block of the correlation functions in a 2D conformal field theory.

1.5. 2D parafermion conformal field theories. In [3, 4, 10–13, 15, 17, 19, 20, 33, 43, 46, 48], and other works, 4D instanton partition functions on $\mathbb{C}^2/\mathbb{Z}_n$ were related⁵, using an extension of the AGT correspondence, to matrix elements in non-rational 2D conformal field theories based on the algebra $\mathcal{A}(N, n) = \left(\widehat{sl}(N)_n \times \widehat{sl}(N)_p / \widehat{sl}(N)_{n+p} \right) \times \widehat{sl}(n)_N \times \mathcal{H}$ ⁶. However, no connection with 5D topological string partition functions and topological vertices was made.

1.6. In this work. 1. We propose an extension of the refined topological vertex C of [31], constructed using a single free boson, to a refined topological vertex C_n constructed using n free bosons, and a conjugate vertex C_n^* . **2.** We compute $\mathcal{S}_{N,n}^{5D}$, the 5D topological string strip partition function that consists of N pairs of vertices where each pair consists of a single C_n vertex and a single C_n^* . **3.** We take the 4D limit of $\mathcal{S}_{N,n}^{5D}$ to obtain $\mathcal{S}_{N,n}^{4D}$, and identify the result, using geometric engineering [36, 37], with $\mathcal{Z}_{N,n}^{4D}$, the 4D instanton partition function of matter in a bifundamental representation of $SU(N)$ in $\mathbb{C}^4/\mathbb{Z}_n$. **4.** We use the AGT correspondence, as defined in [3, 4, 10–13, 15, 17, 19, 20, 46, 48], to identify $\mathcal{Z}_{N,n}^{4D}$ with a matrix element $\mathcal{M}_{\mathcal{A}(N,n)}^{2D}(\alpha_L, \alpha, \alpha_R)$ of a primary vertex operator that carries a highest-weight charge α between left and right states, $\langle \alpha_L |$ and $|\alpha_R\rangle$, where $\langle \alpha_L |$ and $|\alpha_R\rangle$ are arbitrary descendant states. **5.** We obtain the linear relation between the Kähler parameters of the 5D instanton partition function and the parameters of the corresponding $\mathcal{A}(N, n)$ matrix element, **6.** We discuss in detail the differences in normalizations of these objects, and show that these differences cancel out when gluing matrix elements to compute conformal blocks.

1.7. Outline of contents. In section **2**, we recall the combinatorics of partitions and Young diagrams that is used in the sequel, and then in Section **3**, we do the same for symmetric functions in infinitely-many variables, with emphasis on the Schur functions, Heisenberg algebras, and correspondences between them. In **4**, we introduce the n -coloured refined topological vertex C_n , and the conjugate vertex C_n^* . In **5**, we compute $\mathcal{S}_{N,n}^{5D}$, the 5D $SU(N)$ topological string strip partition function made of N pairs of vertices. In **6**, we compute $\mathcal{S}_{N,n}^{4D}$, the 4D limit of $\mathcal{S}_{N,n}^{5D}$, and identify it with the 4D instanton partition function $\mathcal{Z}_{N,n}^{4D}$. In **7**, we use the 5D strips to compute 5D web diagrams, and then in **8**, we take the 4D limit of the 5D web diagrams. In **9**, we reproduce a 4-point conformal block computed in [4], and in **10**, we make a number of comments.

⁵ The action of \mathbb{Z}_n on $\mathbb{C}^2 = \mathbb{C}_1 \times \mathbb{C}_2$ is $(z_1, z_2) \mapsto (\omega z_1, \omega^{-1} z_2)$, where $z_1 \in \mathbb{C}_1, z_2 \in \mathbb{C}_2, \omega^n = 1$ [11]

⁶ Our notation for $\mathcal{A}(N, n)$ is adapted to that used in the present work and as such it differs, in an obvious way, from that used in the original papers. Further, we stress that the discussion of the conformal field theories in the original papers on the subject, and definitely in the present work, is restricted to non-rational conformal field theories. The space of states in rational theories based on $\mathcal{A}(N, n)$ contains degenerate representations with null states that require special treatment.

2. YOUNG AND MAYA DIAGRAMS

2.1. Young diagrams. A partition $Y = (y_1, y_2, \dots)$, of a non-negative integer $|Y|$, is a set of non-negative, non-increasing integers $y_i \geq y_{i+1} \geq 0$, $\sum_{i=1}^{\infty} y_i = |Y|$, and can be represented as a Young diagram, that consists of rows such that row i has y_i cells (see Figure 2.1). We use y_i for the i -th row as well as for the number of cells in that row, and Y^\top for the transpose of Y . In this work, a Young diagram has infinitely-many rows. By a finite Young diagram, we mean a Young diagram that has finitely many non-null rows. The null Young diagram $Y = \emptyset$ is such that all rows are null. Given a set of n Young diagrams $\mathbf{Y} = (Y_1, \dots, Y_n)$, define

$$(2.1) \quad |\mathbf{Y}| = \sum_{i=1}^n |Y_i|, \quad \mathbf{Y}^\top = (Y_1^\top, \dots, Y_n^\top)$$

2.1.1. The (infinite) borderline of a (finite) Young diagram. The union of the positive x -axis and the negative y -axis, that is the borderline of the south-east quadrant, is the borderline of the null Young diagram $Y = \emptyset$. The (infinite) borderline of a (finite) Young diagram is the union of the right vertical boundaries of the right-most cells of each row, the lower horizontal boundaries of the bottom cells of each column, the semi-infinite segment of the positive x -axis to the right, and the semi-infinite segment of the negative y -axis below the Young diagram, as in Figure 2.1.

2.1.2. Cells. We use \square for a cell (a square) in the south-east quadrant of the plane, and refer to the coordinates of \square as (i, j) . If $\square \in Y$, then i is the Y -row-number, counted from top to bottom, and j is the Y -column-number, counted from left to right, that \square lies in. If $\square \notin Y$, we still regard i (j) as a Y -row-number (Y -column-number) albeit that row (column) is null. In other words, the coordinates (i, j) of a cell are measured with respect to the (original) boundaries of the south-east quadrant, rather than with respect to the borderline of any specific Young diagram.

2.1.3. Arms, legs, and hooks. Consider a cell \square with coordinates (i, j) . We define the lengths of the arm $A_{\square, Y}$, half-extended arm $A_{\square, Y}^+$, extended arm $A_{\square, Y}^{++}$, the leg $L_{\square, Y}$, half-extended leg $L_{\square, Y}^+$, extended leg $L_{\square, Y}^{++}$, of \square with respect to the Young diagram Y ,

$$(2.2) \quad A_{\square, Y} = y_i - j, \quad A_{\square, Y}^+ = A_{\square, Y} + \frac{1}{2}, \quad A_{\square, Y}^{++} = A_{\square, Y} + 1,$$

$$(2.3) \quad L_{\square, Y} = y_j^\top - i, \quad L_{\square, Y}^+ = L_{\square, Y} + \frac{1}{2}, \quad L_{\square, Y}^{++} = L_{\square, Y} + 1$$

Note that $A_{\square, Y}$ and $L_{\square, Y}$ are negative when $\square \notin Y$. The hook of a cell \square , with respect to the borderline of a Young diagram Y is,

$$(2.4) \quad H_\square = A_{\square, Y} + L_{\square, Y} + 1$$

2.1.4. Charged Young diagrams. We define a charged Young diagram as a pair (Y, c_Y) , where Y is a finite Young diagram and $c_Y \in \mathbb{Z}$ is the charge.

2.2. Maya diagrams. A Maya diagram is an infinite 1-dimensional lattice with a black stone or a white stone on each segment, the segments are labelled by a position coordinate c_p , such that sufficiently far to the left, all stones are black, and sufficiently far to the right, all stones are white [41].

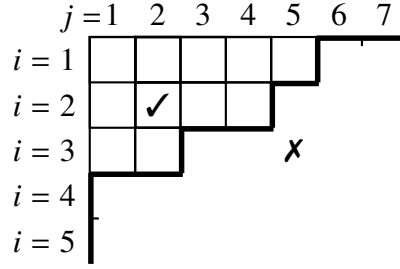

FIGURE 2.1. The Young diagram $Y = (5, 4, 2)$, and the corresponding transpose Young diagram $Y^\top = (3, 3, 2, 2, 1)$. The infinite borderline is shown in thick lines. The rows are numbered from top to bottom, the columns are from left to right, with null-rows and null-columns included. The arm-length and leg-length of the box with \checkmark are $A_{\checkmark,Y} = 2, A_{\checkmark,Y}^+ = 5/2, A_{\checkmark,Y}^{++} = 3, L_{\checkmark,Y} = 1, L_{\checkmark,Y}^+ = 3/2, L_{\checkmark,Y}^{++} = 2$. Similarly for the box with \times , we have $A_{\times,Y} = -3, A_{\times,Y}^+ = -5/2, A_{\times,Y}^{++} = -2, L_{\times,Y} = -2, L_{\times,Y}^+ = -3/2, L_{\times,Y}^{++} = -1$.

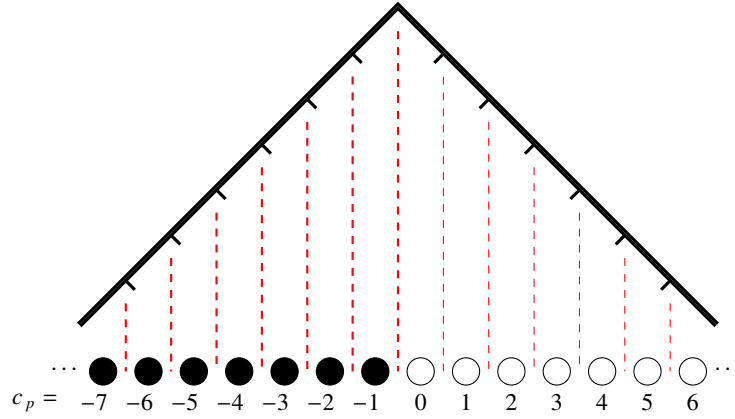

FIGURE 2.2. The ground-state, 0-charge Maya diagram. That no stones are shuffled corresponds to introducing a null Young diagram. That the charge is zero corresponds to positioning the apex between $(c_p = -1)$, and $(c_p = 0)$.

2.2.1. *The ground-state, 0-charge Maya diagram.* The simplest Maya diagram is the ground-state, 0-charge Maya diagram M_0 , where all segments from position $(c_p = -\infty)$, to position $(c_p = -1)$, inclusive, carry black stones, and all segments from position $(c_p = 0)$, to position $(c_p = \infty)$, inclusive, carry white stones, see Figure 2.2. From M_0 , we can generate all other diagrams by applying a charged Young diagram (Y, c_Y) to M_0 , such that, Y shuffles the black and the white stones at finite distances from the origin, and c_Y shifts the positions of *all* stones to the right by the same distance c_Y . The result is an excited state, charge- c_Y Maya diagram.

2.2.2. *Introducing a Young diagram.* Starting from the ground-state, 0-charge Maya diagram M_0 , we can use a finite Young diagram Y to shuffle the black and white stones at finite distances from the origin and produce an excited-state Maya diagram as follows. **1.** We position the diagram Y as in Figure 2.3, so that the apex of Y projects on the point between positions (-1) and (0) on the Maya diagram. The infinite borderline of Y then consists of upward and downward segments $(/, \backslash)$, where all segments are $/$ sufficiently far to the left, and all segments are \backslash sufficiently far to the right. **2.** We map the infinite borderline to a Maya diagram according to,

$$(2.5) \quad / \Rightarrow \bullet, \quad \backslash \Rightarrow \circ$$

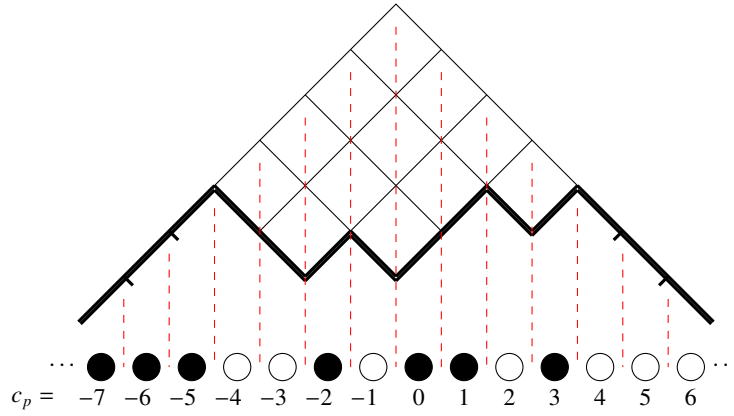

FIGURE 2.3. An excited-state, 0-charge Maya diagram with a shuffling that corresponds to $Y = (4, 3, 3, 2)$. The apex of the Young diagram is between position $(c_p = -1)$, and position $(c_p = 0)$.

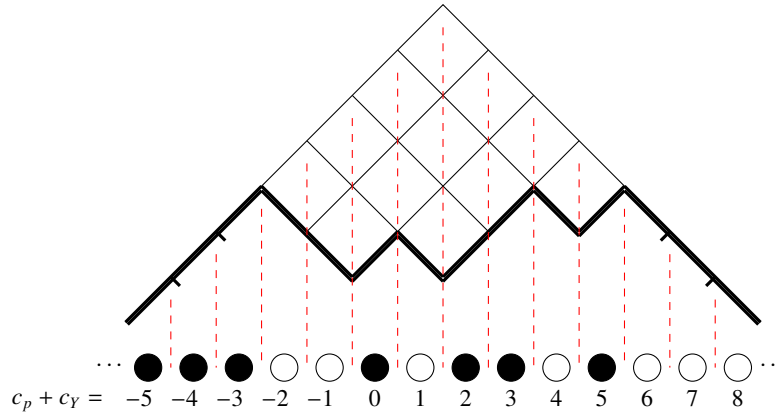

FIGURE 2.4. An excited-state charge-2 Maya diagram, with a shuffling that corresponds to $Y = (4, 3, 3, 2)$. The apex of the Young diagram is between position $(c_p = 1)$, and position $(c_p = 2)$.

The result is an excited-state, 0-charge Maya diagram, where the configuration of the black and white stones is in bijection with a finite Young diagram Y . Note that the position coordinates c_p are the same as in the ground-state Maya diagram.

2.2.3. *Introducing a charge.* We can introduce a charge c_Y into any 0-charge Maya diagram by shifting all stones globally by c_Y segments to the right, as in Figure 2.4. A stone that is at position c_p before introducing the charge is shifted to position $(c_p + c_Y)$.

3. SYMMETRIC FUNCTIONS AND HEISENBERG ALGEBRAS

We recall basic definitions related to symmetric functions, Heisenberg algebras and relations between them.

3.1. **Exponentiated sequences.** Given any two sequences of integers $\mathbf{a} = (a_1, a_2, \dots)$, $\mathbf{b} = (b_1, b_2, \dots)$ and two variables x, y we define

$$(3.1) \quad \mathbf{x}^{\mathbf{a}} \mathbf{y}^{\mathbf{b}} = (x^{a_1} y^{b_1}, x^{a_2} y^{b_2}, \dots),$$

In particular, given a Young diagram $Y = (y_1, y_2, \dots)$, and an infinite sequence of integers $\iota = (1, 2, \dots)$, we have

$$(3.2) \quad x^{\iota} y^{\pm Y} = (x y^{\pm y_1}, x^2 y^{\pm y_2} \dots), \quad x^{\iota-1} y^{\pm Y} = (y^{\pm y_1}, x y^{\pm y_2} \dots), \quad \dots$$

For the purposes of section 4, we define the sub-sequence,

$$(3.3) \quad [x^{\mathbf{a}} \mathbf{y}^{\mathbf{b}}]_c = (x^{a_i} y^{b_i} \mid i = 1, 2, \dots, a_i + b_i = c \bmod n)$$

For example, for $n = 3$ and $Y = (4, 3, 3, 2)$, $x^{\iota} y^{-Y} = (x y^{-4}, x^2 y^{-3}, x^3 y^{-3}, x^4 y^{-2}, x^5, x^6 \dots)$, we have $[x^{\iota} y^{-Y}]_0 = (x y^{-4}, x^3 y^{-3}, x^6, \dots)$.

3.2. The power-sum symmetric functions. Given $\mathbf{x} = (x_1, x_2, \dots)$, the power-sum symmetric function $p_n(\mathbf{x})$, $n \in (0, 1, \dots)$, is ⁷,

$$(3.4) \quad p_0(\mathbf{x}) = 1, \quad p_n(\mathbf{x}) = \sum_i x_i^n, \quad n = 1, 2, \dots,$$

and $p_Y(\mathbf{x})$, indexed by a Young diagram $Y = (y_1, y_2, \dots)$, is ⁸,

$$(3.5) \quad p_Y(\mathbf{x}) = p_{y_1}(\mathbf{x}) p_{y_2}(\mathbf{x}) \dots$$

3.3. The inner product of power-sum functions. Consider the ring of symmetric functions in a set of variables $\mathbf{x} = (x_1, x_2, \dots)$, with constant coefficients. In this case, the power-sum functions are defined to be orthogonal with inner product [39]

$$(3.6) \quad \langle p_{Y_1}(\mathbf{x}) \mid p_{Y_2}(\mathbf{x}) \rangle_{qt} = z_{Y_1} \delta_{Y_1 Y_2}, \quad z_Y = 1^{n_1} (n_1!) 2^{n_2} (n_2!) \dots,$$

3.4. The Schur function. Given a Young diagram $Y = (y_1, y_2, \dots)$, $Y^{\top} = (y_1^{\top}, y_2^{\top}, \dots)$, and a set of variables $\mathbf{x} = (x_1, x_2, \dots, x_n)$, such that $|\mathbf{x}| \geq y_1^{\top}$, the Schur function $s_{Y_1}(\mathbf{x})$ is ⁹,

$$(3.7) \quad s_Y(\mathbf{x}) = \frac{\det(x_i^{y_j + n - j})_{1 \leq i, j \leq n}}{\prod_{1 \leq i, j \leq n} (x_i - x_j)}$$

⁷ Ch. I, p. 23, in [39]

⁸ Ch. I, p. 24, in [39]

⁹ Ch. I, p. 40, in [39]

3.5. The skew Schur function. For two partitions Y_1 and Y_2 , the product of the Schur functions,

$$(3.8) \quad s_{Y_1} s_{Y_2} = \sum_Y c_{Y_1 Y_2}^Y s_Y$$

defines the integers $c_{Y_1 Y_2}^Y$, and the skew Schur symmetric functions are then defined as ¹⁰,

$$(3.9) \quad s_{Y/Y_1} = \sum_{Y_2} c_{Y_1 Y_2}^Y s_{Y_2}$$

By definition,

$$(3.10) \quad s_{\emptyset/\emptyset}(\mathbf{x}) = 1, \quad s_{\emptyset/\eta}(\mathbf{x}) = 0, \quad \text{if } \eta \neq \emptyset, \quad Q^{|\lambda|-|\eta|} s_{\lambda/\eta}(\mathbf{x}) = s_{\lambda/\eta}(Q\mathbf{x})$$

3.6. Cauchy identities. The (skew) Schur functions satisfy the Cauchy identities ¹¹,

$$(3.11) \quad \sum_Y s_{Y/Y_2}(\mathbf{x}) s_{Y/Y_1}(\mathbf{y}) = \prod_{i,j=1}^{\infty} \frac{1}{1-x_i y_j} \sum_Y s_{Y_1/Y}(\mathbf{x}) s_{Y_2/Y}(\mathbf{y})$$

$$(3.12) \quad \sum_Y s_{Y^\tau/Y_2^\tau}(\mathbf{x}) s_{Y/Y_1}(\mathbf{y}) = \prod_{i,j=1}^{\infty} (1+x_i y_j) \sum_Y s_{Y_1^\tau/Y^\tau}(\mathbf{x}) s_{Y_2/Y}(\mathbf{y})$$

3.7. The Heisenberg algebra. In this work, a Heisenberg algebra \mathcal{H} is the infinite-dimensional algebra generated by $\mathbf{a}_+ = (a_{+1}, a_{+2}, \dots)$ and $\mathbf{a}_- = (a_{-1}, a_{-2}, \dots)$, that satisfy the commutation relations,

$$(3.13) \quad [a_m, a_n] = m \delta_{n+m,0}$$

act on the left-state as creation and annihilation operators, respectively, and on the right-state as annihilation and creation operators, respectively.

3.8. The left- and right-Heisenberg states. The left-Heisenberg state $\langle \mathbf{a}_Y |$, and the right-Heisenberg state $|\mathbf{a}_Y \rangle$, $Y = (y_1, y_2, \dots)$, are generated from the left- and the right-vacuum states,

$$(3.14) \quad \langle \mathbf{a}_Y | = \langle 0 | a_{y_1} a_{y_2} \dots, \quad |\mathbf{a}_Y \rangle = \dots a_{-y_2} a_{-y_1} | 0 \rangle$$

Using the Heisenberg commutation relations, the inner product of $\langle \mathbf{a}_{Y_1} |$ and $|\mathbf{a}_{Y_2} \rangle$ is,

$$(3.15) \quad \langle \mathbf{a}_{Y_1} | \mathbf{a}_{Y_2} \rangle = z_{Y_1} \delta_{Y_1 Y_2}, \quad z_Y = 1^{n_1} (n_1!) 2^{n_2} (n_2!) \dots$$

¹⁰ Ch. I, p. 69, in [39]

¹¹ Ch. I, p. 93, in [39]

3.9. The power-sum/Heisenberg correspondence. From the inner products 3.6 and 3.15, we deduce that the power-sum basis spanned by $p(\mathbf{x})$ is isomorphic to the left-state Heisenberg basis spanned by $\langle a_Y |$, as well as the right-state Heisenberg basis spanned by $| a_Y \rangle$,

$$(3.16) \quad p_n(\mathbf{x}) \rightleftharpoons -a_n, \quad p_n(\mathbf{x}) \rightleftharpoons -a_{-n}, \quad n \geq 1.$$

3.10. The left- and right-Schur states. Expanding the Schur functions in terms of the power-sum functions, then formally replacing the latter with Heisenberg generators, we obtain operator-valued Schur functions that act on left- and right-vacuum states to produce left- and right-Schur states,

$$(3.17) \quad \langle s_Y | = \langle 0 | s_Y(\mathbf{a}_+), \quad | s_Y \rangle = s_Y(\mathbf{a}_-) | 0 \rangle.$$

The left- and the right-Schur states satisfy the orthogonality condition,

$$(3.18) \quad \langle s_{Y_1}(\mathbf{x}) | s_{Y_2}(\mathbf{x}) \rangle = \delta_{Y_1 Y_2}.$$

3.11. The Γ -operators. To the Heisenberg algebra \mathcal{H} , we associate the operators Γ_{\pm} ,

$$(3.19) \quad \Gamma_{\pm}(x) = \exp\left(-\sum_{n=1}^{\infty} \frac{x^{\mp n}}{n} a_{\pm n}\right)$$

Using the Heisenberg commutation relations Equation 3.13, we obtain

$$(3.20) \quad \Gamma_+(x^{-1}) \Gamma_-(y) = \left(\frac{1}{1-xy}\right) \Gamma_-(y) \Gamma_+(x^{-1}).$$

3.12. The action of the Γ_{\pm} operators on Schur states. In [26, 27], identities that describe the action of the Γ_{\pm} operators on states labelled by Macdonald and q -Whittaker symmetric functions, respectively, were derived. In the Schur limit, these identities reduce to,

$$(3.21) \quad \langle s_{Y_1} | \prod_{i=1}^{\infty} \Gamma_-(y_i) = \sum_Y \langle s_Y | s_{Y_1/Y}(\mathbf{y}), \quad \prod_{i=1}^{\infty} \Gamma_+(x_i^{-1}) | s_{Y_1} \rangle = \sum_Y s_{Y_1/Y}(\mathbf{x}) | s_Y \rangle.$$

4. THE n -COLOURED REFINED TOPOLOGICAL VERTEX

We construct the n -coloured refined topological vertex using n free bosons.

The n -coloured refined topological vertex is a trivalent vertex with an incoming leg labelled by n Young diagrams $\mathbf{Y}_1 = (Y_{1,0}, \dots, Y_{1,n-1})$, an outgoing leg labelled by n Young diagrams $\mathbf{Y}_2 = (Y_{2,0}, \dots, Y_{2,n-1})$, and a preferred leg labelled by a single charged Young diagram (Y, c_Y) , $c_Y \in (0, 1, \dots, n-1)$. We construct the n -coloured vertex in six steps¹².

¹² The construction of the n -coloured vertex and the conjugate vertex, in this section, was guided by the form of the instanton partition function on $\mathbb{C}^2/\mathbb{Z}_n$ of the Landau School [3, 4, 10–13, 15]

4.1. 1. Introduce n species of free bosons. Instead of a single Heisenberg algebra, as in the case of the refined topological vertex, we work in terms of n commuting Heisenberg algebras \mathcal{H}_m , $m \in (0, 1, \dots, n-1)$. From now on, all operators that belong to \mathcal{H}_m will carry a subscript m . In particular, we have $\Gamma_{m\pm}$, $m \in (0, 1, \dots, n-1)$.

4.2. 2. Introduce an excited-state, charged Maya diagram. We start from a ground-state, 0-charge Maya diagram and use a charged Young diagram (Y, c_Y) as in Section 2.2 to produce an excited-state, charge- c_Y Maya diagram. The position of each stone is shifted from c_p to $(c_p + c_Y)$.

4.3. 3. Introduce the Γ -operators. We map the excited-state, charge- c_Y Maya diagram to an infinite sequence of Γ -vertex operators $\prod_{\text{Maya}(Y)} \Gamma_{\pm}$, using the bijections

$$(4.1) \quad / \Leftrightarrow \circ \Leftrightarrow \Gamma_{c_H+}, \quad \backslash \Leftrightarrow \bullet \Leftrightarrow \Gamma_{c_H-}, \quad c_H = (c_p + c_Y) \bmod n,$$

for each stone at position $(c_p + c_Y)$. We call c_H the Heisenberg charge.

4.4. 4. Assign arguments to the vertex operators. We take the arguments of the Γ -operators to be,

$$(4.2) \quad \Gamma_{c_H+} (x^{-i} y^{Y_i}), \quad \Gamma_{c_H-} (y^{j-1} x^{-Y_j^T}),$$

where Y_i is the length of the i -row of the Young diagram Y that labels the preferred leg of the vertex, and Y_j^T is the length of the j -column of the Young diagram Y . The sum of the exponents of the arguments of Γ_{\pm} is related to c_p as follows. For $\Gamma_{c_H+} (x^{-i} y^{Y_i})$ at position $(c_p + c_Y)$,

$$(4.3) \quad c_p = Y_i - i,$$

and for $\Gamma_{c_H-} (y^{j-1} x^{-Y_j^T})$ at position $(c_p + c_Y)$,

$$(4.4) \quad c_p = -Y_j^T + j - 1$$

4.5. 5. From the infinite sequence of Γ -operators to an expectation value. We evaluate the sequence $\prod_{\text{Maya}(Y)} \Gamma_{\pm}$ between a left-state,

$$(4.5) \quad \langle s_{\mathbf{Y}_1} | = \langle s_{Y_{1,0}} | \otimes \cdots \otimes \langle s_{Y_{1,(n-1)}} | = \langle 0 | s_{Y_{1,0}} (\mathbf{a}_{1+}) \cdots s_{Y_{1,(n-1)}} (\mathbf{a}_{n+})$$

and a right-state,

$$(4.6) \quad |s_{\mathbf{Y}_2}\rangle = |s_{Y_{2,0}}\rangle \otimes \cdots \otimes |s_{Y_{2,(n-1)}}\rangle = s_{Y_{2,0}} (\mathbf{a}_{1-}) \cdots s_{Y_{2,(n-1)}} (\mathbf{a}_{n-}) |0\rangle$$

to get the unnormalized n -coloured refined topological vertex

$$(4.7) \quad C_{\mathbf{Y}_1 \mathbf{Y}_2 Y}^{p, c_Y, unnorm} (x, y) = \langle s_{\mathbf{Y}_1} | \left(\prod_{\text{Maya}(Y)} \Gamma_{\pm} \right) | s_{\mathbf{Y}_2} \rangle$$

For $n = 3$ and $Y = (4, 3, 3, 2)$ (see Figure 2.4), the sequences for the possible c_Y are ¹³,

$$(4.8) \quad C_{\mathbf{Y}_1 \mathbf{Y}_2 Y}^{3, c_Y=0, unnorm} (x, y) = \langle s_{\mathbf{Y}_1} | \cdots \Gamma_{1+} (x^{-5}) \Gamma_{2-} (x^{-4}) \Gamma_{0-} (yx^{-4}) \Gamma_{1+} (x^{-4}y^2) \Gamma_{2-} (y^2x^{-3}) \\ \Gamma_{0+} (x^{-3}y^3) \Gamma_{1+} (x^{-2}y^3) \Gamma_{2-} (y^3x^{-1}) \Gamma_{0+} (x^{-1}y^4) \Gamma_{1-} (y^4) \cdots | s_{\mathbf{Y}_2} \rangle$$

$$(4.9) \quad C_{\mathbf{Y}_1 \mathbf{Y}_2 Y}^{3, c_Y=1, unnorm} (x, y) = \langle s_{\mathbf{Y}_1} | \cdots \Gamma_{2+} (x^{-5}) \Gamma_{0-} (x^{-4}) \Gamma_{1-} (yx^{-4}) \Gamma_{2+} (x^{-4}y^2) \Gamma_{0-} (y^2x^{-3}) \\ \Gamma_{1+} (x^{-3}y^3) \Gamma_{2+} (x^{-2}y^3) \Gamma_{0-} (y^3x^{-1}) \Gamma_{1+} (x^{-1}y^4) \Gamma_{2-} (y^4) \cdots | s_{\mathbf{Y}_2} \rangle$$

$$(4.10) \quad C_{\mathbf{Y}_1 \mathbf{Y}_2 Y}^{3, c_Y=2, unnorm} (x, y) = \langle s_{\mathbf{Y}_1} | \cdots \Gamma_{0+} (x^{-5}) \Gamma_{1-} (x^{-4}) \Gamma_{2-} (yx^{-4}) \Gamma_{0+} (x^{-4}y^2) \Gamma_{1-} (y^2x^{-3}) \\ \Gamma_{2+} (x^{-3}y^3) \Gamma_{0+} (x^{-2}y^3) \Gamma_{1-} (y^3x^{-1}) \Gamma_{2+} (x^{-1}y^4) \Gamma_{0-} (y^4) \cdots | s_{\mathbf{Y}_2} \rangle$$

To evaluate the expectation value in Equation 4.7, we normal-order the sequence $\left(\prod_{\text{Maya}(Y)} \Gamma_{\pm} \right)$ to put all Γ_{c_H+} vertex operators on the right, and all Γ_{c_H-} vertex operators on the left. Since Γ -operators with different Heisenberg charges commute, the n -coloured vertex is a product of n components labelled by $c_H \in \mathbb{Z}_n$,

$$(4.11) \quad C_{\mathbf{Y}_1 \mathbf{Y}_2 Y}^{n, c_Y, unnorm} (x, y) = \prod_{c_H=0}^{n-1} \langle s_{\mathbf{Y}_1 c_H} | \left(\prod_{\substack{\text{Maya}(Y) \\ c_p + c_Y = c_H \pmod n}} \Gamma_{\pm c_H} \right) | s_{\mathbf{Y}_2 c_H} \rangle,$$

where $\left(\prod_{\substack{\text{Maya}(Y) \\ c_p + c_Y = c_H \pmod n}} \Gamma_{\pm c_H} \right)$ is restricted to the sub-Maya diagram of $\text{Maya}(Y)$ with stones at positions $(c_p + c_Y = c_H \pmod n)$. Within each factor, we commute Γ -operators (all of which are built from the same Heisenberg algebra) using,

$$(4.12) \quad \Gamma_{c_H+} (x^{-i} y^{Y_i}) \Gamma_{c_H-} (y^{j-1} x^{-Y_j^T}) = \\ \left(\frac{1}{1 - x^{-Y_{3,j}^T + i} y^{-Y_{3,i+j-1}}} \right) \Gamma_{c_H-} (y^{j-1} x^{-Y_{3,j}^T}) \Gamma_{c_H+} (x^{-i} y^{Y_{3,i}})$$

Since Γ_{c_H+} is attached to a segment $/$ in the borderline of Y , and Γ_{c_H-} is attached to an adjacent segment \backslash to the right of the former, the commutation relation, Equation 4.12, is the same as adding a strip of length n to Y . Repeating this process,

¹³ We list all three possibilities, then we choose one.

$$\begin{aligned}
(4.13) \quad C_{\mathbf{Y}_1 \mathbf{Y}_2 Y}^{n, c_Y, \text{unnorm}}(x, y) &= \prod_{c_H=0}^{n-1} \prod_{\substack{(i,j) \notin Y \\ Y_i - i + c_Y = c_H \pmod n \\ -Y_j^\top + j - 1 + c_Y = c_H \pmod n}} \frac{1}{1 - x^{-Y_j^\top + i} y^{-Y_i + j - 1}} \\
&\langle s_{\mathbf{Y}_1} | \prod_{c_H=0}^{n-1} \left(\prod_{\substack{j=1 \\ -Y_j^\top + j - 1 + c_Y = c_H \pmod n}}^{\infty} \Gamma_{c_H^-} (y^{j-1} x^{-Y_j^\top}) \prod_{\substack{i=1 \\ Y_i - i + c_Y = c_H \pmod n}}^{\infty} \Gamma_{c_H^+} (x^{-i} y^{Y_i}) \right) | s_{\mathbf{Y}_2} \rangle \\
&= \left(\prod_{\substack{\square \notin Y \\ A_{\square, Y} + L_{\square, Y} + 1 = 0 \pmod n}} \frac{1}{1 - x^{-L_{\square, Y}} y^{-A_{\square, Y}^{++}}} \right) \prod_{c_H=0}^{n-1} \sum_Y s_{Y_{1c_H}/Y} ([y^{J^{-1}} x^{-Y^\top}]_{c_H - c_Y}) s_{Y_{2c_H}/Y} ([x^t y^{-Y}]_{-c_H + c_Y})
\end{aligned}$$

where, to obtain the last equality, we used $\mathbf{t} = \mathbf{j} = (1, 2, \dots)$, Equations 3.21 and 3.18, and the definition of $[x^a y^b]_c$, for any two sequences of integers \mathbf{a}, \mathbf{b} , in Equation 3.3.

4.6. 6. Normalization of the vertex. Using the unnormalized vertex $C_{\mathbf{Y}_1 \mathbf{Y}_2 Y}^{n, c_Y, \text{unnorm}}(x, y)$, we obtain the normalization $C_{\emptyset \emptyset \emptyset}^{n, c_Y, \text{unnorm}}(x, y)$, from which we then obtain the normalized vertex:

$$\begin{aligned}
(4.14) \quad C_{\mathbf{Y}_1 \mathbf{Y}_2 Y}^{n, c_Y}(x, y) &= \frac{C_{\mathbf{Y}_1 \mathbf{Y}_2 Y}^{n, c_Y, \text{unnorm}}(x, y)}{C_{\emptyset \emptyset \emptyset}^{n, c_Y, \text{unnorm}}(x, y)} \\
&= \prod_{\substack{i,j=1 \\ 1-i-j=0 \pmod n}}^{\infty} (1 - x^i y^{j-1}) \left(\prod_{\substack{\square \notin Y \\ A_{\square, Y} + L_{\square, Y} + 1 = 0 \pmod n}} \frac{1}{1 - x^{-L_{\square, Y}} y^{-A_{\square, Y}^{++}}} \right) \\
&\quad \prod_{c_H=0}^{n-1} \sum_Y s_{Y_{1c_H}/Y} ([y^{J^{-1}} x^{-Y^\top}]_{c_H - c_Y}) s_{Y_{2c_H}/Y} ([x^t y^{-Y}]_{-c_H + c_Y}) \\
&= \left(\prod_{\substack{\square \in Y \\ A_{\square, Y} + L_{\square, Y} + 1 = 0 \pmod n}} \frac{1}{1 - x^{L_{\square, Y}^{++}} y^{A_{\square, Y}}} \right) \prod_{c_H=0}^{n-1} \sum_Y s_{Y_{1c_H}/Y} ([y^{J^{-1}} x^{-Y^\top}]_{c_H - c_Y}) s_{Y_{2c_H}/Y} ([x^t y^{-Y}]_{-c_H + c_Y}).
\end{aligned}$$

Then, on defining

$$(4.15) \quad Z_Y^n(x, y) = \prod_{c_H=0}^{n-1} \prod_{\substack{(i,j) \in Y \\ Y_i - i + c_Y = c_H \pmod n \\ -Y_j^\top + j - 1 + c_Y = c_H \pmod n}} \frac{1}{1 - x^{Y_j^\top - i + 1} y^{Y_i - j}} = \prod_{\substack{\square \in Y \\ A_{\square, Y} + L_{\square, Y} + 1 = 0 \pmod n}} \frac{1}{1 - x^{L_{\square, Y}^{++}} y^{A_{\square, Y}}},$$

we obtain

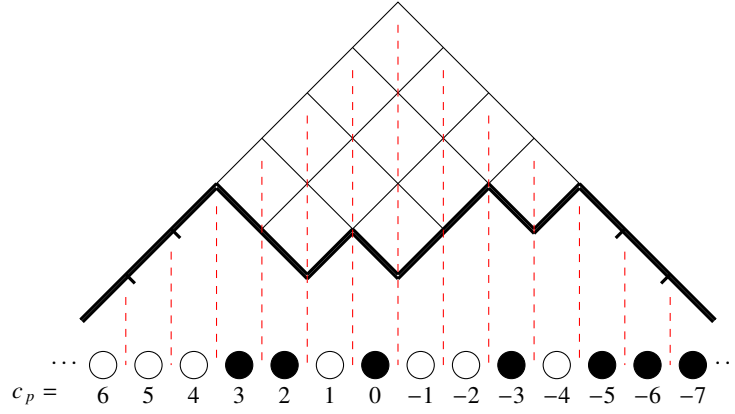

FIGURE 4.1. An n -coloured Maya diagram for conjugate vertex that corresponds to a partition $Y = (4, 3, 3, 2)$. Note that the position coordinates are reversed with respect to those in Figure 2.3.

$$(4.16) \quad C_{\mathbf{Y}_1 \mathbf{Y}_2 Y}^{n, c_Y} (x, y) = Z_Y^n (x, y) \prod_{c_H=0}^{n-1} \sum_Y s_{Y_{1c_H/Y}} ([y^{j-1} x^{-Y^T}]_{c_H - c_Y}) s_{Y_{2c_H/Y}} ([x^i y^{-Y}]_{-c_H + c_Y})$$

4.7. The conjugate vertex. To form strips, we need the conjugate vertex which is obtained by reversing the positions of the Maya diagram as shown in Figure 4.1, that is, $c_p \mapsto -c_p - 1$, and repeat the construction of the vertex outlined above, but now the sum of the exponents of the argument of Γ_{\pm} is related to the initial position c_p in a different way. For $\Gamma_{c_H+} (x^{-i} y^{Y_i})$, at position $(c_p + c_Y)$,

$$(4.17) \quad c_p = -Y_i + i - 1,$$

and for $\Gamma_{c_H-} (y^{j-1} x^{-Y_j^T})$, at position $(c_p + c_Y)$,

$$(4.18) \quad c_p = Y_j^T - j,$$

so that,

$$(4.19) \quad C_{\mathbf{Y}_1 \mathbf{Y}_2 Y}^{n, c_Y, \text{unnorm}^*} (x, y) = \prod_{c_H=0}^{n-1} \langle s_{\mathbf{Y}_1} | \left(\prod_{\substack{\text{Maya}(Y) \\ c_p + c_Y = c_H \pmod n}} \Gamma_{c_H \pm} \right) | s_{\mathbf{Y}_2} \rangle \\ = \prod_{c_H=0}^{n-1} \prod_{\substack{(i,j) \notin Y \\ -Y_i + i - 1 + c_Y = c_H \pmod n \\ Y_j^T - j + c_Y = c_H \pmod n}} \frac{1}{1 - x^{-Y_j^T + i} y^{-Y_i + j - 1}}$$

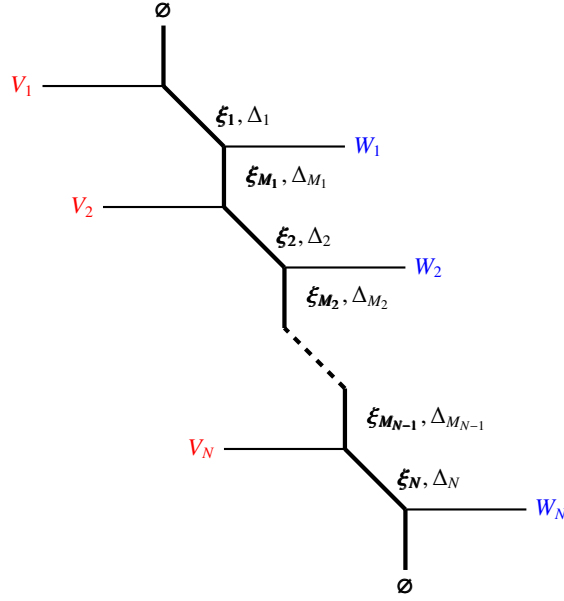

FIGURE 4.2. The strip diagram made of N pairs of n -coloured vertices and conjugate vertices. Each internal line is labeled by a partition and a Kähler parameter. Each external (horizontal) line is labeled by a partition. The external legs are preferred and labelled by Young's diagrams $\mathbf{V} = ((V_1, c_{V_1}), \dots, (V_N, c_{V_N}))$ and $\mathbf{W} = ((W_1, c_{W_1}), \dots, (W_N, c_{W_N}))$.

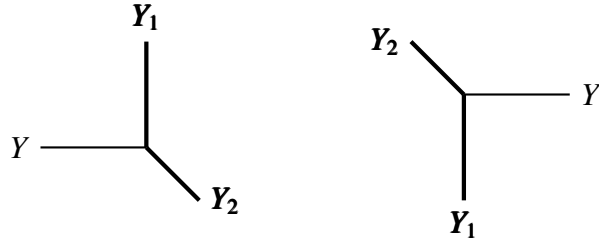

FIGURE 4.3. The vertex $C_{\mathbf{Y}_1 \mathbf{Y}_2 Y}^{p, c_Y}(x, y)$ is on the left and the conjugate vertex $C_{\mathbf{Y}_1 \mathbf{Y}_2 \mathbf{Y}^\top}^{p, c_Y^*}(y, x)$ is on the right.

$$\begin{aligned} & \langle s_{\mathbf{Y}_1} | \prod_{c_H=0}^{n-1} \left(\prod_{j=1}^{\infty} \Gamma_{c_H - (y^{j-1} x^{-Y_j^\top})} \prod_{i=1}^{\infty} \Gamma_{c_H + (x^{-i} y^{Y_i})} \right) | s_{\mathbf{Y}_2} \rangle \\ &= \left(\prod_{\substack{\square \notin Y \\ A_{\square, Y} + L_{\square, Y} + 1 = 0 \pmod n}} \frac{1}{1 - x^{-L_{\square, Y}} y^{-A_{\square, Y}^{++}}} \right) \prod_{c_H=0}^{n-1} \sum_Y s_{Y_{1c_H}/Y} ([y^{J-1} x^{-Y^\top}]_{-c_H+c_Y-1}) s_{Y_{2c_H}/Y} ([x^t y^{-Y}]_{c_H-c_Y+1}), \end{aligned}$$

and after normalization,

$$(4.20) \quad \boxed{C_{\mathbf{Y}_1 \mathbf{Y}_2 Y}^{n, c_Y^*}(x, y) = Z_Y^n(x, y) \prod_{c_H=0}^{n-1} \sum_Y s_{Y_{1c_H}/Y} ([y^{J-1} x^{-Y}]_{-c_H+c_Y-1}) s_{Y_{2c_H}/Y} ([x^t y^{-Y^\top}]_{c_H-c_Y+1})}$$

5. FROM n -COLOURED VERTICES TO n -COLOURED N -STRIP PARTITION FUNCTIONS

We construct 5D strip partition functions from N pairs of n -coloured refined topological vertices, where a pair of vertices consists of a vertex and a conjugate vertex.

We consider an N -strip partition function on $\mathbb{C}^2/\mathbb{Z}_n$ shown in Figure 4.2. The horizontal external legs are labelled by Young diagrams with \mathbb{Z}_n -charges. Denote a Young diagram Y carrying \mathbb{Z}_n -charge $c_Y \in \mathbb{Z}_n$ by (Y, c_Y) . There are N horizontal external legs to the left labelled by,

$$(5.1) \quad (\mathbf{V}, \mathbf{c}_V) = \left((V_1, c_{V_1}), \dots, (V_N, c_{V_N}) \right)$$

There are N horizontal external legs to the right labelled by,

$$(5.2) \quad (\mathbf{W}, \mathbf{c}_W) = \left((W_1, c_{W_1}), \dots, (W_N, c_{W_N}) \right)$$

Each internal edge is labelled by uncharged n -Young diagrams $\xi = (\xi_0, \dots, \xi_{n-1})$. For an internal edge with diagram ξ_i we define,

$$(5.3) \quad \text{Edge factor} = (-Q_i)^{|\xi_i|}, \quad Q_i = e^{-R\Delta_i}, \quad i = 1, M_1, 2, M_2, \dots, M_{N-1}, N$$

The external vertical legs are labelled by n null Young diagrams \emptyset .

5.1. The unnormalized strip partition function. The unnormalized N -strip $\mathbb{C}^2/\mathbb{Z}_n$ partition function can be written directly from Figure 4.2,

$$(5.4) \quad \mathcal{S}_{(\mathbf{V}, \mathbf{c}_V)(\mathbf{W}, \mathbf{c}_W)\Delta}^{n, \text{unnorm}}(x, y, R) = \sum_{\xi_1, \dots, \xi_N} \sum_{\xi_{M_1}, \dots, \xi_{M_{N-1}}} \prod_{I=1}^N \left((-Q_i)^{|\xi_i|} (-Q_{M_I})^{|\xi_{M_I}|} C_{\xi_{M_{I-1}}^\top \xi_I V_I^\top}^{n, V_I}(x, y) C_{\xi_{M_I} \xi_I^\top W_I}^{n, W_I^*}(y, x) \right)$$

where the summations are over all possible internal n -Young diagrams. Expanding the definition of the vertices and the conjugate vertices gives

$$(5.5) \quad \mathcal{S}_{(\mathbf{V}, \mathbf{c}_V)(\mathbf{W}, \mathbf{c}_W)\Delta}^{n, \text{unnorm}}(x, y, R) = \prod_{I=1}^N \left(Z_{V_I}^n(x, y) Z_{W_I^\top}^n(y, x) \right) \sum_{\xi_1, \dots, \xi_N} \sum_{\xi_{M_1}, \dots, \xi_{M_{N-1}}} \prod_{I=1}^N \left((-Q_i)^{|\xi_i|} (-Q_{M_I})^{|\xi_{M_I}|} \right) \\ \prod_{c_H=0}^{n-1} \sum_{\eta'_I} S_{\xi_{M_{I-1}} c_H / \eta'_I} \left([x^{-V_I} y^{J-1}]_{c_H - c_{V_I}} \right) S_{\xi_I c_H / \eta'_I} \left([x^I y^{-V_I^\top}]_{-c_H + c_{V_I}} \right) \\ \prod_{c_H=0}^{n-1} \sum_{\eta''_I} S_{\xi_{M_I} c_H / \eta''_I} \left([y^{-W_I^\top} x^{I-1}]_{-c_H + c_{W_I} - 1} \right) S_{\xi_I c_H / \eta''_I} \left([y^J x^{-W_I}]_{c_H - c_{W_I} + 1} \right)$$

$$\begin{aligned}
&= \prod_{I=1}^N \left(Z_{V_I}^n(x, y) Z_{W_I^\top}^n(y, x) \right) \prod_{c_H=0}^{n-1} \sum_{(\xi_1, \dots, \xi_N)} \sum_{(\xi_{M_1}, \dots, \xi_{M_{N-1}})} \prod_{I=1}^N \left((-Q_I)^{|\xi_I|} (-Q_{M_I})^{|\xi_{M_I}|} \right) \\
&\quad \sum_{\eta'_I} s_{\xi_{M_{I-1}}/\eta'_I} \left([x^{-V_I} y^{J-1}]_{c_H - c_{V_I}} \right) s_{\xi_I/\eta'_I} \left([x^t y^{-V_I^\top}]_{-c_H + c_{V_I}} \right) \\
&\quad \sum_{\eta''_I} s_{\xi_{M_I}/\eta''_I} \left([y^{-W_I^\top} x^{t-1}]_{-c_H + c_{W_I-1}} \right) s_{\xi_I^\top/\eta''_I} \left([y^J x^{-W_I}]_{c_H - c_{W_I+1}} \right)
\end{aligned}$$

where $\xi_{M_0} = \xi_{M_N} = \emptyset$. Using the result of Appendix B then gives

$$\begin{aligned}
(5.6) \quad \mathcal{S}_{(V, c_V)(W, c_W)\Delta}^{n, unnorm}(x, y, R) &= \prod_{I=1}^N \left(Z_{V_I}^n(x, y) Z_{W_I^\top}^n(y, x) \right) \\
&\quad \prod_{c_H=0}^{n-1} \prod_{J=1}^N \prod_{I=1}^J \prod_{i=1}^{\infty} \prod_{j=1}^{\infty} \left(1 - \prod_{K=I}^{J-1} Q_{M_K} \prod_{K=I}^J Q_K x^{-W_{J,j}+i} y^{-V_{I,i}^\top+j} \right) \\
&\quad \prod_{c_H=0}^{n-1} \prod_{J=1}^N \prod_{I=1}^{J-1} \prod_{i=1}^{\infty} \prod_{j=1}^{\infty} \left(1 - \prod_{K=I}^{J-1} Q_{M_K} \prod_{K=I+1}^{J-1} Q_K x^{-V_{J,j}+i-1} y^{-W_{I,i}^\top+j-1} \right) \\
&\quad \prod_{c_N=0}^{n-1} \prod_{J=1}^N \prod_{I=1}^{J-1} \prod_{i=1}^{\infty} \prod_{j=1}^{\infty} \left(1 - \prod_{K=I}^{J-1} Q_{M_K} \prod_{K=I}^{J-1} Q_K x^{-V_{J,j}+i} y^{-V_{I,i}^\top+j-1} \right)^{-1} \\
&\quad \prod_{c_H=0}^{n-1} \prod_{J=1}^N \prod_{I=1}^{J-1} \prod_{i=1}^{\infty} \prod_{j=1}^{\infty} \left(1 - \prod_{K=I}^{J-1} Q_{M_K} \prod_{K=I+1}^J Q_K x^{-W_{J,j}+i-1} y^{-W_{I,i}^\top+j} \right)^{-1} \\
&= \prod_{I=1}^N \left(Z_{V_I}^n(x, y) Z_{W_I^\top}^n(y, x) \right) \\
&\quad \prod_{J=1}^N \prod_{I=1}^J \prod_{i,j=1}^{\infty} \left(1 - \prod_{K=I}^{J-1} Q_{M_K} \prod_{K=I}^J Q_K x^{-W_{J,j}+i} y^{-V_{I,i}^\top+j} \right) \\
&\quad \prod_{J=1}^N \prod_{I=1}^{J-1} \prod_{i,j=1}^{\infty} \left(1 - \prod_{K=I}^{J-1} Q_{M_K} \prod_{K=I+1}^{J-1} Q_K x^{-V_{J,j}+i-1} y^{-W_{I,i}^\top+j-1} \right) \\
&\quad \prod_{J=1}^N \prod_{I=1}^{J-1} \prod_{i,j=1}^{\infty} \left(1 - \prod_{K=I}^{J-1} Q_{M_K} \prod_{K=I}^{J-1} Q_K x^{-V_{J,j}+i} y^{-V_{I,i}^\top+j-1} \right)^{-1} \\
&\quad \prod_{J=1}^N \prod_{I=1}^{J-1} \prod_{i,j=1}^{\infty} \left(1 - \prod_{K=I}^{J-1} Q_{M_K} \prod_{K=I+1}^J Q_K x^{-W_{J,j}+i-1} y^{-W_{I,i}^\top+j} \right)^{-1}
\end{aligned}$$

5.2. The normalization of the strip. For $n = 1$, the normalized N -strip partition function on \mathbb{R}^4 is obtained by normalizing $\mathcal{S}_{\mathbf{v}\mathbf{w}\Delta}(x, y, R)$ by $\mathcal{S}_{\emptyset\emptyset\Delta}(x, y, R)$, so that $\mathcal{S}_{\emptyset\emptyset\Delta}^{norm}(x, y, R) = 1$. Similarly, for $n > 1$, we write the normalized strip partition function on $\mathbb{R}^4/\mathbb{Z}_n$ as,

$$(5.7) \quad \mathcal{S}_{(\mathbf{v}, \mathbf{c}_V)(\mathbf{w}, \mathbf{c}_W)\Delta}^{n, norm}(x, y, R) = \frac{\mathcal{S}_{(\mathbf{v}, \mathbf{c}_V)(\mathbf{w}, \mathbf{c}_W)\Delta}^n(x, y, R)}{\mathcal{S}_{(\emptyset, \mathbf{c}_V)(\emptyset, \mathbf{c}_W)\Delta}^n(x, y, R)}$$

From Equation 5.6 and identity A.1,

$$(5.8) \quad \mathcal{S}_{(\mathbf{v}, \mathbf{c}_V)(\mathbf{w}, \mathbf{c}_W)\Delta}^{n, norm}(x, y, R) = \prod_{I=1}^N \left(Z_{V_I}^n(x, y) Z_{W_I^\tau}^n(y, x) \right) \\ \prod_{I=1}^N \prod_{J=1}^I \prod_{\blacksquare \in W_J} \prod_{A_{\blacksquare, W_I} + L_{\blacksquare, V_J} + 1 - c_{W_I} + c_{V_J} = 0 \pmod n} \left(1 - \prod_{K=J}^{I-1} \mathcal{Q}_{M_K} \prod_{K=J}^I \mathcal{Q}_K x^{-A_{\blacksquare, W_I}} y^{-L_{\blacksquare, V_J}} \right) \\ \prod_{\square \in V_J} \prod_{A_{\square, V_J} + L_{\square, W_I} + 1 + c_{W_I} - c_{V_J} = 0 \pmod n} \left(1 - \prod_{K=J}^{I-1} \mathcal{Q}_{M_K} \prod_{K=J}^I \mathcal{Q}_K x^{A_{\square, V_J}^{++}} y^{L_{\square, W_I}^{++}} \right) \\ \prod_{I=1}^N \prod_{J=1}^{I-1} \prod_{\square \in V_I} \prod_{A_{\square, V_I} + L_{\square, W_J} + 1 - c_{V_I} + c_{W_J} = 0 \pmod n} \left(1 - \prod_{K=J}^{I-1} \mathcal{Q}_{M_K} \prod_{K=J+1}^{I-1} \mathcal{Q}_K x^{-A_{\square, V_I}^{++}} y^{-L_{\square, W_J}^{++}} \right) \\ \prod_{\blacksquare \in W_J} \prod_{A_{\blacksquare, W_I} + L_{\blacksquare, V_I} + 1 + c_{V_I} - c_{W_J} = 0 \pmod n} \left(1 - \prod_{K=J}^{I-1} \mathcal{Q}_{M_K} \prod_{K=J+1}^{I-1} \mathcal{Q}_K x^{A_{\blacksquare, W_I}} y^{L_{\blacksquare, V_I}} \right) \\ \prod_{I=1}^N \prod_{J=1}^{I-1} \prod_{\square \in V_I} \prod_{A_{\square, V_I} + L_{\square, W_J} + 1 - c_{V_I} + c_{W_J} = 0 \pmod n} \left(1 - \prod_{K=J}^{I-1} \mathcal{Q}_{M_K} \prod_{K=J}^{I-1} \mathcal{Q}_K x^{-A_{\square, V_I}^{++}} y^{-L_{\square, W_J}} \right)^{-1} \\ \prod_{\square \in V_J} \prod_{A_{\square, V_J} + L_{\square, V_I} + 1 + c_{V_I} - c_{V_J} = 0 \pmod n} \left(1 - \prod_{K=J}^{I-1} \mathcal{Q}_{M_K} \prod_{K=J}^{I-1} \mathcal{Q}_K x^{A_{\square, V_J}} y^{L_{\square, V_I}^{++}} \right)^{-1} \\ \prod_{I=1}^N \prod_{J=1}^{I-1} \prod_{\blacksquare \in W_I} \prod_{A_{\blacksquare, W_I} + L_{\blacksquare, W_J} + 1 - c_{W_I} + c_{W_J} = 0 \pmod n} \left(1 - \prod_{K=J}^{I-1} \mathcal{Q}_{M_K} \prod_{K=J+1}^I \mathcal{Q}_K x^{-A_{\blacksquare, W_I}} y^{-L_{\blacksquare, W_J}^{++}} \right)^{-1} \\ \prod_{\blacksquare \in W_J} \prod_{A_{\blacksquare, W_I} + L_{\blacksquare, W_I} + 1 + c_{W_I} - c_{W_J} = 0 \pmod n} \left(1 - \prod_{K=J}^{I-1} \mathcal{Q}_{M_K} \prod_{K=J+1}^I \mathcal{Q}_K x^{A_{\blacksquare, W_I}^{++}} y^{L_{\blacksquare, W_I}} \right)^{-1}$$

6. FROM n -COLOURED 5D STRIPS TO n -COLOURED 4D INSTANTON PARTITION FUNCTIONS

We take the 4D limit of the 5D strip partition function to obtain the corresponding 4D instanton partition function.

6.1. Parameters. The parameters x, y of the n -coloured topological vertex and the parameters ϵ_1, ϵ_2 of the instanton partition functions are related by

$$(6.1) \quad x = e^{+R\epsilon_2}, \quad y = e^{-R\epsilon_1}.$$

Further, recall that $Q_i = e^{-R\Delta_i}, i = 1, M_1, 2, M_2, \dots, M_{N-1}, N$.

6.2. The 4D limit. For $n = 1$, taking the 4D limit is straightforward because both the numerator and the denominator of $\mathcal{S}_{(\mathbf{V}, \mathbf{c}_V)(\mathbf{W}, \mathbf{c}_W)\Delta}^{n, \text{norm}}(x, y, R)$ approach zero as $R^{N \sum_{i=1}^N (|V_i| + |W_i|)}$, in the limit $R \rightarrow 0$. For $n > 1$, this is no longer the case and $\mathcal{S}_{(\mathbf{V}, \mathbf{c}_V)(\mathbf{W}, \mathbf{c}_W)\Delta}^{n, \text{norm}}(x, y, R)$ approaches zero as R^K , in the limit $R \rightarrow 0$, for some integer K which depends on $(\mathbf{V}, \mathbf{c}_V)$ and $(\mathbf{W}, \mathbf{c}_W)$. So, to take the 4D limit, we must cancel the excess factors of R by

$$(6.2) \quad \mathcal{S}_{(\mathbf{V}, \mathbf{c}_V)(\mathbf{W}, \mathbf{c}_W)\Delta}^{n, \text{norm}}(\epsilon_1, \epsilon_2) = \lim_{R \rightarrow 0} \left(R^{-K} \mathcal{S}_{(\mathbf{V}, \mathbf{c}_V)(\mathbf{W}, \mathbf{c}_W)\Delta}^{n, \text{norm}}(x, y, R) \right),$$

to obtain ¹⁴,

$$(6.3) \quad \mathcal{S}_{(\mathbf{V}, \mathbf{c}_V)(\mathbf{W}, \mathbf{c}_W)\Delta}^{n, \text{norm}}(\epsilon_1, \epsilon_2) =$$

$$\prod_{I=1}^N \prod_{J=1}^I \prod_{\substack{\blacksquare \in W_J \\ A_{\blacksquare, W_J} + L_{\blacksquare, V_J} + 1 - c_{W_J} + c_{V_J} = 0 \pmod n}} \left(\sum_{K=J}^{I-1} \Delta_{M_K} + \sum_{K=J}^I \Delta_K + A_{\blacksquare, W_J} \epsilon_2 - L_{\blacksquare, V_J} \epsilon_1 \right)$$

$$\prod_{\substack{\square \in V_J \\ A_{\square, V_J} + L_{\square, W_J} + 1 + c_{W_J} - c_{V_J} = 0 \pmod n}} \left(\sum_{K=J}^{I-1} \Delta_{M_K} + \sum_{K=J}^I \Delta_K - A_{\square, V_J}^{++} \epsilon_2 + L_{\square, W_J}^{++} \epsilon_1 \right)$$

$$\prod_{I=1}^N \prod_{J=1}^{I-1} \prod_{\substack{\square \in V_J \\ A_{\square, V_J} + L_{\square, W_J} + 1 - c_{V_J} + c_{W_J} = 0 \pmod n}} \left(\sum_{K=J}^{I-1} \Delta_{M_K} + \sum_{K=J+1}^{I-1} \Delta_K + A_{\square, V_J}^{++} \epsilon_2 - L_{\square, W_J}^{++} \epsilon_1 \right)$$

$$\prod_{\substack{\blacksquare \in W_J \\ A_{\blacksquare, W_J} + L_{\blacksquare, V_J} + 1 + c_{V_J} - c_{W_J} = 0 \pmod n}} \left(\sum_{K=J}^{I-1} \Delta_{M_K} + \sum_{K=J+1}^{I-1} \Delta_K - A_{\blacksquare, W_J} \epsilon_2 + L_{\blacksquare, V_J} \epsilon_1 \right)$$

$$\prod_{I=1}^N \left(\prod_{\substack{\square \in V_I \\ A_{\square, V_I} + L_{\square, W_I} + 1 = 0 \pmod n}} \left(-A_{\square, V_I}^{++} \epsilon_2 + L_{\square, W_I} \epsilon_1 \right)^{-1} \prod_{\substack{\blacksquare \in W_I \\ A_{\blacksquare, W_I} + L_{\blacksquare, V_I} + 1 = 0 \pmod n}} \left(-A_{\blacksquare, W_I} \epsilon_2 + L_{\blacksquare, V_I}^{++} \epsilon_1 \right)^{-1} \right)$$

$$\prod_{I=1}^N \prod_{J=1}^{I-1} \prod_{\substack{\square \in V_I \\ A_{\square, V_I} + L_{\square, W_I} + 1 - c_{V_I} + c_{W_I} = 0 \pmod n}} \left(\sum_{K=J}^{I-1} \Delta_{M_K} + \sum_{K=J}^{I-1} \Delta_K + A_{\square, V_I}^{++} \epsilon_2 - L_{\square, W_I} \epsilon_1 \right)^{-1}$$

¹⁴ We do not need the closed form expression of the factor K , and it suffices for our purposes to compute it on a case by case basis.

$$\begin{aligned}
& \prod_{\substack{\square \in V_J \\ A_{\square, V_J} + L_{\square, V_J} + 1 + c_{V_J} - c_{V_J} = 0 \pmod n}} \left(\sum_{K=J}^{I-1} \Delta_{M_K} + \sum_{K=J}^{I-1} \Delta_K - A_{\square, V_J} \epsilon_2 + L_{\square, V_J}^{++} \right)^{-1} \\
& \prod_{I=1}^N \prod_{J=1}^{I-1} \prod_{\substack{\blacksquare \in W_I \\ A_{\blacksquare, W_I} + L_{\blacksquare, W_I} + 1 - c_{W_I} + c_{W_I} = 0 \pmod n}} \left(\sum_{K=J}^{I-1} \Delta_{M_K} + \sum_{K=J+1}^I \Delta_K + A_{\blacksquare, W_I} \epsilon_2 - L_{\blacksquare, W_I}^{++} \epsilon_1 \right)^{-1} \\
& \prod_{\substack{\blacksquare \in W_J \\ A_{\blacksquare, W_J} + L_{\blacksquare, W_J} + 1 + c_{W_J} - c_{W_J} = 0 \pmod n}} \left(\sum_{K=J}^{I-1} \Delta_{M_K} + \sum_{K=J+1}^I \Delta_K - A_{\blacksquare, W_J}^{++} \epsilon_2 + L_{\blacksquare, W_J} \epsilon_1 \right)^{-1}
\end{aligned}$$

6.3. Comparison with the $\mathbb{R}^4/\mathbb{Z}_n$ 4D instanton partition function. The $\mathbb{R}^4/\mathbb{Z}_n$ 4D instanton partition function is,

$$(6.4) \quad \mathcal{Z}^n(\mathbf{a}, \mathbf{V}, \mathbf{c}_V | \mu | \mathbf{b}, \mathbf{W}, \mathbf{c}_W) = \frac{\mathcal{Z}^{n, num}(\mathbf{a}, \mathbf{V}, \mathbf{c}_V | \mu | \mathbf{b}, \mathbf{W}, \mathbf{c}_W)}{\mathcal{Z}^{n, den}(\mathbf{a}, \mathbf{V}, \mathbf{c}_V | \mathbf{b}, \mathbf{W}, \mathbf{c}_W)}$$

where

$$(6.5) \quad \mathcal{Z}^{n, num}(\mathbf{a}, \mathbf{V}, \mathbf{c}_V | \mu | \mathbf{b}, \mathbf{W}, \mathbf{c}_W) = \prod_{I, J=1}^N \prod_{\substack{\square \in V_I \\ A_{\square, V_I} + L_{\square, V_I} + 1 - c_{V_I} + c_{W_J} = 0 \pmod n}} (a_I - b_J - \mu + A_{\square, V_I}^{++} \epsilon_2 - L_{\square, W_J} \epsilon_1) \prod_{\substack{\blacksquare \in W_J \\ A_{\blacksquare, W_J} + L_{\blacksquare, V_I} + 1 + c_{V_I} - c_{W_J} = 0 \pmod n}} (a_I - b_J - \mu - A_{\blacksquare, W_J} \epsilon_2 + L_{\blacksquare, V_I}^{++} \epsilon_1)$$

and,

$$(6.6) \quad \mathcal{Z}_{den}^n(\mathbf{a}, \mathbf{V}, \mathbf{c}_V | \mathbf{b}, \mathbf{W}, \mathbf{c}_W) = \left(\mathcal{Z}^{n, num}(\mathbf{a}, \mathbf{V}, \mathbf{c}_V | 0 | \mathbf{a}, \mathbf{V}, \mathbf{c}_V) \mathcal{Z}^{n, num}(\mathbf{b}, \mathbf{W}, \mathbf{c}_W | 0 | \mathbf{b}, \mathbf{W}, \mathbf{c}_W) \right)^{\frac{1}{2}} = \prod_{I, J=1}^N \prod_{\substack{\square \in V_I \\ A_{\square, V_I} + L_{\square, V_I} + 1 - c_{V_I} + c_{V_J} = 0 \pmod n}} (a_I - a_J + A_{\square, V_I}^{++} \epsilon_2 - L_{\square, V_J} \epsilon_1)^{\frac{1}{2}} \prod_{\substack{\square \in V_J \\ A_{\square, V_J} + L_{\square, V_I} + 1 + c_{V_I} - c_{V_J} = 0 \pmod n}} (a_I - a_J - A_{\square, V_J} \epsilon_2 + L_{\square, V_I}^{++} \epsilon_1)^{\frac{1}{2}} \prod_{I, J=1}^N \prod_{\substack{\blacksquare \in W_I \\ A_{\blacksquare, W_I} + L_{\blacksquare, W_J} + 1 - c_{W_I} + c_{W_J} = 0 \pmod n}} (b_I - b_J + A_{\blacksquare, W_I}^{++} \epsilon_2 - L_{\blacksquare, W_J} \epsilon_1)^{\frac{1}{2}} \prod_{\substack{\blacksquare \in W_J \\ A_{\blacksquare, W_J} + L_{\blacksquare, W_I} + 1 + c_{W_I} - c_{W_J} = 0 \pmod n}} (b_I - b_J - A_{\blacksquare, W_J} \epsilon_2 + L_{\blacksquare, W_I}^{++} \epsilon_1)^{\frac{1}{2}},$$

where, $\mathbf{a} = (a_1, \dots, a_N)$ and $\mathbf{b} = (b_1, \dots, b_N)$ are Coulomb parameters, μ is a mass parameter and ϵ_1, ϵ_2 are deformation parameters.

6.3.1. *Parameter identification.* To compare the 4D strip partition function to the 4D instanton partition functions, we substitute

$$(6.7) \quad \boxed{\Delta_i = -a_i + b_i + \mu - \epsilon_1, \quad \Delta_{M_i} = a_{i+1} - b_i - \mu + \epsilon_1, \quad i = 1, \dots, N}$$

where $a_i = a_{i+N}$, and $b_i = b_{i+N}$, into Equation 6.3, to obtain,

$$(6.8) \quad \mathcal{S}_{(V, c_V)(W, c_W)\Delta}^{n, \text{norm}}(\epsilon_1, \epsilon_2) =$$

$$\prod_{I=1}^N \prod_{J=1}^I \prod_{\substack{\square \in V_J \\ A_{\square, V_J} + L_{\square, W_J} + 1 + c_{W_J} - c_{V_J} = 0 \pmod n}} - (a_J - b_I - \mu + A_{\square, V_J}^{++} \epsilon_2 - L_{\square, W_J} \epsilon_1)$$

$$\prod_{\substack{\blacksquare \in W_I \\ A_{\blacksquare, W_I} + L_{\blacksquare, V_I} + 1 - c_{W_I} + c_{V_I} = 0 \pmod n}} - (a_J - b_I - \mu - A_{\blacksquare, W_I} \epsilon_2 + L_{\blacksquare, V_I}^{++} \epsilon_1)$$

$$\prod_{I=1}^N \prod_{J=1}^{I-1} \prod_{\substack{\square \in V_I \\ A_{\square, V_I} + L_{\square, W_J} + 1 - c_{V_I} + c_{W_J} = 0 \pmod n}} (a_I - b_J - \mu + A_{\square, V_I}^{++} \epsilon_2 - L_{\square, W_J} \epsilon_1)$$

$$\prod_{\substack{\blacksquare \in W_J \\ A_{\blacksquare, W_J} + L_{\blacksquare, V_I} + 1 + c_{V_I} - c_{W_J} = 0 \pmod n}} (a_I - b_J - \mu - A_{\blacksquare, W_J} \epsilon_2 + L_{\blacksquare, V_I}^{++} \epsilon_1)$$

$$\prod_{I=1}^N \left(\prod_{\substack{\square \in V_I \\ A_{\square, V_I} + L_{\square, V_I} + 1 = 0 \pmod n}} - (A_{\square, V_I}^{++} \epsilon_2 - L_{\square, V_I} \epsilon_1)^{-1} \prod_{\substack{\blacksquare \in W_I \\ A_{\blacksquare, W_I} + L_{\blacksquare, W_I} + 1 = 0 \pmod n}} (-A_{\blacksquare, W_I} \epsilon_2 + L_{\blacksquare, W_I}^{++} \epsilon_1)^{-1} \right)$$

$$\prod_{I=1}^N \prod_{J=1}^{I-1} \prod_{\substack{\square \in V_I \\ A_{\square, V_I} + L_{\square, V_J} + 1 - c_{V_I} + c_{V_J} = 0 \pmod n}} (a_I - a_J + A_{\square, V_I}^{++} \epsilon_2 - L_{\square, V_J} \epsilon_1)^{-1}$$

$$\prod_{\substack{\square \in V_J \\ A_{\square, V_J} + L_{\square, V_I} + 1 + c_{V_I} - c_{V_J} = 0 \pmod n}} (a_I - a_J - A_{\square, V_J} \epsilon_2 + L_{\square, V_I}^{++} \epsilon_1)^{-1}$$

$$\prod_{I=1}^N \prod_{J=1}^{I-1} \prod_{\substack{\blacksquare \in W_I \\ A_{\blacksquare, W_I} + L_{\blacksquare, W_J} + 1 - c_{W_I} + c_{W_J} = 0 \pmod n}} - (b_J - b_I - A_{\blacksquare, W_I} \epsilon_2 + L_{\blacksquare, W_J}^{++} \epsilon_1)^{-1}$$

$$\prod_{\substack{\blacksquare \in W_J \\ A_{\blacksquare, W_J} + L_{\blacksquare, W_I} + 1 + c_{W_I} - c_{W_J} = 0 \pmod n}} - (b_J - b_I + A_{\blacksquare, W_J}^{++} \epsilon_2 - L_{\blacksquare, W_I} \epsilon_1)^{-1}$$

$$= \frac{\mathcal{S}_{(V, c_V)(W, c_W)\Delta}^{n, \text{num}}(\epsilon_1, \epsilon_2)}{\mathcal{S}_{den(V, c_V)(W, c_W)\Delta}^n(\epsilon_1, \epsilon_2)}$$

6.3.2. *Sign factors and abbreviations.* We define,

$$(6.9) \quad F(\mathbf{V}, \mathbf{c}_V | \mathbf{W}, \mathbf{c}_W) = \frac{F^{num}(\mathbf{V}, \mathbf{c}_V | \mathbf{W}, \mathbf{c}_W)}{F^{den}(\mathbf{V}, \mathbf{c}_V | \mathbf{W}, \mathbf{c}_W)},$$

$$(6.10) \quad F^{num}(\mathbf{V}, \mathbf{c}_V | \mathbf{W}, \mathbf{c}_W) = \prod_{I=1}^N \prod_{J=1}^I \prod_{\substack{\square \in V_J \\ A_{\square, V_J} + L_{\square, V_J} + 1 + c_{W_I} - c_{V_J} = 0 \pmod n}} (-1) \prod_{\substack{\blacksquare \in W_I \\ A_{\blacksquare, W_I} + L_{\blacksquare, W_I} + 1 - c_{W_I} + c_{V_J} = 0 \pmod n}} (-1)$$

$$(6.11) \quad F^{den}(\mathbf{V}, \mathbf{c}_V | \mathbf{W}, \mathbf{c}_W) = \prod_{I=1}^N \prod_{\substack{\square \in V_I \\ A_{\square, V_I} + L_{\square, V_I} + 1 - c_{V_I} - c_{V_J} = 0 \pmod n}} (-1) \\ \prod_{I=1}^N \prod_{J=1}^{I-1} \prod_{\substack{\blacksquare \in W_J \\ A_{\blacksquare, W_J} + L_{\blacksquare, W_J} + 1 - c_{W_I} + c_{W_J} = 0 \pmod n}} (-1) \prod_{\substack{\blacksquare \in W_I \\ A_{\blacksquare, W_I} + L_{\blacksquare, W_I} + 1 + c_{W_I} - c_{W_J} = 0 \pmod n}} (-1)$$

and introduce the abbreviations,

$$(6.12) \quad \mathcal{H}_{Y_{IJ}}(\mathbf{x}, \mathbf{c}_Y) = \mathcal{A}_{Y_{IJ}}(\mathbf{x}, \mathbf{c}_Y) \mathcal{L}_{Y_{IJ}}(\mathbf{x}, \mathbf{c}_Y),$$

where,

$$(6.13) \quad \mathcal{A}_{V_{IJ}}(\mathbf{x}, \mathbf{c}_V) = \prod_{\substack{\square \in V_I \\ A_{\square, V_I} + L_{\square, V_I} + 1 - c_{V_I} + c_{V_J} = 0 \pmod n}} (x_I - x_J + A_{\square, V_I}^+ \epsilon_2 - L_{\square, V_I} \epsilon_1), \quad \mathcal{A}_{\emptyset, \emptyset}(\mathbf{x}, \mathbf{c}_V) = 1,$$

$$(6.14) \quad \mathcal{L}_{W_{IJ}}(\mathbf{x}, \mathbf{c}_W) = \prod_{\substack{\blacksquare \in W_J \\ A_{\blacksquare, W_J} + L_{\blacksquare, W_J} + 1 + c_{W_I} - c_{W_J} = 0 \pmod n}} (x_I - x_J - A_{\blacksquare, W_J} \epsilon_2 + L_{\blacksquare, W_I}^+ \epsilon_1), \quad \mathcal{L}_{\emptyset, \emptyset}(\mathbf{x}, \mathbf{c}_W) = 1,$$

6.3.3. *Comparing the numerators.* The numerators $\mathcal{S}_{(\mathbf{V}, \mathbf{c}_V)(\mathbf{W}, \mathbf{c}_W)\Delta}^{n, num}(\epsilon_1, \epsilon_2)$ and $\mathcal{Z}^{n, num}(\mathbf{a}, \mathbf{V}, \mathbf{c}_V | \mu | \mathbf{b}, \mathbf{W}, \mathbf{c}_W)$ are identical up to possible overall signs,

$$(6.15) \quad \mathcal{S}_{(\mathbf{V}, \mathbf{c}_V)(\mathbf{W}, \mathbf{c}_W)\Delta}^{n, num}(\epsilon_1, \epsilon_2) = F^{num}(\mathbf{V}, \mathbf{c}_V | \mathbf{W}, \mathbf{c}_W) \mathcal{Z}^{n, num}(\mathbf{a}, \mathbf{V}, \mathbf{c}_V | \mu | \mathbf{b}, \mathbf{W}, \mathbf{c}_W)$$

6.3.4. *Comparing the denominators.* The denominators are,

$$(6.16) \quad \mathcal{S}_{den(\mathbf{V}, \mathbf{c}_V)(\mathbf{W}, \mathbf{c}_W)\Delta}^n(\epsilon_1, \epsilon_2) = \\ F^{den}(\mathbf{V}, \mathbf{c}_V | \mathbf{W}, \mathbf{c}_W) \prod_{I=1}^N \mathcal{A}_{V_{II}}(\mathbf{a}, \mathbf{c}_V) \mathcal{L}_{W_{II}}(\mathbf{b}, \mathbf{c}_W) \prod_{J=1}^N \prod_{I=1}^{J-1} \mathcal{H}_{V_{JI}}(\mathbf{a}, \mathbf{c}_V) \mathcal{H}_{W_{IJ}}(\mathbf{b}, \mathbf{c}_W)$$

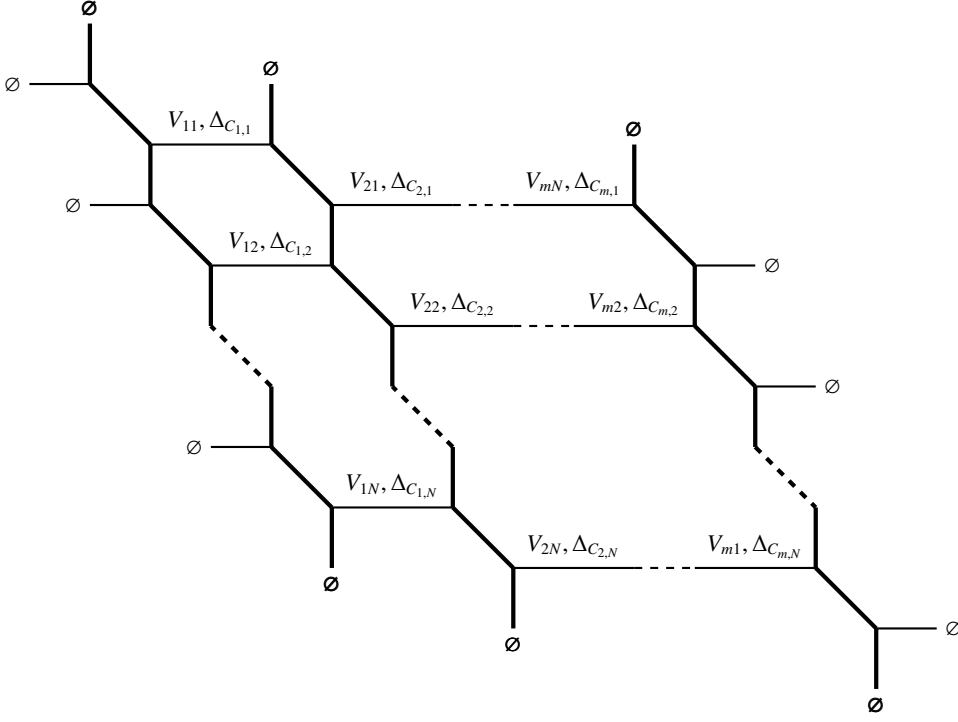

FIGURE 7.1. The linear web diagram constructed by gluing $(m + 1)$ N -strip diagrams. Each N -strip is linked to the next by a series of internal horizontal edges assigned with Kähler parameters $\Delta_{C_{ij}}$ and sum over all possible associated Young diagrams $\mathbf{V}_i = (V_{i1}, \dots, V_{iN})$ in a given series.

and

$$(6.17) \quad \mathcal{Z}_{den}^n(\mathbf{a}, \mathbf{V}, \mathbf{c}_V | \mathbf{b}, \mathbf{W}, \mathbf{c}_W) = \prod_{I=1}^N \prod_{J=1}^N (\mathcal{H}_{V_{IJ}}(\mathbf{a}, \mathbf{c}_V) \mathcal{H}_{W_{IJ}}(\mathbf{b}, \mathbf{c}_W))^{1/2}$$

In other words, $\mathcal{S}_{(\mathbf{v}, \mathbf{c}_V)}^{n, norm}(\mathbf{w}, \mathbf{c}_W)_{\Delta}(\epsilon_1, \epsilon_2)$ and $\mathcal{Z}^{n, norm}(\mathbf{a}, \mathbf{V}, \mathbf{c}_V | \mu | \mathbf{b}, \mathbf{W}, \mathbf{c}_W)$ have different denominators. However, we show in the sequel that in computing linear as well as cyclic 4D instanton partition functions, we get exactly the same result by using $\mathcal{S}^{n, norm}$ (with an appropriate choice of framing factors) and by using $\mathcal{Z}^{n, norm}$.

7. FROM n -COLOURED 5D STRIPS TO n -COLOURED 5D WEBS

We glue 5D n -coloured strip diagrams to form 5D n -coloured web diagrams.

The linear and cyclic web diagram topological partition functions are obtained from Figures 7.1 and 7.2, once the horizontal edge factors are specified. The answer takes the general form,

$$(7.1) \quad \mathcal{S}^n(x, y, R) = \sum_{(\mathbf{v}_1, \mathbf{c}_{V_1}), \dots, (\mathbf{v}_p, \mathbf{c}_{V_p})} \mathcal{S}_{(\mathbf{v}_1, \mathbf{c}_{V_1}), (\mathbf{v}_2, \mathbf{c}_{V_2}), \dots, (\mathbf{v}_m, \mathbf{c}_{V_m})}^{n, block}(x, y, R)$$

where $\mathcal{S}_{(\mathbf{v}_1, \mathbf{c}_{V_1}), (\mathbf{v}_2, \mathbf{c}_{V_2}), \dots, (\mathbf{v}_p, \mathbf{c}_{V_p})}^{n, block}(x, y, R)$ is a product of factors of type $\mathcal{S}_{(\mathbf{v}_i, \mathbf{c}_{V_i})}^{p, norm}(\mathbf{v}_{i+1}, \mathbf{c}_{V_{i+1}})_{\Delta_{i,i+1}}$ for every strip, and an edge factor for every internal horizontal edge.

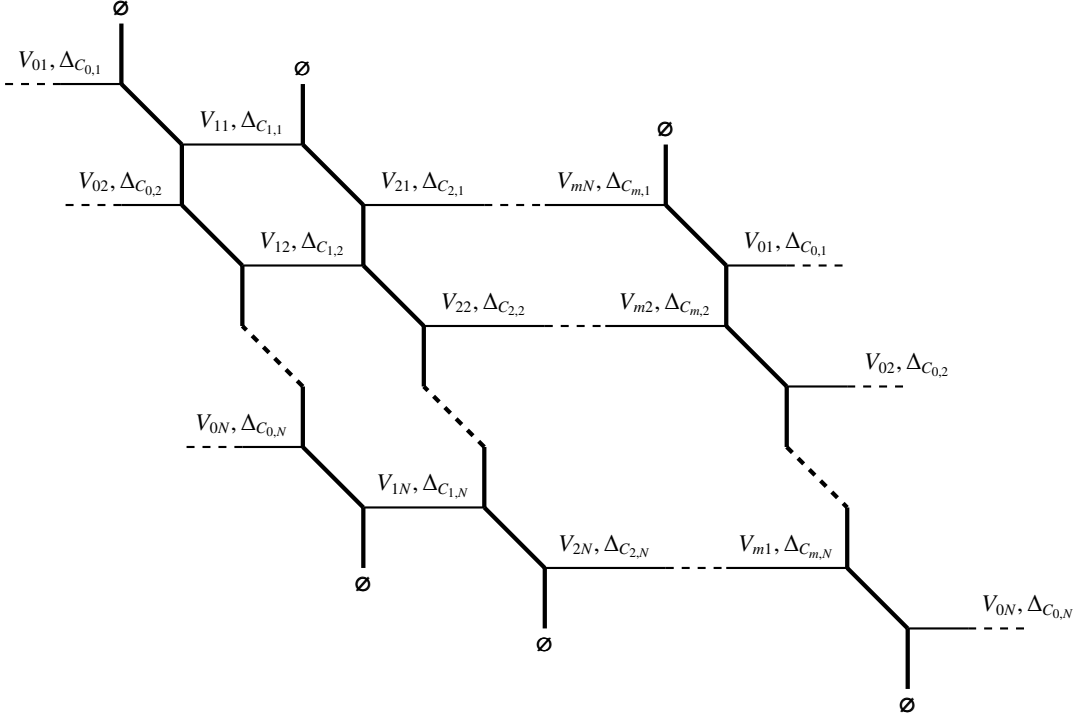

FIGURE 7.2. The cyclic web diagram constructed by gluing the first and the last N -strips in the linear web diagram.

7.1. **The summation in Equation 7.1.** For $n = 1$, the summation is over all N -Young diagrams because the moduli space of instantons on \mathbb{C}^2 is connected, and the localization theorem requires that we sum over the contributions of all fixed points, each of which is labelled by N -Young diagrams. For $n = 2, 3, \dots$, the moduli space of instantons on $\mathbb{C}^2/\mathbb{Z}_n$ is a union of disjoint smaller spaces [28], and the summation in Equation 7.1 is not over all possible charged N -Young diagrams, but restricted to certain series of charged Young diagrams.

7.2. **(\mathbf{N}, \mathbf{k}) -type Young diagrams.** Following [4, 32], given $(\mathbf{Y}, \mathbf{c}_Y) = ((Y_1, c_{Y_1}), \dots, (Y_N, c_{Y_N}))$, we define $\mathbf{N} = (N_0, \dots, N_{n-1})$, where N_c is the number of Young diagrams of charge c . Further, we define $\mathbf{k} = (k_0, \dots, k_{n-1})$, where k_c is the number of cells with coordinates $(i, j) \in Y_i$, $i = 1, \dots, N$ (that is, in all Young diagrams), such that,

$$(7.2) \quad c_{Y_i} + (i - 1) - (j - 1) = c, \quad c \in (0, \dots, n - 1)$$

and say that $(\mathbf{Y}, \mathbf{c}_Y)$ is of (\mathbf{N}, \mathbf{k}) -type. Clearly, $\sum_{c=0}^{n-1} N_c = N$, and $\sum_{c=0}^{n-1} k_c = \sum_{I=1}^N |Y_I|$.

7.3. **(\mathbf{N}, \mathbf{u}) -series of solutions.** Let $\mathbf{u} = (u_1, \dots, u_{n-1})$ be given by¹⁵,

$$(7.3) \quad u_i = N_i + (k_{i-1} - 2k_i + k_{i+1}),$$

then, for fixed \mathbf{u} , solve Equation 7.3 to find all possible values of (\mathbf{N}, \mathbf{k}) . For fixed \mathbf{N} , there may be no solutions, or there may be infinitely-many solutions \mathbf{k} that satisfy Equation 7.3. In the latter (relevant)

¹⁵ \mathbf{u} is related to the first Chern class of the instanton gauge bundle $c_1(E) = \sum_{i=1}^{n-1} u_i c_1(\mathcal{T}_i)$, [28, 4].

case, for a corresponding fixed \mathbf{N} , \mathbf{k} is a sequence in $\mathbb{Z}_{\geq 0}^n$ indexed by $k_0 = r \in \mathbb{Z}_{\geq 0}$ which we denote by $\mathbf{k}(r)$. We define,

$$(7.4) \quad (\mathbf{N}, \mathbf{u})\text{-series} = \left((\mathbf{Y}, \mathbf{c}_Y) \mid (\mathbf{Y}, \mathbf{c}_Y) \text{ is of } (\mathbf{N}, \mathbf{k})\text{-type for } \mathbf{k} \text{ such that } \mathbf{N} \text{ and } \mathbf{k} \text{ satisfy (7.3)} \right)$$

$$(7.5) \quad = \left((\mathbf{Y}, \mathbf{c}_Y) \mid (\mathbf{Y}, \mathbf{c}_Y) \text{ is of } (\mathbf{N}, \mathbf{k}(r))\text{-type for some } r \in \mathbb{Z}_{\geq 0} \right),$$

and restrict the summation in $(\mathbf{Y}, \mathbf{c}_Y)$ to one or more of these series.

7.4. Example. For $N = 2$, $n = 4$, and $\mathbf{u} = (0, 0, 0)$, there are three (\mathbf{N}, \mathbf{k}) -series¹⁶,

$$(7.6) \quad \text{Series 1: } \mathbf{N} = (2, 0, 0, 0), \quad \mathbf{k} = (r, r, r, r)$$

$$(7.7) \quad \text{Series 2: } \mathbf{N} = (0, 1, 0, 1), \quad \mathbf{k} = (r, r+1, r+1, r+1)$$

$$(7.8) \quad \text{Series 3: } \mathbf{N} = (0, 0, 2, 0), \quad \mathbf{k} = (r, r+1, r+2, r+1)$$

for $r \in \mathbb{Z}_{\geq 0}$. This gives rise to three series of charged Young diagrams $(\mathbf{Y}, \mathbf{c}_Y)$. The charges \mathbf{c}_Y are fixed within the series by \mathbf{N} ,

$$\text{Series 1: } \mathbf{c}_Y = (0, 0)$$

$$\text{Series 2: } \mathbf{c}_Y = (1, 3) \quad \text{or equivalently} \quad \mathbf{c}_Y = (3, 1)$$

$$\text{Series 3: } \mathbf{c}_Y = (2, 2)$$

Switching $\mathbf{c}_Y = (1, 3)$ and $\mathbf{c}_Y = (3, 1)$ is the same as switching the labels of Y_1 and Y_2 in the summation, hence they are equivalent. The summation in Equation 7.1 is restricted to one or more of these series.

7.5. The edge factors. For the I -th line between $\mathcal{S}_{(\mathbf{v}_{i-1}, \mathbf{c}_{\mathbf{v}_{i-1}})(\mathbf{v}_i, \mathbf{c}_{\mathbf{v}_i})\Delta_{i-1,i}}^{n, \text{norm}}$ and $\mathcal{S}_{(\mathbf{v}_i, \mathbf{c}_{\mathbf{v}_i})(\mathbf{v}_{i+1}, \mathbf{c}_{\mathbf{v}_{i+1}})\Delta_{i,i+1}}^{n, \text{norm}}$, we define,

$$(7.9) \quad \text{Edge factor} = \left(-Q_{C_{iI}} \right)^{|V_{iI}|} f_{i-1,i,i+1,I}^n,$$

with $Q_{C_{iI}} = z_i e^{-R\Delta_{C_{iI}}}$, where z_i is an instanton expansion parameter, and the framing factor $f_{i-1,i,i+1,I}^n$ is,

$$(7.10) \quad f_{i-1,i,i+1,I}^n = (-1)^{|V_{iI}|} f_{i-1,i,I}^{n, \text{left}} f_{i,i+1,I}^{n, \text{right}}$$

$$(7.11) \quad f_{i,i+1,I}^{n, \text{right}} = \prod_{J=I}^N \prod_{\substack{\square \in V_{iI} \\ A_{\square, V_{iI}} + L_{\square, V_{i+1, J}} + 1 \\ + c_{V_{i+1, J}} - c_{V_{iI}} = 0 \pmod n}} (-1) \prod_{J=1}^I \prod_{\substack{\square \in V_{iI} \\ A_{\square, V_{iI}} + L_{\square, V_{iJ}} + 1 \\ - c_{V_{iI}} - c_{V_{iJ}} = 0 \pmod n}} (-1)$$

¹⁶ We use this example, which can be found in [4], to reproduce the same result.

$$(7.12) \quad f_{i-1,i,I}^{n,left} = \prod_{J=1}^I \prod_{\substack{\square \in V_{iI} \\ A_{\square,V_{iI}} + L_{\square,V_{i-1,J}} + 1 \\ -c_{V_{iI}} + c_{V_{i-1,J}} = 0 \pmod n}} (-1) \prod_{J=1}^{I-1} \prod_{\substack{\square \in V_{iI} \\ A_{\square,V_{iI}} + L_{\square,V_{iJ}} + 1 \\ -c_{V_{iI}} + c_{V_{iJ}} = 0 \pmod n}} (-1) \prod_{J=I+1}^N \prod_{\substack{\square \in V_{iI} \\ A_{\square,V_{iI}} + L_{\square,V_{iJ}} + 1 \\ +c_{V_{iJ}} - c_{V_{iI}} = 0 \pmod n}} (-1) \quad (-1)$$

The framing factor is designed to take care of the sign difference between the conformal blocks calculated from \mathcal{Z}^n and $\mathcal{S}^{n,norm}$. When $n = 1$, the framing factor is,

$$(7.13) \quad f_{i-1,i,i+1,I}^{p=1} = (-1)^{|V_{iI}|} \prod_{J=I}^N \prod_{\square \in V_{iI}} (-1) \prod_{J=1}^I \prod_{\square \in V_{iI}} (-1) \prod_{\square \in V_{iI}} (-1) \prod_{J=1}^{I-1} \prod_{\square \in V_{iI}} (-1) \prod_{J=I+1}^N \prod_{\square \in V_{iI}} (-1) \\ = (-1)^{|V_{iI}|} (-1)^{(N-I+1)|V_{iI}|} (-1)^{I|V_{iI}|} (-1)^{|V_{iI}|} (-1)^{(I-1)|V_{iI}|} (-1)^{(N-I)|V_{iI}|} = 1$$

\mathcal{S}_N^{5D} is given in terms of N -strip partition functions for linear and cyclic cases as follows,

7.5.1. *Linear conformal blocks.* (See Figure 7.1)

$$(7.14) \quad \mathcal{S}_{(\mathbf{v}_1, \mathbf{c}_{\mathbf{v}_1}), (\mathbf{v}_2, \mathbf{c}_{\mathbf{v}_2}), \dots, (\mathbf{v}_m, \mathbf{c}_{\mathbf{v}_m})}^{n,linear\ block} (x, y, R) \\ = \mathcal{S}_{(\emptyset, \mathbf{c}_{\emptyset_0}) (\mathbf{v}_1, \mathbf{c}_{\mathbf{v}_1}) \Delta_{01}}^{n,norm} (x, y, R) \left(\prod_{I=1}^N (-Q_{C_{iI}})^{|V_{iI}|} f_{012,I}^n \right) \mathcal{S}_{(\mathbf{v}_1, \mathbf{c}_{\mathbf{v}_1}) (\mathbf{v}_2, \mathbf{c}_{\mathbf{v}_2}) \Delta_{12}}^{n,norm} (x, y, R) \cdots \\ \cdots \mathcal{S}_{(\mathbf{v}_{m-1}, \mathbf{c}_{\mathbf{v}_{m-1}}) (\mathbf{v}_m, \mathbf{c}_{\mathbf{v}_m}) \Delta_{m-1,m}}^{n,norm} (x, y, R) \left(\prod_{I=1}^N (-Q_{C_{m,I}})^{|V_{m,I}|} f_{m-1,m,m+1,I}^n \right) \mathcal{S}_{(\mathbf{v}_p, \mathbf{c}_{\mathbf{v}_p}) (\emptyset, \mathbf{c}_{\emptyset_{m+1}}) \Delta_{m,m+1}}^{n,norm} (x, y, R)$$

7.5.2. *Cyclic conformal blocks.* (See Figure 7.2)

$$(7.15) \quad \mathcal{S}_{(\mathbf{v}_0, \mathbf{c}_{\mathbf{v}_0}), (\mathbf{v}_1, \mathbf{c}_{\mathbf{v}_1}), (\mathbf{v}_2, \mathbf{c}_{\mathbf{v}_2}), \dots, (\mathbf{v}_m, \mathbf{c}_{\mathbf{v}_m})}^{n,cyclic\ block} (x, y, R) \\ = \mathcal{S}_{(\mathbf{v}_0, \mathbf{c}_{\mathbf{v}_0}) (\mathbf{v}_1, \mathbf{c}_{\mathbf{v}_1}) \Delta_{01}}^{n,norm} (x, y, R) \left(\prod_{I=1}^N (-Q_{C_{iI}})^{|V_{iI}|} f_{012,I}^n \right) \mathcal{S}_{(\mathbf{v}_1, \mathbf{c}_{\mathbf{v}_1}) (\mathbf{v}_2, \mathbf{c}_{\mathbf{v}_2}) \Delta_{12}}^{n,norm} (x, y, R) \cdots \\ \cdots \mathcal{S}_{(\mathbf{v}_{m-1}, \mathbf{c}_{\mathbf{v}_{m-1}}) (\mathbf{v}_m, \mathbf{c}_{\mathbf{v}_m}) \Delta_{m-1,m}}^{n,norm} (x, y, R) \left(\prod_{I=1}^N (-Q_{C_{m,I}})^{|V_{m,I}|} f_{m-1,m,0,I}^n \right) \mathcal{S}_{(\mathbf{v}_m, \mathbf{c}_{\mathbf{v}_m}) (\mathbf{v}_0, \mathbf{c}_{\mathbf{v}_0}) \Delta_{m0}}^{n,norm} (x, y, R) \\ \left(\prod_{I=1}^N (-Q_{C_{0,I}})^{|V_{0,I}|} f_{m01,I}^n \right)$$

8. THE 4D LIMIT OF THE 5D n -COLOURED WEB DIAGRAMS

We take the 4D limit of the 5D n -coloured web diagrams, and show that $\mathcal{S}^{n,norm}$ and $\mathcal{Z}_N^{n,4D}$ lead to the same 4D instanton partition functions.

Given a pair of charged N -Young diagrams $(\mathbf{V}, \mathbf{c}_{\mathbf{V}})$ and $(\mathbf{W}, \mathbf{c}_{\mathbf{W}})$ of $(\mathbf{N}_{\mathbf{V}}, \mathbf{k}_{\mathbf{V}})$ -type and $(\mathbf{N}_{\mathbf{W}}, \mathbf{k}_{\mathbf{W}})$ -type respectively, the number of factors that appear in $\mathcal{Z}^{n,num}(\mathbf{a}, \mathbf{V}, \mathbf{c}_{\mathbf{V}} | \mu | \mathbf{b}, \mathbf{W}, \mathbf{c}_{\mathbf{W}})$ (as given in Equation 6.5) is,

$$(8.1) \quad K_n(\mathbf{N}_V, \mathbf{k}_V | \mathbf{N}_W, \mathbf{k}_W) = \sum_{c=0}^{n-1} (k_{V,c+1} k_{W,c} - 2k_{V,c} k_{W,c} + k_{V,c} k_{W,c+1} + N_{V,c} k_{W,c} + N_{W,c} k_{V,c})$$

For the web diagram partition function in Equation 7.1, where $(\mathbf{V}_i, \mathbf{c}_{V_i})$ is a $(\mathbf{N}_i, \mathbf{u}_i)$ -series,

$$(8.2) \quad \begin{aligned} \mathcal{S}^n(x, y, R) &= \sum_{(\mathbf{V}_1, \mathbf{c}_{V_1}) \in (\mathbf{N}_1, \mathbf{u}_1)\text{-series}} \cdots \sum_{(\mathbf{V}_m, \mathbf{c}_{V_m}) \in (\mathbf{N}_m, \mathbf{u}_m)\text{-series}} \mathcal{S}_{(\mathbf{V}_1, \mathbf{c}_{V_1}), (\mathbf{V}_2, \mathbf{c}_{V_2}), \dots, (\mathbf{V}_m, \mathbf{c}_{V_m})}^{n, block}(x, y, R) \\ &= \sum_{m_1, \dots, m_n=0}^{\infty} \sum_{(\mathbf{V}_1, \mathbf{c}_{V_1}) \text{ is } (\mathbf{N}_1, \mathbf{k}_1(m_1))\text{-type}} \cdots \sum_{(\mathbf{V}_n, \mathbf{c}_{V_n}) \text{ is } (\mathbf{N}_n, \mathbf{k}_n(m_n))\text{-type}} \mathcal{S}_{(\mathbf{V}_1, \mathbf{c}_{V_1}), (\mathbf{V}_2, \mathbf{c}_{V_2}), \dots, (\mathbf{V}_m, \mathbf{c}_{V_m})}^{n, block}(x, y, R) \end{aligned}$$

we multiply each summand of $\mathcal{S}^n(x, y, R)$ with (r_1, \dots, r_m) by a factor of,

$$(8.3) \quad R^{\sum_{i=0}^p (K_n(\mathbf{N}_i, \mathbf{k}_i(r_i) | \mathbf{N}_i, \mathbf{k}_i(r_i)) - K_n(\mathbf{N}_i, \mathbf{k}_i(r_i) | \mathbf{N}_{i+1}, \mathbf{k}_{i+1}(r_{i+1})))}$$

with either linear or cyclic boundary conditions for $(\mathbf{N}_i, \mathbf{k}_i)$ for a linear or a cyclic web diagram, respectively. For linear conformal blocks,

$$(8.4) \quad (\mathbf{N}_0, \mathbf{k}_0) = (\mathbf{N}_{\emptyset_0}, \mathbf{0}), \quad (\mathbf{N}_{m+1}, \mathbf{k}_0) = (\mathbf{N}_{\emptyset_{m+1}}, \mathbf{0}),$$

where $N_{\emptyset_i, c}$ is the number of \mathbb{Z}_n -charges in \mathbf{c}_{\emptyset_i} that are equal to c , $i = 0, m+1$. For cyclic conformal blocks,

$$(8.5) \quad (\mathbf{N}_0, \mathbf{k}_0) = (\mathbf{0}, \mathbf{0}), \quad (\mathbf{N}_{m+1}, \mathbf{k}_{m+1}) = (\mathbf{N}_1, \mathbf{k}_1)$$

In the limit $R \rightarrow 0$,

$$(8.6) \quad \begin{aligned} \mathcal{S}^n(\epsilon_1, \epsilon_2) &= \lim_{R \rightarrow 0} \sum_{m_1, \dots, m_p=0}^{\infty} R^{\sum_{i=0}^p (K_n(\mathbf{N}_i, \mathbf{k}_i(r_i) | \mathbf{N}_i, \mathbf{k}_i(r_i)) - K_n(\mathbf{N}_i, \mathbf{k}_i(r_i) | \mathbf{N}_{i+1}, \mathbf{k}_{i+1}(r_{i+1})))} \\ &= \sum_{(\mathbf{V}_1, \mathbf{c}_{V_1}) \text{ is } (\mathbf{N}_1, \mathbf{k}_1(m_1))\text{-type}} \cdots \sum_{(\mathbf{V}_m, \mathbf{c}_{V_m}) \text{ is } (\mathbf{N}_m, \mathbf{k}_p(m_p))\text{-type}} \mathcal{S}_{(\mathbf{V}_1, \mathbf{c}_{V_1}), (\mathbf{V}_2, \mathbf{c}_{V_2}), \dots, (\mathbf{V}_m, \mathbf{c}_{V_m})}^{n, block}(x, y, R) \\ &= \sum_{(\mathbf{V}_1, \mathbf{c}_{V_1}) \in (\mathbf{N}_1, \mathbf{u}_1)\text{-series}} \cdots \sum_{(\mathbf{V}_m, \mathbf{c}_{V_m}) \in (\mathbf{N}_m, \mathbf{u}_m)\text{-series}} \mathcal{S}_{(\mathbf{V}_1, \mathbf{c}_{V_1}), (\mathbf{V}_2, \mathbf{c}_{V_2}), \dots, (\mathbf{V}_m, \mathbf{c}_{V_m})}^{n, block}(\epsilon_1, \epsilon_2). \end{aligned}$$

Since the 4D limit of the edge factors are,

$$(8.7) \quad \lim_{R \rightarrow 0} (-Q_{C_{il}})^{|V_{il}|} f_{i-1, i, i+1, I}^n = (-1)^{|V_{il}|} f_{i-1, i, i+1, I}^n,$$

$\mathcal{S}_{(\mathbf{V}_1, \mathbf{c}_{V_1}), (\mathbf{V}_2, \mathbf{c}_{V_2}), \dots, (\mathbf{V}_m, \mathbf{c}_{V_m})}^{n, block}(\epsilon_1, \epsilon_2)$ for linear and cyclic building blocks is

$$\begin{aligned}
(8.8) \quad & \mathcal{S}_{(\mathbf{v}_1, \mathbf{c}_{\mathbf{v}_1}), (\mathbf{v}_2, \mathbf{c}_{\mathbf{v}_2}), \dots, (\mathbf{v}_m, \mathbf{c}_{\mathbf{v}_m})}^{n, \text{linear block}} (\epsilon_1, \epsilon_2) \\
&= \mathcal{S}_{(\emptyset, \mathbf{c}_{\emptyset_0}) (\mathbf{v}_1, \mathbf{c}_{\mathbf{v}_1}) \Delta_{01}}^{n, \text{norm}} (\epsilon_1, \epsilon_2) (-1)^{\sum_{I=1}^N |V_{1I}|} \prod_{I=1}^N f_{012, I}^n \mathcal{S}_{(\mathbf{v}_1, \mathbf{c}_{\mathbf{v}_1}) (\mathbf{v}_2, \mathbf{c}_{\mathbf{v}_2}) \Delta_{12}}^{n, \text{norm}} (\epsilon_1, \epsilon_2) \cdots \\
&\cdots \mathcal{S}_{(\mathbf{v}_{m-1}, \mathbf{c}_{\mathbf{v}_{m-1}}) (\mathbf{v}_m, \mathbf{c}_{\mathbf{v}_m}) \Delta_{m-1, m}}^{n, \text{norm}} (\epsilon_1, \epsilon_2) (-1)^{\sum_{I=1}^N |V_{mI}|} \prod_{I=1}^N f_{m-1, m, m+1, I}^n \mathcal{S}_{(\mathbf{v}_m, \mathbf{c}_{\mathbf{v}_m}) (\emptyset, \mathbf{c}_{\emptyset_{m+1}}) \Delta_{m, m+1}}^{n, \text{norm}} (\epsilon_1, \epsilon_2)
\end{aligned}$$

$$\begin{aligned}
(8.9) \quad & \mathcal{S}_{(\mathbf{v}_0, \mathbf{c}_{\mathbf{v}_0}), (\mathbf{v}_1, \mathbf{c}_{\mathbf{v}_1}), (\mathbf{v}_2, \mathbf{c}_{\mathbf{v}_2}), \dots, (\mathbf{v}_m, \mathbf{c}_{\mathbf{v}_m})}^{n, \text{cyclic block}} (\epsilon_1, \epsilon_2) \\
&= \mathcal{S}_{(\mathbf{v}_0, \mathbf{c}_{\mathbf{v}_0}) (\mathbf{v}_1, \mathbf{c}_{\mathbf{v}_1}) \Delta_{01}}^{n, \text{norm}} (\epsilon_1, \epsilon_2) (-1)^{\sum_{I=1}^N |V_{1I}|} \prod_{I=1}^N f_{012, I}^n \mathcal{S}_{(\mathbf{v}_1, \mathbf{c}_{\mathbf{v}_1}) (\mathbf{v}_2, \mathbf{c}_{\mathbf{v}_2}) \Delta_{12}}^{n, \text{norm}} (\epsilon_1, \epsilon_2) \cdots \\
&\cdots \mathcal{S}_{(\mathbf{v}_{m-1}, \mathbf{c}_{\mathbf{v}_{m-1}}) (\mathbf{v}_m, \mathbf{c}_{\mathbf{v}_m}) \Delta_{m-1, m}}^{n, \text{norm}} (\epsilon_1, \epsilon_2) (-1)^{\sum_{I=1}^N |V_{mI}|} \prod_{I=1}^N f_{m-1, m, 0, I}^n \\
&\mathcal{S}_{(\mathbf{v}_m, \mathbf{c}_{\mathbf{v}_m}) (\mathbf{v}_0, \mathbf{c}_{\mathbf{v}_0}) \Delta_{m0}}^{n, \text{norm}} (\epsilon_1, \epsilon_2) (-1)^{\sum_{I=1}^N |V_{0I}|} \prod_{I=1}^N f_{m01, I}^n
\end{aligned}$$

Observing that,

$$(8.10) \quad F(\mathbf{V}_i, \mathbf{c}_{\mathbf{V}_i} | \mathbf{V}_{i+1}, \mathbf{c}_{\mathbf{V}_{i+1}}) = \prod_{I=1}^N f_{i, i+1, I}^{n, \text{right}} f_{i, i+1, I}^{n, \text{left}},$$

the relation between $F(\mathbf{V}, \mathbf{c}_{\mathbf{V}} | \mathbf{W}, \mathbf{c}_{\mathbf{W}})$ and the framing factors $f_{i-1, i, I}^p$ for the linear conformal blocks is,

$$\begin{aligned}
(8.11) \quad & \left(\prod_{I=1}^N (-1)^{|V_{1I}|} f_{012, I}^n \right) \left(\prod_{I=1}^N (-1)^{|V_{2I}|} f_{123, I}^n \right) \cdots \\
& \left(\prod_{I=1}^N (-1)^{|V_{m-1, I}|} f_{m-2, m-1, m, I}^n \right) \left(\prod_{I=1}^N (-1)^{|V_{mI}|} f_{m-1, m, m+1, I}^n \right) \\
&= \prod_{I=1}^N (f_{01, I}^{p, \text{left}} f_{12, I}^{p, \text{right}} f_{12, I}^{p, \text{left}} f_{23, I}^{p, \text{right}} \cdots f_{m-2, m-1, I}^{p, \text{left}} f_{m-1, m, I}^{p, \text{right}} f_{m-1, m, I}^{p, \text{left}} f_{m, m+1, I}^{p, \text{right}}) \\
&= \prod_{I=1}^N (f_{01, I}^{n, \text{right}} f_{01, I}^{n, \text{left}} f_{12, I}^{n, \text{right}} f_{12, I}^{n, \text{left}} f_{23, I}^{n, \text{right}} \cdots f_{m-2, m-1, I}^{n, \text{left}} f_{m-1, m, I}^{n, \text{right}} f_{m-1, m, I}^{n, \text{left}} f_{m, m+1, I}^{n, \text{right}} f_{m, m+1, I}^{n, \text{left}}) \\
&= \prod_{i=0}^m F(\mathbf{V}_i, \mathbf{c}_{\mathbf{V}_i} | \mathbf{V}_{i+1}, \mathbf{c}_{\mathbf{V}_{i+1}})
\end{aligned}$$

Since $\mathbf{V}_0 = \mathbf{V}_{m+1} = \emptyset$, we have $f_{01, I}^{n, \text{right}} = f_{m, m+1, I}^{n, \text{left}} = 1$, and it is justified to multiply the right hand side in the second last equality by $f_{01, I}^{n, \text{right}} f_{m, m+1, I}^{n, \text{left}}$. For the cyclic conformal blocks, the relation is,

$$\begin{aligned}
(8.12) \quad & \left(\prod_{I=1}^N (-1)^{|V_{1I}|} f_{012,I}^n \right) \left(\prod_{I=1}^N (-1)^{|V_{1I}|} f_{123,I}^n \right) \cdots \\
& \left(\prod_{I=1}^N (-1)^{|V_{mI}|} f_{m-1,m,0,I}^n \right) \left(\prod_{I=1}^N (-1)^{|V_{0I}|} f_{m01,I}^n \right) \\
& = \prod_{I=1}^N \left(f_{01,I}^{n,left} f_{12,I}^{n,right} f_{12,I}^{n,left} f_{23,I}^{n,right} \cdots f_{m-2,m-1,I}^{n,left} f_{m-1,m,I}^{n,right} f_{m-1,m,I}^{n,left} f_{m,0,I}^{n,right} f_{m,0,I}^{n,left} f_{01,I}^{n,right} \right) \\
& = \prod_{i=0}^m F(\mathbf{V}_i, \mathbf{c}_{V_i} | \mathbf{V}_{i+1}, \mathbf{c}_{V_{i+1}})
\end{aligned}$$

and we can write the linear and cyclic conformal blocks in Equation 8.8 and Equation 8.9 as,

$$\begin{aligned}
(8.13) \quad & \mathcal{S}_{(\mathbf{V}_1, \mathbf{c}_{V_1}), (\mathbf{V}_2, \mathbf{c}_{V_2}), \dots, (\mathbf{V}_m, \mathbf{c}_{V_m})}^{n, linear\ block}(\epsilon_1, \epsilon_2) \\
& = F(\emptyset, \mathbf{c}_{\emptyset_0} | \mathbf{V}_1, \mathbf{c}_{V_1}) \mathcal{S}_{\emptyset \mathbf{V}_1 \Delta_{01}}^{n, norm}(\epsilon_1, \epsilon_2) F(\mathbf{V}_1, \mathbf{c}_{V_1} | \mathbf{V}_2, \mathbf{c}_{V_2}) \mathcal{S}_{(\mathbf{V}_1, \mathbf{c}_{V_1}) (\mathbf{V}_2, \mathbf{c}_{V_2}) \Delta_{12}}^{n, norm}(\epsilon_1, \epsilon_2) \cdots \\
& \cdots F(\mathbf{V}_{m-1}, \mathbf{c}_{V_{m-1}} | \mathbf{V}_m, \mathbf{c}_{V_m}) \mathcal{S}_{(\mathbf{V}_{m-1}, \mathbf{c}_{V_{m-1}}) (\mathbf{V}_m, \mathbf{c}_{V_m}) \Delta_{m-1,m}}^{n, norm}(\epsilon_1, \epsilon_2) F(\mathbf{V}_m, \mathbf{c}_{V_m} | \emptyset, \mathbf{c}_{\emptyset_{m+1}}) \\
& \mathcal{S}_{(\mathbf{V}_m, \mathbf{c}_{V_m}) (\emptyset, \mathbf{c}_{\emptyset_{m+1}}) \Delta_{m,m+1}}^{n, norm}(\epsilon_1, \epsilon_2)
\end{aligned}$$

$$\begin{aligned}
(8.14) \quad & \mathcal{S}_{(\mathbf{V}_0, \mathbf{c}_{V_0}), (\mathbf{V}_1, \mathbf{c}_{V_1}), (\mathbf{V}_2, \mathbf{c}_{V_2}), \dots, (\mathbf{V}_m, \mathbf{c}_{V_m})}^{n, cyclic\ block}(\epsilon_1, \epsilon_2) \\
& = F(\mathbf{V}_0, \mathbf{c}_{V_0} | \mathbf{V}_1, \mathbf{c}_{V_1}) \mathcal{S}_{(\mathbf{V}_0, \mathbf{c}_{V_0}) (\mathbf{V}_1, \mathbf{c}_{V_1}) \Delta_{01}}^{n, norm}(\epsilon_1, \epsilon_2) F(\mathbf{V}_1, \mathbf{c}_{V_1} | \mathbf{V}_2, \mathbf{c}_{V_2}) \mathcal{S}_{(\mathbf{V}_1, \mathbf{c}_{V_1}) (\mathbf{V}_2, \mathbf{c}_{V_2}) \Delta_{12}}^{n, norm}(\epsilon_1, \epsilon_2) \cdots \\
& \cdots F(\mathbf{V}_{m-1}, \mathbf{c}_{V_{m-1}} | \mathbf{V}_m, \mathbf{c}_{V_m}) \mathcal{S}_{(\mathbf{V}_{m-1}, \mathbf{c}_{V_{m-1}}) (\mathbf{V}_m, \mathbf{c}_{V_m}) \Delta_{m-1,m}}^{n, norm}(\epsilon_1, \epsilon_2) F(\mathbf{V}_m, \mathbf{c}_{V_m} | \mathbf{V}_0, \mathbf{c}_{V_0}) \\
& \mathcal{S}_{(\mathbf{V}_m, \mathbf{c}_{V_m}) (\mathbf{V}_0, \mathbf{c}_{V_0}) \Delta_{m0}}^{n, norm}(\epsilon_1, \epsilon_2)
\end{aligned}$$

8.1. $\mathcal{S}^{n, norm}$ and $\mathcal{Z}_N^{n, 4D}$ lead to the same 4D instanton partition functions. Let,

$$\begin{aligned}
(8.15) \quad \mathcal{F}(\mathbf{a}, \mathbf{V} | \mathbf{b}, \mathbf{W}) & = F(\mathbf{V}, \mathbf{c}_V | \mathbf{W}, \mathbf{c}_W) \frac{\mathcal{S}_{(\mathbf{V}, \mathbf{c}_V) (\mathbf{W}, \mathbf{c}_W) \Delta}^{n, norm}(\epsilon_1, \epsilon_2)}{\mathcal{Z}_N^{n, 4D}(\mathbf{a}, \mathbf{V}, \mathbf{c}_V | \mu | \mathbf{b}, \mathbf{W}, \mathbf{c}_W)} \\
& = \frac{\prod_{I=1}^N \prod_{J=1}^N (\mathcal{H}_{V_{IJ}}(\mathbf{a}, \mathbf{c}_V) \mathcal{H}_{W_{IJ}}(\mathbf{b}, \mathbf{c}_W))^{1/2}}{\prod_{I=1}^N \mathcal{A}_{V_{II}}(\mathbf{a}, \mathbf{c}_V) \mathcal{L}_{W_{II}}(\mathbf{b}, \mathbf{c}_W) \prod_{J=1}^N \prod_{I=1}^{J-1} \mathcal{H}_{V_{JI}}(\mathbf{a}, \mathbf{c}_V) \mathcal{H}_{W_{JI}}(\mathbf{b}, \mathbf{c}_W)} \\
& = \mathcal{F}_{left}(\mathbf{a}, \mathbf{V}) \mathcal{F}_{right}(\mathbf{b}, \mathbf{W})
\end{aligned}$$

where we have used Equations 6.15, 6.16 and 6.17 for the second equality. We also define,

$$(8.16) \quad \mathcal{F}_{left}(\mathbf{a}, \mathbf{V}) = \frac{\prod_{I=1}^N \prod_{J=1}^N \mathcal{H}_{V_{IJ}}(\mathbf{a}, \mathbf{c}_V)^{\frac{1}{2}}}{\prod_{I=1}^N \mathcal{A}_{V_{II}}(\mathbf{a}, \mathbf{c}_V) \prod_{J=1}^N \prod_{I=1}^{J-1} \mathcal{H}_{V_{JI}}(\mathbf{a}, \mathbf{c}_V)}$$

$$(8.17) \quad \mathcal{F}_{right}(\mathbf{b}, \mathbf{W}) = \frac{\prod_{I=1}^N \prod_{J=1}^N \mathcal{H}_{W_{IJ}}(\mathbf{b}, \mathbf{c}_W)^{\frac{1}{2}}}{\prod_{I=1}^N \mathcal{L}_{W_{II}}(\mathbf{b}, \mathbf{c}_W) \prod_{J=1}^N \prod_{I=1}^{J-1} \mathcal{H}_{W_{IJ}}(\mathbf{b}, \mathbf{c}_W)}$$

The linear and cyclic conformal blocks take the form,

$$(8.18) \quad \mathcal{Z}^{n, linear\ block} = \mathcal{Z}_N^{n, 4D}(\mathbf{a}_0, \emptyset, \mathbf{c}_\emptyset | \mu_{01} | \mathbf{a}_1, \mathbf{V}_1, \mathbf{c}_{V_1}) \mathcal{Z}_N^{n, 4D}(\mathbf{a}_1, \mathbf{V}_1, \mathbf{c}_{V_1} | \mu_{12} | \mathbf{a}_2, \mathbf{V}_2, \mathbf{c}_{V_2}) \cdots \\ \mathcal{Z}_N^{n, 4D}(\mathbf{a}_m, \mathbf{V}_m, \mathbf{c}_{V_m} | \mu_{m, m+1} | \mathbf{a}_{m+1}, \emptyset, \mathbf{c}_\emptyset)$$

$$(8.19) \quad \mathcal{Z}^{n, cyclic\ block} = \mathcal{Z}_N^{n, 4D}(\mathbf{a}_0, \mathbf{V}_0, \mathbf{c}_{V_0} | \mu_{01} | \mathbf{a}_1, \mathbf{V}_1, \mathbf{c}_{V_1}) \mathcal{Z}_N^{n, 4D}(\mathbf{a}_1, \mathbf{V}_1, \mathbf{c}_{V_1} | \mu_{12} | \mathbf{a}_2, \mathbf{V}_2, \mathbf{c}_{V_2}) \cdots \\ \mathcal{Z}_N^{n, 4D}(\mathbf{a}_m, \mathbf{V}_m, \mathbf{c}_{V_m} | \mu_{m0} | \mathbf{a}_0, \mathbf{V}_0, \mathbf{c}_{V_0})$$

We claim that

$$(8.20) \quad \boxed{\mathcal{Z}^{n, linear\ block} = \mathcal{S}^{n, linear\ block} \quad \text{and} \quad \mathcal{Z}^{n, cyclic\ block} = \mathcal{S}^{n, cyclic\ block}}$$

Comparing Equation 8.13 to 8.18 and 8.14 to 8.19, the claim is equivalent to,

$$(8.21) \quad \mathcal{F}_{left}(\mathbf{a}_0, \emptyset) \mathcal{F}_{right}(\mathbf{a}_1, \mathbf{V}_1) \cdots \mathcal{F}_{left}(\mathbf{a}_m, \mathbf{V}_m) \mathcal{F}_{right}(\mathbf{a}_{m+1}, \emptyset) = 1,$$

$$(8.22) \quad \mathcal{F}_{left}(\mathbf{a}_0, \mathbf{V}_0) \mathcal{F}_{right}(\mathbf{a}_1, \mathbf{V}_1) \cdots \mathcal{F}_{left}(\mathbf{a}_m, \mathbf{V}_m) \mathcal{F}_{right}(\mathbf{a}_0, \mathbf{V}_0) = 1$$

Since $\mathcal{F}(\mathbf{a}, \emptyset | \mathbf{b}, \emptyset) = 1$, it follows that $\mathcal{F}_{left}(\mathbf{a}, \emptyset) = \mathcal{F}_{right}(\mathbf{a}, \emptyset) = 1$,

$$(8.23) \quad \mathcal{F}_{left}(\mathbf{a}, \mathbf{V}) \mathcal{F}_{right}(\mathbf{a}, \mathbf{V}) = \\ \frac{\prod_{I=1}^N \prod_{J=1}^N \mathcal{H}_{V_{IJ}}(\mathbf{a}, \mathbf{c}_V)}{\prod_{I=1}^N (\mathcal{A}_{V_{II}}(\mathbf{a}, \mathbf{c}_V) \mathcal{L}_{V_{II}}(\mathbf{a}, \mathbf{c}_V)) \prod_{J=1}^N \prod_{I=1}^{J-1} \mathcal{H}_{V_{IJ}}(\mathbf{a}, \mathbf{c}_V) \prod_{I=1}^N \prod_{J=1}^{I-1} \mathcal{H}_{V_{IJ}}(\mathbf{a}, \mathbf{c}_V)} = \\ \frac{(-1)^{\sum_{I=1}^N |V_I|} \prod_{I=1}^N \prod_{J=1}^N \mathcal{H}_{V_{IJ}}(\mathbf{a}, \mathbf{c}_V)}{\prod_{I=1}^N \mathcal{H}_{V_{II}}(0) \prod_{I < J} \mathcal{H}_{V_{IJ}}(\mathbf{a}, \mathbf{c}_V) \prod_{I > J} \mathcal{H}_{V_{IJ}}(\mathbf{a}, \mathbf{c}_V)} = 1$$

proving the claim.

9. A 4-POINT CONFORMAL BLOCK

We recover the 4-point conformal block on $\mathbb{R}^4/\mathbb{Z}_n$ in Equation (2.10) of [4] by gluing two strip partition functions. To help with the comparison, in this section, we use the notation of [4].

9.1. Change of parameters and notation. In previous sections, the case of computing 4-point conformal blocks is the same as linear blocks with $\mathbf{V}_0 = \emptyset, \mathbf{V}_1 = \mathbf{Y}, \mathbf{V}_2 = \emptyset$. We used the Kähler parameters $\Delta_{01,K}, \dots$, the Coulomb parameters $\mathbf{a}_0, \mathbf{a}_1, \mathbf{a}_2$, the mass parameters μ_{01} and μ_{12} , the deformation parameters ϵ_1 and ϵ_2 , and c_I for the Young diagram charges.

In [4], Alfimov and Tarnopolsky use the Coulomb parameters $\mathbf{P}_i = (P_{i,1}, \dots, P_{i,N})$, $\mathbf{P} = (P_1, \dots, P_N)$, $i = 1, 2$, the mass parameters α_1, α_2 , the deformation parameters b^{-1}, b , and $\mathbf{q} = (q_1, \dots, q_N)$ for the Young diagram charges. These two sets of parameters are related as,

$$(9.1) \quad \mathbf{a}_0 = \mathbf{P}_1, \quad \mathbf{a}_1 = \mathbf{P}, \quad \mathbf{a}_2 = \mathbf{P}_2, \quad \mu_{01} = \alpha_1, \quad \mu_{12} = \alpha_2, \quad \epsilon_1 = b^{-1}, \quad \epsilon_2 = b, \quad c_{Y_I} = -q_I,$$

and the Kähler parameters $(\Delta_{01,K}, \dots)$, in terms of the parameters of [4] are,

$$(9.2) \quad \Delta_{01,K} = -P_{1,K} + P_K + \alpha_1 - b^{-1}, \quad \Delta_{01,M_K} = P_{1,K+1} - P_K + \alpha_1 - b^{-1}, \\ \Delta_{12,K} = -P_K + P_{2,K} + \alpha_2 - b^{-1}, \quad \Delta_{12,M_K} = P_{K+1} - P_{2,K} + \alpha_2 - b^{-1}$$

We will also use,

$$(9.3) \quad (\mathbf{Y}, \mathbf{c}_Y) = (\mathbf{Y}, -\mathbf{q})$$

9.2. The 4-point conformal block. In the notation of [4], introduced above, the 4-point n -coloured conformal block constructed from two n -coloured strip partition functions is,

$$(9.4) \quad \mathcal{S}^{n,4\text{-point}}(b) = \sum_{(\mathbf{Y}, -\mathbf{q})} \mathcal{S}_{(\mathbf{Y}, \mathbf{q})}^{n,block}(b) z^{|\mathbf{Y}|/n},$$

where z is an instanton expansion parameter (a position parameter in 2D conformal field theory). The summation is over each of the $(\mathbf{N}, \mathbf{u} = (0, 0, 0))$ -series in Equations 7.6–7.8. For example, if we choose Series 2 in Equation 7.7 then $\mathbf{N} = (0, 1, 0, 1)$ and $\mathbf{k}(r) = (r, r+1, r+1, r+1)$ and the summation is over all $(\mathbf{Y}, \mathbf{c}_Y) = (\mathbf{Y}, -\mathbf{q})$ of $(\mathbf{N}, \mathbf{k}(r))$ -type. We obtain the expression for the 4-point conformal block $\mathcal{S}_{(\mathbf{Y}, \mathbf{q})}^{n,block}(b)$ from the expression of linear conformal block in Equation 8.13 by substituting $\mathbf{V}_0 = \emptyset, \mathbf{V}_1 = \mathbf{Y}, \mathbf{V}_2 = \emptyset$. In the notation of [4],

$$(9.5) \quad \mathcal{S}_{(\mathbf{Y}, \mathbf{q})}^{n,block}(b) = F(\emptyset, \mathbf{0} | \mathbf{Y}, \mathbf{c}_Y) \mathcal{S}_{(\emptyset, \mathbf{0}) (\mathbf{Y}, \mathbf{c}_Y) \Delta_{01}}^{n,norm}(\epsilon_1, \epsilon_2) F(\mathbf{Y}, \mathbf{c}_Y | \emptyset, \mathbf{0}) \mathcal{S}_{(\mathbf{Y}, \mathbf{c}_Y) (\emptyset, \mathbf{0}) \Delta_{12}}^{n,norm}(\epsilon_1, \epsilon_2) \\ = F(\emptyset, \mathbf{0} | \mathbf{Y}, -\mathbf{q}) \mathcal{S}_{(\emptyset, \mathbf{0}) (\mathbf{Y}, -\mathbf{q}) \Delta_{01}}^{n,norm}(b^{-1}, b) F(\mathbf{Y}, -\mathbf{q} | \emptyset, \mathbf{0}) \mathcal{S}_{(\mathbf{Y}, -\mathbf{q}) (\emptyset, \mathbf{0}) \Delta_{12}}^{n,norm}(b^{-1}, b) \\ = \prod_{I=1}^N \prod_{J=1}^I \prod_{\substack{\square \in Y_I \\ A_{\square, Y_I} + L_{\square, \emptyset} + 1 + q_I = 0 \pmod n}} (P_{1,J} - P_I - \alpha_1 - A_{\square, Y_I} b + L_{\square, \emptyset}^{++} b^{-1}) \\ \prod_{I=1}^N \prod_{J=1}^{I-1} \prod_{\substack{\square \in Y_J \\ A_{\square, Y_J} + L_{\square, \emptyset} + 1 + q_J = 0 \pmod n}} (P_{1,I} - P_J - \alpha_1 - A_{\square, Y_J} b + L_{\square, \emptyset}^{++} b^{-1})$$

$$\begin{aligned}
& \prod_{I=1}^N \prod_{\substack{\square \in Y_I \\ A_{\square, Y_I} + L_{\square, Y_I} + 1 = 0 \pmod n}} \left(-A_{\square, Y_I} b + L_{\square, \emptyset}^{++} b^{-1} \right)^{-1} \\
& \prod_{I=1}^N \prod_{J=1}^{I-1} \prod_{\substack{\square \in Y_I \\ A_{\square, Y_I} + L_{\square, Y_J} + 1 + q_I - q_J = 0 \pmod n}} \left(P_J - P_I - A_{\square, Y_I} b + L_{\square, Y_J}^{++} b^{-1} \right)^{-1} \\
& \prod_{\substack{\square \in Y_J \\ A_{\square, Y_J} + L_{\square, Y_I} + 1 - q_I + q_J = 0 \pmod n}} \left(P_J - P_I + A_{\square, Y_J}^{++} b - L_{\square, Y_I} b^{-1} \right)^{-1} \\
& \prod_{I=1}^N \prod_{J=1}^I \prod_{\substack{\square \in Y_J \\ A_{\square, Y_J} + L_{\square, \emptyset} + 1 + q_J = 0 \pmod n}} \left(P_J - P_{2, I} - \alpha_2 + A_{\square, Y_J}^{++} b - L_{\square, \emptyset} b^{-1} \right) \\
& \prod_{I=1}^N \prod_{J=1}^{I-1} \prod_{\substack{\square \in Y_I \\ A_{\square, Y_I} + L_{\square, \emptyset} + 1 + q_I = 0 \pmod n}} \left(P_I - P_{2, J} - \alpha_2 + A_{\square, Y_I}^{++} b - L_{\square, \emptyset} b^{-1} \right) \\
& \prod_{I=1}^N \prod_{\substack{\square \in Y_I \\ A_{\square, Y_I} + L_{\square, Y_I} + 1 = 0 \pmod n}} \left(A_{\square, Y_I}^{++} b - L_{\square, Y_I} b^{-1} \right)^{-1} \\
& \prod_{I=1}^N \prod_{J=1}^{I-1} \prod_{\substack{\square \in Y_I \\ A_{\square, Y_I} + L_{\square, Y_J} + 1 + q_I - q_J = 0 \pmod n}} \left(P_I - P_J + A_{\square, Y_I}^{++} b - L_{\square, Y_J} b^{-1} \right)^{-1} \\
& \prod_{\substack{\square \in Y_J \\ A_{\square, Y_J} + L_{\square, Y_I} + 1 - q_I + q_J = 0 \pmod n}} \left(P_I - P_J - A_{\square, Y_J} b + L_{\square, Y_I}^{++} b^{-1} \right)^{-1} \\
& = \prod_{I, J=1}^N \prod_{\substack{\square \in Y_I \\ A_{\square, Y_I} + L_{\square, \emptyset} + 1 = -q_I \pmod n}} \left(P_{1, J} - P_I - \alpha_1 - A_{\square, Y_I} b + L_{\square, \emptyset}^{++} b^{-1} \right) \\
& \prod_{I, J=1}^N \prod_{\substack{\square \in Y_J \\ A_{\square, Y_J} + L_{\square, \emptyset} + 1 = -q_J \pmod n}} \left(P_J - P_{2, I} - \alpha_2 + A_{\square, Y_J}^{++} b - L_{\square, \emptyset} b^{-1} \right) \\
& \prod_{I, J}^N \prod_{\substack{\square \in Y_I \\ A_{\square, Y_I} + L_{\square, Y_J} + 1 = -q_I + q_J \pmod n}} \left(P_I - P_J + A_{\square, Y_I}^{++} b - L_{\square, Y_J} b^{-1} \right)^{-1} \\
& \prod_{\substack{\square \in Y_J \\ A_{\square, Y_J} + L_{\square, Y_I} + 1 = q_I - q_J \pmod n}} \left(P_I - P_J - A_{\square, Y_J} b + L_{\square, Y_I}^{++} b^{-1} \right)^{-1} \\
& = \frac{\mathcal{Z}^{num}(\mathbf{s}_1, \emptyset, \mathbf{0} | \alpha_1 | \mathbf{P}, \mathbf{Y}, -\mathbf{q}) \mathcal{Z}^{num}(\mathbf{P}, \mathbf{Y}, -\mathbf{q} | \alpha_2 | \mathbf{s}_2, \emptyset, \mathbf{0})}{\mathcal{Z}^{num}(\mathbf{P}, \mathbf{Y}, -\mathbf{q} | 0 | \mathbf{P}, \mathbf{Y}, -\mathbf{q})}
\end{aligned}$$

which is Equation (2.10) in [4], for $N = 2, n = 4$.

10. COMMENTS AND REMARKS

10.1. A formulation in terms of n -coloured Young diagrams. We have refrained from discussing the n -coloured vertex in terms of n -coloured checkerboard Young diagrams, and in particular, we did not consider working in terms of n -cores and n -quotients [34, 38, 44]. This is because, in this work, working in terms of n -cores and n -quotients was not needed and would have taken us far afield from our goal which is to reproduce the 2D parafermion matrix elements in [4].

10.2. The n -coloured vertex is not a product of n arbitrary refined topological vertices. The n -coloured vertex factorizes into a product of n refined vertices. However, it is not a product of n arbitrary refined topological vertices unless the Young diagrams that label the preferred legs of the component vertices mesh together to form the Young diagram that labels the preferred leg of the n -coloured vertex.

10.3. Counting parameters. While the 5D strip partition function has $(2N - 1)$ Kähler parameters, and the 4D instanton partition function also has $(2N - 1)$ parameters, there are N^2 relations among them which arise from the factors in $\mathcal{S}_{(\mathbf{v}, \mathbf{c}_V)}^{n, num}(\mathbf{w}, \mathbf{c}_W)_\Delta(\epsilon_1, \epsilon_2)$ (Equation 6.8) and $\mathcal{Z}^{n, num}(\mathbf{a}, \mathbf{V}, \mathbf{c}_V | \mu | \mathbf{b}, \mathbf{W}, \mathbf{c}_W)$ (Equation 6.5). The significance of the fact that $(2N - 1)$ parameters satisfy N^2 relations is not clear at this stage.

10.4. Rational models. In this work, we restricted our attention to generic, that is non-rational parameters and the corresponding conformal field theories. The relations between the parameters of the 5D strip partition function and the 2D matrix elements obtained in this work are expected to extend to the rational model, after **1.** re-writing all parameters in terms of the screening charges α_+ and α_- of the minimal 2D conformal field theory, and **2.** restricting the Young diagrams that label the preferred legs to those that satisfy Burge-type conditions (thereby eliminating the null states), as described in [5, 18, 14].

10.5. The orbifold vertex [22]. In [22], Bryan, Cadman and Young define Donaldson-Thomas invariants of Calabi-Yau orbifolds and introduce *an orbifold topological vertex* to compute them. The orbifold vertex is n -coloured in the sense that it is the generating function of plane partitions that are made of interlacing checkerboard n -coloured Young diagrams. However, the orbifold vertex differs (at least on a superficial level) from the n -coloured vertex introduced in this work in several technical respects. **1.** The orbifold vertex is constructed in terms of one type of Γ_\pm -operators, which is equivalent to using one Heisenberg algebra, rather than n Heisenberg algebras as in the n -coloured vertex, and consequently, the orbifold vertex is in the form of a single sum of a bilinear of Schur functions (as in the refined topological vertex), while the n -coloured vertex is in the form of a product of n sums of bilinears of Schur functions, and **2.** the cells of the plane partitions generated by the orbifold vertex are assigned n colours, and cells of different colours are assigned different weights, while in the case of the n -coloured vertex, all cells are assigned the same (trivial) weight¹⁷, **3.** the orbifold vertex is not refined, while the n -coloured vertex is¹⁸. More generally, **4.** The orbifold vertex computes topological string partition functions on orbifold Calabi-Yau (internal) spaces such as $\mathbb{C}^3/\mathbb{Z}_n$, while the n -coloured vertex computes topological string partition functions on the (Euclidean version of space-time) orbifolds $\mathbb{C}^2/\mathbb{Z}_n$. It is possible that there is a more general operator formalism that produces a more general vertex such

¹⁷ There can be an orbifold vertex that is formulated in terms of n free bosons that assign different colours to different cells, but this is not clear at this stage.

¹⁸ Because of **1** and **2**, the orbifold vertex is parameterized in terms of n parameters $(q_0, q_1, \dots, q_{n-1})$, while the n -coloured vertex is parameterized in terms of the equivariant deformation parameters (ϵ_2, ϵ_1) , and the radius R . However, this is probably not a deep difference, and it is entirely possible that there is a refined version of the orbifold vertex.

that the orbifold vertex and the n -coloured vertex are special cases of the same object, but this is not clear at this stage, and is unlikely given that these two vertices compute different objects.

10.6. The intertwining operator of the Fock representations of the quantum toroidal algebras of type A_n [9]. Following the completion of this work, we learned that in [9], Awata, Kanno, Mironov, Morozov, Suetake and Zenkevich introduced an intertwining operator of the Fock representations of the quantum toroidal algebras of type A_n , and used these to obtain the instanton partition functions on $\mathbb{C}^2/\mathbb{Z}_n$ ¹⁹. Using AGT, these instanton partition functions are identified with the matrix elements discussed in this work, and as such, the intertwiner of [9] is identified with the n -coloured vertex introduced in this work. The differences between the two works are that **1.** The intertwiner of [9] is in Awata-Feigin-Shiraishi operator form [6], which bypasses working in terms of symmetric functions, while the n -coloured vertex in this work is in the (more conventional) Iqbal-Kozcaz-Vafa symmetric-function form [31], **2.** The focus of [9] is on the representation theory of quantum toroidal algebras, while that of the present work is on making contact with the 2D matrix elements that the $\mathbb{C}^2/\mathbb{Z}_n$ topological vertex formalism computes, with emphasis on the details, including the framing factors, the matching of the various normalizations, *etc.*

10.7. More general orbifolds. Following the completion of this work, Bourgine and Jeong [21] introduced an n -coloured topological vertex of the Awata-Feigin-Shiraishi type [6], that allowed them to discuss new quantum toroidal algebras that are related to 5D supersymmetric gauge theories on $(\mathbb{C}^2/\mathbb{Z}_n) \times S^1$ orbifolds, which were first discussed in [19, 20]. These orbifolds are more general than those discussed in this work, and so far the corresponding 2D conformal field theories are not known.

10.8. Extracting the affine A_n , integral level- N , WZW model algebra. In [25], Macleod and the second author show that there is a choice of the Nekrasov deformation parameters such that the coset component in the full $\mathcal{A}(N, n)$ algebra trivializes and one obtains a formalism that involves only the affine A_n WZW models, at integral level N , times a Heisenberg factor.

ACKNOWLEDGEMENTS

We wish to thank V Belavin, M Bershtein, J-E Bourgine, J Bryan, H Kanno, N Macleod, M Manabe, A Morozov, R Santachiara, F Yagi and R-D Zhu for discussions on the subject of this work and related topics, and Trevor Welsh for a careful reading of the manuscript. WC is supported by an Australian Postgraduate Fellowship, and OF is supported by the Australian Research Council.

APPENDIX A. A PROOF OF THE n -COLOURED NORMALIZED PRODUCT IDENTITY

We prove the identity used to go from Equation 5.7 to Equation 5.8

In the following, c stands for $c_V - c_W$, the difference of the charges of the Young diagrams V and W .

¹⁹ We thank M Bershtein and J-E Bourgine for bringing [9] to our attention.

→ j

	(1,1)	(2,1)	(3,1)	(4,1)	(5,1)	(6,1)	(7,1)	(8,1)
	(1,2)	(2,2)	(3,2)	(4,2)	(5,2)	(6,2)	(7,2)	(8,2)
	(1,3)	(2,3)	(3,3)	(4,3)	(5,3)	(6,3)	(7,3)	(8,3)
	(1,4)	(2,4)	(3,4)	(4,4)	(5,4)	(6,4)	(7,4)	(8,4)
	(1,5)	(2,5)	(3,5)	(4,5)	(5,5)	(6,5)	(7,5)	(8,5)
	(1,6)	(2,6)	(3,6)	(4,6)	(5,6)	(6,6)	(7,6)	(8,6)
	(1,7)	(2,7)	(3,7)	(4,7)	(5,7)	(6,7)	(7,7)	(8,7)
	(1,8)	(2,8)	(3,8)	(4,8)	(5,8)	(6,8)	(7,8)	(8,8)
	(1,9)	(2,9)	(3,9)	(4,9)	(5,9)	(6,9)	(7,9)	(8,9)
	(1,10)	(2,10)	(3,10)	(4,10)	(5,10)	(6,10)	(7,10)	(8,10)

↓ i

FIGURE A.1. $\psi_{\emptyset\emptyset}$

A.0.1. *An identity.* For $c \in (0, 1, \dots, n-1)$, we have the following identity:

$$\begin{aligned}
 \text{(A.1)} \quad & \frac{\prod_{i,j=1}^{\infty} (1 - Q x^{-V_i+j} y^{-W_j^\top+i-1})}{\prod_{i+j-1=c \bmod n} (1 - Q x^j y^{i-1})} \\
 &= \prod_{\substack{\blacksquare \in V \\ A_{\blacksquare,V} + L_{\blacksquare,W} + 1 = -c \bmod n}} (1 - Q x^{-A_{\blacksquare,V}} y^{-L_{\blacksquare,W}^{++}}) \prod_{\substack{\square \in W \\ A_{\square,W} + L_{\square,V} + 1 = c \bmod n}} (1 - Q x^{A_{\square,W}^{++}} y^{L_{\square,V}}) \\
 &= \prod_{\substack{\square \in W \\ A_{\square,V} + L_{\square,W} + 1 = -c \bmod n}} (1 - Q x^{-A_{\square,V}} y^{-L_{\square,W}^{++}}) \prod_{\substack{\blacksquare \in V \\ A_{\blacksquare,W} + L_{\blacksquare,V} + 1 = c \bmod n}} (1 - Q x^{A_{\blacksquare,W}^{++}} y^{L_{\blacksquare,V}})
 \end{aligned}$$

A.1. **A more general identity.** Here we prove an identity more general than Equation A.1, and from which the latter follows.

A.1.1. *Proposition.* Let $F : \mathbb{Z} \times \mathbb{Z} \rightarrow \mathbb{R}$ be a function such that $\prod_{i,j=1}^{\infty} (1 + F(j, i))$ converges absolutely. Then, for any pair of Young diagrams V and W ,

$$\begin{aligned}
 \text{(A.2)} \quad & \frac{\prod_{i,j=1}^{\infty} (1 + F(-V_i + j, -W_j^\top + i))}{\prod_{i,j=1}^{\infty} (1 + F(j, i))} = \prod_{\blacksquare \in V} (1 + F(-A_{\blacksquare,V}, -L_{\blacksquare,W})) \prod_{\square \in W} (1 + F(A_{\square,W}^{++}, L_{\square,V}^{++})) \\
 &= \prod_{\square \in W} (1 + F(-A_{\square,V}, -L_{\square,W})) \prod_{\blacksquare \in V} (1 + F(A_{\blacksquare,W}^{++}, L_{\blacksquare,V}^{++}))
 \end{aligned}$$

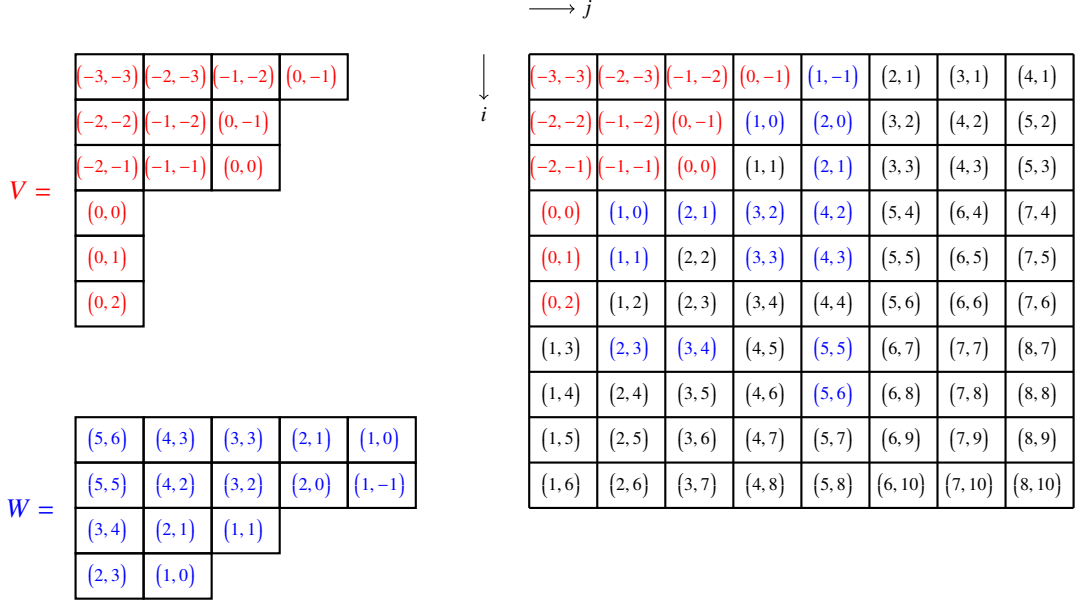

FIGURE A.2. The Young diagram pair W, V and their embedding into ψ_{WV} . The rest of ψ_{WV} (colored black) exactly coincide with $\psi_{\emptyset\emptyset}$.

A.1.2. *Example.* Figure A.1 and Figure A.2 illustrate the idea of the proof of this proposition for the case where $V = (4, 3, 3, 1, 1, 1)$ and $W = (5, 5, 3, 2)$.

A.1.3. *Proof of the first equality in Equation A.2.* To simplify the notation, we write the $(1 + F(m, n))$, $m, n \in \mathbb{Z}$ as (m, n) . Consider the positive quadrant of the integer lattice $\mathbb{Z}_+^2 = \mathbb{Z}_{\geq 1} \times \mathbb{Z}_{\geq 1}$. We associate to each point $(j, i) \in \mathbb{Z}_+^2$, the symbol $(-V_i + j, -W_j^\top + i)$. In the other words, we consider the map $\psi_{WV} : \mathbb{Z}_+^2 \rightarrow \mathbb{Z}^2$, and identify \mathbb{Z}_+^2 with the associated symbols and the map ψ_{WV} . By multiplying all factors that correspond to all symbols in \mathbb{Z}_+^2 , we obtain the product $\prod_{i,j=1}^{\infty} (1 + F(-V_i + j, -W_j^\top + i))$.

For $V = W = \emptyset$, Equation A.2 is trivially true, and \mathbb{Z}_+^2 is populated by symbols (j, i) at each point $(j, i) \in \mathbb{Z}_+^2$. We extend this to \mathbb{Z}^2 by associating (j, i) at all points $(j, i) \in \mathbb{Z}^2$, and take $\psi_{\emptyset\emptyset}$ to be the restriction of the identity map to the sub-lattice \mathbb{Z}_+^2 .

For arbitrary Young diagrams (W, V) , we construct ψ_{WV} from $\psi_{\emptyset\emptyset}$ as follows. **1.** Shift the first coordinate of each symbol (m, n) in the i -th row of \mathbb{Z}^2 in the positive j -direction by V_i . For example (m, n) becomes $(m + V_i, n)$ after the shift, **2.** Shift the second coordinate of each symbol (m, n) in the j -th column of \mathbb{Z}^2 in the positive i -direction by W_j^\top . For example (m, n) becomes $(m, n + W_j^\top)$ after the shift, and **3.** Restrict to the sub-lattice $\mathbb{Z}_+^2 \subset \mathbb{Z}^2$.

Consider V to be arbitrary, and $W = \emptyset$. From the construction of $\psi_{\emptyset V}$, all symbols in $\psi_{\emptyset\emptyset}$ are preserved, but get pushed to the right to make room for the embedding of $V \subset \mathbb{Z}_+^2$. All the factors corresponding to symbols in $\psi_{\emptyset\emptyset}$ are eliminated when dividing by $\prod_{i,j=1}^{\infty} (1 + F(j, i))$, and we are left with the product $\prod_{(j,i) \in V} (1 + F(-V_i + j, i))$, so the identity is proven in this case.

Next, consider the general case where both V and W are arbitrary. From the above construction, the symbols in $V \subset \mathbb{Z}_+^2$ give the product,

$$\prod_{(j,i) \in V} (1 + F(-V_i + j, -W_j^\top + i)) = \prod_{\blacksquare \in V} (1 + F(-A_{\blacksquare, V}, -L_{\blacksquare, W}))$$

It only remains to show that W along with $\psi_{\emptyset\emptyset}$ can be embedded in the $\mathbb{Z}_+^2 \setminus V$ part of ψ_{WV} . That is, the embedding of W must include the symbols that represent the factors in the product,

$$\prod_{\square \in W} \left(1 + F\left(A_{\square, W}^{++}, L_{\square, V}^{++}\right)\right)$$

The contributions from $\psi_{\emptyset\emptyset}$ are eliminated when dividing

$$\prod_{i, j=1}^{\infty} \left(1 + F\left(-V_i + j, -W_j^\top + i\right)\right)$$

by $\prod_{i, j}^{\infty} \left(1 + F\left(j, i\right)\right)$, giving Equation A.2.

Now, keep V fixed, and add boxes to W , completing a row then moving to the next. The first box added to W shifts the second coordinates of the symbols on the first column of \mathbb{Z}^2 down by 1. This is equivalent to pushing all symbols above the V_1^\top -row in the first column up by 1, and refilling the empty spot at $(1, V_1^\top + 1)$ by a new symbol $(1, V_1^\top)$. Therefore, all original symbols from $\psi_{\emptyset\emptyset}$ are preserved.

The new symbol $(1, V_1^\top)$ cannot be part of $\psi_{\emptyset\emptyset}$ because we have just concluded that $\psi_{\emptyset\emptyset}$ gets pushed away with all its symbols preserved. This gives an embedding of W into ψ_{WV} as the new symbol $(1, V_1^\top)$, and $\psi_{\emptyset\emptyset}$ into ψ_{WV} as $\mathbb{Z}_+^2 \setminus (V \cup \{(1, V_1^\top + 1)\})$.

Consider that W consists of a single row of length $(n - 1)$ and can be embedded in ψ_{WV} . Adding a box into the row of W , so that W is single row of length n , amounts to shifting the second coordinates of the symbols in the n -th column of \mathbb{Z}^2 down by 1. Take $V_0^\top = \infty$, and let,

$$(A.3) \quad \mathcal{N}_n = \left(j \in (1, \dots, n) \mid V_{j-1}^\top - V_j^\top > 0\right)$$

For each $j \in \mathcal{N}_n$, all symbols above the V_j^\top -th row but below the V_{j-1}^\top -th row are shifted up by 1 and for each $j \in \mathcal{N}_n \setminus \{1\}$, the symbol $(n - j + 1, V_{j-1}^\top)$ on the V_{j-1}^\top -th row and n -th column is pushed to replace $(n - j + 1, V_{j-1}^\top)$ at $(n - (j - V_{j-1}^\top + 1), V_{j-1}^\top + 1)$. The symbol being replaced was a new symbol created when we added a $(n - (j - V_{j-1}^\top + 1))$ -th box to the row of W . The new symbols introduced are $(n - j + 1, V_j^\top)$ for all $j \in \mathcal{N}_n$. The remaining symbols needed for the embedding of W are $(n - j + 1, V_j^\top)$ for $j \notin \mathcal{N}_n$ or $V_{j-1}^\top = V_j^\top$. These symbols are in ψ_{WV} before we added our last box and it cannot get replaced because, as noted above, only $(n - j + 1, V_{j-1}^\top)$ for $j \in \mathcal{N}_n \setminus \{1\}$ are replaced.

The number of symbols introduced is equal to $|\mathcal{N}_n|$, which is always one more than the number of symbols replaced. Therefore, all symbols that belong to W before we added the box but not after, must be replaced. Since all the original symbols from $\psi_{\emptyset\emptyset}$ are preserved, we have an embedding of a single row of any size W and $\psi_{\emptyset\emptyset}$ into ψ_{WV} as required.

Since we work with Young diagrams, shifting the second coordinates of symbols in the n -th column of \mathbb{Z}^2 down by 1 can only be done if we have done it for columns $1, \dots, n - 1$. Moreover, the operation preserves all but those symbols it created itself in columns $1, \dots, n - 1$. When we add boxes to the next rows of W , the embeddings of all previous rows of W along with $\psi_{\emptyset\emptyset}$ are preserved. Adding the i -th row of W is exactly the same as adding the first row, except that all the second coordinates of symbols in every columns that concern us have already been shifted down $(i - 1)$ -times. So, wherever we introduce a new symbol $(W_1 - j + 1, V_j^\top)$, we introduce instead $(W_i - j + 1, V_j^\top - i + 1)$. We have

an embedding of $\psi_{\emptyset\emptyset}$ and an arbitrary W into ψ_{WV} , which concludes the proof of the first equality in Equation A.2.

A.1.4. *Proof of the second equality of Equation A.2.* Applying the first equality with $\tilde{F}(m, n) = F(n, m)$ and diagrams $\tilde{V} = W^\tau, \tilde{W} = V^\tau$,

$$(A.4) \quad \frac{\prod_{i,j=1}^{\infty} (1 + \tilde{F}(-\tilde{V}_i + j, -\tilde{W}_j^\tau + i))}{\prod_{i,j=1}^{\infty} (1 + \tilde{F}(j, i))} = \prod_{(j,i) \in \tilde{V}} (1 + \tilde{F}(-\tilde{V}_i + j, -\tilde{W}_j^\tau + i)) \prod_{(j,i) \in \tilde{W}} (1 + \tilde{F}(\tilde{W}_i - j + 1, \tilde{V}_j^\tau - i + 1))$$

where, for clarity, the right hand side is given in detail. Re-writing this in terms of $F(m, n)$ and the Young diagrams V and W gives

$$(A.5) \quad \frac{\prod_{i,j=1}^{\infty} (1 + F(-V_i + j, -W_j^\tau + i))}{\prod_{i,j=1}^{\infty} (1 + F(j, i))} = \prod_{(j,i) \in W^\tau} (1 + F(-V_i + j, -W_j^\tau + i)) \prod_{(j,i) \in V^\tau} (1 + F(W_i - j + 1, V_j^\tau - i + 1)) \\ = \prod_{(i,j) \in W} (1 + F(-V_i + j, -W_j^\tau + i)) \prod_{(i,j) \in V} (1 + F(W_i - j + 1, V_j^\tau - i + 1))$$

This is the second equality in Equation A.2 and the Proposition is proven.

A.1.5. *Proof of identity A.1.* Let

$$(A.6) \quad F(j, i) = \begin{cases} -Q x^j y^{i-1}, & i + j - 1 = c \pmod n \\ 0, & i + j - 1 \neq c \pmod n \end{cases}$$

Then Equation A.2 gives Equation A.1.

APPENDIX B. THE N -STRIP PARTITION FUNCTION. A PROOF BY INDUCTION

We present a proof by induction of Equation 5.6 for the n -coloured 5D strip partition function.

B.0.1. *The unevaluated strip partition function.* Our goal is to obtain Equation 5.6 from Equation 5.5. However, it is hard to perform a proof by induction directly on $\mathcal{S}_{\mathbf{V}\mathbf{W}\Delta}^{5D}(x, y, R)$, and we find that we need to consider a more general function $\tilde{\mathcal{S}}^{(N)}$.

Let $A^I = (A_1^I, A_2^I, A_3^I, \dots)$ be a set of variables indexed by I and $\mathbf{A} = (A^1, \dots, A^N)$, and similarly for $\mathbf{B}, \mathbf{C}, \mathbf{D}$. Let $\mathbf{Q}' = (Q'_1, \dots, Q'_N)$ and $\mathbf{Q}'' = (Q''_1, \dots, Q''_{N-1})$. We define,

$$(B.1) \quad \tilde{\mathcal{S}}^{(N)}(\mathbf{A}, \mathbf{B}, \mathbf{C}, \mathbf{D} | \mathbf{Q}', \mathbf{Q}'') = \sum_{\xi'_1, \dots, \xi'_N, \xi''_1, \dots, \xi''_{N-1}} \prod_{I=1}^N ((-Q'_I)^{|\xi'_I|} (-Q''_I)^{|\xi''_I|}) \prod_{I=1}^N \left(\sum_{\eta'_I} s_{\xi''_{I-1}/\eta'_I}(A^I) s_{\xi'_I/\eta'_I}(B^I) \sum_{\eta''_I} s_{\xi''_{I+1}/\eta''_I}(C^I) s_{\xi'_I/\eta''_I}(D^I) \right)$$

where $\xi''_0 = \xi''_N = \emptyset$. In the rest of the proof, any Young diagram ξ that appears in the product but not being summed over is assumed to be null $\xi = \emptyset$. $\mathcal{S}_{\mathbf{V}\mathbf{W}\Delta}^{5D}(x, y, R)$ in Equation 5.5 is expressed in terms of $\tilde{\mathcal{S}}^{(N)}$ as,

$$(B.2) \quad \mathcal{S}_{\mathbf{V}\mathbf{W}\Delta}^n(x, y, R) = \prod_{I=1}^N \left(Z_{V_I}^n(x, y) Z_{W_I^\top}^n(y, x) \right) \prod_{c_H=0}^{p-1} \tilde{\mathcal{S}}^{(N)}([x^{-\mathbf{V}} y^{J-1}]_{c_H-c_V}, [x^t y^{-\mathbf{V}^\top}]_{-c_H+c_V}, [y^{-\mathbf{W}^\top} x^{t-1}]_{-c_H+c_{\mathbf{W}}-1}, [y^J x^{-\mathbf{W}}]_{c_H-c_{\mathbf{W}}+1} | \mathbf{Q}, \mathbf{Q}_M)$$

where

$$(B.3) \quad [q^{-\mathbf{V}} t^{J-1}]_{c_H-c_V} = ([q^{-V_1} t^{J-1}]_{c_H-c_{V_1}}, \dots, [q^{-V_N} t^{J-1}]_{c_H-c_{V_N}}), \\ [q^t t^{-\mathbf{V}^\top}]_{-c_H+c_V} = ([q^t t^{-V_1^\top}]_{-c_H+c_{V_1}}, \dots, [q^t t^{-V_N^\top}]_{-c_H+c_{V_N}}), \\ [t^{-\mathbf{W}^\top} q^{t-1}]_{-c_H+c_{\mathbf{W}}-1} = ([t^{-W_1^\top} q^{t-1}]_{-c_H+c_{W_1}-1}, \dots, [t^{-W_N^\top} q^{t-1}]_{-c_H+c_{W_N}-1}), \\ [t^J q^{-\mathbf{W}}]_{c_H-c_{\mathbf{W}}+1} = ([t^J q^{-W_1}]_{c_H-c_{W_1}+1}, \dots, [t^J q^{-W_N}]_{c_H-c_{W_N}+1}), \\ \mathbf{Q} = (Q_1, \dots, Q_N), \mathbf{Q}_M = (Q_{M_1}, \dots, Q_{M_N}).$$

Therefore, once we prove the following general result,

$$(B.4) \quad \tilde{\mathcal{S}}^{(N)}(\mathbf{A}, \mathbf{B}, \mathbf{C}, \mathbf{D} | \mathbf{Q}', \mathbf{Q}'') = \prod_{J=1}^N \prod_{I=1}^J \prod_{i,j} \left(1 - \prod_{K=I}^{J-1} Q''_K \prod_{K=I}^J Q'_K D_j^J B_i^I \right) \prod_{J=1}^N \prod_{I=1}^{J-1} \prod_{i,j} \left(1 - \prod_{K=I}^{J-1} Q''_K \prod_{K=I+1}^{J-1} Q'_K A_j^J C_i^I \right) \\ \prod_{J=1}^N \prod_{I=1}^{J-1} \prod_{i,j} \left(1 - \prod_{K=I}^{J-1} Q''_K \prod_{K=I}^{J-1} Q'_K A_j^J B_i^I \right)^{-1} \prod_{J=1}^N \prod_{I=1}^{J-1} \prod_{i,j} \left(1 - \prod_{K=I}^{J-1} Q''_K \prod_{K=I+1}^J Q'_K D_j^J C_i^I \right)^{-1},$$

for any $\mathbf{A}, \mathbf{B}, \mathbf{C}, \mathbf{D}, \mathbf{Q}', \mathbf{Q}''$, for $N \geq 1$, Equation 5.6 follows from Equation B.2 and our proof is complete. We prove Equation B.4 by induction.

B.0.2. *Step 1. The base case.* From Equation B.1, the $N = 1$ base case is,

$$(B.5) \quad \tilde{S}^{(1)}(\mathbf{A}, \mathbf{B}, \mathbf{C}, \mathbf{D} | \mathbf{Q}', \mathbf{Q}'') = \\ \sum_{\xi'_1} \left((-Q'_1)^{|\xi'_1|} \sum_{\eta'_1} s_{\emptyset/\eta'_1}(A^1) s_{\xi'_1/\eta'_1}(B^1) \sum_{\eta''_1} s_{\emptyset/\eta''_1}(C^1) s_{\xi'_1/\eta''_1}(D^1) \right) \\ = \sum_{\xi'_1} (-Q'_1)^{|\xi'_1|} s_{\xi'_1}(B^1) s_{\xi'_1}(D^1) = \sum_{\xi'_1} s_{\xi'_1}(-Q'_1 B^1) s_{\xi'_1}(D^1) = \prod_{i,j} (1 - Q'_1 D_j^1 B_i^1)$$

which agrees with Equation B.4.

B.0.3. *Step 2. The $(N - 1)$ case.* We assume that Equation B.1 holds for $(N - 1)$. From Equation B.1, by switching the summation for $\{\xi'_I, \xi''_I\}$ and $\{\eta'_I, \eta''_I\}$ and defining $\eta'_1 = \eta''_N = \emptyset$, we obtain

$$(B.6) \quad \tilde{S}^{(N)}(\mathbf{A}, \mathbf{B}, \mathbf{C}, \mathbf{D} | \mathbf{Q}', \mathbf{Q}'') = \sum_{\eta'_2, \dots, \eta'_N} \sum_{\eta''_1, \dots, \eta''_{N-1}} \prod_{I=1}^N \left(\sum_{\xi'_I} (-Q'_I)^{|\xi'_I|} s_{\xi'_I/\eta'_I}(B^I) s_{\xi'_I/\eta''_I}(D^I) \right) \\ \prod_{I=1}^{N-1} \left(\sum_{\xi''_I} (-Q''_I)^{|\xi''_I|} s_{\xi''_I/\eta''_{I+1}}(A^{I+1}) s_{\xi''_I/\eta''_I}(C^I) \right)$$

Then, using Equation 3.10,

$$(B.7) \quad \tilde{S}^{(N)}(\mathbf{A}, \mathbf{B}, \mathbf{C}, \mathbf{D} | \mathbf{Q}', \mathbf{Q}'') = \sum_{\eta'_2, \dots, \eta'_N} \sum_{\eta''_1, \dots, \eta''_{N-1}} \prod_{I=1}^N \left((-Q'_I)^{|\eta'_I|} (-Q''_I)^{|\eta''_I|} \right) \\ \prod_{I=1}^N \left(\sum_{\xi'_I} s_{\xi'_I/\eta'_I}(-Q'_I B^I) s_{\xi'_I/\eta''_I}(D^I) \right) \prod_{I=1}^{N-1} \left(\sum_{\xi''_I} s_{\xi''_I/\eta''_{I+1}}(A^{I+1}) s_{\xi''_I/\eta''_I}(-Q''_I C^I) \right)$$

Then, using Equation 3.12,

$$(B.8) \quad \tilde{S}^{(N)}(\mathbf{A}, \mathbf{B}, \mathbf{C}, \mathbf{D} | \mathbf{Q}', \mathbf{Q}'') = \\ \prod_{I=1}^N \prod_{i,j} (1 - Q'_I B_i^I D_j^I) \prod_{I=1}^{N-1} \prod_{i,j} (1 - Q''_I A_i^{I+1} C_j^I) \sum_{\eta'_2, \dots, \eta'_N} \sum_{\eta''_1, \dots, \eta''_{N-1}} \prod_{I=1}^N \left((-Q'_I)^{|\eta'_I|} (-Q''_I)^{|\eta''_I|} \right) \\ \prod_{I=1}^N \left(\sum_{\tau'_I} s_{\eta'_I/\tau'_I}(D^I) s_{\eta''_I/\tau'_I}(-Q'_I B^I) \right) \prod_{I=1}^{N-1} \left(\sum_{\tau''_I} s_{\eta''_{I+1}/\tau''_I}(-s''_I C^I) s_{\eta''_I/\tau''_I}(A^{I+1}) \right)$$

Changing the summation for $\{\eta'_I, \eta''_I\}$ and $\{\tau'_I, \tau''_I\}$ and defining $\tau'_1 = \tau''_N = \emptyset$,

$$(B.9) \quad \tilde{S}^{(N)}(\mathbf{A}, \mathbf{B}, \mathbf{C}, \mathbf{D} | \mathbf{Q}', \mathbf{Q}'') =$$

$$\prod_{I=1}^N \prod_{i,j} (1 - \mathcal{Q}'_I B_i^I D_j^I) \prod_{I=1}^{N-1} \prod_{i,j} (1 - \mathcal{Q}''_I A_i^{I+1} C_j^I)$$

$$\sum_{\tau'_2, \dots, \tau'_{N-1}} \sum_{\tau''_1, \dots, \tau''_{N-1}} \prod_{I=2}^N \left(\sum_{\eta'_I} (-\mathcal{Q}'_I)^{|\eta'_I|} s_{\eta'_I / \tau'_{I-1}} (D^I) s_{\eta'_I / \tau''_{I-1}} (-\mathcal{Q}''_{I-1} C^{I-1}) \right)$$

$$\prod_{I=1}^{N-1} \left(\sum_{\eta''_I} (-\mathcal{Q}''_I)^{|\eta''_I|} s_{\eta''_I / \tau'_I} (-\mathcal{Q}'_I B^I) s_{\eta''_I / \tau''_I} (A^{I+1}) \right)$$

Applying Equation 3.11 then gives

$$(B.10) \quad \tilde{\mathcal{S}}^{(N)}(\mathbf{A}, \mathbf{B}, \mathbf{C}, \mathbf{D} | \mathbf{Q}', \mathbf{Q}'') =$$

$$\prod_{I=1}^N \prod_{i,j} (1 - \mathcal{Q}'_I B_i^I D_j^I) \prod_{I=1}^{N-1} \prod_{i,j} (1 - \mathcal{Q}''_I A_i^{I+1} C_j^I)$$

$$\prod_{I=2}^N \prod_{i,j} (1 - \mathcal{Q}'_I \mathcal{Q}''_{I-1} D^I C^{I-1})^{-1} \prod_{I=1}^{N-1} \prod_{i,j} (1 - \mathcal{Q}'_I \mathcal{Q}''_I B^I A^{I+1})^{-1}$$

$$\sum_{\tau'_2, \dots, \tau'_{N-1}} \sum_{\tau''_1, \dots, \tau''_{N-1}} \prod_{I=1}^N \left((-\mathcal{Q}'_I)^{|\tau'_I|} (-\mathcal{Q}''_I)^{|\tau''_I|} \right)$$

$$\prod_{I=2}^N \left(\sum_{\alpha'_I} s_{\tau'_I / \alpha'_I} (-\mathcal{Q}''_{I-1} C^{I-1}) s_{\tau''_{I-1} / \alpha'_I} (-\mathcal{Q}'_I D^I) \right) \prod_{I=1}^{N-1} \left(\sum_{\alpha''_I} s_{\tau'_I / \alpha''_I} (-\mathcal{Q}''_I A^{I+1}) s_{\tau''_I / \alpha''_I} (-\mathcal{Q}'_I B^I) \right)$$

On changing the summation indices to $\xi'_1 = \tau''_1, \dots, \xi'_{N-1} = \tau''_{N-1}, \xi''_1 = \tau'_2, \dots, \xi''_{N-2} = \tau'_{N-1}$ and $\eta'_2 = \alpha''_2, \dots, \eta'_{N-1} = \alpha''_{N-1}, \eta''_1 = \alpha'_2, \dots, \eta''_{N-2} = \alpha'_{N-1}$ and $\xi''_0 = \xi'_{N-1} = \emptyset$, this becomes,

$$(B.11) \quad \tilde{\mathcal{S}}^{(N)}(\mathbf{A}, \mathbf{B}, \mathbf{C}, \mathbf{D} | \mathbf{Q}', \mathbf{Q}'') =$$

$$\prod_{I=1}^N \prod_{i,j} (1 - \mathcal{Q}'_I B_i^I D_j^I) \prod_{I=1}^{N-1} \prod_{i,j} (1 - \mathcal{Q}''_I A_i^{I+1} C_j^I)$$

$$\prod_{I=2}^N \prod_{i,j} (1 - \mathcal{Q}'_I \mathcal{Q}''_{I-1} D_j^I C_i^{I-1})^{-1} \prod_{I=1}^{N-1} \prod_{i,j} (1 - \mathcal{Q}'_I \mathcal{Q}''_I B_j^I A_i^{I+1})^{-1}$$

$$\sum_{\xi'_1, \dots, \xi'_{N-1}, \xi''_1, \dots, \xi''_{N-2}} \prod_{I=1}^{N-1} \left((-\mathcal{Q}''_I)^{|\xi'_I|} (-\mathcal{Q}'_{I+1})^{|\xi''_I|} \right)$$

$$\prod_{I=1}^{N-1} \left(\sum_{\eta'_I} s_{\xi'_{I-1} / \eta'_I} (-\mathcal{Q}''_I A^{I+1}) s_{\xi'_I / \eta'_I} (-\mathcal{Q}'_I B^I) \sum_{\eta''_I} s_{\xi''_I / \eta''_I} (-\mathcal{Q}''_I C^I) s_{\xi'_{I+1} / \eta''_I} (-\mathcal{Q}'_{I+1} D^{I+1}) \right)$$

Using Equation B.1 then gives

$$(B.12) \quad \tilde{\mathcal{S}}^{(N)}(\mathbf{A}, \mathbf{B}, \mathbf{C}, \mathbf{D} | \mathbf{Q}', \mathbf{Q}'') =$$

$$\begin{aligned}
& \prod_{l=1}^N \prod_{i,j} (1 - Q'_l B_i^l D_j^l) \prod_{l=1}^{N-1} \prod_{i,j} (1 - Q''_l A_i^{l+1} C_j^l) \\
& \prod_{l=2}^N \prod_{i,j} (1 - Q'_l Q''_{l-1} D_j^l C_i^{l-1})^{-1} \prod_{l=1}^{N-1} \prod_{i,j} (1 - Q'_l Q''_l B_j^l A_i^{l+1})^{-1} \\
& \tilde{\mathcal{S}}^{(N-1)} (-Q''A^+, -Q'B, -Q''C, -s'^+ D^+ | Q'', Q'^+)
\end{aligned}$$

where, for any given set of variables $x = (x_1, x_2, x_3, \dots)$, $y = (y_1, y_2, Y, \dots)$, we define,

$$(B.13) \quad x^+ := (x_2, x_3, \dots), \quad xy := (x_1 y_1, x_2 y_2, x_3 Y, \dots).$$

B.0.4. *Step 3. The induction.* By the induction hypothesis,

$$\begin{aligned}
(B.14) \quad \tilde{\mathcal{S}}^{(N-1)} (-Q''A^+, -Q'B, -Q''C, -Q'^+ D^+ | Q'', Q'^+) = \\
& \prod_{J=1}^{N-1} \prod_{l=1}^J \prod_{i,j} \left(1 - \prod_{K=l}^{J-1} Q'_{K+1} \prod_{K=l}^J Q''_K Q'_{J+1} Q'_l D_j^{J+1} B_i^l \right) \\
& \prod_{J=1}^{N-1} \prod_{l=1}^{J-1} \prod_{i,j} \left(1 - \prod_{K=l}^{J-1} Q'_{K+1} \prod_{K=l+1}^{J-1} Q''_K Q'_J Q'_l A_j^{J+1} C_i^l \right) \\
& \prod_{J=1}^{N-1} \prod_{l=1}^{J-1} \prod_{i,j} \left(1 - \prod_{K=l}^{J-1} Q'_{K+1} \prod_{K=l}^{J-1} Q''_K Q'_J Q'_l A_j^{J+1} B_i^l \right)^{-1} \\
& \prod_{J=1}^{N-1} \prod_{l=1}^{J-1} \prod_{i,j} \left(1 - \prod_{K=l}^{J-1} Q'_{K+1} \prod_{K=l+1}^J Q''_K Q'_{J+1} Q'_l D_j^{J+1} C_i^l \right)^{-1}
\end{aligned}$$

from Equation B.4 for $(N-1)$. Therefore,

$$\begin{aligned}
(B.15) \quad \tilde{\mathcal{S}}^{(N)} (A, B, C, D | Q', Q'') = \\
& \prod_{l=1}^N \prod_{i,j} (1 - Q'_l D_j^l B_i^l) \prod_{l=1}^{N-1} \prod_{i,j} (1 - Q''_l A_j^{l+1} C_i^l) \\
& \prod_{l=1}^{N-1} \prod_{i,j} (1 - Q'_{l+1} Q''_l D_j^{l+1} C_i^l)^{-1} \prod_{l=1}^{N-1} \prod_{i,j} (1 - Q'_l Q''_l A_j^{l+1} B_i^l)^{-1} \\
& \prod_{J=1}^{N-1} \prod_{l=1}^J \prod_{i,j} \left(1 - \prod_{K=l}^J Q''_K \prod_{K=l}^{J+1} Q'_K D_j^{J+1} B_i^l \right) \prod_{J=1}^{N-1} \prod_{l=1}^{J-1} \prod_{i,j} \left(1 - \prod_{K=l}^J Q''_K \prod_{K=l+1}^J Q'_K A_j^{J+1} C_i^l \right) \\
& \prod_{J=1}^{N-1} \prod_{l=1}^{J-1} \prod_{i,j} \left(1 - \prod_{K=l}^J Q''_K \prod_{K=l}^J Q'_K A_j^{J+1} B_i^l \right)^{-1} \prod_{J=1}^{N-1} \prod_{l=1}^{J-1} \prod_{i,j} \left(1 - \prod_{K=l}^J Q''_K \prod_{K=l+1}^{J+1} Q'_K D_j^{J+1} C_i^l \right)^{-1} \\
& = \prod_{l=1}^N \prod_{i,j} (1 - Q'_l D_j^l B_i^l) \prod_{l=1}^{N-1} \prod_{i,j} (1 - Q''_l A_j^{l+1} C_i^l)
\end{aligned}$$

$$\begin{aligned}
& \prod_{I=1}^{N-1} \prod_{i,j} (1 - Q''_I Q'_I A_j^{I+1} B_i^I)^{-1} \prod_{I=1}^{N-1} \prod_{i,j} (1 - Q''_I Q'_{I+1} D_j^{I+1} C_i^I)^{-1} \\
& \prod_{J=1}^N \prod_{I=1}^{J-1} \prod_{i,j} \left(1 - \prod_{K=I}^{J-1} Q''_K \prod_{K=I}^J Q'_K D_j^J B_i^I \right) \prod_{J=1}^N \prod_{I=1}^{J-2} \prod_{i,j} \left(1 - \prod_{K=I}^{J-1} Q''_K \prod_{K=I+1}^{J-1} Q'_K A_j^J C_i^I \right) \\
& \prod_{J=1}^N \prod_{I=1}^{J-2} \prod_{i,j} \left(1 - \prod_{K=I}^{J-1} Q''_K \prod_{K=I}^{J-1} Q'_K A_j^J B_i^I \right)^{-1} \prod_{J=1}^N \prod_{I=1}^{J-2} \prod_{i,j} \left(1 - \prod_{K=I}^{J-1} Q''_K \prod_{K=I+1}^J Q'_K D_j^J C_i^I \right)^{-1} \\
& = \prod_{J=1}^N \prod_{I=1}^J \prod_{i,j} \left(1 - \prod_{K=I}^{J-1} Q''_K \prod_{K=I}^J Q'_K D_j^J B_i^I \right) \prod_{J=1}^N \prod_{I=1}^{J-1} \prod_{i,j} \left(1 - \prod_{K=I}^{J-1} Q''_K \prod_{K=I+1}^{J-1} Q'_K A_j^J C_i^I \right) \\
& \prod_{J=1}^N \prod_{I=1}^{J-1} \prod_{i,j} \left(1 - \prod_{K=I}^{J-1} Q''_K \prod_{K=I}^{J-1} Q'_K A_j^J B_i^I \right)^{-1} \prod_{J=1}^N \prod_{I=1}^{J-1} \prod_{i,j} \left(1 - \prod_{K=I}^{J-1} Q''_K \prod_{K=I+1}^J Q'_K D_j^J C_i^I \right)^{-1}
\end{aligned}$$

This concludes the proof of Equation B.4.

REFERENCES

- [1] M Aganagic, A Klemm, M Marino and C Vafa, *The topological vertex*, Communications in mathematical physics **25.2** (2005) 425-478, arXiv:hep-th/0305132
- [2] L F Alday, D Gaiotto and Y Tachikawa, *Liouville Correlation Functions from Four-dimensional Gauge Theories*, Letters in Mathematical Physics **91.2** (2010) 167–197, arXiv:1012.1312 [hep-th]
- [3] M N Alfimov, A A Belavin and G M Tarnopolsky, *Coset conformal field theory and instanton counting on $\mathbb{C}_2/\mathbb{Z}_p$* , Journal of High Energy Physics **2013.8** (2013), 134, arXiv:1306.3938 [hep-th]
- [4] M N Alfimov and G M Tarnopolsky, *Parafermionic Liouville field theory and instantons on ALE spaces*, Journal of High Energy Physics **2012.2** (2012) 36, arXiv:1110.5628 [hep-th]
- [5] K B Alkalaev and V A Belavin, *Conformal blocks of W_N minimal models and AGT correspondence*, Journal of High Energy Physics **2014.7** (2014) 1-16, arXiv:1404.7094 [hep-th]
- [6] H Awata, B Feigin, and J Shiraishi, *Quantum algebraic approach to refined topological vertex*, Journal of High Energy Physics **2012.03** 41, arXiv:1112.6074 [hep-th]
- [7] H Awata and H Kanno, *Instanton counting, Macdonald function and the moduli space of D-branes*, Journal of High Energy Physics **2005.5** (2005) 039, hep-th/0502061
- [8] H Awata and H Kanno, *Refined BPS state counting from Nekrasov's formula and Macdonald functions*, International Journal of Modern Physics **A24** (2009) 2253–2306, arXiv:0805.0191 [hep-th]
- [9] H Awata, H Kanno, A Mironov, A Morozov, K Suetake, and Y Zenkevich, *(q, t)-KZ equations for quantum toroidal algebra and Nekrasov partition functions on ALE spaces*, Journal of High Energy Physics **2018.03** (2018) 192, arXiv:1712.08016 [hep-th]
- [10] A Belavin, V Belavin and M Bershtein, *Instantons and 2d Superconformal field theory*, Journal of High Energy Physics **2011.9** (2011) 117, arXiv:1106.4001 [hep-th]
- [11] A A Belavin, M A Bershtein, B L Feigin, A V Litvinov and G M Tarnopolsky, *Instanton moduli spaces and bases in coset conformal field theory*, Communications in Mathematical Physics **319.1** (2013) 269-301, arXiv:1111.2803 [hep-th]
- [12] A A Belavin, M A Bershtein and G M Tarnopolsky, *Bases in coset conformal field theory from AGT correspondence and Macdonald polynomials at the roots of unity*, Journal of High Energy Physics **2013.3** (2013) 19, arXiv:1211.2788 [hep-th]

- [13] V Belavin and B Feigin, *Super Liouville conformal blocks from $\mathcal{N} = 2$ $SU(2)$ quiver gauge theories*, Journal of High Energy Physics **2011.7** (2011) 79, arXiv:1105.5800 [hep-th]
- [14] V Belavin, O Foda, and R Santachiara, *AGT, N -Burge partitions and \mathcal{W}_N minimal model*, Journal of High Energy Physics **2015.10** (2015) 73, arXiv:1507.03540 [hep-th]
- [15] A Belavin and B Mukhametzhanov, *$\mathcal{N} = 1$ superconformal blocks with Ramond fields from AGT correspondence*, Journal of High Energy Physics (2013.1) 178, arXiv:1210.7454 [hep-th]
- [16] A A Belavin, A M Polyakov and A B Zamolodchikov, *Infinite conformal symmetry in two-dimensional quantum field theory*, Nuclear Physics **B 241** (1984) 333-380
- [17] V Belavin and N Wyllard, *$\mathcal{N} = 2$ superconformal blocks and instanton partition functions*, Journal of High Energy Physics (2012.6) 173, arXiv:1205.3091 [hep-th]
- [18] M Bershtein and O Foda, *AGT, Burge pairs and minimal models*, Journal of High Energy Physics (2014.6) 1-29, arXiv:1404.7075 [hep-th]
- [19] G Bonelli, K Maruyoshi and A Tanzini, *Instantons on ALE spaces and super Liouville conformal field theories*, Journal of High Energy Physics (2011.8) 56, arXiv:1106.2505 [hep-th]
- [20] G Bonelli, K Maruyoshi and A Tanzini, *Gauge theories on ALE space and super Liouville correlation functions*, Letters in Mathematical Physics **101.1** (2012) 103-124, arXiv:1107.4609 [hep-th]
- [21] J E Bourguine and S Jeong, *New quantum toroidal algebras from 5D $\mathcal{N} = 1$ instantons on orbifolds*, arXiv:1906.01625 [hep-th]
- [22] J Bryan, Ch Cadman, and B Young, *The orbifold topological vertex*, Advances in Mathematics **229.1** (2012): 531-595, arXiv:1008.4205
- [23] V I S Dotsenko and V A Fateev, *Conformal algebra and multipoint correlation functions in 2D statistical models*, Nuclear Physics **B 240.3** (1984) 312-348
- [24] V I S Dotsenko and V A Fateev, *Four-point correlation functions and the operator algebra in the 2D conformal invariant theories with the central charge $C \leq 1$* , Nuclear Physics **B 251** (1985) 691-734
- [25] O Foda, N Macleod, T Welsh and M Manabe, *$\widehat{\mathfrak{sl}}(n)_N$ WZW conformal blocks from $SU(N)$ instanton partition functions on $\mathbb{C}^2/\mathbb{Z}_n$* , to appear, 2019
- [26] O Foda and J-F Wu, *A Macdonald refined topological vertex*, Journal of Physics **A 50** (2017) 294003, arXiv:1701.08541 [hep-th]
- [27] O Foda and R-D Zhu, *An elliptic topological vertex*, Nuclear Physics **B 936** (2018) 448-471 arXiv:1805.12073 [hep-th]
- [28] F Fucito, J-F Morales and R Poghossian, *Multi-instanton calculus on ALE spaces*, Nuclear Physics **B 703** (2004) 518-536 arXiv:0406243 [hep-th]
- [29] Amer Iqbal, *All Genus Topological String Amplitudes and 5-brane Webs as Feynman Diagrams*, arXiv:hep-th/0207114
- [30] A Iqbal and A Kashani-Poor, *The vertex on a strip*, Advances in Theoretical and Mathematical Physics **10.3** (2006) 317-343, arXiv:hep-th/0410174
- [31] A Iqbal, C Kozcaz and C Vafa, *The refined topological vertex*, Journal of High Energy Physics **10** (2009) 069, arXiv:hep-th/0701156
- [32] Y Ito, K Maruyoshi, T Okuda, *Scheme dependence of instanton counting in ALE spaces*, Journal of High Energy Physics **2013.5** (2013) 45, arXiv:1303.5765 [hep-th]
- [33] H Itoyama, T Oota, R Yoshioka, *2d-4d connection between q -Virasoro/ \mathcal{W} block at root of unity limit and instanton partition function on ALE space*, Nuclear Physics **B 877.02** (2013) 506-537, arXiv:1308.2068 [hep-th]
- [34] G James and A Kerber, *The representation theory of the symmetric group*, Encyclopedia of Mathematics and its Applications **16** (1981), Addison-Wesley Publishing Company.
- [35] A Kanno, Y Matsuo and H Zhang, *Extended conformal symmetry and recursion formulae for Nekrasov partition function*, Journal of High Energy Physics **2013**, no. 8 (2013) 1-27. arXiv:1306.1523

- [36] Sh Katz, A Klemm and C Vafa, *Geometric engineering of quantum field theories*, Nuclear Physics **B497.1** (1997) 173–195, arXiv:hep-th/9609239
- [37] Sh Katz, P Mayr and C Vafa, *Mirror symmetry and exact solution of 4d $N = 2$ gauge theories I*, Advances in Theoretical and Mathematical Physics **1** (1998) 53–114, arXiv:hep-th/9706110
- [38] N A Loehr, *Bijjective combinatorics*, CRC Press (2011)
- [39] I G Macdonald, *Symmetric functions and Hall polynomials*, 2nd Edition, Clarendon Press (1995) Oxford.
- [40] A Mironov and A Morozov, *On AGT relation in the case of $U(3)$* , Nuclear physics **B 825** (2010) 1-37, arXiv:0908.2569 [hep-th]
- [41] T Miwa, M Jimbo, and A Date, *Solitons: Differential equations, symmetries and infinite dimensional algebras*, Cambridge University Press, 2000.
- [42] B Nienhuis, *Coulomb gas representations of phase transitions in two dimensions*, Phase Transitions and Critical Phenomena **11** (1987) 1-53
- [43] T Nishioka and Y Tachikawa, *Central charges of para-Liouville and Toda theories from M5-branes*, Physical Review **D84.4** (2011) 046009, arXiv:hep-th/1106.1172
- [44] J B Olsson, *Combinatorics and representations of finite groups*, Vorlesungen aus dem Fachbereich Mathematik, Universität GH Essen (1994), Essen, Germany
- [45] R Poghossian, *Recurrence relations for the \mathcal{W}_3 conformal blocks and $N = 2$ SYM partition functions*, Journal High Energy Physics **11** (2017) 053, arXiv:1705.00629 [hep-th]
- [46] L Spodyneiko, *AGT correspondence: Ding-Iohara algebra at roots of unity and Lepowsky-Wilson algebra*, Journal of Physics **A 48.27** (2015) 275404, arXiv:1409.3465 [hep-th]
- [47] N Wyllard, *$A_{(N-1)}$ conformal Toda field theory correlation functions from conformal $N = 2$ $SU(N)$ quiver gauge theories*, Journal of High Energy Physics (2009.11) 002, arXiv:0907.2189 [hep-th]
- [48] N Wyllard, *Coset conformal blocks and $N = 2$ gauge theories*, arXiv:1109.4264
- [49] Al B Zamolodchikov, *Conformal symmetry in two dimensions: an explicit recurrence formula for the conformal partial wave amplitude*, Communications in Mathematical Physics **96.3** (1984) 419-422
- [50] Al B Zamolodchikov, *Conformal symmetry in two-dimensional space: recursion representation of conformal block*, Theoretical and Mathematical Physics **73.1** (1987) 1088-1093

SCHOOL OF MATHEMATICS AND STATISTICS, UNIVERSITY OF MELBOURNE, ROYAL PARADE, PARKVILLE, VICTORIA 3010, AUSTRALIA

E-mail address: n.chaimanowong@student.unimelb.edu.au, omar.foda@unimelb.edu.au