

On orthogonal symmetric chain decompositions*

Karl Däubel, Sven Jäger, Torsten Mütze, and Manfred Scheucher

Institut für Mathematik, Technische Universität Berlin, Germany
{daeubel,jaeger,muetze,scheucher}@math.tu-berlin.de

Abstract

The n -cube is the poset obtained by ordering all subsets of $\{1, \dots, n\}$ by inclusion, and it can be partitioned into $\binom{n}{\lfloor n/2 \rfloor}$ chains, which is the minimum possible number. Two such decompositions of the n -cube are called *orthogonal* if any two chains of the decompositions share at most a single element. Shearer and Kleitman conjectured in 1979 that the n -cube has $\lfloor n/2 \rfloor + 1$ pairwise orthogonal decompositions into the minimum number of chains, and they constructed two such decompositions. Spink recently improved this by showing that the n -cube has three pairwise orthogonal chain decompositions for $n \geq 24$. In this paper, we construct four pairwise orthogonal chain decompositions of the n -cube for $n \geq 60$. We also construct five pairwise *edge-disjoint* symmetric chain decompositions of the n -cube for $n \geq 90$, where edge-disjointness is a slightly weaker notion than orthogonality, improving on a recent result by Gregor, Jäger, Mütze, Sawada, and Wille.

1 Introduction

The n -dimensional cube Q_n , or n -cube for short, is the poset obtained by taking all subsets of $[n] := \{1, \dots, n\}$, and ordering them by inclusion. This poset is sometimes also called the *subset lattice* or the *Boolean lattice*, and it is a fundamental and widely studied object in combinatorics. For illustration, Figure 1 shows the 4-cube. In this figure and throughout this paper, we draw posets by their Hasse diagrams.

Clearly, Q_n is a graded poset with rank function given by the set sizes, and every maximal chain has size $n + 1$. We refer to the family of all subsets of a fixed size $k \in \{0, \dots, n\}$ as the k th level of Q_n . It is easy to see that Q_n has a unique largest level $n/2$ for even n , and two largest levels $\lfloor n/2 \rfloor$ and $\lceil n/2 \rceil$ for odd n . We refer to these levels as *middle levels*. Sperner's classical theorem [Spe28] asserts that each middle level is in fact a largest antichain of Q_n , i.e., Q_n has width $a_n := \binom{n}{\lfloor n/2 \rfloor}$. As a consequence, at least a_n many chains are needed to partition Q_n , and by Dilworth's theorem [Dil50], a partition into this many chains indeed exists. De Bruijn, van Ebbenhorst Tengbergen, and Kruiswijk [dBvETK51] first described an inductive construction of a partition of Q_n into a_n many chains that are all *symmetric* and *saturated*, i.e., every chain starts and ends in symmetric levels around the middle, and no chain skips any intermediate levels. Throughout this paper, we will refer to their decomposition as the *standard decomposition*. Lewin [Lew72], Aigner [Aig73], and White and Williamson [WW77] gave alternative descriptions of the standard decomposition via greedy matching algorithms as well as explicit local rules to follow the chains in the standard decomposition. The easiest-to-remember local rule using parenthesis matching was given by Greene and Kleitman [GK76] (we will describe their rule in Section 3.1). The standard decomposition of Q_n was famously used by Kleitman [Kle65] to prove the two-dimensional case of the Littlewood-Offord conjecture on signed sums of vectors [LO38] (later proved in all dimensions by Kleitman [Kle70]).

*An extended abstract of this paper has been submitted to Eurocomb 2019.

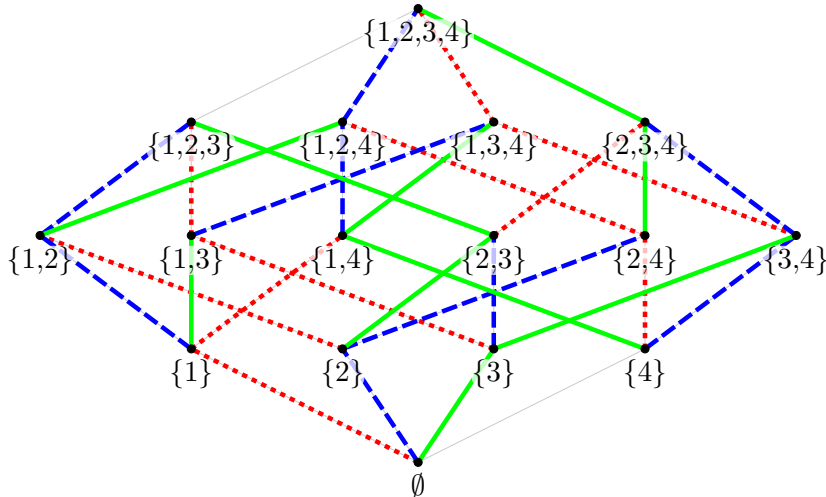

Figure 1: Hasse diagram of the 4-cube Q_4 , with three pairwise orthogonal chain decompositions into 6 chains, highlighted by thick solid, dashed, and dotted lines.

Shearer and Kleitman [SK79] were the first to investigate chain decompositions of the n -cube that are different from the aforementioned standard decomposition. They proved that, when picking subsets $x, y \subseteq [n]$ at random, the probability that $x \subseteq y$ is at least $1/a_n$, for every probability distribution on Q_n . Their proof introduces the notion of orthogonal chain decompositions. Formally, two decompositions of Q_n into a_n (not necessarily symmetric or saturated) chains are called *orthogonal* if every two chains from the two decompositions have at most a single element of Q_n in common. For example, Figure 1 shows three pairwise orthogonal chain decompositions into 6 chains in Q_4 . Shearer and Kleitman conjectured that Q_n admits $b_n := \lfloor n/2 \rfloor + 1$ pairwise orthogonal chain decompositions for all $n \geq 1$. As a warm-up exercise, we verified their conjecture for $n \leq 7$ with computer help. It is easy to check that there are at most b_n pairwise orthogonal decompositions (consider the node degrees in the Hasse diagram around the middle levels).

As a first step towards their conjecture, Shearer and Kleitman established the existence of *two* orthogonal chain decompositions for all $n \geq 2$. They proved this by showing that the standard decomposition and its *complement*, obtained by taking the complements of all sets with respect to the full set $[n]$, are almost-orthogonal. Formally, we say that two decompositions of Q_n into a_n symmetric and saturated chains are *almost-orthogonal* if every two chains from the two decompositions have at most a single element of Q_n in common, with the exception of the two unique chains of size $n + 1$, which are only allowed to intersect in their minimal and maximal elements \emptyset and $[n]$. It is straightforward to verify that for $n \geq 5$, every family of almost-orthogonal decompositions can be modified to orthogonal decompositions, by moving the empty set \emptyset in all but one of the decompositions from the unique longest chain to a shortest chain, one decomposition at a time (see [SK79, Spi17] for details).

Recently, Spink [Spi17] made the first progress towards the Shearer-Kleitman conjecture from 1979 by proving that Q_n has *three* pairwise orthogonal chain decompositions for $n \geq 24$. He actually showed that Q_n has three almost-orthogonal decompositions into symmetric and saturated chains, from which the result follows as described before.

1.1 Our results

Using Spink’s product construction, we improve on his result as follows.

Theorem 1. *For all $n \geq 60$, the n -cube has four pairwise almost-orthogonal decompositions into symmetric and saturated chains, and consequently four pairwise orthogonal chain decompositions.*

A slightly weaker notion than almost-orthogonality was introduced in a recent paper by Gregor, Jäger, Mütze, Sawada, and Wille [GJM⁺18]. We refer to any cover relation $x \subseteq y$ as an *edge* (x, y) (y is one level above x), and we say that two decompositions of Q_n into a_n symmetric and saturated chains are *edge-disjoint* if the two decompositions do not share any edges. Equivalently, the two decompositions form edge-disjoint paths in the cover graph of Q_n , which is the graph formed by all cover relations. By this definition, every pair of almost-orthogonal chain decompositions is edge-disjoint, but not necessarily vice versa. The main application of edge-disjoint chain decompositions in [GJM⁺18] was to construct cycle factors in subgraphs of Q_n induced by an interval of levels around the middle, with the goal of generalizing the recent proof of the middle levels conjecture by Mütze [Müt16] (see also [GMN18]). It is also easy to check that Q_n admits at most b_n pairwise edge-disjoint chain decompositions. The authors of [GJM⁺18] conjectured that this bound can be achieved for all $n \geq 1$. They verified this conjecture for $n \leq 7$, and proved that Q_n has *four* pairwise edge-disjoint decompositions for $n \geq 12$. We improve on this result as follows.

Theorem 2. *For all $n \geq 90$, the n -cube has five pairwise edge-disjoint decompositions into symmetric and saturated chains.*

Unless stated otherwise, all chains we consider in the following are symmetric and saturated, and we will from now on omit those qualifications. Moreover, we refer to any decomposition of Q_n into symmetric and saturated chains as an *SCD*. Also, when referring to a family of pairwise almost-orthogonal or pairwise edge-disjoint SCDs, we will from now on omit the qualification ‘pairwise’.

1.2 Small dimensions

Table 1 summarizes what is known for small values of n . Specifically, the table shows the maximum number of almost-orthogonal and edge-disjoint SCDs of Q_n that we know for $n \leq 25$, together with the upper bound b_n . As indicated in the table, we actually found six edge-disjoint SCDs of Q_{11} , which, using the product construction from [GJM⁺18], yields six edge-disjoint SCDs for all dimensions $n = 11k$, $k \in \mathbb{N}$. To extend this result to all but finitely many dimensions, thus improving Theorem 2, we would only need to find six edge-disjoint SCDs of Q_n for some dimension n not of this form. It is also interesting to note that there are *no* three almost-orthogonal SCDs of Q_4 (see [Spi17]), i.e., in this case the trivial upper bound b_n cannot be achieved. Nevertheless, there are three orthogonal decompositions using non-symmetric chains in Q_4 —see Figure 1—so this shows that not every family of orthogonal chain decompositions can be obtained from almost-orthogonal SCDs.

As the table shows, we can also slightly improve Spink’s aforementioned result [Spi17] that Q_n has three almost-orthogonal SCDs for $n \geq 24$. His proof left only the dimensions $n = 6, 8, 9, 11, 13, 16, 18, 23$ as possible exceptions [Spi17, Theorem 3.3] (for $n \geq 5$). Using the SCDs shown in our table for $n \leq 11$ and Spink’s product construction [Spi17, Theorem 3.5], we can close all those gaps, and obtain that Q_n has three almost-orthogonal SCDs for all $n \geq 5$, and three orthogonal chain decompositions for all $n \geq 4$, providing some more evidence for the Shearer-Kleitman conjecture. We also see that Q_n has four edge-disjoint SCDs for all $n \geq 6$, ruling out the two possible exceptions $n = 9, 11$ left by Gregor et al. [GJM⁺18].

Remark 1. Our lower bounds for edge-disjoint SCDs differ from the upper bound b_n by 1 exactly for the dimensions $n = 8, 9, 10$; see the values in the dotted box in Table 1. In fact, it can be shown that our approach for finding edge-disjoint SCDs via the necklace poset N_n yields at most $b_n - 1$ edge-disjoint SCDs of Q_n for all even n and for $n = 9$ (see Lemma 8 below), so our methods cannot yield better lower bounds for those cases.

n	1	2	3	4	5	6	7	8	9	10	11														
almost-orthogonal SCDs	1	2	2	2	3	3*	4*	3*	3*	3	4*														
edge-disjoint SCDs	1	2	2	3	3	4	4	4	4*	5*	6*														
upper bound $b_n = \lfloor n/2 \rfloor + 1$	1	2	2	3	3	4	4	5	5	6	6														
												12	13	14	15	16	17	18	19	20	21	22	23	24	25
												3	3*	4*	3	3*	3	4*	3	3	4*	4*	3*	3	4*
												4	4	4	4	4	4	4	4	5*	5*	6*	4	4	4
												7	7	8	8	9	9	10	10	11	11	12	12	13	13

Table 1: Number of almost-orthogonal and edge-disjoint SCDs of Q_n we know for $n \leq 25$. Entries marked with * are new compared to the earlier results from [Spi17] and [GJM⁺18]. For $n \leq 11$, the corresponding families of SCDs are provided electronically on the third authors' website [www19] and on the arXiv [DJMS19], and for the shaded entries they are also shown in Figures 8–11. For $n \geq 12$, they are obtained via the product constructions presented in [Spi17] and [GJM⁺18]. The entries in the dotted box are explained in Remark 1.

1.3 Proof ideas

We now outline the main ideas for proving Theorems 1 and 2.

Product constructions We compute families of $s = 4$ almost-orthogonal and $s = 5$ edge-disjoint SCDs, for two cubes Q_a and Q_b of small coprime dimensions a and b . Specifically, these dimensions will be $(a, b) = (7, 11)$ and $(a, b) = (10, 11)$, respectively; see the shaded entries in Table 1. Using the product constructions presented in [Spi17] and [GJM⁺18], we then obtain s SCDs of the corresponding type for all dimensions n for which n is a non-negative integer combination of a and b , in particular for all $n \geq (a - 1)(b - 1)$. This evaluates to $n \geq 60$ and $n \geq 90$ for the aforementioned pairs (a, b) , respectively.

Problem reduction via the necklace poset To find families of SCDs in cubes of small fixed dimension ($n = 7, 10$, and 11) that satisfy the desired constraints, we reduce the search space to a much smaller poset, the so-called *necklace poset* N_n ; see Figure 2. It is obtained from Q_n by identifying all subsets that differ only in cyclically renaming the elements of the ground set $1 \rightarrow 2 \rightarrow \dots \rightarrow n \rightarrow 1$. The necklace poset N_n inherits the level structure from Q_n , and notions such as symmetric chains and SCDs translate to it in a natural way. Moreover, N_n is by a factor of $n(1 - o(1))$ smaller than Q_n , which turns out to be crucial for our computer searches for SCDs. We refer to the process of translating an SCD computed in N_n to Q_n as *unrolling*. Unrolling essentially creates n copies of each chain in N_n , and these copies are obtained by cyclic renaming as explained before. This strategy works particularly well when n is a prime number, and with some adjustments it can also be made to work for composite n . We also introduce a suitable notion of edge multiplicities for the necklace poset (as indicated in Figure 2), which allows us to find multiple edge-disjoint SCDs in N_n simultaneously, and to unroll them to multiple edge-disjoint SCDs in Q_n . Specifically, we prove that the two constructions of SCDs in N_n found by Griggs, Killian, and Savage [GKS04] and by Jordan [Jor10] can be unrolled to almost-orthogonal SCDs in Q_n . The key steps here are Lemmas 10 and 11 and Proposition 12 below.

Using SAT solvers To search multiple edge-disjoint SCDs in the necklace poset N_n for some small fixed dimension n , we formulate the problem as a propositional formula in conjunctive normal form (CNF), and compute solutions using the SAT solvers Glucose [ALS13] and Mini-Sat [ES03]. In our CNF formula, we use Boolean variables that indicate whether certain nodes

and edges belong to a particular SCD, and we introduce clauses ensuring that a satisfying variable assignment indeed corresponds to an unrollable SCD, and that multiple SCDs are edge-disjoint. Once a valid variable assignment is found, we use incremental CNF augmentation to enforce the remaining properties, in particular almost-orthogonality of the unrolled SCDs in Q_n . Specifically, if we encounter a violation, we add an additional clause that prevents this particular configuration. We solve the augmented CNF using an incremental SAT solver, until we either find a feasible solution or obtain a formula with no satisfying assignment. This approach keeps the size of the generated CNFs and of the computation time small, as the solvers can reuse structural information of the CNFs, rather than recomputing a solution from scratch. The size of the formulas can be reduced further by prescribing some SCDs to be particularly nice decompositions.

1.4 Related work

Other chain decompositions There is a considerable amount of literature on partitioning the n -cube using possibly non-symmetric and/or non-saturated chains. One of the most interesting open problems in this direction is a well-known conjecture of Füredi [Für85] (cf. [Gri88]), which asserts that Q_n can be decomposed into a_n (not necessarily symmetric or saturated) chains whose sizes differ by at most 1, so their size is $2^n/a_n$ rounded up or down, which is approximately $\sqrt{\pi n}(1 + o(1))$. Tomon [Tom15] recently made some progress towards this conjecture, by showing that for large enough n , the n -cube can be decomposed into a_n chains whose size is between $0.8\sqrt{n}$ and $13\sqrt{n}$. Another remarkable result, recently shown by Gruslys, Leader, and Tomon [GLT19], is that for large enough n , the n -cube can be partitioned into copies of any fixed poset P , provided that the number of elements of P is a power of 2 and that P has a unique minimal and maximal element.

Pikurkho [Pik99] showed that all edges of the n -cube can be partitioned into symmetric chains, but it is not clear whether some of those chains can be selected to form one or more SCDs. In a slightly different direction, Streib and Trotter [ST14] presented the construction of an SCD of the n -cube that can be extended to a Hamiltonian cycle through the entire cover graph.

The existence and construction of SCDs has also been investigated for many graded posets different from Q_n . The paper [dBvETK51] proves that divisor lattices, which are products of chains, are symmetric chain orders, and Griggs [Gri77] gave a sufficient condition for a general graded poset to admit an SCD.

Griggs, Killian, and Savage first constructed an explicit SCD of the necklace poset N_n [GKS04] when the dimension n is a prime number, with the goal of constructing rotation-symmetric Venn diagrams for n curves in the plane (see [RSW06]). Their result for N_n with n prime was later generalized by Jordan [Jor10] to all $n \in \mathbb{N}$, and to even more general quotients of Q_n by Duffus, McKibben-Sanders, and Thayer [DMST12]. All these constructions in the necklace poset proceed by taking suitable subchains from the standard SCD of Q_n . Further generalizations of these results can be found in [Dha12, HS13, DT15].

SAT solvers in combinatorics We conclude this section by listing some recent results where SAT solvers were used successfully to tackle difficult problems in (extremal) combinatorics, either by using them to find a solution, or to prove that no solution exists. Fujita [Fuj12] established a new lower bound $R(4, 8) \geq 58$ for the classical Ramsey numbers. Similarly, Dransfield, Liu, Marek, and Truszczyński [DLMT04] derived improved bounds for van der Waerden numbers (see also [HHvLvM07] and [KP08]). Another recent result that received considerable attention is the paper by Konev and Lisitsa [KL14] on the Erdős discrepancy conjecture. SAT solvers have also been used in the context of geometry, specifically for tackling Erdős-Szekeres type questions, see the papers by Balko and Valtr [BV17] and by Scheucher [Sch18]. Moreover, with their help researchers were able to find new coil-in-the-box Gray codes [ZKC08] and to compute pairs of orthogonal diagonal Latin squares [ZKS16].

1.5 Outline of this paper

In Section 2 we present the proofs of our two main theorems. The proofs of two crucial lemmas, which settle the base cases for our construction, are deferred to Section 5 at the end of the paper. In Section 3 we explain our reduction technique to produce SCDs of Q_n by working in the much smaller necklace poset N_n , and in Section 4 we describe how to exploit this reduction using a SAT solver.

2 Product constructions implying Theorems 1 and 2

As already mentioned in the introduction, both of our theorems are proved by applying product constructions established in [Spi17] and [GJM⁺18], respectively, which allow us to obtain s almost-orthogonal or edge-disjoint SCDs of Q_{a+b} , given s such SCDs in the smaller cubes Q_a and Q_b . In the following we will repeatedly use the basic number-theoretic fact that, if a and b are coprime integers, then every integer $n \geq (a-1)(b-1)$ is a non-negative integer combination of a and b .

2.1 Proof of Theorem 1

The product construction for almost-orthogonal SCDs requires an additional property that we now define: A family of almost-orthogonal SCDs of the n -cube for some odd n is called *good* if the union of edges given by all chains of size 2 from all the decompositions forms a unicyclic graph, i.e., a graph all of whose components contain at most a single cycle. The following crucial statement was proved in [Spi17].

Lemma 1 ([Spi17, Theorem 3.5]). *Let $s \geq 3$ and $r \geq 2$ be integers, and let $n_1, \dots, n_r \geq 3$ be a sequence of odd integers. If each Q_{n_i} , $1 \leq i \leq r$, has a good family of s almost-orthogonal SCDs, then $Q_{n_1+\dots+n_r}$ has s almost-orthogonal SCDs.*

The base case for applying Lemma 1 is the following result, which will be proved in Section 5.

Lemma 2. *The cubes Q_7 and Q_{11} each have four good almost-orthogonal SCDs.*

Proof of Theorem 1. As every integer $n \geq (7-1)(11-1) = 60$ is a non-negative integer combination of 10 and 11, we can apply Lemmas 1 and 2 to obtain the desired SCDs. \square

Spink [Spi17, Theorem 3.6] also proved that the goodness requirement in Lemma 1 can be omitted if the additional condition $r \geq 6$ is added. As every integer $n \geq 60$ is a non-negative integer combination of 7 and 11 with coefficients that sum up to at least 6, we would not need the families of SCDs of Q_7 and Q_{11} to be good to prove Theorem 1. However, since proving this modified version of Lemma 1 is considerably harder, partially deferred to another paper [DST18], and since goodness is not hard to achieve on top of almost-orthogonality, we prefer to stick with Lemma 1 in its stated form. Moreover, in this form the lemma also yields four almost-orthogonal SCDs for all non-negative integer combinations of 7 and 11 that are smaller than 60.

2.2 Proof of Theorem 2

The following product lemma for edge-disjoint SCDs was proved in [GJM⁺18].

Lemma 3 ([GJM⁺18, Theorem 5]). *If Q_a and Q_b each have s edge-disjoint SCDs, then Q_{a+b} has s edge-disjoint SCDs.*

The base case for applying Lemma 3 is the following result, which will be proved in Section 5.

Lemma 4. *The cubes Q_{10} and Q_{11} each have five edge-disjoint SCDs.*

Proof of Theorem 2. As every integer $n \geq (10 - 1)(11 - 1) = 90$ is a non-negative integer combination of 10 and 11, we can apply Lemmas 3 and 4 to obtain the desired SCDs. \square

To complete the proofs of our main theorems, it remains to prove Lemma 2 and Lemma 4. The corresponding SCDs are provided in Section 5 below.

3 Unrolling the necklace poset

Given a subset $x \subseteq [n]$, we write $\sigma(x)$ for the subset obtained from x by cyclically renaming elements $1 \rightarrow 2 \rightarrow \dots \rightarrow n \rightarrow 1$. Moreover, we write $\langle x \rangle$ for the family of all subsets obtained by repeatedly applying σ to x , and we refer to $\langle x \rangle$ as a *necklace*, and to any element of $\langle x \rangle$ as a *necklace representative*. We say that the necklace $\langle x \rangle$ is *full* if $|\langle x \rangle| = n$, and *deficient* if $|\langle x \rangle| < n$. For example, for $n = 4$ the necklace $\langle \{1,3,4\} \rangle = \{\{1,3,4\}, \{2,4,1\}, \{3,1,2\}, \{4,2,3\}\}$ is full, and the necklace $\langle \{1,3\} \rangle = \{\{1,3\}, \{2,4\}\}$ is deficient. Note that the cardinality of any necklace divides n . Consequently, if n is a prime number, then $\langle \emptyset \rangle$ and $\langle [n] \rangle$ are the only deficient necklaces, and all other necklaces are full. On the other hand, if n is composite, then there are more than these two deficient necklaces.

The *necklace poset* N_n is the set of all necklaces $\langle x \rangle$, $x \subseteq [n]$, and its cover relations are all pairs $(\langle x \rangle, \langle y \rangle)$ for which $x \subseteq y$ form a cover relation in the n -cube; see the left hand side of Figure 2. Similarly to the n -cube, we also refer to the cover relations in N_n as *edges*. As σ preserves the set size, N_n inherits the level structure from Q_n , and notions such as symmetric chains and SCDs translate to N_n in the natural way.

As almost all necklaces of N_n are full, we have that N_n is by a factor of $n(1 - o(1))$ smaller than Q_n , which is vital for our computer searches for SCDs. We now collect a few simple observations about transferring SCDs from N_n to Q_n . These observations are illustrated in Figure 2. Recall that all chains we consider are symmetric and saturated.

Observation 5. *Let $y = (y_1, \dots, y_k)$ be a chain of full necklaces in N_n . Then there are necklace representatives $x = (x_1, \dots, x_k)$ with $x_i \in y_i$ for $1 \leq i \leq k$, such that $\sigma^i(x) = (\sigma^i(x_1), \dots, \sigma^i(x_k))$ for $i = 0, \dots, n - 1$ is a family of n disjoint chains in Q_n that visit exactly all elements from y_1, \dots, y_k .*

The easiest way to pick necklace representatives satisfying those conditions is to move up the chain y from its minimal element y_1 to its maximal element y_k , starting with an arbitrary representative $x_1 \in y_1$, and then arbitrarily picking $x_{j+1} \in y_{j+1}$ for $j = 1, \dots, k - 1$ such that (x_j, x_{j+1}) is an edge in Q_n .

We refer to the process of translating a chain from N_n to a family of n chains in Q_n as described by Observation 5 as *unrolling*. As an example, consider the chain $(y_1, \dots, y_4) = (\langle \{1\} \rangle, \langle \{1,2\} \rangle, \langle \{1,2,3\} \rangle, \langle \{1,2,3,4\} \rangle)$ in N_5 . The necklace representatives $x = (x_1, \dots, x_4) = (\{1\}, \{1,2\}, \{1,2,3\}, \{1,2,3,4\})$ form a chain in Q_5 , and $\sigma^i(x)$, $i = 0, \dots, 4$, is a family of five disjoint chains in Q_5 that visit exactly all $5 \cdot 4 = 20$ elements from y_1, \dots, y_4 . It is crucial here to observe that the choice of necklace representatives in Observation 5 is *not unique*. In the previous example, we could also choose $x = (x_1, \dots, x_4) = (\{1\}, \{1,5\}, \{1,4,5\}, \{1,2,4,5\})$ as necklace representatives, yielding a *different* family of five disjoint chains in Q_5 .

The notion of unrolling can be extended straightforwardly from a chain of full necklaces to a chain that has one deficient necklace at each of its ends, as captured by the following observation. The crucial insight here is that if a necklace $\langle x \rangle$ is deficient and of size $d < n$, then $\langle x \rangle = \{\sigma^i(x) \mid i = 0, \dots, d - 1\}$.

Observation 6. *Let (y_0, \dots, y_{k+1}) be a chain of necklaces in N_n such that y_1, \dots, y_k are full and y_0 and y_{k+1} are deficient and of the same size $d < n$. Then there are necklace representatives (x_0, \dots, x_{k+1}) with $x_i \in y_i$ for $0 \leq i \leq k + 1$, such that $\sigma^i(x_0, \dots, x_{k+1})$ for $i = 0, \dots, d - 1$, and*

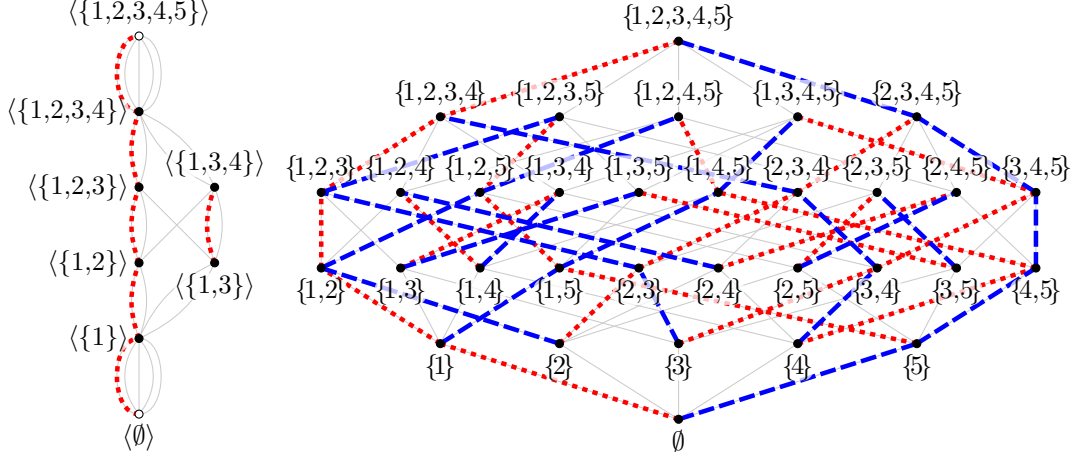

Figure 2: Unrolling an SCD of the necklace poset N_5 (left) to an SCD of the 5-cube (right). The SCD is highlighted by dotted lines, full necklaces are indicated by filled bullets, and deficient necklaces are indicated by empty bullets. Complementing the resulting SCD of Q_5 yields another SCD (dashed lines), which is edge-disjoint from the first one. The capacities of the edges of N_n are visualized by multiple parallel edges.

$\sigma^i(x_1, \dots, x_k)$ for $i = d, \dots, n-1$, is a family of n disjoint chains in Q_n that visit exactly all elements from y_0, \dots, y_{k+1} .

As an example, consider the chain $y = (y_0, \dots, y_4) = (\langle\{1,5\rangle\rangle, \langle\{1,2,5\rangle\rangle, \langle\{1,2,3,5\rangle\rangle, \langle\{1,2,3,5,6\rangle\rangle, \langle\{1,2,3,5,6,7\rangle\rangle)$ in N_8 . It has one deficient necklace of size $d = 4$ at each of its ends, and all inner necklaces are full. Taking $x = (x_0, \dots, x_4) = (\{1,5\}, \{1,2,5\}, \{1,2,3,5\}, \{1,2,3,5,6\}, \{1,2,3,5,6,7\})$ as necklace representatives, unrolling yields four chains of size 5, namely $\sigma^i(x_0, \dots, x_4)$ for $i = 0, 1, 2, 3$, and it yields four chains of size 3, namely $\sigma^i(x_1, \dots, x_3)$ for $i = 4, 5, 6, 7$.

We say that a chain in N_n is *unimodal* if its minimal and maximal element are necklaces of the same size (possibly deficient), and all other elements are full necklaces. Moreover, we say that an SCD of N_n is *unimodal* if all of its chains are unimodal. Combining Observations 5 and 6 yields the following fact, which allows us to translate an entire SCD from N_n to Q_n .

Observation 7. *Given a unimodal SCD of N_n , $n \geq 1$, unrolling each of its chains yields an SCD of Q_n .*

This observation is illustrated in Figure 2. We refer to the process of unrolling all chains of an SCD of N_n to an SCD of Q_n as *unrolling the SCD*. Recall that in this unrolling process there may be several choices for picking necklace representatives for each chain.

We now want to simultaneously unroll multiple SCDs from N_n to edge-disjoint SCDs of Q_n . This motivates the following definitions: For any edge $e = (\langle x \rangle, \langle y \rangle)$ of N_n where $\langle x \rangle$ is on level $k \leq (n-1)/2$, we define the *capacity* $c(e)$ as the number of distinct elements from $[n]$ that can be added to x to reach an element in $\langle y \rangle$. For any edge $e = (\langle y \rangle, \langle x \rangle)$ of N_n where $\langle x \rangle$ is on level $k \geq (n+1)/2$, we define the capacity $c(e)$ symmetrically as the number of distinct elements from $[n]$ that can be removed from x to reach an element in $\langle y \rangle$. We can think of the cover graph of N_n with those capacities on its edges e as a multigraph with edge multiplicities $c(e)$; see the left hand side of Figure 2. It is easy to see that the sum of capacities of all edges $e = (\langle x \rangle, \langle y \rangle)$ for fixed $\langle x \rangle$ on level $k \leq (n-1)/2$ is $n - k$, which is equal to the number of neighbors of x in level $k+1$ of the cover graph of Q_n . We say that a family of unimodal SCDs of N_n is *edge-disjoint* if for every edge e in N_n , there are at most $c(e)$ chains in those SCDs containing this edge.

For even $n \geq 4$, the middle level of N_n contains the deficient necklace $\langle\{1, 3, 5, \dots, n-1\}\rangle$. Consequently, any unimodal chain containing this necklace has size 1. It follows that the edges incident to this necklace cannot be used by any chain, so that the upper bound b_n for the

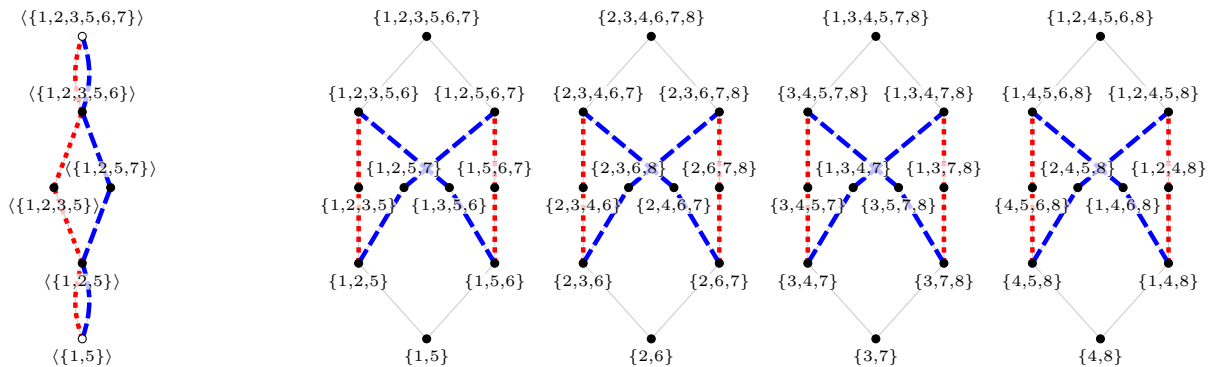

Figure 3: Given the two unimodal chains in N_8 (left; the chains are dashed and dotted), it is impossible to unroll them so that the resulting sets of chains are edge-disjoint in Q_8 (right). In each of the four blocks on the right, extending one of the two dashed chains to include the two extreme elements prevents both dotted chains to be extended.

maximum number of edge-disjoint SCDs given in the introduction (for Q_n) can be improved by 1, yielding the following lemma (see [Wil18] for a formal proof).

Lemma 8. *For even $n \geq 4$, there are at most $b_n - 1 = n/2$ unimodal SCDs of N_n that are edge-disjoint.*

Lemma 8 shows that our approach via the necklace poset N_n yields at most four edge-disjoint SCDs of N_8 and at most five edge-disjoint SCDs of N_{10} ; recall Remark 1. By considering the deficient necklace $\langle\{1, 4, 7\}\rangle$ and its complement in N_9 , one can similarly show that N_9 has at most $b_9 - 1 = 4$ edge-disjoint SCDs (see [Wil18]).

The following lemma was stated and proved in [GJM⁺18] in slightly different form.

Lemma 9 ([GJM⁺18, Lemma 7]). *Let $n \geq 2$ be a prime number. Every family of $s \leq b_n$ unimodal SCDs of N_n that are edge-disjoint can be unrolled to s edge-disjoint SCDs of Q_n .*

In Section 5 we will apply Lemma 9 to prove the case $n = 11$ of Lemma 4.

Note that the conclusion of Lemma 9 does not hold if the dimension n is not prime, but composite. The example in Figure 3 shows that even two chains between two deficient necklaces in N_n cannot always be unrolled so that the resulting sets of chains are edge-disjoint in Q_n . Consequently, in general it may not be possible to unroll two edge-disjoint SCDs of N_n to two edge-disjoint SCDs of Q_n . Nevertheless, the next two lemmas show that unrolling is possible for two known constructions of SCDs of N_n , yielding not only two edge-disjoint SCDs, but even two almost-orthogonal SCDs of Q_n . Specifically, these constructions are due to Griggs, Killian, and Savage [GKS04] for prime n , and due to Jordan [Jor10] for all n , and they will be explained in the next section. It is worth to mention that both constructions in general yield different SCDs for prime n ; see Figure 5.

Lemma 10. *For every prime $n \geq 2$, the unimodal SCD of N_n constructed as in [GKS04] and its complement can be unrolled to two almost-orthogonal SCDs of Q_n .*

Lemma 11. *For every $n \geq 1$, the unimodal SCD of N_n constructed as in [Jor10] and its complement can be unrolled to two almost-orthogonal SCDs of Q_n .*

In Section 5 we will apply Lemma 10 to prove the cases $n = 7$ and $n = 11$ in Lemma 2 and we apply Lemma 11 to settle the case $n = 10$ in Lemma 4. Of course, we could simply check by computer whether these concrete small instances can be unrolled, but we still think that the preceding two lemmas are interesting general facts that have not appeared in the literature before.

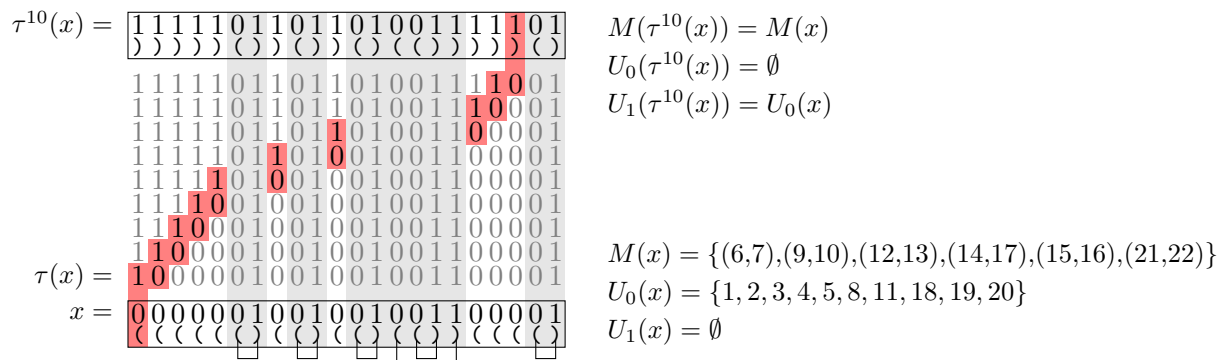

Figure 4: The parenthesis matching approach for constructing the symmetric chain containing a bitstring $x \in Q_{22}$.

The proof of Lemmas 10 and 11 is rather long and technical, and will be given in the next section. It is followed by Section 4, where we describe our computer search for SCDs of the necklace poset using a SAT solver. The reader may want to skip these parts for the moment, and continue in Section 5 with the proofs of Lemmas 2 and 4.

3.1 Proofs of Lemmas 10 and 11

In the remainder of this section we represent subsets of $[n]$ by their characteristic $\{0, 1\}$ -strings of length n . The i th entry of a bitstring x is denoted by x_i . For instance, the set $x = \{1, 3, 5, 6\} \subseteq [6]$ is represented by the bitstring $x = x_1 \dots x_6 = 101011 \in \{0, 1\}^6$. The operation $\sigma(x)$ on the set x translates to a cyclic right-rotation of the bitstring x . Moreover, we write $|x|$ for the number of 1s in x , which is the same as the level of x in Q_n . Also, for any bitstring x and any integer $r \geq 0$, we write x^r for the concatenation of r copies of x .

We begin by recapitulating the SCD constructions in the n -cube and the necklace poset described in the three papers [GK76, GKS04, Jor10]. The first construction by Greene and Kleitman is used as an auxiliary construction for the other two constructions, which we need for proving Lemmas 10 and 11. For the reader's convenience, the Greene-Kleitman construction is illustrated in Figure 4 for one particular chain, and the other two constructions are illustrated in Figure 5 for $n = 7$.

The Greene-Kleitman construction in Q_n Greene and Kleitman [GK76] proposed the following explicit construction of an SCD of Q_n . Given any bitstring x of length n , we think of every 0-bit as an opening parenthesis, and every 1-bit as a closing parenthesis, and we match closest pairs of opening and closing parentheses in the natural way; see Figure 4. We let $M(x)$ be the set of all index pairs corresponding to matched parentheses in x , and we let $U_0(x)$ and $U_1(x)$ be the index sets of unmatched opening and closing parentheses, respectively. The length of x clearly satisfies $n = 2|M(x)| + |U_0(x)| + |U_1(x)|$. For any x with $U_0(x) \neq \emptyset$, we let $\tau(x)$ be the bitstring obtained from x by flipping the leftmost unmatched 0 to a 1. The union of all chains $(x, \tau(x), \dots, \tau^k(x))$, where $x \in \{0, 1\}^n$ with $U_1(x) = \emptyset$ and $k = |U_0(x)|$, forms an SCD of the n -cube for all $n \geq 1$. This follows easily from the observation that we have $M(x) = M(\tau(x)) = \dots = M(\tau^k(x))$ and $U_0(\tau^k(x)) = \emptyset$ along each such chain, so the chain is uniquely determined by its matched pairs of parentheses. We denote this SCD by D_n . This is exactly the standard SCD of the n -cube mentioned in the introduction.

The Griggs-Killian-Savage construction in N_n for prime n To construct an SCD of N_n for prime n , Griggs, Killian, and Savage [GKS04] use the standard SCD D_n in Q_n as a start-

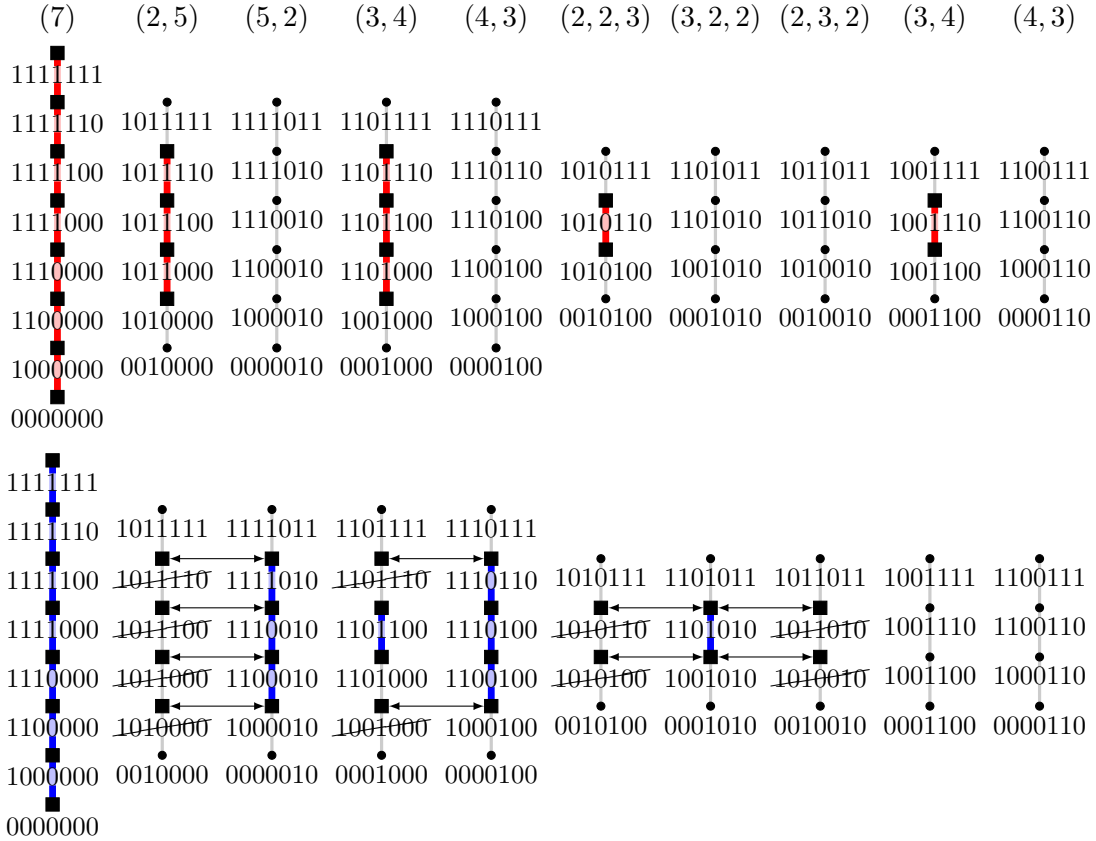

Figure 5: Illustration of the Griggs-Killian-Savage construction (top) and the Jordan construction (bottom) of an SCD of N_n for $n = 7$, by trimming the Greene-Kleitman SCD of Q_n . The figure shows only the chains from the standard SCD D_n that contain a bitstring with finite block code, all other chains from D_n are omitted as they do not contribute to either construction (see Lemmas 14 and 16). The block codes of the inner bitstrings of each chain are shown at the very top; the block codes of all chain endpoints are (∞) . Top: We select the bitstrings with lexicographically minimal block code in their necklace (marked by squares) as representatives R_n^{GKS} . Bottom: We select all bitstrings with the maximum number of unmatched 1s in their necklace (marked by squares) as representatives R_n^{J} . Representatives of the same necklace with the same number of unmatched 1s are highlighted by double arrows. If this occurs on two chains of the same length, then the trimming procedure applied in the Jordan construction is not unique. Note that by the trimming (struck through bitstrings), some chains disappear entirely. Also observe that the SCDs of N_n resulting from the two constructions (bold edges) are distinct.

ing point and select subchains of D_n , such that exactly one representative of each necklace is contained in one of the subchains.

For this purpose we define, for any $x \in \{0, 1\}^n$, the *block code* $\beta(x)$ as follows: If x has the form $x = 1^{a_1}0^{b_1}1^{a_2}0^{b_2} \dots 1^{a_r}0^{b_r}$ with $r \geq 1$ and $a_i, b_i \geq 1$ for all $i = 1, \dots, r$, then $\beta(x) := (a_1 + b_1, a_2 + b_2, \dots, a_r + b_r)$. Otherwise we define $\beta(x) := (\infty)$. If $\beta(x) \neq (\infty)$, then we say that the block code of x is *finite*. Note that the block code is finite if and only if x starts with 1 and ends with 0. Observe also that for all chains from the standard SCD D_n , the block code of all chain endpoints is (∞) , whereas along the inner bitstrings of each chain, we see the same finite block code along the chain; see Figure 5. For prime n , we let $R_n^{\text{GKS}} \subseteq \{0, 1\}^n$ be the set of all necklace representatives whose block code is lexicographically minimal in their necklace. As n is prime, this gives exactly one representative per necklace.¹ It was shown in [GKS04]

¹If n is composite, the method fails, as there may be several necklace representatives with the same block code, e.g., $x = 100110$ and $y = 110100$ with $\beta(x) = \beta(y) = (3, 3)$.

that the representatives R_n^{GKS} induce symmetric and saturated subchains of D_n , and we denote these subchains by D_n^{GKS} . Clearly, the corresponding chains in the necklace poset form an SCD of N_n .

The Jordan construction in N_n for arbitrary n Jordan’s construction [Jor10] of an SCD of N_n for arbitrary n also uses the standard SCD D_n in Q_n as a starting point, but selects subchains in a different fashion. We let R_n^{J} be the set of all necklace representatives that have the maximum number of unmatched 1s in their necklace. (It is easy to see that those also have finite block code—see Lemma 16—but this is irrelevant for the moment.) Note that R_n^{J} may contain several representatives from the same necklace; see Figure 5. It was shown in [Jor10] that these representatives R_n^{J} induce symmetric and saturated subchains of D_n . We now search for pairs of chains that contain two representatives of the same necklace. Jordan showed in her paper that these duplicates always lie symmetrically at the ends of both chains, so we may trim the shorter of the two chains symmetrically at both ends. If both chains have the same size, then we trim any of the two, yielding different resulting subchains. We repeat this trimming process until each necklace has only a single representative left, and we denote the remaining subchains of D_n by D_n^{J} . Clearly, the corresponding chains in the necklace poset form an SCD of N_n . We emphasize again that the outcome of the trimming procedure is not unique, but could be made unique by some lexicographic tie-breaking rule.

Proof of Lemmas 10 and 11 The following statements are the main steps for proving Lemmas 10 and 11. The proofs of these statements are deferred to the next subsection.

Our first proposition will be used to show that the cyclic rotations of the complement of any subchain of a chain in the standard decomposition D_n are almost-orthogonal to all other chains in D_n , and it can thus be seen as a generalization of the results of Shearer and Kleitman [SK79].

Proposition 12. *Consider two distinct bitstrings x and y with finite block code that lie on the same chain of D_n . Then for every $k \geq 0$, the bitstrings $\sigma^k(\bar{x})$ and $\sigma^k(\bar{y})$ do not lie on the same chain of D_n .*

The next two lemmas capture crucial properties of the subchains D_n^{GKS} of D_n obtained from the Griggs-Killian-Savage construction.

Lemma 13. *For every prime $n \geq 2$ and every chain from D_n^{GKS} , the corresponding necklaces form a unimodal chain in N_n .*

Lemma 14. *For every prime $n \geq 2$, all necklace representatives in R_n^{GKS} except 0^n and 1^n have finite block code.*

The next two lemmas are the analogous statements for the subchains D_n^{J} obtained from the Jordan construction.

Lemma 15. *For every $n \geq 1$ and every chain from D_n^{J} , the corresponding necklaces form a unimodal chain in N_n .*

Lemma 16. *For every $n \geq 1$, all necklace representatives in R_n^{J} except 0^n and 1^n have finite block code.*

With these lemmas in hand, the proof of Lemmas 10 and 11 is straightforward.

Proof of Lemma 10. We first consider the SCD of N_n for prime $n \geq 2$ obtained via the Griggs-Killian-Savage construction described before, specified by the chains of necklace representatives D_n^{GKS} . We let U_n be the SCD of Q_n obtained by unrolling each chain from this SCD. Furthermore, we let \bar{U}_n be the SCD of Q_n obtained by unrolling each chain from the complement of this SCD, or equivalently, by taking the complement of U_n . In both cases, unrolling

is possible because of Lemma 13 (recall Observations 5 and 6), where we also use that complementation preserves unimodality.

It remains to show that U_n and $\overline{U_n}$ are almost-orthogonal SCDs of Q_n . For this consider two distinct bitstrings x' and y' on the same chain in U_n that are neither 0^n nor 1^n . There is a unique $k \geq 0$, such that $x' = \sigma^k(x)$ and $y' = \sigma^k(y)$ for two bitstrings x and y on the same chain in D_n^{GKS} . Consider the following chain of implications:

- x' and y' lie on the same chain in $\overline{U_n}$.
- $\overline{x'}$ and $\overline{y'}$ lie on the same chain in U_n .
- There is a unique $\ell \geq 0$, so that $\sigma^\ell(\overline{x'})$ and $\sigma^\ell(\overline{y'})$ lie on the same chain in D_n^{GKS} .
- $\sigma^{k+\ell}(\overline{x})$ and $\sigma^{k+\ell}(\overline{y})$ lie on the same chain in D_n^{GKS} .

From Lemma 14 we know that x and y have finite block code. Clearly, if two elements lie on the same chain in D_n^{GKS} , then they also lie on the same chain in D_n . Consequently, applying Proposition 12 falsifies the last of the above statements, so the first one is also false, i.e., we obtain that x' and y' do not lie on the same chain in $\overline{U_n}$. To complete the proof that U_n and $\overline{U_n}$ are almost-orthogonal, we can verify directly that the unique longest chains in U_n and $\overline{U_n}$, namely $(0^n, 1^1 0^{n-1}, 1^2 0^{n-2}, \dots, 1^{n-2} 0^2, 1^{n-1} 0^1, 1^n)$ and its complement, intersect only in 0^n and 1^n . \square

Proof of Lemma 11. This proof proceeds in an analogous fashion as the proof of Lemma 10 presented before, using Lemmas 15 and 16 instead of Lemmas 13 and 14. \square

It remains to prove Proposition 12 and Lemmas 13–16, which will be done in the next three subsections.

Proof of Proposition 12 For the proof we will need the following auxiliary lemma.

Lemma 17. *Let $x, y \in \{0, 1\}^n$, and let i and j be two distinct indices such that $x_i x_{i+1} = 01$ and $y_i y_{i+1} \neq 01$, and $x_j x_{j+1} \neq 01$ and $y_j y_{j+1} = 01$. Then the sets $M(\sigma^k(x))$ and $M(\sigma^k(y))$ are distinct for all $k \geq 0$.*

Proof. Clearly, for any bitstring z we have that $(\ell, \ell + 1) \in M(z)$ if and only if $z_\ell z_{\ell+1} = 01$. In the following we consider all indices in x and y modulo n , with $1, \dots, n$ as representatives. As a consequence of our first observation, if $k \neq -i$, then $(k + i, k + i + 1)$ is in $M(\sigma^k(x))$ but not in $M(\sigma^k(y))$. Similarly, if $k \neq -j$, then $(k + j, k + j + 1)$ is in $M(\sigma^k(y))$ but not in $M(\sigma^k(x))$. As $i \neq j$, the two sets are distinct in any case. \square

Proof of Proposition 12. We assume without loss of generality that $|x| < |y|$, i.e., y is obtained from x by repeatedly applying τ . Furthermore, let i and j be the indices of the leftmost unmatched 0 in x and the rightmost unmatched 1 in y , respectively. More formally, we have $i = \min U_0(x)$ and $j = \max U_1(y)$. As x and y have finite block code, we have $x_1 = y_1 = 1$ and $x_n = y_n = 0$. In particular, these positions are unmatched, so $i > 1$ and $j < n$ are well-defined. Moreover, we clearly have $i \leq j$. Note that x_{i-1} is either matched or an unmatched 1. However, as every block of matched parentheses ends with 1, we have $x_{i-1} = y_{i-1} = 1$ in any case. A similar argument shows that $y_{j+1} = x_{j+1} = 0$. Summarizing, the situation looks as follows:

$$\begin{array}{cccc}
 1 & i & j & n \\
 y = 1 & *** & 1 & 1 & *** & 1 & 0 & *** & 0 \\
 x = 1 & *** & 1 & 0 & *** & 0 & 0 & *** & 0
 \end{array}
 \qquad
 \begin{array}{cccc}
 1 & i & j & n \\
 \overline{y} = 0 & *** & 0 & 0 & *** & 0 & 1 & *** & 1 \\
 \overline{x} = 0 & *** & 0 & 1 & *** & 1 & 1 & *** & 1
 \end{array}$$

From these observations it follows that $\overline{x_{i-1} x_i} = 01$ and $\overline{y_{i-1} y_i} = 00$, and similarly $\overline{x_j x_{j+1}} = 11$ and $\overline{y_j y_{j+1}} = 01$. Applying Lemma 17 to the indices $i - 1$ and j in \overline{x} and \overline{y} hence shows that $M(\sigma^k(\overline{x}))$ and $M(\sigma^k(\overline{y}))$ are distinct for all $k \geq 0$. As each chain of D_n is uniquely described by its matched pairs of parentheses, we obtain that $\sigma^k(\overline{x})$ and $\sigma^k(\overline{y})$ do not lie on the same chain, proving the proposition. \square

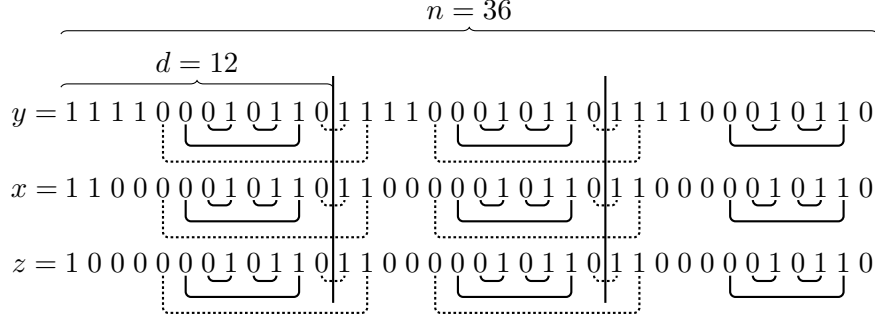

Figure 6: Illustration of the proof of Lemma 15 for $x = v^r$ with $v = 110000010110$ and $r = 3$. The brackets show matched pairs of parentheses, where solid brackets are matches within each copy of v in x , and dotted brackets are matches across different copies of v .

Proofs of Lemmas 13 and 14

Proof of Lemma 13. This is trivial, as there are only two deficient necklaces for prime n , namely $\langle 0^n \rangle$ and $\langle 1^n \rangle$. \square

Proof of Lemma 14. Each bitstring x other than 0^n and 1^n has two consecutive bits $x_i x_{i+1} = 01$. Consequently, the rotated bitstring $\sigma^{-i}(x)$ starts with 1 and ends with 0 and therefore has finite block code. \square

Proofs of Lemmas 15 and 16

Proof of Lemma 15. This proof was suggested in Wille's thesis [Wil18] on edge-disjoint SCDs in the n -cube, and is reproduced here with her permission.

Consider a chain from D_n^J with a bitstring x such that $\langle x \rangle$ is deficient and of size $d < n$. We will show that x is an endpoint of this chain and that the other endpoint y corresponds to a deficient necklace $\langle y \rangle$ of the same size d .

The following argument is illustrated in Figure 6. Define $r := n/d$ and let $v \in \{0, 1\}^d$ be such that $x = v^r$. We assume without loss of generality that $|x| \leq n/2$, implying that $|v| \leq d/2$. As every matched pair of parentheses involves exactly one 0 and one 1, it follows that $|U_0(v)| \geq |U_1(v)|$. This ensures that we can match every unmatched 1 in the i th copy of v in x with an unmatched 0 in the $(i - 1)$ th copy of v for all $i = 2, \dots, r$, implying that $U_1(x) = U_1(v)$.

We proceed to show that x is the starting point of its chain in D_n^J . If $U_1(x) = \emptyset$, then x is the starting point of its chain in D_n by definition, and consequently also the starting point of its chain in D_n^J . Otherwise $U_1(x) \neq \emptyset$, and we show that then $z := \tau^{-1}(x) \notin R_n^J$. By our observation from before, all unmatched 1s of x lie in the first copy of v , so we have $z = \tau^{-1}(x) = \tau^{-1}(v)v^{r-1}$. Together with the fact that $|U_1(\tau^{-1}(v))| = |U_1(v)| - 1$, we obtain $U_1(z) = U_1(x) - 1$ and $U_1(\sigma^{-d}(z)) = U_1(x)$. This implies $U_1(z) < U_1(\sigma^{-d}(z))$, i.e., z does not have the maximum number of unmatched 1s among the representatives of its necklace, so indeed $z \notin R_n^J$.

We now show that $y := \tau^{n-2|x|}(x)$ has the form $y = w^r$ for some $w \in \{0, 1\}^d$. This implies $|\langle y \rangle| \leq d$, which is sufficient to prove that actually $|\langle y \rangle| = d$, as otherwise we could reverse the roles of x and y in the proof, yielding a contradiction. For $i = 1, \dots, r - 1$, the number of 0s in the i th copy of v in x that are unmatched in x is $|U_0(v)| - |U_1(v)| = d - 2|v| = (n - 2|x|)/r$. Consequently, by applying $\tau^{n-2|x|}$ to x , we arrive at $\tau^{n-2|x|}(x) = w^r$ with $w = \tau^{d-2|v|}(v)$. \square

Proof of Lemma 16. Let $x \in R_n^J \setminus \{0^n, 1^n\}$, i.e., x has the maximum number of unmatched 1s among the representatives of its necklace. Note that $x_1 = 1$, as otherwise we could rotate x to the left until the first 1-bit reaches the first position, which would strictly increase the number of unmatched 1s. A similar argument shows that $x_n = 0$, as otherwise we could rotate x to the

right until the last 0-bit reaches the last position, which would strictly increase the number of unmatched 1s. These two observations imply that x has finite block code. \square

4 SAT based computer search

In this section we describe our computer search for SCDs in cubes of small dimension using a SAT solver.

4.1 The reduced necklace graph

We let N_n^- denote the multigraph obtained as follows: We consider the cover graph of N_n , where the edge multiplicities are given by the capacities (as defined before Lemma 8), and we remove all edges between a full necklace and a deficient necklace, whenever the deficient necklace is closer to the middle level(s); see Figure 7. Note here that even though N_n^- is a (multi)graph, it inherits the level structure from the poset N_n , so all the poset notions (chain, SCD, etc.) from before translate to N_n^- in the natural way. The aforementioned edge removals enforce that a chain containing a deficient necklace must either start or end at this necklace. Informally speaking, removing those edges does not harm us when searching for unimodal chains and SCDs, as they must not be contained in any unimodal chain anyway.

4.2 SAT formula for edge-disjoint SCDs of N_n^-

In this section we describe a propositional formula $\Phi(n, s)$ in conjunctive normal form (CNF), whose solutions correspond to s edge-disjoint unimodal SCDs of N_n^- . In the later sections we show how to modify those solutions, so that they can be unrolled to s edge-disjoint (and good almost-orthogonal) SCDs of Q_n . Throughout this section, the integers $n \geq 1$ and $s \geq 2$ are fixed.

We first compute the level sizes of N_n^- , and, based on this, the number c_n of chains and the chain sizes that an SCD must have. Different SCDs will be indexed by $i = 1, \dots, s$, and different chains in the i th SCD will be indexed by $j = 1, \dots, c_n$. We also assume that the chains of the i th SCD are indexed in decreasing order of their size, so chain $j = 1$ is the unique longest chain, and chain $j = c_n$ is a shortest chain.

We use Boolean variables $X_{i,j,e}$ to indicate that edge e of N_n^- is contained in chain j of decomposition i . Moreover, Boolean variables $Y_{i,j,u}$ are used to indicate that node u of N_n^- is contained in chain j of decomposition i . Clearly, we introduce these variables only for pairs (j, e) and (j, u) in the relevant levels. For instance, the node $u = \langle \emptyset \rangle$ can only be contained in the longest chain 1, so we only have a single variable $Y_{i,j,u}$ for fixed i and u , namely $Y_{i,1,u}$.

In the following we describe the clauses of our CNF formula $\Phi(n, s)$ in verbal form.

Link edge to node variables: If some edge variable $X_{i,j,e}$ is satisfied and the edge e connects nodes u and v , then both corresponding node variables $Y_{i,j,u}$ and $Y_{i,j,v}$ must be satisfied. Moreover, if some node variable $Y_{i,j,u}$ is satisfied and chain j extends above the level of u , then at least one edge variable $X_{i,j,e}$ for an edge e incident with u and a node from a level above must be satisfied. Similarly, if chain j extends below the level of u , then at least one edge variable $X_{i,j,e}$ for an edge e incident with u and a node from a level below must be satisfied. At a deficient necklace u , one or both of these edge sets are empty, and consequently a chain extending beyond the level of u in the corresponding direction will never be mapped to u .

Force chains to be present: For any chain j and a level k visited by this chain, at least one of the node variables $Y_{i,j,u}$, where u runs over all nodes on level k , must be satisfied.

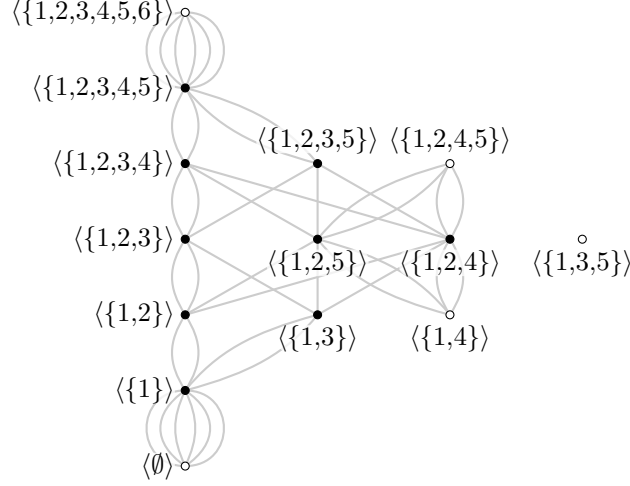

Figure 7: The multigraph N_6^- . As before, full necklaces are indicated by filled bullets, and deficient necklaces are indicated by empty bullets.

Node-disjoint chains: For any node u on a level visited by two chains j and j' in the same SCD i , at most one of the two node variables $Y_{i,j,u}$ or $Y_{i,j',u}$ must be satisfied.

Enforce unimodality: For any deficient necklace u on some level $k \leq (n - 1)/2$, if one of the node variables $Y_{i,j,u}$ is satisfied, then one of the corresponding variables $Y_{i,j,v}$, where v is on level $n - k$ and satisfies $|u| = |v|$, has to be satisfied. Note that there may be deficient necklaces of different sizes on the same level.

Edge-disjoint SCDs: For any two SCDs i and i' , any two chains j and j' from those SCDs, and any edge e between two consecutive levels that are intersected by both chains, at most one of the two edge variables $X_{i,j,e}$ and $X_{i',j',e}$ must be satisfied.

A useful trick to reduce the size of the resulting CNF formula dramatically is to fix some SCDs to be particular standard decompositions, for instance the ones mentioned in Lemmas 10 and 11, so that the corresponding edge and node variables are not free, but fixed constants. Similarly, we may also couple certain pairs of SCDs to be complements of each other, so only one set of variables is free, and the other is forced.

4.3 Unrolling by incremental CNF augmentation

Any solution of the CNF formula $\Phi(n, s)$ described before corresponds to s edge-disjoint unimodal SCDs of N_n^- (and N_n). However, as the example in Figure 3 shows, these SCDs cannot always be unrolled to s edge-disjoint SCDs of Q_n . Unfortunately, we have no systematic way to avoid this problem, so we resolve it in an ad-hoc fashion: We compute a satisfying assignment of $\Phi(n, s)$ using a SAT solver, and we test whether the current solution can be unrolled. If not, then we take the first pair of chains from two SCDs that cannot be unrolled simultaneously, and we add an additional clause that prevents this particular pair of chains to appear in a solution, yielding an augmented CNF formula $\Phi'(n, s)$. The advantage of this approach is that an incremental SAT solver has the ability to reuse information about the structure of $\Phi(n, s)$ when solving the augmented instance $\Phi'(n, s)$. We repeat this iterative process until we either find a solution that can be unrolled to s edge-disjoint SCDs of Q_n , or the resulting CNF formula has no satisfying assignment. In practice, this last case usually cannot be detected, as the solvers take too long to certify non-satisfiability.

n	s	SCDs	#variables	#clauses	solver	time	memory
7	4	almost-orthogonal	1.152	1.484	Glucose	0.048 s	11 MB
11	4	almost-orthogonal	132.432	1.437.326	MiniSat	23 min	972 MB
10	5	edge-disjoint	49.900	381.880	Glucose	2:29 h	501 MB
11	6	edge-disjoint	198.648	14.258.688	Glucose	3:51 h	1.6 GB

Table 2: Size of SAT instances and required computing resources. The number of variables and clauses are recorded at the end of the CNF augmentation and take into account internal simplifications carried out by the solver.

4.4 Good almost-orthogonal SCDs

We take a similar incremental approach to compute good families of almost-orthogonal SCDs. Again we start with the CNF formula $\Phi(n, s)$, and keep adding constraints that prevent certain pairs of chains to appear. Specifically, we forbid a pair of chains if it cannot be unrolled or if the unrolled chains intersect in more than one node (or in more than two if these are the longest chains). It turns out that adding the following clauses right in the beginning speeds up the incremental search process considerably, as it immediately excludes many local violations of almost-orthogonality.

Forbid diamonds: Consider four edges $e = (x, v)$, $f = (v, y)$, $g = (x, w)$, and $h = (w, y)$ that form a ‘diamond’, i.e., x is on some level k , the elements v and w are on level $k + 1$, and y is on level $k + 2$ of N_n^- , such that for any necklace representative of x , flipping the two bits corresponding to e and f leads to the same representative of y as flipping the two bits corresponding to g and h . For any two SCDs i and i' and any two chains j and j' from those SCDs that intersect all levels k to $k + 2$, not all four edge variables $X_{i,j,e}$, $X_{i,j,f}$, $X_{i',j',g}$, $X_{i',j',h}$ must be satisfied.

The goodness property could be enforced in a similar incremental way, but coincidentally, the solutions we obtained all satisfied this property right away. In hindsight, this might not be so surprising, given that the graph formed by the 2-element chains is relatively sparse: Every SCD contributes a matching that satisfies only a $\Theta(1/n)$ -fraction of all nodes on average.

4.5 Implementation details

We used the incremental SAT solvers Glucose [ALS13] and MiniSat [ES03]. The unrolling tests and incremental CNF augmentation that drive the SAT solver were implemented in C++. Table 2 shows the sizes of the generated SAT instances, running times, and memory requirements for the four families of SCDs that we computed for proving Lemmas 2 and 4 (shown in Figures 8–11).

5 Proofs of Lemmas 2 and 4

To prove Lemmas 2 and 4, we describe families of four good almost-orthogonal SCDs and five edge-disjoint SCDs of the n -cube for $n = 7, 11$ or $n = 10, 11$, respectively. We specify those SCDs in Figures 8–11 in compact form, by unimodal SCDs of the necklace poset N_n , from which the SCDs in the n -cube can be recovered by unrolling as described in Section 3 and by taking complements of some of the resulting SCDs. We specify each chain in one of these SCDs uniquely by a particular choice of necklace representatives (recall Observations 5 and 6 and the remarks between them). The representatives are described by specifying the minimal and maximal elements of each chain, and the elements from $[n]$ that are added/removed from the sets when moving along the chains. The resulting full SCDs of Q_n are provided in files that can be downloaded from the third authors’ website [www19] and on the arXiv [DJMS19], together

with a simple Python program for verification. In those files, subsets of $[n]$ are encoded by their characteristic bitstrings of length n (as in Section 3.1).

5.1 Proof of Lemma 2

We now describe four good almost-orthogonal SCDs of Q_7 and Q_{11} . The SCDs V_7 and V_{11} defined below are constructed as in [GKS04] (recall Section 3.1), and are then unrolled together with their complements as described in Lemma 10.

Figure 8 shows two SCDs V_7 and W_7 in N_7 , each consisting of 5 chains, that together with their complements $\overline{V_7}$ and $\overline{W_7}$ can be unrolled to four good almost-orthogonal SCDs of Q_7 ; see the file `Q7_4_ortho.txt`. Specifically, the union of all $4 \cdot 14 = 56$ edges given by all chains of size 2 of those SCDs forms one cycle of length 14 and 14 paths on 3 edges each. These are indeed all unicyclic components.

Figure 9 shows two SCDs V_{11} and W_{11} in N_{11} , each consisting of 42 chains, that together with their complements $\overline{V_{11}}$ and $\overline{W_{11}}$ can be unrolled to four good almost-orthogonal SCDs of Q_{11} ; see the file `Q11_4_ortho.txt`. Specifically, the union of all $4 \cdot 132 = 528$ edges given by all chains of size 2 of those SCDs forms 66 isolated edges, 22 paths on 2, 3, or 7 edges each, 22 trees on 5 edges (the trees have one degree 3 node with paths of lengths 1, 1, and 3 attached to it), and 2 cycles of length 22 with an additional dangling edge attached to each node. These are all unicyclic components.

5.2 Proof of Lemma 4

We now describe five edge-disjoint SCDs of Q_{10} and six edge-disjoint SCDs of Q_{11} . The SCD X_{10} defined below is constructed as in [Jor10] (recall Section 3.1), and is then unrolled together with its complement as described in Lemma 11. The SCDs of Q_{11} were computed with the help of Lemma 9.

Figure 10 shows three SCDs X_{10} , Y_{10} , and Z_{10} in N_{10} , each consisting of 26 chains, that together with the complements $\overline{X_{10}}$ and $\overline{Y_{10}}$ can be unrolled to five edge-disjoint SCDs of Q_{10} ; see the file `Q10_5_edge.txt`.

Figure 11 shows three SCDs X_{11} , Y_{11} , and Z_{11} in N_{11} , each consisting of 42 chains, that together with their complements $\overline{X_{11}}$, $\overline{Y_{11}}$, and $\overline{Z_{11}}$ can be unrolled to six edge-disjoint SCDs of Q_{11} ; see the file `Q11_6_edge.txt`.

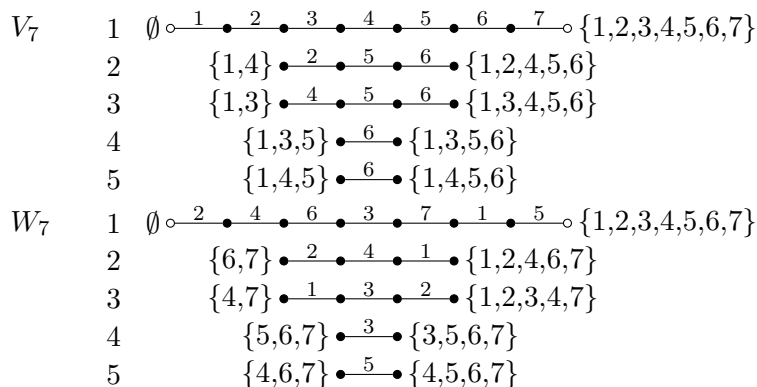
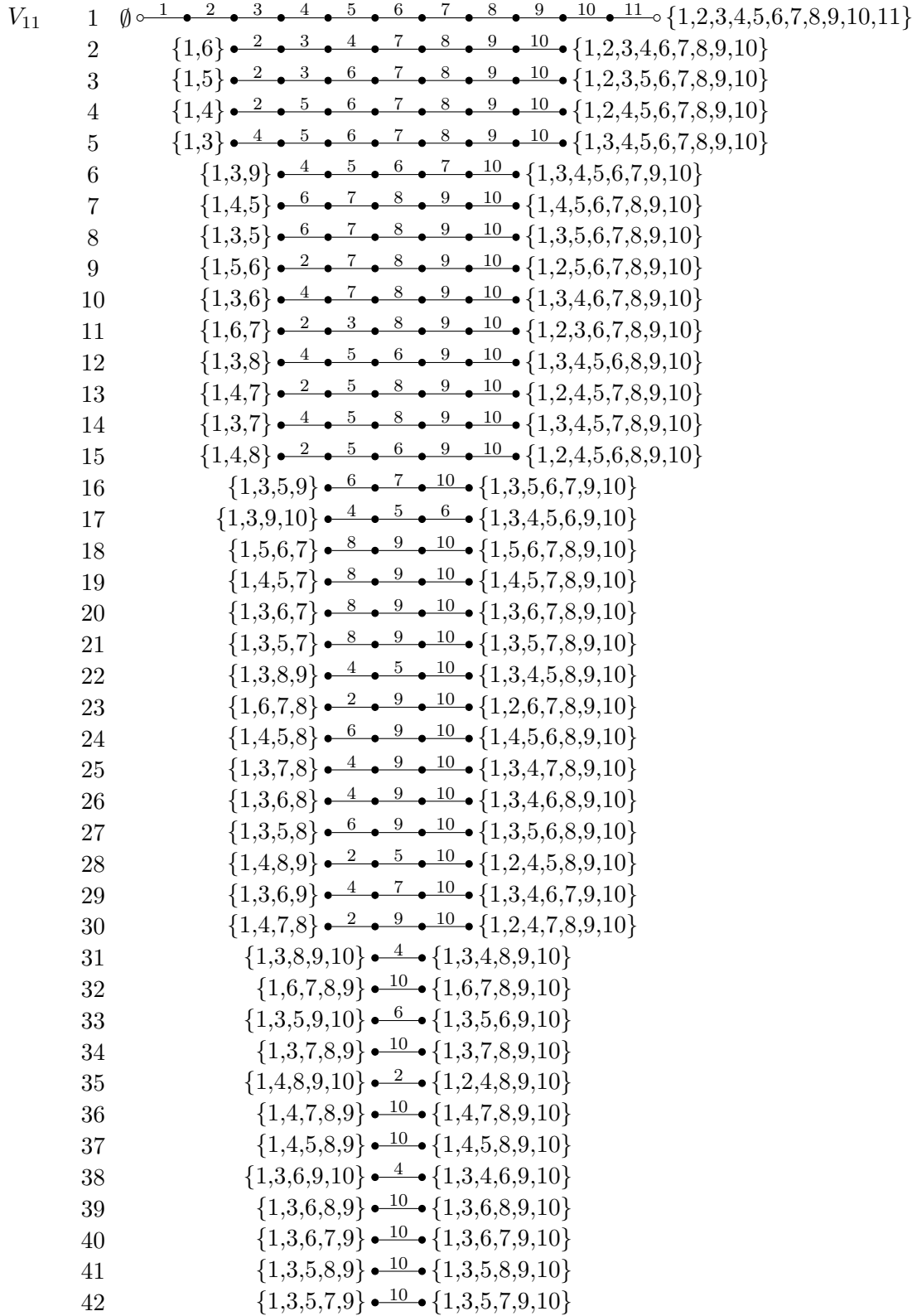

Figure 8: Two SCDs V_7 and W_7 in the necklace poset N_7 that together with their complements $\overline{V_7}$ and $\overline{W_7}$ can be unrolled to four good almost orthogonal SCDs in Q_7 .



(figure continues on next page)

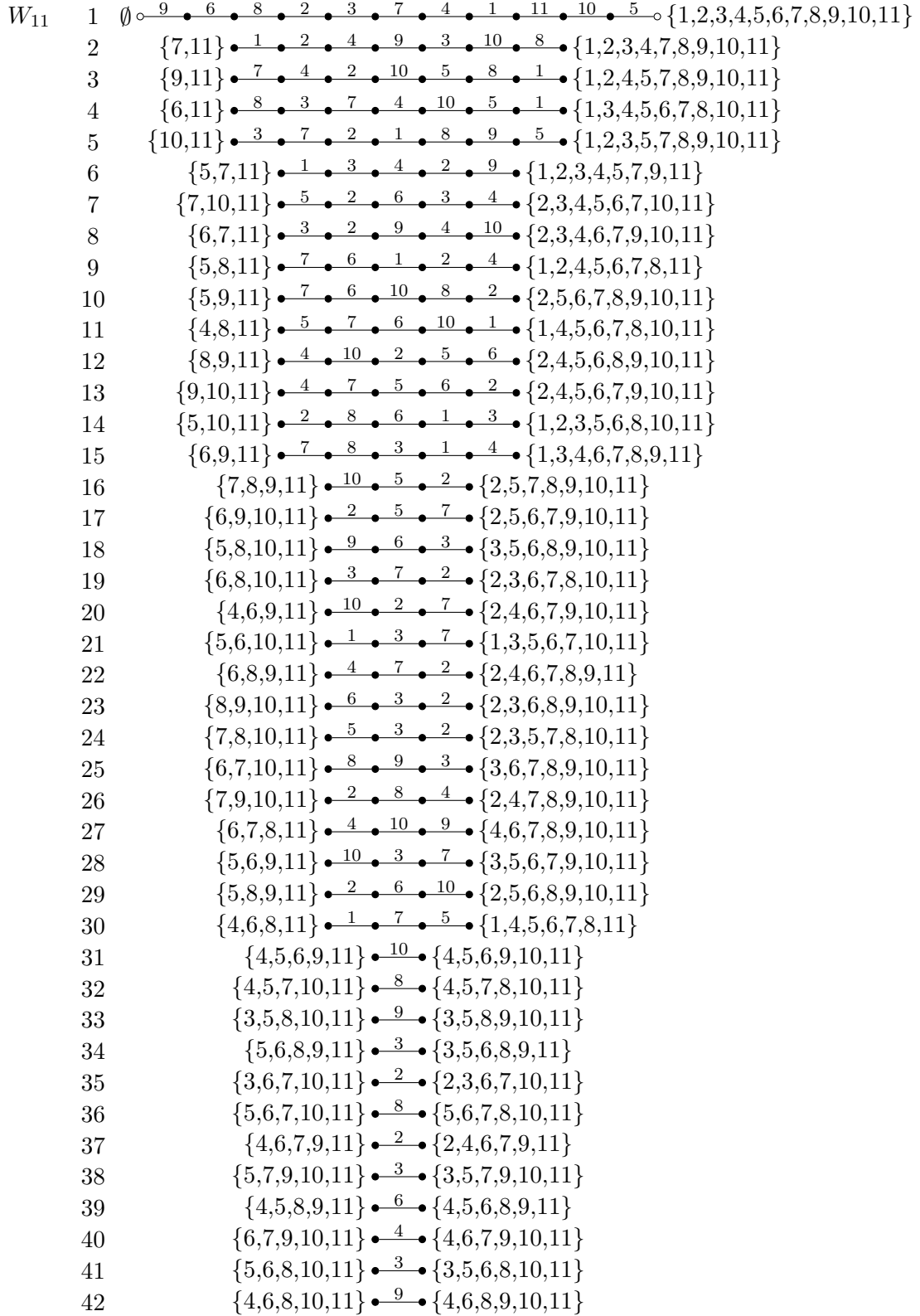
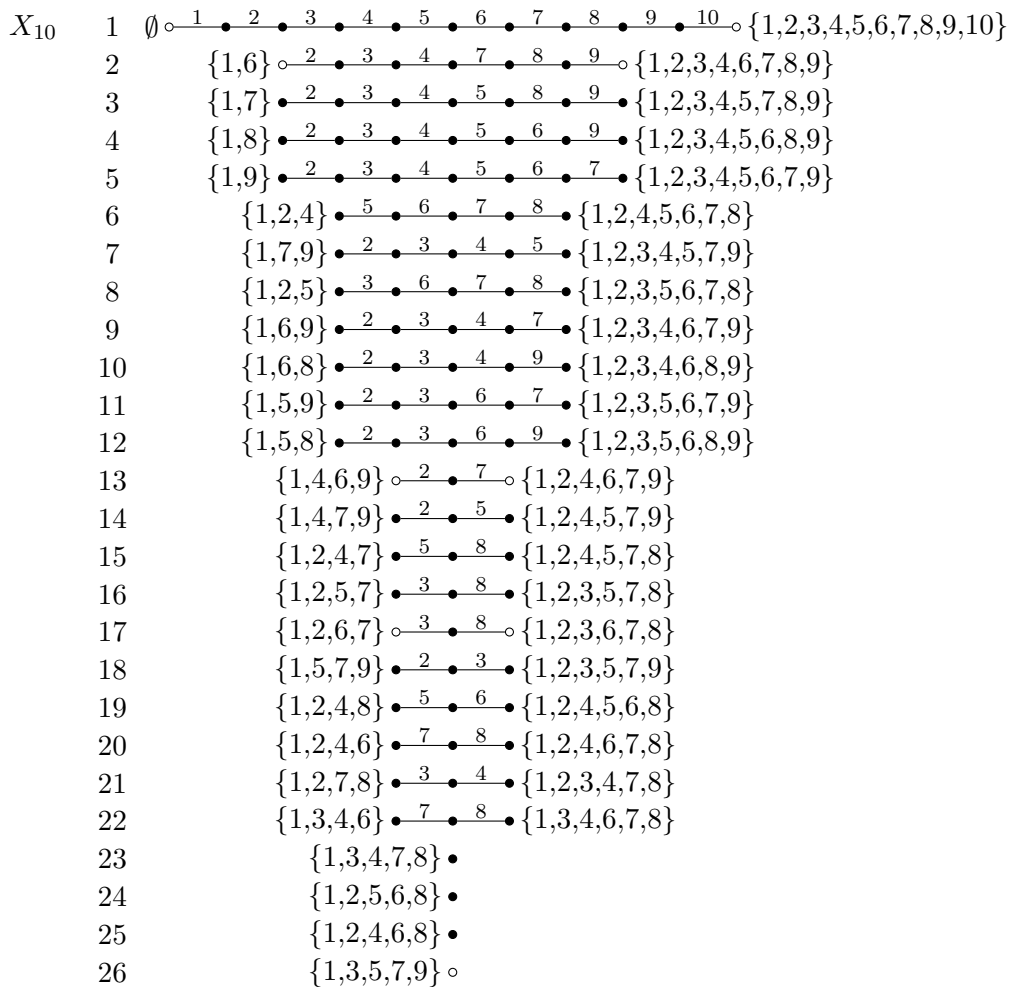
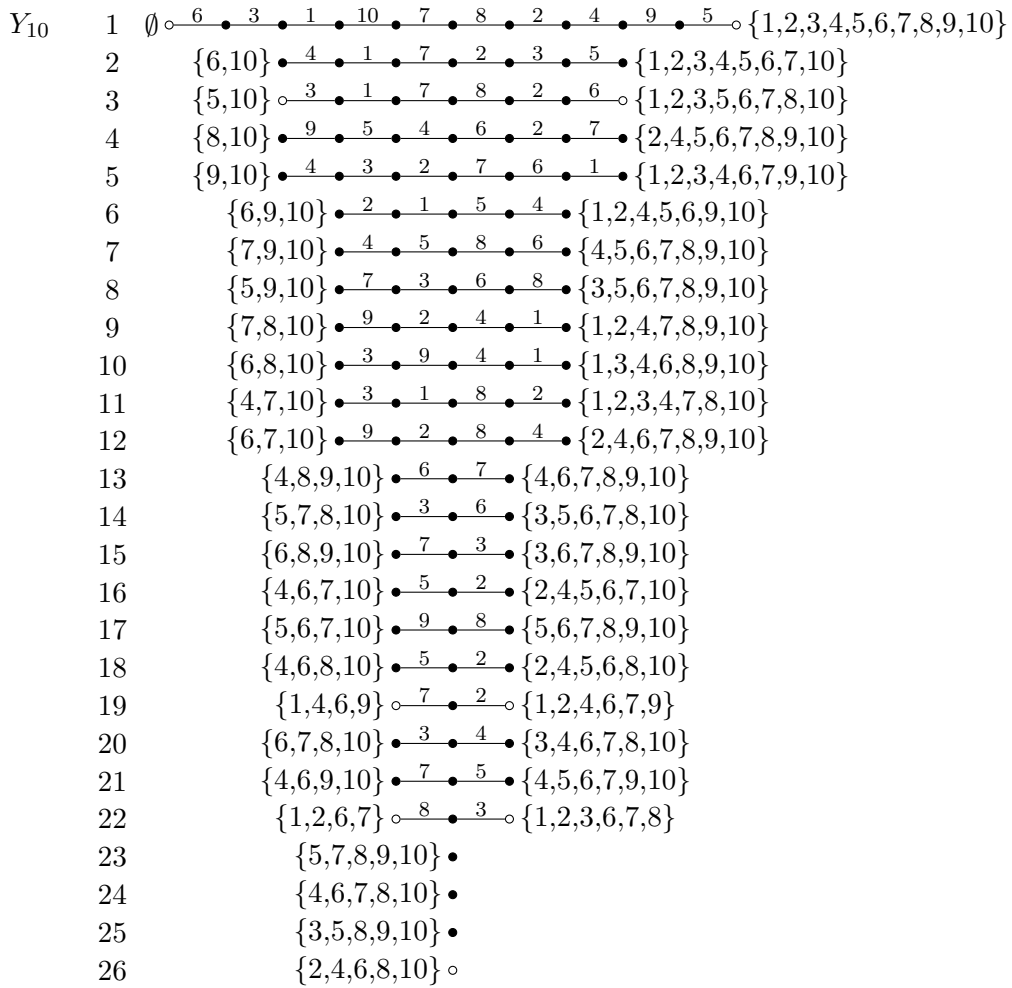

Figure 9: Two SCDs V_{11} and W_{11} in the necklace poset N_{11} that together with their complements $\overline{V_{11}}$ and $\overline{W_{11}}$ can be unrolled to four good almost orthogonal SCDs in Q_{11} .



(figure continues on next page)



(figure continues on next page)

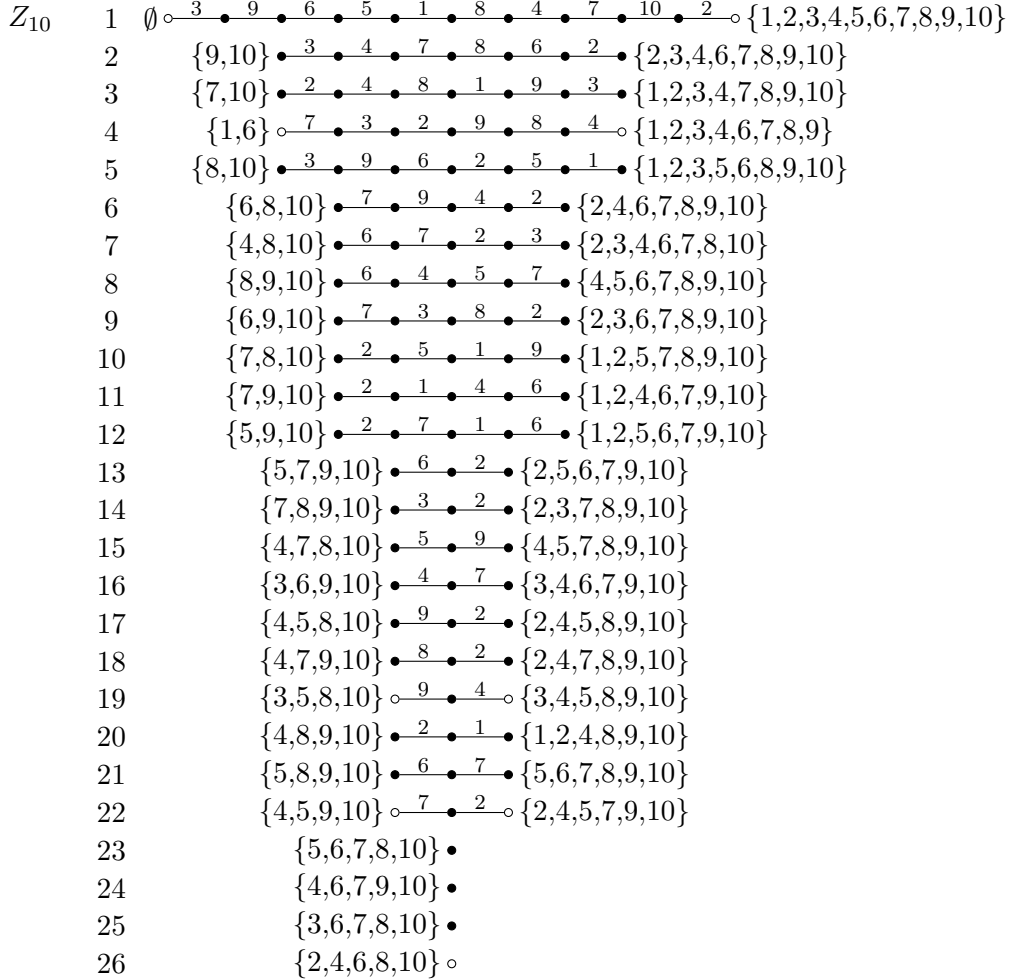
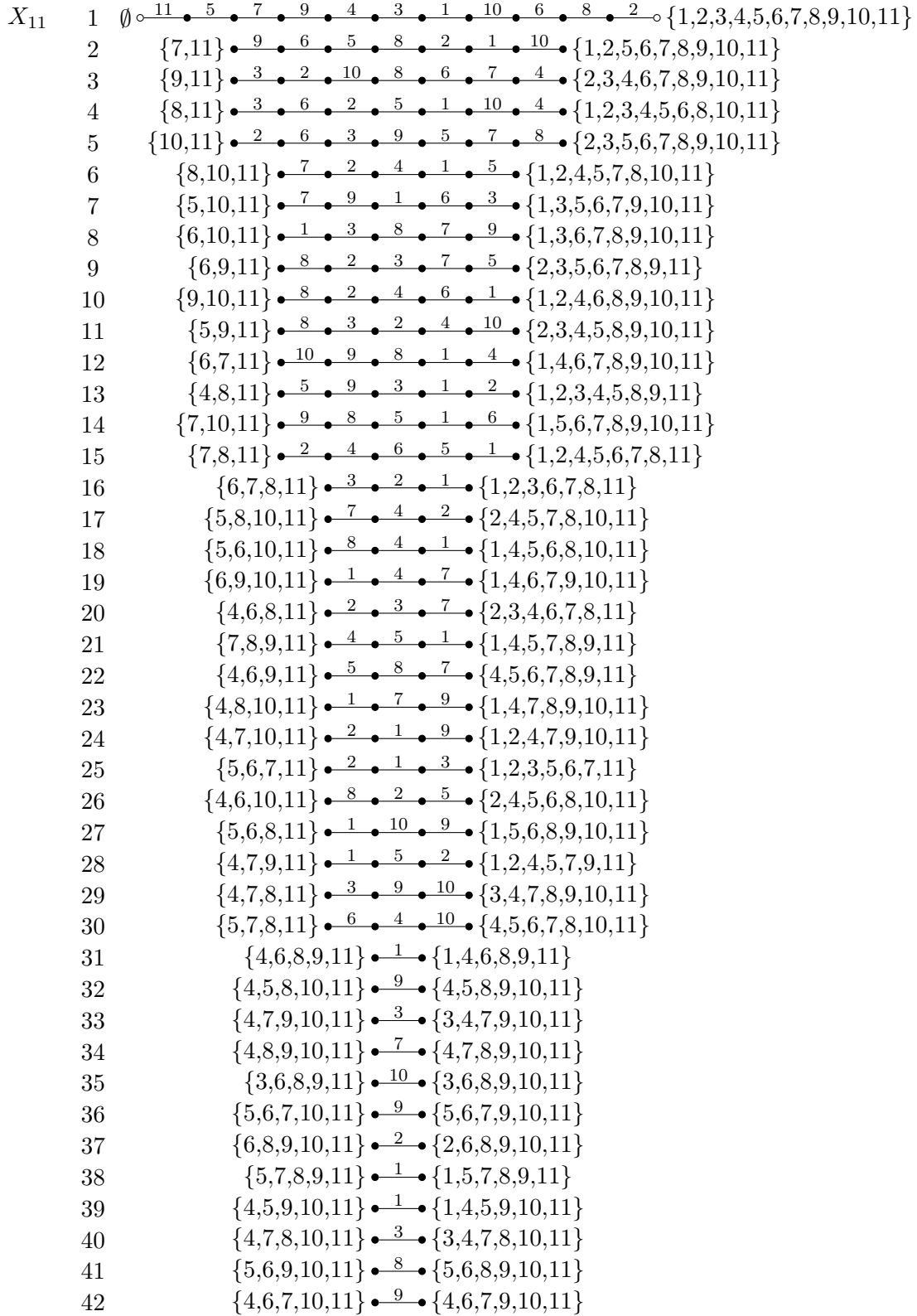
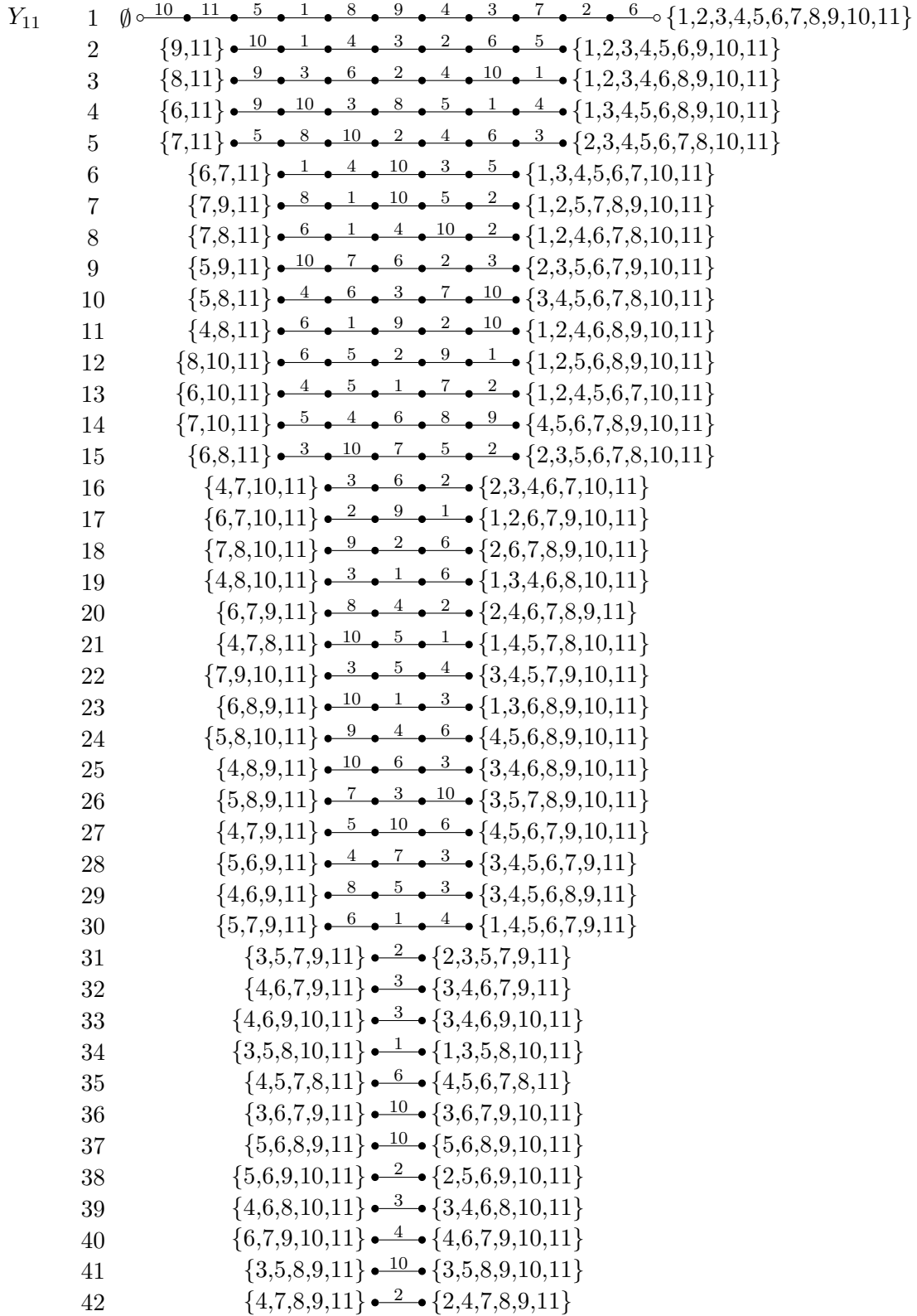

Figure 10: Three SCDs X_{10} , Y_{10} , and Z_{10} in the necklace poset N_{10} that together with the complements $\overline{X_{10}}$ and $\overline{Y_{10}}$ can be unrolled to five edge-disjoint SCDs in Q_{10} .



(figure continues on next page)



(figure continues on next page)

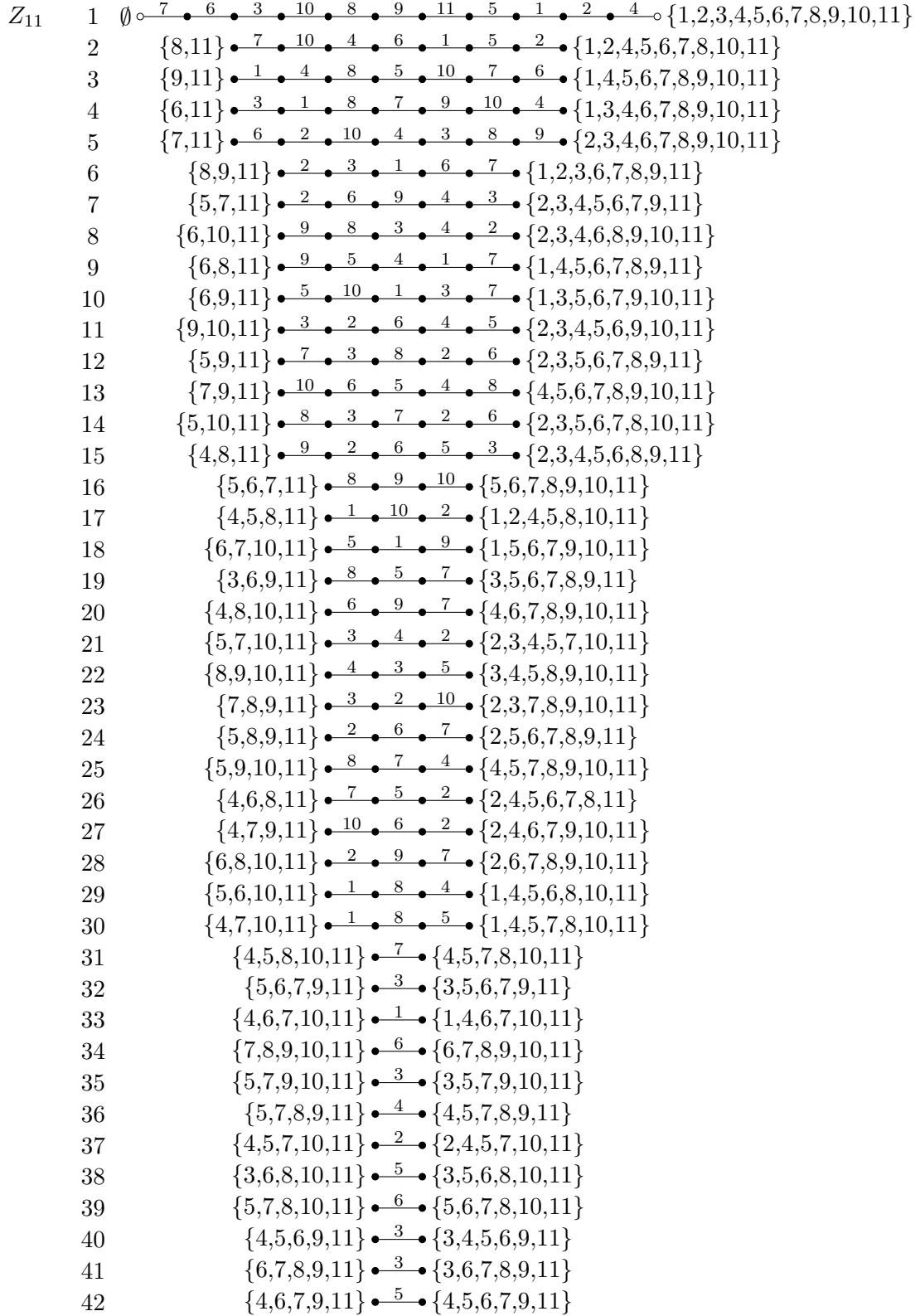

Figure 11: Three SCDs X_{11} , Y_{11} , and Z_{11} in the necklace poset N_{11} that together with their complements $\overline{X_{11}}$, $\overline{Y_{11}}$, and $\overline{Z_{11}}$ can be unrolled to six edge-disjoint SCDs in Q_{11} .

Acknowledgements

We thank Kaja Wille for several inspiring discussions about symmetric chain decompositions. We also thank the anonymous referee of this paper whose suggestions improved the presentation in several places. Manfred Scheucher was supported by DFG Grant FE 340/12-1.

References

- [Aig73] M. Aigner. Lexicographic matching in Boolean algebras. *J. Combin. Theory Ser. B*, 14:187–194, 1973.
- [ALS13] G. Audemard, J.-M. Lagniez, and L. Simon. Improving Glucose for incremental SAT solving with assumptions: Application to MUS extraction. In *Theory and Applications of Satisfiability Testing – SAT 2013*, volume 7962 of *LNCS*, pages 309–317. Springer, 2013.
- [BV17] M. Balko and P. Valtr. A SAT attack on the Erdős-Szekeres conjecture. *European J. Combin.*, 66:13–23, 2017.
- [dBvETK51] N. G. de Bruijn, C. van Ebbenhorst Tengbergen, and D. Kruyswijk. On the set of divisors of a number. *Nieuw Arch. Wiskunde (2)*, 23:191–193, 1951.
- [Dha12] V. Dhand. Symmetric chain decomposition of necklace posets. *Electron. J. Combin.*, 19(1):Paper #26, 14 pp., 2012.
- [Dil50] R. P. Dilworth. A decomposition theorem for partially ordered sets. *Ann. of Math. (2)*, 51:161–166, 1950.
- [DJMS19] K. Däubel, S. Jäger, T. Mütze, and M. Scheucher. On orthogonal symmetric chain decompositions. arXiv:1810.09847, preprint of the current paper with supplementary electronic files, 2019.
- [DLMT04] M. R. Dransfield, L. Liu, V. W. Marek, and M. Truszczyński. Satisfiability and computing van der Waerden numbers. *Electron. J. Combin.*, 11(1):Research Paper 41, 15, 2004.
- [DMST12] D. Duffus, J. McKibben-Sanders, and K. Thayer. Some quotients of chain products are symmetric chain orders. *Electron. J. Combin.*, 19:Paper #P46, 11 pp., 2012.
- [DST18] S. David, H. Spink, and M. Tiba. Symmetric chain decompositions of products of posets with long chains. *Electron. J. Combin.*, 25(1):Paper #P1.69, 12 pp., 2018.
- [DT15] D. Duffus and K. Thayer. Symmetric chain decompositions of quotients by wreath products. *Electron. J. Combin.*, 22(2):Paper #P2.35, 15 pp., 2015.
- [ES03] N. Eén and N. Sörensson. An extensible SAT-solver. In *Theory and Applications of Satisfiability Testing – SAT 2003*, volume 2919 of *LNCS*, pages 502–518. Springer, 2003.
- [Fuj12] H. Fujita. A new lower bound for the Ramsey number $r(4, 8)$. arXiv:1212.1328, 2012.
- [Für85] Z. Füredi. Problem session. In *Kombinatorik geordneter Mengen*, Oberwolfach, BRD, 1985.

- [GJM⁺18] P. Gregor, S. Jäger, T. Mütze, J. Sawada, and K. Wille. Gray codes and symmetric chains. In *45th International Colloquium on Automata, Languages, and Programming (ICALP 2018)*, volume 107 of *LIPICs*, pages 66:1–66:14, 2018.
- [GK76] C. Greene and D. J. Kleitman. Strong versions of Sperner’s theorem. *J. Combin. Theory Ser. A*, 20(1):80–88, 1976.
- [GKS04] J. Griggs, C. E. Killian, and C. D. Savage. Venn diagrams and symmetric chain decompositions in the Boolean lattice. *Electron. J. Combin.*, 11(1):Paper #R2, 30 pp., 2004.
- [GLT19] V. Gruslys, I. Leader, and I. Tomon. Partitioning the Boolean lattice into copies of a poset. *J. Combin. Theory Ser. A*, 161:81–98, 2019.
- [GMN18] P. Gregor, T. Mütze, and J. Nummenpalo. A short proof of the middle levels theorem. *Discrete Anal.*, pages Paper No. 8, 12, 2018.
- [Gri77] J. R. Griggs. Sufficient conditions for a symmetric chain order. *SIAM J. Appl. Math.*, 32(4):807–809, 1977.
- [Gri88] J. R. Griggs. Problems on chain partitions. In *Proceedings of the First Japan Conference on Graph Theory and Applications (Hakone, 1986)*, volume 72, pages 157–162, 1988.
- [HHvLvM07] P. R. Herwig, M. J. H. Heule, P. M. van Lambalgen, and H. van Maaren. A new method to construct lower bounds for van der Waerden numbers. *Electron. J. Combin.*, 14(1):Research Paper 6, 18, 2007.
- [HS13] P. Hersh and A. Schilling. Symmetric chain decomposition for cyclic quotients of Boolean algebras and relation to cyclic crystals. *Int. Math. Res. Not. IMRN*, (2):463–473, 2013.
- [Jor10] K. K. Jordan. The necklace poset is a symmetric chain order. *J. Combin. Theory Ser. A*, 117(6):625–641, 2010.
- [KL14] B. Konev and A. Lisitsa. A SAT attack on the Erdős discrepancy conjecture. In *Theory and Applications of Satisfiability Testing – SAT 2014*, volume 8561 of *LNCS*, pages 219–226. Springer, Cham, 2014.
- [Kle65] D. J. Kleitman. On a lemma of Littlewood and Offord on the distribution of certain sums. *Math. Z.*, 90:251–259, 1965.
- [Kle70] D. J. Kleitman. On a lemma of Littlewood and Offord on the distributions of linear combinations of vectors. *Advances in Math.*, 5:155–157, 1970.
- [KP08] M. Kouril and J. L. Paul. The van der Waerden number $W(2, 6)$ is 1132. *Experiment. Math.*, 17(1):53–61, 2008.
- [Lew72] M. Lewin. Choice mappings of certain classes of finite sets. *Math. Z.*, 124:23–36, 1972.
- [LO38] J. E. Littlewood and A. C. Offord. On the number of real roots of a random algebraic equation. *J. London Math. Soc.*, 13(4):288–295, 1938.
- [Müt16] T. Mütze. Proof of the middle levels conjecture. *Proc. Lond. Math. Soc. (3)*, 112(4):677–713, 2016.
- [Pik99] O. Pikhurko. On edge decompositions of posets. *Order*, 16(3):231–244, 1999.

- [RSW06] F. Ruskey, C. D. Savage, and S. Wagon. The search for simple symmetric Venn diagrams. *Notices Amer. Math. Soc.*, 53(11):1304–1312, 2006.
- [Sch18] M. Scheucher. On disjoint holes in point sets. arXiv:1807.10848, 2018.
- [SK79] J. Shearer and D. J. Kleitman. Probabilities of independent choices being ordered. *Stud. Appl. Math.*, 60(3):271–276, 1979.
- [Spe28] E. Sperner. Ein Satz über Untermengen einer endlichen Menge. *Math. Z.*, 27(1):544–548, 1928.
- [Spi17] H. Spink. Orthogonal symmetric chain decompositions of hypercubes. To appear in *SIAM J. Discrete Math.*, arXiv:1706.08545, 2017.
- [ST14] N. Streib and W. T. Trotter. Hamiltonian cycles and symmetric chains in Boolean lattices. *Graphs Combin.*, 30(6):1565–1586, 2014.
- [Tom15] I. Tomon. On a conjecture of Füredi. *European J. Combin.*, 49:1–12, 2015.
- [Wil18] K. Wille. Zerlegung des Hyperwürfels in symmetrische Ketten. Bachelor’s thesis, TU Berlin, 2018. In German.
- [WW77] D. E. White and S. G. Williamson. Recursive matching algorithms and linear orders on the subset lattice. *J. Combin. Theory Ser. A*, 23(2):117–127, 1977.
- [www19] 2019. Personal website of T. Mütze. <http://tmuetze.de/papers/oscd.zip>.
- [ZKC08] I. Zinovik, D. Kroening, and Y. Chebiryak. Computing binary combinatorial Gray codes via exhaustive search with SAT solvers. *IEEE Trans. Inform. Theory*, 54(4):1819–1823, 2008.
- [ZKS16] O. Zaikin, S. Kochemazov, and A. A. Semenov. SAT-based search for systems of diagonal latin squares in volunteer computing project SAT@home. In *39th International Convention on Information and Communication Technology, Electronics and Microelectronics (MIPRO 2016)*, pages 277–281, 2016.