

KNOT FLOER HOMOLOGY AND THE UNKNOTTING NUMBER

AKRAM ALISHAHI AND EAMAN EFTEKHARY

ABSTRACT. Given a knot $K \subset S^3$, let $u^-(K)$ (respectively, $u^+(K)$) denote the minimum number of negative (respectively, positive) crossing changes among all unknotting sequences for K . We use knot Floer homology to construct the invariants $\iota^-(K), \iota^+(K)$ and $\mathfrak{l}(K)$, which give lower bounds on $u^-(K), u^+(K)$ and the unknotting number $u(K)$, respectively. The invariant $\mathfrak{l}(K)$ only vanishes for the unknot, and satisfies $\mathfrak{l}(K) \geq \nu^-(K)$, while the difference $\mathfrak{l}(K) - \nu^-(K)$ can be arbitrarily large. We also present several applications towards bounding the unknotting number, the alteration number and the Gordian distance.

1. INTRODUCTION

Given a knot $K \subset S^3$, by an *unknotting sequence* for K we mean a sequence of crossing changes for K which results in the unknot. The minimum length of an unknotting sequence for K is called the *unknotting number* of K and is denoted by $u(K)$. Let $u^-(K)$ denote the minimum number of negative crossing changes (i.e. changes of a positive crossing to a negative crossing) among all unknotting sequences for K and $u^+(K)$ denote the minimum number of positive crossing changes among all such sequences. It is then clear that $u(K) \geq u^+(K) + u^-(K)$, while the equality is not necessarily satisfied. The unknotting number is one of the simplest, yet most mysterious and intractable invariants of knots in S^3 . The answer to several simple questions about the unknotting number is still not known. In particular, the the following question is widely open.

Question 1.1. *If K and L are knots in S^3 , is it true that $u(K\#L) = u(K) + u(L)$? How about the (weaker) inequality $u(K\#L) \geq \max\{u(K), u(L)\}$?*

Scharlemann proved that composite knots have unknotting number at least 2 [Sch85]. However, no matter how large $u(K)$ and $u(L)$ are, it is not known in general whether $u(K\#L) \geq 3$ [Lac].

Another example is Milnor's conjecture on the unknotting number of the torus knot $T_{p,q}$, which remained open for a long time, until a proof was given by Kronheimer and Mrowka using gauge theory [KM93]. Ozsváth and Szabó reproved it using their invariant $\tau(K)$ [OS03] and Rasmussen gave a purely combinatorial proof by introducing his invariant $s(K)$ [Ras10]. Both $|\tau(K)|$ and $|s(K)|/2$, as well as classical lower bounds for the unknotting number coming from Levine-Tristram signatures [Lev69, Tri69], are in fact lower bounds for the 4-ball genus $g_4(K)$. Since $g_4(K) \leq u(K)$, they also give lower bounds for the unknotting number. Nevertheless, lower bounds for $u(K)$ constructed by bounding the 4-ball genus fail to give effective data for many classes of knots. In particular, if $-K$ denotes the mirror image of the knot K , the knot $L = K\# -K$ is always slice and $\tau(L) = s(L) = 0$. It is thus interesting to construct lower bounds for $u(K)$, which do not come from bounds on $g_4(K)$. In this paper, we use knot Floer homology to construct the invariants $\iota^-(K), \iota^+(K) = \iota^-(-K)$ and $\mathfrak{l}(K)$ associated with a knot $K \subset S^3$ and prove the following theorem.

Theorem 1.1. *For every knot $K \subset S^3$ we have*

- $\iota^+(K) \leq u^+(K)$, $\iota^-(K) \leq u^-(K)$ and $\mathfrak{l}(K) \leq u(K)$.
- $\iota^-(K) \geq \nu^-(K) \geq \tau(K)$ and $\iota^+(K) \geq \nu^-(-K) \geq -\tau(K)$. Therefore, for every $0 \leq t \leq 1$ we have $t\iota^+(K) \geq \Upsilon_K(t) \geq -t\iota^-(K)$.
- $\mathfrak{l}(K) \geq \widehat{\mathfrak{t}}(K)$ where $\widehat{\mathfrak{t}}(K)$ is the maximum order of U -torsion in $\text{HFK}^-(K)$.

Unlike most other lower bounds for the unknotting number, the torsion invariant $\widehat{\mathfrak{t}}$ resists the connected sum operation.

AA was supported by NSF Grants DMS-1505798 and DMS-1811210.

Corollary 1.2. *If K and K' are knots in S^3 then*

$$u(K\#K') \geq \widehat{\mathfrak{t}}(K\#K') \geq \max\{\widehat{\mathfrak{t}}(K), \widehat{\mathfrak{t}}(K')\}.$$

In particular, for the torus knot $T_{p,q}$ with $0 < p < q$, $\widehat{\mathfrak{t}}(T_{p,q}) = p - 1$ and for every knot $K \subset S^3$

$$u(K\#T_{p,q}) \geq p - 1.$$

Therefore, for every coprime $0 < p < q$, $\mathfrak{l}(-T_{p,q}\#T_{p,q}) \geq p - 1$, while the lower bounds ν^- , $|\tau|$ and $|s|/2$ vanish, because $-T_{p,q}\#T_{p,q}$ is slice.

Theorem 1.1 naturally reproves the following corollary.

Corollary 1.3. *For every knot $K \subset S^3$, $\nu^-(K)$ is a lower bounds for $u^-(K)$, while $\nu^-(-K)$ is a lower bound for $u^+(K)$. In particular, $u^-(T_{p,q}) = (p - 1)(q - 1)/2$.*

Associated with a knot $K \subset S^3$, one can construct a Heegaard Floer chain complex $\text{CF}(K)$, which is freely generated over $\mathbb{A} = \mathbb{F}[u, w]$ by the intersection points associated with a Heegaard diagram for K . $\text{CF}(K)$ is equipped with differential d , which is an \mathbb{A} -homomorphism defined by counting holomorphic disks [AE15]. Let $\mathbb{H}(K)$ denote the homology of $(\text{CF}(K), d)$, which is again a module over \mathbb{A} . Let $\mathbb{T}(K)$ denote the torsion submodule of $\mathbb{H}(K)$, i.e. $\mathbb{T}(K)$ consists of $x \in \mathbb{H}(K)$ such that there exists a non-zero $a \in \mathbb{A}$ with $a \cdot x = 0$. Then, $\mathbb{H}(K)$ sits in a short exact sequence

$$0 \longrightarrow \mathbb{T}(K) \longrightarrow \mathbb{H}(K) \longrightarrow \mathbb{A}(K) \longrightarrow 0,$$

where the torsion free part $\mathbb{A}(K)$ of the homology is isomorphic to an ideal in \mathbb{A} . Specifically, for every knot K , there is an *ideal sequence* $\mathfrak{v}(K) = (i_0 = 0 < i_1 < \dots < i_n = \nu^-(K))$ of some length $n = n(K)$ and a canonical identification

$$\mathbb{A}(K) = \langle u^{i_k} w^{i_n - k} \mid k = 0, 1, \dots, n \rangle_{\mathbb{A}} \leq \mathbb{A}.$$

We define $\mathfrak{t}(K)$ as the smallest integer m such that w^m acts trivially on $\mathbb{T}(K)$ (i.e. maps $\mathbb{T}(K)$ to zero). For the unknot U , we have $\mathbb{T}(U) = 0$ and $\mathbb{A}(U) = \mathbb{A}$.

If K' is obtained from K by a sequence of m negative crossing changes and n positive crossing changes, we use the cobordism maps constructed in [AE] to show that $w^n \mathbb{A}(K) \subset \mathbb{A}(K')$ and $w^m \mathbb{A}(K') \subset \mathbb{A}(K)$, while $w^{m+n} \mathbb{T}(K)$ may be embedded in $\mathbb{T}(K')$. This observation implies, in particular, that $\nu^-(K)$ is a lower bound for $u^-(K)$ and that $\mathfrak{t}(K)$ is lower bound for $u(K)$.

The above construction also gives lower bounds on the *Gordian distance* $u(K, K')$ from a knot K to another knot K' , i.e. the minimum number of crossing changes required to get from K to K' . In particular, we give the following three lower bounds on the *alteration number* $\text{alt}(K)$, defined as the least Gordian distance of an alternating knot from K .

Proposition 1.4. *The alteration number $\text{alt}(K)$ of a knot $K \subset S^3$ satisfies the inequalities*

$$\text{alt}(K) \geq \nu^-(K) - \mathfrak{a}(K), \quad \text{alt}(K) \geq \widehat{\mathfrak{t}}(K) - 1 \quad \text{and} \quad \text{alt}(K) \geq \min\{\mathfrak{t}(K) - 1, |\nu^-(K)|\},$$

where $\mathfrak{a}(K)$ is the minimum degree of a monomial in $\mathbb{A}(K)$. In particular, it follows that

$$\text{alt}(T_{p,pn+1}) \geq n \left\lfloor \frac{(p-1)^2}{4} \right\rfloor.$$

A similar strategy is used by the first author in [Ali] to construct lower bounds for the unknotting number from Khovanov homology. The resulting invariants are used in [AD] to prove the *knight move conjecture* for knots with unknotting number at most 2.

In Section 2 we study the cobordism maps induced on knot chain complexes associated with a crossing change. These cobordism maps are used in Section 3 to construct lower bounds on the Gordian distance of knots, while simpler obstructions to the unknotting are extracted from these lower bounds in Section 4. We discuss several examples and applications in Section 5.

Acknowledgements. The authors would like to thank Jennifer Hom, Robert Lipshitz and Iman Setayesh for helpful discussions and suggestions.

2. CHANGING THE CROSSINGS IN KNOT DIAGRAMS

By a *crossing change* for an oriented link $L \subset Y$ we mean replacing a ball in Y in which L looks like a positive crossing to the ball in which L looks like a negative crossing (a negative crossing change), or the reverse of the above operation (a positive crossing change). Figure 1 illustrates how a band surgery on L can be used to do any of the following two changes (or the reverse of it):

- A negative crossing change and adding a positively oriented meridian for L as a new link component.
- A positive crossing change and adding a negatively oriented meridian for L as a new link component.

Let us assume that K' is obtained from K by a negative crossing change and that L is obtained from K' by adding a positively oriented meridian. As illustrated in Figure 1, one may then place a pair of markings p_1, p_2 on K , and distinguish a band \mathbb{I} with endpoints on $K \setminus \{p_1, p_2\}$, such that the band surgery on \mathbb{I} gives L , while p_1 lands on K' and p_2 lands on the positively oriented meridian.

Associated with the pointed link (K, p_1, p_2) , we may construct a tangle (equivalently, a sutured manifold) as follows. Fix an orientation on K and consider two disjoint small arcs on K which contains p_1 and p_2 , respectively. Remove a small ball around each one of the four ends of these arcs to obtain a 3-manifold M with 4 sphere boundary components. Using the orientation on K we may orient these spheres so that two of them form $\partial^+ M$ and the other two form $\partial^- M$, see the lower part of Figure 1. Let T_1 and T_2 denote the remaining part of the two arcs around p_1 and p_2 , respectively, which are now strands in M connecting $\partial^+ M$ to $\partial^- M$. The complement of the two arcs in K gives two other strands T_3 and T_4 which connect $\partial^+ M$ to $\partial^- M$. The 3-manifold M and the strands T_1, T_2, T_3 and T_4 then form a tangle associated with (K, p_1, p_2) (see [AE]). Correspondingly, we also obtain a sutured manifold, which is constructed by removing a solid cylinder around each one of the strands and considering the boundary of these 4 solid cylinders as the set of sutures on the resulting 3-manifold. The construction of authors in [AE15], as well as the special case considered in [AE15, Subsection 8.2], may be used to associate a chain complex $\text{CF}(K, p_1, p_2)$ with this tangle (or sutured manifold), which is a module over $\mathbb{A}' = \mathbb{F}[u, v, w]$. The variables u and v are associated with the strands T_1 and T_2 (equivalently, with p_1 and p_2), while the variable w is associated with T_3 and T_4 (equivalently, with $K \setminus \{p_1, p_2\}$). Similarly, we can associate a chain complex $\text{CF}(L, p_1, p_2)$ with the pointed link (L, p_1, p_2) , which is again a module over \mathbb{A}' . The generators of the two complexes all correspond to the unique Spin^c structure \mathfrak{s}_0 on S^3 , which will be dropped from the notation.

Associated with the framed arc \mathbb{I} , the construction of [AE] gives the \mathbb{A}' -cobordism maps

$$\mathfrak{g}^+ : \text{CF}(K, p_1, p_2) \rightarrow \text{CF}(L, p_1, p_2) \quad \text{and} \quad \mathfrak{g}^- : \text{CF}(L, p_1, p_2) \rightarrow \text{CF}(K, p_1, p_2).$$

Lemma 2.1. *With the above notation fixed, the maps*

$$\mathfrak{g}^+ \circ \mathfrak{g}^- : \text{CF}(L, p_1, p_2) \rightarrow \text{CF}(L, p_1, p_2) \quad \text{and} \quad \mathfrak{g}^- \circ \mathfrak{g}^+ : \text{CF}(K, p_1, p_2) \rightarrow \text{CF}(K, p_1, p_2)$$

are both multiplication by w , up to chain homotopy.

Proof. For defining \mathfrak{g}^+ we may use a triple

$$(\Sigma, \alpha, \beta, \gamma, \mathbf{z} = \{z_1, z_2, z_3, z_4\})$$

subordinate to the framed arc \mathbb{I} , where z_i corresponds to the strand T_i . The corresponding \mathbb{A}' -coloring maps z_1 to u and z_2 to v , while z_3 and z_4 are mapped to w . If δ is obtained by a small Hamiltonian isotopy from β which do not cross \mathbf{z} , then $(\Sigma, \alpha, \gamma, \delta, \mathbf{z})$ is subordinate to $\bar{\mathbb{I}}$, the reverse band surgery. Associated with the Heegaard quadruple $H = (\Sigma, \alpha, \beta, \gamma, \delta, \mathbf{z})$ we obtain:

- the top generators $\Theta_{\beta\gamma}, \Theta_{\gamma\delta}$ and $\Theta_{\beta\delta}$ in $\mathbb{T}_\beta \cap \mathbb{T}_\gamma, \mathbb{T}_\gamma \cap \mathbb{T}_\delta$ and $\mathbb{T}_\beta \cap \mathbb{T}_\delta$, respectively,
- the triangle maps $f_{\alpha\beta\gamma}, f_{\alpha\gamma\delta}, f_{\alpha\beta\delta}$ and $f_{\beta\gamma\delta}$, which are associated with the triples (α, β, γ) , (α, γ, δ) , (α, β, δ) and (β, γ, δ) , respectively, and the induced maps $\mathfrak{g}^+ = f_{\alpha\beta\gamma}(- \otimes \Theta_{\beta\gamma})$ and $\mathfrak{g}^- = f_{\alpha\gamma\delta}(- \otimes \Theta_{\gamma\delta})$,

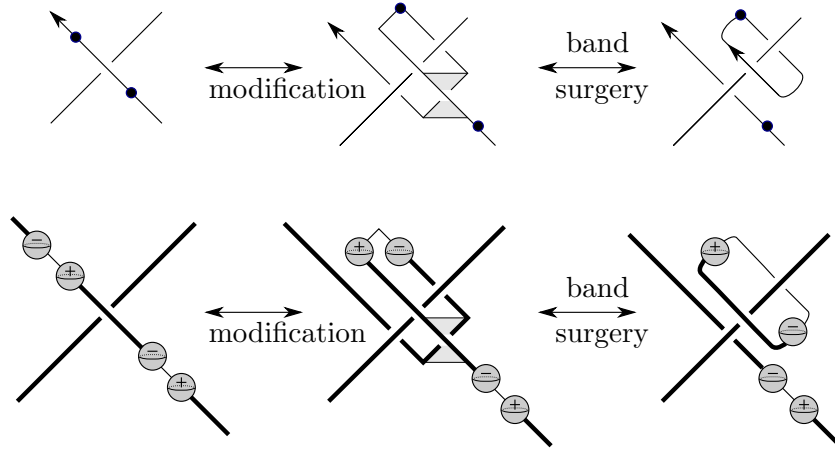

FIGURE 1. We may change a crossing in the expense of adding a meridian. The meridian can be positively or negatively oriented depending on whether the initial crossing is negative or positive, respectively.

- and the holomorphic square map \mathfrak{S} which satisfies

$$d \circ \mathfrak{S} + \mathfrak{S} \circ d = \mathfrak{g}^+ \circ \mathfrak{g}^- + \mathfrak{f}_{\alpha\beta\delta}(- \otimes \mathfrak{f}_{\beta\gamma\delta}(\Theta_{\beta\gamma} \otimes \Theta_{\gamma\delta})).$$

The position of the curves in $\beta \cup \gamma \cup \delta$, which is basically illustrated in Figure 2, implies that

$$\mathfrak{f}_{\beta\gamma\delta}(\Theta_{\beta\gamma} \otimes \Theta_{\gamma\delta}) = w\Theta_{\beta\delta}.$$

Since $\mathfrak{f}_{\alpha\beta\delta}(- \otimes \Theta_{\beta\delta})$ gives a map chain homotopic to the identity on $\text{CF}(L, p_1, p_2)$, the above observation completes the proof for the composition $\mathfrak{g}^+ \circ \mathfrak{g}^-$. A similar argument implies that $\mathfrak{g}^- \circ \mathfrak{g}^+$ is chain homotopic to multiplication by w . \square

Removing p_2 from K , we obtain a knot with a single marked point on it. Correspondingly, we find a tangle with two strands and the standard knot chain complex $\text{CF}(K)$ for K , which is a module over $\mathbb{A} = \mathbb{F}[u, w]$. Similarly, there is a single marked point on K' , and associated with it we obtain the chain complex $\text{CF}(K')$, which is again an \mathbb{A} -module. There are chain homotopy equivalences

$$\begin{aligned} \text{CF}(K, p_1, p_2) &\simeq \left(\text{CF}(K) \otimes_{\mathbb{A}} \mathbb{A}' \xrightarrow{u+v} \text{CF}(K) \otimes_{\mathbb{A}} \mathbb{A}' \right) \quad \text{and} \\ \text{CF}(L, p_1, p_2) &\simeq \left((\text{CF}(K') \oplus \text{CF}(K')) \otimes_{\mathbb{A}} \mathbb{A}' \xrightarrow{\begin{bmatrix} 0 & w \\ u+v & u \end{bmatrix}} (\text{CF}(K') \oplus \text{CF}(K')) \otimes_{\mathbb{A}} \mathbb{A}' \right), \end{aligned}$$

where the latter is deduced from the identification $L = K' \# (\text{Hopf link})$, and the chain complex $(C \xrightarrow{f} C')$ is defined as the mapping cylinder of the chain map $f : C \rightarrow C'$ between two chain complexes. Corresponding to the above chain homotopy equivalences, we may present \mathfrak{g}^+ and \mathfrak{g}^- as 4×2 and 2×4 matrices $(\mathfrak{g}_{ij}^+)_{ij}$ and $(\mathfrak{g}_{ji}^-)_{ji}$, where

$$\mathfrak{g}_{ij}^+ : \text{CF}(K) \otimes_{\mathbb{A}} \mathbb{A}' \rightarrow \text{CF}(K') \otimes_{\mathbb{A}} \mathbb{A}' \quad \text{and} \quad \mathfrak{g}_{ji}^- : \text{CF}(K') \otimes_{\mathbb{A}} \mathbb{A}' \rightarrow \text{CF}(K) \otimes_{\mathbb{A}} \mathbb{A}'.$$

Let us denote $u + v$ by σ and regard \mathbb{A}' as $\mathbb{A}[\sigma]$. For each $1 \leq i, j \leq 2$, we decompose

$$\mathfrak{g}_{ij}^+ = \mathfrak{g}_{ij,0}^+ + \sigma \mathfrak{h}_{ij}^+ \quad \text{and} \quad \mathfrak{g}_{ji}^- = \mathfrak{g}_{ji,0}^- + \sigma \mathfrak{h}_{ji}^-,$$

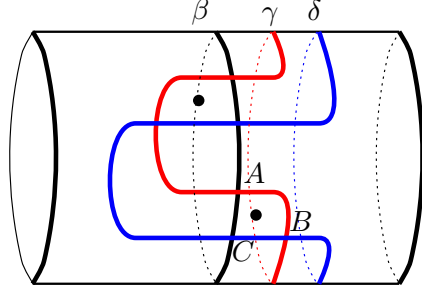

FIGURE 2. If δ is obtained from β by a Hamiltonian isotopy supported away from the marked points, the domain of the distinguished triangle class in $(\Sigma, \beta, \gamma, \delta, \mathbf{z})$ connecting $\Theta_{\beta\gamma}, \Theta_{\gamma\delta}$ and $\Theta_{\beta\delta}$ will contain one of the marked points corresponding to the strands connected by \mathbb{I} . The intersection of the domain of the triangle with the surface is the small triangle connecting A, B and C .

where the maps $\mathfrak{g}_{ij,0}^\pm$ do not use the variable σ . We will find chain homotopies such that

$$(1) \quad \mathfrak{g}^+ \simeq \begin{bmatrix} \mathfrak{g}_{11,0}^+ & 0 \\ \mathfrak{g}_{21,0}^+ & 0 \\ \mathfrak{g}_{31,0}^+ & 0 \\ \mathfrak{g}_{41,0}^+ & \mathfrak{g}_{11,0}^+ \end{bmatrix} \quad \text{and} \quad \mathfrak{g}^- \simeq \begin{bmatrix} \mathfrak{g}_{24,0}^- & 0 & 0 & 0 \\ \mathfrak{g}_{21,0}^- & \mathfrak{g}_{22,0}^- & \mathfrak{g}_{23,0}^- & \mathfrak{g}_{24,0}^- \end{bmatrix}.$$

First, we deduce from \mathfrak{g}^+ and \mathfrak{g}^- being chain maps that

$$\begin{aligned} \sigma \cdot \mathfrak{g}_{12}^+ &= \mathfrak{g}_{11}^+ \circ d + d \circ \mathfrak{g}_{11}^+ & \sigma \cdot \mathfrak{g}_{11}^- &= \sigma \cdot \mathfrak{g}_{24}^- + \mathfrak{g}_{21}^- \circ d + d \circ \mathfrak{g}_{21}^- \\ \sigma \cdot \mathfrak{g}_{22}^+ &= \mathfrak{g}_{21}^+ \circ d + d \circ \mathfrak{g}_{21}^+ & \sigma \cdot \mathfrak{g}_{12}^- &= \mathfrak{w} \cdot \mathfrak{g}_{23}^- + \mathfrak{u} \cdot \mathfrak{g}_{24}^- + \mathfrak{g}_{22}^- \circ d + d \circ \mathfrak{g}_{22}^- \\ \sigma \cdot \mathfrak{g}_{32}^+ &= \mathfrak{w} \cdot \mathfrak{g}_{21}^+ + \mathfrak{g}_{31}^+ \circ d + d \circ \mathfrak{g}_{31}^+ & \sigma \cdot \mathfrak{g}_{13}^- &= \mathfrak{g}_{23}^- \circ d + d \circ \mathfrak{g}_{23}^- \\ \sigma \cdot \mathfrak{g}_{42}^+ &= \sigma \cdot \mathfrak{g}_{11}^+ + \mathfrak{u} \cdot \mathfrak{g}_{21}^+ + \mathfrak{g}_{41}^+ \circ d + d \circ \mathfrak{g}_{41}^+ & \sigma \cdot \mathfrak{g}_{14}^- &= \mathfrak{g}_{24}^- \circ d + d \circ \mathfrak{g}_{24}^- \end{aligned}$$

The differentials d of the complexes do not use the variable σ , so the above equations imply

$$\begin{aligned} \mathfrak{g}_{12}^+ &= \mathfrak{h}_{11}^+ \circ d + d \circ \mathfrak{h}_{11}^+ & \mathfrak{g}_{11}^- &= \mathfrak{g}_{24}^- + \mathfrak{h}_{21}^- \circ d + d \circ \mathfrak{h}_{21}^- \\ \mathfrak{g}_{22}^+ &= \mathfrak{h}_{21}^+ \circ d + d \circ \mathfrak{h}_{21}^+ & \mathfrak{g}_{12}^- &= \mathfrak{w} \cdot \mathfrak{h}_{23}^- + \mathfrak{u} \cdot \mathfrak{h}_{24}^- + \mathfrak{h}_{22}^- \circ d + d \circ \mathfrak{h}_{22}^- \\ \mathfrak{g}_{32}^+ &= \mathfrak{w} \cdot \mathfrak{h}_{21}^+ + \mathfrak{h}_{31}^+ \circ d + d \circ \mathfrak{h}_{31}^+ & \mathfrak{g}_{13}^- &= \mathfrak{h}_{23}^- \circ d + d \circ \mathfrak{h}_{23}^- \\ \mathfrak{g}_{42}^+ &= \mathfrak{g}_{11}^+ + \mathfrak{u} \cdot \mathfrak{h}_{21}^+ + \mathfrak{h}_{41}^+ \circ d + d \circ \mathfrak{h}_{41}^+ & \mathfrak{g}_{14}^- &= \mathfrak{h}_{24}^- \circ d + d \circ \mathfrak{h}_{24}^- \end{aligned}$$

Then, it is easy to check that

$$H^+ = \begin{bmatrix} 0 & \mathfrak{h}_{11}^+ \\ 0 & \mathfrak{h}_{21}^+ \\ 0 & \mathfrak{h}_{31}^+ \\ 0 & \mathfrak{h}_{41}^+ \end{bmatrix} \quad \text{and} \quad H^- = \begin{bmatrix} \mathfrak{h}_{21}^- & \mathfrak{h}_{22}^- & \mathfrak{h}_{23}^- & \mathfrak{h}_{24}^- \\ 0 & 0 & 0 & 0 \end{bmatrix}$$

are the chain homotopies for \mathfrak{g}^+ and \mathfrak{g}^- which result in Equation 1, respectively. Abusing the notation we keep denoting the new matrixes by $\mathfrak{g}^- = (\mathfrak{g}_{ij}^-)$ and $\mathfrak{g}^+ = (\mathfrak{g}_{ij}^+)$.

We now set $\sigma = 0$, or equivalently $\mathfrak{v} = \mathfrak{u}$. Then, \mathfrak{g}_{11}^+ and \mathfrak{g}_{11}^- induce chain maps

$$\mathfrak{g}_{11}^+ : \text{CF}(K) \rightarrow \text{CF}(K') \quad \text{and} \quad \mathfrak{g}_{11}^- : \text{CF}(K') \rightarrow \text{CF}(K),$$

and we define $\mathfrak{f}^+ = \mathfrak{g}_{11}^+$ and $\mathfrak{f}^- = \mathfrak{g}_{11}^-$. Note that $(\mathfrak{g}^+ \circ \mathfrak{g}^-)_{11} = \mathfrak{g}_{11}^+ \circ \mathfrak{g}_{11}^-$ and $(\mathfrak{g}^- \circ \mathfrak{g}^+)_{11} = \mathfrak{g}_{11}^- \circ \mathfrak{g}_{11}^+$. So, both $\mathfrak{f}^+ \circ \mathfrak{f}^-$ and $\mathfrak{f}^- \circ \mathfrak{f}^+$ are chain homotopic to multiplication by \mathfrak{w} .

If K' is obtained from K by a positive crossing change, a similar argument may be used to arrive at the same conclusion. The above discussion implies the following theorem.

Theorem 2.2. *If $K' \subset S^3$ is obtained from $K \subset S^3$ by a crossing change, there exist chain maps*

$$f^+ : CF(K) \rightarrow CF(K') \quad \text{and} \quad f^- : CF(K') \rightarrow CF(K)$$

such that $f^+ \circ f^-$ and $f^- \circ f^+$ are chain homotopic to multiplication by w .

Given a knot $K \subset S^3$, the knot Floer chain complex $CF(K)$ (which is generated over $\mathbb{A} = \mathbb{F}[u, w]$) is \mathbb{Z} -bigraded. It has a Maslov grading μ and an Alexander grading A , as defined in [OS04]. Multiplication by u and w changes these gradings by

$$\mu(u^a w^b \mathbf{x}) = \mu(\mathbf{x}) - 2a \quad \text{and} \quad A(u^a w^b \mathbf{x}) = A(\mathbf{x}) - a + b$$

Subsequently, we may write

$$CF(K) = \bigoplus_{d, s \in \mathbb{Z}} CF_d(K, s),$$

where d and s denote the Maslov and Alexander grading, respectively. For instance, for the unknot we obtain

$$CF(\text{Unknot}) = \mathbb{F}[u, w] = \bigoplus_{s \in \mathbb{Z}} \mathbb{A}_0(s), \quad \text{where } \mathbb{A}_0(s) = \langle u^a w^b \mid b - a = s \rangle.$$

Proposition 2.3. *Both f^+ and f^- are homogeneous maps. If K' is obtained from K by a negative crossing change then f^+ and f^- have bidegree $(\mu, A) = (0, 0)$ and $(0, 1)$, respectively. Similarly, if K' is obtained from K by a positive crossing change then f^+ and f^- have bidegree $(0, 1)$ and $(0, 0)$, respectively.*

Proof. Suppose K' is obtained from K by a negative crossing change. In the situation of Lemma 2.1, the chain maps g^+ and g^- are homogeneous, [AE, Lemma 7.8], and it follows from [Zem, Lemma 7.2] that g^+ and g^- are homogeneous of bidegree $(0, 1/2)$. Furthermore, considering the bigradings,

$$CF(K, p_1, p_2) \otimes_{\mathbb{A}'} \mathbb{A} = CF(K) \otimes_{\mathbb{A}} V$$

where V is a free \mathbb{A} -module with two generators in bidegrees $(0, 0)$ and $(-1, -1)$. In addition,

$$CF(L, p_1, p_2) \otimes \mathbb{A} = CF(K') \otimes_{\mathbb{A}} W,$$

where $W = CF(H, p_1, p_2)$ and H is the right-handed Hopf link. Specifically, it is a bigraded chain complex of free modules with the generators y_1, y_2, y_3, y_4 in gradings

$$\begin{aligned} (\mu(y_3), A(y_3)) &= \left(-\frac{3}{2}, -\frac{3}{2}\right), & (\mu(y_4), A(y_4)) &= \left(\frac{1}{2}, \frac{1}{2}\right) \\ \text{and } (\mu(y_1), A(y_1)) &= (\mu(y_2), A(y_2)) &= \left(-\frac{1}{2}, -\frac{1}{2}\right). \end{aligned}$$

and the differential d defined by $d(y_2) = wy_3 + uy_4$ and $d(y_1) = d(y_3) = d(y_4) = 0$. Therefore, f^+ preserves both Maslov and Alexander gradings, while f^- has bidegree $(0, 1)$. The proof for a positive crossing change is analogous. \square

Since the crossing change chain maps f^+ and f^- do not change the Maslov index, we will drop it from the notation in the rest of the paper. Moreover, by degree of a homogeneous chain map f , denoted by $\deg(f)$, we mean the Alexander grading degree of f .

3. THE DEPTH OF A KNOT AND BOUNDING THE UNKNOTTING NUMBER

Let K and K' be knots in S^3 and \mathbb{I} denote a sequence of crossing changes which modifies K to K' . We denote the length of \mathbb{I} by $|\mathbb{I}|$, and the number of positive (resp. negative) crossing changes in \mathbb{I} by $m^+(\mathbb{I})$ (resp. $m^-(\mathbb{I})$). For $\bullet \in \{+, -\}$, let $u^\bullet(K, K')$ denote the minimum of $m^\bullet(\mathbb{I})$ over all such sequences \mathbb{I} of crossing changes. Further, the *Gordian distance* $u(K, K')$ between K and K' is defined as the minimum number of crossing changes required for modifying K to K' . Therefore,

$$u(K, K') \geq u^-(K, K') + u^+(K, K').$$

Define $u^\bullet(K) = u^\bullet(K, U)$, where U denotes the unknot. Note that it is possible that $u^+(K)$ and/or $u^-(K)$ are realized in an unknotting sequence which does not have minimal length. The knot K' is called *Gordian adjacent* to K if there exists a minimal unknotting sequence for K containing K' . Equivalently, the Gordian distance $u(K, K')$ from K to K' is $u(K) - u(K')$. Based on Theorem 2.2 we make the following definition.

Definition 3.1. Given the knots $K, K' \subset S^3$, consider all pairs of homogeneous chain maps

$$f^+ : \text{CF}(K) \rightarrow \text{CF}(K') \quad \text{and} \quad f^- : \text{CF}(K') \rightarrow \text{CF}(K)$$

of degrees $m^+ = \deg(f^+)$ and $m^- = \deg(f^-)$ such that $f^- \circ f^+$ and $f^+ \circ f^-$ are chain homotopic to multiplication by w^m , where $m^- + m^+ = m$. Define $\iota^-(K, K')$, $\iota^+(K, K')$ and $\iota(K, K')$ as the least values for the integers $\deg(f^-)$, $\deg(f^+)$ and $m = \deg(f^-) + \deg(f^+)$ (respectively) among all such pairs. In particular, define $\iota^\pm(K) = \iota^\pm(K, U)$ and $\iota(K) = \iota(K, U)$, where U denotes the unknot.

When $K' = U$, the chain complex $\text{CF}(U)$ is chain homotopic to \mathbb{A} (with trivial differentials). For defining $\iota^\pm(K)$ and $\iota(K)$, we are thus lead to consider all pairs of homogeneous chain maps

$$f^+ : \text{CF}(K) \rightarrow \mathbb{A} \quad \text{and} \quad f^- : \mathbb{A} \rightarrow \text{CF}(K)$$

of degrees $m^+ = \deg(f^+)$ and $m^- = \deg(f^-)$ such that $f^- \circ f^+$ is multiplication by w^m and $f^+ \circ f^-$ is chain homotopic to multiplication by w^m . The discussion of the previous section, and in particular Theorem 2.2 and Proposition 2.3, imply the following theorem.

Theorem 3.1. *Given a pair of knots $K, K' \subset S^3$, $u^\bullet(K, K')$ is bounded below by $\iota^\bullet(K, K')$ for $\bullet \in \{-, +\}$, while $u(K, K')$ is bounded below by $\iota(K, K')$.*

Remark 3.2. *Given the knots K and K' in S^3 , any pair of chain maps f^+ and f^- satisfying the assumptions of Definition 3.1 would induce chain maps*

$$\bar{f}^- : \text{CF}(-K') \rightarrow \text{CF}(-K) \quad \text{and} \quad \bar{f}^+ : \text{CF}(-K) \rightarrow \text{CF}(-K')$$

of degrees m^+ and m^- , respectively. Moreover, $\bar{f}^- \circ \bar{f}^+ \simeq w^m$ and $\bar{f}^+ \circ \bar{f}^- \simeq w^m$. Thus,

$$\iota^+(-K, -K') = \iota^-(K, K'), \quad \iota^-(-K, -K') = \iota^+(K, K') \quad \text{and} \quad \iota(K, K') = \iota(-K, -K').$$

Let us denote the homology of $\text{CF}(K, s)$ by $\mathbb{H}(K, s)$ for every $s \in \mathbb{Z}$, and set $\mathbb{H}(K) = \bigoplus_s \mathbb{H}(K, s)$. Then $\mathbb{H}(K)$ is a module over $\mathbb{A} = \mathbb{F}[u, w]$. Let $\mathbb{T}(K)$ denote the torsion submodule of $\mathbb{H}(K)$, i.e.

$$\mathbb{T}(K) = \{x \in \mathbb{H}(K) \mid \exists a \in \mathbb{A} - \{0\} \text{ s.t. } ax = 0\}.$$

It is clear that $\mathbb{T}(K)$ is a sub-module of $\mathbb{H}(K)$, and there is a short exact sequence

$$0 \longrightarrow \mathbb{T}(K) \xrightarrow{\iota_K} \mathbb{H}(K) \xrightarrow{\pi_K} \mathbb{A}(K) \longrightarrow 0,$$

where $\mathbb{A}(K)$, defined by the above exact sequence, is the torsion-free part of $\mathbb{H}(K)$. Fix a sequence \mathbb{I} of crossing changes which modify K to the unknot. Correspondingly, we obtain the \mathbb{A} -homomorphisms $f_{\mathbb{I}}^+ : \mathbb{H}(K) \rightarrow \mathbb{A}$ and $f_{\mathbb{I}}^- : \mathbb{A} \rightarrow \mathbb{H}(K)$. The map $f_{\mathbb{I}}^+$ induces a map $f_{\mathbb{I}, \mathbb{T}}^+ : \mathbb{T}(K) \rightarrow \mathbb{A}$, while $f_{\mathbb{I}}^-$ induces the map $f^- : \mathbb{A} \rightarrow \mathbb{A}(K)$.

Lemma 3.3. *The map $f^- : \mathbb{A} \rightarrow \mathbb{A}(K)$ induced by $f_{\mathbb{I}}^-$ is injective, while the map $f_{\mathbb{I}, \mathbb{T}}^+ : \mathbb{T}(K) \rightarrow \mathbb{A}$ is trivial. We thus have a map $f^+ : \mathbb{A}(K) \rightarrow \mathbb{A}$ induced by $f_{\mathbb{I}}^+$, which is injective. The induced maps are homogeneous with respect to the Alexander grading.*

Proof. Let $m^+ = \deg(f_{\mathbb{I}}^+)$ and $m^- = \deg(f_{\mathbb{I}}^-)$. If $x \in \mathbb{T}(K)$ and $ax = 0$ for $0 \neq a \in \mathbb{A}$, it follows that $a f_{\mathbb{I}}^+(x) = 0$ in \mathbb{A} , implying that $f_{\mathbb{I}}^+(x) = 0$. Since the restriction $f_{\mathbb{I}, \mathbb{T}}^+$ of $f_{\mathbb{I}}^+$ to $\mathbb{T}(K)$ is trivial, a map $f^+ : \mathbb{A}(K) \rightarrow \mathbb{A}$ is induced by $f_{\mathbb{I}}^+$. Let us now assume that $x \in \mathbb{H}(K)$ is in the kernel of $f_{\mathbb{I}}^+$. Then $w^m x = f_{\mathbb{I}}^- \circ f_{\mathbb{I}}^+(x) = 0$, implying that $x \in \mathbb{T}(K)$. In particular, $f^+ : \mathbb{A}(K) \rightarrow \mathbb{A}$ is injective. On the other hand, if $a \in \mathbb{A}$ and $x = f_{\mathbb{I}}^-(a) \in \mathbb{T}(K)$, it follows that $0 = f_{\mathbb{I}}^+(x) = w^m a$, implying that $a = 0$. Thus $f^- : \mathbb{A} \rightarrow \mathbb{A}(K)$ is injective. This completes the proof of the lemma, as the statement about the Alexander grading follows immediately from our previous discussions. \square

Proposition 3.4. *There is a sequence $0 = i_0(K) < i_1(K) < \dots < i_n(K) = \nu^-(K)$ associated with every knot $K \subset S^3$, and an identification*

$$(2) \quad \mathbb{A}(K) = \left\langle \mathbf{u}^{i_k(K)} \mathbf{w}^{i_n - k(K)} \mid k \in \{0, 1, \dots, n\} \right\rangle_{\mathbb{A}}.$$

Moreover, the identification of Equation 2 preserves the Alexander grading.

Proof. If we set $\mathbf{w} = 1$ and consider $\text{CF}(K)$ as a chain complex filtered by the Alexander filtration, we obtain an identification

$$(3) \quad \mathbb{H}(K, s) = H_{\star}(C\{\max(i, j - s) \leq 0\}).$$

Under this identification, the homomorphism induced by inclusion

$$v_s : H_{\star}(C\{\max(i, j - s) \leq 0\}) \rightarrow H_{\star}(C\{\max(i, j - s - 1) \leq 0\})$$

is equal to multiplication by \mathbf{w} . Recall that $\nu^- = \nu^-(K)$ is the smallest s such that the map

$$h_s : H_{\star}(C\{\max(i, j - s) \leq 0\}) \rightarrow H_{\star}(C\{i \leq 0\}) = \mathbb{F}[U]$$

induced by inclusion is surjective, where $U = \mathbf{u}\mathbf{w}$. It is clear that for all s , under the identification of Equation 3, $\mathbb{T}(K, s)$ is equal to the kernel of h_s and so the restriction of h_s to $\mathbb{A}(K, s) \cong \mathbb{F}[U]$ is injective. Furthermore, for all $s \geq \nu^-$, multiplication by \mathbf{w} is an isomorphism from $\mathbb{A}(K, s)$ to $\mathbb{A}(K, s+1)$. Let a denote the generator of $\mathbb{A}(K, \nu^-)$ i.e. $h_{\nu^-}(a) = 1$. The above observations imply that for any $b \in \mathbb{A}(K, s)$

$$(4) \quad \begin{cases} b = \mathbf{w}^{s - \nu^-} p_b(U) a & \text{if } s \geq \nu^- \\ \mathbf{w}^{\nu^- - s} b = p_b(U) a & \text{if } s < \nu^- \end{cases}$$

for some polynomial $p_b \in \mathbb{F}[U]$. If $b \in \mathbb{A}(K, s)$ is the generator, $p_b(U) = 1$ for $s \geq \nu^-$. Suppose now that $s < \nu^-$ and b is the generator of $\mathbb{A}(K, s)$ as before. Since $\mathbf{u}^{\nu^- - s} a \in \mathbb{A}(K, s)$, we have $\mathbf{u}^{\nu^- - s} a = p'(U)b$, and so $U^{\nu^- - s} a = p_b(U)p'(U)a$. Therefore, $p_b(U)p'(U) = U^{\nu^- - s}$ and $p_b(U) = U^{j_s}$ for some $0 \leq j_s \leq \nu^- - s$.

Additionally, $\mathbb{H}(K)$ is symmetric under exchanging the variables \mathbf{u} and \mathbf{w} , so for all $s \leq -\nu^-$ multiplication by \mathbf{u} is an isomorphism from $\mathbb{A}(K, s)$ to $\mathbb{A}(K, s-1)$. Let $a' \in \mathbb{A}(K, -\nu^-)$ denote the generator. It is straightforward that,

$$\mathbf{u}^{2\nu^-} a = U^{\nu^-} a' \quad \text{and} \quad \mathbf{w}^{2\nu^-} a' = U^{\nu^-} a.$$

Further, for any generator $b \in \mathbb{A}(K, s)$ with $-\nu^- \leq s \leq \nu^-$ we have $\mathbf{u}^{\nu^- + s} b = U^{j'_s} a'$ where $j'_s = j_s + s$.

Then, we define a grading preserving \mathbb{A} -module homomorphism

$$\iota : \mathbb{A}(K) = \bigoplus_s \mathbb{A}(K, s) \rightarrow \mathbb{A}$$

by setting $\iota(b) = \mathbf{u}^{j_s} \mathbf{w}^{j'_s}$ for the generator $b \in \mathbb{A}(K, s)$. For instance, if $s \geq \nu^-$ is non-negative then $\iota(b) = \mathbf{w}^s$, while if $s \leq -\nu^-$ is non-positive then $\iota(b) = \mathbf{u}^{-s}$. It is clear that ι is injective and it identifies $\mathbb{A}(K)$ with an ideal generated by at most $2\nu^- + 1$ monomial of the form $\mathbf{u}^i \mathbf{w}^j$ with $0 \leq i, j \leq \nu^-$ in \mathbb{A} . This set of generators contains a unique minimal subset

$$\{\mathbf{u}^{i_k} \mathbf{w}^{j_k} \mid 0 = i_0 < i_1 < \dots < i_n = \nu^- \text{ and } \nu^- = j_0 > j_1 > \dots > j_n = 0\}$$

that generates the image of ι . The symmetry of $\mathbb{H}(K)$ implies that $j_k = i_{n-k}$ for all $k = 0, \dots, n$. \square

Definition 3.2. Under the identification of Equation 2, for every knot $K \subset S^3$ the sequence

$$\iota(K) = (0 = i_0(K) < i_1(K) < \dots < i_{n(K)}(K) = \nu^-(K))$$

is called the *ideal sequence* associated with the knot K . The ideal $\mathbb{A}(\iota)$ associated with a sequence $\iota = (0 = i_0 < i_1 < \dots < i_n)$ is defined as

$$\mathbb{A}(\iota) = \left\langle \mathbf{u}^{i_k} \mathbf{w}^{i_n - k} \mid k \in \{0, 1, \dots, n\} \right\rangle_{\mathbb{A}},$$

and we identify $\mathbb{A}(K) = \mathbb{A}(\iota(K))$. For finite increasing sequences ι, ι' of non-negative integers as above define the *distance* $\ell(\iota, \iota')$ from ι to ι' as the smallest value for p such that $w^p \mathbb{A}(\iota') \subset \mathbb{A}(\iota)$. Given the knots $K, K' \subset S^3$, define the *negative distance* $\ell^-(K, K')$ as $\ell(\iota(K), \iota(K'))$. Define the *positive distance* by $\ell^+(K, K') = \ell^-(-K, -K')$, where $-K$ denotes the mirror image of K . Define the positive/negative *depth* of a knot K by $\ell^\pm(K) = \ell^\pm(K, U)$, where U denotes the unknot.

Note that under the identification of Equation 2, the negative depth of K is equal to $\nu^-(K)$.

Proposition 3.5. *Let K and K' be knots in S^3 . Then*

$$\iota^+(K, K') \geq \max\{\ell^+(K, K'), \ell^-(K', K)\} \quad \text{and} \quad \iota^-(K, K') \geq \max\{\ell^-(K, K'), \ell^+(K', K)\}.$$

Proof. It is straightforward corollary of the definition, that $\iota^-(K, K') = \iota^+(K', K)$. So, remark 3.2 implies that it suffices to show that $\iota^-(K, K') \geq \ell^-(K, K')$. By definition, there exists \mathbb{A} -homomorphisms

$$f : \mathbb{A}(K) \rightarrow \mathbb{A}(K') \quad \text{and} \quad g : \mathbb{A}(K') \rightarrow \mathbb{A}(K)$$

such that $f \circ g$ and $g \circ f$ are equal to multiplication by w^m , and $\deg(g) = \iota^-(K, K')$. Under the identification of Equation 2, it is easy to check that f and g are the restriction of \mathbb{A} -homomorphisms from \mathbb{A} to \mathbb{A} defined by multiplication with polynomials p and q in \mathbb{A} . Since, $pq = w^m$ and $\deg(g) = \iota^-(K, K')$, we have $g = w^{\iota^-(K, K')}$ and so $\iota^-(K, K') \geq \ell^-(K, K')$. \square

Theorem 3.1 and the above proposition imply that $\ell^\pm(K, K') \leq u^\pm(K, K')$.

Corollary 3.6. *For any knot $K \subset S^3$, we have*

$$u^-(K) \geq \iota^-(K) \geq \nu^-(K) \geq \tau(K) \quad \text{and} \quad u^+(K) \geq \iota^+(K) \geq \nu^-(-K) \geq -\tau(K).$$

Therefore, for $0 \leq t \leq 1$, we have $-t\iota^-(K) \leq \Upsilon_K(t) \leq t\iota^+(K)$.

Proof. The first two claims follow from Proposition 3.5 and the inequality $\nu^-(K) \geq \tau(K)$ from [HW16, Proposition 2.3]. The last claim follows from the inequality $-t\nu^-(K) \leq \Upsilon_K(t)$ from [OSS17, Proposition 4.7]. \square

4. THE TORSION OBSTRUCTION

Let us assume that a sequence \mathbb{I} of crossing changes is used to unknot $K \subset S^3$. Let us further assume that $m^+ = m^+(\mathbb{I})$ and $m^- = m^-(\mathbb{I})$, while $m = m^+ + m^- = |\mathbb{I}|$. The argument of Lemma 3.3 then implies that multiplication by w^m trivializes all of $\mathbb{T}(K)$. This observation gives a weaker obstruction to the unknotting number.

Definition 4.1. Define the *negative torsion depth* $\mathfrak{t}^-(K)$ of a knot $K \subset S^3$ to be the smallest integer m such that multiplication by w^m is trivial on $\mathbb{T}(K)$. Let $\mathfrak{t}^+(K) = \mathfrak{t}^-(-K)$. Then $\mathfrak{t}(K) = \max\{\mathfrak{t}^-(K), \mathfrak{t}^+(K)\}$ is called the *torsion depth* of K .

Consider the homomorphism $\widehat{\phi} : \mathbb{A} \rightarrow \mathbb{F}[w]$ defined by $\widehat{\phi}(u) = 0$ and $\widehat{\phi}(w) = w$. This homomorphism makes $\mathbb{F}[w]$ into an \mathbb{A} -module. We define

$$\widehat{\text{CF}}(K) = \text{CF}(K) \otimes_{\widehat{\phi}} \mathbb{F}[w] \quad \text{and} \quad \widehat{\text{H}}(K) = H_\star(\widehat{\text{CF}}(K)).$$

Then $\widehat{\text{H}}(K)$ is a $\mathbb{F}[w]$ -module, with a free summand isomorphic to $\mathbb{F}[w]$ and a torsion summand denoted by $\widehat{\text{T}}(K)$. Define $\widehat{\mathfrak{t}}(K)$ as the smallest m such that multiplication by w^m is trivial on $\widehat{\text{T}}(K)$. The following proposition is a straightforward corollary of previous definitions and discussions.

Proposition 4.1. *For any knot $K \subset S^3$, the torsion classes $\widehat{\mathfrak{t}}(K)$, $\widehat{\mathfrak{t}}(-K)$, and $\mathfrak{t}(K)$ are lower bounds for $\mathfrak{l}(K)$, and thus for the unknotting number $u(K)$.*

Proposition 4.2. *If the genus $g(K)$ of a knot $K \subset S^3$ is strictly bigger than $\tau(K)$ then $\mathbb{T}(K) \neq 0$, and in particular, $\mathfrak{t}^-(K) \geq 1$.*

Proof. The differential d of the chain complex $\text{CF}(K)$ may be written as $d = \sum_{i,j \geq 0} \mathbf{u}^i \mathbf{w}^j d^{i,j}$. Using a spectral sequence determined by $(\text{CF}(K), d)$, we can replace $\text{CF}(K)$ with page 1 of the aforementioned spectral sequence and assume that $d^{0,0} = 0$. Let x denote a generator of $\widehat{\text{HFK}}(K, g(K))$. If a generator y appears in $d^{i,0}(x)$ (where $i > 0$), it follows that

$$g(K) = A(x) = A(\mathbf{u}^i y) = A(y) - i < A(y).$$

Since $\widehat{\text{HFK}}(K, s) = 0$ for $s > g(K)$, the above observation implies that $d^{i,0}(x) = 0$. In particular, $d(x) = \mathbf{w}^p z$ for some $p > 0$ and some z representing a class $[z] \in \mathbb{H}(K)$. Clearly, $\mathbf{w}^p [z] = 0$ in $\mathbb{H}(K)$. If $z = d(x')$ for some $x' \in \text{CF}(K)$, then $d(x + \mathbf{w}^p x') = 0$. Since $\tau(K) < g(K)$, the image of $x + \mathbf{w}^p x'$ under the chain map $\text{CF}(K) \rightarrow \widehat{\text{CF}}(K)$ represents a trivial homology class. Thus, x appears in $d^{0,i}(y)$ (where $i > 0$) for some generator $y \in \widehat{\text{HFK}}(K)$. So,

$$A(y) = A(\mathbf{w}^i x) = A(x) + i > g(K)$$

which is a contradiction. In particular, $[z]$ is non-zero in $\mathbb{T}(K)$. \square

Corollary 4.3. *If K is a non-trivial knot then $\widehat{\mathfrak{t}}(K) > 0$ and $\mathfrak{t}(K) > 0$.*

Proof. The first claim is a trivial consequence of the definition. Since K is non-trivial, $g(K) \geq 1$. If $\tau(K) < g(K)$, Proposition 4.2 gives the second claim. Otherwise, $\tau(-K) = -g(K) < g(-K)$ and $\mathfrak{t}(K) \geq \mathfrak{t}(-K) > 0$. \square

Proposition 4.4. *Suppose K and K' are knots in S^3 . Then,*

$$\max\{\widehat{\mathfrak{t}}(K), \widehat{\mathfrak{t}}(K')\} \leq \widehat{\mathfrak{t}}(K \# K') \leq \widehat{\mathfrak{t}}(K) + \widehat{\mathfrak{t}}(K').$$

Proof. By Künneth theorem for homology, there is an exact sequence

$$0 \longrightarrow \widehat{\mathbb{H}}(K) \otimes \widehat{\mathbb{H}}(K') \longrightarrow \widehat{\mathbb{H}}(K \# K') \longrightarrow \text{Tor}_{\mathbb{F}[\mathbf{w}]}(\widehat{\mathbb{H}}(K), \widehat{\mathbb{H}}(K')) \longrightarrow 0.$$

Thus, $\widehat{\mathbb{H}}(K \# K')$ has torsion summands isomorphic to $\widehat{\mathbb{T}}(K)$ and $\widehat{\mathbb{T}}(K')$ and so

$$\widehat{\mathfrak{t}}(K \# K') \geq \max\{\widehat{\mathfrak{t}}(K), \widehat{\mathfrak{t}}(K')\}.$$

Moreover, multiplication by $\mathbf{w}^{\min\{\widehat{\mathfrak{t}}(K), \widehat{\mathfrak{t}}(K')\}}$ is trivial on $\widehat{\mathbb{T}}(K) \otimes \widehat{\mathbb{T}}(K')$ and $\text{Tor}_{\mathbb{F}[\mathbf{w}]}(\widehat{\mathbb{H}}(K), \widehat{\mathbb{H}}(K'))$. Therefore, $\widehat{\mathfrak{t}}(K \# K')$ is at most $\widehat{\mathfrak{t}}(K) + \widehat{\mathfrak{t}}(K')$. \square

Remark 4.5. *One can construct a similar lower bound $\mathfrak{t}_{p/q}$ by sending \mathbf{u} and \mathbf{w} to \mathbf{v}^p and \mathbf{v}^q in $\mathbb{F}[\mathbf{v}]$, respectively, which satisfies in a statement similar to Proposition 4.4.*

5. EXAMPLES AND APPLICATIONS

Example 5.1. Let $K = T_{p,q}$ be the (p, q) torus knot with $0 < p < q$. The chain homotopy type of $\text{CF}(K)$ is specified by the Alexander polynomial of K [OS05]. Specifically, the symmetrized Alexander polynomial of K is equal to

$$\Delta_K(t) = t^{-\frac{(p-1)(q-1)}{2}} \frac{(t^{pq} - 1)(t - 1)}{(t^p - 1)(t^q - 1)} = \sum_{i=0}^{2n} (-1)^i t^{a_i}$$

for a sequence $a_0 > a_1 > \dots > a_{2n}$ of integers where $a_i = -a_{2n-i}$. The complex $\text{CF}(K)$ is chain homotopic to the bigraded complex freely generated over \mathbb{A} with generators $\{\mathbf{x}_i\}_{i=0}^{2n}$ and differential

$$d\mathbf{x}_i = \begin{cases} \mathbf{u}^{a_{i-1}-a_i} \mathbf{x}_{i-1} + \mathbf{w}^{a_i-a_{i+1}} \mathbf{x}_{i+1} & \text{if } i \text{ is odd} \\ 0 & \text{if } i \text{ is even.} \end{cases}$$

Furthermore, the gradings are specified by $\mu(\mathbf{x}_i) = m_i$ and $A(\mathbf{x}_i) = a_i$ where m_i is defined recursively by $m_0 = 0$ and

$$m_{2i} = m_{2i-1} - 1 \quad \text{and} \quad m_{2i+1} = m_{2i} - 2(a_{2i} - a_{2i+1}) + 1.$$

Consequently, $\mathbb{T}(K) = 0$ and $\mathbb{A}(K) = \mathbb{H}(K)$ is generated by $[\mathbf{x}_{2i}]$ for $i = 0, \dots, n$. Moreover,

$$\mathbf{w}^{a_{2i-1}-a_{2i}} \mathbf{x}_{2i} = \mathbf{u}^{a_{2i}-2-a_{2i-1}} \mathbf{x}_{2i-2}.$$

Thus, $\iota(T_{p,q}) = (i_0 = 0 < i_1 < \dots < i_n)$ where

$$i_k = \sum_{j=0}^{2(n-k)} (-1)^j a_j.$$

For any knot K , $\text{CF}(-K) \simeq \text{CF}(K)^*$. So for $-K = T_{p,-q}$, the above discussion implies that $\text{CF}(-K)$ is chain homotopic to the chain complex freely generated over \mathbb{A} with generators $\{\mathbf{x}_i\}_{i=0}^{2n}$ and differential

$$d\mathbf{x}_i = \begin{cases} 0 & \text{if } i \text{ is odd} \\ \mathbf{u}^{a_{i-1}-a_i} \mathbf{x}_{i-1} + \mathbf{w}^{a_i-a_{i+1}} \mathbf{x}_{i+1} & \text{if } i \text{ is even.} \end{cases}$$

Moreover, the bigradings of generators is given by $(\mu(\mathbf{x}_i), A(\mathbf{x}_i)) = (-m_{2n-i}, a_i)$. Thus, $\mathbb{A}(-K) \cong \mathbb{A}$ is generated by $\sum_{k=0}^n \mathbf{u}^{i_{n-k}} \mathbf{w}^{i_k} \mathbf{x}_{2k}$, while $[\mathbf{x}_{2k+1}]$ is torsion of order i_{k+1} for $k = 0, \dots, n-1$. Therefore,

$$\mathfrak{t}(T_{p,q}) = \mathfrak{t}^+(T_{p,q}) = i_n = \nu^-(T_{p,q}) = \frac{(p-1)(q-1)}{2}.$$

Consider $\widehat{\text{CF}}(K) = \text{CF}(K) \otimes_{\hat{\phi}} \mathbb{F}[\mathbf{w}]$, where as before $\hat{\phi} : \mathbb{A} \rightarrow \mathbb{F}[\mathbf{w}]$ is the homomorphisms defined by $\hat{\phi}(\mathbf{u}) = 0$ and $\hat{\phi}(\mathbf{w}) = \mathbf{w}$. By the above discussion, $\widehat{\mathbb{H}}(K)$ has a free summand generated by $[\mathbf{x}_0]$. Moreover, for each $1 \leq i \leq n$, $[\mathbf{x}_{2i}]$ is a torsion class of order $a_{2i-1} - a_{2i}$. It is easy to check that

$$a_1 - a_2 = p - 1 \quad \text{and} \quad a_{2i-1} - a_{2i} \leq p - 1 \quad \text{for every } i = 1, \dots, n.$$

Therefore, $\widehat{\mathfrak{t}}(T_{p,q}) = p - 1$.

Special case: $p = 2$, $q = 2n + 1$. For the torus knot $T_{2,2n+1}$ we have

$$\Delta_{T_{2,2n+1}}(t) = \sum_{i=0}^{2n} (-1)^i t^{i-n}.$$

So $a_i = n - i$ for $0 \leq i \leq 2n$, and thus

$$\iota(T_{2,2n+1}) = (0 < 1 < 2 < \dots < n) \quad \text{and} \quad \mathbb{A}(T_{2,2n+1}) = \langle \mathbf{u}^i \mathbf{w}^j \mid i + j \geq n \rangle_{\mathbb{A}}.$$

Special case: $p = 3$, $q = 3k \pm 1$. Suppose $q = 3k + 1$. First, we compute the symmetrized Alexander polynomial of $T_{3,3k+1}$:

$$\begin{aligned} \Delta_{T_{3,3k+1}}(t) &= t^{-3k} \frac{(t^{3(3k+1)} - 1)(t - 1)}{(t^{3k+1} - 1)(t^3 - 1)} = t^{-3k} \frac{t^{2(3k+1)} + t^{3k+1} + 1}{t^2 + t + 1} \\ &= t^{-3k} \frac{t^{3k+2}(t^{3k} - 1) + t^{3k}(t^2 + t + 1) + 1 - t^{3k}}{t^2 + t + 1} \\ &= \sum_{i=1}^k (t^{3i} - t^{3i-1}) + 1 + \sum_{i=-k}^{-1} (t^{3i} - t^{3i+1}). \end{aligned}$$

Therefore, $n = 2k$, and

$$i_j = \begin{cases} j & \text{if } 0 \leq j < k \\ 2j - k & \text{if } k \leq j \leq n. \end{cases} \quad \Rightarrow \quad \mathbb{A}(T_{3,3k+1}) = \langle \mathbf{u}^i \mathbf{w}^j \mid 2i + j \geq 3k \text{ and } i + 2j \geq 3k \rangle_{\mathbb{A}}.$$

For $q = 3k - 1$, an analogous argument implies that

$$\mathbb{A}(T_{3,3k-1}) = \langle \mathbf{u}^i \mathbf{w}^j \mid 2i + j \geq 3k - 2 \text{ and } i + 2j \geq 3k - 2 \rangle_{\mathbb{A}}$$

More generally, the ideal sequence for the torus knot $T_{p,pn+1}$ takes the explicit form

$$(5) \quad \iota(T_{p,pn+1}) = \left(0 < 1 < \cdots < n < n+2 < \cdots < 3n < 3n+3 < \cdots < \binom{p}{2}n \right)$$

or equivalently, $i_k = \left(k - \frac{n}{2} \left\lfloor \frac{k}{n} \right\rfloor \right) \left(\left\lfloor \frac{k}{n} \right\rfloor + 1 \right)$, for $k = 0, 1, \dots, n(p-1)$.

One useful computation is the degree computation for the generator

$$\mathbf{u}^{i_{\lfloor n(p-1)/2 \rfloor}} \mathbf{w}^{i_{\lceil n(p-1)/2 \rceil}} \in \mathbb{A}(T_{p,pn+1}),$$

which follows from Equation 5:

$$(6) \quad \begin{aligned} i_{\lfloor n(p-1)/2 \rfloor} + i_{\lceil n(p-1)/2 \rceil} &= \left(\left\lfloor \frac{n(p-1)}{2} \right\rfloor - \frac{n}{2} \left\lfloor \frac{\lfloor \frac{n(p-1)}{2} \rfloor}{n} \right\rfloor \right) \left(\left\lfloor \frac{\lfloor \frac{n(p-1)}{2} \rfloor}{n} \right\rfloor + 1 \right) \\ &\quad + \left(\left\lceil \frac{n(p-1)}{2} \right\rceil - \frac{n}{2} \left\lfloor \frac{\lceil \frac{n(p-1)}{2} \rceil}{n} \right\rfloor \right) \left(\left\lfloor \frac{\lceil \frac{n(p-1)}{2} \rceil}{n} \right\rfloor + 1 \right) \\ &= n \left\lfloor \frac{p^2}{4} \right\rfloor. \end{aligned}$$

The minimum degree of a monomial in $\mathbb{A}(K)$ will be denoted by $\mathfrak{a}(K)$. The above computation shows that $\mathfrak{a}(T_{p,pn+1}) = n \left\lfloor \frac{p^2}{4} \right\rfloor$.

Remark 5.1. *One can in fact show that for every $p < q$, there is an inclusion*

$$(7) \quad \mathbb{A}(T_{p,q}) \leq \mathbb{A}_{p,q} = \left\langle \mathbf{u}^i \mathbf{w}^j \mid ki + (p-k)j \geq \frac{k(p-k)(q-1)}{2} \text{ for } k = 1, \dots, p-1 \right\rangle_{\mathbb{A}}.$$

However, the equality is not satisfied for $p > 3$, although the two ideals are very closely related.

Proposition 5.2. *If a torus knot $K = T_{p,p'}$ with $0 < p < p'$ is Gordian adjacent to a torus knot $K' = T_{q,q'}$ with $0 < q < q'$, then*

$$\mathbb{A}(T_{q,q'}) \leq \mathbb{A}(T_{p,p'}) \quad \text{and} \quad \mathbf{w}^u \mathbb{A}(T_{p,p'}) \leq \mathbb{A}(T_{q,q'}),$$

where $u = u(K') - u(K) = \frac{(p-1)(p'-1)}{2} - \frac{(q-1)(q'-1)}{2}$. In particular, $\mathfrak{a}(T_{q,q'}) \geq \mathfrak{a}(T_{p,p'})$.

Proof. Since $T_{p,p'}$ is Gordian adjacent to $T_{q,q'}$, there exists \mathbb{A} -homomorphisms

$$f : \mathbb{H}(T_{p,p'}) \rightarrow \mathbb{H}(T_{q,q'}) \quad \text{and} \quad g : \mathbb{H}(T_{q,q'}) \rightarrow \mathbb{H}(T_{p,p'})$$

such that $f \circ g = g \circ f = \mathbf{w}^u$. Note that $\mathbb{H}(T_{p,p'}) = \mathbb{A}(T_{p,p'})$ and $\mathbb{H}(T_{q,q'}) = \mathbb{A}(T_{q,q'})$. So, f and g are defined by multiplication with polynomials $p, q \in \mathbb{A} = \mathbb{F}[u, w]$. Thus, $f \circ g = g \circ f = \mathbf{w}^u$ implies that $f = \mathbf{w}^{m^+}$ and $g = \mathbf{w}^{m^-}$ such that $m^+ + m^- = u$. On the other hand, by Corollary 3.6, a minimal unknotting sequence for a torus knot only consists of negative crossing changes. Thus $\deg f = m^+ = 0$ and $\deg g = m^- = u$. Therefore, $f = \text{id}$, g is multiplication by \mathbf{w}^u and $\mathbb{A}(T_{q,q'}) \leq \mathbb{A}(T_{p,p'})$ and $\mathbf{w}^u \mathbb{A}(T_{p,p'}) \leq \mathbb{A}(T_{q,q'})$. \square

The computations in Example 5.1 and the Proposition 5.2 have a number of quick consequences. One outcome is the following corollary that was suggested to us by Jennifer Hom. This result was first proved by Borodzik and Livingston in [BL16].

Corollary 5.3. *If a torus knot $T_{p,p'}$ with $0 < p < p'$ is Gordian adjacent to a torus knot $T_{q,q'}$ with $0 < q < q'$, then $p \leq q$.*

Proof. Assume that

$$\iota(T_{p,p'}) = (i_0 < \cdots < i_n) \quad \text{and} \quad \iota(T_{q,q'}) = (j_0 < \cdots < j_m).$$

Proposition 5.2 implies that $\mathbf{w}^{j_m - i_n} \mathbb{A}(T_{p,p'}) \leq \mathbb{A}(T_{q,q'})$. Thus,

$$\mathbf{w}^{j_m - i_n + i_{n-1}} \mathbf{u}^{i_1} = \mathbf{w}^{u(K') - u(K)} \mathbf{w}^{i_{n-1}} \mathbf{u}^{i_1} \in \mathbb{A}(K').$$

Since $i_1 = j_1 = 1$, $i_n - i_{n-1} = p - 1$ and $j_m - j_{m-1} = q - 1$, the above conclusion implies

$$j_m - i_n + i_{n-1} \geq j_{m-1} \quad \Leftrightarrow \quad \frac{(q-1)(q'-1)}{2} - p + 1 \geq \frac{(q-1)(q'-1)}{2} - q + 1 \quad \Leftrightarrow \quad q \geq p,$$

completing the proof. \square

We also obtain a proof of the following corollary. The second statement of the corollary was first proved by Peter Feller [Fel14].

Corollary 5.4. *If the torus knot $T_{p,pn+1}$ is Gordian adjacent to the torus knot $T_{q,qm+1}$ then*

$$n \left\lfloor \frac{p^2}{4} \right\rfloor \leq m \left\lfloor \frac{q^2}{4} \right\rfloor.$$

If $T_{2,n}$ is Gordian adjacent to $T_{3,m}$, where n is odd and m is not a multiple of 3, then $n \leq \frac{4}{3}m + \frac{1}{3}$.

Proof. Proposition 5.2 implies that $\mathbf{a}(T_{p,pn+1}) \leq \mathbf{a}(T_{q,qm+1})$. So, following the computations of Example 5.1 we have

$$n \left\lfloor \frac{p^2}{4} \right\rfloor \leq m \left\lfloor \frac{q^2}{4} \right\rfloor.$$

Moreover, from the same example we know that $\mathbb{A}(T_{3,m}) \leq \mathbb{A}(T_{2,n})$ if and only if for any pair (i, j) such that $i + 2j \geq m - 1$ and $j + 2i \geq m - 1$, we have $i + j \geq \frac{n-1}{2}$. It is clear that

$$\min\{i + j \mid i + 2j \geq m - 1 \text{ and } 2i + j \geq m - 1\} = \left\lceil \frac{2(m-1)}{3} \right\rceil = \left\lfloor \frac{2m}{3} - \frac{1}{3} \right\rfloor.$$

Thus, $\frac{n-1}{2} \leq \frac{2m}{3} - \frac{1}{3}$ and $n \leq \frac{4}{3}m + \frac{1}{3}$. \square

Example 5.2. An interesting example is the case of the figure 8 knot, where the chain complex is generated by 5 generators X, Y, Z, W and B , where $d(B) = d(X) = 0$ while $d(W) = \mathbf{u}Z + \mathbf{w}Y$, $d(Y) = \mathbf{u}Y$ and $d(Z) = \mathbf{w}X$. Thus, $\mathbb{T}(K)$ is generated by $\mathbf{x} = [X]$ and $\mathbf{u}\mathbf{x}$ and $\mathbf{w}\mathbf{x}$ are both zero. Moreover, $\mathbb{A}(K)$ is generated by $[B]$ and is isomorphic with \mathbb{A} . In particular, $\nu^-(K) = \nu^-(-K) = 0$, while $\mathfrak{t}(K) = \widehat{\mathfrak{t}}(K) = 1$. The sub-complex generated by X, Y, Z and W will be referred to as a *square*.

Example 5.3. Alternating knots are known to have simple knot Floer chain complexes. The restriction on the Alexander and Maslov grading of generators (that their difference is a constant number) implies that the chain complex decomposes as the (shifted) direct sum of a copy of $\text{CF}(\pm T_{2,2n+1})$ and several squares. In particular, if K is an alternating knot with $\tau(K) > 0$ then

$$\iota(K) = (0 < 1 < 2 < \cdots < \tau(K)),$$

while $\mathfrak{t}^-(K) \leq 1$ and $\mathfrak{l}(K) = \mathfrak{l}^-(K) = \mathfrak{t}^+(K) = \tau(K)$.

Example 5.3 gives interesting bounds on the *alternation number* $\text{alt}(K)$ of a knot K , defined as the minimum Gordian distance between K and an alternating knot. The first bound is very similar to, yet different from, the bound constructed in [FPZ18, Corollary 2.2].

Proposition 5.5. *The alternation number $\text{alt}(K)$ of a knot $K \subset S^3$ satisfies*

$$\text{alt}(K) \geq \nu^-(K) - \mathbf{a}(K), \quad \text{alt}(K) \geq \widehat{\mathfrak{t}}(K) - 1 \quad \text{and} \quad \text{alt}(K) \geq \min\{\mathfrak{t}(K) - 1, \nu^-(K)\}.$$

Proof. Let us assume that K is modified to an alternating knot K' using a sequence of m^+ positive crossing changes and m^- negative crossing changes and that $\text{alt}(K) = m^+ + m^-$. It follows that $\nu^-(K') \geq \nu^-(K) - m^-$. Since $w^{m^+} \mathbb{A}(K)$ is a subset of $\mathbb{A}(K')$, it follows that $\mathbb{A}(K')$ includes a monomial of degree $m^+ + \mathfrak{a}(K)$. Nevertheless, every monomial in $\mathbb{A}(K')$ has degree at least $\nu^-(K')$. This means that

$$\mathfrak{a}(K) + m^+ \geq \nu^-(K') \geq \nu^-(K) - m^- \quad \Rightarrow \quad m^+ + m^- \geq \nu^-(K) - \mathfrak{a}(K),$$

and completes the proof of the first inequality. The second and third inequalities are easier. For the second equality note that in the above situation,

$$u(K, K') \geq \widehat{\mathfrak{t}}(K) - \widehat{\mathfrak{t}}(K') = \widehat{\mathfrak{t}}(K) - 1.$$

For the third inequality, we have

$$\nu^-(K) \leq \nu^-(K') + m^- \quad \text{and} \quad \mathfrak{t}(K) \leq \mathfrak{t}(K') + m^+ + m^-.$$

If $\nu(K') = 0$ then $\nu^-(K) \leq m^- \leq \text{alt}(K)$. Otherwise, $\tau(K') = \nu(K') > 0$ and $\mathbb{T}(K')$ can only include torsion elements trivialized by w . In particular, $\mathfrak{t}(K') = 1$ and $\text{alt}(K) = m^+ + m^- \geq \mathfrak{t}(K) - 1$. \square

For torus knots, we obtain the following corollary from our computations in Example 5.1. Similar bounds may also be obtained using Upsilon invariants, c.f. [FPZ18] for the case $p < 5$.

Corollary 5.6. *The alternation number of the torus knot $T_{p,pn+1}$ is at least $n \left\lfloor \frac{(p-1)^2}{4} \right\rfloor$.*

Proof. Using the first inequality in Proposition 5.5 we have

$$\text{alt}(T_{p,pn+1}) \geq \nu(T_{p,pn+1}) - \mathfrak{a}(T_{p,pn+1}) = n \binom{p}{2} - n \left\lfloor \frac{p^2}{4} \right\rfloor = n \left\lfloor \frac{(p-1)^2}{4} \right\rfloor.$$

This completes the proof. \square

Example 5.4. The knot $12n_{404}$, which is a $(1, 1)$ knot, is illustrated in Figure 3. Using Rasmussen's notation [Ras05, page 14], it is given by the quadruple $[29, 7, 14, 1]$. The corresponding chain complex $\text{CF}(12n_{404})$ may be computed combinatorially, e.g. using Krcatovich's computer program [Krc]. After a straight-forward change of basis, we arrive at the chain complex illustrated in Figure 4.

Each dot represents a generator of $\text{CF}(12n_{404})$. An arrow which connects a dot corresponding to a generator \mathbf{x} to a dot representing a generator \mathbf{y} and cuts i vertical lines and j horizontal lines corresponds to the contribution of $u^i w^j \mathbf{y}$ to $d(\mathbf{x})$. The blue dots and the black dots in the diagram generate subcomplexes C and C' of the knot chain complex, respectively, and we obtain a decomposition $\text{CF}(12n_{404}) = C \oplus C'$. We may then identify

$$C = \langle X, Y_0, Y_1, Y_2, Z_0, Z_1 \rangle_{\mathbb{A}}, \quad d(Y_i) = u^i w^{2-i} X \quad \text{and} \quad d(Z_i) = uY_i + wY_{i+1}.$$

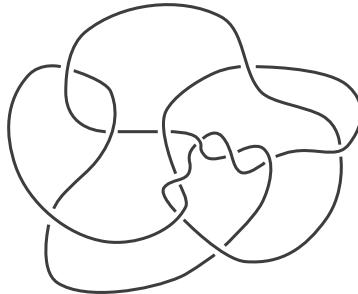

FIGURE 3. The knot $12n_{404}$

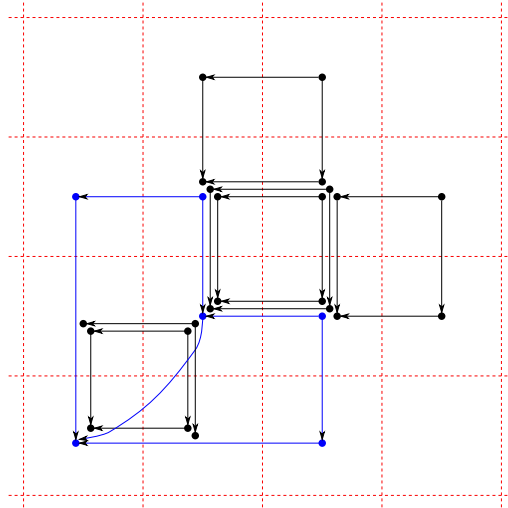

FIGURE 4. The chain complex associated with the knot $12n_{404}$.

The homology of C is then generated by $\mathbf{x} = [X]$, with $w^2\mathbf{x} = w\mathbf{x} = u^2\mathbf{x} = 0$. In particular, it follows that $t(12n_{404}) \geq 2$. In fact, it is straightforward from the above presentation of chain complex to conclude that $t(12n_{404}) = \widehat{t}(12n_{404}) = 2$, while

$$\Gamma^-(12n_{404}) = \nu^-(12n_{404}) = 1, \quad \Gamma^+(12n_{404}) = 0 \quad \text{and} \quad l(12n_{404}) = t(12n_{404}) = 2.$$

The knot $12n_{404}$ may be unknotted by changing 3 crossings. It is not known, however, whether $u(12n_{404})$ is equal to 3 or not. The alternation number $\text{alt}(12n_{404})$ is 1, which matches the lower bound given by the last two inequalities in Proposition 5.5.

Example 5.5. Consider the $(2, -1)$ cable of the torus knot $T_{2,3}$, which is denoted by $T_{2,3;2,-1}$. The chain complex associated with this knot is illustrated in Figure 5.

The chain complex is generated over $\mathbb{F}[u, w]$ by the 9 generator $X_1, X_2, Y_1, Y_2, Z_1, Z_2, Z_3, T_1$ and T_2 . The differential is given by $d(T_i) = 0$, $d(Y_i) = uwT_i$, for $i = 1, 2$ and

$$\begin{aligned} d(Z_1) &= wT_1, & d(Z_3) &= uT_1 + wT_2, & d(Z_2) &= uT_2, \\ d(X_1) &= uY_1 + uwZ_3 + w^2Z_2 & \text{and} & & d(X_2) &= u^2Z_1 + uwZ_3 + wY_2, \end{aligned}$$

The generators of homology may then be specified as $\mathbf{t}_1 = [T_1], \mathbf{t}_2 = [T_2], \mathbf{y}_1 = [Y_1 + uZ_1]$ and $\mathbf{y}_2 = [Y_2 + wZ_2]$, where we have

$$u\mathbf{t}_1 = w\mathbf{t}_2, \quad w\mathbf{t}_1 = u\mathbf{t}_2 = 0 \quad \text{and} \quad u\mathbf{y}_1 = w\mathbf{y}_2.$$

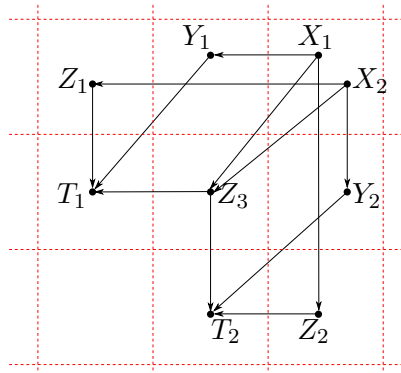

FIGURE 5. The chain complex associated with the knot $T_{2,3;2,-1}$.

It thus follows that

$$\mathbb{H}(T_{2,3;2,-1}) = \mathbb{A}(T_{2,3;2,-1}) \oplus \mathbb{T}(T_{2,3;2,-1}) = \langle \mathbf{u}, \mathbf{w} \rangle_{\mathbb{A}} \oplus \frac{\langle \mathbf{u}, \mathbf{w} \rangle_{\mathbb{A}}}{\langle \mathbf{u}^2, \mathbf{w}^2 \rangle_{\mathbb{A}}}.$$

In particular, $\mathfrak{t}(T_{2,3;2,-1}) = \widehat{\mathfrak{t}}(T_{2,3;2,-1}) = 2$, $\nu^-(T_{2,3;2,-1}) = 1$ and $\mathfrak{l}^-(T_{2,3;2,-1}) = 2$. Since the torsion invariant $\mathfrak{t}(T_{2,3})$ is zero, it follows that the Gordian distance between $T_{2,3;2,-1}$ and the trefoil $T_{2,3}$ is at least 2.

Example 5.6. Let us now consider the $(2, -3)$ cable of the torus knot $T_{2,3}$, which is denoted by $T_{2,3;2,-3}$. We focus on the mirror image $K = -T_{2,3;2,-3}$ of the aforementioned knot. The chain complex associated with K is illustrated in Figure 6.

The chain complex is generated over $\mathbb{F}[\mathbf{u}, \mathbf{w}]$ by 11 generators $T_1, T_2, X_1, X_2, X_3, Y_1, Y_2, Z_1, Z_2, Z_3$ and Z_4 . The differential is given by $d(T_1) = d(T_2) = 0$ and

$$\begin{aligned} d(Y_1) &= \mathbf{u}T_1, & d(Y_2) &= \mathbf{w}T_2, & d(Z_1) &= \mathbf{w}^2T_1, & d(Z_2) &= \mathbf{u}^2T_2, & d(Z_3) &= \mathbf{u}\mathbf{w}T_1, & d(Z_4) &= \mathbf{u}\mathbf{w}T_2, \\ d(X_1) &= \mathbf{u}Z_1 + \mathbf{w}Z_3, & d(X_2) &= \mathbf{w}Z_2 + \mathbf{u}Z_4 & \text{and} & d(X_3) &= \mathbf{u}Z_3 + \mathbf{w}Z_4 + \mathbf{u}\mathbf{w}(Y_1 + Y_2). \end{aligned}$$

The homology of the above chain complex is generated by $\mathbf{t}_1 = [T_1]$, $\mathbf{t}_2 = [T_2]$, $\mathbf{y}_1 = [Z_3 + \mathbf{w}Y_1]$ and $\mathbf{y}_2 = [Z_4 + \mathbf{u}Y_2]$, while we also have

$$\mathbf{u}\mathbf{t}_1 = \mathbf{w}^2\mathbf{t}_1 = \mathbf{w}\mathbf{t}_2 = \mathbf{u}^2\mathbf{t}_2 = 0 \quad \text{and} \quad \mathbf{u}\mathbf{y}_1 = \mathbf{w}\mathbf{y}_2.$$

It thus follows that

$$\mathbb{H}(-T_{2,3;2,-3}) = \mathbb{A}(-T_{2,3;2,-3}) \oplus \mathbb{T}(-T_{2,3;2,-3}) = \langle \mathbf{u}, \mathbf{w} \rangle_{\mathbb{A}} \oplus \left(\frac{\mathbb{A}}{\langle \mathbf{u}, \mathbf{w}^2 \rangle_{\mathbb{A}}} \oplus \frac{\mathbb{A}}{\langle \mathbf{u}^2, \mathbf{w} \rangle_{\mathbb{A}}} \right).$$

By considering the dual complex, one can show that

$$\mathbb{H}(T_{2,3;2,-3}) = \mathbb{A} \oplus \frac{\langle \mathbf{u}, \mathbf{w} \rangle_{\mathbb{A}}}{\langle \mathbf{u}^2, \mathbf{w}^2 \rangle_{\mathbb{A}}}.$$

In particular, we have $\nu^-(-T_{2,3;2,-3}) = 1$ and $\nu^-(T(2, 3; 2, -3)) = 0$ while the torsion invariants are non-trivial:

$$\mathfrak{t}^-(T_{2,3;2,-3}) = \mathfrak{t}^+(T(2, 3; 2, -3)) = \widehat{\mathfrak{t}}(T_{2,3;2,-3}) = \widehat{\mathfrak{t}}(-T_{2,3;2,-3}) = 2.$$

Example 5.7. This example illustrates that $\mathbb{H}(K)$ is not necessarily the direct sum of $\mathbb{A}(K)$ and $\mathbb{T}(K)$. Let $K = T_{4,5} \# -T_{2,3;2,5} \# T_{2,3}$. The chain complex for K is large, with many acyclic pieces. Nevertheless, it includes a direct summand, which we would like to study. Specifically, $\text{CF}(K) = C \oplus C'$, where the chain complex C is illustrated in Figure 7 and the homology of C' is freely generated by torsion elements \mathbf{t}_i such that $\mathbf{u}\mathbf{t}_i = \mathbf{w}\mathbf{t}_i = 0$.

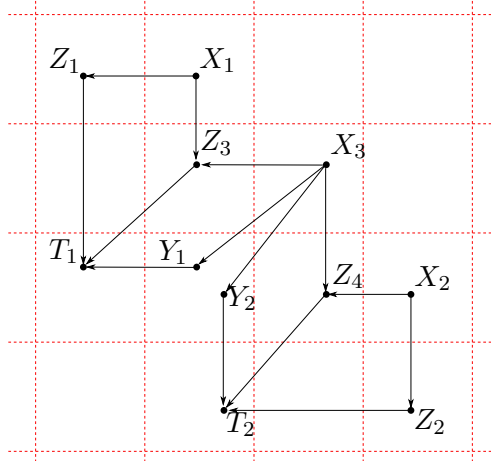
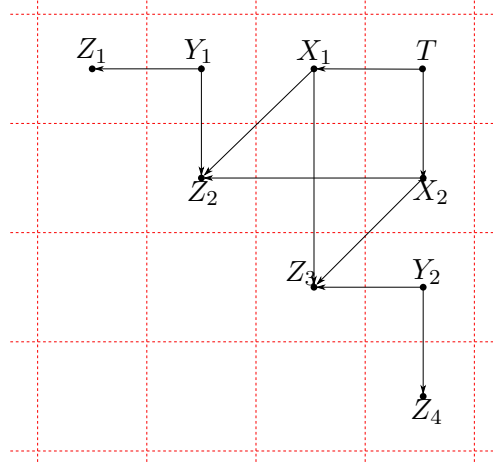

FIGURE 6. The chain complex associated with the knot $-T_{2,3;2,-3}$.

 FIGURE 7. The chain complex C associated with the knot $T_{4,5}\# - T_{2,3;2,5}\#T_{2,3}$.

The chain complex is generated over $\mathbb{F}[u, w]$ by the 9 generators $X_1, X_2, Y_1, Y_2, Z_1, Z_2, Z_3, Z_4$ and T . The differential is given by $d(Z_i) = 0$ for $i = 1, 2, 3, 4$ and

$$\begin{aligned} d(Y_1) &= uZ_1 + wZ_2, & d(Y_2) &= uZ_3 + wZ_4, & d(T) &= uX_1 + wX_2 \\ d(X_1) &= uwZ_2 + w^2Z_3 & \text{and} & & d(X_2) &= u^2Z_2 + uwZ_3. \end{aligned}$$

The homology of C is then generated by the classes $\mathbf{z}_i = [Z_i]$ for $i = 1, 2, 3, 4$, while we have

$$u\mathbf{z}_1 = w\mathbf{z}_2, \quad u\mathbf{z}_3 = w\mathbf{z}_4, \quad uw\mathbf{z}_2 = w^2\mathbf{z}_3 \quad \text{and} \quad u^2\mathbf{z}_2 = uw\mathbf{z}_3.$$

In particular, $\mathbf{t} = u\mathbf{z}_2 - w\mathbf{z}_3$ is a torsion element, and $u\mathbf{t} = w\mathbf{t} = 0$. We then have a short exact sequence

$$0 \longrightarrow \frac{\mathbb{A}}{\langle u, w \rangle_{\mathbb{A}}} \longrightarrow H_*(C) \longrightarrow \mathbb{A}(K) = \langle u^3, u^2w, uw^2, w^3 \rangle_{\mathbb{A}} \longrightarrow 0,$$

which does not split. The chain complex C is an illustration of pieces which may appear in a knot chain complex and make the homology and the unknotting invariants interesting. The next *virtual* example gives another instance of this phenomenon.

Example 5.8. Let $C = C_{i,j}$ denote the chain complex generated over \mathbb{A} by the generators X_1, X_2, Y_1, Y_2 and Z with

$$A(X_1) = -A(X_2) = i, \quad A(Y_1) = -A(Y_2) = j \quad \text{and} \quad A(Z) = 0.$$

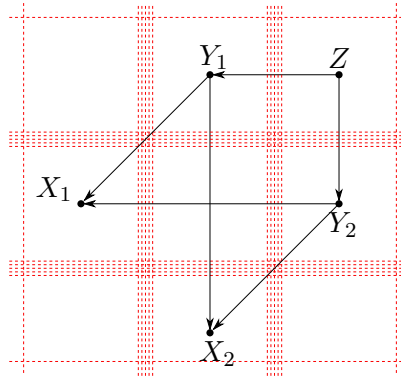
 FIGURE 8. The chain complex $C_{i,j}$.

The differential $d = d_{i,j}$ of C is defined by setting $d(X_1) = d(X_2) = 0$ and

$$d(Y_1) = u^i w^j X_1 + w^{i+j} X_2, \quad d(Y_2) = u^{i+j} X_1 + u^j w^i X_2, \quad d(Z) = u^j Y_1 + w^j Y_2.$$

Figure 8 illustrates this chain complex. We treat $C_{i,j}$ as a direct summand in a knot chain complex, or a *virtual* knot chain complex.

It is then not hard to check that the homology group $\mathbb{H} = \mathbb{H}_{i,j}$ of C is generated by the homology classes $\mathbf{x}_1 = [X_1]$ and $\mathbf{x}_2 = [X_2]$. Furthermore, $\mathbf{t} = u^i x_1 + w^i x_2$ is a torsion element in \mathbb{H} . In fact,

$$w^j \mathbf{t} = [dY_1] = 0 \quad \text{and} \quad u^j \mathbf{t} = [dY_2] = 0.$$

Let us now assume that $\mathfrak{f}^- : \mathbb{H} \rightarrow \mathbb{A}$ and $\mathfrak{f}^+ : \mathbb{A} \rightarrow \mathbb{H}$ are homogeneous maps of degrees m^- and m^+ , respectively. It follows that $\mathfrak{f}^-(\mathbf{x}_1) = w^{m^-+i}$ and $\mathfrak{f}^-(\mathbf{x}_2) = w^{m^-} u^i$, while $\mathfrak{f}^+(1) = w^{m^+-i} \mathbf{x}_1$. But this implies that

$$w^{m^++m^-} \mathbf{x}_2 = \mathfrak{f}^+(\mathfrak{f}^-(\mathbf{x}_2)) = w^{m^++m^-} u^i \mathbf{x}_1 \quad \Rightarrow \quad w^{m^++m^-} \mathbf{t} = 0.$$

In particular, $m^+ + m^- - i \geq j$, or $m^+ + m^- \geq i + j$. In other words, $l(C) \geq i + j$. It is then easy to conclude that $l(C) = i + j$, while $l^-(C) = \nu^-(C) = i$ and $l^+(C) = 0$. Moreover, $\mathfrak{t}(C) = j$. Thus, $C = C_{i,j}$ gives an example with $l(C) = \nu^-(C) + \mathfrak{t}(C)$. It is interesting to note that in this example, $\widehat{\mathfrak{t}}(C_{ij}) = i + j$.

REFERENCES

- [AD] Akram Alishahi and Nathan Dowlin, *The Lee spectral sequence, unknotting number, and the knight move conjecture*, arXiv:1710.07875.
- [AE] Akram Alishahi and Eaman Eftekhary, *Tangle Floer homology and cobordisms between tangles*, ArXiv:1610.07122.
- [AE15] ———, *A refinement of sutured Floer homology*, J. Symplectic Geom. **13** (2015), no. 3, 609–743.
- [Ali] Akram Alishahi, *The Bar-Natan homology and unknotting number*, arXiv:1710.07874.
- [BL16] Maciej Borodzik and Charles Livingston, *Semigroups, d-invariants and deformations of cuspidal singular points of plane curves*, J. Lond. Math. Soc. (2) **93** (2016), no. 2, 439–463.
- [Fel14] Peter Feller, *Gordian adjacency for torus knots*, Algebr. Geom. Topol. **14** (2014), no. 2, 769–793.
- [FPZ18] Peter Feller, Simon Pohlmann, and Raphael Zentner, *Alternation numbers of torus knots with small braid index*, Indiana Univ. Math. J. **67** (2018), no. 2, 645–655.
- [HW16] Jennifer Hom and Zhongtao Wu, *Four-ball genus bounds and a refinement of the Ozsváth-Szabó tau invariant*, J. Symplectic Geom. **14** (2016), no. 1, 305–323.
- [KM93] Peter B. Kronheimer and Tomasz S. Mrowka, *Gauge theory for embedded surfaces. I*, Topology **32** (1993), no. 4, 773–826.
- [Krc] David Kratovich, *Software for CFK^∞ of $1 - 1$ knots*, <https://math.rice.edu/~dk27/cfk11.html>.
- [Lac] Marc Lackenby, *Elementary knot theory*, arXiv:1604.03778.
- [Lev69] Jerome P. Levine, *Knot cobordism groups in codimension two*, Comment. Math. Helv. **44** (1969), 229–244.
- [OS03] Peter Ozsváth and Zoltán Szabó, *Knot Floer homology and the four-ball genus*, Geom. Topol. **7** (2003), 615–639.
- [OS04] Peter Ozsváth and Zoltán Szabó, *Holomorphic disks and knot invariants*, Adv. Math. **186** (2004), no. 1, 58–116.
- [OS05] Peter Ozsváth and Zoltán Szabó, *On knot Floer homology and lens space surgeries*, Topology **44** (2005), no. 6, 1281–1300.
- [OSS17] Peter S. Ozsváth, András I. Stipsicz, and Zoltán Szabó, *Concordance homomorphisms from knot Floer homology*, Adv. Math. **315** (2017), 366–426.
- [Ras05] Jacob Rasmussen, *Knot polynomials and knot homologies*, Geometry and topology of manifolds, Fields Inst. Commun., vol. 47, Amer. Math. Soc., Providence, RI, 2005, pp. 261–280.
- [Ras10] ———, *Khovanov homology and the slice genus*, Invent. Math. **182** (2010), no. 2, 419–447.
- [Sch85] Martin G. Scharlemann, *Unknotting number one knots are prime*, Invent. Math. **82** (1985), no. 1, 37–55.
- [Tri69] A. G. Tristram, *Some cobordism invariants for links*, Proc. Cambridge Philos. Soc. **66** (1969), 251–264.
- [Zem] Ian Zemke, *Link cobordisms and absolute gradings on link Floer homology*, arXiv:1701.03454.

DEPARTMENT OF MATHEMATICS, COLUMBIA UNIVERSITY, NEW YORK, NY 10027

E-mail address: alishahi@math.columbia.edu

SCHOOL OF MATHEMATICS, INSTITUTE FOR RESEARCH IN FUNDAMENTAL SCIENCES (IPM), P. O. BOX 19395-5746, TEHRAN, IRAN

E-mail address: eaman@ipm.ir