

On the Complexity of Solution Extension of Optimization Problems

Katrin Casel², Henning Fernau³, Mehdi Khosravian Ghadikolaei¹, Jérôme Monnot¹, and Florian Sikora¹

¹Université Paris-Dauphine, PSL University, CNRS, LAMSADE, 75016 Paris, France,

{mehdi.khosravian-ghadikolaei, jerome.monnot, florian.sikora}@dauphine.fr

²Hasso Plattner Institute, University of Potsdam, Potsdam, Germany, casel@informatik.uni-trier.de

³Universität Trier, Fachbereich 4, Informatikwissenschaften, CIRT,, Theoretische Informatik, D-54286 Trier, Germany, fernau@informatik.uni-trier.de

Abstract

The question if a given partial solution to a problem can be extended reasonably occurs in many algorithmic approaches for optimization problems. For instance, when enumerating minimal dominating sets of a graph $G = (V, E)$, one usually arrives at the problem to decide for a vertex set $U \subseteq V$, if there exists a *minimal* dominating set S with $U \subseteq S$. We propose a general, partial-order based formulation of such extension problems and study a number of specific problems which can be expressed in this framework. Possibly contradicting intuition, these problems tend to be NP-hard, even for problems where the underlying optimisation problem can be solved in polynomial time. This raises the question of how fixing a partial solution causes this increase in difficulty. In this regard, we study the parameterised complexity of extension problems with respect to parameters related to the partial solution, as well as the optimality of simple exact algorithms under the Exponential-Time Hypothesis. All complexity considerations are also carried out in very restricted scenarios, be it degree restrictions or topological restrictions (planarity) for graph problems or the size of the given partition for the considered extension variant of BIN PACKING.

1 Introduction and Motivation

The very general problem of determining the quality of a given partial solution occurs basically in every algorithmic approach which computes solutions in some sense gradually. Pruning search-trees, proving approximation guarantees or the efficiency of enumeration strategies usually requires a suitable way to decide if a partial solution is a reasonable candidate to pursue. Consider for example the classical concept of minimal dominating sets for graphs. The task of finding a maximum cardinality minimal dominating set (or an approximation of it) as well as enumerating all minimal dominating sets naturally leads to solving the following extension problem: Given a graph $G = (V, E)$ and a vertex set $U \subseteq V$, does there exist a *minimal* dominating set S with $U \subseteq S$.

In this paper, we want to consider these kinds of subproblems which we call *extension problems*. Informally, in an extension version of a problem, we will be given in the input a partial solution to be extended into a *minimal* or a *maximal* solution for the problem (but not necessarily to a solution of globally minimum or maximum value). Extension problems as studied in this paper are

encountered in many situations when dealing with classical decision problems, say, with VERTEX COVER.

- When running a search tree algorithm, usually parts of the constructed solution are fixed. It is highly desirable to be able to prune branches of the search tree as early as possible. Hence, it would be very nice to tell (in polynomial time) if such a solution part (that we will call a *pre-solution* below) can be part of a minimal vertex cover.
- The consideration of the previous item is valid both if we look for a minimum vertex cover (or, as a decision variant, for a vertex cover of a size upper-bounded by a given number k), or if we look for a minimal vertex cover of maximum size (or, for a minimal vertex cover lower-bounded by a given number k).
- The same type of reasoning is true if one likes to enumerate or count all minimal vertex covers or similar structures [10, 11, 12, 16, 22, 26, 33, 35]. It was this scenario where the question of complexity was asked for VERTEX COVER EXTENSION in [16].
- More generally, the question of finding extensions to minimal solutions was encountered in the context of proving hardness results for (efficient) enumeration algorithms for Boolean formulae, in the context of matroids and similar situations; see [11, 26].
- The following question was already asked in 1956 by Kurt Gödel in a famous letter to Joh(an)n von Neumann [36]: *It would be interesting to know, . . . how strongly in general the number of steps in finite combinatorial problems can be reduced with respect to simple exhaustive search.* The mentioned pruning of search branches and hence the question of finding (pre-)solution extensions lies at the heart of this question.
- Extensions also play some role in approaches for polynomial-time approximation schemes.

This paper is not the first one to consider extension problems, yet it proposes a general framework to host this type of problems. In [11], it is shown that this kind of extension of partial solutions is NP-hard for the problem of computing prime implicants of the dual of a Boolean function; a problem which can also be seen as the problem of finding a minimal hitting set for the set of prime implicants of the input function. Interpreted in this way, the proof from [11] yields NP-hardness for the minimal extension problem for 3-HITTING SET. This result was extended in [3] to prove NP-hardness for the extension of minimal dominating sets (denoted by EXT DS here), even when restricted to planar cubic graphs. Similarly, it was shown in [2] that extension for minimum vertex cover (EXT VC) is NP-hard, even restricted to planar cubic graphs. However, we are not aware of a *systematic* study of this type of problems.

In an attempt to study the nature of such extension tasks, we propose a general framework to express a broad class of what we refer to as extension problems. This framework is based on a partial order approach, reminiscent of what has been endeavored for *maximin* problems in [30]. In essence, we consider optimisation problems in NPO with an additionally specified set of partial solutions which we call *pre-solutions* (including the set of solutions) and a partial order on those. This partial order \leq reflects not only the notion of *extension* but also of *minimality* as follows. For a pre-solution U and a solution S , S *extends* U if $U \leq S$. A solution S is *minimal*, if there exists no solution $S' \neq S$ with $S' \leq S$. The resulting extension problem is formally defined as the task to decide for a given pre-solution U , if there exists a minimal solution S which extends U .

We systematically study the complexity of extension problems of quite a number of classical problems which fit into our framework. Interestingly, extension variants tend to be NP-hard, even if the underlying classical optimization problem is solvable in polynomial time. We encountered this observation, for instance, in connection with MAXIMUM MATCHING. We also study the parameterized complexity of these problems, in particular under the parameterization of the size (or more general the value) of the fixed pre-solution or of its complement, as well as the complexity of

extension problems assuming that the Exponential Time Hypothesis (ETH) holds¹. Further, for the graph problems considered here, we discuss the restriction to planar graphs, as for a certain argument to obtain PTAS for this restricted graph class, pioneered by Baker [1], it is important to know if solutions computed for certain parts of the graph can be (easily) extended to a solution of the overall instance. Due to space limitations, many technical proofs have been moved to an appendix.

2 A General Framework of Extension Problems and Notation

We use standard notations from graph theory and only deal with undirected simple graphs that can be specified as $G = (V, E)$. A subgraph $G' = (V', E')$ of G is a partial graph if $V' = V$. If $U \subseteq V$, then $G[U]$ denotes the subgraph induced by U . For $X \subseteq E$, $G[X]$ denotes the graph (V, X) and $V(X)$ denotes the set of vertices incident to edges in X .

In order to formally define our concept of minimal extension, we define what we call *monotone problems* which can be thought of as problems in NPO with the addition of a set of pre-solutions (which includes the set of solutions) together with a partial ordering on this new set. Formally we define such problems as 5-tuples $\Pi = (\mathcal{I}, \text{presol}, \text{sol}, \leq, m)$ (where $\mathcal{I}, \text{sol}, m$ with an additional *goal* $\in \{\min, \max\}$ yields an NPO problem) defined by:

- \mathcal{I} is the set of instances, recognizable in polynomial time.
- For $I \in \mathcal{I}$, $\text{presol}(I)$ is the set of *pre-solutions* and, in a reasonable representation of instances and pre-solutions, the length of the encoding of any $y \in \text{presol}(I)$ is polynomially bounded in the length of the encoding of I .
- For $I \in \mathcal{I}$, $\text{sol}(I)$ is the *set of solutions*, which is a subset of $\text{presol}(I)$.
- There exists an algorithm which, given (I, y) , decides in polynomial time if $y \in \text{presol}(I)$; similarly there is an algorithm which decides in polynomial time if $y \in \text{sol}(I)$.
- For $I \in \mathcal{I}$, \leq_I is a partial ordering on $\text{presol}(I)$ and there exists an algorithm that, given an instance I and $y, z \in \text{presol}(I)$, can decide in polynomial time if $y \leq_I z$.
- For each $I \in \mathcal{I}$, the set of solutions $\text{sol}(I)$ is upward closed with respect to the partial ordering \leq_I , i.e., $U \in \text{sol}(I)$ implies $U' \in \text{sol}(I)$ for all $U, U' \in \text{presol}(I)$ with $U \leq_I U'$.
- m is a polynomial-time computable function which maps pairs (I, x) with $I \in \mathcal{I}$ and $x \in \text{presol}(I)$ to non-negative rational numbers; $m(I, x)$ is the *value of x* .
- For $I \in \mathcal{I}$, $m(I, \cdot)$ is *monotone* with respect to \leq_I , meaning that the property $y \leq_I z$ for some $y, z \in \text{presol}(I)$ either always implies $m(I, y) \leq m(I, z)$ or $m(I, y) \geq m(I, z)$.

The requirement that the set of solutions is upward closed with respect to the partial ordering relates to *independence systems*, see [34].

Given a monotone problem $\Pi = (\mathcal{I}, \text{presol}, \text{sol}, \leq, m)$, we denote by $\mu(\text{sol}(I))$ the set of *minimal feasible solutions of I* , formally given by

$$\mu(\text{sol}(I)) = \{S \in \text{sol}(I) : ((S' \leq_I S) \wedge (S' \in \text{sol}(I))) \rightarrow S' = S\}.$$

Further, given $U \in \text{presol}(I)$, we define $\text{ext}(I, U) = \{U' \in \mu(\text{sol}(I)) : U \leq_I U'\}$ to be the set of *extensions of U* . Sometimes, $\text{ext}(I, U) = \emptyset$, which makes the question of the existence of such

¹ETH is a conjecture asserting that there is no $2^{o(n)}$ (i.e., no sub-exponential) algorithms for solving 3-SAT, where n is the number of variables; the number of clauses is somehow subsumed into this expression, as this number can be assumed to be sub-exponential in n (after applying the famous sparsification procedure); cf. [23].

extensions interesting. Hence, finally, the *extension problem* for Π , written EXT Π , is defined as follows: An instance of EXT Π consists of an instance $I \in \mathcal{I}$ together with some $U \in \text{presol}(I)$, and the associated decision problem asks if $\text{ext}(I, U) \neq \emptyset$.

Although we strongly linked monotone problems to NPO, the corresponding extension problems do not generally belong to NP (in contrast to the decision problems associated to NPO problems). Consider the monotone problem $\Pi_\tau = (\mathcal{I}, \text{presol}, \text{sol}, \leq, m)$ with:

- $\mathcal{I} = \{F: F \text{ is a Boolean formula}\}$.
- For a formula $F \in \mathcal{I}$ on n variables, $\text{presol}(F) = \text{sol}(F) = \{\phi \mid \phi: \{1, \dots, n\} \rightarrow \{0, 1\}\}$.
- For $\phi, \psi \in \text{presol}(F)$, $\phi \leq_F \psi$ if either $\phi = \psi$, or assigning variables according to ψ satisfies F while an assignment according to ϕ does not.
- $m \equiv 1$ (plays no role for the extension problem)

The associated extension problem EXT Π_τ corresponds to the co-NP-complete TAUTOLOGY PROBLEM in the following way: Given a Boolean formula F which, w.l.o.g., is satisfied by the all-ones assignment $\psi_1 \equiv 1$, it follows that (F, ψ_1) is a *yes*-instance for EXT Π_τ if and only if F is a tautology, as ψ_1 is in $\mu(\text{sol}(F))$ if and only if there does not exist some $\psi_1 \neq \phi \in \text{sol}(F)$ with $\phi \leq_F \psi_1$, so, by definition of the partial ordering, an assignment ϕ which does not satisfy F . Consequently EXT Π_τ is not in NP, unless co-NP = NP.

Let us mention some monotone graph problems, for which \mathcal{I} is the set of undirected graphs, denoting instances by $I = (V, E)$, and $m(I, U) = |U|$ for all $U \in \text{presol}(I)$:

- VERTEX COVER (VC): $\leq_{I=\subseteq}$, $\text{presol}(I) = 2^V$, $C \in \text{sol}(I)$ iff each $e \in E$ is incident to at least one $v \in C$;
- EDGE COVER (EC): $\leq_{I=\subseteq}$, $\text{presol}(I) = 2^E$, $C \in \text{sol}(I)$ iff each $v \in V$ is incident to at least one $e \in C$;
- INDEPENDENT SET (IS): $\leq_{I=\supseteq}$, $\text{presol}(I) = 2^V$, $S \in \text{sol}(I)$ iff $G[S]$ contains no edges;
- EDGE MATCHING (EM): $\leq_{I=\supseteq}$, $\text{presol}(I) = 2^E$, $S \in \text{sol}(I)$ iff none of the vertices in V is incident to more than one edge in S ;
- DOMINATING SET (DS): $\leq_{I=\subseteq}$, $\text{presol}(I) = 2^V$, $D \in \text{sol}(I)$ iff $N[D] = V$;
- EDGE DOMINATING SET (EDS): $\leq_{I=\subseteq}$, $\text{presol}(I) = 2^E$, $D \in \text{sol}(I)$ iff each edge belongs to D or is adjacent to some $e \in D$.

We hence arrive at problems like EXT VC (or EXT IS, resp.), where the instance is specified by a graph $G = (V, E)$ and a vertex set U , and the question is if there is some *minimal* vertex cover $C \supseteq U$ (or some *maximal* independent set $I \subseteq U$). Notice that the instance (G, \emptyset) of EXT VC can be solved by a greedy approach that gradually adds vertices, starting from \emptyset as a feasible solution, until this is no longer possible without violating feasibility (since we do not request the solution to be *minimum*). Similarly, (G, V) is an easy instance of EXT IS. We will show that this impression changes for other instances.

So far, it might appear that only few examples exist for defining instance orderings \leq_I . The reader is referred to [30] as a rich source of further instance orderings. Let us mention one other example. *Bin Packing*. Here, we make use of the well-known partition ordering. The underlying optimization problem is BIN PACKING, or BP for short, formalized as follows. The input consists of a set $X = \{x_1, \dots, x_n\}$ of items and a weight function w that associates rational numbers $w(x_i) \in (0, 1)$ to items. A feasible solution is a partition π of X such that, for each set $Y \in \pi$, $\sum_{y \in Y} w(y) \leq 1$. The traditional aim is to find a feasible π such that $|\pi|$ is minimized. Now, $\text{presol}(X)$ collects all partitions of X . For two partitions π_1, π_2 of X , we write $\pi_1 \leq_X \pi_2$ if π_2 is a

Ext. of	EC	EM	DS	EDS	BP
Param.	FPT	FPT	W[3]-complete	W[1]-hard	para-NP-hard
dual	FPT	FPT	FPT	FPT	FPT

Table 1: Survey on parameterized complexity results for extension problems

refinement of π_1 , i.e., π_2 can be obtained from π_1 by splitting up its sets into a larger number of smaller sets. Hence, $\{X\}$ is the smallest partition with respect to \leq_X . As a partition π is a set, we can measure its size by its cardinality. Clearly, the set of solutions is upward closed. Now, a solution is minimal if merging any two of its sets into a single set yields a partition π such that there is some $Y \in \pi$ with $w(Y) := \sum_{y \in Y} w(y) > 1$. In the extension variant, we are given a partition π_U of X (together with X and w) and ask if there is any minimal feasible partition π'_U with $\pi_U \leq_X \pi'_U$. This describes the problem EXT BP. One could think of encoding knowledge about which items should not be put together in one bin within the given partition π_U .

Further, we discuss the parameterized complexity of several extension problems, where we define the *standard parameter* for an extension problem EXT Π for a monotone problem $\Pi = (\mathcal{I}, \text{presol}, \text{sol}, \leq, m)$ to be the value of the given pre-solution, i.e., the parameter for instance (I, U) of EXT Π is $m(U)$. Accordingly, for dual parameterization, we consider the difference of the value of the given pre-solution to the maximum $m_{\max}(I) := \max\{m_I(y) : y \in \text{presol}(I)\}$, so the parameter for instance (I, U) of EXT Π is $m_{\max}(I) - m(U)$.

Summary of Results For all problems that we consider, we obtain NP-completeness results, for graph problems even when restricted to planar bipartite graphs of maximum degree three. Clearly, we know that these hardness results are optimal with respect to the degree bound. Observe that extension problems can behave quite differently from the classical (underlying) decision problems with respect to (in-)tractability. For instance, EC is solvable in polynomial time, while EXT EC is NP-hard. We also study this phenomenon more in depth by defining generalizations of edge cover and matching problems such that the simple optimization problems can be solved in polynomial time, while the extension variants are NP-hard. All our NP-hardness results translate into ETH-hardness results, as well. All ETH-hardness results are matched by corresponding algorithmic results. We further obtain parameterized complexity results as surveyed in Table 1. The hardness results for graph problems contained in this table also hold for the restriction to bipartite graph instances.

3 NP-Completeness Results

In this section, we present computational complexity results for some well known graph problems. Most results are reductions from one of the following two variants of satisfiability. The first is 2-BALANCED 3-SAT, denoted by $(3, B2)$ -SAT. An instance $I = (\mathcal{C}, \mathcal{X})$ of $(3, B2)$ -SAT is a set \mathcal{C} of CNF clauses defined over a set \mathcal{X} of Boolean variables such that each clause has exactly 3 literals, and each variable appears exactly 4 times in \mathcal{C} , twice negated and twice unnegated. The bipartite graph associated to instance $I = (\mathcal{C}, \mathcal{X})$ is $BP = (C \cup X, E(BP))$ with $C = \{c_1, \dots, c_m\}$, $X = \{x_1, \dots, x_n\}$ and $E(BP) = \{c_j x_i : x_i \text{ or } \neg x_i \text{ is literal of } c_j\}$. $(3, B2)$ -SAT is NP-complete by [4, Theorem 1]. The other problem used in our reductions is 4-BOUNDED PLANAR 3-CONNECTED SAT (4P3C3SAT for short), the restriction of EXACT 3-SATISFIABILITY to clauses in \mathcal{C} over variables in \mathcal{X} , where each variable occurs in at most four clauses (at least one time negated and one time unnegated) and the associated bipartite graph BP is planar of maximum degree 4. This restriction is also NP-complete [27].

Let us summarize our findings in the following statement.

Theorem 1. Let $\mathcal{P} \in \{\text{EC}, \text{EM}, \text{DS}, \text{EDS}\}$. Then, $\text{EXT } \mathcal{P}$ is NP-complete on bipartite graphs of maximum degree 3.

We make one of the possibly most surprising results explicit, as the underlying optimization problem is well-known to be polynomial-time solvable. Not only in this case, there are additional properties that graph instances might satisfy, still maintaining NP-hardness.

Theorem 2. EXT EC is NP-complete on bipartite graphs of maximum degree 3, even if the given pre-solution forms an edge matching.

Proof. We reduce from (3, B2)-SAT, so let \mathcal{I} be an instance of (3, B2)-SAT with clauses $\mathcal{C} = \{c_1, \dots, c_m\}$ and variables $\mathcal{X} = \{x_1, \dots, x_n\}$.

From the bipartite graph BP associated to \mathcal{I} , we build a graph $G = (V, E)$ by splitting every vertex $x_i \in X$ by a P_5 denoted $P_i = (x_i, l_i, m_i, r_i, \neg x_i)$ where now x_i (resp., $\neg x_i$) is linked to c_j if x_i appears unnegated (resp., negated) in c_j (see Figure 1). It is easy to see that G is bipartite of maximum degree 3. Finally, let $U = \{x_i l_i, \neg x_i r_i : 1 \leq i \leq n\}$. We claim that \mathcal{I} is satisfiable iff G admits a minimal edge cover containing U .

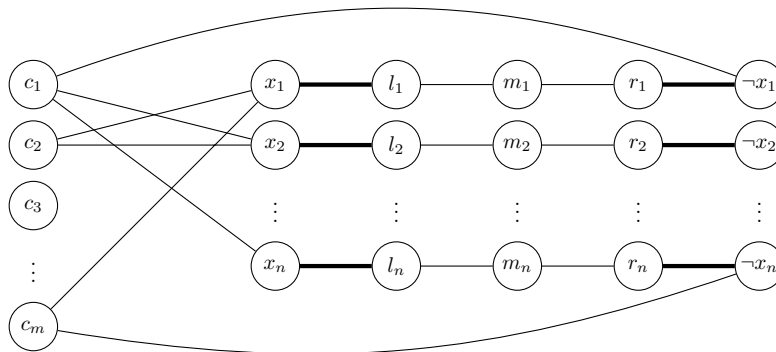

Figure 1: The graph $G = (V, E)$ for EXT EC built from \mathcal{I} with $m + 5n$ vertices and $3m + 4n$ edges. Edges of U are drawn bold. In this example, $c_1 = \{\neg x_1, x_2, x_n\}$.

Assume \mathcal{I} is satisfiable and let T be a truth assignment which satisfies all clauses. For each clause c_j , let $f(j)$ be an index such that variable $x_{f(j)}$ satisfies clause c_j for T and let $J = [n] \setminus f([m])$ be the indices not used by mapping f . We set

$$\begin{aligned} S = & \{x_{f(j)}c_j, m_{f(j)}r_{f(j)} : T(x_{f(j)}) = \text{true}, x_{f(j)} \text{ appears positively in } c_j\} \\ & \cup \{\neg x_{f(j)}c_j, m_{f(j)}l_{f(j)} : T(x_{f(j)}) = \text{false}, x_{f(j)} \text{ appears negatively in } c_j\} \\ & \cup U \cup \{m_i r_i : i \in J\}. \end{aligned}$$

We can easily check that S is a minimal edge cover containing U .

Conversely, assume that G has a minimal edge cover S containing U . In order to cover vertex m_i for each $i \in \{1, \dots, n\}$, the edge cover S contains either $l_i m_i$ or $r_i m_i$ (not both by minimality). This means that if we set $T(x_i) = \text{true}$ if $r_i m_i \in S$ and $T(x_i) = \text{false}$ if $l_i m_i \in S$, we obtain a valid assignment T . This assignment satisfies all clauses of \mathcal{I} , since S must cover all vertices of C . ■

Discussing the complexity of EXT BP requires a quite different approach. We reduce from 3-PARTITION which asks for a given multiset $S = \{s_1, \dots, s_{3m}\}$ of integers and $b \in \mathbb{N}$ if S can be partitioned into m triples such that the sum of each subset equals b . 3-PARTITION is NP-complete even if $b/4 < s_i < b/2$ for each $i \in \{1, \dots, 3m\}$, see [21]. As corresponding EXT BP instance we build the set $X = \{x_0, x_1, \dots, x_{3m}\}$ with weights $w(x_0) = \frac{m}{m+1}$ and $w(x_i) = \frac{s_i}{b}$ for each $1 \leq i \leq 3m$ and set $\pi_U = \{\{x_0\}, \{x_1, \dots, x_{3m}\}\}$ as a partial partition of X . It can be shown that (S, b) is a yes-instance of 3-PARTITION if and only if (X, π_U) is a yes-instance of EXT BP which yields:

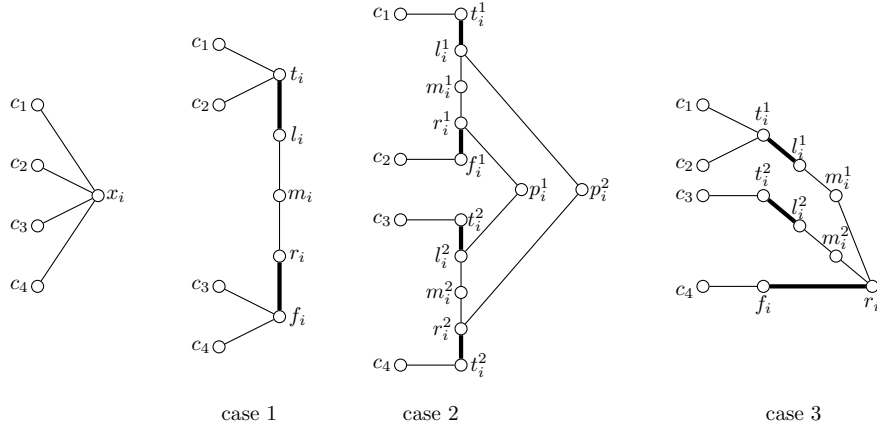

Figure 2: Construction for EXT EC (planar). On the left: A variable x_i appearing in four clauses c_1, c_2, c_3, c_4 in I . On the right, cases 1, 2, 3: The gadgets $H(x_i)$ in the constructed instance depend on how x_i appears (negated or non-negated) in the four clauses. Bold edges denote elements of U .

Theorem 3. EXT BP is NP-hard, even if the pre-solution π_U contains only two sets.

Planar Graphs

The following statement appears to be only strengthening Theorem 1, but the details behind can be different indeed. We exemplify this by one concrete example theorem.

Theorem 4. Let $\mathcal{P} \in \{\text{EC}, \text{EM}, \text{DS}, \text{EDS}\}$. Then, EXT \mathcal{P} is NP-complete on planar bipartite graphs of maximum degree 3.

All reductions are from 4P3C3SAT. This gives us a planar *vertex-clause-graph* G , corresponding to the original SAT instance I . The additional technical difficulties come with the embeddings that need to be preserved. Suppose that a variable x_i appears in at most four clauses c_1, c_2, c_3, c_4 of I such that in the induced (embedded) subgraph $G_i = G[\{x_i, c_1, c_2, c_3, c_4\}]$, $c_1x_i, c_2x_i, c_3x_i, c_4x_i$ is an anti-clockwise ordering of edges around x_i . By looking at G_i and considering how variable x_i appears negated or non-negated in the four clauses c_1, c_2, c_3, c_4 in I , the construction should handle the 3 following cases:

- case 1: $x_i \in c_1, c_2$ and $\neg x_i \in c_3, c_4$,
- case 2: $x_i \in c_1, c_3$ and $\neg x_i \in c_2, c_4$,
- case 3: $x_i \in c_1, c_2, c_3$ and $\neg x_i \in c_4$.

All other cases are included in these 3 cases by rotations and / or interchanging x_i with $\neg x_i$. We illustrate how these cases are used in the reductions explicitly for EXT EC. While the interconnections of the clause gadgets and the variable gadgets are similar to the non-planar case, the variable gadgets differ according to the cases listed above, see Figure 2.

4 Parameterized Perspective

For notions undefined in this paper, we refer to the textbook [17]. Generally, our model for extension allows for problems which are not in NP, which is due to the difficulty of deciding minimality, i.e., checking if $S \in \mu(\text{sol}(I))$ for $S \in \text{sol}(I)$. For the specific problems we discuss here

however, minimality can obviously always be tested efficiently. From our parameterized perspective, this immediately yields membership in FPT for all cases where the set of $S \in \text{presol}(I)$ with $U \leq_I S$ can be enumerated in a function in the parameter.

As $U \leq_I S$ means $U \supseteq S$ for EXT EM, it follows that we only have to consider the $2^{|U|} = 2^{m(U)}$ subsets of U as candidates for a minimal extension of U , which yields:

Corollary 5. EXT EM with standard parameter is in FPT.

As we can list all supersets of a given set $U \subseteq X$ in time $O(2^{|X|-|U|})$, and similarly all partitions of X refining a given partition π_U in time $O(c^{|X|-|\pi_U|})$, we also get the following (observe that for a graph instance $I = (V, E)$ we have $m_{\max}(I) = |V|$ for EXT EC and EXT DS and $m_{\max}(I) = |E|$ for EXT EDS and that $P = \{\{x\}: x \in X\}$ gives the partition of X of value $|X|$ which gives the maximum for dual parametrization of EXT BP):

Corollary 6. EXT EC, EXT DS, EXT EDS and EXT BP with dual parameter are in FPT.

In the following we derive a less obvious FPT membership result which is based on enumeration of minimal vertex covers; see [16]. We discuss EXT EM where it is sometimes more convenient to think about this problem as follows: Given a graph $G = (V, E)$ and an edge set A , does there exist an inclusion-wise maximal matching M (given as a set of edges) of G that avoids A , i.e., $M \cap A = \emptyset$. With dual parameterization the parameter then is $|A|$. Assume there is a maximal matching M of G such that $M \cap A = \emptyset$, then the next property is quite immediate but very helpful.

Lemma 7. $V(M) \cap V(A)$ is a vertex cover of $G'' = (V, A)$.

In order to use this observation, we need the following construction to compute matchings according to a fixed vertex cover. For a minimal vertex cover S of $G'' = (V, A)$, let (G', w^S) be the edge-weighted graph defined as follows: For $v \in V$, $d^S(v) = 1$ if $v \notin S$, and $d^S(v) = |E| + 1$ if $v \in S$. We define w^S , the edge weight, by: $w^S(e) = d^S(x) + d^S(y)$ for $e = xy \in E \setminus A$. This way, we link the profit of an edge in a weighted matching for (G', w^S) to how much it covers of the vertex cover S of $G'' = (V, A)$, which formally yields:

Theorem 8. There is a maximal matching M of G such that $M \cap A = \emptyset$ if and only if there is a minimal vertex cover S of G'' such that the maximum weighted matching of (G', w^S) is at least $|S|(|E| + 1)$.

Using the characterization given in Theorem 8, the following result follows simply from enumerating all minimal vertex covers of G'' .

Theorem 9. EXT EM with dual parameter is in FPT.

MINIMUM HITTING SET as NPO problem is defined by instances $I = (X, \mathcal{S})$ where X is a finite ground set and $\mathcal{S} = \{S_1, \dots, S_m\}$ is a collection of sets $S_i \subseteq X$ (usually referred to as *hyperedges*) and feasible solutions are subsets $H \subseteq X$ such that $H \cap S_i \neq \emptyset$ for all $i \in \{1, \dots, m\}$. In [6] the associated extension problem, where pre-solutions are all subsets $U \subseteq X$, the partial ordering is set-inclusion, in the following referred to as EXT HS, appears as a subproblem for the enumeration of minimal hitting sets in lexicographical order and EXT HS is there shown to be W[3]-complete with respect to the standard parameter $m(I, U) = |U|$. By a slight adjustment of the classical reduction from the hitting set problem to DOMINATING SET, this result transfers and formally yields:

Theorem 10. EXT DS with standard parameter is W[3]-complete, even when restricted to bipartite instances.

To show that EXT EDS is not likely to be FPT by standard parameterization, we designed a reduction from EXT VC which is shown to be W[1]-complete in [13].

Theorem 11. *EXT EDS with standard parameter is W[1]-hard, even when restricted to bipartite instances.*

Since edge domination can be seen as vertex domination on line graphs, the W[3]-membership of EXT DS transfers to EXT EDS. It remains open where EXT EDS exactly belongs in the W hierarchy, as we were not able to place it in W[2] or even W[1] or to show W[3]-hardness.

Discussing treewidth The crucial combinatorial properties of many classical decision problems can be expressed in monadic second order logic (MSO), or counting variants thereof, the actual characterization of the property can be often even written in FO. This is well known for the problems considered in this paper. For instance, $\text{Cov}(C) := \forall x, y (\text{adj}(x, y) \rightarrow (x \in C \vee y \in C))$ says that C is a vertex cover. Based on such a formula, it is also possible to express inclusion-wise minimality or maximality (the most important cases for our paper). For instance,

$$\mu\text{-Cov}(C) := \forall x, y (\text{adj}(x, y) \rightarrow (x \in C \vee y \in C)) \wedge \forall x \in C \exists y (\text{adj}(x, y) \wedge y \notin C)$$

says that C is a minimal vertex cover. The fact that C is superset of a given set U can be easily expressed by an implication. Also see [15, Sec. 7.4.2]. Hence, we state:

Proposition 12. *All extension graph problems considered in this paper can be written as MSO formulae. Hence, applying Courcelle's theorem, these decision problems, parameterized by treewidth, are in FPT.*

We can also state the following result which does not use the previous meta-theorem:

Proposition 13. *For each of the graph extension problems P discussed in this paper, there is a constant c_P such that P can be solved in time $\mathcal{O}^*(c_P^t)$ on graphs of treewidth at most t .*

5 Optimal Exact Algorithms under the Exponential Time Hypothesis

Due to Proposition 13, we can also see that all our extension graph problems can be solved in time $\mathcal{O}(c_P^n)$ for some problem- P specific constant c_P . As planar graphs of order n have treewidth $\mathcal{O}(\sqrt{n})$, Proposition 13 yields the following result.

Corollary 14. *Each of our extension graph problems can be solved in time $\mathcal{O}(2^{\mathcal{O}(\sqrt{n})})$ on planar graphs of order n .*

For EXT BP, the situation is a bit more complicated. The validity of the dynamic programming algorithm that we designed depends on a somewhat special combinatorial characterization of minimal solutions. Namely, a partition solution π is minimal if and only if there is a constant $0 < \delta < 1/2$ such that for the two bins (sets) $X_1, X_2 \in \pi$ of smallest weight, with $w(X_1) \leq w(X_2)$, $w(X_1) > \delta$ and $w(X_2) \geq 1 - \delta$.

Theorem 15. *EXT BP with n items can be solved in time $\mathcal{O}^*(6^n)$, using space $\mathcal{O}^*(3^n)$.*

The Exponential Time Hypothesis (ETH) was introduced to provide evidence for lower bounds on exponential-time algorithms; see [23, 25, 29]. Now, if we look at the construction proving NP-hardness of (3, B2)-SAT [4, Theorem 1], it is clear that these transformations blow up the instance by a constant factor only. Hence, we can state:

Lemma 16. *Assuming ETH, there is no $2^{\mathcal{O}(n+m)}$ -algorithm for solving n -variable, m -clause instances of (3, B2)-SAT.*

As all our reductions, starting out from (3, B2)-SAT, are blowing up the size of the instances only in a linear fashion, we can immediately conclude:

Theorem 17. *Let $\mathcal{P} \in \{\text{EC}, \text{EM}, \text{DS}, \text{EDS}\}$. There is no $2^{o(n+m)}$ -algorithm for n -vertex, m -edge bipartite instances of maximum degree 3 of $\text{EXT } \mathcal{P}$, unless ETH fails.*

For planar graphs, the situation is a bit more involved. Kratochvíl’s construction for showing NP-hardness of 4P3C3SAT is based on Lichtensteins’s [28] and offers a quadratic blow-up in total, compared to 3SAT itself.

Proposition 18. *There is no algorithm that solves 4P3C3SAT on instances with n variables and m clauses in time $2^{o(\sqrt{n+m})}$, unless ETH fails.*

Corollary 19. *For any graph extension problem studied in this paper, there is no $2^{o(\sqrt{n})}$ algorithm for solving planar instances of order n , unless ETH fails.*

EXT BP delivers a nice example that it is not always that easy to take the textbook construction from Garey and Johnson for NP-hardness to immediately get hardness results under ETH that match existing algorithms. According to [24, Corollary 3.2], there is no algorithm deciding 4-PARTITION with n items in time $2^{o(n)} \times |I|^{O(1)}$, unless ETH fails. As we can adapt our reduction from Theorem 3 to reduce from this problem, we can formulate:

Corollary 20. *Assuming ETH, EXT BP with n items cannot be solved in time $2^{o(n)}$.*

In conclusion, all exact algorithms we considered are optimal under ETH.

6 Generalizations of Matching and Edge Cover Problems

In this section, we want to consider more general versions of matchings and edge covers of a graph. A partial subgraph $G' = (V, S)$ of $G = (V, E)$ is called r -degree constrained if the maximum degree of G' is upper-bounded by r . The case $r = 1$ corresponds to a matching. A maximum r -degree constrained partial subgraph can be found in polynomial time [20]. Here, we are interested in the corresponding extension variant, called EXT r -DCPS.

Theorem 21. *For every fixed $r \geq 2$, EXT r -DCPS is NP-complete in bipartite graphs with maximum degree $r + 1$, even if the set of forbidden edges induces a matching.*

On the positive side, it is also possible to generalize the FPT-result from Section 4:

Theorem 22. *EXT r -DCPS with dual parameter is in FPT.*

This generalization of Theorem 9 is not at all trivial, it combines the previous idea of listing minimal vertex covers with solving the weighted version of MAX r -DCPS on an auxiliary graph.

Similarly, we can generalize the notion of edge cover. A partial subgraph G' of a given graph G is called r -edge cover if the minimum degree of G' is lower-bounded by r . A problem called MIN LOWER-UPPER-COVER PROBLEM, or MINLUCP for short, generalizes the problem of finding an r -edge cover of minimum size and can be solved in polynomial time [34]. The optimization variant of MINLUCP is: given $G = (V, E)$ and two non-negative functions a, b from V such that $\forall v \in V$, $0 \leq a(v) \leq b(v) \leq d_G(v)$, find a subset $M \subseteq E$ such that the partial graph $G[M] = (V, M)$ induced by M satisfies $a(v) \leq d_{G[M]}(v) \leq b(v)$ (such a solution is called a *lower-upper-cover*), minimizing its total size $|M|$ among all such solutions (if any). An r -EC solution corresponds to a lower-upper-cover with $a(v) = r$ and $b(v) = d_G(v)$ for every $v \in V$. Our name for the extension variant thereof is EXT r -EC.

Theorem 23. *For every fixed $r \geq 1$, EXT r -EC is NP-complete in bipartite graphs with maximum degree $r + 2$, even if the pre-solution is an induced matching.*

We exploit a combinatorial relationship between EXT r -EC and MINLUCP to show:

Theorem 24. *EXT r -EC with standard parameter is in FPT.*

7 Conclusions

In this paper, we introduced a general framework to model extension for monotone problems with the attempt to highlight the unified structure of such types of problems that seem to appear in many different scenarios. Admittedly, our framework does not cover all problems of this flavour. Quite similar problems have for example been considered in the area of graph coloring, under the name of *pre-coloring extension*, which contains the completion of partial Latin squares as a special case [5, 14, 32]. However, there is a crucial difference with our approach: While with our problems, the minimality condition on the permissible extensions is essential for all our considerations, they become at best uninteresting for pre-coloring extension problems, although it is pretty straightforward to define partial orderings on pre-colorings so that the set of proper colorings is upward closed as required in our setting. It would be interesting to study such forms of extension problems also in a wider framework.

Extension problems as introduced in this paper are also different from *refinement problems* as studied in [7], which ask if a given solution is optimum. They also differ from *incremental problems* where it is asked if a given solution provides sufficient information to obtain a good solution to an instance obtained after modifying the instance in a described way, which is also very much related to reoptimization; see [9, 31].

We only focused on few specific problems. In view of the richness of combinatorial problems, many other areas could be looked into with this new approach. Further, it would be interesting to investigate to what extent enumeration problems can be improved by a clever solution to extension or, conversely, how the difficulty of extension implies bounds on enumeration problems. Finally, let us give one concrete open question in the spirit of the mentioned letter of Gödel to von Neumann: Is it possible to design an exact algorithm for UPPER DOMINATION that avoids enumerating all minimal dominating sets? This still unsolved question already triggered quite some recent research; see [2, 3].

Acknowledgements Partially supported by the Deutsche Forschungsgemeinschaft (FE 560/6-1) and by the project “ESIGMA” (ANR-17-CE23-0010).

References

- [1] Brenda Baker. Approximation algorithms for NP-complete problems on planar graphs. *Journal of the ACM*, 41:153–180, 1994.
- [2] Cristina Bazgan, Ljiljana Brankovic, Katrin Casel, and Henning Fernau. On the complexity landscape of the domination chain. In Sathish Govindarajan and Anil Maheshwari, editors, *Algorithms and Discrete Applied Mathematics - Second International Conference, CAL-DAM*, volume 9602 of *Lecture Notes in Computer Science*, pages 61–72. Springer, 2016. URL: https://doi.org/10.1007/978-3-319-29221-2_6, doi:10.1007/978-3-319-29221-2_6.
- [3] Cristina Bazgan, Ljiljana Brankovic, Katrin Casel, Henning Fernau, Klaus Jansen, Kim-Manuel Klein, Michael Lampis, Mathieu Liedloff, Jérôme Monnot, and Vangelis Th. Paschos. The many facets of upper domination. *Theoretical Computer Science*, 717:2–25, 2018.
- [4] Piotr Berman, Marek Karpinski, and Alex D. Scott. Approximation hardness of short symmetric instances of MAX-3SAT. *Electronic Colloquium on Computational Complexity (ECCC)*, (049), 2003. URL: <http://eccc.hpi-web.de/eccc-reports/2003/TR03-049/index.html>.
- [5] Miklós Biró, Mihály Hujter, and Zsolt Tuza. Precoloring extension. I. Interval graphs. *Discrete Mathematics*, 100(1-3):267–279, 1992.

- [6] Thomas Bläsius, Tobias Friedrich, Kitty Meeks, and Martin Schirneck. On the enumeration of minimal hitting sets in lexicographical order. *CoRR*, abs/1805.01310, 2018. URL: <http://arxiv.org/abs/1805.01310>, arXiv:1805.01310.
- [7] Hans L. Bodlaender, Rodney G. Downey, Michael R. Fellows, and Danny Hermelin. On problems without polynomial kernels. *Journal of Computer and System Sciences*, 75(8):423–434, 2009.
- [8] Hans L. Bodlaender, Fedor V. Fomin, Arie M. C. A. Koster, Dieter Kratsch, and Dimitrios M. Thilikos. A note on exact algorithms for vertex ordering problems on graphs. *Theory of Computing Systems*, 50(3):420–432, 2012.
- [9] Nicolas Boria and Vangelis Th. Paschos. Fast reoptimization for the minimum spanning tree problem. *Journal of Discrete Algorithms*, 8(3):296–310, 2010.
- [10] Endre Boros, Khaled M. Elbassioni, Vladimir Gurvich, Leonid Khachiyan, and Kazuhisa Makino. On generating all minimal integer solutions for a monotone system of linear inequalities. In Fernando Orejas, Paul G. Spirakis, and Jan van Leeuwen, editors, *Automata, Languages and Programming, 28th International Colloquium, ICALP*, volume 2076 of *Lecture Notes in Computer Science*, pages 92–103. Springer, 2001.
- [11] Endre Boros, Vladimir Gurvich, and Peter L. Hammer. Dual subimplicants of positive Boolean functions. *Optimization Methods and Software*, 10(2):147–156, 1998.
- [12] Endre Boros, Vladimir Gurvich, Leonid Khachiyan, and Kazuhisa Makino. Dual-bounded generating problems: Partial and multiple transversals of a hypergraph. *SIAM Journal on Computing*, 30(6):2036–2050, 2000.
- [13] Katrin Casel, Henning Fernau, Mehdi Khosravian, Jérôme Monnot, and Florian Sikora. Extension of vertex cover and independent set in some classes of graphs and generalizations. Manuscript, 2018.
- [14] Charles J. Colbourn. The complexity of completing partial Latin squares. *Discrete Applied Mathematics*, 8(1):25–30, 1984.
- [15] Marek Cygan, Fedor V. Fomin, Lukasz Kowalik, Daniel Lokshtanov, Dániel Marx, Marcin Pilipczuk, Michal Pilipczuk, and Saket Saurabh. *Parameterized Algorithms*. Springer, 2015.
- [16] Peter Damaschke. Parameterized enumeration, transversals, and imperfect phylogeny reconstruction. *Theoretical Computer Science*, 351(3):337–350, 2006.
- [17] Rodney G. Downey and Michael R. Fellows. *Fundamentals of Parameterized Complexity*. Texts in Computer Science. Springer, 2013.
- [18] Henning Fernau. Edge dominating set: Efficient enumeration-based exact algorithms. In Hans L. Bodlaender and Michael A. Langston, editors, *Parameterized and Exact Computation, IWPEC*, volume 4169 of *Lecture Notes in Computer Science*, pages 142–153. Springer, 2006.
- [19] Henning Fernau and David F. Manlove. Vertex and edge covers with clustering properties: Complexity and algorithms. *Journal of Discrete Algorithms*, 7:149–167, 2009.
- [20] Harold N. Gabow. An efficient reduction technique for degree-constrained subgraph and bidirected network flow problems. In David S. Johnson, Ronald Fagin, Michael L. Fredman, David Harel, Richard M. Karp, Nancy A. Lynch, Christos H. Papadimitriou, Ronald L. Rivest, Walter L. Ruzzo, and Joel I. Seiferas, editors, *Proceedings of the 15th Annual ACM Symposium on Theory of Computing, STOC*, pages 448–456. ACM, 1983.

- [21] Michael R. Garey and David S. Johnson. *Computers and Intractability: A Guide to the Theory of NP-Completeness*. W. H. Freeman & Co., New York, NY, USA, 1979.
- [22] Petr A. Golovach, Pinar Heggernes, Mamadou Moustapha Kanté, Dieter Kratsch, and Yngve Villanger. Minimal dominating sets in interval graphs and trees. *Discrete Applied Mathematics*, 216:162–170, 2017. URL: <https://doi.org/10.1016/j.dam.2016.01.038>.
- [23] Russell Impagliazzo, Ramamohan Paturi, and Francis Zane. Which problems have strongly exponential complexity? *Journal of Computer and System Sciences*, 63(4):512–530, 2001.
- [24] Klaus Jansen, Felix Land, and Kati Land. Bounding the running time of algorithms for scheduling and packing problems. *SIAM Journal of Discrete Mathematics*, 30(1):343–366, 2016.
- [25] Peter Jonsson, Victor Lagerkvist, Gustav Nordh, and Bruno Zanuttini. Strong partial clones and the time complexity of SAT problems. *Journal of Computer and System Sciences*, 84:52–78, 2017.
- [26] Leonid G. Khachiyan, Endre Boros, Khaled M. Elbassioni, Vladimir Gurvich, and Kazuhisa Makino. On the complexity of some enumeration problems for matroids. *SIAM Journal of Discrete Mathematics*, 19(4):966–984, 2005.
- [27] Jan Kratochvíl. A special planar satisfiability problem and a consequence of its NP-completeness. *Discrete Applied Mathematics*, 52:233–252, 1994.
- [28] David Lichtenstein. Planar formulae and their uses. *SIAM Journal on Computing*, 11(2):329–343, 1982. URL: <http://dx.doi.org/10.1137/0211025>, doi:10.1137/0211025.
- [29] Daniel Lokshtanov, Dániel Marx, and Saket Saurabh. Lower bounds based on the Exponential Time Hypothesis. *Bulletin of the EATCS*, 105:41–72, 2011.
- [30] David F. Manlove. *Minimaximal and maximinimal optimisation problems: a partial order-based approach*. PhD thesis, University of Glasgow, Computing Science, 1998.
- [31] Bernard Mans and Luke Mathieson. Incremental problems in the parameterized complexity setting. *Theory of Computing Systems*, 60(1):3–19, 2017.
- [32] Dániel Marx. NP-completeness of list coloring and precoloring extension on the edges of planar graphs. *Journal of Graph Theory*, 49(4):313–324, 2005.
- [33] J. W. Moon and L. Moser. On cliques in graphs. *Israel Journal of Mathematics*, 3:23–28, 1965.
- [34] Alexander Schrijver. *Combinatorial Optimization: Polyhedra and Efficiency*. Springer-Verlag, 2003.
- [35] Benno Schwikowski and Ewald Speckenmeyer. On enumerating all minimal solutions of feedback problems. *Discrete Applied Mathematics*, 117:253–265, 2002.
- [36] Michael Sipser. The history and status of the P versus NP question. In S. Rao Kosaraju, Mike Fellows, Avi Wigderson, and John A. Ellis, editors, *Proceedings of the 24th Annual ACM Symposium on Theory of Computing, STOC*, pages 603–618. ACM, 1992. URL: <http://doi.acm.org/10.1145/129712.129771>, doi:10.1145/129712.129771.

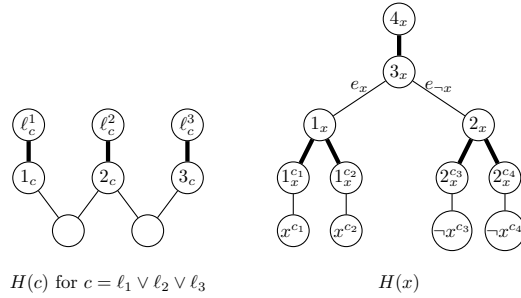

Figure 3: The Gadgets $H(c)$ and $H(x)$ for EXT EM. Edges not in U are marked with bold line.

8 Appendix: Omitted proofs

8.1 Proof of Theorem 1 for $\mathcal{P} = \text{EM}$

Theorem 25. EXT EM is NP-complete on bipartite graphs of maximum degree 3.

Proof. The proof is based on a reduction from (3, B2)-SAT. Consider an instance of (3, B2)-SAT with clauses $\mathcal{C} = \{c_1, \dots, c_m\}$ and variables $\mathcal{X} = \{x_1, \dots, x_n\}$. We build a bipartite graph $G = (V, E)$ of maximum degree 3, together with a set U of permitted edges (among which a maximal matching should be chosen) as follows:

- For each clause $c = \ell_1 \vee \ell_2 \vee \ell_3$ where ℓ_1, ℓ_2, ℓ_3 are literals, introduce a subgraph $H(c) = (V_c, E_c)$ with 8 vertices and 7 edges. V_c contains three specified literal vertices $\ell_c^1, \ell_c^2, \ell_c^3$. Moreover, $F_c = \{\ell_c^1 1_c, \ell_c^2 2_c, \ell_c^3 3_c\}$ is the set of three forbidden edges included in $H(c)$, so that $U_c = E_c \setminus F_c$. The gadget $H(c)$ is illustrated in the left part of Figure 3.
- For each variable x introduce 12 new vertices which induce the subgraph $H(x) = (V_x, E_x)$ illustrated in Figure 3. The vertex set V_x contains four special vertices $x^{c_1}, x^{c_2}, \neg x^{c_3}$ and $\neg x^{c_4}$, where it is implicitly supposed that variable x appears positively in clauses c_1, c_2 and negatively in clauses c_3, c_4 . Define $U_x = \{e_x\} \cup \{2_x^{c_3} \neg x^{c_3}, 2_x^{c_4} \neg x^{c_4}\}$ and $U_{\neg x} = \{e_{\neg x}\} \cup \{1_x^{c_1} x^{c_1}, 1_x^{c_2} x^{c_2}\}$.
- We interconnect $H(x)$ and $H(c)$ where x is a variable occurring in literal ℓ_i of clause c by adding the edge $\ell_i^c \ell_c^i$, with ℓ_i^c from $H(x)$ and ℓ_c^i from $H(c)$. These *crossing edges* are always permitted and collected in the set U_{cross} .

Let $U = (\bigcup_{c \in \mathcal{C}} U_c) \cup (\bigcup_{x \in \mathcal{X}} (U_x \cup U_{\neg x})) \cup U_{\text{cross}}$. This construction is computable in polynomial time and G is a bipartite graph of maximum degree 3.

We claim that there is a truth assignment of I which satisfies all clauses iff there is a maximal edge matching S of G which contains only edges from U . If T is a truth assignment of I which satisfies all clauses, then we add the set of crossing edges $x_c x^c$ as well as U_x if $T(x) = \text{true}$; otherwise, if $T(x) = \text{false}$, we add the crossing edges $\neg x_c \neg x^c$ and all edges in $U_{\neg x}$. For each clause c , we determine the literals which satisfy the clause (either one, two or three; let $\#c$ be the number of such literals); then, we add $3 - \#c$ edges saturating vertices $1_c, 2_c$ and 3_c . For instance, assume it is only ℓ_2 (thus, $\#c = 1$). Then, we add two edges saturating vertices 1_c and 3_c and the unnamed vertices in gadget clause $H(c)$. The resulting matching S is inclusion-wise maximal and satisfies $S \subseteq U$.

Conversely, assume the existence of a maximal matching S with $S \subseteq U$. Hence, for each variable $x \in \mathcal{X}$ exactly one edge between e_x and $e_{\neg x}$ belongs to S (in order to block edge $3_x 4_x$). If it is $e_x \in S$ (resp., $e_{\neg x} \in S$), then $U_x \subseteq S$ (resp., $U_{\neg x} \subseteq S$). Hence, S does not contain any crossing edges saturating $\neg x^c$ (resp. x^c). Now, for each clause $c = \ell_1 \vee \ell_2 \vee \ell_3$, at least one vertex

among $\ell_c^1, \ell_c^2, \ell_c^3$ must be adjacent to a crossing edge of S . In conclusion, by setting $T(x) = \text{true}$ if at least one vertex x^{c_1} or x^{c_2} of $H(x)$ is saturated by S and $T(x) = \text{false}$ otherwise we get a valid assignment T satisfying all clauses. ■

8.2 Proof of Theorem 1 for $\mathcal{P} = \text{DS}$

Theorem 26. *EXT DS is NP-complete on bipartite graphs of maximum degree 3, even if the subgraph $G[U]$ induced by the pre-solution U is an induced matching.*

Proof. The proof is based on a reduction from (3, B2)-SAT as defined before. For an instance I of (3, B2)-SAT with clause set $\mathcal{C} = \{c_1, \dots, c_m\}$ and variable set $\mathcal{X} = \{x_1, \dots, x_n\}$, we build a bipartite graph $G = (V, E)$ with maximum degree 3, together with a set $U \subseteq V$ of forced vertices as an instance of EXT DS as follows:

- For each clause $c = \ell_1 \vee \ell_2 \vee \ell_3$ where ℓ_1, ℓ_2, ℓ_3 are literals, we introduce the subgraph $H(c) = (V_c, E_c)$ with 7 vertices and 6 edges as illustrated on the left side of Fig. 4. The vertices $1'_c$ and $2'_c$ represent literals in clause c ($1'_c$ represents literals ℓ_1 and ℓ_2 while $2'_c$ represents ℓ_3) and the vertices $\{3_c, 4_c\}$ are included in the forced set U_c .
- For each variable x , we introduce a gadget $H(x) = (V_x, E_x)$ which is a path of length 2. The vertex 1_x is in the set of forced vertices U_x . An illustration of variable subgraph $H(x)$ is on the right side of Fig. 4.
- We interconnect the subgraphs $H(x)$ and $H(c)$ in the following way: for each clause c with literals ℓ_1, ℓ_2, ℓ_3 , corresponding to variables y_1, y_2, y_3 , respectively, connect $1'_c$ (representing ℓ_1 and ℓ_2) to the literal vertices ℓ_1 in $H(y_1)$ and ℓ_2 in $H(y_2)$ and connect $2'_c$ (representing ℓ_3) to the literal vertex ℓ_3 in $H(y_3)$.
- Also we set $U = (\bigcup_{c \in \mathcal{C}} U_c) \cup (\bigcup_{x \in \mathcal{X}} U_x)$.

This construction computes, in polynomial time, a bipartite graph G with maximum degree 3. Moreover, $G[U]$ is an induced matching. We can prove that there exists a satisfying assignment T for I iff (G, U) is a yes-instance of EXT DS. Suppose T is a satisfying assignment for I . Create a dominating set S from U by adding for each $x \in \mathcal{X}$ the literal vertex x if $T(x) = \text{true}$ and the literal vertex $\neg x$ if $T(x) = \text{false}$. Also, add to S for each clause $c \in \mathcal{C}$ the vertex 1_c if $1'_c$ is not dominated by a literal vertex in S and 2_c if $2'_c$ is not dominated by a literal vertex in S . The resulting set S is obviously a dominating set for G which contains U . Since T satisfies all clauses in I , S does not contain both 1_c and 2_c for any clause c , so the vertex 3_c has at least one private neighbor for each $c \in \mathcal{C}$. Since T further is a valid assignment, S only contains x or $\neg x$ for each variable $x \in \mathcal{X}$, so 1_x also has a private neighbor. If S is not minimal, it can hence be turned into a minimal dominating set S' by successively removing vertices without private neighbors from the ones that we added to U . This could happen if there is a variable x whose setting does not matter, as all clauses that contain x or $\neg x$ are already satisfied by the other literals. Then, the corresponding literal vertex (x or $\neg x$) put into S can be removed. The resulting minimal dominating set S' still contains all vertices from U ; observe that vertices 4_c also have a private neighbor 5_c . The vertices 4_c and 5_c are present in the gadgets to prevent 3_c to consider itself as its private neighbor.

Conversely, assume that S is a minimal dominating set of G with $U \subseteq S$. Because of minimality, 3_c needs a private neighbor, either 1_c or 2_c . Hence, S contains at most one vertex from $\{1_c, 1'_c, 2_c, 2'_c\}$ for each clause c . In particular, there is at least one vertex among $\{1'_c, 2'_c\}$ which needs to be dominated by a literal vertex. Again by minimality, 1_x needs a private neighbor, either x or $\neg x$. Hence, the two literal vertices x and $\neg x$ cannot be together in S . Thus, by setting $T(x) = \text{true}$ (resp., false) if $x \in S$ (resp., $x \notin S$), we arrive at a partial truth assignment of I , satisfying all clauses, that can be easily completed. ■

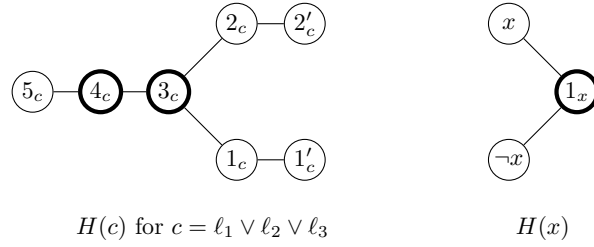

Figure 4: The Gadgets $H(c)$ and $H(x)$ for EXT DS. Vertices in U illustrated by their bold border.

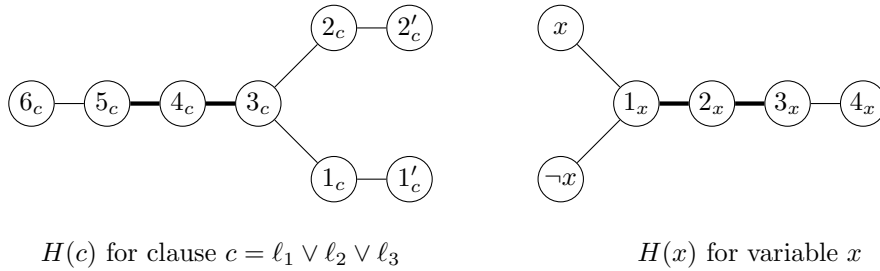

Figure 5: The Gadgets $H(c)$ and $H(x)$ for EXT EDS. Edges in U are marked with bold line.

8.3 Proof of Theorem 1 for $\mathcal{P} = \text{EDS}$

Theorem 27. EXT EDS is NP-complete on bipartite graphs of maximum degree 3, even if the partial subgraph (V, U) induced by the pre-solution U is an induced collection of P_3 .

Proof. The proof is similar to the proof of Theorem 26. We start with instance of $(3, B2\text{-SAT})$ with clauses $\mathcal{C} = \{c_1, \dots, c_m\}$ and variables $\mathcal{X} = \{x_1, \dots, x_n\}$ and build a bipartite graph $G = (V, E)$ of maximum degree 3 as described in Figure 5. Here the clause gadget $H(c) = (V_c, E_c)$ just has a new vertex 6_c and a new edge $5_c 6_c$ while the variable gadget $H(x) = (V_x, E_x)$ has an additional vertex 4_x and additional edge $3_x 4_x$. As forced edges we include the sets $U_c = \{3_c 4_c, 4_c 5_c\}$ and $U_x = \{1_x 2_x, 2_x 3_x\}$ for each clause gadget $H(c)$ and variable gadget $H(x)$, respectively, and the overall set of forced edges is given by $U = (\bigcup_{x \in \mathcal{X}} U_x) \cup (\bigcup_{c \in \mathcal{C}} U_c)$. Fig. 5 proposes an illustration of $H(c)$ and $H(x)$.

Clearly G is bipartite with maximum degree 3 and is constructed in polynomial time. Similarly to Theorem 26, we claim that I is satisfiable iff G has a minimal edge dominating set containing U . ■

8.4 Proof of Theorem 3

Theorem. EXT BP is NP-hard, even if the given pre-solution π_U contains only two sets.

Proof. The proof consists of a reduction from 3-PARTITION which is defined as follows: given a multiset $S = \{s_1, \dots, s_{3m}\}$ of positive integers and a positive integer b as input, decide if S can be partitioned into m triples S_1, \dots, S_m such that the sum of each subset equals b . 3-PARTITION is NP-complete even if each integer satisfies $b/4 < s_i < b/2$; see [21]. Let $(S = \{s_1, \dots, s_{3m}\}, b)$ be the input of 3-PARTITION, where $b/4 < s_i < b/2$ for each $1 \leq i \leq 3m$. We build a set $X = \{x_0, x_1, \dots, x_{3m}\}$ of items and a weight function w where $w(x_0) = \frac{m}{m+1}$ and $w(x_i) = \frac{s_i}{b}$ for each $1 \leq i \leq 3m$ and set $\pi_U = \{\{x_0\}, \{x_1, \dots, x_{3m}\}\}$ as a partial partition of X . We claim that (S, b) is a yes-instance of 3-PARTITION if and only if (X, π_U) is a yes-instance of EXT BP.

Suppose first that S can be partitioned into m triples S_1, \dots, S_m where $\sum_{s_j \in S_i} s_j = b$ for each $S_i \in S$. We build a set $X_i = \{x_j : 1 \leq j \leq 3m, s_j \in S_i\}$, $1 \leq i \leq m$. Considering π_U ,

$\pi'_U = \{\{x_0\}, X_1, \dots, X_m\}$ is a feasible partition and since for each $S_i \in \mathcal{S}$, $\sum_{s_j \in S_i} s_j = b$, we have $w(X_i) = 1$ for each $X_i \in \pi'_U$. Hence π'_U is not the refinement of any other feasible partition for (S, b) , as especially x_0 cannot be added to any subset $X_i \in \pi'_U$. Since π'_U is obviously a refinement of π_U , π'_U is a minimal feasible partition with $\pi_U \leq_X \pi'_U$.

Conversely, assume that π'_U is a minimal partition of X as a refinement of π_U . As the set $\{x_0\}$ in the partition π_U can not be split up further, it follows that the extension π'_U is of the form $\{\{x_0\}, X_1, \dots, X_k\}$. By using the minimality of π'_U , it follows especially that $\sum_{x_l \in X_i} w(x_l) + w(x_0) > 1$ for all $i \in \{1, \dots, k\}$, as otherwise $\pi''_U = \{X_1, \dots, X_{i-1}, X_i \cup \{x_0\}, X_{i+1}, \dots, X_k\}$ would be a feasible partition of X with $\pi''_U \leq_X \pi'_U$. We claim that $k = m$. As $k < m$ is not possible, assume that $k > m$. Since $\sum_{i=1}^{3m} w(x_i) = \frac{1}{b} \sum_{i=1}^{3m} s_i = m$, this means that $\sum_{x_l \in X_j} x_l w(X_j) \leq \frac{m}{k}$ for at least one $j \in \{1, \dots, k\}$, which contradicts $\sum_{x_l \in X_j} w(x_l) + w(x_0) > 1$ by the definition of x_0 . Consider the collection of the sets $S_i = \{s_j : 1 \leq j \leq 3m, x_j \in X_i\}$, $1 \leq i \leq m$ as a partition for S . By feasibility of π'_U , it follows that $w(X_i) \leq 1$, which means $\sum_{s_l \in S_i} s_l \leq b$ and $k = m$ implies that indeed $\sum_{s_l \in S_i} s_l = b$ for each $i \in \{1, \dots, m\}$. The requirement $b/4 < s_i < b/2$ for each $1 \leq i \leq 3m$ then implies that the size of each X_i equals 3, which overall means that S_1, \dots, S_m is a solution for 3-PARTITION on (S, b) . ■

8.5 Proofs for Theorem 4

These proofs are summarized below in Section 11.

8.6 Proof of Theorem 8

Theorem. *There is a maximal matching M of G such that $M \cap A = \emptyset$ if and only if there is a minimal vertex cover S of G'' such that the maximum weighted matching of (G', w^S) is at least $|S|(|E| + 1)$.*

Proof. Let $G = (V, E)$ be a graph and let $A \subseteq E$. Let M be any maximal matching of G such that $M \cap A = \emptyset$ (if any). From Lemma 7, we know $V(M) \cap V(A)$ is a vertex cover of G'' . Let $S \subseteq V(M) \cap V(A)$ be any minimal vertex cover of G'' . By construction of w^S , we have $w^S(M) \geq |S|(|E| + 1)$.

Conversely, assume that S is a minimal vertex cover of G'' such that the maximum weighted matching of (G', w^S) is at least $|S|(|E| + 1)$. Let M be any maximum weighted matching of (G', w^S) . By construction of w^S , matching M is incident to every vertex of S . In conclusion, M is a maximal matching of G with $M \cap A = \emptyset$. ■

8.7 Proof of Theorem 9

Theorem. EXT EM with dual parameter is in FPT.

Proof. Consider an algorithm that lists all minimal vertex covers of G'' and checks the matching condition of (G', w^S) according to Theorem 8 in polynomial time. The running time is dominated by the procedure that lists all minimal vertex covers. As the number of edges in a graph is an upper bound on any minimal vertex cover of that graph, it is clear that we can enumerate all minimal vertex covers of G'' in time $O^*(2^{|A|})$ by [16, 18]. ■

8.8 Proof of Theorem 10

Theorem. EXT DS with standard parameter is W[3]-complete, even when restricted to bipartite instances.

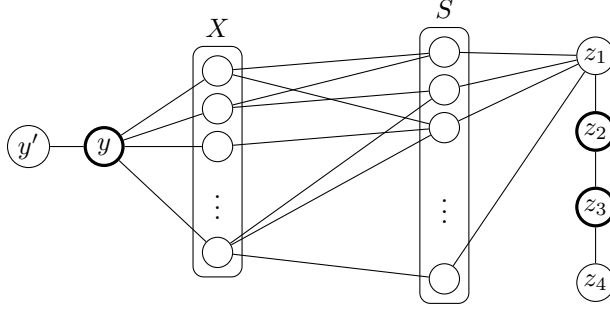

Figure 6: The graph $G = (V, E)$ for EXT DS, Vertices in U' are drawn bold.

Proof. EXT DS can obviously be modeled as special case of the extension for hitting sets by interpreting the closed neighborhoods as subsets of the ground set of vertices. This immediately gives membership in W[3] for EXT DS.

Conversely, given an instance (I, U) with $I = (X, \mathcal{S})$, $\mathcal{S} = \{S_1, \dots, S_m\}$ for EXT HS we create a graph for the corresponding instance for EXT DS as follows:

- Start with the bipartite graph on vertices $X \cup \{s_1, \dots, s_m\}$ containing edges xs_i iff $x \in S_i$.
- Add two new vertices y, y' with edges $y'y$ and xy for all $x \in X$.
- Add four new vertices z_1, z_2, z_3, z_4 with edges z_1z_2, z_2z_3, z_3z_4 and z_1s_i for all $1 \leq i \leq m$.

The construction is illustrated in Fig 6. Let $G = (V, E)$ denote the obviously still bipartite graph created in this way. With the set U' containing the vertex y to dominate X , z_2 and z_3 to forbid including any vertex s_i in the extension (as this would make z_2 obsolete) and the vertices corresponding to the pre-solution U for EXT HS, it is not hard to see that (G, U') is a *yes*-instance for EXT DS iff (I, U) is a *yes*-instance for EXT HS. As the parameters relate by $m(G, U') = |U'| = |U| + 3 = m(I, U) + 3$, this reduction transfers the W[3]-hardness of EXT HS to EXT DS on bipartite graphs. ■

8.9 Proof of Theorem 11

Theorem. EXT EDS (with standard parameter) is W[1]-hard, even when restricted to bipartite graphs.

Proof. The hardness result comes from a reduction from EXT VC on bipartite graphs. Let $I = (G, U)$ be an instance of EXT VC, where $G = (V, E)$ is a bipartite graph with partition (V_1, V_2) of V and $U \subseteq V$. We build an instance $I' = (G', U')$ of EXT EDS as follows. Let us first construct a new graph $G' = (V', E')$ with $V' = V \cup \{x_i, y_i, z_i : i = 1, 2\}$ and

$$E' = E \cup \bigcup_{i=1,2} (\{x_i y_i, y_i z_i\} \cup \{v x_i : v \in V_i\})$$

by adding six new vertices (three for each part). G' is obviously bipartite with partition into $V'_1 = V_1 \cup \{x_2, y_1, z_2\}$ and $V'_2 = V_2 \cup \{x_1, y_2, z_1\}$. Let

$$U' = (\{u x_1 : u \in U \cap V_1\} \cup \{u x_2 : u \in U \cap V_2\}) \cup \{x_1 y_1, x_2 y_2\};$$

so, $|U'| = |U| + 2$. This construction is illustrated in Fig. 7. We claim that (G', U') is a *yes*-instance of EXT EDS if and only if (G, U) is a *yes*-instance of EXT VC.

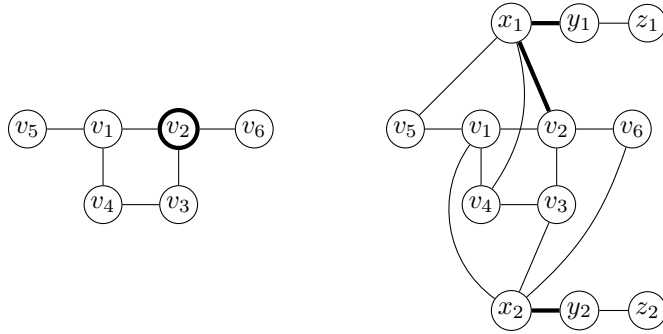

Figure 7: (G, U) as an instance of EXT VC is shown on the left, with $V_1 = \{v_2, v_4, v_5\}$ and $V_2 = \{v_1, v_3, v_6\}$ and $U = \{v_2\}$. The constructed instance (G', U') of EXT EDS is shown on the right. The vertices and edges of U and U' are in marked with bold lines.

Suppose (G, U) is a yes-instance for EXT VC; so there exists a minimal vertex cover S for G such that $U \subseteq S$. Consider the set $S' = \{vx_1 : v \in V_1 \cap S\} \cup \{vx_2 : v \in V_2 \cap S\} \cup \{x_1y_1, x_2y_2\}$. S' is an edge dominating set of G' which includes U' because S contains U . Since S is minimal, S' is minimal, too; observe that private edges of a vertex $v \in S \cap V_1$ translate to private edges of $vx_1 \in S'$, analogously for $x \in S \cap V_2$. By construction, y_iz_i is a private edge for x_iy_i , $i = 1, 2$.

Conversely, suppose S' is a minimal edge dominating set of G' containing U' . Since S' is minimal, then for each $e \in S'$ there is a private edge set $S_e \subseteq E'$, $S_e \neq \emptyset$, which is dominated only by e . Moreover, we have, for $i \in \{1, 2\}$:

$$\forall v \in V_i ((vx_i \in S') \iff (\forall u \in V_{3-i}(vu \notin S' \cap E))$$

since S' is minimal and $\{x_1y_1, x_2y_2\} \subseteq U'$. We will now show how to safely modify S' such that $S' \cap E = \emptyset$. If it is not already the case, there is some edge, w.l.o.g., $e = uv \in S' \cap E$ with $u \in V_1$ and $v \in V_2$. In particular from the above observations, we deduce $u \notin U$, $v \notin U$ and $S_e \subseteq E$. Modify S' by the following procedure.

- If the private solution set $S_e \setminus \{e\}$ contains some edges incident to u and some edges incident to v , then $e \in S'$ will be replaced by ux_1 and vx_2 ;
- if every edge in the private solution S_e is adjacent to u , replace e in S' by ux_1 , otherwise if every edge in the private solution S_e is adjacent to v , replace e in S' by vx_2 .

The case distinction is necessary to guarantee that S' stays a minimal edge dominating set after each modification step. We repeat this procedure until $S' \cap E = \emptyset$. At the end of the process, any vertex $v \in V$ covers the same set of edges as vx_1 or vx_2 dominates. Hence, by setting $S = \{v \in V : vx_1 \in S' \text{ or } vx_2 \in S'\}$, we build a minimal vertex cover of G containing U . ■

Remark 28. Note that the procedure of local modifications given in Theorem 11 does not preserve optimality, but only inclusion-wise minimality.

9 Generalization of matching extension

r -DEGREE CONSTRAINED PARTIAL SUBGRAPH (or r -DCPS for short) is defined as follows: the instance $I = (V, E)$ is a graph, $\leq_I = \supseteq$, $presol(I) = 2^E$, $S \in sol(I)$ iff none of the vertices in V is incident to more than r edges in S .

The particular case of $r = 1$ corresponds to the famous matching problem in graphs. The optimization problem associated to r -DCPS, denoted here MAX r -DCPS, consists of finding an edge subset E' of maximum cardinality that is a solution to r -DCPS. MAX r -DCPS is known to be solvable in polynomial time even for the edge weighted version (here, we want to maximize $w(E')$) [20]. When additionally the constraint r is not uniform and depends on each vertex (i.e., at most $b(v) = r_v$ edges incident to vertex v), MAX r -DCPS is usually known as SIMPLE b -MATCHING and remains solvable in polynomial time even for the edge weighted version (Theorem 33.4, Chapter 33 of Volume A in [34]).

We are considering the associated extension problem, formally described as follows.

EXT r -DCPS
Input: A graph $G = (V, E)$ and $U \subseteq E$.
Question: Does there exists $E' \subseteq U$ such that the partial graph $G = (V, E')$ has maximum degree at most r and is maximal in G ?

9.1 Complexity results

We are first re-stating Theorem 21: For every fixed $r \geq 2$, EXT r -DCPS is NP-complete in bipartite graphs with maximum degree $r + 1$, even if the set of forbidden edges induces a matching.

Proof. The proof is based on a reduction from (3, B2)-SAT. A main building block of our construction is a subgraph, denoted $B_k(v)$ with $k < r$, containing $(kr) + 1$ vertices which are arranged as a tree of depth 2 with root v such that v has k children within this gadget and each child w of v has r children. For each child w of v one edge connecting w to a leaf in $B_k(v)$ will be forbidden in our construction, and we will use $F_{B_k(v)}$ to denote a fixed set of k edges in $B_k(v)$ such that each child of v is adjacent to an edge in $F_{B_k(v)}$ and v is not adjacent to an edge in $F_{B_k(v)}$. The left part of Fig. 8 gives an illustration of $B_k(v)$. The purpose of this construction is that the root v will connect to other parts of the graph, and the structure of $B_k(v)$ with the forbidden edges will make sure that a maximum r -degree constrained partial subgraph contains all edges between v and its children in $B_k(v)$, and can consequently only contain $r - k$ edges connecting v to a vertex outside $B_k(v)$. Namely, if one edge e would be missing from the edges incident to v in $B_k(v)$ in any maximal edge set E' , say, $e = vv'$, then E' would have to include the forbidden edge incident to v' by maximality.

Consider now an instance I of (3, B2)-SAT with clauses $\mathcal{C} = \{c_1, \dots, c_m\}$ and variables $\mathcal{X} = \{x_1, \dots, x_n\}$. We build a bipartite graph $G = (V, E)$ of maximum degree $r + 1$, together with a set U of permitted edges (among which a maximal partial subgraph of degree at most r should be chosen) as follows:

- For each clause $c \in \mathcal{C}$, build a clause gadget $H(c) = (V_c, E_c)$ which is a $B_{(r-2)}(c)$ (the root c of $B_{(r-2)}(c)$ has $r - 2$ children). Hence, we denote $U_c = E_c \setminus F_{B_{(r-2)}(c)}$ set of permitted edges in $H(c)$.
- For each variable x introduce $3r$ new vertices which induce the primary subgraph denoted $H'(x) = (V'_x, E'_x)$. The vertex set V'_x contains four special vertices $x, x', \neg x, \neg x'$. The vertices x and $\neg x$ have $r - 2$ distinct vertices in its neighborhoods and x' and $\neg x'$ are connected to r common vertices $v_x^1, v_x^2, \dots, v_x^r$. Also we connect $x, \neg x$ to $x', \neg x'$ respectively with two forbidden edges in $H'(x)$. The right part of Fig. 8 gives an illustration of $H'(x)$. By adding a component $B_{(r-1)}(y)$ for each vertex $y \in \{v_x^i : 1 \leq i \leq r\}$ and identifying the root of $B_{(r-1)}(y)$ with y , we construct a new subgraph $H(x) = (V_x, E_x)$. We define the set of forbidden edges in $H(x)$ by $F_x = \{xx', \neg x\neg x'\} \cup (\bigcup_{1 \leq i \leq r} F_{B_{(r-1)}(v_x^i)})$ and hence $U_x = E_x \setminus F_x$ denotes the set of permitted edges in $H(x)$.

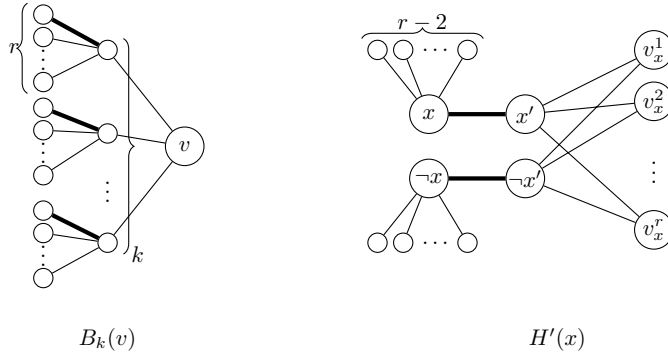

Figure 8: The gadgets $B_k(v)$ and $H'(x)$. Edges from the forbidden subset in $F_{B_k(v)}$ are marked with bold line of the left side and more generally, edges not in U are marked with bold line.

- We interconnect $H(x)$ and $H(c)$ by adding edge xc if x appears positively in clause c and $\neg xc$ if x appears negatively. These *crossing edges* are always permitted and collected in the set U_{cross} .

Let $U = (\bigcup_{c \in C} U_c) \cup (\bigcup_{x \in X} U_x) \cup U_{\text{cross}}$ be the global set of permitted edges. This construction is computable in polynomial time, yielding a graph G that is a bipartite graph of maximum degree $r + 1$.

We claim that there is a truth assignment T of I which satisfies all clauses iff there is a maximal r -degree constrained partial subgraph $G_S = (V, S)$ where $S \subseteq U$ of G .

If T is a truth assignment of I which satisfies all clauses, a maximal r -degree constrained partial subgraph $G_S = (V, S)$ with $S \subseteq U$ can be constructed as follows:

1. For each variable gadget $H(c)$, by maximality $U_c \subseteq S$.
2. For each variable x we add edges according to the assignment as follows: If $T(x) = \text{true}$, we add $v_x^i x'$ for all $1 \leq i \leq r$ and the two crossing edges connecting $\neg x$ with their respective clause gadgets. If $T(x) = \text{false}$, we add $v_x^i \neg x'$ for all $1 \leq i \leq r$ and the two crossing edges connecting x with their respective clause gadgets. In both cases by maximality we add $2(r - 2)$ pendent edges incident to x and $\neg x$ and also all permitted edges in $B_{(r-1)}(y)$ for all $y \in \{v_x^i : 1 \leq i \leq r\}$.
3. At last, for each variable c which has more than one true literal in assignment T , add some arbitrary crossing edges to c such that $d_{G_S}(c) = r$.

The resulting subgraph is a maximal r -degree constrained partial subgraph $G_S = (V, S)$ with $S \subseteq U$.

Conversely, assume the existence of a maximal r -degree partial subgraph $G_S = (V, S)$ with $S \subseteq U$. First, recall that for every gadget $B_k(v)$, we must have $E(B_k(v)) \setminus F_{B_k(v)} \subseteq S$ for $k \in \{r - 1, r - 2\}$. Moreover, for each variable gadget $H(x)$, at least one of the pairs of crossing edges incident to x and $\neg x$ have to be in S (by maximality). Hence we set $T(x) = \text{true}$ if both crossing edges incident to $\neg x$ are in S and otherwise we set $T(x) = \text{false}$ (if both, we choose arbitrarily one of them). This assignment is valid and since for each clause c , at most two crossing edges incident to vertex c are in S (G_S is a subgraph with maximum degree r), then T satisfies all clauses of I . ■

9.2 Parameterized perspective

Proposition 29. *For graphs with maximum degree $r + 1$, EXT r -DCPS is polynomial-time decidable when $r = 1$ and is in **FPT** respect to the number of isolated edges in $E \setminus U$ for $r \geq 2$.*

Proof. Consider the subgraph $G' = (V, E \setminus U)$ induced by $E \setminus U$, i.e. the graph induced by the forbidden edges. Since maximum degree of G is $r + 1$, so if G' contains a triangle or a path of length at least 3, the answer is no. Therefore, we can suppose that G' is a collection of stars. If one leaf of a star of G' has a degree at most r in G , then this star might be an isolated edge in G' and it is exactly for one of these two endpoints (otherwise, the answer is no). Hence, let $P_{G'}$ be the set of the stars which are isolated edges in G' and such that both extremities are of degree $r + 1$ in G .

- For $r \geq 2$, for the set of stars of G' with more than one edge, leaves and center are clearly determined and for each single edge of G' not in $P_{G'}$, the extremity with degree less than r is chosen as a center. Now, for each star in $P_{G'}$ we have to determine one of the extremities as a center and the other one as a leaf. We can now build the set L of leaves for all stars of G' . Let $E'_L = \{uv \in E : u \in L\}$ and $G'_L = (V, E'_L)$. We check for all possible labelings, if there is a label which satisfies two following conditions the answer is yes, else the answer is no.

1. for each $v \in L$, $d_{G'_L}(v) = r + 1$.
2. for each vertex $v \in V \setminus L$, $d_{G'_L}(v) \leq r$.

- For $r = 1$, we make a new graph H by omitting all sets of vertices $\{u'_i, u_i, v_i, w_i, w'_i\}$ for the stars $[u_i, v_i, w_i]$ of G' (with center v_i) where u'_i, w'_i are neighbors of the leaves u_i, w_i (without v_i). Notice at each time u'_i, w'_i have to be disjoint from one star to another one, otherwise the answer is no. Now H is a collection of paths (maybe trivial) and cycles where the forbidden edges induce a matching. Remove from H all cycles and the paths where both end edges are in U . Now H is a collection of paths where at least one of end edges is forbidden. For all of these paths, start from one side and satisfy the maximality by assigning the first possible edge to a forbidden edge, if there is a path does not satisfy the maximality, the answer is no, else the answer is yes. ■

Remark 30. *For graphs with maximum degree $r + 1$, EXT r -DCPS with $r \geq 2$ is parameterized equivalent to SAT with respect to the number of isolated edges in $E \setminus U$ and variables, respectively.*

10 Generalization of edge cover extension

We assume r is a constant fixed greater than one (but all results given here hold even if r depends on the graph). The r -DEGREE EDGE-COVER PROBLEM (r -EC for short) is defined as follows: the instance $G = (V, E)$ is a graph, $\leq_G = \subseteq$, $presol(G) = 2^E$, and $E' \in sol(I)$ is a feasible solution iff each $v \in V$ is incident to at least $r \geq 1$ distinct edges $e \in C$. The particular case of $r = 1$ corresponds to the famous edge cover problem in graphs. A partial graph $G' = (V, E')$ of r -EC will be called an r -EC solution in the following.²

The optimization version of a generalization of r -EC known as the MIN LOWER-UPPER-COVER PROBLEM (MINLUCP), consists of, given a graph G where $G = (V, E)$ and two non-negative functions a, b from V such that $\forall v \in V$, $0 \leq a(v) \leq b(v) \leq d_G(v)$, of finding a subset $M \subseteq E$ such that the partial graph $G[M] = (V, M)$ induced by M satisfies $a(v) \leq d_{G[M]}(v) \leq b(v)$ (such a solution will be called a *lower-upper-cover*) and minimizing its total size $|M|$ among all such solutions (if any). Hence, an r -EC solution corresponds to a lower-upper-cover with $a(v) = r$ and

²A different generalization of edge cover was considered in [19], requiring that each connected component induced by the edge cover solution contains at least t edges. Clearly, if every vertex is incident to at least r edges from the cover, then each connected component induced by the edge cover solution contains at least r edges.

$b(v) = d_G(v)$ for every $v \in V$. MINLUCP is known to be solvable in polynomial time even for edge-weighted graphs (Theorem 35.2 in Chapter 35 of Volume A in [34]).

EXT r -EC

Input: A graph $G = (V, E)$ and $U \subseteq E$.

question: Does there exist $E' \supseteq U$ such that the partial graph $G' = (V, E')$ has minimum degree at least r and is minimal in G ?

10.1 Complexity results

We are now proving Theorem 23, which we are re-formulating here for convenience.

For every fixed $r \geq 1$, EXT r -EC is NP-complete in bipartite graphs with maximum degree $r + 2$, even if the pre-solution (V, U) is a collection of paths of length at most 1.

Proof. The proof is based on a reduction from $(3, B2)$ -SAT. A main building block $B_{2r}(v)$ (or $B_{2r+1}(v)$) in our construction is based on a complete bipartite subgraph of $2r$ (or $2r + 1$) vertices where one specified edge between two special vertices v and v' has been deleted. So, $B_{2r}(v) = K_{r,r} - \{vv'\}$ and $B_{2r+1}(v) = K_{r+1,r} - \{vv'\}$. Except for these two vertices v, v' , the other vertices of $B_{2r}(v)$ are not linked to any other vertex in the whole construction, while for $B_{2r+1}(v)$, it is only the case of v (i.e., only v is also linked outside $B_{2r+1}(v)$). Block $B_{2r}(v)$ will appear five times in each *variable gadget* and block $B_{2r+1}(v)$ will correspond to each *clause gadget* (see Fig. 9 for an illustration). By construction, all edges of $B_{2r}(v)$ will belong to any r -EC solution (in fact, vertices v and v' still need one more edge to satisfy the minimum degree constraint) and for $B_{2r+1}(c)$, it will be almost the case (except for few edges of $B_{2r+1}(c)$ incident to c , as all neighbors of c in $B_{2r+1}(c)$ have degree $r + 1$, and all edges between $N(c)$ and $N(N(c)) \setminus \{c\}$ have to be in the edge cover; c will need one more incident edge in the edge cover besides (some of) the edges from $B_{2r+1}(c)$).

Now, consider an instance I of $(3, B2)$ -SAT with clauses $\mathcal{C} = \{c_1, \dots, c_m\}$ and variables $\mathcal{X} = \{x_1, \dots, x_n\}$. We build a bipartite graph $G = (V, E)$ of maximum degree $r + 2$, together with a set U of permitted edges as follows:

- For each clause $c \in \mathcal{C}$, we build a clause gadget $B_{2r+1}(c)$ which is a component $K_{r,r-1}$ plus two vertices c, c' . An illustration of $B_{2r+1}(c)$ is given in the left side of Fig. 9.
- For each variable $x \in \mathcal{X}$, we construct a subgraph $H(x) = (V_x, E_x)$ as follows: build two P_5 denoted $P = (x, l, m, r, \neg x)$ and $P' = (x', l', m', r', \neg x')$ respectively; then between each pair of vertices v, v' of P and P' a block $B_{2r}(v)$ is added for each v on P ; this interconnects v on P with the corresponding vertex v' on P' , as v and v' are special to $B_{2r}(v)$. The variable gadget $H(x) = (V_x, E_x)$ is illustrated to the right of Figure 9.
- We interconnect $H(x)$ and $B_{2r+1}(c)$ where x is a literal of clause c by adding edge xc if x appears positively in c and the edge $\neg xc$ if x appears negated. Such edges will be called *crossing*.

Now, it is easy to see that G is bipartite of maximum degree $r + 2$. Finally, let $U = \{x_i l_i, \neg x_i r_i : 1 \leq i \leq n\}$, picking the corresponding vertices and edges in each $H(x_i)$.

We claim that there is a truth assignment T of I which satisfies all clauses iff G admits a minimal r -EC solution $H = (V, S)$ where $U \subseteq S$ of G .

If T is a truth assignment of I which satisfies all clauses, a minimal r -EC solution $H = (V, S)$ can be constructed as follows:

- For each variable x , if $T(x) = \text{true}$, $\{xc : x \text{ appears positively in } c\} \cup (E_x \setminus \{lm, l'm'\}) \subseteq S$, and if $T(x) = \text{false}$, $\{\neg xc : x \text{ appears negatively in } c\} \cup (E_x \setminus \{mr, m'r'\}) \subseteq S$.

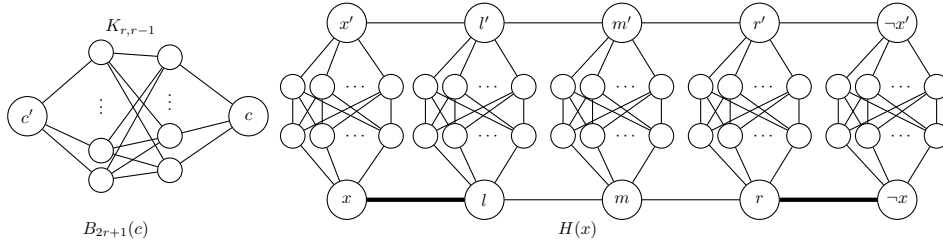

Figure 9: Block $B_{2r+1}(c)$ for clause c is depicted on the left-hand side. The subgraph $H(x) = (V_x, E_x)$ is shown on the right-hand side. Edges of U are drawn in bold.

- Since T is a satisfying assignment, we have already added in the previous step $k \geq 1$ crossing edges connected to block $B_{2r+1}(c)$ for each clause c . Then, we delete arbitrarily $k - 1$ edges S_c of $B_{2r+1}(c)$ incident to c , and we add $E(B_{2r+1}(c)) \setminus S_c$ to S .

Conversely, assume that $H = (V, S)$ is a minimal r -EC solution of G containing U . By considering the variable gadget $H(x)$ and in order to keep minimality S contains either lm or rm (not both since $\{xl, -xr\} \subset S$ by hypothesis and since all edges in the block $B_{2r}(v)$ for $v \in \{l, m, r\}$ have to be included into the edge cover by our previous observations). Hence, we set $T(x_i) = \text{true}$ if $rm \in S$ and $T(x_i) = \text{false}$ if $lm \in S$. Since H has to get a minimum degree at least r for each vertex and vertex c has a degree $r - 1$ in clause gadget $B_{2r+1}(c)$, then the partial graph H contains at least one crossing edge incident to each c and hence T is a valid assignment of I . ■

10.2 Parameterized perspective

Consider a graph $G = (V, E)$ and let $U \subseteq E$; recall that $G[U] = (V, U)$ and $G[\overline{U}] = (V, E \setminus U)$ denote the partial graphs induced by U and $E \setminus U$, respectively. Finally, $V(U)$ denotes the endpoints of edges in U (or equivalently the non-isolated vertices of $G[U]$). The next property is quite immediate for each solution $G' = (V, E')$ of EXT r -EC.

Lemma 31. *$\text{ext}(G, U) \neq \emptyset$ iff there is an r -EC solution $G' = (V, E')$ where $E' \supseteq U$ such that $S_{G'} = \{v \in V(U) : d_{G'}(v) > r\}$ is an independent set of $G[U]$.*

Proof. The condition is obviously necessary, as an edge among two vertices $x, y \in U$ of a minimal extension $X \supseteq U$ certifying that $\text{ext}(G, U) \neq \emptyset$ can only exist if x or y is, or both x and y are, incident to at most r edges from X because of minimality.

Let us look into the other direction. Let $G' = (V, E')$ be a partial subgraph of G with $U \subseteq E'$ and $d_{G'}(v) \geq r$ for all $v \in V$. Moreover, assume $S_{G'} = \{v \in V(U) : d_{G'}(v) > r\}$ is an independent set of $G[U]$. Consider any minimal partial subgraph $H = (V, E_H)$ of $G' = (V, E')$ maintaining the property $d_{G'}(v) \geq r$ for all $v \in V$. Since $S_{G'}$ is an independent set of $G[U]$, $U \subseteq E_H$ and therefore, $E_H \in \text{ext}(G, U)$. ■

Now let us establish a relation between the instances of the two problems EXT r -EC and MINLUCP. Let (G, U) be a *yes*-instance of EXT r -EC where $G = (V, E)$ is a graph of minimum degree at least r and $U \subseteq E$. So, $\text{ext}(G, U) \neq \emptyset$ which implies by Lemma 31 the existence of a particular independent set S of $G[U]$. We build an instance $(G[\overline{U}], a, b)$, $\overline{U} = E \setminus U$, of MINLUCP, where a, b are two non-negative functions defined as follows:

$$a(v) := \begin{cases} r & \text{if } v \in V \setminus V(U) \\ r - d_{G[U]}(v) & \text{if } v \in V(U), \end{cases}$$

and

$$b(v) := \begin{cases} d_G(v) & \text{if } v \in (V \setminus V(U)) \cup S \\ r - d_{G[U]}(v) & \text{if } v \in V(U) \setminus S. \end{cases}$$

The next property is rather immediate.

Theorem 32. *If there is a solution of MINLUCP for the instance $(G[\overline{U}], a, b)$, then $\text{ext}(G, U) \neq \emptyset$.*

Proof. Assume that instance $(G[\overline{U}], a, b)$ of MINLUCP admits a feasible solution and let $G^* = (V, E^*)$ be an optimal solution. Then, the partial graph $H = (V, E^* \cup U)$ satisfies the hypothesis of Lemma 31 (actually, H is already minimal with respect to property $\forall v \in V, d_H(v) \geq r$). ■

Using the outcome given in Theorem 32, the next result is rather straightforward. We reformulate Theorem 24 for the reader's convenience.

EXT r -EC, with standard parameter, is in FPT.

Proof. Consider the algorithm that lists all possible instances $(G[\overline{U}], a, b)$ for MINLUCP by checking all independent sets of $G[U]$ included in $V(U)$ from an instance $I = (G, U)$ of EXT r -EC. This means that we try different values for function b . Since MINLUCP is solvable in polynomial time [34], then the running time is dominated by the procedure that lists all possible independent sets of $G[U]$, i.e., there are $3^{|U|}$ possibilities: each vertex of each edge in U can be either included or excluded of the independent set, except for taking both endpoints in. ■

11 Planar Problems (Proofs for Theorem 4)

We already mentioned above that we know the extension variants of VERTEX COVER and of DOMINATING SET are NP-hard on planar cubic graphs. In the following, we will consider EXT EC, DS, EDS, EM in planar bipartite graphs and will show that all the problems are NP-hard even we restrict the graphs to be subcubic planar bipartite. In order to prove these results, we will give some reductions from 4-BOUNDED PLANAR 3-CONNECTED SAT PROBLEM (4P3C3SAT for short) which was already explained above.

Let $I = (X, C)$ be an instance of 4P3C3SAT where $X = \{x_1, \dots, x_n\}$ and $C = \{c_1, \dots, c_m\}$ are variable and clause sets of I respectively. By definition, the graph $G = (V, E)$ with $V = \{c_1, \dots, c_m\} \cup \{x_1, \dots, x_n\}$ and $E = \{c_i x_j : x_j \text{ or } \neg x_j \text{ appears in } c_j\}$ is planar. In the following, we always assume that the planar graph comes with an embedding in the plane. Informally, we are looking a new construction by putting some gadgets instead of vertices x_i of G which satisfies two following conditions: (1) as it can be seen in Fig. 1, the constructions distinguishes between the cases that a variable x_i appears positively and negatively in some clauses (2) the new construction preserves planarity.

Suppose that a variable x_i appears in at most four clauses c_1, c_2, c_3, c_4 of the original instance I such that in the induced (embedded) subgraph $G_i = G[\{x_i, c_1, c_2, c_3, c_4\}]$, $c_1 x_i, c_2 x_i, c_3 x_i, c_4 x_i$ is an anti-clockwise ordering of edges around x_i . By looking at G_i and considering the fact that variable x_i appears negated or non-negated in the four clauses c_1, c_2, c_3, c_4 in I , the construction should satisfies the 3 following cases:

- case 1: $x_i \in c_1, c_2$ and $\neg x_i \in c_3, c_4$,
- case 2: $x_i \in c_1, c_3$ and $\neg x_i \in c_2, c_4$,
- case 3: $x_i \in c_1, c_2, c_3$ and $\neg x_i \in c_4$.

Note that all other cases are included in these 3 cases by rotations and / or replacing $x_i(\neg x_i)$ with $\neg x_i(x_i)$.

In Theorem 2 we show that EXT EC is NP-hard for subcubic bipartite graphs. In order to this, we proposed a reduction from (3,B2)-SAT in which the corresponding construction does not preserve planarity. In the following, we will propose a new construction containing 3 different variable gadgets.

Theorem 33. EXT EC is NP-hard for planar bipartite graphs of maximum degree 3.

Proof. The proof is based on a reduction from 4P3C3SAT. We start from graph G and build a planar bipartite graph $H = (V_H, E_H)$ by replacing every node x_i in G with one of the three variable gadgets $H(x_i)$ which are illustrated in Fig. 2. The forced edge set U_i , corresponding to variable gadget $H(x_i)$, contains $t_i l_i, r_i f_i$ for case 1, $t_i^1 l_i^1, r_i^1 f_i^1, t_i^2 l_i^2, r_i^2 f_i^2$ for case 2 and $t_i^1 l_i^1, t_i^2 l_i^2, r_i f_i$ for case 3. Let $U = \bigcup_{1 \leq i \leq n} U_i$, the set of forced edges of H . This construction can be done in polynomial time and the final graph H is planar bipartite with maximum degree 3. We now claim that I is satisfiable iff H admits a minimal edge cover containing U .

Suppose T is a truth assignment of I which satisfies all clauses. For each clause c_j , let $h(j)$ be an index such that variable $x_{h(j)}$ satisfies clause c_j for T and let $J = [n] \setminus h([m])$ be the unused indices by mapping h . We construct a minimal edge cover S of H by considering all possibilities of $H(x_i)$:

- for each variable gadget $H(x_i)$ which complies with "case 1" we set:

$$S_1 := \{t_{h(j)} c_j, m_{h(j)} r_{h(j)} : T(x_{h(j)}) = true, x_{h(j)} \text{ appears positively in } c_j\} \\ \cup \{f_{h(j)} c_j, m_{h(j)} l_{h(j)} : T(x_{h(j)}) = false, x_{h(j)} \text{ appears negatively in } c_j\} \\ \cup \{m_i r_i : i \in J\}.$$

- for each variable gadget $H(x_i)$ which complies with "case 2" by assuming $h(j) = k$ we set:

$$S_2 := \{t_k^1 c_j (t_k^2 c_j), m_k^1 r_k^1, r_k^1 p_k^1, m_k^2 r_k^2, r_k^2 p_k^2 : T(x_k) = true \wedge t_k^1 c_j \in E_H (t_k^2 c_j \in E_H)\} \\ \cup \{f_k^1 c_j (f_k^2 c_j), m_k^1 l_k^1, l_k^2 p_k^1, m_k^2 l_k^2, l_k^1 p_k^2 : T(x_k) = false \wedge f_k^1 c_j \in E_H (f_k^2 c_j \in E_H)\} \\ \cup \{l_i^1 p_i^2, l_i^1 m_i^1, l_i^2 m_i^2, l_i^2 p_i^1 : i \in J\}.$$

- for each variable gadget $H(x_i)$ which complies with "case 3" by assuming $h(j) = k$ we set:

$$S_3 := \{t_k^1 c_j (t_k^2 c_j), m_k^1 r_k, m_k^2 r_k : T(x_k) = true \wedge t_k^1 c_j \in E_H (t_k^2 c_j \in E_H)\} \\ \cup \{f_k c_j, m_k^1 l_k^1, m_k^2 l_k^2 : T(x_k) = false\} \\ \cup \{l_i^1 m_i^1, l_i^2 m_i^2 : i \in J\}.$$

Finally we set $S = S_1 \cup S_2 \cup S_3 \cup U$. One can easily check that S is a minimal edge cover of H .

Conversely, suppose S is a minimal edge cover of H containing U . By minimality of S we propose an assignment T of I depending on different types of variable gadgets of H as follows:

- If $H(x_i)$ complies with case 1, in order to cover vertex m_i , the edge cover S either contains $m_i r_i$ or $m_i l_i$ (not both by minimality). This means that we set $T(x_i) = true$ (resp., $T(x_i) = false$) if $m_i r_i \in S$ (resp., $m_i l_i \in S$).
- If $H(x_i)$ complies with case 2, in order to cover vertices $m_i^1, m_i^2, p_i^1, p_i^2$, the edge cover S contains exactly one of edges in pairs $(l_i^1 m_i^1, r_i^1 m_i^1), (l_i^2 m_i^2, r_i^2 m_i^2), (l_i^1 p_i^2, r_i^2 p_i^2), (r_i^1 p_i^1, l_i^2 p_i^1)$. Hence, we set

$$- T(x_i) = true \text{ if } \{l_i^1 m_i^1, l_i^1 p_i^2, l_i^2 p_i^1, l_i^2 m_i^2\} \cap S = \emptyset, \text{ and}$$

– $T(x_i) = \text{false}$ if $|\{l_i^1 m_i^1, l_i^1 p_i^2, l_i^2 p_i^1, l_i^2 m_i^2\} \cap S| \geq 1$.

- If $H(x_i)$ complies with 3, in order to cover vertices m_i^1, m_i^2 , S contains exactly one of edges in the pairs $(r_i m_i^1, l_i^1 m_i^1), (r_i m_i^2, l_i^2 m_i^2)$. This means that we set

– $T(x_i) = \text{true}$ if $S \cap \{l_i^1 m_i^1, l_i^2 m_i^2\} = \emptyset$ and
– $T(x_i) = \text{false}$ if $|S \cap \{l_i^1 m_i^1, l_i^2 m_i^2\}| \geq 1$.

We obtain a valid assignment T . Since S covers all vertices of \mathcal{C} , T satisfies all clauses of I . ■

In the previous construction, we started from a planar graph G and made a new graph H by replacing each vertex $x_i \in V$ with one of the three different variable gadgets $H(x_i)$ which are depicted in Figure 2.

In the following we will introduce three new constructions in order to prove NP-hardness of EXT DS, EXT EDS and EXT EM for subcubic planar bipartite graphs. All of the constructions include variable and clause gadgets, the clause gadgets are very similar to what we proposed for these problems before but in order to maintain planarity we introduce three different variable gadgets.

Theorem 34. *EXT DS is NP-hard for planar bipartite graphs of maximum degree 3.*

Proof. The proof is based on a reduction from 4P3C3SAT. For an instance I of 4P3C3SAT with clause set $\mathcal{C} = \{c_1, \dots, c_m\}$ and variable set $\mathcal{X} = \{x_1, \dots, x_n\}$, we build a planar bipartite graph $H = (V_H, E_H)$ with maximum degree 3 together with a set $U \subseteq V_H$ of forced vertices as an instance of EXT DS.

For each variable x_i , similar to what we did in Theorem 33, we propose 3 different gadgets $H(x_i)$. As is depicted in Fig. 10, the forced vertex set U_{x_i} corresponding to gadget $H(x_i)$ contains m_i for case 1, $\{p_i^1, p_i^2, m_i^1, m_i^2\}$ for case 2 and $\{p_i^1, p_i^2, p_i^3\}$ for case 3.

For each clause $c_j \in \mathcal{C}$, we consider a clause gadget $H(c_j)$ together with a forced vertex set U_{c_j} completely similar to what is defined before in Theorem 26 and illustrated in Fig. 4. Moreover we interconnect with some crossing edges, the subgraphs $H(x_i)$ and $H(c_j)$ using the proposed instructions in Theorem 26. We also set the forced vertex set $U = (\bigcup_{x_i \in \mathcal{X}} U_{x_i}) \cup (\bigcup_{c_j \in \mathcal{C}} U_{c_j})$.

This construction computes in polynomial time, a planar bipartite graph with maximum degree 3. We now claim that (H, U) is a yes-instance of EXT DS iff I has a satisfying assignment T .

Suppose T is a truth assignment of I which satisfies all clauses. We construct a minimal dominating set S from U as follows:

- For each variable gadget $H(x_i)$ complies with "case 1", add t_i (resp., f_i) to S if $T(x_i) = \text{true}$ (resp., $T(x_i) = \text{false}$).
- For each variable gadget $H(x_i)$ complies with "case 2" add t_i^1, t_i^2 (resp., f_i^1, f_i^2) to S if $T(x_i) = \text{true}$ (resp., $T(x_i) = \text{false}$).
- For each variable gadget $H(x_i)$ complies with "case 3" add t_i^1, t_i^2, m_i (resp., f_i, l_i^2, r_i^2) to S if $T(x_i) = \text{true}$ (resp., $T(x_i) = \text{false}$).
- For each clause $c \in \mathcal{C}$, add vertex 1_c to S if $1'_c$ is not dominated by a variable vertex of S and add 2_c to S if $2'_c$ is not dominated by a variable vertex of S .

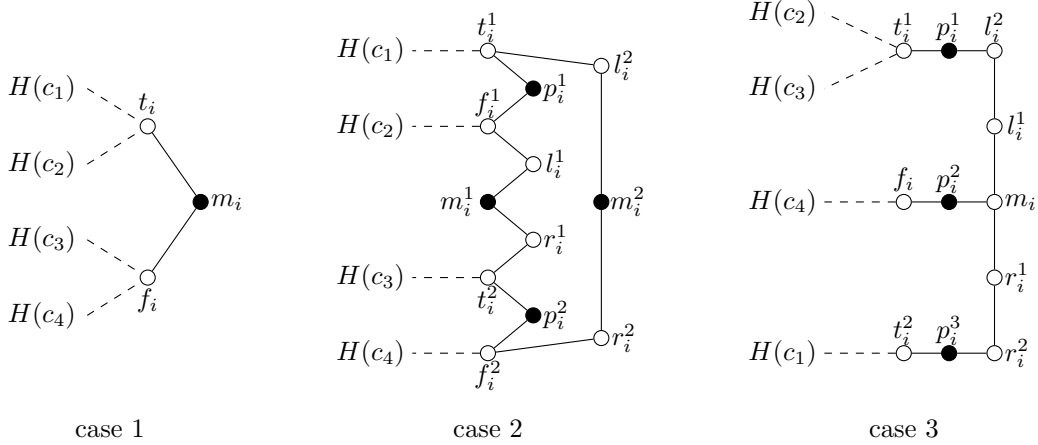

Figure 10: Variable gadgets $H(x_i)$ of Theorem 34. Cases 1, 2, 3 are corresponding to $H(x_i)$, depending on how x_i appears (negated or non-negated) in the four clauses (Here case 3 is rotated). Black vertices denote elements of U_{x_i} . Crossing edges are marked with dashed lines.

Since T is satisfiable, for each clause gadget $H(c)$, at least one of $1'_c, 2'_c$ is dominated by a variable vertex of S . Thus, S is a dominating set that contains U of H . If S is not minimal, it can hence be turned into a minimal dominating set S' by successively removing vertices without private neighbors from the ones that we added to U .

Conversely, suppose S is a minimal dominating set of H with $U \subseteq S$. We show that in Theorem 26, for each clause gadget $H(c)$ at least one of $1'_c, 2'_c$ needs to be dominated by a variable gadget vertex thus there is an assignment T which satisfies all clauses of I . We now show that T is a valid assignment, in order to this, we consider all variable gadgets independently:

- If $H(x_i)$ complies with case 1, by minimality, S cannot contain both t_i, f_i , So we set $T(x_i) = true$ if $\{f_i\} \cap S = \emptyset$ and otherwise we set $T(x_i) = false$.
- If $H(x_i)$ complies with case 2, by minimality, S cannot contain both vertices in each pair $(t_i^1, f_i^1), (t_i^1, f_i^2), (t_i^2, f_i^1), (t_i^2, f_i^2)$, so we set $T(x_i) = true$ if $S \cap \{f_i^1, f_i^2\} = \emptyset$ and otherwise we set $T(x_i) = false$.
- If $H(x_i)$ complies with case 3, by minimality, S cannot contain both vertices in each pair $(t_i^1, f_i), (t_i^2, f_i)$, hence we set $T(x_i) = true$ if $S \cap \{f_i\} = \emptyset$ and otherwise, we set $T(x_i) = false$.

■

Theorem 35. EXT EDS is NP-hard for planar bipartite graphs of maximum degree 3.

Proof. The proof is similar to the proof of Theorem 34. For an instance I of 4P3C3SAT with clause set $\mathcal{C} = \{c_1, \dots, c_m\}$ and variable set $\mathcal{X} = \{x_1, \dots, x_n\}$, we build a planar bipartite graph $H = (V_H, E_H)$ with maximum degree 3 together with a set $U \subseteq E_H$ of forced edges as an instance of EXT EDS.

For each variable x_i we propose 3 different gadgets $H(x_i)$, which is depicted in Fig. 11, the forced edge set U_{x_i} corresponding to gadget $H(x_i)$ contains $\{m_i r_i, r_i p_i\}$ for case 1, $\{p_i^j r_i^j, r_i^j m_i^j : 1 \leq j \leq 4\}$ for case 2 and $\{p_i^1 p_i^2, p_i^2 p_i^3, p_i^5 p_i^6, p_i^6 p_i^7, m_i^2 f_i\}$ for case 3.

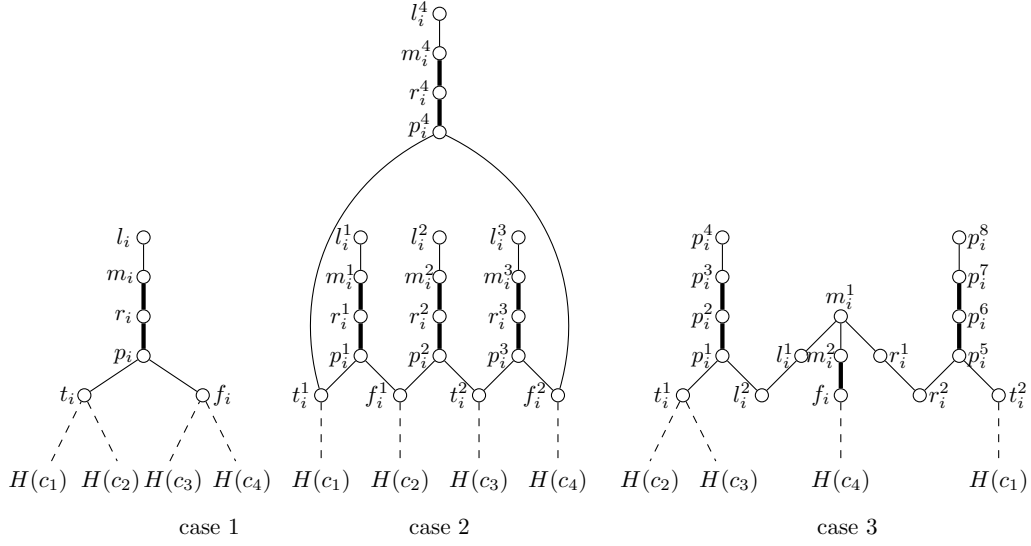

Figure 11: Variable gadgets $H(x_i)$ of Theorem 35. Cases 1, 2, 3 are corresponding to $H(x_i)$, depending on how x_i appears (negated or non-negated) in the four clauses (Here case 3 is rotated). Bold edges denote elements of U_{x_i} . Crossing edges are marked by dashed lines.

For each clause $c_j \in \mathcal{C}$, we consider a clause gadget $H(c_j)$ and a forced edge set U_{c_j} similar to what we did in Theorem 27, each clause gadget $H(c_j)$ contains 8 vertices and 7 edges where $|U_{c_j}| = 2$ (see Fig. 5). Moreover we interconnect with some crossing edges the subgraphs $H(x_i)$ and $H(c_j)$ by the proposed instructions in Theorem 27. We also set the forced edge set $U = (\bigcup_{x_i \in \mathcal{X}} U_{x_i}) \cup (\bigcup_{c_j \in \mathcal{C}} U_{c_j})$.

This construction computes in polynomial time, a planar bipartite graph with maximum degree 3. We now claim that T is a satisfying assignment of I iff H has a minimal edge dominating set containing U . ■

For the last proof in this section we will show NP-hardness of EXT EM.

Theorem 36. EXT EM is NP-hard for planar bipartite graphs of maximum degree 3.

Proof. The proof is based on a reduction from 4P3C3SAT. For an instance I of 4P3C3SAT with clause set $\mathcal{C} = \{c_1, \dots, c_m\}$ and variable set $\mathcal{X} = \{x_1, \dots, x_n\}$, we build a planar bipartite graph $H = (V_H, E_H)$ with maximum degree 3 together with a set $U \subseteq E_H$ of permitted edges as an instance of EXT EM as follows.

- For each clause c_j , we introduce a clause gadget $H(c_j)$ together with a permitted edge set U_{c_j} which is already explained in detail in Theorem 25.
- For each variable x_i depending on how x_i appears (negated or non-negated) in clauses, we introduce 3 different gadgets $H(x_i)$ together with a set of permitted edges U_{x_i} which is depicted in Fig. 12.
- We also interconnect $H(x_i)$ to $H(c_j)$ where x_i appears positively or negatively in clause c_j by some crossing edges which explained before in Theorem 25. Let U_{cross} be the set of all crossing edges.

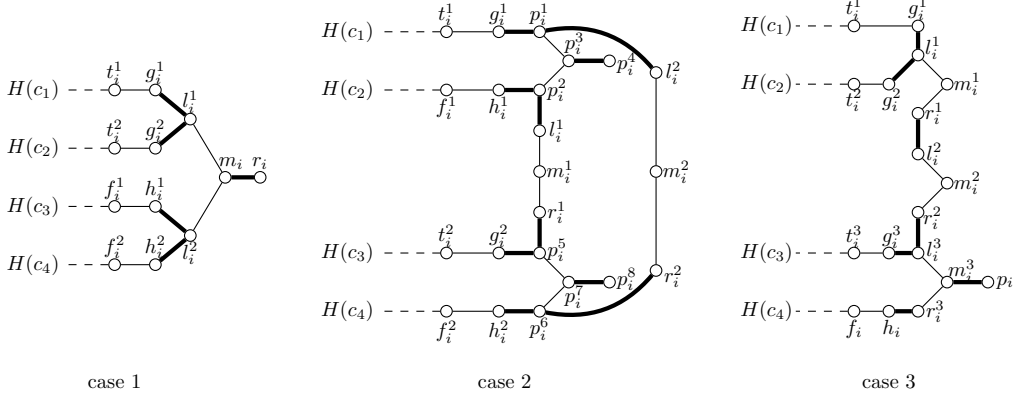

Figure 12: Variable gadgets $H(x_i)$ of Theorem 36. Cases 1, 2, 3 are corresponding to $H(x_i)$, depending on how x_i appears (negated or non-negated) in the four clauses. Edges not in U_{x_i} are drawn bold. Crossing edges are marked with dashed lines.

Let $U = (\bigcup_{c_j \in \mathcal{C}} U_{c_j}) \cup (\bigcup_{x_i \in \mathcal{X}} U_{x_i}) \cup U_{cross}$. This construction computes in polynomial time a planar bipartite graph of maximum degree 3. We now claim that (H, U) is a yes-instance of EXT EM iff T is a satisfying assignment of I .

Suppose T is a truth assignment of I which satisfies all clauses. We produce a maximal edge matching $S \subseteq U$ as follows: the method of choosing edges from clause gadgets and crossing edges is already explained in Theorem 25, so we here just show which edges of each $H(x_i)$ should be in S :

- If $H(x_i)$ complies with case 1, we add $\{m_i l_i^1, h_i^1 f_i^1, h_i^2 f_i^2\}$ (resp., $\{m_i l_i^2, g_i^1 t_i^1, g_i^2 t_i^2\}$) if $T(x_i) = true$ (resp., $T(x_i) = false$),
- If $H(x_i)$ complies with case 2, we add $\{f_i^1 h_i^1, p_i^1 p_i^3, m_i^2 r_i^2, f_i^2 h_i^2, p_i^5 p_i^7, l_i^1 m_i^1\}$ if $T(x_i) = true$; otherwise, if $T(x_i) = false$ we add $\{p_i^2 p_i^3, t_i^1 g_i^1, l_i^2 m_i^2, p_i^6 p_i^7, t_i^2 g_i^2, m_i^1 r_i^1\}$,
- If $H(x_i)$ complies with case 3, we add $\{l_i^1 m_i^1, l_i^2 m_i^2, l_i^3 m_i^3, f_i h_i\}$ if $T(x_i) = true$; otherwise, if $T(x_i) = false$ we add $\bigcup_{1 \leq j \leq 3} \{r_i^j m_i^j, t_i^j g_i^j\}$.

Conversely, suppose $S \subseteq U$ is a maximal edge matching of H . Because of maximality, for each clause gadget $H(x_j)$ there exists at least one crossing edge in S incident to a vertex of $H(x_j)$. This means that there is an assignment T which satisfies all clauses of I . We now show that T is a valid assignment:

- If $H(x_i)$ complies with case 1, by maximality either $l_i^1 m_i$ or $l_i^2 m_i$ (not both) is in S , hence we set $T(x_i) = true$ (resp., $T(x_i) = false$) if $l_i^1 m_i^1 \in S$ (resp., $l_i^2 m_i$),
- If $H(x_i)$ complies with case 2, by maximality either $S_1 = \{p_i^1 p_i^3, m_i^2 r_i^2, p_i^5 p_i^7, l_i^1 m_i^1\}$ or $S_2 = \{p_i^2 p_i^3, l_i^2 m_i^2, p_i^6 p_i^7, m_i^1 r_i^1\}$ (not both) is in S , so we set $T(x_i) = true$ (resp., $T(x_i) = false$) if $S_1 \in S$ (resp., $S_2 \in S$),
- If $H(x_i)$ complies with case 3, by maximality either $S_1 = \bigcup_{1 \leq j \leq 3} \{l_i^j m_i^j\}$ or $S_2 = \bigcup_{1 \leq j \leq 3} \{r_i^j m_i^j\}$ (not both) is in S , hence we set $T(x_i) = true$ (resp., $T(x_i) = false$) if $S_1 \in S$ (resp., $S_2 \in S$).

■

12 Exponential Time Hypothesis and Exact Algorithms

Impagliazzo, Paturi and Zane initiated the analysis of computationally hard problems under the hypothesis that there are (basically) no $2^{o(n)}$ (i.e., no sub-exponential) algorithms for solving 3-SAT, where n is the number of variables; the number of clauses is somehow subsumed into this expression, as this number can be assumed to be sub-exponential in n (after applying the famous sparsification procedure); cf. [23]. This hypothesis³ is also known as *Exponential Time Hypothesis*, or ETH for short. This type of study was furthered in many directions; for us, the most relevant seems to be recent work of Jonsson *et al.* [25] who showed, among other things, that ETH extends to NOT-ALL-EQUAL-3SAT, or NAE-3SAT, for short. So, if ETH is true, then there exists no sub-exponential algorithm for NAE-3SAT, either. We also refer to the survey article [29].

Re-analyzing our NP-hardness (or W[1]-hardness) constructions, we can now immediately deduce the following results. This is interesting to see, as for all our graph extension problems, we can easily find $2^{O(n+m)}$ algorithms on instances with n vertices and m edges. Hence, the following results show that, up to constant-factor improvements of the basis of the exponential term (which is of course crucial for some practical considerations), these trivial algorithms are optimal under ETH.

Corollary 37. *Assuming ETH, there is no $2^{o(n+m)}$ -algorithm for solving n -vertex, m -edge instances of EXT EC in bipartite graphs of maximum degree 3, even if the required edges build an edge matching. (From Theorem 2)*

Corollary 38. *Assuming ETH, there is no $2^{o(n+m)}$ -algorithm for solving n -vertex, m -edge instances of EXT EM in bipartite graphs of maximum degree 3. (From Theorem 25)*

Corollary 39. *Assuming ETH, there is no $2^{o(n+m)}$ -algorithm for solving n -vertex, m -edge instances of EXT DS in bipartite graphs of maximum degree 3. (From Theorem 26)*

Corollary 40. *Assuming ETH, there is no $2^{o(n+m)}$ -algorithm for solving n -vertex, m -edge instances of EXT EDS in bipartite graphs of maximum degree 3. (From Theorem 27 or from Theorem 11)*

We are now turning to planar variants of our problems. Instead of going through them one-by-one, we only provide one corollary summarizing our observations. The main reason for being able to state Corollary 19 that easily is that all our reductions presented in Section 11 start out from the 4P3C3SAT problem introduced earlier by J. Kratochvíl [27], and all these reductions do not blow up the instances too much. Now, Kratochvíl's NP-hardness proof for 4P3C3SAT is based on Lichtenstein's construction [28] that in turn proved that 3SAT, restricted to planar instances, is still NP-hard. Now, while Lichtenstein's construction contains a quadratic blow-up, Kratochvíl's refinement is linear in size only, so that we can use it first to state an ETH result for 4P3C3SAT and then make use of it for the problems we are interested in for our paper. This reasoning shows Proposition 18 and finally Corollary 19.

EXT BP delivers a nice example that it is not always that easy to take the textbook construction from Garey and Johnson for NP-hardness to immediately get hardness results under ETH that match existing algorithms. The classical reduction to show NP-hardness of 3-PARTITION is from 4-PARTITION, which again reduces from 3D-MATCHING, which reduces from 3-SAT. Instances of 3D-MATCHING have $2mn + 3m + 2m^2n(n - 1)$ many triples according to [21]. Each of the three involved sets W, X, Y has $O(nm)$ many elements. Then, the corresponding 4-PARTITION instance has $O(|M|)$ many elements. The corresponding 3-PARTITION instance has $O(x^2)$ many elements if the 4-PARTITION instance has x elements. Putting things together, a straight analysis would only give a relatively weak non-existence of an $O(2^{o(\sqrt[8]{\ell})})$ algorithm for EXT BP with ℓ items under ETH.

³Actually, a slightly different variant of it.

We have to apply another route to obtain the desired result. According to [24, Corollary 3.2], there is no algorithm deciding 4-PARTITION with n items in time $2^{o(n)} \times |I|^{O(1)}$, unless ETH fails. As we can adapt our reduction from Theorem 3 to reduce from this problem, we can formulate Corollary 20.

An Exact Algorithm for Ext BP The correctness of the DP algorithm claimed in Theorem 15 relies on the following characterization.

Lemma 41. *A partition solution π is minimal if and only if there is a constant $0 < \delta < 1/2$ such that for the two bins (sets) $X_1, X_2 \in \pi$ of smallest weight, with $w(X_1) \leq w(X_2)$, $w(X_1) > \delta$ and $w(X_2) \geq 1 - \delta$.*

Proof. The partition π is not minimal if and only if there are two bins, i.e., sets in the partition, that can be merged without violating the size constraint of one. For a set of bins, any two of them, say, A and B , can be merged if and only if there is some δ , $0 < \delta < 1/2$, such that the weight of A is at most δ and the weight of B is at most $1 - \delta$. To avoid this situation, we only have to consider merging the two bins of smallest weight. ■

The bound of the previous lemma is only helpful, because we do not have to test all (uncountably many) values of δ , but only those that can be realized within our given instance (X, w, π_U) of EXT BP.

Observation 42. *It is sufficient to test all δ , $0 < \delta < 1/2$, such that there is a subset of items of weight δ or $1 - \delta$ in the given instance.*

Hence, for all δ , $0 < \delta < 1/2$ that can be realized by the instance (X, w, π_U) of EXT BP, we consider the following problem; notice that only 2^n problems are generated this way.

EXT δ -BP

Input: A set $X = \{x_1, \dots, x_n\}$ of items, a weight function w associating rational numbers $w(x_i) \in (0, 1)$ to items, a partition π_U of X .

Question: Does there exist a minimal feasible partition π'_U with $\pi_U \leq_X \pi'_U$ such that, except for $Y_{\min} \in \pi'_U$, all sets $Y \in \pi'_U$ satisfy $1 - \delta \leq w(Y) \leq 1$, while Y_{\min} satisfies $\delta < w(Y_{\min}) \leq 1$?

The overall idea is similar to DP solutions solving well-known vertex ordering problems; see [8]. One of the main ideas is to study all orderings in which items could have been put into bins. This would be too expensive for our purposes. Therefore, we use dynamic programming in order to maintain the possibility to consider all but one of the bins to be closed. It is sufficient to store the set of items that has already been packed into bins that are considered closed, plus one that is currently open. Also, we will maintain the invariant that all closed bins contain at least $(1 - \delta)$ of weight, so that potentially only the last, still open, bin might violate the constraint of the previous lemma and contain at most δ of weight.

To this purpose, let $T_\delta[Y, L] = 1$ if, maintaining the restriction imposed by π_U , there is a possibility to pack $Y \subseteq X$ into bins such that all but the last bin described by L contain a weight of at least $1 - \delta$, while $w(L) \in [0, 1]$. If such a special packing does not exist, we set $T_\delta[Y, L] = 0$. In our setting, this means that $T_\delta[Y, L] = 1$ certifies the existence of a partition π of Y such that, for all sets $B \in \pi$ different from L , $w(B) \geq 1 - \delta$. Also, whenever two elements $x, y \in Y$ are put into two different sets by π_U , this is the case for π , as well.

Clearly, there are 3^n many possibilities for choosing $Y \subseteq X$ and L as a subset of Y . This determines the space requirements of our algorithm.

In our dynamic programming solution, we compute the entries of the table $T_\delta[\cdot, \cdot]$ for all $Y \subseteq X$ with increasing size. For the smallest size, $|Y| = 0$, we initialize $T_\delta[\emptyset, \emptyset] = 1$. By induction, assume that $T_\delta[Y, L]$ has been correctly filled for all Y such that $|Y| \leq c$ and for all $L \subseteq Y$. Now, consider some Y with $c + 1$ many elements. Initialize $T_\delta[Y, L] = 0$ for all $L \subseteq Y$. Walk through all

$y \in Y$, basically looking for the last element that was put in, in order to produce a solution for Y . If $T_\delta[Y \setminus \{y\}, L] = 1$ and $w(L \cup \{y\}) \leq 1$ for any $L \subseteq Y \setminus \{y\}$, we can update $T_\delta[Y, L \cup \{y\}] = 1$, because we can add y to the last, not yet closed bin, unless the open bin would then violate a constraint imposed by π_U , i.e., unless there is some $x \in L$ and some $A, B \in \pi_U$ with $x \in A, y \in B, A \neq B$. If $T_\delta[Y \setminus \{y\}, L] = 1$ and $w(L) \geq 1 - \delta$ for any $L \subseteq Y \setminus \{y\}$, we can update $T_\delta[Y, y] = 1$. The last case corresponds to closing a previously open bin. This way, we can correctly fill all table entries of $T_\delta[Y, L]$ for $|Y| = c + 1$ and $L \subseteq Y$. By induction, the whole table $T_\delta[\cdot, \cdot]$ can be correctly filled.

After having filled the table for $T_\delta[X, L]$ for all $L \subseteq X$ as described by the recursion, we walk once more through all these table entries and look for some $L \subseteq X$ such that $w(L) > \delta$ and $T_\delta[X, L] = 1$. If such an L can be found, then X can be partitioned such that π_U is obeyed and such that all but one bin contain weight at least $1 - \delta$, while the exceptional bin contains weight more than δ . Hence, this partition is a minimal extension of π_U as required. If no such L can be found, then there is no minimal extension of π_U that satisfies the weight restriction imposed by δ .

The overall running time for solving EXT δ -BP is clearly dominated by filling the DP table $T_\delta[\cdot, \cdot]$. This can be estimated by

$$\sum_{c=0}^n \binom{n}{c} c 2^c \leq n 3^n.$$

As 2^n many such tables have to be computed, we arrive at the claimed running time for solving EXT BP.

13 Exact algorithms for the graph problems

In the following, we will first explain quite to some detail both the intuition and a rather concrete implementation of an algorithm for EXT VC, because — although not being in the focus of the studies in this paper — this is the simplest of all considered problems from the point of view of developing algorithms. In the next subsection, we then show how to adapt these ideas for developing algorithms for the other graph problems. Finally, we argue for exact exponential-time algorithms. All these results are claimed and addressed in the main part of the paper.

13.1 A treewidth algorithm for Ext VC

We assume that the graph G that we are considering has treewidth at most t and that we are given a nice tree decomposition of G .

We have to specify what happens at the leaf nodes, and then (in the recursion) what to do in introduce, forget and join nodes, assuming we are given a nice tree decomposition.

We first define the concept of states appropriate for VC EXT.

Of course, there should be a distinction between a vertex being or not being in the vertex cover. However, in contrast to the classical decision version, this is not sufficient, because once a vertex is put into the cover (or is assumed to be there), we also must store the fact if (or if not) a vertex in the cover has a private edge, as this proved minimality of the solution.

initialization: As we are assuming a nice tree decomposition, initial nodes contain one vertex only. This vertex is either (1) not in the cover or (2) it is in the cover but does not have (yet) a private edge. In the case that the specific vertex that we add a vertex that is bound to belong to the (given) pre-solution, then only case (2) would apply. This describes all situations corresponding to (potential) solutions of the VC extension problem.

introduce nodes: There is a (potential) solution to the extension problem if one of the following cases apply.

1. The new vertex is determined not to be in the vertex cover. Of course, this also means that it does not belong to the specified pre-solution. This is only feasible if all neighbors of this

vertex (in the current bag) are determined to belong to the vertex cover. Also, if they might not have seen a private edge so far, now they do.

2. The new vertex is determined to belong to the vertex cover. This new vertex is having a private edge if and only if one of its neighbor in the current bag is determined not to belong to the vertex cover.

forget nodes: One of the following two cases might apply.

1. The vertex that we like to forget is determined not to be in the vertex cover and this is also the case for one of its neighbor, or it is put into the cover but does not have a private edge yet. This is surely not leading to any feasible (extension) solution, so that such situations must be excluded.
2. If the vertex that we like to forget is put into the vertex cover and has a private edge, or if it is determined not to be in the vertex cover but all neighbors are in the cover, then we can safely remove it.

Let us present our algorithm more formally in the following. To each bag with k vertices, we associate (conceptually) a table with 3^k many rows, indexed by tuples from $\{0, 1, 2\}^k$, which either carries the value 1 (meaning that the association of 0, 1, 2 to the vertices of the bag may still be extended to some (minimal) extension of the given pre-solution) or the value 0 (no extension is possible). Alternatively, we can view this table as a subset of $\{0, 1, 2\}^k$, containing the rows of the table with value one. Here, the value 0 means that the associated vertex does not belong to the cover, 1 means that this vertex does belong to the cover but does not have a private edge (so far) and 2 means that the vertex belongs to the cover and possesses a private edge.

Let U be the given pre-solution and $G = (V, E)$ be the given graph. Also, we are given a nice tree decomposition of G of width at most $t \leq |V|$. Finally, we assume a strict linear order $<$ on V , which naturally transfers to subsets of vertices, so that we can interpret tuples from $\{0, 1, 2\}^k$ in a unique way as assigning 0, 1, 2 to vertices in a bag consisting of k vertices.

If v is a vertex that is belonging to a leaf node of the tree decomposition, then we associate the set $\{0, 1\}$ to this bag if $v \notin U$, and $\{1\}$ if $v \in U$.

Assume that B' is a bag in the decomposition such that $B := B' \cup \{v\}$ is the parent node in the tree decomposition. In other words, B is an *introduce node*. Assume that the set (table) T' is associated to B' . We are going to describe the table T associated to B in the following. Assume, without loss of generality, that v is bigger than any vertex from B' in the ordering on V . Let $1 \leq i_1 < i_2 < \dots < i_\ell \leq |B'|$ be the indices of the vertices of $N(v) \cap B$. Also, define $\widehat{0} = 0$ and $\widehat{1} = \widehat{2} = 2$. For all tuples $(x_1, \dots, x_{|B'|})$ in T' , we put $(\widehat{x_1}, \dots, \widehat{x_{|B'|}}, 0)$ into T iff $x_{i_1}, \dots, x_{i_\ell} \in \{1, 2\}$ and $v \notin U$. Namely, all neighbors of v have now found a private edge. Moreover, for all tuples $(x_1, \dots, x_{|B'|})$ in T' , we put $(x_1, \dots, x_{|B'|}, 1)$ into T iff $x_{i_1}, \dots, x_{i_\ell} \in \{1, 2\}$. Finally, for all tuples $(x_1, \dots, x_{|B'|})$ in T' , we put $(x_1, \dots, x_{|B'|}, 2)$ into T iff, for some $j \in \{1, \dots, \ell\}$, $x_{i_j} = 0$.

Assume that B' is a bag in the decomposition such that $B := B' \setminus \{v\}$ is the parent node in the tree decomposition. In other words, B is a *forget node* and v is the vertex that has to be forgotten. Assume, w.l.o.g., that v is last in the ordering of the vertices of B' . Assume that the set (table) T' is associated to B' . We are going to describe the table T associated to B in the following. If $(x_1, \dots, x_{|B'|}, 2) \in T'$, then $(x_1, \dots, x_{|B|}) \in T$.

We can always do a sort of clean-up operation after setting up one new table: Whenever $(x_1, \dots, x_{|B|}), (x'_1, \dots, x'_{|B|}) \in T$ such that always either $x_i = x'_i$ or $x_i = 2$ and $x'_i = 1$, then we can delete $(x'_1, \dots, x'_{|B|})$ from T . Namely, there seems to have been a way to determine a private edge for the vertex corresponding to x_i in B outside of B in some solution that, from the point of view of B , looks identical to another solution where x_i does not have a private edge so far. As finally the (positive) decision about extensibility will be based on finding 2 and 0 only in the settings, we can ignore the setting that we propose to delete. In conclusion, T will at no point contain more than $2^{|B|}$ many elements.

Assuming clean-up, we can also add the following rule in the forget-node case: If $(x_1, \dots, x_{|B|}, 0) \in T'$, then $(x_1, \dots, x_{|B|}) \in T$.

This clean-up also simplifies the join operation considerably. Now, we first turn the two sets into tables with binary (0/1) k -tuples that map to the unique (due to clean-up) tuple from $\{0, 1, 2\}^k$. Then, one performs the following: If a binary k -tuple $(x_1, \dots, x_{|B|})$ has corresponding ternary tuples $(y_1, \dots, y_{|B|}), (z_1, \dots, z_{|B|})$ in the two child bags, we will put

$$(\max\{y_1, z_1\}, \dots, \max\{y_{|B|}, z_{|B|}\})$$

into the parent's bag. Conversely, if a binary tuple is only showing up in the table of one child node, then this must mean that some 0-entry of this tuple would correspond to a situation that is unfeasible in the other child node, because then some of the edges connected to the corresponding vertex in the subgraph that is treated by that child bag is not covered. Hence, in such a situation no tuple is added to the parent table.

This reasoning proves that EXT VC can be solved in time $\mathcal{O}^*(2^{tw})$, which matches the time known for the classical corresponding decision problem.

13.2 Treewidth-based algorithms for other graph problems

This running time of $\mathcal{O}^*(2^{tw})$ can be also matched by the extension variant of domination. The intuitive reason behind is that we are not interested in the value of a solution (not aiming at solutions of small cardinality) but only at the existence of such solutions. This also allows us to avoid using subset folding and other similar techniques; it is sufficient to update the information about unique concretizations of the binary vectors associated to vertices in each bag.

To be more concrete, again (for dominating set) we basically have to store a collection of binary vectors (telling if a vertex belongs to a dominating set or not) and then a pointer to the more refined version saying if a vertex in a dominating set already has a private neighbor or not and also if a vertex not in the dominating set is neighbor of a vertex in a dominating set or not. In both cases, we have a kind of domination relation between the states (as with vertex cover).

Alternatively, we may refer to the algorithm given for UPPER DOMINATION parameterized by treewidth in [3].

For edge domination as well as for edge cover and for maximum matching, one has to adapt our ideas a bit more. To sum up these ideas:

- Given a nice tree decomposition, we can express for each vertex if it is incident to an edge that is belonging to a solution or not. If it is incident to an edge belonging to a solution, one can distinguish between the case that this is already satisfied or whether this will be satisfied only in the future.
- Minimality and the related notion of privateness is specific to each problem. We will detail this in the following.

We are now discussing the three problem variants separately, sketching some further ideas.

- For matching, there should be no possibility to insert another edge in the current solution. This means that we should keep track of if a vertex that is not incident to an edge in the currently considered matching is (not) neighbor of a vertex that is incident to some edge in this matching. Conceptually, this means that we have to consider the following states in our dynamic program:
 - 0: a vertex that is not incident to an edge of the matching but is known to be neighbor to some vertex incident to an edge of the matching.
 - $\hat{0}$: a vertex that is not incident to an edge of the matching and is not yet proven to be a neighbor to any vertex incident to an edge of the matching.

1: a vertex that has already been paired up with another neighboring vertex, building together an edge of the matching.

$\hat{1}$: a vertex that is assumed to be incident to an edge in the matching, but so far has not found its partner.

In the initialization at the leaf nodes, we only use $\hat{0}$ or $\hat{1}$. Clearly, if x is incident to an edge contained in the pre-solution, then the leaf nodes corresponding to x will only include the case $\hat{1}$ as the labeling for x .

If we introduce a vertex in an introduce node, then the status $\hat{0}$ might be updated towards 0, and similarly the status $\hat{1}$ might be updated to 1, assuming that the conditions are satisfied by setting the new vertex to $\hat{1}$ or to 1 (in the second case, when the status of a neighbor turns from $\hat{1}$ to 1, clearly this pairing-up means that the status of the newly introduced vertex is 1; also notice that in that case, there is exactly one neighbor of the newly introduced vertex that had status $\hat{1}$ and no neighbor with status 1). In a forget node, if we associate status 0 or 1 to the vertex x that is going to be forgotten, this is fine, but table entries that associate $\hat{0}$ or $\hat{1}$ to x will be ignored in (not carried over to) the table associated to the forget node.

In any case, we have to make sure that the DP takes care of the natural consistency requirements of the status information, which is as follows.

- There should never be two neighboring vertices labeled 0 or $\hat{0}$.
 - Finally, we have to look into the table of the root bag if there is any table entry consisting of 0 and 1 only (i.e., no $\hat{0}$ or $\hat{1}$ are around). There is an extension to the given pre-solution if and only if this is the case.
- For edge cover, the states of the vertices can keep track of the information if they serve as a private vertex to some edge. In fact, this is only possible if there is exactly one edge in the cover that is incident to this vertex. Hence, the natural states of a vertex are one of the following:
 - 0: not being incident to any edge in the cover but should be incident to an edge later on;
 - 1: being incident to exactly one edge in the cover (and hence being private to some edge);
 - $\hat{1}$: being incident to at least one edge in the cover (but not being private to any edge).

Initially, at leaf nodes, vertices have status 0. Whenever a vertex is inserted (introduce node), the status of neighbors changes from 0 to either 1 or $\hat{1}$ (both is possible). In introduce nodes, also the pre-solution is taken care of, as then 0 is not an admissible state. When looking into forget nodes, table rows that contain 0 as a state of the vertex that is forgotten will not contribute to the new table. With join nodes, table rows combine according to rules like: If there is status 0 in one table row but 1 in the other, then this combines to 1 in the parent table row; etc.

- For edge domination, the situation is the most complicated. We have the following states.
 - 0: No edges from the EDS are incident to such vertices. This means that all edges incident to a vertex colored 0 can serve as private edges. Also, in order to form a valid edge domination set at all, it is clear that the set of all 0-colored vertices forms an independent set.
 - 1: At least one neighbor is 0-colored, and at most one edge from the EDS is incident to a 1-colored vertex. Hence, the edge from the EDS that is incident with a 1-colored vertex has a private neighboring edge emanating from the 1-colored vertex. In the course of the DP algorithm, 1 signals that indeed one neighbor is 0-colored, while the variant $\hat{1}$ has the same semantics as 1 has, except that one still expects the 0-colored neighbor to appear in the future. Hence, in forget nodes, table entries that contain $\hat{1}$ for the vertex to be forgotten have to be omitted.
 - 2: No neighbor is (ever) 0-colored, but there is an edge of the EDS incident to a 2-colored vertex.

In the terminology introduced so far, all neighbors of a vertex colored 0 will be colored 1 (there will be another variant introduced below that is also fine here).

In the course of the algorithm, the actual EDS should be determined based on the colorings described so far. This leads to three further color variants: 1° , $\hat{1}^\circ$ and 2° . The ring symbol should indicate that such vertices are already paired-up. Here, certain rules have to be obeyed for pairing-up neighboring vertices x and y .

- If x, y both have the status 1, then they can both obtain the status 1° .
- If x, y both have the status $\hat{1}$, then they can both obtain the status $\hat{1}^\circ$.
- If x has the status $\hat{1}$ and y has the status 1, then x can obtain the status $\hat{1}^\circ$ and y can obtain the status 1° .
- If x has status 1 and y has status 2 or 2° , then x can get the status 1° and y the status 2° .
- If x has status $\hat{1}$ and y has status 2 or 2° , then x can get the status $\hat{1}^\circ$ and y the status 2° .

In other words, vertices with color 1 (or $\hat{1}$) can only find one partner (defining the edge in the EDS), while vertices with color 2 can find multiple partners, but all of them carry color 1 or $\hat{1}$.

Initially, at the leaf nodes, only the colors 0, $\hat{1}$, and 2 are available. Moreover, if an edge of the pre-solution is incident to the vertex introduced in the leaf node, then 0 is not a possible color. Moreover, if x is incident to at least two edges from the given pre-solution, then x will have color 2.

In introduce nodes, we could again first distinguish the cases of colors 0, $\hat{1}$, and 2, again keeping in mind that if an edge of the pre-solution is incident to the vertex introduced, then 0 is not a possible color. Moreover, if x is incident to at least two edges from the given pre-solution, then x will have color 2. Let us look more carefully at the situation when introducing vertex x .

Assume we are looking at a particular table row r (given by a tuple of colors uniquely associated to the vertices in the child bag B), with c_1, \dots, c_j being in particular the colors of the neighbors of x among the vertices in B .

- If one of the c_i is 0, then we cannot color x with 0, nor with 2 (or with 2°). Rather, x has to be colored with 1.
- If one of the c_i is $\hat{1}$ and we color x with 0, then $c_i = \hat{1}$ will be replaced by 1 in the table row(s) of the parent bag.

In forget nodes, we have to pair-up yet unpaired vertices that are forgotten. More specifically, assume we are about to forget vertex x and let c_1, \dots, c_j be the colors of the neighbors of x . Let r be a specific row in the child bag. For simplicity, let $r - x$ mean the row obtained from r by omitting the color entry corresponding to x .

- If the color of x in r is 0 or 1° , then $r - x$ is put as a row in the table of the parent bag.
- Likewise, if x is colored 2° . In addition, we change the colors $c_i = 1$ to $c_i = 1^\circ$ or from $c_i = \hat{1}$ to $c_i = \hat{1}^\circ$, either testing all such possibilities (and hence introducing quite a number of new rows in the table of the parent bag) or this can be also enforced, namely, if the corresponding edge incident to x was belonging to the given pre-solution.
- Moreover, if x is colored 1, then pick any neighbor of x with color $c_i = 1$ (or $c_i = 2$ or $c_i = 2^\circ$, resp.) and turn this chosen color to $c_i = 1^\circ$ (or $c_i = 2^\circ$, resp.), implicitly also turning the color of x to 1° before removing x . Hence, x is paired-up if necessary. Notice that this pick is deterministic if x is incident to some edge from the given pre-solution.

In join nodes, consistency checks are necessary. Clearly, identical rows can be copied as long as they do not contain paired-up vertices with a variant of color 1, but if, for instance, vertex x is colored 1° in both bags, then this row cannot be copied, because this means that in x (with color 1) has already found its partner in both sub-parts of the graph (represented by the two children bags), which contradicts our semantics of the color 1. Conversely, there are also compatible vertex colors that are not identical. For instance, if vertex x is colored $\hat{1}$ in one bag but 1 in the other, then in the parent bag, the situation is reflected by the color 1. Likewise, pairing-up of a vertex in one child bag is fine and will combine with the non-paired variant of the same color. Finally, color 2° is compatible both with 2 and with 2° .

Finally, a given pre-solution is extendible if and only if we can find in the root bag a table row where all vertices not colored 0 are already paired-up or (if not) the remaining vertices can be paired-up by computing a matching to match all vertices colored 1 with themselves or with vertices colored 2 or 2° , so that all vertices previously colored 1 or 2 have found their partner.

13.3 Exact exponential-time algorithms

Let us finally sketch how the ideas for treewidth-based algorithms can be used to construct exact algorithms for the graph problems that we study. First, for the vertex problems (like vertex cover or dominating set), it is trivial to come up with an algorithm with running time $\mathcal{O}^*(2^n)$: just cycle through all possible subsets and test for feasibility of the solution, i.e., is this a minimal extension of the given pre-solution? For the edge problems, we can mis-use the earlier derived treewidth-based algorithms, simply observing that a graph with n vertices has pathwidth bounded by n .

Clearly, it would be an idea to develop faster exact algorithms than the ones that follow in a rather trivial way as sketched in the previous paragraph. We leave this for future research.