

Recent Advances in Physical Reservoir Computing: A Review

Gouhei Tanaka^{a,b,1}, Toshiyuki Yamane^c, Jean Benoit Héroux^c,
Ryosho Nakane^{a,b}, Naoki Kanazawa^c, Seiji Takeda^c,
Hidetoshi Numata^c, Daiju Nakano^c, and Akira Hirose^{a,b}

^a*Institute for Innovation in International Engineering Education, Graduate School of Engineering, The University of Tokyo, Tokyo 113-8656, Japan*

^b*Department of Electrical Engineering and Information Systems, Graduate School of Engineering, The University of Tokyo, Tokyo 113-8656, Japan*

^c*IBM Research – Tokyo, Kanagawa 212-0032, Japan*

Abstract

Reservoir computing is a computational framework suited for temporal/sequential data processing. It is derived from several recurrent neural network models, including echo state networks and liquid state machines. A reservoir computing system consists of a reservoir for mapping inputs into a high-dimensional space and a readout for extracting features of the inputs. Further, training is carried out only in the readout. Thus, the major advantage of reservoir computing is fast and simple learning compared to other recurrent neural networks. Another advantage is that the reservoir can be realized using physical systems, substrates, and devices, instead of recurrent neural networks. In fact, such physical reservoir computing has attracted increasing attention in various fields of research. The purpose of this review is to provide an overview of recent advances in physical reservoir computing by classifying them according to the type of the reservoir. We discuss the current issues and perspectives related to physical reservoir computing, in order to further expand its practical applications and develop next-generation machine learning systems.

Keywords: Neural networks, machine learning, reservoir computing, nonlinear dynamical systems, neuromorphic device

2010 MSC: 68Txx, 37N20

¹Correspondence and requests for materials should be addressed to G.T. (gouhei@sat.t.u-tokyo.ac.jp)

Contents

1	Introduction	3
2	Reservoir computing (RC)	5
2.1	Basic framework	5
2.2	Recent trends	7
3	Dynamical systems models for RC	10
3.1	Delayed dynamical systems	10
3.2	Cellular automata	11
3.3	Coupled oscillators	12
4	Electronic RC	14
4.1	Integrated circuits	14
4.1.1	ESN-type circuits	15
4.1.2	LSM-type circuits	15
4.1.3	Time-delay circuits	16
4.2	Memristive RC	16
4.2.1	Neuromemristive circuits	17
4.2.2	Memristor circuits	18
5	Photonic RC	20
5.1	Optical node arrays	20
5.2	Time-delay optical systems	21
5.2.1	Opto-electronic feedback	21
5.2.2	Optical feedback in a laser cavity	24
5.3	Other configurations	25
6	Spintronic RC	26
7	Mechanical RC	28
8	Biological RC	30
8.1	Brain regions	30
8.2	<i>in-vitro</i> cultured cells	32
9	Others	34
10	Conclusions and outlook	35

1. Introduction

Artificial neural networks (ANNs) constitute the core information processing technology in the fields of artificial intelligence and machine learning, which have witnessed remarkable progress in recent years, and they are expected to be increasingly employed in real-world applications (Samarasinghe, 2016). ANNs are computational models that mimic biological neural networks. They are represented by a network of neuron-like processing units interconnected via synapse-like weighted links. Network architectures of ANNs are typically classified into feedforward networks (Schmidhuber, 2015) and recurrent networks (Mandic et al., 2001), the choice of which depends on the type of computational task. Feedforward neural networks (FNNs) are mainly used for *static* (non-temporal) data processing, as individual input data are independently processed even if they are given sequentially. FNNs are capable of approximating nonlinear input-output functions. On the other hand, recurrent neural networks (RNNs) are suited for *dynamic* (temporal) data processing, as they can embed temporal correlations of the inputs into their dynamical behavior. RNNs are capable of representing dynamical systems driven by sequential inputs owing to their feedback connections.

Reservoir computing (RC) is an RNN-based framework and is therefore suitable for temporal/sequential information processing (Jaeger and Haas, 2004). Specifically, RC is a unified computational framework (Verstraeten et al., 2007; Lukoševičius and Jaeger, 2009), derived from independently proposed RNN models, such as echo state networks (ESNs) (Jaeger, 2001a) and liquid state machines (LSMs) (Maass et al., 2002). The backpropagation decorrelation (BPDC) learning rule (Steil, 2004, 2007) for RNNs is also regarded as a predecessor of RC. In RC, input data are transformed into spatiotemporal patterns in a high-dimensional space by an RNN in the *reservoir*. Then, the features of the inputs are extracted in the *readout*, as shown in Fig. 1(a). The main characteristic of RC is that the weights of the recurrent connections within the reservoir are not trained whereas only the readout weights (i.e., W^{out} in Fig. 1(a)) are trained by linear regression or another simple machine learning algorithm. This simple and fast training process makes it possible to drastically reduce the computational cost of learning compared with standard RNNs, which is the major advantage of RC (Jaeger, 2002). RC has been successfully applied to many computational problems, such as temporal pattern classification, prediction, and generation. To achieve excellent computational performance of RC, it is necessary to appropriately represent sample data and optimally design the RNN-based reservoir. The methods for obtaining effective reservoirs, which have been summarized in (Lukoševičius and Jaeger, 2009), are categorized into task-independent generic guidelines and task-dependent reservoir adjustment.

The role of the reservoir in RC is to nonlinearly transform sequential inputs into a high-dimensional space such that the features of the inputs can be effectively extracted by a simple learning algorithm. Therefore, instead of RNNs, other nonlinear dynamical systems can be used as reservoirs. In particular, *physical RC* using reservoirs based on physical phenomena has recently

attracted increasing interest in many research areas (Fig. 1(b)). Various physical systems, substrates, and devices have been proposed as reservoirs for RC. Although design principles for conventional RC, such as ESNs (Ozturk et al., 2007; Lukoševičius, 2012) and LSMs (Maass, 2011), have been examined comprehensively, the following issues require further investigation: how to design physical reservoirs for achieving high computational performance and how much computational power can be attained by individual physical RC systems.

The purpose of this review is to provide an overview of recent advances in RC, with special focus on physical RC. Published studies on physical RC can be found not only in neural network journals but also in specialized journals related to the respective physical systems. Our objective is to provide a comprehensive viewpoint with regard to interdisciplinary studies on physical RC by classifying them according to the type of the physical phenomenon in the reservoir. Toward this end, we summarize the characteristics of individual physical reservoirs. Our classification, which highlights the similarities and differences among different physical reservoirs, is useful for gaining insights into the further developments of physical RC.

Some RC systems are expected to be implemented with physical devices and hardware. Such hardware-based RC can significantly speed up data processing compared to software-based RC, and it is often motivated by the need to reduce the power consumed by machine learning hardware. The RC framework is suited to low-cost online computation for sufficiently high performance rather than high-cost offline computation for extraordinarily high performance. Such a computational framework is an excellent choice for edge computing (Shi et al., 2016) in the era of the Internet of Things (IoTs), as opposed to cloud computing. Owing to the ever-growing amount of data generated at the edge of computer networks, speed degradation of data transportation is becoming a bottleneck for cloud computing. Therefore, data needs to be processed at the edge of the network, preferably in real time. Machine learning hardware for temporal data processing, such as RC hardware, is expected to become increasingly significant in the future. On the other hand, physical constraints make it difficult to optimize the conditions of reservoirs in physical RC. Many issues remain to be addressed in order to realize efficient physical RC devices for practical applications. Our review introduces potential candidates of physical reservoirs for such devices.

The remainder of this review article is organized as follows. In Sec. 2, we briefly describe the basic concept of RC and its recent trends. In the subsequent sections, we introduce different types of physical RC systems, including RC based on well-known dynamical systems models in Sec. 3, electronic RC in Sec. 4, photonic RC in Sec. 5, spintronic RC in Sec. 6, mechanical RC in Sec. 7, biological RC in Sec. 8, and others in Sec. 9. Finally, we discuss the current issues and future research directions in Sec. 10.

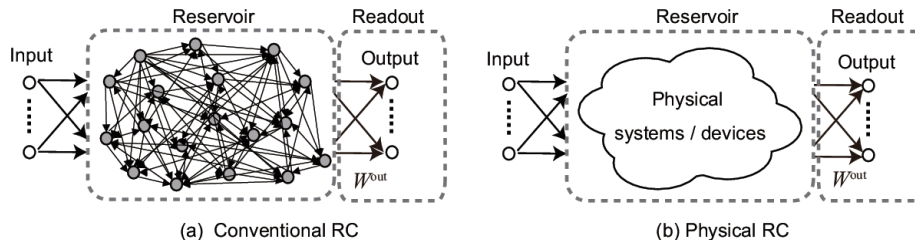

Figure 1: RC frameworks where the reservoir is fixed and only the readout weights W^{out} are trained. (a) A conventional RC system with an RNN-based reservoir as in ESNs and LSMs. (b) A physical RC system in which the reservoir is realized using a physical system or device.

2. Reservoir computing (RC)

First, we outline the fundamental concept of RC in Sec. 2.1. For a more detailed background and overview of conventional RC, readers may refer to the following well-organized articles: the survey paper (Lukoševičius and Jaeger, 2009), the review papers (Schrauwen et al., 2007; Lukoševičius et al., 2012; Scardapane and Wang, 2017), and the special issue on ESNs and LSMs in *Neural Networks* (Jaeger et al., 2007). Then, we discuss the recent trends in RC in Sec. 2.2.

2.1. Basic framework

Since the 1980s, RNNs have been used for temporal/sequential pattern recognition. They are characterized by feedback (recurrent) connections for generating history-dependent dynamical responses to inputs. The two major gradient-based learning algorithms for RNNs are backpropagation through time (BPTT) (Rumelhart et al., 1985; Werbos, 1990) and real-time recurrent learning (RTRL) (Williams and Zipser, 1989; Doya, 1998). These classical methods for training RNNs are discussed in a tutorial on RC (Jaeger, 2002). BPTT is used for batch learning with a fixed length of sequential data, and its space complexity (i.e. computer memory) increases with the length of the data because an RNN is unfolded in time and converted to an FNN with shared weights. RTRL shows excellent performance in online learning, but its time complexity (i.e. computational time) is high. Most RNN-based methods, including the long short-term memory (LSTM) (Hochreiter and Schmidhuber, 1997), use one of the above-mentioned algorithms or a combination of them.

In the early 2000s, ESNs (Jaeger, 2001a; Jaeger and Haas, 2004) and LSMs (Maass et al., 2002; Maass, 2011) were independently proposed as seminal RC models. They are different from conventional RNNs in that the weights on the recurrent connections in the reservoir are not trained but only the weights in the readout are trained (Schrauwen et al., 2007; Lukoševičius and Jaeger, 2009). The RNN-based reservoir transforms sequential inputs into high-dimensional patterns such that the features of the inputs can be effectively extracted by a

simple readout. As in the kernel method (Hofmann et al., 2008), nonlinear mapping of an input signal to a high-dimensional space is an effective method for pattern analysis of the input information. To apply a simple machine learning method to the readout, the reservoir should be appropriately designed in advance. The characteristics of the two above-mentioned models are summarized below.

The ESN was proposed by Jaeger (Jaeger, 2001a; Jaeger and Haas, 2004). It uses an RNN-based reservoir consisting of discrete-time artificial neurons (Fig. 1(a)). When the feedback from the output to the reservoir is absent, the time evolution of the neuronal states in the reservoir is described as follows (Jaeger, 2001a):

$$\mathbf{x}(n) = \mathbf{f}(W^{\text{in}}\mathbf{u}(n) + W\mathbf{x}(n-1)), \quad (1)$$

where n denotes discrete time, $\mathbf{x}(n)$ is the state vector of the reservoir units, $\mathbf{u}(n)$ is the input vector, W^{in} is the weight matrix for the input-reservoir connections, and W is the weight matrix for the recurrent connection in the reservoir. The function \mathbf{f} represents an element-wise activation function of the reservoir units, which is typically a sigmoid-type activation function. Equation (1) represents a non-autonomous dynamical system forced by the external input. The output is often given by a linear combination of the reservoir states as follows:

$$\mathbf{y}(n) = W^{\text{out}}\mathbf{x}(n), \quad (2)$$

where $\mathbf{y}(n)$ is the output vector and W^{out} is the weight matrix in the readout. In supervised learning, this weight matrix is trained to minimize the difference between the network output and the desired output for a certain time period (see Sec. 8 of (Lukoševičius and Jaeger, 2009) for details). The performance of the ESN depends on the design of the RNN-based reservoir. To approximate the input signal, the RNN-based reservoir should have the *echo state property*, whereby it asymptotically eliminates any information from the initial conditions (Jaeger, 2001a). It is empirically observed that the echo state property is obtained for any input if the spectral radius (i.e. the maximum eigenvalue of W) is adjusted to be smaller than unity. A practical guide for reservoir design in ESNs can be found in (Lukoševičius, 2012).

The LSM was proposed by Maass et al. (Maass et al., 2002; Maass, 2011) to explore the computational capability of neural microcircuits in the brain (Maass and Markram, 2004). The purpose of LSMs is to develop biologically relevant learning models using spiking neural networks with recurrent architectures (Fig. 1(a)). The spiking neurons are excitatory or inhibitory. Although they are principally modeled with integrate-and-fire neurons, other biologically plausible models can also be used (Wojcik and Kaminski, 2007; Grzyb et al., 2009). The topology and connectivity of the RNN in the LSM follow the constraints of biological neural networks. Specifically, the probability that two neurons are connected depends on the distance between their positions. Such a reservoir is often called a *liquid* and the LSM operation is called *liquid computing* because it is similar to excitable media exhibiting ripples in response to

external stimulation inputs. The reservoir dynamics is generally described as follows (Maass et al., 2002):

$$x^M(t) = (L^M u)(t), \quad (3)$$

where t denotes continuous time, x^M is the reservoir state (neuronal activation patterns), $u(\cdot)$ is the input encoded as a spike sequence, and L^M is the filter for transforming the input by the spiking neurons. The output is given by

$$y(t) = f^M(x^M(t)), \quad (4)$$

where $y(t)$ is the output and f^M is a memory-less readout map. A simple machine learning algorithm or a biologically plausible learning rule can be adopted to train the readout map. If the reservoir and the readout map have certain properties, the LSM can approximate any time series (Maass et al., 2002; Maass and Markram, 2004). This indicates its universal computational power for temporal inputs. The LSMs can incorporate new findings about biological mechanisms of information processing in the brain.

2.2. Recent trends

The number of studies on RC has been rapidly increasing in recent years. In this subsection, we discuss the recent trends in RC studies from several viewpoints, including applications, methods, and physical realization.

First, RC has been successfully applied to many practical problems involving real data. One of the reasons for this success is that researchers outside the neural network community have recognized the advantages of RC. The simplicity of the training method in RC is attractive for practitioners. Table 1 lists examples of subjects that have been addressed using RC. Most of these studies are involved in machine learning applications, such as pattern classification, time series forecasting, pattern generation, adaptive filtering and control, and system approximation. In particular, RC meets the demands for low training cost and real-time processing in these applications. Some benchmark tasks related to these applications are listed in Table 2. Although RC is suited for temporal pattern recognition, it can be applied to image recognition by transforming an image into a sequence of pixel values. As RC can deal with any sequential data in principle, further expansion of its application fields is widely expected.

Second, many variants of RC models have been proposed to improve the performance of the original ones. New RC models have been devised by using new architectures (e.g., multiple reservoirs and evolving reservoirs), combining RC with other machine learning methods (e.g., deep learning and reinforcement learning), incorporating new learning algorithms (e.g., FORCE learning (Sussillo and Abbott, 2009) and its variants), and/or replacing some elements of RC with other types of elements. In addition, theoretical studies have provided a deeper understanding of the relationship between the computational performance of RC and the dynamics of reservoirs, in terms of nonlinear dynamical systems theory, information theory, and statistical theory. A comprehensive overview of these studies is beyond the scope of this review.

Table 1: Examples of subjects in RC applications.

Category	Examples
Biomedical	EEG, fMRI, ECG, EMG, heart rates, biomarkers, BMI, eye movement, mammogram, lung images.
Visual	Images, videos.
Audio	Speech, sounds, music, bird calls.
Machinery	Vehicles, robots, sensors, motors, compressors, controllers, actuators.
Engineering	Power plants, power lines, renewable energy, engines, fuel cells, batteries, gas flows, diesel oil, coal mines, hydraulic excavators, steam generators, roller mills, footbridges, air conditioners.
Communication	Radio waves, telephone calls, Internet traffic.
Environmental	Wind power and speed, ozone concentration, PM2.5, wastewater, rainfall, seismicity.
Security	Cryptography.
Financial	Stock price, stock index, exchange rate.
Social	Language, grammar, syntax, smart phone.

Finally, physical realizations of RC models have attracted considerable attention. A straightforward method is to implement RNNs using neural network hardware or neuromorphic computing techniques. Another method is to employ other dynamical systems instead of RNNs. Any dynamical system has the potential to serve as a reservoir if it can exhibit dynamical responses to inputs. Such reservoirs were previously regarded as “exotic” (Lukoševičius and Jaeger, 2009), but the number of studies on physical RC has been rapidly increasing. Various physical reservoirs have been proposed using different types of physical systems, substrates, and devices. Physical RC is a useful framework for establishing unconventional computing technologies. Some physical RC systems are aimed at developing energy-efficient machine learning hardware.

There are several requirements for a physical reservoir to efficiently solve computational tasks. (i) *High dimensionality* is necessary to map inputs into a high-dimensional space. This property facilitates the separation of originally inseparable inputs in classification tasks and allows the effective extraction of spatiotemporal correlations of inputs in prediction tasks. The dimensionality is related to the number of independent signals obtained from the reservoir. (ii) *Nonlinearity* is necessary for a reservoir to operate as a nonlinear mapping. This property allows inputs that are not linearly separable to be transformed into those that are linearly separable in classification tasks. It is also useful for effectively extracting nonlinear correlations of inputs in prediction tasks. (iii) *Fading memory* (or short-term memory) (Maass et al., 2002, 2004) is necessary to ensure that the reservoir state is dependent on recent-past inputs but independent of distant-past inputs. It is also referred to as the echo state property,

Table 2: Applications and related benchmark tasks of RC.

Applications	Benchmark tasks
Pattern classification	Spoken digit recognition (Verstraeten et al., 2005b) Waveform classification (Paquot et al., 2012) Human action recognition (Soh and Demiris, 2012) Handwritten digit image recognition (Jalalvand et al., 2015)
Time series forecasting	Chaotic time series prediction (Jaeger, 2001a) NARMA time series prediction (Jaeger, 2003)
Pattern generation	Sine-wave generation (Jaeger, 2002) Limit cycle generation (Hauser et al., 2012)
Adaptive filtering and control	Channel equalization (Jaeger and Haas, 2004)
System approximation	Temporal XOR task (Bertschinger and Natschläger, 2004) Temporal parity task (Bertschinger and Natschläger, 2004)
Short-term memory	Memory capacity (Jaeger, 2001b)

indicating that the current state of the reservoir and the output depend only on a finite number of past states and inputs (Jaeger, 2001a; Yildiz et al., 2012). Such a property is particularly important for representing sequential data with short-term correlations. (iv) *Separation property* is required to separate the responses of a reservoir to distinct signals into different classes. On the other hand, a reservoir should be insensitive to unessential small fluctuations, such as noise, so that similar inputs are classified into the same class. Therefore, when a system parameter variation causes a transition between stability and chaotic regimes, it is often recommended that the parameter be set close to the transition point (the so-called edge of chaos (Bertschinger and Natschläger, 2004; Legenstein and Maass, 2007)), where the transformation by a reservoir is neither very expanding nor very contracting.

The responses of physical RC systems are used to train a readout that is realized using physical devices or software-based computations. Linear regression or another simple machine learning algorithm is used in the readout of ESN-type RC (Lukoševičius and Jaeger, 2009), while a perceptron-like local learning rule or a synaptic plasticity-based one is used for the readout neurons in LSM-type RC (Maass et al., 2002).

An intriguing example of physical RC in an early study is a fluidic RC with water in a bucket for pattern recognition as shown in Fig. 2 (Fernando and Sojakka, 2003). The input signals are transmitted to electric motors that generate ripples on the water surface, and the ripples are recorded using a video camera. From the recorded signals, a software-based readout is trained. The performance of the liquid computer is demonstrated in an XOR task and a spoken digit recognition task. Subsequently, many dynamical systems models and physical systems have been employed as potential reservoirs. We classify these RC systems, substrates, and devices, depending on the type of the physical



Figure 2: A fluidic RC where the reservoir is the water in a bucket (Fernando and Sojakka, 2003). Figure reproduced with permission from Springer Nature.

phenomenon in the reservoir and review the individual reservoirs in the following sections.

3. Dynamical systems models for RC

In this section, we review several types of reservoirs based on well-known nonlinear dynamical systems models, including delayed dynamical systems in Sec. 3.1, cellular automata in Sec. 3.2, and coupled oscillators in Sec. 3.3.

3.1. Delayed dynamical systems

The reservoirs in ESNs and LSMs generate high-dimensional signals using a network of interacting neuron nodes, which are regarded as a special class of high-dimensional dynamical systems. Another way to generate high-dimensional patterns is to use a time-delayed dynamical system, as described in the following form (Lepri et al., 1994):

$$\frac{dx(t)}{dt} = F(t, x(t), x(t - \tau)), \quad (5)$$

where t represents continuous time, x is the state variable, F is a function determining the flow of this system, and $\tau > 0$ is the delay period. This system is capable of exhibiting rich nonlinear behavior including periodic oscillations and deterministic chaos depending on the system parameter setting. In the first proposal of a single-node reservoir with delayed feedback (Appeltant et al., 2011), the reservoir was implemented using electronic circuits with a feedback loop. As shown in Fig. 3, the input signal is multiplied by a mask function (Appeltant et al., 2014) and fed to the single nonlinear node. The virtual nodes are set at N time points that equally divide the delay period τ . The time interval

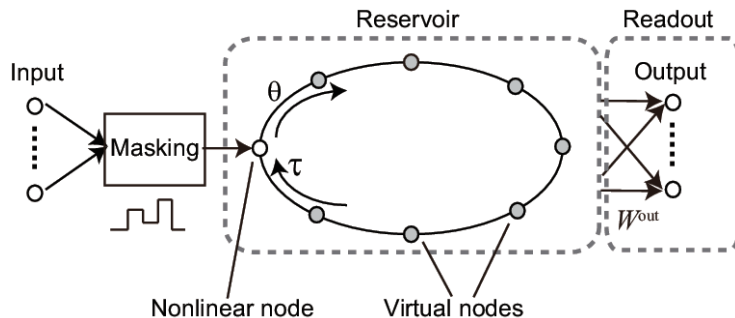

Figure 3: RC using a single nonlinear node reservoir with time-delayed feedback (Appeltant et al., 2011).

between two consecutive nodes is $\theta \equiv \tau/N$. The states at these virtual nodes, $x(t - (N - i)\theta)$ for $i = 1, \dots, N$, are used as the reservoir states at time t and then fed to the output layer through weighted connections. These connection weights are trained in the readout. The system was successfully applied to a spoken digit recognition task.

The architecture of the time-delayed single-node reservoir was extended in two ways (Ortín and Pesquera, 2017). One is an ensemble of two separate time-delayed reservoirs whose outputs are combined at the readout. The other is a circular concatenation of the delay lines of two reservoirs, forming a longer delay line. These extended architectures were shown to achieve better performance, faster processing speed, and higher robustness than the single-node reservoir.

The simplicity of the single-node reservoir with delayed feedback is advantageous for physical implementation compared to network-based reservoirs consisting of a large number of nodes. In fact, single-node reservoirs have been widely employed in electronic RC (Sec. 4.1.3) and photonic RC (Sec. 5.2).

3.2. Cellular automata

A cellular automaton (CA) is a simple dynamical system model where both state and time are discrete (Wolfram, 2018). The discrete states on the cells are updated according to a given (local) evolution rule. Depending on the rule, the CA can exhibit rich behavior, including ordered, critical (or the edge of chaos), and chaotic dynamics, in spite of its simplicity. It is heuristically conjectured that the computational capability of CA is maximized at the edge of chaos.

This conjecture has been confirmed in a numerical study on RC based on a random Boolean network, which is an extended version of CA (Snyder et al., 2013). Other studies employed CA-based reservoirs as shown in Fig. 4 (Yilmaz, 2014, 2015a,b). Binary or non-binary inputs are randomly mapped onto the initial states of CA through an encoding procedure. According to the predefined evolution rule, CA exhibits nonlinear dynamical behavior, through which the input data are projected onto an expressive and discriminative space. The entire record of the CA evolution is vectorized and used as a feature vector for

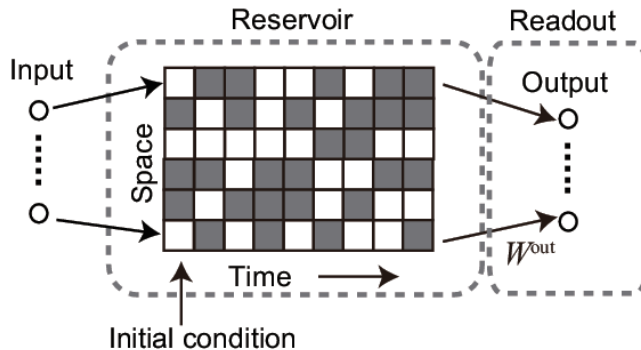

Figure 4: RC using cellular automata (Yilmaz, 2015b).

processing in the readout. The CA reservoirs are binary in nature and suitable for symbolic computation including Boolean logic. CA-based RC can perform 5-bit and 20-bit temporal memory tasks, which require long short-term memory capability, with less computation compared to ESNs (Yilmaz, 2015a). The binary operations and simple update rules of CA reservoirs are advantageous for implementation with parallel hardware, such as field-programmable gate arrays (FPGAs) and graphics processing units (GPUs).

The architecture of the CA reservoir can be extended in several ways. For instance, a parallel loosely coupled architecture (Nichele and Gundersen, 2017) and a layered deep architecture (Nichele and Molund, 2017) have been proposed. The rules of CA can also be extended by employing two CA rules of different classes in the reservoir layer to satisfy two competing requirements of the CA reservoir, i.e., sensitivity to the current input and asymptotic insensitivity to past inputs (McDonald, 2017). The first half of the CA reservoir is driven by a rule generating chaos or the edge of chaos for hyperdimensional projection of the inputs, while the second half is driven by a rule generating an ordered state for short-term memory.

3.3. Coupled oscillators

Coupled nonlinear oscillators are ubiquitous in mechanical, chemical, electronic, and biological systems. They can be used as physical reservoirs. When each oscillator is described with a first-order ordinary differential equation (ODE), a system of N coupled oscillators can be described in the following general form:

$$\frac{dx_i}{dt} = F(x_i(t)) + G(x_1(t), \dots, x_N(t)), \quad \text{for } i = 1, \dots, N, \quad (6)$$

where t represents continuous time, $x_i(t)$ is the state of oscillator i at time t , F is a function determining the dynamics of isolated oscillators, and G is a coupling function. The coupled oscillator model consists of the term representing

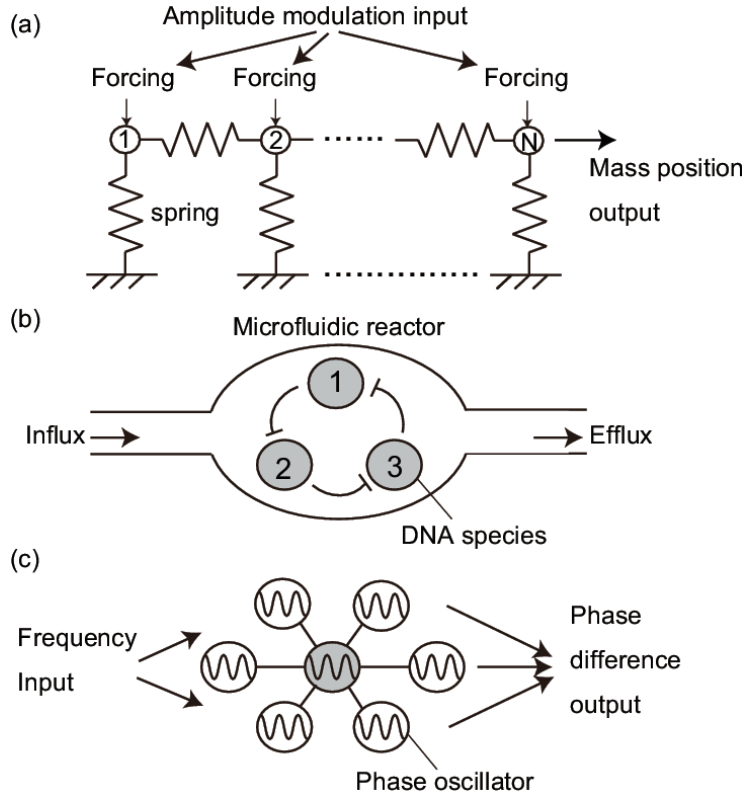

Figure 5: RC using coupled oscillators. (a) A mechanical reservoir with coupled nonlinear oscillators (Coulombe et al., 2017). (b) A DNA reservoir with coupled chemical oscillators (Goudarzi et al., 2013). (c) A synchronization-based RC with coupled phase oscillators (Yamane et al., 2015).

the dynamics of individual oscillators and the coupling term representing the interactions between oscillators.

A reservoir based on nonlinear mechanical oscillators has been proposed (Coulombe et al., 2017). Such reservoirs are composed of multiple inertial masses arranged in a chain, which are coupled with their nearest neighbors by springs, as illustrated in Fig. 5(a). The masses are grounded by linear or nonlinear springs with damping. The entire equation of motion is described by coupled Duffing oscillators (2nd-order ODEs) driven by periodic forcing. The input signal is applied to the reservoir by amplitude modulation of the periodic forcing. The outputs from the reservoir are envelope signals containing only the low-frequency amplitude variations in the high-frequency mass position signals. The output signal is calculated by a linear combination of the weighted envelope signals. A reservoir with nonlinear mechanical oscillators can be compactly fabricated using microelectromechanical systems (MEMS) technology in

an energy-efficient manner. The performance of such a reservoir computer was evaluated in a parity computation task and a spoken digit recognition task. Other mechanical reservoirs are reviewed in Sec. 7.

Chemical reactions are often modeled with coupled chemical oscillators to reproduce their oscillatory behavior far from a steady state. A DNA reservoir was designed with coupled deoxyribozyme-based oscillators at molecular scale as shown in Fig. 5(b) (Goudarzi et al., 2013). The reservoir consists of different DNA species interacting via biochemical reactions in a microfluidic reaction chamber, which can be mathematically represented as coupled ODEs with respect to concentrations of the product molecules of the DNA species. The input signal is encoded as fluctuations in the influx of species into the reactor, and the reservoir states are read using fluorescent probes. A software-based read-out is trained to map the oscillator dynamics to a target output. A chemical oscillator-based RC with three DNA species was applied to a temporal signal-tracking task.

When coupled nonlinear oscillators show limit cycle motions, they can be reduced to coupled phase oscillators under the assumption of weak interactions (Nakao, 2016). After the reduction, the amplitude of the motion is eliminated and the dynamics is restricted to the phase domain. Coupled phase oscillators can also exhibit rich dynamical behavior, including phase transition, clustering, and phase synchronization, which are available for RC. A phase-based RC encodes the input signal as phases of the oscillators and adopt phase synchronization for computation as shown in Fig. 5(c) (Yamane et al., 2015). In this method, the phase coupling function is appropriately designed to perform function approximations. This approach can contribute to development of phase-based information processing (Parihar et al., 2017) and wave-based neuromorphic computing (Katayama et al., 2016).

4. Electronic RC

RC systems implemented with electronic circuits and devices have been actively studied for developing machine learning devices with low power consumption. In Sec. 4.1, we introduce RC systems implemented with digital integrated circuits, including very-large-scale integrated circuits (VLSIs), custom integrated circuits, and reconfigurable hardware platforms. In Sec. 4.2, we focus on RC systems based on memristive elements which are promising constituents of reservoirs.

4.1. Integrated circuits

Electronic reservoirs implemented on integrated circuits can be categorized into network-type electronic reservoirs and single-node electronic reservoirs. Network-type electronic reservoirs are mainly based on ESNs and LSMs, which are separately discussed in Sec. 4.1.1 and Sec. 4.1.2, respectively. Single-node electronic reservoirs with delayed feedback are discussed in Sec. 4.1.3.

4.1.1. ESN-type circuits

In an early study, the electronic reservoir was implemented on an application-specific integrated circuit (ASIC) for a general-purpose mixed-mode neural network, which combines analog computation and digital signaling (Schürmann et al., 2005). The device consists of a recurrent network of McCulloch-Pitts neurons connected via analog synapses. It processes binary sequences in the input and output. Experimental results have shown that its computational performance in a 3-bit parity problem is maximized when the neural network exhibits critical dynamics at the edge of chaos, as in the case of previous results of software simulations (Bertschinger and Natschläger, 2004). Another reservoir composed of stochastic bit stream neurons was implemented on an FPGA board to explore efficient hardware implementation (Verstraeten et al., 2005a). A similar reservoir based on stochastic logic was implemented on an FPGA board using a random network topology (Alomar et al., 2014). In the above-mentioned studies, the readout was implemented with software on computers.

The first stand-alone FPGA design, including both a ring-network reservoir and a readout, was proposed for fast online learning and applied to a channel equalization benchmark task (Antonik et al., 2015). The units in this reservoir have a sinusoidal nonlinear function as an activation function and the readout provides a gradient descent algorithm. Other stand-alone ESN-type reservoir designs on FPGA were developed for real-time training (Yi et al., 2016) and stochastic computing (Alomar et al., 2016b).

4.1.2. LSM-type circuits

LSM-type reservoirs implemented on FPGAs have been proposed in many studies. As such reservoirs are based on spiking neural networks, they can be regarded as a specific form of neuromorphic computing. An efficient hardware architecture for implementing LSMs on an FPGA was presented for real-time information processing as shown in Fig. 6(a) and applied to isolated digit speech recognition (Schrauwen et al., 2008). The implementation technique for digital spiking neural networks was devised on the basis of serial operations, which enables slower but scalable operations in a compact device size. Subsequently, efficient designs and architectures for the implementation of FPGA-based LSMs have been investigated. For instance, it was shown that a stand-alone FPGA-based LSM with approximate arithmetic and parallel processing can speed up the runtime and reduce the energy consumption compared to implementation on a general-purpose CPU in speech and image recognition tasks (Wang et al., 2016, 2017). Other FPGA implementations of LSMs were demonstrated using stochastic spiking neurons in a ring network (Alomar et al., 2016a) and multiplier-less reconfigurable architectures (Ghani et al., 2015). In addition, a digital design architecture for implementing LSMs on reconfigurable platforms was proposed for real-time processing of input data (Polepalli et al., 2016a,b). The performance of the proposed model was numerically evaluated in an epileptic seizure detection task. Another novel digital neuromorphic architecture called a spiking temporal processing unit was proposed by incorporating temporal buffers in each spiking neuron to model arbitrary synaptic response functions (Smith et al., 2017).

This scheme was adopted to implement an LSM, and its pattern classification ability was evaluated in a spoken digit recognition task. The tradeoff between hardware overhead and computational performance in hardware-implemented LSMs was discussed in a simulation study (Jin and Li, 2017).

In addition to the above-mentioned reservoir implementation methods, hardware-friendly readout implementation techniques have also been studied for energy-efficient learning. Inspired by dendrites in biological neurons, a hardware-friendly readout architecture for LSMs and an efficient learning rule with adaptive network rewiring were proposed (Roy et al., 2014). In another study, a biologically inspired local learning rule was presented for low-power VLSI implementation of LSMs to reduce hardware implementation costs (Zhang et al., 2015). It was numerically shown that the overhead of hardware implementation can be reduced by the new learning rule in a speech recognition task. Similarly, improvement in the cost efficiency and energy efficiency of hardware LSMs was explored by developing a reservoir tuning method based on a hardware-friendly spike-timing-dependent plasticity (STDP) learning algorithm (Liu et al., 2018).

4.1.3. Time-delay circuits

A simpler architecture is a single-node reservoir with delayed feedback, as described in Sec. 3.1. A single-node reservoir imposes less hardware requirements compared to a network-type reservoir consisting of a large number of units (Soriano et al., 2015a). An electronic implementation of a single-node reservoir with a delay line was demonstrated using analog circuits as shown in Fig. 6(b) (Soriano et al., 2015b). The effect of the quantization noise generated by AD and DA conversion of the signals on the computational performance was investigated. A digital FPGA implementation of a single-node reservoir with delayed feedback was adopted for wave classification and time series prediction (Alomar et al., 2015). In (Haynes et al., 2015), a single autonomous Boolean node reservoir was implemented on an FPGA and employed to reproduce a three-input XOR gate. In other studies, a single spike-based node with delayed feedback was implemented with analog circuits (Zhao et al., 2016; Li et al., 2017).

4.2. Memristive RC

This subsection focuses on electronic RC based on memristive elements. A memristor (or memory resistor) is a two-terminal passive circuit element with the memristive property (Chua and Kang, 1976). The main characteristic of a memristor is that its resistance changes with time depending on the current flow that has passed through it (Chua, 1971; Williams, 2014). A memristor device was first physically realized using TiO_2 (Strukov et al., 2008). We classify memristive reservoirs into two types: neuromemristive reservoirs consisting of both neuron circuits and memristor synapses, which are discussed in Sec. 4.2.1, and memristor-based reservoirs without neuron elements, which are discussed in Sec. 4.2.2.

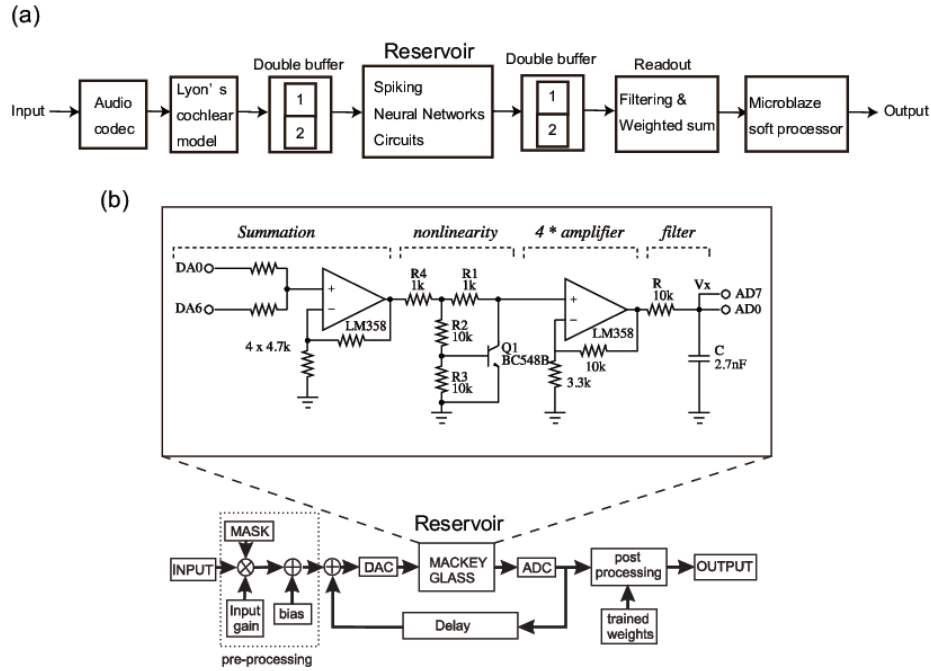

Figure 6: (a) Architecture of an FPGA-based LSM system for speech recognition (Schrauwen et al., 2008). (b) Electronically implemented RC system using a single-node reservoir based on the Mackey-Glass equation with delay (Soriano et al., 2015b). Figure reproduced and modified with permission from Springer Nature.

4.2.1. Neuromemristive circuits

Neuromorphic computing with non-von Neumann architecture has rapidly progressed in recent years. Neuromorphic devices/chips have been fabricated by different research groups (Walter et al., 2015). Neuromemristive systems are a subclass of neuromorphic computing systems that use memristors to mimic the synaptic plasticity in biological neurons, where the memristor conductance corresponds to the synaptic weight (Indiveri et al., 2013; Thomas, 2013). Nano-scale memristive synapses have considerable potential as elements of energy-efficient neuromorphic devices.

A memristor-based ESN with cellular neural network structures (i.e., locally connected arrays) was proposed using staircase memristor models (Yang et al., 2016). Numerical simulation showed that, owing to the simple structure, the performance of the proposed model is not better than that of the original ESN model with a random connection topology in a time series prediction task. Other ESN-type reservoirs were designed using memristor crossbar arrays (Merkel et al., 2014; Donahue et al., 2015). Memristor crossbar arrays are often used to implement direct synaptic connections in neuromorphic devices, because they are suitable for vector-matrix multiplication, and the conductances

of memristive synapses can be adaptively updated by applying voltage pulses. Double crossbar arrays were used to realize recurrent connections in ESNs (Hasan et al., 2017) and LSMs (Soures et al., 2017). The use of memristor crossbar arrays in the readout part of ESNs was proposed for a digital (or mixed signal) reservoir with a doubly twisted troidal structure (Kudithipudi et al., 2016). A more general on-chip system using analog memristive nanosynapses was presented for emulating a reservoir computer and performing recognition tasks (Bennett et al., 2017).

4.2.2. Memristor circuits

Memristors and memristive devices are capable of exhibiting nonlinear dynamics and responding to inputs in a history-dependent manner. Even without neuron units, memristors can exhibit nonlinear transformation of input signals. By exploiting these favorable properties for a dynamic reservoir, some studies have proposed reservoirs based on memristors. There are various memristive devices having different current-voltage characteristics, but ideally, they can be formulated as memristive systems categorized into a special class of dynamical systems (Chua, 1971; Chua and Kang, 1976). A current-controlled memristor with time-invariant characteristic is generally described as follows:

$$V = R(\mathbf{w}, I)I, \quad (7)$$

$$\frac{d\mathbf{w}}{dt} = f(\mathbf{w}, I), \quad (8)$$

where t represents continuous time, V is the voltage, R is the time-varying resistance, I is the current, and \mathbf{w} is a vector representing the internal state of the system. The function f determines how the internal state evolves depending on the input current.

A network of memristors can be used as a reservoir to nonlinearly map an input signal to a high-dimensional feature space, as shown in Fig. 7(a). The first memristor-based reservoir was proposed in (Kulkarni and Teuscher, 2012). The proposed model was applied to a wave pattern classification task and an associative memory task, but the readout is not simple but based on the genetic algorithm. As the connectivity of the memristors affects the computational performance of memristor-based RC, subsequent studies have extended the structure of the memristor network to a regular mesh structure for investigating the variation tolerance of RC (Bürger and Teuscher, 2013) and to a hierarchical structure for enhancing the computational capability of RC (Bürger et al., 2015b). Moreover, the correlation between the computational capacity and the energy consumption of RC with random memristor networks was investigated to clarify its potential and limitations (Bürger et al., 2015a). In the above-mentioned studies, the behavior of memristor-based reservoirs was simulated using circuit simulators. On the other hand, a general mathematical model of memristor networks was explicitly formulated to promote theoretical and numerical analyses of memristor-based RC (Tanaka et al., 2017). This formulation is applicable to any memristor network if its memductance is expressed

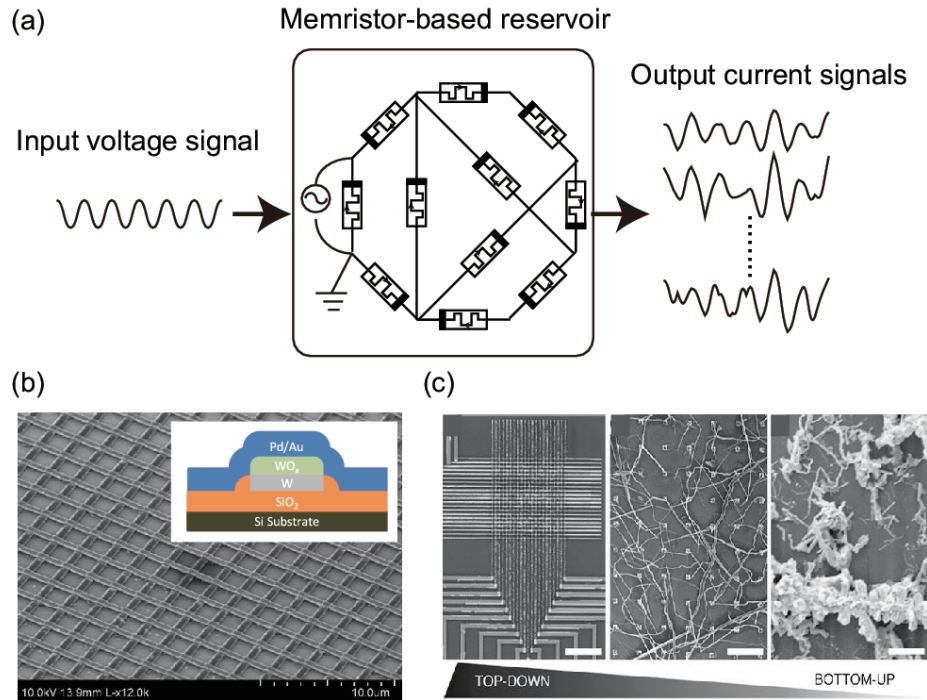

Figure 7: (a) RC based on a memristor network. (b) A fabricated memristor array where several cells are selected to work as a reservoir on the whole (Du et al., 2017). The inset shows tungsten oxide (WO_x) memristor with a metal-insulator-metal structure. Figure reproduced from (Du et al., 2017), licensed under CC-BY 4.0. (c) An atomic switch network device composed of self-assembled silver nanowires (Stieg et al., 2014). Figure reproduced with permission from Springer Nature.

as a function of its magnetic flux as in the linear drift model (Strukov et al., 2008). The numerical simulation showed that the variability in the memristive elements, which is generally thought to be undesired, can be beneficial if the network topology and the input scaling are appropriately selected. In (Carbajal et al., 2015), new memristor models with volatility were proposed to introduce the fading memory property into the standard non-volatile memristor model. Other memory devices, such as memcapacitors, are potential components of a network-type reservoir with low power consumption (Tran and Teuscher, 2017).

Several studies have demonstrated physical implementations of memristive reservoirs. A memristor-based reservoir device was recently demonstrated (Du et al., 2017), where the reservoir is not a network of memristors but a group of independent memristors (Fig. 7(b)). An input signal is divided into multiple segments, and each segment is then separately transformed into an output signal by each memristive device. The collection of the output signals is used as the state of the entire reservoir. It was experimentally demonstrated that this

RC device performs well in image recognition and time series prediction tasks. Memristive behavior is also observed in atomic switch networks (ASNs), which are aggregations of a number of silver nanowires interconnected with each other and formed via a thermodynamically driven self-organized growth process, as shown in Fig. 7(c) (Stieg et al., 2012). RC based on ASNs was applied to a waveform generation task (Sillin et al., 2013; Stieg et al., 2014).

5. Photonic RC

In this section, the rich literature on photonic reservoir implementations is categorized and briefly summarized. An alternative discussion on this specific area can be found in (Van der Sande et al., 2017). Reviews on topics related to photonic spike processing (Prucnal et al., 2016) and photonics for neuromorphic applications (Ferreira et al., 2017) have also been published recently. In this review, optical reservoirs are categorized as network-type reservoirs (Sec. 5.1), single-node reservoirs with delay feedback (Sec. 5.2), and other configurations (Sec. 5.3).

5.1. Optical node arrays

A photonic reservoir computer, with the potential advantages of low power consumption and extremely fast computation, was first realized in 2008 and subsequently refined on the basis of numerical simulations (Vandoorne et al., 2008, 2011). The design is based on a chip-integrated device with single-mode waveguides. Semiconductor optical amplifiers (SOAs) are assembled in a 4×4 array, with each node connected to a maximum of four neighbors in a swirl configuration, as shown in Fig. 8. The effect of non-uniformity of the nodes and the delay and phase shift between interconnections were studied. An experimental prototype was reported in 2014 (Vandoorne et al., 2014). Readout was performed at 11 of the 16 nodes by photodetectors providing nonlinearity owing to the limitations imposed by optical loss, and the signal input was inserted via a single node. The training of the reservoir and processing of the output were performed off line. Experimental demonstrations include a 2-bit XOR logical operator, header recognition, and spoken digit classification.

A proposed related design is a platform in which the nodes are microring resonators providing nonlinear responses (Mesaritakis et al., 2013). With a randomly interconnected 6×6 array, successful operation for a pattern recognition task was numerically demonstrated. Another related study developed a node-based framework adapted to a coupled-mode theory to simulate a large number of cavities efficiently (Vaerenbergh et al., 2015). A drawback of photonic reservoirs is that a compact design results in short time delays; hence, the required input and readout operation rates may be too high for practical implementation. A digital mask modulation technique was proposed to alleviate this problem and decrease the input signal rate by a factor of 40 (Schneider et al., 2016). There is a design choice for the number of nodes that are linked to the input signal. This aspect was recently studied, and it was found that the power efficiency

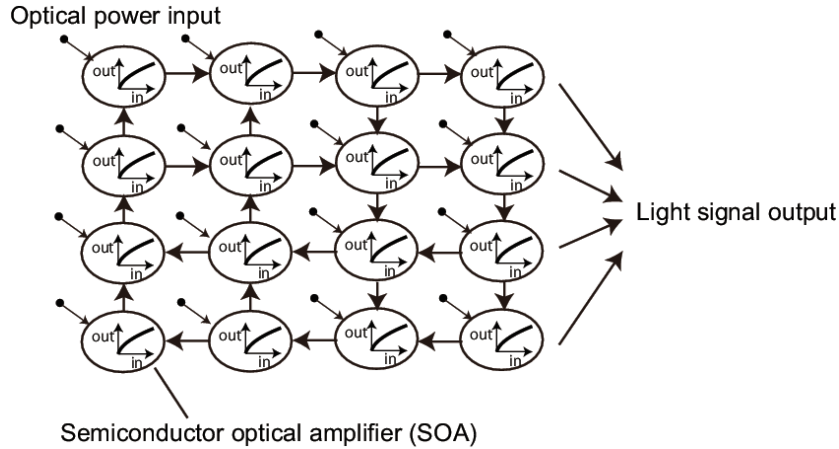

Figure 8: A 4×4 node array optical reservoir with a swirl connection pattern (Vandoorne et al., 2011).

was improved for an input signal fully connected to the array (Katumba et al., 2017).

5.2. Time-delay optical systems

5.2.1. Opto-electronic feedback

The most extensively studied implementation of an optical reservoir computer is a configuration that uses a single physical node with a time-delayed feedback signal (Appeltant et al., 2011), as explained in Sec. 3.1. The input signal is converted into a staircase waveform by a sample-and-hold procedure. A weight mask related to the number of virtual nodes in the feedback loop is applied to each symbol step. The weights of the output signal are calculated off line during the training procedure.

In the first experimental demonstrations (Larger et al., 2012; Paquot et al., 2012), the feedback loop was optoelectronic. Light from a continuously emitting laser source is sent to a modulator for information processing. The optical output reaching a photodiode is amplified and electronically combined with the input signal to drive the modulator, as shown in a generic form in Fig. 9(a). Readout is performed either by sampling the feedback photodiode output or with an optical splitter collecting part of the light in the loop and a second photodiode. Demonstrations include the nonlinear auto regressive moving average (NARMA) equation of order 10, equalization of a nonlinear channel, and spoken digit recognition. In these pioneering demonstrations, the signal input rate was in the MHz range.

A number of published studies have reported different components, design optimization, and the addition of new functionality. A reservoir in which the input signal is fed by directly modulating the laser, node nonlinearity is achieved

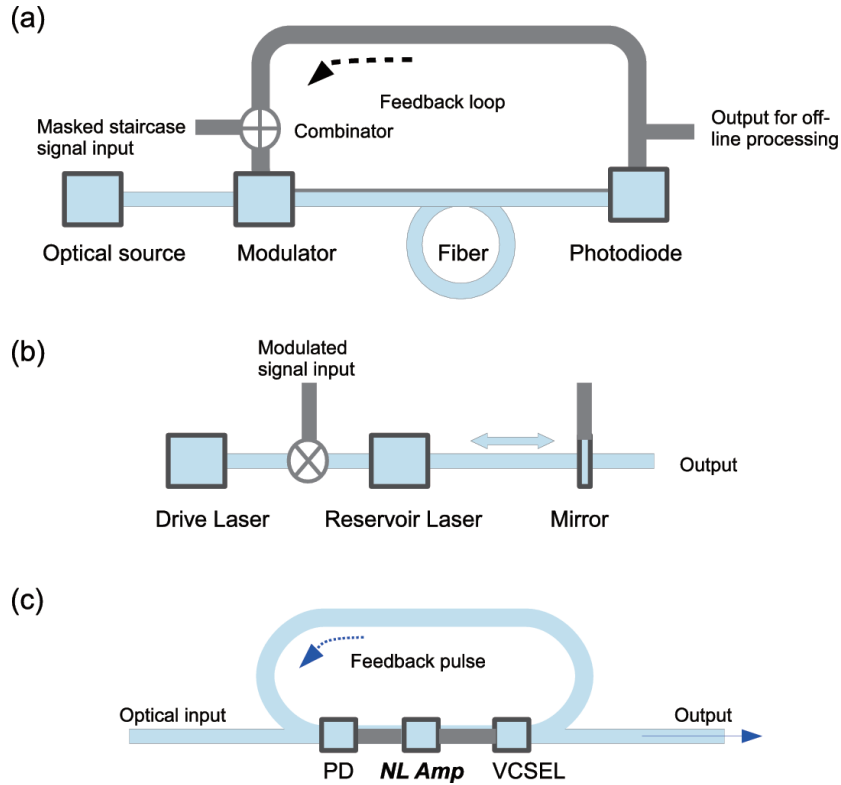

Figure 9: (a) Principle of a time-delay reservoir computer with an opto-electronic feedback loop. The blue and gray lines represent optical and electronic signals, respectively. (b) Time-delay reservoir computer with optical feedback into a laser cavity by a partially reflecting mirror. (c) Diagram of a polymer waveguide-based time-delay reservoir computer with optical feedback and opto-electronic node.

by a birefringent plate, and multiple feedback loops with different delay times for enhanced connectivity are realized with an FPGA, was reported (Martinghi et al., 2012). All-optical designs in which the electronics in the loop was replaced by a semiconductor optical amplifier and a fiber coupler (Duport et al., 2012) or a fiber amplifier, semiconductor saturable absorber, and fiber coupler (Dejonckheere et al., 2014) have been demonstrated experimentally. An important limiting factor for reservoir prototypes is the impact of noise on performance. This issue was investigated numerically and experimentally, and the importance of a preprocessing mask weight with multiple values, as opposed to binary values, was demonstrated (Soriano et al., 2013).

It was also shown that when an optoelectronic loop setup was used for a reservoir computer, the system could perform learning tasks even if the feedback was removed in an extreme learning machine (ELM) configuration if the response was slower than the masked input to provide some interaction be-

tween neighboring neurons (Ortín et al., 2015). The system without feedback was found to be capable of performing a cancer type classification task with genetic microarray data. Another added functionality is the simultaneous computation of three independent tasks in a time-delay optical system with three so-called virtual reservoirs, as the system typically has an inherent bandwidth higher than the input signal rate (Duport et al., 2016b). In another scheme, a reservoir with a coherently-driven passive cavity was reported, in which the low optical loss leads to good performance without the internal gain increasing the noise performance degradation (Vinckier et al., 2015). State-of-the-art results were obtained numerically and experimentally for a spoken digit recognition task.

To avoid electronic preprocessing of the input signal into a step waveform as an input mask, an implementation of a fully analogue reservoir with time delay was proposed and only slight performance degradation compared to a step signal was observed (Duport et al., 2016a). At the output layer, the signal was split between a readout photodiode and a modulated portion applying the readout coefficients online. Finally, the potential of an optoelectronic feedback reservoir computer for high speed processing was clearly demonstrated in the realization of a setup capable of performing a million-words-per-second classification task using high-speed electronics for input and output processing (Larger et al., 2017). Phase modulators were used in the feedback loop, and the delay between the virtual nodes corresponded to an input signal rate of approximately 17 GHz.

An interesting application was demonstrated in (Qin et al., 2017), namely the identification and classification of a packet header for switching in an optical network application. The low hardware requirements compared to a traditional neural network were emphasized. This concept was further extended to a system with two feedback loops to perform simultaneous recognition of packet headers for two optical channels (Zhao et al., 2018). An optoelectronic reservoir computer was also applied to the task of generating a long-range periodic time series and the emulation of a chaotic system (Antonik et al., 2017b,c). The underlying concept of this work was to feed the signal output processed by an FPGA back to the reservoir, in addition to the usual feedback signal. Periodic frequency and random patterns were successfully generated.

Some recently published articles have reported the potential of novel schemes for online training. By connecting an FPGA performing a gradient descent algorithm at the loop output, a device with a very low symbol error rate was demonstrated for a distorted wireless signal recovery task, particularly for a high signal-to-noise ratio environment (Antonik et al., 2017a). A new method based on online gradient descent training with BPTT was recently proposed and experimentally shown with an optoelectronic feedback loop (Hermans et al., 2015b,a, 2016). The scheme cannot be strictly labeled as a reservoir, because the input weights are optimized to enhance performance, but may have a significant impact on the development of future related systems. Results obtained for TIMIT phoneme recognition were similar to those reported for a fully offline trained RC with a larger number of nodes.

5.2.2. *Optical feedback in a laser cavity*

A second class of time-delayed optical reservoir computers has been investigated in recent years, in which the nonlinearity comes not from an electronically controlled discrete element in the feedback loop but from the nonlinear response of a laser when a delayed signal re-enters the cavity. Light input and output with the same aperture is achieved by polarization rotation with a circulator component or another suitable mechanism. In the first reports (Brunner et al., 2013b; Hicke et al., 2013), good results were experimentally obtained with a semiconductor laser for spoken digit recognition and chaotic time-series prediction tasks. In another study that is related but not strictly categorized as a reservoir as there was no feedback component, a similar system based on a nonlinear resonant cavity was used to demonstrate optical vector-matrix product operations (Brunner et al., 2013a).

In an alternative configuration, a semiconductor ring laser is implemented as the nonlinear node, with the potential for on-chip integration and simultaneous processing of two tasks by optical modes with opposite propagation directions. Numerical studies have shown good results for chaotic time series prediction and nonlinear channel equalization tasks (Nguimdo et al., 2015). Optical delayed systems are sensitive to optical phase change, but in a subsequent study, it was explained that this problem can be alleviated with a modified readout layer (Nguimdo et al., 2016). Calculations on a similar system for dual-channel optical packet header recognition have also been reported (Bao et al., 2018).

In another related setup, information was sent into the laser cavity via phase modulation, and a partially transparent mirror split the laser output into a delayed component going back into the cavity and a transmitted component for readout (Nakayama et al., 2016), as shown schematically in Fig. 9(b). The efficiency of a chaotic input mask generated from a separate optical cavity subjected to feedback was compared to other digital and analog masking schemes and numerically studied for a chaotic time series prediction task. Performance improvement was observed, provided that the mask frequency was near the relaxation oscillation of the ring cavity laser. It was experimentally confirmed that a chaotic or colored-noise mask provides better performance with a properly selected cut-off frequency (Kuriki et al., 2018). In another study, numerical simulation of a reservoir in which the input signal was applied to a tunable Bragg reflector providing external feedback to the laser cavity was proposed, and the reservoir was applied to a waveform classification task (Takeda et al., 2016).

Very recently, the performance of a more elaborate system with two optical feedback loops was studied numerically for a time series prediction task with an information processing rate of 1 GB/s (Hou et al., 2018). Performance was improved over a single loop configuration owing to the rich dynamics.

Another application was described in (Qin et al., 2016), where a delayed optical feedback setup with a polarization circulator was adopted for optical packet header identification at 10 GB/s. The optimal feedback parameters were found and a low recognition error was obtained provided that the signal-

to-noise ratio was above 15 dB. The optimal operation conditions for an all-optical feedback loop system were numerically and experimentally investigated in (Bueno et al., 2017). The effects of detuning of the frequency between an injection laser and the reservoir laser as well as the locking of the laser state were studied for a chaotic time series prediction task.

5.3. Other configurations

In this section, we summarize recently proposed schemes that are extensions of those presented above or are based on different physical principles.

A chip-integrated device that combines physical optical nodes and time multiplexing functions by connecting in series several ring resonators for memory with a time-encoded input optical signal was proposed (Zhang et al., 2014). Its performance for signal classification and chaotic time series tasks was numerically examined.

The concept of a device built on the basis of a photonic crystal platform was first proposed for a waveform generation application (Fiers et al., 2014). Good simulation results were reported for a task with multiple superimposed oscillators. More recently, a reservoir built from photonic crystal cavities with multiple waveguide inputs and outputs was designed to exploit field mixing dynamics and was shown to exhibit memory up to 6 bits (Laporte et al., 2018). A parallel reservoir computer based on a fiber loop with frequency multiplexing of neurons was also reported (Akrouf et al., 2016), where the realization of non-linear channel equalization and isolated spoken digit recognition was simulated.

An all-optical, free-space configuration with diffraction grating and Fourier imaging was designed with randomly interconnected microring resonators and applied to an imaging pattern task (Mesaritakis et al., 2015). Another reservoir with a diffractive optical element was recently described on the basis of an 8×8 laser array and a spatial light modulator. Rich interaction dynamics was experimentally observed, and the potential for scaling up to a complex configuration with low power consumption was illustrated (Brunner and Fischer, 2015; Van der Sande et al., 2017). A reservoir in which node interaction comes from the scattering of light passing through a microscopic slide with a simple layer of white paint was proposed and applied to logical function operation, with signal input via a micro-mirror array (Dong et al., 2016).

An intrinsic limitation of single-mode waveguide-integrated passive optical reservoirs is loss accumulation for a large number of nodes and long delay lines. Multi-mode waveguide reservoir designs in which coupling and propagation losses are much smaller can mitigate this problem. A polymer waveguide-based structure with all-optical feedback and opto-electronic neurons composed of a photodiode, amplifier, and vertical cavity surface emitting laser (VCSEL) chip arrays, was recently proposed, as shown in Fig. 9(c) (H eroux et al., 2017, 2018). Simulations with this reservoir yielded promising results for a signal recovery task. As there is gain in the nodes, there is no fundamental limitation on the aggregation of a large number of physical neurons in a future device. Moreover, as the optical path is on the centimeter scale with low loss, there is added flexibility in the implementation of relatively long optical delay feedback on a

solid substrate. In another study with multimode waveguides, a chip-integrated photonic circuit with a low-loss optical Y-junction combiner was simulated and applied to a header recognition task (Katumba et al., 2018).

6. Spintronic RC

Several reservoirs based on spin electronics (spintronics) have been proposed. Spintronics is an emerging research field of nanoscale electronics involving both charge and spin of electrons for developing new electronic devices, such as non-volatile storage (Wolf et al., 2001). Spin systems are potential candidates for low-power and small-scale reservoir devices. Three types of spin-based reservoirs with spin oscillations, spin waves, and skyrmions are summarized.

A reservoir with a spin torque oscillator (STO) was experimentally demonstrated (Torrejon et al., 2017). The spin torque oscillator is fabricated with a magnetic tunnel junction (MTJ) element composed of two ferromagnets (the top free layer and the bottom pinned layer) separated by a thin insulator, as shown in Fig. 10(a). When a constant DC current is injected into an MTJ, the spin direction in the free layer rotates owing to the spin torque that originates from the spin-polarized electron current generated by the pinned layer. After a transient time, the oscillation is stabilized at a frequency depending on the magnitude of the input current. The reservoir uses the nonlinear relationship between the input current and the oscillation frequency as well as history-dependent transient motions of the spin in the free layer. In a spoken digit recognition task, the sound data is given to the single STO as an input current after a preprocessing step and the voltage output of the STO is used to train the readout. It was shown that the digit prediction performance of the proposed method is better than that in the case without STO. The possibility of using chaotic dynamics in an STO with time-delayed feedback for RC has been explored in (Williame et al., 2017). By adjusting the amplitude and delay time of the feedback current, good conditions for spin motions in RC can be specified. Another study numerically investigated the memory effect and nonlinearity of STO-based reservoirs with single and multiple MTJs on short-term memory and parity check tasks (Furuta et al., 2018). A random binary voltage was used as an input and the time-varying resistance of the MTJ device was used as an output. The spin dynamics in the free layer follows the Landau-Lifshitz-Gilbert (LLG) equation. It was demonstrated that the performance in the two tasks depends on the duration of the input pulse voltage.

Spatial propagation of spin motions, or spin waves, can also be used for a reservoir (Nakane et al., 2018). The proposed reservoir device structure consists of a thin Yttrium iron garnet (YIG) film between a magneto-electric coupling layer and a conductive substrate, as shown in Fig. 10(b). The input voltage signals applied at the input electrodes on the top layer cause a change in the uniaxial magnetic anisotropy constant of the middle garnet layer by the magneto-electric effect. This stimulation disturbs the alignment of spins in the same direction; thus, the phase difference between neighboring spins is transmitted through a material as spin waves. This behavior is simulated with the LLG

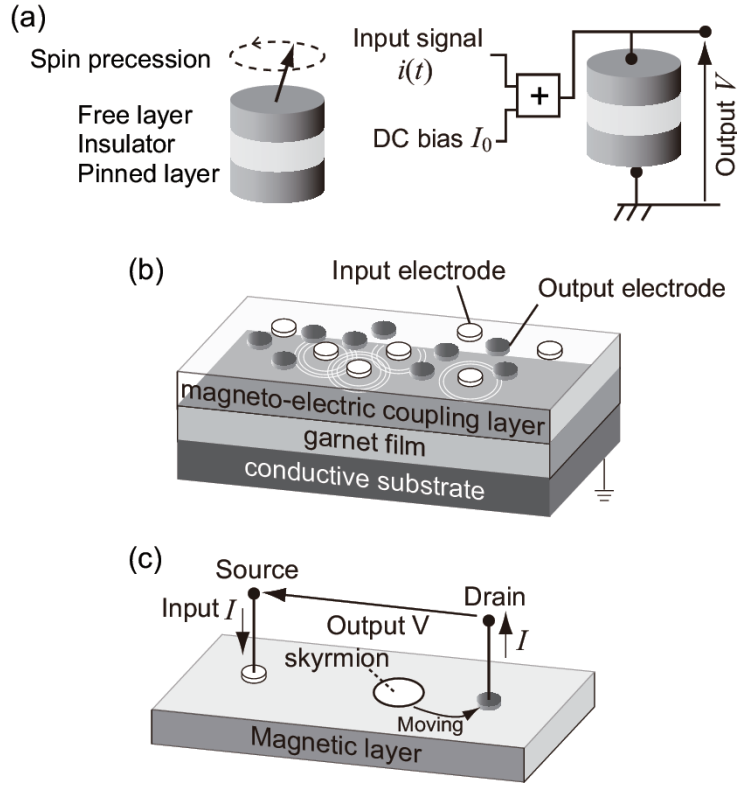

Figure 10: (a) Schematic illustration of the spin torque oscillator (left) and the reservoir device structure with a bias current input and a voltage output (right) (Torrejon et al., 2017). (b) Schematic illustration of a spin-wave-based reservoir device (Nakane et al., 2018). Figure reproduced with permission from IEEE. (c) A possible structure of a skyrmion-based reservoir device (Prychynenko et al., 2018).

equation. The spin waves can show input history-dependent transient motions and nonlinear interferences. Spin motions measured at the output electrodes are used to train a linear regression model in the readout. A numerical demonstration shows that a characteristic of the input pattern can be well estimated by the spin-wave-based RC when the electrode positions and the duration of the output signals are appropriately selected.

Another type of spin-based reservoir device could be realized using magnetic skyrmion, which is a nano-scaled magnetic vortex in a magnetic material, as shown in Fig. 10(c) (Prychynenko et al., 2018). It is known that a current-induced transfer of a skyrmion can show nonlinear dynamics and history-dependent spin distributions, which are favorable for a reservoir. In the proposed device, the input is an electron current at the source and the output is the voltage between the source and the drain. By injection of a constant current, a skyrmion initially present between the source and the drain moves

toward the drain and is then annihilated at the drain. The output voltage changes with the distance between the skyrmion position and the drain, in response to the input current. Interacting multiple skyrmions can generate more complex behavior, and skyrmion fabrics are potentially attractive options for implementing a reservoir (Bourianoff et al., 2018).

7. Mechanical RC

Mechanical systems, such as soft and compliant robots, are possible options for physical reservoirs. Soft and compliant robots with flexible bodies are difficult to control due to their complex body dynamics compared to rigid robots with stiff bodies. However, such complex behavior can be favorably leveraged to generate rich nonlinear dynamics required for RC. The idea of outsourcing computation to a physical body is known as *morphological computing* in the field of robotics (Pfeifer and Bongard, 2006).

Soft and compliant robots are typically composed of deformable bodies. A primitive model available as a physical reservoir is a mass-spring network, which can be regarded as coupled mechanical oscillators as described in Sec. 3.3. A mass-spring network reservoir where mass points are randomly connected to neighboring mass points via nonlinear springs was proposed in (Hauser et al., 2011). The motion of each nonlinear spring can be formulated as follows:

$$\frac{dx_1}{dt} = x_2, \quad (9)$$

$$\frac{dx_2}{dt} = -p(x_1) - q(x_2) + u, \quad (10)$$

where t represents continuous time, x_1 is the displacement of the spring from its rest length, x_2 is the velocity of the spring motion, p and q are nonlinear functions representing the properties of the spring, and u is the sum of external forces acting on the spring. The input signal is given to some randomly chosen nodes as the external force, inducing nonlinear responses of the mass-spring network. The output signal is obtained as a linear combination of the actual lengths of the springs. Simulations demonstrated the computing power of RC based on the mass-spring network in time-series approximation and robot arm tasks. By adding feedback loops from the output, the reservoir of a mass-spring network can be applied to pattern generation tasks, which are useful for producing locomotion of robots and biological organisms (Hauser et al., 2012). In another extensive study, a reservoir model of a mass-spring-damper network was numerically investigated to clarify the link between the property of the mechanical reservoir and its computational ability in locomotion learning (Urbain et al., 2017). The reservoir of nonlinear mechanical oscillators introduced in Sec. 3.3 is also

By replacing point masses in a mass-spring network by stiff bars, a tensegrity-like structure is obtained. Tensegrity (tension integrity) indicates a structural principle that uses isolated compression elements loaded in a continuous network of tension elements, leading to a physical structure combining strength

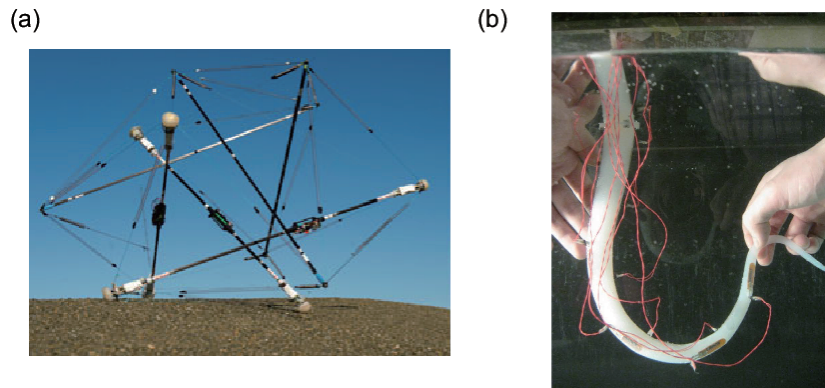

Figure 11: (a) A tensegrity structure-based reservoir (Caluwaerts et al., 2014). Figure reproduced with permission from NASA Ames Research Center. (b) A reservoir based on a soft octopus robot (Nakajima et al., 2015). Figure reproduced from (Nakajima et al., 2015), licensed under CC-BY 4.0.

and flexibility. The compliant body of a tensegrity robot was exploited as a physical reservoir and successfully applied to stable gait pattern generation and terrain pattern classification in numerical experiments (Caluwaerts and Schrauwen, 2011). Moreover, how to effectively implement control in physical reservoirs with tensegrity structure was investigated by considering various learning rules including a reward-modulated Hebbian learning rule (Caluwaerts et al., 2013; Burms et al., 2015). A physical prototype of a reservoir compliant tensegrity robot (ReCTeR, Fig. 11(a)) was developed for creating planetary rovers (Caluwaerts et al., 2014). The highly compliant body of ReCTeR consists of 24 passive spring-cable assemblies and 6 actuated spring-cable assemblies connecting non-parallel struts. The reservoir states obtained from the sensors attached to the struts were used to control the robot in order to approximate desired signals under various control strategies. In another study, better conditions for a tensegrity-based reservoir computer were explored (Fujita et al., 2018).

Another type of physical body is a muscular hydrostat system inspired by octopus limbs, as shown in Fig. 11(b) (Nakajima et al., 2013). This is an extreme embodiment of a soft robotic arm without a skeleton, involving virtually unlimited degrees of freedom. Even though the hydrodynamic effect yields highly complex and time-varying dynamics of the soft robotic arm, its motion was successfully learned by an ESN-based controller in a simulation study (Kuwabara et al., 2012) and in an experimental study using a real robot made of silicone rubber (Li et al., 2012). On the other hand, the complex dynamics of the soft body can be used for physical RC. The computational capability of the soft body was demonstrated in nonlinear system approximations and body dynamics control without an external controller (Nakajima et al., 2014, 2015).

Other attempts to control real robots and generate different robot behav-

iors, based on the concept of RC, can be found in studies on a pneumatically driven soft robot arm (Eder et al., 2017), a spine-driven quadruped robot (Zhao et al., 2013), a dog-like quadruped robot (Wyffels et al., 2010), and a much less compliant quadrupedal robot (Degraeve et al., 2015).

8. Biological RC

A brain region can be regarded as a physical reservoir if RC is a plausible model for spatiotemporal information processing in the brain region. However, it is still unclear whether biological neural networks actually rely on this computational scheme. Researchers have speculated about which part of the brain can be regarded as a reservoir or a readout as well as about how subnetworks of the brain work in the RC framework. On the other hand, physical RC based on *in vitro* biological components has been proposed to investigate the computational capability of biological systems. We review recent studies on RC hypotheses in brain regions in Sec. 8.1 and RC using *in vitro* cultured cells in Sec. 8.2.

8.1. Brain regions

The idea of LSM was originally motivated by the real-time information processing of time-varying input streams in cortical microcircuits (Maass et al., 2002; Maass and Markram, 2004) as described in Sec. 2.1. Since then, researchers debated on whether reservoir computation is actually conducted in the brain and which brain regions can be interpreted to use this computational framework (Fig. 12). It is suggested that RC is one of the general frameworks for state-dependent computation in cortical networks, emerging from the interaction between the incoming stimulation and the internal dynamics in recurrent neural networks (Buonomano and Maass, 2009). Some researchers have hypothesized that the spatiotemporal information processing in cortical and subcortical networks can be interpreted as RC through neurophysiological experiments and/or computational models.

First, we summarize RC-related studies on cortical regions including prefrontal and visual areas. The prefrontal cortex is a front part of the cerebral cortex, which is associated with the planning of cognitive behavior, personality expression, decision making, and moderating social behavior. The flexible context-dependent computations in the prefrontal cortex can be explained by the population dynamics of neurons with recurrent connectivity, indicating that the prefrontal circuits are used for both selection and integration of task-relevant inputs (Mante et al., 2013). The RC properties in monkey prefrontal cortex were investigated to explore how contexts of sensory inputs are represented in cortical dynamics (Enel et al., 2016). A reservoir of model neurons was compared with the monkey prefrontal cortex in terms of their representational and dynamic properties during a cognitive task. Then, it was shown that the reservoir of randomly connected recurrent neural networks can obtain a dynamic form of mixed selectivity (Rigotti et al., 2013) and thus perform a complex context-dependent cognitive task as in cortical neurons. This result suggests that RC

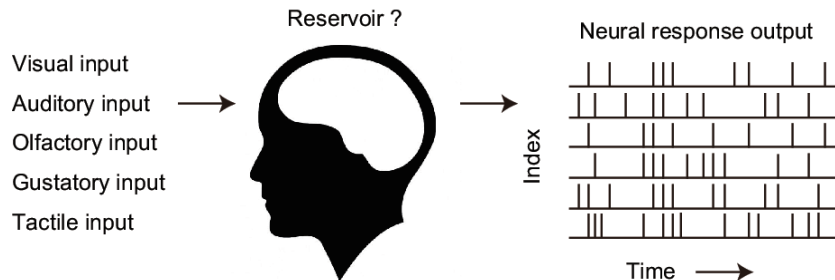

Figure 12: A possibility that some brain regions work as reservoirs.

can be a model of cognitive processing in local generic prefrontal cortical networks. A discussion on the computational role of the thalamus (Dehghani and Wimmer, 2018) also highlights the close relationship between the computational properties of the prefrontal cortex and the main features of RC. It is suggested that the context-dependent computing in the prefrontal cortex relies on the task-dependent modulation of the cortical reservoir by thalamic functions.

The visual cortex is a part of the cerebral cortex that processes visual information. An experimental study has shown evidence that early visual areas have fading memory properties demanded by LSMs (Nikolić et al., 2009). In this experiment, *in vivo* data of neuronal spiking activities in cat primary visual cortex for different visual stimulus are obtained as a reservoir state and they are classified by a simple linear classifier emulating linear integrate-and-fire readout neurons. The new perspective that the primary visual cortex can perform time-dependent computations for sequential inputs based on memory mechanisms is in contrast to the conventional one that it executes frame-by-frame computation based on memory-less hierarchically organized feedforward architectures (Serre et al., 2005).

Second, we move on to studies on RC in subcortical structures including the cerebellum and the basal ganglia. In terms of learning styles, the cerebellum and the basal ganglia can be characterized by supervised learning and reinforcement learning, respectively, which are complementary to each other (Doya, 2000). The cerebellum is mainly involved in the coordination of body movement and is responsible for the learning of motor and non-motor skills. The classical hypothesis is that the cerebellum is a learning device, such as a simple perceptron (Marr, 1969; Albus, 1971). Another viewpoint from a model-based study is that the functional role of cerebellar circuits is interpreted as an LSM (Yamazaki and Tanaka, 2007). In the proposed model, the granular layer constructed with a recurrent inhibitory circuit is regarded as a reservoir that receives inputs through mossy fibers, and the Purkinje cells are regarded as readout neurons. Numerical studies have shown that the cerebellar circuit model successfully learns Boolean functions. This LSM hypothesis highlights an indirect functional pathway in the cerebellum, in addition to the direct pathway regarded as a simple perceptron as in the classical hypothesis. Further exploration in this direction has

made it possible to incorporate recent anatomical and physiological findings on cerebellar microcircuits into computational models (D’Angelo et al., 2016).

The striatum is the primary input module of the basal ganglia and a critical component of the reward system. It plays a significant role not only in motor control and planning but also in reward-modulated decision making. However, it is not obvious how the environmental states are represented in the reinforcement learning of the basal ganglia. Based on the hypothesis that the striatum responds to diverse inputs from different cortical sources and plays a computational role for discriminating inputs in reinforcement learning-based decision making, the LSM properties of a striatal microcircuit were studied with computational models (Toledo-Suárez et al., 2014). It was demonstrated that the separation and approximation properties required for the LSM are generated using a model network of medium spiny neurons and fast spiking interneurons coupled via inhibitory synapses in a supervised learning task.

Third, we focus on the discussion on the relationship between RC and working memory. Working memory is a cognitive process that temporarily stores and manages information for carrying out complex cognitive tasks and is believed to be involved in multiple cortical and subcortical regions. However, elucidating the mechanism for task-dependent switching of the role of neural circuitry remains an unresolved issue. Multiple working memory models based on RC and their variants have been proposed, including the working memory model with generic cortical microcircuit models with feedback (Maass et al., 2007), the ESN-based working memory model (Pascanu and Jaeger, 2011), the reservoir model for storing different time constants of memory traces for reward expectation in reinforcement learning (Bernacchia et al., 2011), the autonomously emerged working memory model through reward-modulated online learning rule that enables the same neural circuit to solve different tasks (Hoerzer et al., 2012), and the comparative analysis of three working memory models including the RC-based one (Barak et al., 2013).

As described above, the biological plausibility of RC in the brain regions has been examined in many studies, but it requires further investigation. To address this issue, the RC models should be evaluated from multiple aspects of structural, dynamical, and functional properties of cognitive systems. For instance, an investigation focused on the robustness and resilience of reservoir models against structural perturbations in cortical circuits (Vincent-Lamarre et al., 2016). Examination of RC from the neuroscience viewpoint is expected to be useful for its applications in brain machine interfacing, disease care, and robot control.

8.2. *in-vitro* cultured cells

A model system to gain insights into the spatiotemporal information processing *in vivo* is cultured biological components *in vitro*.

RC with biological neurons has been demonstrated to investigate the computational function of an assembly of biological components. Microelectrode arrays (MEAs) are widely used to electrically stimulate neuronal cultures and measure their responses as shown in Fig. 13 (Obien et al., 2015). An RC system

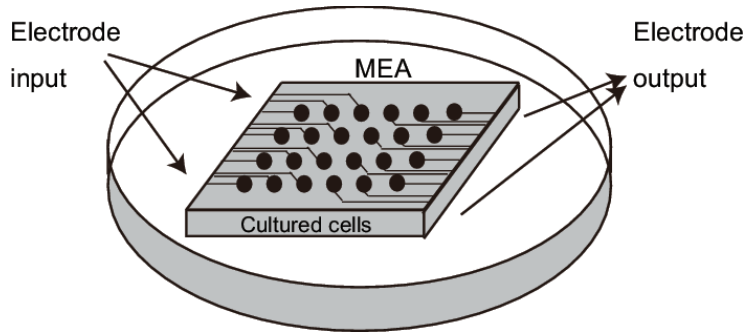

Figure 13: A reservoir of *in-vitro* cell cultures.

that combines a reservoir based on cultured cells on MEAs and a computer-aided readout is regarded as a hybrid biological-silicon computer. An early study demonstrated an LSM using *in vitro* rat cortical neurons plated on CMOS-based MEAs (Hafizovic et al., 2007). Two stimulation patterns with rectangular voltage pulses are given to the electrodes for generating the action potentials of the cultured neurons. The spatiotemporal patterns of spike events recorded with MEAs are transformed into time-continuous reservoir states by a leaky integrator. In the readout on an external computer, a support vector machine is employed for classification of the stimulation patterns. This work was followed by similar experiments. In one such study, the classification ability was investigated with a larger number of stimulation patterns, and the tradeoff between the number of patterns and the separability was evaluated (Ortman et al., 2011). In (Dockendorf et al., 2009), two types of electrical stimulation protocols were used. One is the low-frequency stimulation inducing bursts spikes and the other is the high-frequency stimulation suppressing the burst response. Living cortical networks react to these stimulus patterns differently, generating distinct spatiotemporal spike trains. The goal is to reconstruct the input spatial stimulation pattern from the temporal structures of the spike trains. The results show that the input reconstruction is successful if an appropriate window size is chosen, suggesting the linear separation property in the biological cell networks. In another study, input coding and output decoding methods for LSMs with cultured neurons have been considered (George et al., 2014). The proposed input coding method allows the realization of a large number of input patterns using stimulations through a small number of electrodes. The spatiotemporal spike patterns in the reservoir of cultured cells are transformed into spatial patterns such that a linear classifier works well in the readout.

Instead of electrical stimuli, an optogenetic approach for controlling neuronal activities more precisely has been used in RC experiments. Optical stimuli using random dot patterns were projected onto rat cortical neurons cultured on MEAs as a reservoir (Draniias et al., 2013). Through experiments on short-term memory for optical inputs, it was shown that the results closely match those

of corresponding *in vivo* experiments in (Nikolić et al., 2009). This suggests that the mechanism of state-dependent information processing *in vivo* can be studied using cultured neuronal networks. Based on a similar experimental setting, more complex tasks in the time domain were tested (Ju et al., 2015). In classification tasks of spike template patterns and musical styles, high classification performance was achieved if appropriate MEA channels are selected before the readout process and the spatiotemporal memory processes last for several seconds.

In addition to the input separability, the control of biological reservoirs has received considerable attention in terms of robot control. In this case, the reservoir receives feedback inputs from the output. FORCE learning (Sussillo and Abbott, 2009) was used for a closed loop reservoir with cultured neurons to control the output at a target constant value (Takahashi et al., 2016). This technique can be adopted to control a mobile robot, by which the robot can avoid obstacles and traverse a maze. An application of the concept of RC to robot control is discussed in (Aaser et al., 2017).

Finally, reservoirs based on other living organisms are discussed. A reservoir with bacterium *Escherichia Coli* (E.Coli) reacts to different chemical inputs and generate complex temporal patterns (Jones et al., 2007). A population of E.Coli was placed in a flask and exposed to sequential inputs that indicate time-varying combinatorial conditions of chemical environments and temperatures. Then, samples of E.Coli were moved to a microarray to measure the mRNA and protein concentrations, representing the state of the gene regulatory network. Perceptron learning was used in the readout to classify the stimuli into the appropriate classes. Numerical simulations corresponding to the above experimental design confirmed that the proposed RC is partially successful in an XOR problem and shows good performance in a separation problem. This study motivated a corresponding experiment in a wet lab. In (Didovyk et al., 2014), genetically engineered bacterial cell cultures were used for realizing a variety of simple classifiers separating different chemical inputs, which are aggregated to form a more complex classifier. This conceptual design of machine learning in synthetic biology can be extended to a reservoir computer.

9. Others

There are many other candidates for physical reservoirs. Attempts to exploit novel physical reservoirs for RC can contribute to exploration of unconventional computing methods (Hadaeghi et al., 2017). We introduce two types of physical reservoirs that are not categorized into the aforementioned types.

The first one is RC realized by nano-scale materials and substrates that exhibit stimulation-dependent changes. An example is the atomic switch networks introduced in Sec. 4.2.2. Another proposal is a nano-scale reservoir with quantum dots and chemical compounds that change their absorption spectrum depending on the pH or redox potential in their environment (Obst et al., 2013). An input signal is given as a change in chemical properties of the compounds, which affect the signal transfer between quantum dots randomly dispersed in

a space, encoded as an emission pattern. Simulations confirmed the potential computational performance in an image recognition task. In another study, reservoirs were configured with physical substrates consisting of carbon nanotubes and polymer mixtures (Dale et al., 2016a,b). A computer-aided evolutionary algorithm determines the control voltage signals and the locations of input/output electrodes for finding an optimal configuration of the reservoir. Experimental results showed that the material-based RC with the optimized reservoir configuration is successful in time series prediction benchmark tasks.

Another recently proposed idea is to use complex quantum dynamics for RC (Fujii and Nakajima, 2017). A quantum system consists of multiple qubits (or quantum bit, indicating the minimum unit of information in quantum computing). For N qubits, there are 2^N basis states for a pure quantum state. In quantum RC, each individual node of a quantum reservoir is defined by the system's basis states, not by qubits; therefore, a large number of hidden nodes can be implicitly implemented behind true nodes that are monitored by ensemble measurements. In response to an input signal injected into the first qubit, the quantum system temporally evolves under a Hamiltonian. Then, the states of the qubits obtained by ensemble average measurements are transformed with time multiplexing into a set of signals that are linearly combined to yield an output signal in the readout. High computational performance of the quantum RC was demonstrated in benchmark tasks. In a subsequent study (Nakajima et al., 2018), spatial multiplexing was proposed to enhance the computational power of quantum RC by constructing a system of multiple decoupled quantum reservoirs. Physical implementation of a quantum reservoir system is a challenge for the future.

10. Conclusions and outlook

This review paper summarized recent trends in RC, with special focus on physical RC. Physical reservoirs have been categorized according to the type of their physical phenomena (Secs. 3-9). Most physical reservoirs are designed and configured to satisfy multiple requirements, such as high-dimensionality, nonlinearity, input history-dependent response, fading memory property (echo state property), and/or separation property (Sec. 2.2). However, dynamical behavior produced by different types of physical reservoirs exhibits high diversity in terms of the degree of nonlinearity, transient response time, signal transmission speed, and spatial dimension. This diversity makes physical reservoirs appropriate for various tasks and data.

Physical reservoirs are classified according to their architecture into several types, including network-type reservoir, single-node reservoir having a time-delayed feedback, and excitable medium reservoir. They are characterized as follows.

- Network-type reservoirs consist of interacting nonlinear elements, such as artificial neurons (Sec. 2.1), oscillators (Sec. 3.3), circuit elements (Secs. 4.1.1, 4.1.2, and 4.2), optical nodes (Sec. 5.1), springs (Sec. 7), biological cells

(Sec. 8.2). They can be simply scaled up by an increase in the number of network elements for higher dimensionality. However, realization of a large-scale reservoir requires sophisticated technology to implement massive recurrent interconnections.

- Single nonlinear node reservoirs with time-delayed feedback generate input-dependent patterns in high-dimensional space using virtual nodes on a delay loop (Sec. 3.1). Such reservoirs have been intensively studied for electronic RC (Sec. 4.1.3) and photonic RC (Sec. 5.2). These reservoirs can avoid the problem of networking and thus are more hardware friendly. However, designing and implementing an appropriate delayed feedback loop is not a straightforward task.
- Reservoirs based on excitable media use propagation of waves triggered by stimulation inputs. Propagation phenomena are widely observed in fluids (Sec. 2.2), cellular automata (Sec. 3.2), optical fibers (Sec. 5.3), magnetic materials (Sec. 6), and elastic media (Sec. 7). They have the potential to realize extremely efficient physical RC by harnessing rich physical properties of waves, such as interference, resonance, and synchronization (Katayama et al., 2016). However, their computational power has not been fully understood thus far.

There are general issues to be addressed in physical RC. First, appropriate preprocessing is necessary for maximizing the computational power of each physical RC. In fact, some studies have empirically demonstrated that adequate information transformation of input data is necessary for satisfactory performance. In addition, temporal and spatial scaling of input data critically affects the computational performance as the dynamic range is limited in physical reservoirs. Second, each physical reservoir needs to be optimized by the selection of the best-suited material or substrate as well as the tuning of hyper-parameters, such as the shape and size of the reservoir. Mathematical modeling and analysis of a physical reservoir, under physical constraints and practical conditions, are useful for determining the reservoir settings systematically. It is also practically important to ensure scalability in a single reservoir as well as in combined multiple reservoirs. Third, a training algorithm in the readout should be suitably chosen to be compatible with the physical property of RC. Even if a physical reservoir has high signal processing speed, the total computation speed of the entire physical RC system for online processing is limited by the training speed in the readout. One possible solution to this problem is hardware implementation of the adaptation part in a physical readout, instead of a software-based one.

Some physical RC systems are suited for realizing next-generation machine learning hardware devices and chips with low power consumption. Such RC hardware is potentially capable of high-speed online computation for dynamic data, in contrast to relatively expensive computation in deep learning hardware for static data. This type of hardware is in great demand as edge computing devices for reducing the communication load in the IoT society, where a massive

amount of data is produced and transmitted. Developments of device technology and findings of new materials for this purpose are highly expected. Other physical RC systems are useful for exploring the applicability of natural phenomena to information processing under realistic constraints in biology, chemistry, physics, and engineering. In particular, studies on biological reservoirs are expected to provide new insights into the mechanism of real-time information processing in the brain regions (Sec. 8.1).

Physical RC remains in an early stage of development. For full-scale development of physical RC, further investigation is required from various aspects, such as performance evaluations in practical applications, developments of implementation technology, and theoretical understanding of dynamics and computational function. It is intriguing to exploit novel physical phenomena for RC and to combine physical RC with other machine learning algorithms/hardware. We expect this review to facilitate future interdisciplinary research on physical RC.

Acknowledgments

We would like to thank Ze Hei for his assistance in collecting the relevant papers. This work was partially supported by JSPS KAKENHI Grant Number JP16H00326 (GT).

References

- Aaser, P., Knudsen, M., Huse Ramstad, O., van de Wijdeven, R., Nichele, S., Sandvig, I., Tufte, G., Bauer, U.S., Halaas, Ø., Hendseth, S., et al., 2017. Towards making a cyborg: A closed-loop reservoir-neuro system, in: Proceedings of the European Conference on Artificial Life 2017, MIT Press. pp. 430–437.
- Akrout, A., Bouwens, A., Duport, F., Vinckier, Q., Haelterman, M., Massar, S., 2016. Parallel photonic reservoir computing using frequency multiplexing of neurons. [arXiv:1612.08606](https://arxiv.org/abs/1612.08606) [physics] [arXiv:1612.08606](https://arxiv.org/abs/1612.08606).
- Albus, J.S., 1971. A theory of cerebellar function. *Mathematical Biosciences* 10, 25–61.
- Alomar, M.L., Canals, V., Martínez-Moll, V., Rosselló, J.L., 2014. Low-cost hardware implementation of reservoir computers, in: Power and Timing Modeling, Optimization and Simulation (PATMOS), 2014 24th International Workshop on, IEEE. pp. 1–5.
- Alomar, M.L., Canals, V., Morro, A., Oliver, A., Rossello, J.L., 2016a. Stochastic hardware implementation of liquid state machines, in: Neural Networks (IJCNN), 2016 International Joint Conference on, IEEE. pp. 1128–1133.

- Alomar, M.L., Canals, V., Perez-Mora, N., Martínez-Moll, V., Rosselló, J.L., 2016b. Fpga-based stochastic echo state networks for time-series forecasting. *Computational intelligence and neuroscience* 2016, 15.
- Alomar, M.L., Soriano, M.C., Escalona-Morán, M., Canals, V., Fischer, I., Mirasso, C.R., Rosselló, J.L., 2015. Digital implementation of a single dynamical node reservoir computer. *IEEE Transactions on Circuits and Systems II: Express Briefs* 62, 977–981.
- Antonik, P., Duport, F., Hermans, M., Smerieri, A., Haelterman, M., Massar, S., 2017a. Online Training of an Opto-Electronic Reservoir Computer Applied to Real-Time Channel Equalization. *IEEE Transactions on Neural Networks and Learning Systems* 28, 2686–2698.
- Antonik, P., Haelterman, M., Massar, S., 2017b. Brain-Inspired Photonic Signal Processor for Generating Periodic Patterns and Emulating Chaotic Systems. *Physical Review Applied* 7, 054014.
- Antonik, P., Hermans, M., Haelterman, M., Massar, S., 2017c. Random Pattern and Frequency Generation Using a Photonic Reservoir Computer with Output Feedback. *Neural Processing Letters* , 1–14.
- Antonik, P., Smerieri, A., Duport, F., Haelterman, M., Massar, S., 2015. Fpga implementation of reservoir computing with online learning, in: *24th Belgian-Dutch Conference on Machine Learning*.
- Appeltant, L., Van der Sande, G., Danckaert, J., Fischer, I., 2014. Constructing optimized binary masks for reservoir computing with delay systems. *Scientific reports* 4, 3629.
- Appeltant, L., Soriano, M.C., Van der Sande, G., Danckaert, J., Massar, S., Dambre, J., Schrauwen, B., Mirasso, C.R., Fischer, I., 2011. Information processing using a single dynamical node as complex system. *Nature communications* 2, 468.
- Bao, X., Zhao, Q., Yin, H., Qin, J., 2018. Recognition of the optical packet header for two channels utilizing the parallel reservoir computing based on a semiconductor ring laser. *Modern Physics Letters B* , 1850150.
- Barak, O., Sussillo, D., Romo, R., Tsodyks, M., Abbott, L., 2013. From fixed points to chaos: three models of delayed discrimination. *Progress in neurobiology* 103, 214–222.
- Bennett, C.H., Querlioz, D., Klein, J.O., 2017. Spatio-temporal learning with arrays of analog nanosynapses, in: *2017 IEEE/ACM International Symposium on Nanoscale Architectures (NANOARCH)*, IEEE. pp. 125–130.
- Bernacchia, A., Seo, H., Lee, D., Wang, X.J., 2011. A reservoir of time constants for memory traces in cortical neurons. *Nature neuroscience* 14, 366.

- Bertschinger, N., Natschläger, T., 2004. Real-time computation at the edge of chaos in recurrent neural networks. *Neural computation* 16, 1413–1436.
- Bourianoff, G., Pinna, D., Sitte, M., Everschor-Sitte, K., 2018. Potential implementation of reservoir computing models based on magnetic skyrmions. *AIP Advances* 8, 055602.
- Brunner, D., Fischer, I., 2015. Reconfigurable semiconductor laser networks based on diffractive coupling. *Optics Letters* 40, 3854–3857.
- Brunner, D., Soriano, M.C., Fischer, I., 2013a. High-Speed Optical Vector and Matrix Operations Using a Semiconductor Laser. *IEEE Photonics Technology Letters* 25, 1680–1683.
- Brunner, D., Soriano, M.C., Mirasso, C.R., Fischer, I., 2013b. Parallel photonic information processing at gigabyte per second data rates using transient states. *Nature communications* 4, 1364.
- Bueno, J., Brunner, D., Soriano, M.C., Fischer, I., 2017. Conditions for reservoir computing performance using semiconductor lasers with delayed optical feedback. *Optics Express* 25, 2401–2412.
- Buonomano, D.V., Maass, W., 2009. State-dependent computations: spatiotemporal processing in cortical networks. *Nature Reviews Neuroscience* 10, 113.
- Bürger, J., Goudarzi, A., Stefanovic, D., Teuscher, C., 2015a. Computational capacity and energy consumption of complex resistive switch networks. *AIMS Materials Science* 2, 530–545.
- Bürger, J., Goudarzi, A., Stefanovic, D., Teuscher, C., 2015b. Hierarchical composition of memristive networks for real-time computing, in: *Nanoscale Architectures (NANOARCH), 2015 IEEE/ACM International Symposium on, IEEE*. pp. 33–38.
- Bürger, J., Teuscher, C., 2013. Variation-tolerant computing with memristive reservoirs, in: *Proceedings of the 2013 IEEE/ACM International Symposium on Nanoscale Architectures, IEEE Press*. pp. 1–6.
- Burms, J., Caluwaerts, K., Dambre, J., 2015. Reward-modulated hebbian plasticity as leverage for partially embodied control in compliant robotics. *Frontiers in neurobotics* 9, 9.
- Caluwaerts, K., Despraz, J., Işçen, A., Sabelhaus, A.P., Bruce, J., Schrauwen, B., SunSpiral, V., 2014. Design and control of compliant tensegrity robots through simulation and hardware validation. *Journal of the royal society interface* 11, 20140520.
- Caluwaerts, K., D’Haene, M., Verstraeten, D., Schrauwen, B., 2013. Locomotion without a brain: physical reservoir computing in tensegrity structures. *Artificial life* 19, 35–66.

- Caluwaerts, K., Schrauwen, B., 2011. The body as a reservoir: locomotion and sensing with linear feedback, in: 2nd International conference on Morphological Computation (ICMC 2011), pp. 45–47.
- Carbajal, J.P., Dambre, J., Hermans, M., Schrauwen, B., 2015. Memristor models for machine learning. *Neural computation* .
- Chua, L., 1971. Memristor-the missing circuit element. *IEEE Transactions on circuit theory* 18, 507–519.
- Chua, L.O., Kang, S.M., 1976. Memristive devices and systems. *Proceedings of the IEEE* 64, 209–223.
- Coulombe, J.C., York, M.C., Sylvestre, J., 2017. Computing with networks of nonlinear mechanical oscillators. *PloS one* 12, e0178663.
- Dale, M., Miller, J.F., Stepney, S., Trefzer, M.A., 2016a. Evolving carbon nanotube reservoir computers, in: *International Conference on Unconventional Computation and Natural Computation*, Springer. pp. 49–61.
- Dale, M., Stepney, S., Miller, J.F., Trefzer, M., 2016b. Reservoir computing in materio: An evaluation of configuration through evolution, in: *Computational Intelligence (SSCI), 2016 IEEE Symposium Series on, IEEE*. pp. 1–8.
- D’Angelo, E., Antonietti, A., Casali, S., Casellato, C., Garrido, J.A., Luque, N.R., Mapelli, L., Masoli, S., Pedrocchi, A., Prestori, F., et al., 2016. Modeling the cerebellar microcircuit: New strategies for a long-standing issue. *Frontiers in cellular neuroscience* 10, 176.
- Degrave, J., Caluwaerts, K., Dambre, J., Wyffels, F., 2015. Developing an embodied gait on a compliant quadrupedal robot, in: *Intelligent Robots and Systems (IROS), 2015 IEEE/RSJ International Conference on, IEEE*. pp. 4486–4491.
- Dehghani, N., Wimmer, R.D., 2018. A computational perspective of the role of thalamus in cognition. *arXiv preprint arXiv:1803.00997* .
- Dejonckheere, A., Duport, F., Smerieri, A., Fang, L., Oudar, J.L., Haelterman, M., Massar, S., 2014. All-optical reservoir computer based on saturation of absorption. *Optics express* 22, 10868–10881.
- Didovyk, A., Kanakov, O.I., Ivanchenko, M.V., Hasty, J., Huerta, R., Tsimring, L., 2014. Distributed classifier based on genetically engineered bacterial cell cultures. *ACS synthetic biology* 4, 72–82.
- Dockendorf, K.P., Park, I., He, P., Príncipe, J.C., DeMarse, T.B., 2009. Liquid state machines and cultured cortical networks: The separation property. *Biosystems* 95, 90–97.

- Donahue, C., Merkel, C., Saleh, Q., Dolgova, L., Ooi, Y.K., Kudithipudi, D., Wysocki, B., 2015. Design and analysis of neuromemristive echo state networks with limited-precision synapses, in: *Computational Intelligence for Security and Defense Applications (CISDA)*, 2015 IEEE Symposium on, IEEE. pp. 1–6.
- Dong, J., Gigan, S., Krzakala, F., Wainrib, G., 2016. Scaling up Echo-State Networks with multiple light scattering. *arXiv:1609.05204 [physics]* [arXiv:1609.05204](https://arxiv.org/abs/1609.05204).
- Doya, K., 1998. Recurrent networks: Supervised learning, in: *The handbook of brain theory and neural networks*, MIT Press. pp. 796–800.
- Doya, K., 2000. Complementary roles of basal ganglia and cerebellum in learning and motor control. *Current opinion in neurobiology* 10, 732–739.
- Dranias, M.R., Ju, H., Rajaram, E., VanDongen, A.M., 2013. Short-term memory in networks of dissociated cortical neurons. *Journal of Neuroscience* 33, 1940–1953.
- Du, C., Cai, F., Zidan, M.A., Ma, W., Lee, S.H., Lu, W.D., 2017. Reservoir computing using dynamic memristors for temporal information processing. *Nature communications* 8, 2204.
- Duport, F., Schneider, B., Smerieri, A., Haelterman, M., Massar, S., 2012. All-optical reservoir computing. *Optics express* 20, 22783–22795.
- Duport, F., Smerieri, A., Akrouf, A., Haelterman, M., Massar, S., 2016a. Fully analogue photonic reservoir computer. *Scientific Reports* 6, 22381.
- Duport, F., Smerieri, A., Akrouf, A., Haelterman, M., Massar, S., 2016b. Virtualization of a Photonic Reservoir Computer. *Journal of Lightwave Technology* 34, 2085–2091.
- Eder, M., Hirsch, F., Hauser, H., 2017. Morphological computation-based control of a modular, pneumatically driven, soft robotic arm. *Advanced Robotics* , 1–11.
- Enel, P., Procyk, E., Quilodran, R., Dominey, P.F., 2016. Reservoir computing properties of neural dynamics in prefrontal cortex. *PLoS computational biology* 12, e1004967.
- Fernando, C., Sojakka, S., 2003. Pattern recognition in a bucket, in: *European Conference on Artificial Life*, Springer. pp. 588–597.
- Ferreira, d.L.T., Shastri, B.J., Tait, A.N., Nahmias, M.A., Prucnal, P.R., 2017. Progress in neuromorphic photonics. *Nanophotonics* 6, 577–599.

- Fiers, M.A.A., Vaerenbergh, T.V., Wyffels, F., Verstraeten, D., Schrauwen, B., Dambre, J., Bienstman, P., 2014. Nanophotonic Reservoir Computing With Photonic Crystal Cavities to Generate Periodic Patterns. *IEEE Transactions on Neural Networks and Learning Systems* 25, 344–355.
- Fujii, K., Nakajima, K., 2017. Harnessing disordered-ensemble quantum dynamics for machine learning. *Physical Review Applied* 8, 024030.
- Fujita, K., Yonekura, S., Nishikawa, S., Niiyama, R., Kuniyoshi, Y., 2018. Environmental and structural effects on physical reservoir computing with tensegrity. *Journal of the Institute of Industrial Applications Engineers* 6, 92–99.
- Furuta, T., Fujii, K., Nakajima, K., Sumito, T., Hitoshi, K., Suzuki, Y., Miwa, S., 2018. Macromagnetic simulation for reservoir computing utilizing spin-dynamics in magnetic tunnel junctions. *arXiv preprint arXiv:1805.09977*.
- George, J.B., Abraham, G.M., Singh, K., Ankolekar, S.M., Amrutur, B., Sikdar, S.K., 2014. Input coding for neuro-electronic hybrid systems. *Biosystems* 126, 1–11.
- Ghani, A., See, C.H., Migdadi, H., Asif, R., Abd-Alhameed, R.A., Noras, J.M., 2015. Reconfigurable neurons-making the most of configurable logic blocks (clbs), in: *Internet Technologies and Applications (ITA), 2015, IEEE*. pp. 475–478.
- Goudarzi, A., Lakin, M.R., Stefanovic, D., 2013. Dna reservoir computing: a novel molecular computing approach, in: *International Workshop on DNA-Based Computers, Springer*. pp. 76–89.
- Grzyb, B.J., Chinellato, E., Wojcik, G.M., Kaminski, W.A., 2009. Which model to use for the liquid state machine?, in: *Neural Networks, 2009. IJCNN 2009. International Joint Conference on, IEEE*. pp. 1018–1024.
- Hadaeghi, F., He, X., Jaeger, H., 2017. *Unconventional Information Processing Systems, Novel Hardware: A Tour D’Horizon*. IRC-Library, Information Resource Center der Jacobs University Bremen.
- Hafizovic, S., Heer, F., Ugniwenko, T., Frey, U., Blau, A., Ziegler, C., Hierlemann, A., 2007. A cmos-based microelectrode array for interaction with neuronal cultures. *Journal of neuroscience methods* 164, 93–106.
- Hassan, A.M., Li, H.H., Chen, Y., 2017. Hardware implementation of echo state networks using memristor double crossbar arrays, in: *Neural Networks (IJCNN), 2017 International Joint Conference on, IEEE*. pp. 2171–2177.
- Hauser, H., Ijspeert, A.J., Fuchslin, R.M., Pfeifer, R., Maass, W., 2011. Towards a theoretical foundation for morphological computation with compliant bodies. *Biological cybernetics* 105, 355–370.

- Hauser, H., Ijspeert, A.J., Fuchslin, R.M., Pfeifer, R., Maass, W., 2012. The role of feedback in morphological computation with compliant bodies. *Biological cybernetics* 106, 595–613.
- Haynes, N.D., Soriano, M.C., Rosin, D.P., Fischer, I., Gauthier, D.J., 2015. Reservoir computing with a single time-delay autonomous boolean node. *Physical Review E* 91, 020801.
- Hermans, M., Antonik, P., Haelterman, M., Massar, S., 2016. Embodiment of Learning in Electro-Optical Signal Processors. *Physical Review Letters* 117, 128301.
- Hermans, M., Dambre, J., Bienstman, P., 2015a. Optoelectronic Systems Trained With Backpropagation Through Time. *IEEE Transactions on Neural Networks and Learning Systems* 26, 1545–1550.
- Hermans, M., Soriano, M.C., Dambre, J., Bienstman, P., Fischer, I., 2015b. Photonic Delay Systems as Machine Learning Implementations. *Journal of Machine Learning Research* 16, 2081–2097.
- Héroux, J.B., Numata, H., Kanazawa, N., Nakano, D., 2018. Optoelectronic reservoir computing with vcsel, in: 2018 International Joint Conference on Neural Networks (IJCNN), p. 000.
- Héroux, J.B., Numata, H., Nakano, D., 2017. Polymer Waveguide-Based Reservoir Computing, in: *Neural Information Processing*, Springer, Cham. pp. 840–848.
- Hicke, K., Escalona-Morán, M.A., Brunner, D., Soriano, M.C., Fischer, I., Mirasso, C.R., 2013. Information processing using transient dynamics of semiconductor lasers subject to delayed feedback. *IEEE Journal of Selected Topics in Quantum Electronics* 19, 1501610–1501610.
- Hochreiter, S., Schmidhuber, J., 1997. Long short-term memory. *Neural computation* 9, 1735–1780.
- Hoerzer, G.M., Legenstein, R., Maass, W., 2012. Emergence of complex computational structures from chaotic neural networks through reward-modulated hebbian learning. *Cerebral cortex* 24, 677–690.
- Hofmann, T., Schölkopf, B., Smola, A.J., 2008. Kernel methods in machine learning. *The annals of statistics* , 1171–1220.
- Hou, Y., Xia, G., Yang, W., Wang, D., Jayaprasath, E., Jiang, Z., Hu, C., Wu, Z., 2018. Prediction performance of reservoir computing system based on a semiconductor laser subject to double optical feedback and optical injection. *Optics Express* 26, 10211–10219.
- Indiveri, G., Linares-Barranco, B., Legenstein, R., Deligeorgis, G., Prodromakis, T., 2013. Integration of nanoscale memristor synapses in neuromorphic computing architectures. *Nanotechnology* 24, 384010.

- Jaeger, H., 2001a. The "echo state" approach to analysing and training recurrent neural networks-with an erratum note. Bonn, Germany: German National Research Center for Information Technology GMD Technical Report 148, 13.
- Jaeger, H., 2001b. Short term memory in echo state networks. volume 5. GMD-Forschungszentrum Informationstechnik.
- Jaeger, H., 2002. Tutorial on training recurrent neural networks, covering BPPT, RTRL, EKF and the "echo state network" approach. volume 5. GMD-Forschungszentrum Informationstechnik Bonn.
- Jaeger, H., 2003. Adaptive nonlinear system identification with echo state networks, in: *Advances in neural information processing systems*, pp. 609–616.
- Jaeger, H., Haas, H., 2004. Harnessing nonlinearity: Predicting chaotic systems and saving energy in wireless communication. *Science* 304, 78–80.
- Jaeger, H., Maass, W., Principe, J., 2007. Special issue on echo state networks and liquid state machines.
- Jalalvand, A., Van Wallendael, G., Van de Walle, R., 2015. Real-time reservoir computing network-based systems for detection tasks on visual contents, in: *Computational Intelligence, Communication Systems and Networks (CICSyN)*, 2015 7th International Conference on, IEEE. pp. 146–151.
- Jin, Y., Li, P., 2017. Performance and robustness of bio-inspired digital liquid state machines: A case study of speech recognition. *Neurocomputing* 226, 145–160.
- Jones, B., Stekel, D., Rowe, J., Fernando, C., 2007. Is there a liquid state machine in the bacterium *escherichia coli*?, in: *Artificial Life, 2007. ALIFE'07. IEEE Symposium on, Ieee*. pp. 187–191.
- Ju, H., Dranias, M.R., Banumurthy, G., VanDongen, A.M., 2015. Spatiotemporal memory is an intrinsic property of networks of dissociated cortical neurons. *Journal of Neuroscience* 35, 4040–4051.
- Katayama, Y., Yamane, T., Nakano, D., Nakane, R., Tanaka, G., 2016. Wave-based neuromorphic computing framework for brain-like energy efficiency and integration. *IEEE Transactions on Nanotechnology* 15, 762–769.
- Katumba, A., Freiberger, M., Bienstman, P., Dambre, J., 2017. A Multiple-Input Strategy to Efficient Integrated Photonic Reservoir Computing. *Cognitive Computation* 9, 307–314.
- Katumba, A., Heyvaert, J., Schneider, B., Uvin, S., Dambre, J., Bienstman, P., 2018. Low-Loss Photonic Reservoir Computing with Multimode Photonic Integrated Circuits. *Scientific Reports* 8, 2653.

- Kudithipudi, D., Saleh, Q., Merkel, C., Thesing, J., Wysocki, B., 2016. Design and analysis of a neuromemristive reservoir computing architecture for biosignal processing. *Frontiers in neuroscience* 9, 502.
- Kulkarni, M.S., Teuscher, C., 2012. Memristor-based reservoir computing, in: 2012 IEEE/ACM International Symposium on Nanoscale Architectures (NANOARCH), pp. 226–232.
- Kuriki, Y., Nakayama, J., Takano, K., Uchida, A., 2018. Impact of input mask signals on delay-based photonic reservoir computing with semiconductor lasers. *Optics Express* 26, 5777–5788.
- Kuwabara, J., Nakajima, K., Kang, R., Branson, D.T., Guglielmino, E., Caldwell, D.G., Pfeifer, R., 2012. Timing-based control via echo state network for soft robotic arm, in: *Neural Networks (IJCNN), The 2012 International Joint Conference on, IEEE*. pp. 1–8.
- Laporte, F., Katumba, A., Dambre, J., Bienstman, P., 2018. Numerical demonstration of neuromorphic computing with photonic crystal cavities. *Optics Express* 26, 7955–7964.
- Larger, L., Baylón-Fuentes, A., Martinenghi, R., Udaltsov, V.S., Chembo, Y.K., Jacquot, M., 2017. High-Speed Photonic Reservoir Computing Using a Time-Delay-Based Architecture: Million Words per Second Classification. *Physical Review X* 7, 011015.
- Larger, L., Soriano, M.C., Brunner, D., Appeltant, L., Gutierrez, J.M., Pesquera, L., Mirasso, C.R., Fischer, I., 2012. Photonic information processing beyond Turing: An optoelectronic implementation of reservoir computing. *Optics Express* 20, 3241–3249.
- Legenstein, R., Maass, W., 2007. Edge of chaos and prediction of computational performance for neural circuit models. *Neural Networks* 20, 323–334.
- Lepri, S., Giacomelli, G., Politi, A., Arecchi, F., 1994. High-dimensional chaos in delayed dynamical systems. *Physica D: Nonlinear Phenomena* 70, 235–249.
- Li, J., Zhao, C., Hamedani, K., Yi, Y., 2017. Analog hardware implementation of spike-based delayed feedback reservoir computing system, in: *Neural Networks (IJCNN), 2017 International Joint Conference on, IEEE*. pp. 3439–3446.
- Li, T., Nakajima, K., Cianchetti, M., Laschi, C., Pfeifer, R., 2012. Behavior switching using reservoir computing for a soft robotic arm, in: *Robotics and Automation (ICRA), 2012 IEEE International Conference on, IEEE*. pp. 4918–4924.
- Liu, Y., Jin, Y., Li, P., 2018. Online adaptation and energy minimization for hardware recurrent spiking neural networks. *ACM Journal on Emerging Technologies in Computing Systems (JETC)* 14, 11.

- Lukoševičius, M., 2012. A practical guide to applying echo state networks, in: *Neural networks: Tricks of the trade*. Springer, pp. 659–686.
- Lukoševičius, M., Jaeger, H., 2009. Reservoir computing approaches to recurrent neural network training. *Computer Science Review* 3, 127–149.
- Lukoševičius, M., Jaeger, H., Schrauwen, B., 2012. Reservoir computing trends. *KI-Künstliche Intelligenz* 26, 365–371.
- Maass, W., 2011. Liquid state machines: motivation, theory, and applications, in: *Computability in context: computation and logic in the real world*. World Scientific, pp. 275–296.
- Maass, W., Joshi, P., Sontag, E.D., 2007. Computational aspects of feedback in neural circuits. *PLoS computational biology* 3, e165.
- Maass, W., Markram, H., 2004. On the computational power of circuits of spiking neurons. *Journal of computer and system sciences* 69, 593–616.
- Maass, W., Natschläger, T., Markram, H., 2002. Real-time computing without stable states: A new framework for neural computation based on perturbations. *Neural computation* 14, 2531–2560.
- Maass, W., Natschläger, T., Markram, H., 2004. Fading memory and kernel properties of generic cortical microcircuit models. *Journal of Physiology-Paris* 98, 315–330.
- Mandic, D.P., Chambers, J.A., et al., 2001. *Recurrent neural networks for prediction: learning algorithms, architectures and stability*. Wiley Online Library.
- Mante, V., Sussillo, D., Shenoy, K.V., Newsome, W.T., 2013. Context-dependent computation by recurrent dynamics in prefrontal cortex. *nature* 503, 78.
- Marr, D., 1969. A theory of cerebellar cortex. *The Journal of physiology* 202, 437–470.
- Martinenghi, R., Rybalko, S., Jacquot, M., Chembo, Y.K., Larger, L., 2012. Photonic nonlinear transient computing with multiple-delay wavelength dynamics. *Physical review letters* 108, 244101.
- McDonald, N., 2017. Reservoir computing & extreme learning machines using pairs of cellular automata rules, in: *Neural Networks (IJCNN), 2017 International Joint Conference on, IEEE*. pp. 2429–2436.
- Merkel, C., Saleh, Q., Donahue, C., Kudithipudi, D., 2014. Memristive reservoir computing architecture for epileptic seizure detection. *Procedia Computer Science* 41, 249–254.

- Mesaritakis, C., Bogris, A., Kapsalis, A., Syvridis, D., 2015. High-speed all-optical pattern recognition of dispersive Fourier images through a photonic reservoir computing subsystem. *Optics Letters* 40, 3416–3419.
- Mesaritakis, C., Papataxiarhis, V., Syvridis, D., 2013. Micro ring resonators as building blocks for an all-optical high-speed reservoir-computing bit-pattern-recognition system. *JOSA B* 30, 3048–3055.
- Nakajima, K., Fujii, K., Negoro, M., Mitarai, K., Kitagawa, M., 2018. Boosting computational power through spatial multiplexing in quantum reservoir computing. *arXiv preprint arXiv:1803.04574* .
- Nakajima, K., Hauser, H., Kang, R., Guglielmino, E., Caldwell, D.G., Pfeifer, R., 2013. A soft body as a reservoir: case studies in a dynamic model of octopus-inspired soft robotic arm. *Frontiers in computational neuroscience* 7, 91.
- Nakajima, K., Hauser, H., Li, T., Pfeifer, R., 2015. Information processing via physical soft body. *Scientific reports* 5, 10487.
- Nakajima, K., Li, T., Hauser, H., Pfeifer, R., 2014. Exploiting short-term memory in soft body dynamics as a computational resource. *Journal of The Royal Society Interface* 11, 20140437.
- Nakane, R., Tanaka, G., Hirose, A., 2018. Reservoir computing with spin waves excited in a garnet film. *IEEE Access* 6, 4462–4469.
- Nakao, H., 2016. Phase reduction approach to synchronisation of nonlinear oscillators. *Contemporary Physics* 57, 188–214.
- Nakayama, J., Kanno, K., Uchida, A., 2016. Laser dynamical reservoir computing with consistency: An approach of a chaos mask signal. *Optics Express* 24, 8679–8692.
- Nguimdo, R.M., Verschaffelt, G., Danckaert, J., der Sande, G.V., 2015. Simultaneous Computation of Two Independent Tasks Using Reservoir Computing Based on a Single Photonic Nonlinear Node With Optical Feedback. *IEEE Transactions on Neural Networks and Learning Systems* 26, 3301–3307.
- Nguimdo, R.M., Verschaffelt, G., Danckaert, J., der Sande, G.V., 2016. Reducing the phase sensitivity of laser-based optical reservoir computing systems. *Optics Express* 24, 1238–1252.
- Nichele, S., Gundersen, M.S., 2017. Reservoir computing using non-uniform binary cellular automata. *arXiv preprint arXiv:1702.03812* .
- Nichele, S., Molund, A., 2017. Deep reservoir computing using cellular automata. *arXiv preprint arXiv:1703.02806* .

- Nikolić, D., Häusler, S., Singer, W., Maass, W., 2009. Distributed fading memory for stimulus properties in the primary visual cortex. *PLoS biology* 7, e1000260.
- Obien, M.E.J., Deligkaris, K., Bullmann, T., Bakkum, D.J., Frey, U., 2015. Revealing neuronal function through microelectrode array recordings. *Frontiers in neuroscience* 8, 423.
- Obst, O., Trinchi, A., Hardin, S.G., Chadwick, M., Cole, I., Muster, T.H., Hoshcke, N., Ostry, D., Price, D., Pham, K.N., et al., 2013. Nano-scale reservoir computing. *Nano Communication Networks* 4, 189–196.
- Ortín, S., Pesquera, L., 2017. Reservoir computing with an ensemble of time-delay reservoirs. *Cognitive Computation* 9, 327–336.
- Ortín, S., Soriano, M.C., Pesquera, L., Brunner, D., San-Martín, D., Fischer, I., Mirasso, C.R., Gutiérrez, J.M., 2015. A Unified Framework for Reservoir Computing and Extreme Learning Machines based on a Single Time-delayed Neuron. *Scientific Reports* 5, 14945.
- Ortman, R.L., Venayagamoorthy, K., Potter, S.M., 2011. Input separability in living liquid state machines, in: *International Conference on Adaptive and Natural Computing Algorithms*, Springer. pp. 220–229.
- Ozturk, M.C., Xu, D., Príncipe, J.C., 2007. Analysis and design of echo state networks. *Neural computation* 19, 111–138.
- Paquot, Y., Duport, F., Smerieri, A., Dambre, J., Schrauwen, B., Haelterman, M., Massar, S., 2012. Optoelectronic Reservoir Computing. *Scientific Reports* 2, 287.
- Parihar, A., Shukla, N., Jerry, M., Datta, S., Raychowdhury, A., 2017. Computing with dynamical systems based on insulator-metal-transition oscillators. *Nanophotonics* 6, 601–611.
- Pascanu, R., Jaeger, H., 2011. A neurodynamical model for working memory. *Neural networks* 24, 199–207.
- Pfeifer, R., Bongard, J., 2006. *How the body shapes the way we think: a new view of intelligence*. MIT press.
- Polepalli, A., Soures, N., Kudithipudi, D., 2016a. Digital neuromorphic design of a liquid state machine for real-time processing, in: *Rebooting Computing (ICRC)*, IEEE International Conference on, IEEE. pp. 1–8.
- Polepalli, A., Soures, N., Kudithipudi, D., 2016b. Reconfigurable digital design of a liquid state machine for spatio-temporal data, in: *Proceedings of the 3rd ACM International Conference on Nanoscale Computing and Communication*, ACM. p. 15.

- Prucnal, P.R., Shastri, B.J., de Lima, T.F., Nahmias, M.A., Tait, A.N., 2016. Recent progress in semiconductor excitable lasers for photonic spike processing. *Advances in Optics and Photonics* 8, 228–299.
- Prychynenko, D., Sitte, M., Litzius, K., Krüger, B., Bourianoff, G., Kläui, M., Sinova, J., Everschor-Sitte, K., 2018. Magnetic skyrmion as a nonlinear resistive element: A potential building block for reservoir computing. *Physical Review Applied* 9, 014034.
- Qin, J., Zhao, Q., Xu, D., Yin, H., Chang, Y., Huang, D., 2016. Optical packet header identification utilizing an all-optical feedback chaotic reservoir computing. *Modern Physics Letters B* 30, 1650199.
- Qin, J., Zhao, Q., Yin, H., Jin, Y., Liu, C., 2017. Numerical Simulation and Experiment on Optical Packet Header Recognition Utilizing Reservoir Computing Based on Optoelectronic Feedback. *IEEE Photonics Journal* 9, 1–11.
- Rigotti, M., Barak, O., Warden, M.R., Wang, X.J., Daw, N.D., Miller, E.K., Fusi, S., 2013. The importance of mixed selectivity in complex cognitive tasks. *Nature* 497, 585.
- Roy, S., Banerjee, A., Basu, A., 2014. Liquid state machine with dendritically enhanced readout for low-power, neuromorphic vlsi implementations. *IEEE transactions on biomedical circuits and systems* 8, 681–695.
- Rumelhart, D.E., Hinton, G.E., Williams, R.J., 1985. Learning internal representations by error propagation. Technical Report. California Univ San Diego La Jolla Inst for Cognitive Science.
- Samarasinghe, S., 2016. *Neural networks for applied sciences and engineering: from fundamentals to complex pattern recognition*. CRC Press.
- Van der Sande, G., Brunner, D., Soriano, M.C., 2017. Advances in photonic reservoir computing. *Nanophotonics* 6, 561–576.
- Scardapane, S., Wang, D., 2017. Randomness in neural networks: an overview. *Wiley Interdisciplinary Reviews: Data Mining and Knowledge Discovery* 7.
- Schmidhuber, J., 2015. Deep learning in neural networks: An overview. *Neural networks* 61, 85–117.
- Schneider, B., Dambre, J., Bienstman, P., 2016. Using Digital Masks to Enhance the Bandwidth Tolerance and Improve the Performance of On-Chip Reservoir Computing Systems. *IEEE Transactions on Neural Networks and Learning Systems* 27, 2748–2753.
- Schrauwen, B., DfHaene, M., Verstraeten, D., Van Campenhout, J., 2008. Compact hardware liquid state machines on fpga for real-time speech recognition. *Neural networks* 21, 511–523.

- Schrauwen, B., Verstraeten, D., Van Campenhout, J., 2007. An overview of reservoir computing: theory, applications and implementations, in: Proceedings of the 15th European Symposium on Artificial Neural Networks. p. 471-482 2007, pp. 471–482.
- Schürmann, F., Meier, K., Schemmel, J., 2005. Edge of chaos computation in mixed-mode vlsi - “a hard liquid”, in: Advances in neural information processing systems, pp. 1201–1208.
- Serre, T., Kouh, M., Cadieu, C., Knoblich, U., Kreiman, G., Poggio, T., 2005. A theory of object recognition: computations and circuits in the feedforward path of the ventral stream in primate visual cortex. AI Memo 2005-036/CBCL Memo 259, Massachusetts Inst. of Technology, Cambridge .
- Shi, W., Cao, J., Zhang, Q., Li, Y., Xu, L., 2016. Edge computing: Vision and challenges. IEEE Internet of Things Journal 3, 637–646.
- Sillin, H.O., Aguilera, R., Shieh, H.H., Avizienis, A.V., Aono, M., Stieg, A.Z., Gimzewski, J.K., 2013. A theoretical and experimental study of neuromorphic atomic switch networks for reservoir computing. Nanotechnology 24, 384004.
- Smith, M.R., Hill, A.J., Carlson, K.D., Vineyard, C.M., Donaldson, J., Follett, D.R., Follett, P.L., Naegle, J.H., James, C.D., Aimone, J.B., 2017. A novel digital neuromorphic architecture efficiently facilitating complex synaptic response functions applied to liquid state machines, in: Neural Networks (IJCNN), 2017 International Joint Conference on, IEEE. pp. 2421–2428.
- Snyder, D., Goudarzi, A., Teuscher, C., 2013. Computational capabilities of random automata networks for reservoir computing. Physical Review E 87, 042808.
- Soh, H., Demiris, Y., 2012. Iterative temporal learning and prediction with the sparse online echo state gaussian process, in: Neural Networks (IJCNN), The 2012 International Joint Conference on, IEEE. pp. 1–8.
- Soriano, M.C., Brunner, D., Escalona-Morán, M., Mirasso, C.R., Fischer, I., 2015a. Minimal approach to neuro-inspired information processing. Frontiers in computational neuroscience 9, 68.
- Soriano, M.C., Ortín, S., Brunner, D., Larger, L., Mirasso, C.R., Fischer, I., Pesquera, L., 2013. Optoelectronic reservoir computing: Tackling noise-induced performance degradation. Optics Express 21, 12–20.
- Soriano, M.C., Ortín, S., Keuninckx, L., Appeltant, L., Danckaert, J., Pesquera, L., Van der Sande, G., 2015b. Delay-based reservoir computing: noise effects in a combined analog and digital implementation. IEEE transactions on neural networks and learning systems 26, 388–393.

- Soures, N., Hays, L., Kudithipudi, D., 2017. Robustness of a memristor based liquid state machine, in: *Neural Networks (IJCNN), 2017 International Joint Conference on, IEEE*. pp. 2414–2420.
- Steil, J.J., 2004. Backpropagation-decorrelation: online recurrent learning with $O(n)$ complexity, in: *Neural Networks, 2004. Proceedings. 2004 IEEE International Joint Conference on, IEEE*. pp. 843–848.
- Steil, J.J., 2007. Online reservoir adaptation by intrinsic plasticity for backpropagation-decorrelation and echo state learning. *Neural Networks* 20, 353–364.
- Stieg, A.Z., Avizienis, A.V., Sillin, H.O., Aguilera, R., Shieh, H.H., Martin-Olmos, C., Sandouk, E.J., Aono, M., Gimzewski, J.K., 2014. Self-organization and emergence of dynamical structures in neuromorphic atomic switch networks, in: *Memristor Networks*. Springer, pp. 173–209.
- Stieg, A.Z., Avizienis, A.V., Sillin, H.O., Martin-Olmos, C., Aono, M., Gimzewski, J.K., 2012. Emergent criticality in complex turing b-type atomic switch networks. *Advanced Materials* 24, 286–293.
- Strukov, D.B., Snider, G.S., Stewart, D.R., Williams, R.S., 2008. The missing memristor found. *nature* 453, 80.
- Sussillo, D., Abbott, L.F., 2009. Generating coherent patterns of activity from chaotic neural networks. *Neuron* 63, 544–557.
- Takahashi, H., Yasuda, S., Yada, Y., Kanzaki, R., 2016. Reservoir computing with dissociated neuronal culture. *Frontiers in Neuroscience* 27.
- Takeda, S., Nakano, D., Yamane, T., Tanaka, G., Nakane, R., Hirose, A., Nakagawa, S., 2016. Photonic reservoir computing based on laser dynamics with external feedback, in: *International Conference on Neural Information Processing, Springer*. pp. 222–230.
- Tanaka, G., Nakane, R., Yamane, T., Takeda, S., Nakano, D., Nakagawa, S., Hirose, A., 2017. Waveform classification by memristive reservoir computing, in: *International Conference on Neural Information Processing, Springer*. pp. 457–465.
- Thomas, A., 2013. Memristor-based neural networks. *Journal of Physics D: Applied Physics* 46, 093001.
- Toledo-Suárez, C., Duarte, R., Morrison, A., 2014. Liquid computing on and off the edge of chaos with a striatal microcircuit. *Frontiers in computational neuroscience* 8, 130.
- Torrejon, J., Riou, M., Araujo, F.A., Tsunegi, S., Khalsa, G., Querlioz, D., Borlototti, P., Cros, V., Yakushiji, K., Fukushima, A., et al., 2017. Neuromorphic computing with nanoscale spintronic oscillators. *Nature* 547, 428.

- Tran, S.D., Teuscher, C., 2017. Memcapacitive reservoir computing, in: 2017 IEEE/ACM International Symposium on Nanoscale Architectures (NANOARCH), IEEE. pp. 115–116.
- Urbain, G., Degrave, J., Carette, B., Dambre, J., Wyffels, F., 2017. Morphological properties of mass-spring networks for optimal locomotion learning. *Frontiers in neurorobotics* 11, 16.
- Vaerenbergh, T.V., Fiers, M., Dambre, J., Bienstman, P., 2015. Efficient simulation of optical nonlinear cavity circuits. *Optical and Quantum Electronics* 47, 1471–1476.
- Vandoorne, K., Dambre, J., Verstraeten, D., Schrauwen, B., Bienstman, P., 2011. Parallel Reservoir Computing Using Optical Amplifiers. *IEEE Transactions on Neural Networks* 22, 1469–1481.
- Vandoorne, K., Dierckx, W., Schrauwen, B., Verstraeten, D., Baets, R., Bienstman, P., Campenhout, J.V., 2008. Toward optical signal processing using Photonic Reservoir Computing. *Optics Express* 16, 11182–11192.
- Vandoorne, K., Mechet, P., Van Vaerenbergh, T., Fiers, M., Morthier, G., Verstraeten, D., Schrauwen, B., Dambre, J., Bienstman, P., 2014. Experimental demonstration of reservoir computing on a silicon photonics chip. *Nature communications* 5, 3541.
- Verstraeten, D., Schrauwen, B., dffHaene, M., Stroobandt, D., 2007. An experimental unification of reservoir computing methods. *Neural networks* 20, 391–403.
- Verstraeten, D., Schrauwen, B., Stroobandt, D., 2005a. Reservoir computing with stochastic bitstream neurons, in: *Proceedings of the 16th annual Prorisc workshop*, pp. 454–459.
- Verstraeten, D., Schrauwen, B., Stroobandt, D., Van Campenhout, J., 2005b. Isolated word recognition with the liquid state machine: a case study. *Information Processing Letters* 95, 521–528.
- Vincent-Lamarre, P., Lajoie, G., Thivierge, J.P., 2016. Driving reservoir models with oscillations: a solution to the extreme structural sensitivity of chaotic networks. *Journal of computational neuroscience* 41, 305–322.
- Vinckier, Q., Dupont, F., Smerieri, A., Vandoorne, K., Bienstman, P., Haelterman, M., Massar, S., 2015. High-performance photonic reservoir computer based on a coherently driven passive cavity. *Optica* 2, 438–446.
- Walter, F., Röhrbein, F., Knoll, A., 2015. Neuromorphic implementations of neurobiological learning algorithms for spiking neural networks. *Neural Networks* 72, 152–167.

- Wang, Q., Li, Y., Li, P., 2016. Liquid state machine based pattern recognition on fpga with firing-activity dependent power gating and approximate computing, in: Circuits and Systems (ISCAS), 2016 IEEE International Symposium on, IEEE. pp. 361–364.
- Wang, Q., Li, Y., Shao, B., Dey, S., Li, P., 2017. Energy efficient parallel neuro-morphic architectures with approximate arithmetic on fpga. *Neurocomputing* 221, 146–158.
- Werbos, P.J., 1990. Backpropagation through time: what it does and how to do it. *Proceedings of the IEEE* 78, 1550–1560.
- Williame, J., Accioly, A.D., Kim, J.V., 2017. Chaotic dynamics in a macroscale spin-torque nano-oscillator with time-delayed feedback. *arXiv preprint arXiv:1709.04310*.
- Williams, R.J., Zipser, D., 1989. A learning algorithm for continually running fully recurrent neural networks. *Neural computation* 1, 270–280.
- Williams, R.S., 2014. How we found the missing memristor, in: *Memristors and Memristive Systems*. Springer, pp. 3–16.
- Wojcik, G.M., Kaminski, W.A., 2007. Liquid state machine and its separation ability as function of electrical parameters of cell. *Neurocomputing* 70, 2593–2597.
- Wolf, S., Awschalom, D., Buhrman, R., Daughton, J., Von Molnar, S., Roukes, M., Chtchelkanova, A.Y., Treger, D., 2001. Spintronics: a spin-based electronics vision for the future. *Science* 294, 1488–1495.
- Wolfram, S., 2018. *Cellular automata and complexity: collected papers*. CRC Press.
- Wyffels, F., D’Haene, M., Waegeman, T., Caluwaerts, K., Nunes, C., Schrauwen, B., 2010. Realization of a passive compliant robot dog, in: *Biomedical Robotics and Biomechatronics (BioRob), 2010 3rd IEEE RAS and EMBS International Conference on, IEEE*. pp. 882–886.
- Yamane, T., Katayama, Y., Nakane, R., Tanaka, G., Nakano, D., 2015. Wave-based reservoir computing by synchronization of coupled oscillators, in: *International Conference on Neural Information Processing, Springer*. pp. 198–205.
- Yamazaki, T., Tanaka, S., 2007. The cerebellum as a liquid state machine. *Neural Networks* 20, 290–297.
- Yang, X., Chen, W., Wang, F.Z., 2016. Investigations of the staircase memristor model and applications of memristor-based local connections. *Analog Integrated Circuits and Signal Processing* 87, 263–273.

- Yi, Y., Liao, Y., Wang, B., Fu, X., Shen, F., Hou, H., Liu, L., 2016. Fpga based spike-time dependent encoder and reservoir design in neuromorphic computing processors. *Microprocessors and Microsystems* 46, 175–183.
- Yildiz, I.B., Jaeger, H., Kiebel, S.J., 2012. Re-visiting the echo state property. *Neural networks* 35, 1–9.
- Yilmaz, O., 2014. Reservoir computing using cellular automata. arXiv preprint arXiv:1410.0162 .
- Yilmaz, O., 2015a. Machine learning using cellular automata based feature expansion and reservoir computing. *Journal of Cellular Automata* 10.
- Yilmaz, O., 2015b. Symbolic computation using cellular automata-based hyper-dimensional computing. *Neural computation* 27, 2661–2692.
- Zhang, H., Feng, X., Li, B., Wang, Y., Cui, K., Liu, F., Dou, W., Huang, Y., 2014. Integrated photonic reservoir computing based on hierarchical time-multiplexing structure. *Optics Express* 22, 31356–31370.
- Zhang, Y., Li, P., Jin, Y., Choe, Y., 2015. A digital liquid state machine with biologically inspired learning and its application to speech recognition. *IEEE transactions on neural networks and learning systems* 26, 2635–2649.
- Zhao, C., Li, J., Liu, L., Koutha, L.S., Liu, J., Yi, Y., 2016. Novel spike based reservoir node design with high performance spike delay loop, in: *Proceedings of the 3rd ACM International Conference on Nanoscale Computing and Communication*, ACM. p. 14.
- Zhao, Q., Nakajima, K., Sumioka, H., Hauser, H., Pfeifer, R., 2013. Spine dynamics as a computational resource in spine-driven quadruped locomotion, in: *Intelligent Robots and Systems (IROS), 2013 IEEE/RSJ International Conference on*, IEEE. pp. 1445–1451.
- Zhao, Q., Yin, H., Zhu, H., 2018. Simultaneous recognition of two channels of optical packet headers utilizing reservoir computing subject to mutual-coupling optoelectronic feedback. *Optik* 157, 951–956.