

Paired many-to-many 2-disjoint path cover of balanced hypercubes with faulty edges

Huazhong Lü*

School of Mathematics Science,
University of Electronic Science and Technology of China,
Chengdu 610054, P.R. China

Abstract

As a variant of the well-known hypercube, the balanced hypercube BH_n was proposed as a novel interconnection network topology for parallel computing. It is known that BH_n is bipartite. Assume that $S = \{s_1, s_2\}$ and $T = \{t_1, t_2\}$ are any two sets of two vertices in different partite sets of BH_n ($n \geq 1$). It has been proved that there exist two vertex-disjoint s_1, t_1 -path and s_2, t_2 -path of BH_n covering all vertices of it. In this paper, we prove that there always exist two vertex-disjoint s_1, t_1 -path and s_2, t_2 -path covering all vertices of BH_n with at most $2n - 3$ faulty edges. The upper bound $2n - 3$ of edge faults tolerated is optimal.

Key words: Interconnection networks; Balanced hypercube; Fault-tolerant; Vertex-disjoint path cover;

1. Introduction

The interconnection network (network for short) plays a crucial role in massively parallel systems [14]. It is impossible to design a network which is optimum in all aspects of performance, accordingly, many networks have been proposed. Linear arrays and rings are two fundamental networks. Since some parallel applications

*E-mail address: lvhz08@lzu.edu.cn

such as those in image and signal processing are originally designated on an array architecture, it is important to have effective path embedding in a network.

In path embedding problems, to find parallel paths among vertices in networks is one of most central issues concerned with efficient data transmission [14]. Parallel paths in networks are usually studied with regard to disjoint paths in graphs. Since algorithms designed on linear arrays or rings can be efficiently simulated in a topology containing Hamiltonian paths or cycles, Hamiltonian path and cycle embedding property of graphs have been widely studied [2–4, 7, 9, 24, 27, 28].

In disjoint path cover problems, the many-to-many disjoint path cover problem is the most generalized one [21]. Assume that $S = \{s_1, s_2, \dots, s_k\}$ and $T = \{t_1, t_2, \dots, t_k\}$ are two sets of k sources and k sinks in a graph G , respectively, the *many-to-many k -disjoint path cover* (k -DPC for short) problem is to determine whether there exist k disjoint paths P_1, P_2, \dots, P_k in G such that P_i joins s_i to t_i for each $i \in \{1, 2, \dots, k\}$ and $V(P_1) \cup \dots \cup V(P_k) = V(G)$. Moreover, the DPC problem has a close relationship with Hamiltonian path problem in graphs. In fact, a one-to-one DPC of a network is indeed a Hamiltonian path between any two vertices.

Failure is inevitable when a massive system is put in use, so it is of great practical importance to consider the fault-tolerant capacity of a network. Hamiltonicity and k -DPC problems of various networks with faulty elements were investigated in literature, for example, k -ary n -cubes [4, 25], recursive circulants [13, 23], hypercubes [12, 22, 24] and hypercube-like graphs [6, 20].

The balanced hypercube, proposed by Wu and Huang [26], is one of the most popular networks. It has many excellent topological properties, such as high symmetry, low-latency, regularity, strong connectivity, etc. The special property of the balanced hypercube is that each processor has a backup processor that shares the same neighborhood. Thus tasks running on a faulty processor can be shifted to its backup processor [26]. With such novel properties above, different aspects of the balanced hypercube are studied extensively, including Hamiltonian embedding issues [5, 10, 15, 17, 27, 29, 32], connectivity issues [18, 31], matching preclusion and extendability [16, 19], and symmetric issues [33, 34] and some other topics [11, 30]. In this paper, we will consider the problem of paired 2-DPC of the balanced hypercube with faulty edges.

The rest of this paper is organized as follows. In Section 2, some definitions and notations are presented. The main result of this paper is shown in Section 3. Conclusions are given in Section 4.

2. Definitions and preliminaries

Throughout this paper, a network is represented by a simple undirected graph, where vertices represent processors and edges represent links between processors. Let $G = (V(G), E(G))$ be a graph, where $V(G)$ and $E(G)$ are its vertex-set and edge-set, respectively. The number of vertices of G is denoted by $|V(G)|$. The set of vertices adjacent to v is called *neighborhood* of v , denoted by $N_G(v)$. We will use $N(v)$ to replace $N_G(v)$ when the context is clear. A path P in G is a sequence of distinct vertices so that there is an edge joining consecutive vertices, and the length of P is the number of edges, denoted by $l(P)$. For simplicity, a path $P = \langle x_0, x_1, \dots, x_k \rangle$ can also be denoted by $\langle x_0, P, x_k \rangle$. A u, v -path is a path whose end vertices are u and v . If a path $C = \langle x_0, x_1, \dots, x_k \rangle$ is such that $k \geq 3$, $x_0 = x_k$, then C is said to be a *cycle*, and the length of C is the number of edges. The *distance* between two vertices u and v , denoted by $d(u, v)$, is the length of a shortest path of G joining u and v . A path (resp. cycle) containing all vertices of a graph G is called a *Hamiltonian path* (resp. *cycle*). A bipartite graph G is *bipartiteconnected* if, for two arbitrary nodes u and v of G with distance $d(u, v)$, there exists a path of length l between u and v for every integer l with $d(u, v) \leq l \leq |V(G)| - 1$ and $l \equiv d(u, v) \pmod{2}$. For other standard graph notations not defined here please refer to [1].

The definitions of the balanced hypercube are given as follows.

Definition 1. [26] An n -dimension balanced hypercube BH_n contains 4^n vertices $(a_0, \dots, a_{i-1}, a_i, a_{i+1}, \dots, a_{n-1})$, where $a_i \in \{0, 1, 2, 3\}$, $0 \leq i \leq n - 1$. Any vertex $v = (a_0, \dots, a_{i-1}, a_i, a_{i+1}, \dots, a_{n-1})$ in BH_n has the following $2n$ neighbors:

- (1). $((a_0 + 1) \bmod 4, a_1, \dots, a_{i-1}, a_i, a_{i+1}, \dots, a_{n-1})$,
 $((a_0 - 1) \bmod 4, a_1, \dots, a_{i-1}, a_i, a_{i+1}, \dots, a_{n-1})$, and
- (2). $((a_0 + 1) \bmod 4, a_1, \dots, a_{i-1}, (a_i + (-1)^{a_0}) \bmod 4, a_{i+1}, \dots, a_{n-1})$,
 $((a_0 - 1) \bmod 4, a_1, \dots, a_{i-1}, (a_i + (-1)^{a_0}) \bmod 4, a_{i+1}, \dots, a_{n-1})$.

The first coordinate a_0 of the vertex $(a_0, \dots, a_i, \dots, a_{n-1})$ in BH_n is defined as *inner index*, and other coordinates a_i ($1 \leq i \leq n - 1$) *outer index*.

The recursive structure of the balanced hypercube is presented in the following definition.

Definition 2. [26]

- (1). BH_1 is a 4-cycle, whose vertices are labelled by 0, 1, 2, 3 clockwise.
- (2). BH_{k+1} is constructed from 4 BH_k s, which are labelled by $BH_k^0, BH_k^1, BH_k^2, BH_k^3$. For any vertex in BH_k^i ($0 \leq i \leq 3$), its new labelling in BH_{k+1} is $(a_0, a_1, \dots, a_{k-1}, i)$, and it has two new neighbors:
 - a) $BH_k^{i+1} : ((a_0 + 1) \bmod 4, a_1, \dots, a_{k-1}, (i + 1) \bmod 4)$ and $((a_0 - 1) \bmod 4, a_1, \dots, a_{k-1}, (i + 1) \bmod 4)$ if a_0 is even.
 - b) $BH_k^{i-1} : ((a_0 + 1) \bmod 4, a_1, \dots, a_{k-1}, (i - 1) \bmod 4)$ and $((a_0 - 1) \bmod 4, a_1, \dots, a_{k-1}, (i - 1) \bmod 4)$ if a_0 is odd.

BH_1 is shown in Fig. 1 (a). One layout of BH_2 is shown in Fig. 1 (b) and the other layout of BH_2 is shown in Fig. 1 (c), which reveals a ring-like structure of BH_2 . Obviously, BH_2 can be also regarded as joining diagonal vertices of eight twisted 4-cycles end-to-end.

The following basic properties of the balanced hypercube will be applied in the main result of this paper.

Lemma 1 [26]. BH_n is bipartite.

By the above lemma, we give a bipartition V_0 and V_1 of BH_n , where $V_0 = \{(a_0, \dots, a_{n-1}) | (a_0, \dots, a_{n-1}) \in V(BH_n) \text{ and } a_0 \text{ is even}\}$ and $V_1 = \{(a_0, \dots, a_{n-1}) | (a_0, \dots, a_{n-1}) \in V(BH_n) \text{ and } a_0 \text{ is odd}\}$.

Lemma 2 [26, 32]. BH_n is vertex-transitive and edge-transitive.

Lemma 3 [26]. Vertices $u = (a_0, a_1, \dots, a_{n-1})$ and $v = ((a_0+2) \bmod 4, a_1, \dots, a_{n-1})$ in BH_n have the same neighborhood.

For convenience, let $p(u)$ be the vertex having the same neighborhood of u . It is obvious that u and $p(u)$ differ only from the inner index.

Assume that u is a neighbor of v in BH_n . If u and v differ only from the inner index, then uv is called a *0-dimension edge*, and u and v are mutually called *0-dimension neighbors*. Similarly, if u and v differ from j -th outer index ($1 \leq j \leq n-1$), uv is called a *j -dimension edge*, and u and v are mutually called *j -dimension neighbors*. The set of all k -dimension edges of BH_n is denoted by E_k for each $k \in \{0, \dots, n-1\}$, and the subgraph of BH_n obtained by deleting E_{n-1} is written by B^i , where i $0 \leq i \leq 3$. Obviously, each of B^i is isomorphic to BH_{n-1} . Let

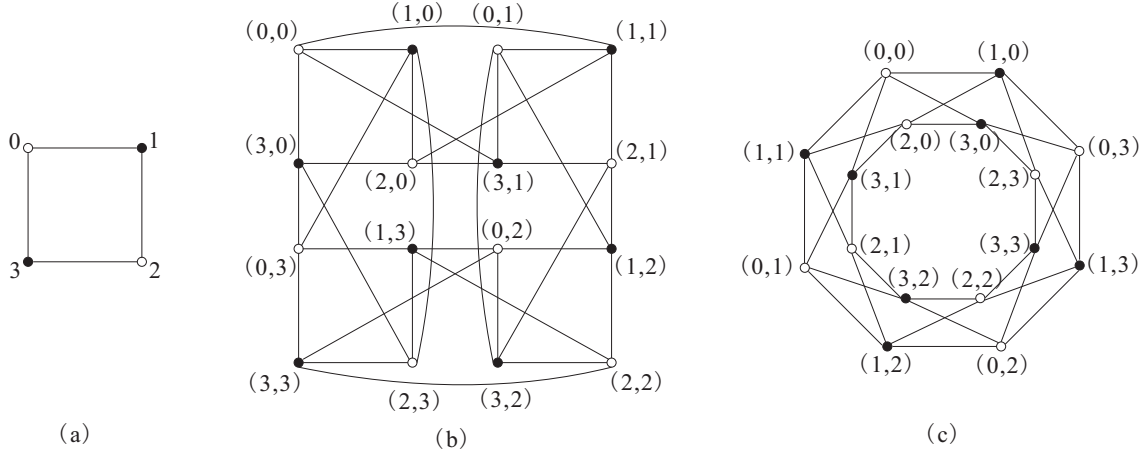

Fig. 1. BH_1 and BH_2 .

$u_i, v_i, w_i \in V_0$ (resp. $a_i, b_i, c_i \in V_1$) be vertices in B^i . For convenience, let $E_{i,i+1}$ be the edge set containing all edges between B^i and B^{i+1} ($0 \leq i \leq 3$), where “+” is under modulo four. For any vertex v of BH_n , let $e(v)$ be the set of edges incident to v . In particular, the two k -dimension edges incident to v is denoted by $e_k(v)$, where $0 \leq k \leq n - 1$. Let F be a set of edges in BH_n , we denote $F^i = F \cap E(B^i)$.

Let P and Q be two 2-paths with central vertices u and v , respectively. A *tenon chain* $T_m(x; y)$ from u to v is defined to be an m ($m \geq 1$) twisted 4-cycle chain with P and Q joining to its two ends, respectively. Additionally, let P' and Q' be two 2-paths with central vertices x and y , respectively. P' and Q' are joined to two ends of $T_m(x; y)$ the same way as P and Q do, we denote the graph obtained above by $T_m(u, x; v, y)$. In other words, $T_m(u, x; v, y)$ is an $m+2$ ($m \geq 1$) twisted 4-cycles chain with u and x being degree 2 vertices at one end and v and y being degree 2 vertices at the other end. By above, if $1 \leq m \leq 6$, $T_m(u; v)$ and $T_m(u, x; v, y)$ are both subgraphs of BH_2 . For convenience, we refer $T_m(u; v)$ and $T_m(u, x; v, y)$ ($1 \leq m \leq 6$) to the subgraph of BH_2 (ring-like layout) from u to v clockwise. $T_3((1, 0), (0, 1))$ and $T_3((1, 0), (3, 0); (0, 1), (2, 1))$ are illustrated as heavy lines in Figs. 2 (a) and 2 (b), respectively. Note that if u and v are in different partite sets of BH_2 then m is odd, otherwise, m is even.

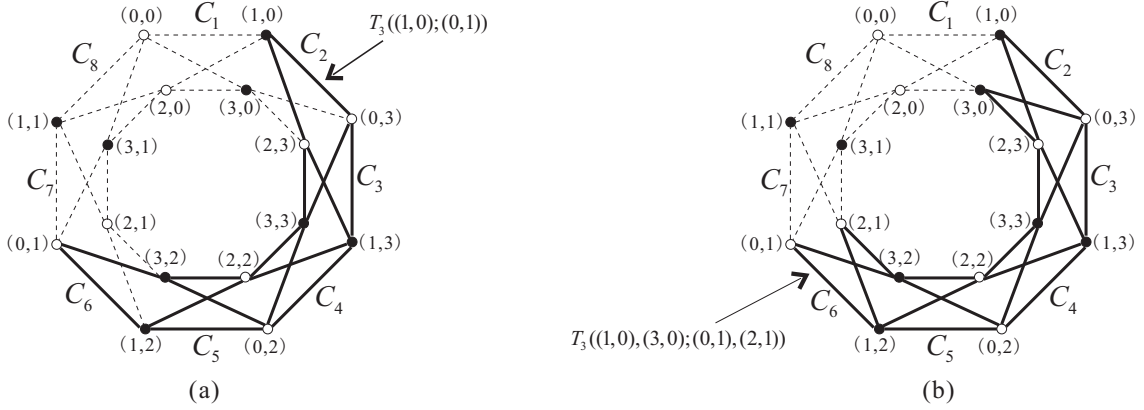

Fig. 2. $T((1, 0); (0, 1))$ and $T((1, 0), (3, 0); (0, 1), (3, 1))$.

3. Paired two-disjoint path cover of the balanced hypercube

Firstly, we will give some statements, which will be used later.

Lemma 4 [30]. Let u be an arbitrary vertex of BH_n for $n \geq 1$. Then, for an arbitrary vertex v of BH_n , either u and v have 0, 2, or $2n$ common neighbors. Furthermore, there is exactly one vertex w such that u and w have $2n$ common neighbors.

Lemma 5 [29]. The balanced hypercube BH_n is bipanconnected for all $n \geq 1$.

Lemma 6 [31]. Assume that $n \geq 2$. There exist 4^{n-1} edges between B^i and B^{i+1} for each $0 \leq i \leq 3$.

Lemma 7 [27]. Let uv be an edge of BH_n . Then uv is contained in a cycle C of length 8 in BH_n such that $|E(C) \cap E(B^i)| = 1$ for each $i = 0, 1, 2, 3$.

Lemma 8 [5]. Let $u, x \in V_0$ and $v, y \in V_1$. Then there exist two vertex-disjoint paths P and Q such that: (1) P connects u to v , (2) Q connects x to y , (3) $V(P) \cup V(Q) = V(BH_n)$.

Lemma 9 [32]. Let F be a set of faulty edges of BH_n with $|F| \leq 2n - 2$ for $n \geq 2$ and let x and y be two vertices in different partite sets of BH_n . Then there exists a Hamiltonian path of $BH_n - F$ from x to y .

Lemma 10. Given $T_m(x, y)$ with m being odd. If f is an arbitrary edge of $T_m(x, y)$, then there exists a Hamiltonian path of $T_m(x, y) - f$ from x to y .

Proof. Since m is odd, x and y are in different partite sets. Either f is an edge incident to x or y , or f is an edge of any twisted 4-cycle, it is easy to obtain a Hamiltonian path of $T_m(x, y)$ avoiding f . The lemma holds. \square

It follows from Lemma 10 that there exists a Hamiltonian path of $T_m(x, y)$ from x to y when at most one edge fault occurs, so we also use $T_m(x, y)$ to denote a fault-free Hamiltonian path of $T_m(x, y)$ from x to y when there is no ambiguity.

Lemma 11. Given $T_m(u, x; v, y)$ with m being odd. Let e and f be two edges of $T_m(u, x; v, y)$ such that e and f are not contained in the same twisted 4-cycle, then there exist vertex-disjoint u, v -path and x, y -path of $T_m(u, x; v, y) - \{e, f\}$ that cover all vertices of it.

Proof. Since m is odd, u and x are in one partite set, and v and y are in the other partite set of $T_m(u, x; v, y)$. To obtain the desired u, v -path and x, y -path, one has to go through all twisted 4-cycles of $T_m(u, x; v, y)$ and never go back. Accordingly, u, v -path and x, y -path contain the same number of vertices. Fault-free u, v -path and x, y -path of $T_m(u, x; v, y) - \{e, f\}$ can be constructed according to the following two rules:

(1) If e (or f) is incident to one of u, x, v and y , say u , we then choose the other edge incident to u in u, v -path.

(2) If $e = ab$ (or $f = ab$) is contained in a twisted 4-cycle $C = \langle a, b, c, d, a \rangle$, then ad (resp. bc) must be contained in exact one of u, v -path and x, y -path.

Hence, the lemma holds. \square

Lemma 12. Let $\{s_1, s_2\}$ and $\{t_1, t_2\}$ be two sets of vertices in different partite sets of BH_2 and let $F = \{e, f\}$ be a set of edges of BH_2 with $e \in E_0$ and $f \in E_1$. Then there exist vertex-disjoint s_1, t_1 -path and s_2, t_2 -path of $BH_2 - F$ that cover all vertices of it unless there exists a common neighbor of s_1 and s_2 (or t_1 and t_2), say x , such that $F = e(x) \setminus \{s_1x, s_2x\}$ (or $F = e(x) \setminus \{t_1x, t_2x\}$).

Proof. Suppose without loss of generality that x is a common neighbor of s_1 and s_2 , if $F = e(x) \setminus \{s_1x, s_2x\}$, that is, $\{s_1x, s_2x\} \cap F = \emptyset$, which yields a 2-path starting from s_1 to s_2 . Accordingly, it is impossible to obtain vertex-disjoint s_1, t_1 -path and s_2, t_2 -path that cover all vertices of BH_2 . If $d(s_1, s_2) = 2$, $F \neq e(x) \setminus \{s_1x, s_2x\}$ is

a necessary condition to guarantee that there exist vertex-disjoint s_1, t_1 -path and s_2, t_2 -path of $BH_2 - F$.

On the other hand, noting $e \in E_0$ and $f \in E_1$, each twisted 4-cycle of BH_2 (ring-like layout) contains at most one of them. By vertex-transitivity of BH_2 , we may assume that $s_1 = (0, 0)$. According to all possible relative positions of s_1, s_2, t_1 and t_2 in BH_2 , there are 16 essential different distributions to be considered. In each case, we have verified that there always exist vertex-disjoint s_1, t_1 -path and s_2, t_2 -path of $BH_2 - F$ that covers all vertices of BH_2 (by making use of Lemmas 10 and 11 to reduce the number of cases to be considered). Since the proof is tedious and rather long, we only list all different distributions of s_1, s_2, t_1 and t_2 in BH_2 in the following:

- (1) $s_2 = (2, 0), t_1 = (1, 0), t_2 = (3, 0)$;
- (2) $s_2 = (2, 0), t_1 = (1, 0), t_2 = (3, 3)$ (or $s_2 = (2, 1), t_1 = (1, 0), t_2 = (3, 0)$ or $s_2 = (2, 0), t_1 = (3, 3), t_2 = (3, 0)$ or $s_2 = (2, 3), t_1 = (3, 3), t_2 = (1, 3)$);
- (3) $s_2 = (2, 0), t_1 = (1, 0), t_2 = (3, 0)$ (or $s_2 = (2, 2), t_1 = (1, 0), t_2 = (3, 0)$ or $s_2 = (2, 0), t_1 = (3, 3), t_2 = (3, 1)$ or $s_2 = (2, 2), t_1 = (3, 3), t_2 = (1, 3)$);
- (4) $s_2 = (2, 0), t_1 = (1, 0), t_2 = (3, 1)$ (or $s_2 = (2, 3), t_1 = (1, 0), t_2 = (3, 0)$);
- (5) $s_2 = (2, 3), t_1 = (1, 0), t_2 = (3, 3)$ (or $s_2 = (2, 1), t_1 = (1, 0), t_2 = (3, 1)$);
- (6) $s_2 = (2, 3), t_1 = (1, 0), t_2 = (3, 2)$ (or $s_2 = (2, 2), t_1 = (1, 0), t_2 = (3, 1)$ or $s_2 = (2, 2), t_1 = (3, 3), t_2 = (3, 2)$ or $s_2 = (2, 1), t_1 = (3, 3), t_2 = (3, 1)$);
- (7) $s_2 = (2, 3), t_1 = (1, 0), t_2 = (3, 1)$ (or $s_2 = (2, 3), t_1 = (3, 3), t_2 = (3, 0)$);
- (8) $s_2 = (2, 2), t_1 = (1, 0), t_2 = (3, 3)$ (or $s_2 = (2, 1), t_1 = (1, 0), t_2 = (3, 2)$);
- (9) $s_2 = (2, 2), t_1 = (1, 0), t_2 = (3, 2)$;
- (10) $s_2 = (2, 1), t_1 = (1, 0), t_2 = (3, 3)$ (or $s_2 = (2, 1), t_1 = (3, 3), t_2 = (3, 2)$);
- (11) $s_2 = (2, 0), t_1 = (1, 3), t_2 = (3, 3)$;
- (12) $s_2 = (2, 0), t_1 = (1, 3), t_2 = (3, 2)$ (or $s_2 = (2, 1), t_1 = (1, 3), t_2 = (3, 2)$);
- (13) $s_2 = (2, 3), t_1 = (1, 3), t_2 = (3, 2)$ (or $s_2 = (2, 1), t_1 = (1, 3), t_2 = (3, 0)$);
- (14) $s_2 = (2, 3), t_1 = (1, 3), t_2 = (3, 2)$ (or $s_2 = (2, 3), t_1 = (1, 3), t_2 = (3, 1)$);
- (15) $s_2 = (2, 2), t_1 = (1, 3), t_2 = (3, 1)$. □

The following corollary is straightforward.

Corollary 13. Let $\{s_1, s_2\}$ and $\{t_1, t_2\}$ be any two sets of vertices in different partite sets of BH_2 and let e be any edge of BH_2 . Then there exist vertex-disjoint s_1, t_1 -path and s_2, t_2 -path of $BH_2 - e$ that covers all vertices of it.

Remark. Our aim is to guarantee that there exists a dimension $d \in \{0, 1, 2\}$ such that by dividing BH_3 into B^i along dimension d we can use Lemmas 12 and 13 as

the induction basis of the main result. Let $F = \{f_0, f_1, f_2\}$ be a set of three edges of BH_3 and let $\{s_1, s_2\}$ and $\{t_1, t_2\}$ be any two sets of vertices in different partite sets of BH_3 . If there exists a dimension $d \in \{0, 1, 2\}$ such that $|E_d \cap F| \geq 2$, then BH_3 can be divided into B^i ($0 \leq i \leq 3$) along dimension d . Thus, $|E(B^i) \cap F| \leq 1$ for each $i \in \{0, 1, 2, 3\}$. So we assume that $E_j \cap F = \{f_i\}$ for each $j = 0, 1, 2$. By Lemma 4, s_1 and s_2 (or t_1 and t_2) have 0, 2 or $2n$ common neighbors.

If s_1 and s_2 (or t_1 and t_2) have no common neighbors, then we can safely divide BH_3 into B^i ($0 \leq i \leq 3$) along each dimension $d \in \{0, 1, 2\}$.

If s_1 and s_2 (or t_1 and t_2) have at least 2 common neighbors, we may assume that x is one of the common neighbors of s_1 and s_2 . If we divide BH_3 into B^i ($0 \leq i \leq 3$) along some dimension $d \in \{0, 1, 2\}$ such that s_1, s_2, t_1 and t_2 are in the same B^i , say B^0 , and $F = F'$, where F' is the set of edges incident to x in B^0 (except s_1x and s_2x). Furthermore, if s_1 and s_2 (or t_1 and t_2) have exact 2 common neighbors, then s_1x and s_2x are edges of different dimensions, then we can choose a dimension $d' \in \{0, 1, 2\} \setminus \{d\}$ such that by dividing BH_3 into B^i ($0 \leq i \leq 3$) along dimension d' , s_1 and s_2 (or t_1 and t_2) are not in the same B^i . If s_1 and s_2 have 6 common neighbors, then s_1x and s_2x are edges of the same dimension, so we can divide BH_3 into B^i ($0 \leq i \leq 3$) along the dimension of the edges in F' . \square

Lemma 14. Let F be a set of edges of BH_n ($n \geq 3$) with $|F| = 2n - 3$. Given a dimension k of BH_n such that $|E_k \cap F| = \max\{|E_j \cap F| \mid 0 \leq j \leq n - 1\}$. Let B^i , $0 \leq i \leq 3$, be subgraphs of BH_n obtained by splitting BH_n along dimension k . Then there exists four vertices $a, c \in V_0$ and $b, d \in V_1$ of B^i such that:

- (1) $a = p(c)$, $b = p(d)$, and a, b, c and d form a 4-cycle in B^i ;
- (2) there exists a k -dimension neighbor a_{i+1} of a and c such that $e_k(a_{i+1}) \cap F = \emptyset$;
- (3) there exist two k -dimension neighbors u_{i-1} and v_{i-1} of b and d such that $e_k(b) \cap F = \emptyset$, $|e_k(d) \cap F| < 2$ and $cd \notin F$;
- (4) there exists a neighbor u of b and d in B^i such that $|e_{j_1}(u) \cap F| < 2$ for each $j_1 \in \{0, 1, \dots, n - 1\}$;
- (5) there exists a longest path P from u to a covering all vertices of $B^i - F$ but b, c and d .

Proof. We proceed the proof by induction on n . By the choice of k , we have $|E_k \cap F| = 1$ or $|E_k \cap F| \geq 2$ when $n = 3$. It is easy to verify that conditions (1)-(5) hold after splitting BH_3 by dimension k . Thus, the induction basis holds. So we assume that the lemma is true for all integers m with $3 \leq m \leq n - 1$. Next we consider BH_n .

Note that $|E_k \cap F| \geq 2$ whenever $n \geq 4$, suppose without loss of generality that $i = 3$ and $k = n - 1$. Since $|E_{n-1} \cap F| \geq 2$, $|F \cap E(B^i)| \leq 2n - 5$, $0 \leq i \leq 3$. For each pair of vertices $u_0, u'_0 \in V_0$ with $u_0 = p(u'_0)$ in B^0 , there exist $2n - 2$ common neighbors of them in B^0 . Let a_0 and a'_0 be any two neighbors of u_0 and u'_0 with $a_0 = p(a'_0)$ in B^0 . In addition, let u_3 and u'_3 be two $(n - 1)$ -dimension neighbors of a_0 and a'_0 and let a_3, a'_3 be two k_1 -dimension neighbors of u_3 and u'_3 of B^3 for a given $k_1 \in \{0, 1, \dots, n - 2\}$. Accordingly, let u_2 and u'_2 be two $(n - 1)$ -dimension neighbors of a_3 and a'_3 and let a_2 and a'_2 be two k_1 -dimension neighbors of u_2 and u'_2 in B^2 . Thus, the subgraph induced by $\{a_0, a'_0, u_3, u'_3, a_3, a'_3, u_2, u'_2, a_2, a'_2\}$ is a twisted 4-cycle chain. If there exist at least two edges of F in one of $\langle a'_0, u_3, a_0, u'_3, a'_0 \rangle$, $\langle a'_3, u_2, a_3, u'_2, a'_3 \rangle$ and $\langle a'_2, u_2, a_2, u'_2, a'_2 \rangle$, then it may eliminate the choice of a_3, a'_3, u_3 and u'_3 as a, b, c and d to satisfy conditions (1),(2) and (3) (see Fig. 3). By arbitrary choice of a_0 and a'_0 , if there exist no such a, b, c and d satisfying conditions (1),(2) and (3) for given u_0 and u'_0 , we have $|F| = 2 \times (n - 1) = 2n - 2 > 2n - 3$, a contradiction.

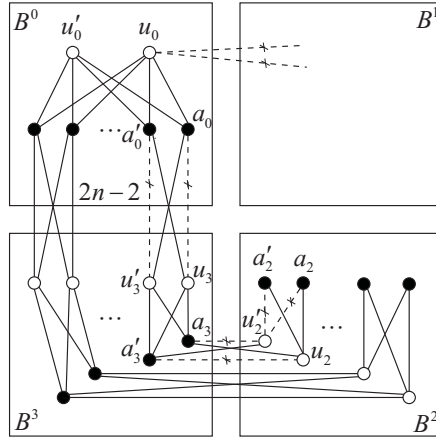

Fig. 3. Existence of a, b, c and d satisfying required conditions in Lemma 14.

On the other hand, b and d have $2n - 2$ common neighbors (except a and c) in B^3 . Since $2 \times (2n - 2) > 2 \times (2n - 4) > 2n - 3$ whenever $n \geq 4$, there must exist a common neighbor u of b and d satisfying condition (4). It remains to show that condition (5) holds.

By our assumption, $u, a, b, c, d \in V(B^3)$. Note that we have $|E(B^3) \cap F| \leq 2n - 5$, our aim is to show that there exists a longest path P from u to a covering all vertices of $B^3 - F$ but b, c and d . Let $k_2 \in \{0, 1, \dots, n - 2\}$ such that $|E_{k_2} \cap E(B^3) \cap F| \geq$

$|E_j \cap E(B^3) \cap F|$ for each $j \in \{0, 1, \dots, n-2\} \setminus \{k_2\}$. We further divide each B^i into $B_{n-2}^{i_1, i}$, $0 \leq i_1 \leq 3$, along dimension k_2 . That is, $B_{n-2}^{i_1, i} \cong BH_{n-2}$ for each i_1 and i . Assume without loss of generality that $a, b, c, d \in V(B_{n-2}^{0,3})$. By Definition 1, the graph induced by $V(B_{n-2}^{0,0})$, $V(B_{n-2}^{0,1})$, $V(B_{n-2}^{0,2})$ and $V(B_{n-2}^{0,3})$ is isomorphic to BH_{n-1} , for convenience, we denote it by H . Since u is a neighbor of b and d in B^3 , we assume without loss of generality that $u \in V(B_{n-2}^{0,3})$.

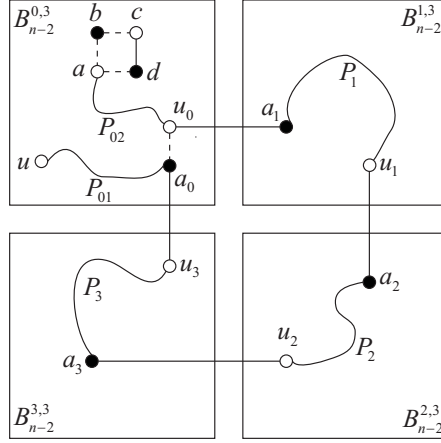

Fig. 4. Longest path from u to a covering all vertices of $B^3 - F$ but b, c and d .

By induction hypothesis, there exists a longest path P_0 from u to a covering all vertices of $B_{n-2}^{0,3} - F$ but b, c and d . Since $l(P_0) = 4^{n-2} - 4$ and $(4^{n-2} - 4)/2 > 2n - 3$ whenever $n \geq 4$ (any vertex v on P_0 with $|e_{k_2}(v) \cap F| = 2$ will eliminate the choice of two edges incident to v on P_0), we can choose an edge $u_0 a_0 \in E(P_0)$ such that there exist two edges $u_0 a_1, u_3 a_0 \notin F$, where $a_1 \in V(B_{n-2}^{1,3})$ and $u_3 \in V(B_{n-2}^{3,3})$. Deleting $u_0 a_0$ from P_0 will generate two vertex-disjoint paths P_{01} and P_{02} , where P_{01} connects u to a_0 and P_{02} connects u_0 to a . Let $u_1 a_2$ and $u_2 a_3$ be two fault-free k_2 -dimension edges. By Lemma 9, there exist a fault-free Hamiltonian path P_1 of $B_{n-2}^{1,3}$ from u_1 to a_1 , a fault-free Hamiltonian path P_2 of $B_{n-2}^{2,3}$ from u_2 to a_2 , and a fault-free Hamiltonian path P_3 of $B_{n-2}^{3,3}$ from u_3 to a_3 . Hence, $\langle u, P_{01}, a_0, u_3, P_3, a_3, u_2, P_2, a_2, u_1, P_1, a_1, u_0, P_{02}, a \rangle$ is the path required (see Fig. 4).

This completes the proof. \square

Lemma 15. Let $F = \{e, f\}$ be any two edges of BH_2 with $e \in E_0$ and $f \in E_1$. In addition, let $t_1, t_2 \in V_1$ be two arbitrary vertices. Then there exist two pairs of vertices in V_0 differing only from inner index respectively, suppose without loss of generality that a and c is such a pair with $a = p(c)$, such that: (1) there exists a

vertex $u \in V_0$ of BH_2 with $u \neq a, c$; (2) there exist two vertex-disjoint paths P and Q of $BH_2 - F$ cover all vertices of it, where P connects u to t_2 , and Q connects c to t_1 and $\langle c, b, a \rangle$ is a subpath of Q .

Proof. By vertex-transitivity of BH_2 , we may assume that $t_1 = (1, 0)$. Since $e \in E_0$ and $f \in E_1$, e and f lie in different twisted 4-cycles of BH_2 . Our aim is to find two pairs of vertices differing only from inner index respectively and satisfying conditions (1) and (2). There are three essentially different positions of t_2 .

Case 1. $t_2 = (3, 0)$. We further deal with the following cases.

Case 1.1. e and f lie in consecutive twisted 4-cycles.

Case 1.1.1. e and f are nonadjacent. We may assume that $e = (0, 0)(1, 0)$ and $f = (2, 0)(3, 1)$. If $a = (2, 0)$, $c = (0, 0)$ and $u = (2, 1)$, then $P^{-1} = \langle T_3((3, 0); (0, 1)), (3, 1), (2, 1) \rangle$ and $Q = \langle (0, 0), (1, 1), (2, 0), (1, 0) \rangle$ are the paths required.

If $a = (0, 1)$, $c = (2, 1)$ and $u = (2, 2)$, then $P = \langle (2, 2), (3, 2), (0, 2), (1, 3), (0, 3), (3, 3), (2, 3), (3, 0) \rangle$ and $Q = \langle (2, 1), (1, 2), (0, 1), (3, 1), (0, 0), (1, 1), (2, 0), (1, 0) \rangle$ are the paths required.

Case 1.1.2. e and f are adjacent. There are two essential relative positions of e and f , we further deal with the following cases.

Case 1.1.2.1. $e = (0, 0)(1, 0)$ and $f = (0, 0)(1, 1)$. The proof is similar to that of Case 1.1.1, we omit it.

Case 1.1.2.2. $e = (0, 0)(1, 1)$ and $f = (1, 1)(0, 1)$. If $a = (2, 1)$, $c = (0, 1)$ and $u = (2, 2)$, then $P = \langle (2, 2), (3, 2), (0, 2), (1, 3), (0, 3), (3, 3), (2, 3), (3, 0) \rangle$ and $Q = \langle (0, 1), (1, 2), (2, 1), (1, 1), (2, 0), (3, 1), (0, 0), (1, 0) \rangle$ are the paths required.

If $a = (0, 2)$, $c = (2, 2)$ and $u = (2, 3)$, then $P = \langle (2, 3), (1, 3), (0, 3), (1, 0) \rangle$ and $Q = \langle (2, 2), (3, 3), (0, 2), (1, 2), (0, 1), (3, 2), (2, 1), (1, 1), (2, 0), (3, 1), (0, 0), (1, 0) \rangle$ are the paths required.

Case 1.2. e and f lie in inconsecutive twisted 4-cycles. Obviously, BH_2 can be decomposed into four edge-disjoint 8-cycles according to ring-like layout. By Lemma 11, each pair of vertices in V_0 differing only from the inner index can be chosen as a and c such that there exist two vertex-disjoint paths P and Q of $BH_2 - F$ cover all vertices of it, where P connects u to t_2 , and Q connects c to t_1 and $\langle c, b, a \rangle$ is a subpath of Q .

Case 2. $t_2 = (3, 3)$. We further deal with the following cases.

Case 2.1. $|F \cap T_0(t_1, (3, 0); (1, 3), t_2)| = 2$. By Lemma 11, there exist two edge-disjoint 2-paths P_1 and Q_1 cover all vertices of $T_0(t_1, (3, 0); (1, 3), t_2)$, where P_1 con-

nects $(3,0)$ to t_2 and Q_1 connects $(1,3)$ to t_1 . There are two pairs of vertices can be chosen as a and c : (1) $a = (0, 2)$ and $c = (2, 2)$; (2) $a = (0, 1)$ and $c = (2, 1)$.

If $a = (0, 2)$ and $c = (2, 2)$, let $u = (2, 1)$, then $P = \langle (2, 1), (1, 2), (0, 1), (3, 1), (0, 0), (1, 1), (2, 0), (3, 0), P_1, (3, 3) \rangle$ and $Q = \langle (2, 2), (3, 2), (0, 2), (1, 3), Q_1, (1, 0) \rangle$ are the paths required.

If $a = (0, 1)$ and $c = (2, 1)$, let $u = (2, 0)$, then $P = \langle (2, 0), (3, 1), (0, 0), (3, 0), P_1, (3, 3) \rangle$ and $Q = \langle (2, 1), (1, 1), (0, 1), (1, 2), (0, 2), (3, 2), (2, 2), (1, 3), Q_1, (1, 0) \rangle$ are the paths required.

Case 2.2. $|F \cap T_0(t_1, (3, 0); (1, 3), t_2)| = 1$ or $|F \cap T_0(t_1, (3, 0); (1, 3), t_2)| = 0$. The proof is similar to that of Case 2.1, we omit it.

Case 3. $t_2 = (3, 2)$. The proof is similar to that of Case 2, we omit it. \square

By above lemma, it is not hard to obtain the following corollary.

Corollary 16. Let e be an edge of BH_2 . In addition, let $t_1, t_2 \in V_1$ be two arbitrary vertices of BH_2 . Then there exist at least two pairs of vertices in V_0 differing only from inner index respectively, suppose without loss of generality that a and c is such a pair with $a = p(c)$, such that: (1) there exists a vertex $u \in V_0$ of BH_2 with $u \neq a, c$; (2) there exist two vertex-disjoint paths P and Q of $BH_2 - e$ cover all vertices of it, where P connects u to t_2 , and Q connects c to t_1 and $\langle c, b, a \rangle$ is a subpath of Q .

Lemma 17. Let F be a set of edges of BH_n with $|F| = 2n - 3$ ($n \geq 3$). Given a dimension k of BH_n such that $|E_k \cap F| \geq |E_j \cap F|$ for each $j \in \{0, 1, \dots, n-1\} \setminus \{k\}$. Let B^i , $0 \leq i \leq 3$, be subgraphs of BH_n obtained by splitting BH_n along dimension k . In addition, let $t_1, t_2 \in V_1$ be two arbitrary vertices in B^i such that $t_1 \neq t_2$. Then, there exist four vertices $u, a, c \in V_0$ and $b \in V_1$ of B^i with $a = p(c)$ such that:

(1) there exists a k -dimension neighbor a_{i+1} of a and c such that $e_k(a_{i+1}) \cap F = \emptyset$ and there exists a k -dimension neighbor u_{i-1} of b such that $|e_k(b) \cap F| < 2$, where b ($b \neq t_1, t_2$) is a common neighbor of a and c ;

(2) for each $j_1 \in \{0, 1, \dots, n-1\}$, $|e_{j_1}(u) \cap F| < 2$;

(3) there exist two vertex-disjoint paths P and Q of $B^i - F$ cover all vertices of it, where P connects u to t_2 , and Q connects c to t_1 and $\langle c, b, a \rangle$ is a subpath of Q .

Proof. We proceed the proof by induction on n . Firstly, we shall show that the lemma is true when $n = 3$. Suppose without loss of generality that $i = 3$ and $k = 2$, that is, $t_1, t_2 \in V(B^3)$. Since $|E_2 \cap F| \geq 1$, $|F \cap E(B^i)| \leq 2$ for $0 \leq i \leq 3$. If $|E_2 \cap F| = 1$, then it follows from Lemma 15 that the lemma is true. If $|E_2 \cap F| \geq 2$, it follow from Lemma 16 that the lemma is also true. Thus, the induction basis

holds. So we assume that the lemma is true for all integers m with $3 \leq m \leq n - 1$. Next we consider BH_n .

Obviously, we have $|E_k \cap F| \geq 2$ whenever $n \geq 4$. We may assume that $i = 3$ and $k = n - 1$. So we obtain four subgraphs B^i , $0 \leq i \leq 3$, by splitting BH_n along dimension $n - 1$. Accordingly, by our assumption, $t_1, t_2 \in V(B^3)$. Thus, we have $|E(B^3) \cap F| \leq 2n - 5$. Our aim is to show that there exist four vertices $u, a, c \in V_0$ and $b \in V_1$ of B^3 with $a = p(c)$ satisfying conditions (1)-(3). Let $k_1 \in \{0, 1, \dots, n - 2\}$ such that $|E_{k_1} \cap E(B^3) \cap F| \geq |E_j \cap E(B^3) \cap F|$ for each $j \in \{0, 1, \dots, n - 2\} \setminus \{k_1\}$. We further divide each B^i into $B_{n-2}^{i_1, i}$, $0 \leq i_1 \leq 3$, along dimension k_1 . That is, $B_{n-2}^{i_1, i} \cong BH_{n-2}$ for each i_1 and i . Assume without loss of generality that $t_1 \in V(B_{n-2}^{0,3})$. By Definition 1, the graph induced by $V(B_{n-2}^{0,0})$, $V(B_{n-2}^{0,1})$, $V(B_{n-2}^{0,2})$ and $V(B_{n-2}^{0,3})$ is isomorphic to BH_{n-1} , for convenience, we denote it by H . There are four relative positions of t_2 in B^3 , so we consider the following conditions.

If $t_2 \in V(B_{n-2}^{0,3})$. By induction hypothesis, there exist four vertices $u, a, c \in V_0$ and $b \in V_1$ of $B_{n-2}^{0,3}$ with $a = p(c)$ satisfying conditions (1),(2) in H . Moreover, there exist two vertex-disjoint paths P_0 and Q of $B_{n-2}^{0,3} - F$ cover all vertices of it, where P_0 connects u to t_2 , and Q connects c to t_1 and $\langle c, b, a \rangle$ is a subpath of Q . Since $l(P_0) + l(Q) = 4^{n-2} - 2$, it is obvious that there exists an edge on P_0 or Q , say $u_0a_0 \in E(P_0)$, such that $u_0a_1, u_3a_0 \notin F$, where u_0a_1 and u_3a_0 are k_1 -dimension edges. Thus, deleting u_0a_0 from P_0 will generate two vertex-disjoint paths P_{01} and P_{02} , where P_{01} connects u to a_0 and P_{02} connects u_0 to t_2 . By Lemma 6, there must exist two k_1 -dimension fault-free edges u_1a_2 and u_2a_3 , where $u_1 \in V(B_{n-2}^{1,3})$, $u_2, a_2 \in V(B_{n-2}^{2,3})$ and $a_3 \in V(B_{n-2}^{3,3})$. By Lemma 9, there exist a fault-free Hamiltonian path P_1 of $B_{n-2}^{1,3} - F$ from u_1 to a_1 , a fault-free Hamiltonian path P_2 of $B_{n-2}^{2,3} - F$ from u_2 to a_2 , and a fault-free Hamiltonian path P_3 of $B_{n-2}^{3,3} - F$ from u_3 to a_3 . Hence, $P = \langle u, P_{01}, a_0, u_3, P_3, a_3, u_2, P_2, a_2, u_1, P_1, a_1, u_0, P_{02}, t_2 \rangle$ and Q are paths satisfying condition (3) in BH_n .

If $t_2 \in V(B_{n-2}^{1,3})$. Obviously, there exists a vertex $u \in V(B_{n-2}^{1,3})$ such that $|e_{j_1}(u) \cap F| < 2$ for each $j_1 \in \{0, 1, \dots, n - 1\}$. By Lemma 9, there exists a fault-free Hamiltonian path P_1 of $B_{n-2}^{1,3} - F$ from u to t_2 . Since $l(P_1) = 4^{n-2} - 1$, there must exist an edge $u_1a_1 \in E(P_1)$ such that $|e_{k_1}(u_1) \cap F| < 2$ and $|e_{k_1}(a_1) \cap F| < 2$. So let u_1a_2 and $u'a_1$ be two fault-free k_1 -dimension edges. Additionally, deleting u_1a_1 from P_1 will generate two vertex-disjoint paths P_{11} and P_{12} , where P_{11} connects u to a_1 and P_{12} connects u_1 to t_2 . By induction hypothesis, there exists four vertices

$a, c \in V_0$ and $a_0, b \in V_1$ of $B_{n-2}^{0,3}$ with $a = p(c)$ such that: a, b and c satisfy condition (1) and a_0 satisfies condition (2) in H . Moreover, there exist two vertex-disjoint paths P_0 and Q of $B_{n-2}^{0,3} - F$ cover all vertices of it, where P_0 connects u' to a_0 , and Q connects c to t_1 and $\langle c, b, a \rangle$ is a subpath of Q . Obviously, there exist two k_1 -dimension fault-free edges u_2a_3 and u_3a_0 , where $u_2 \in V(B_{n-2}^{2,3})$ and $u_3, a_3 \in V(B_{n-2}^{3,3})$. By Lemma 9, there exist a fault free Hamiltonian path P_2 of $B_{n-2}^{2,3} - F$ from u_2 to a_2 , and a fault free Hamiltonian path P_3 of $B_{n-2}^{3,3} - F$ from u_3 to a_3 . Hence, $P = \langle u, P_{11}, a_1, u', P_0, a_0, u_3, P_3, a_3, u_2, P_2, a_2, u_1, P_{12}, t_2 \rangle$ and Q are paths satisfying condition (3) in BH_n .

If $t_2 \in V(B_{n-2}^{2,3})$. Obviously, there exists a vertex $u \in V_0$ in $B_{n-2}^{2,3}$ such that $|e_{j_1}(u) \cap F| < 2$ for each $j_1 \in \{0, 1, \dots, n-1\}$. By Lemma 9, there exists a fault-free Hamiltonian path P_2 of $B_{n-2}^{2,3} - F$ from u to t_2 . Similarly, there must exist an edge $u_2a_2 \in E(P_2)$ such that $|e_{k_1}(u_2) \cap F| < 2$ and $|e_{k_1}(a_2) \cap F| < 2$. So let u_1a_2 and u_2a_3 be two fault-free k_1 -dimension edges. Additionally, deleting u_2a_2 from P_2 will generate two vertex-disjoint paths P_{21} and P_{22} , where P_{21} connects u to a_2 and P_{22} connects u_2 to t_2 . Let $a_0 \in V(B_{n-2}^{0,3})$ be a vertex such that $|e_{k_1}(a_0) \cap F| < 2$. By induction hypothesis, there exists four vertices $u_0, a, c \in V_0$ and $b \in V_1$ of $B_{n-2}^{0,3}$ with $a = p(c)$ such that: a, b and c satisfy condition (1) and u_0 satisfies condition (2) in H . Moreover, there exist two vertex-disjoint paths P_0 and Q of $B_{n-2}^{0,3} - F$ cover all vertices of it, where P_0 connects u_0 to a_0 , and Q connects c to t_1 and $\langle c, b, a \rangle$ is a subpath of Q . Obviously, there exist two fault-free k_1 -dimension edges u_0a_1 and u_3a_0 , where $u_3 \in V(B_{n-2}^{3,3})$ and $a_1 \in V(B_{n-2}^{1,3})$. By Lemma 9, there exist a fault-free Hamiltonian path P_1 of $B_{n-2}^{1,3} - F$ from u_1 to a_1 , and a fault free Hamiltonian path P_3 of $B_{n-2}^{3,3} - F$ from u_3 to a_3 . Hence, $P = \langle u, P_{21}, a_2, u_1, P_1, a_1, u_0, P_0, a_0, u_3, P_3, a_3, u_2, P_{22}, t_2 \rangle$ and Q are paths satisfying condition (3) in BH_n .

If $t_2 \in V(B_{n-2}^{3,3})$. Similarly, there exists a vertex $u \in V(B_{n-2}^{2,3})$ such that $|e_{j_1}(u) \cap F| < 2$ for each $j_1 \in \{0, 1, \dots, n-1\}$. Let $a_0 \in V(B_{n-2}^{0,3})$ be a vertex such that $|e_{k_1}(a_0) \cap F| < 2$. By induction hypothesis, there exists four vertices $u_0, a, c \in V_0$ and $b \in V_1$ of $B_{n-2}^{0,3}$ with $a = p(c)$ such that: a, b and c satisfy condition (1) and u_0 satisfies condition (2) in H . Moreover, there exist two vertex-disjoint paths P_0 and Q of $B_{n-2}^{0,3} - F$ cover all vertices of it, where P_0 connects u_0 to a_0 , and Q connects c to t_1 and $\langle c, b, a \rangle$ is a subpath of Q . So there exist three fault-free k_1 -dimension edges u_0a_1 , u_1a_2 and u_3a_0 , where $u_1, a_1 \in V(B_{n-2}^{1,3})$, $a_2 \in V(B_{n-2}^{2,3})$ and $u_3 \in V(B_{n-2}^{3,3})$. By Lemma 9, there exist a fault-free Hamiltonian path P_1 of $B_{n-2}^{1,3} - F$ from u_1 to a_1 , a fault-free Hamiltonian path P_2 of $B_{n-2}^{2,3} - F$ from

u to a_2 and a fault-free Hamiltonian path P_3 of $B_{n-2}^{3,3} - F$ from u_3 to t_2 . Hence, $P = \langle u, P_2, a_2, u_1, P_1, a_1, u_0, P_0, a_0, u_3, P_3, t_2 \rangle$ and Q are paths satisfying condition (3) in BH_n .

This completes the proof. \square

Now we are ready to state the main result of this paper.

Theorem 18. Let F be a set of edges with $|F| \leq 2n - 3$ and let $\{s_1, s_2\}$ and $\{t_1, t_2\}$ be two sets of vertices in different partite sets of BH_n for $n \geq 2$. Then $BH_n - F$ contains vertex-disjoint s_1, t_1 -path and s_2, t_2 -path that covers all vertices of it.

Proof. We proceed the proof by induction on n . By Lemma 13, the statement is true for BH_2 . For $n = 3$, we have characterized how to divide BH_3 by some dimension $k \in \{0, 1, 2\}$ in Remark. Assume that the statement holds for BH_{n-1} with $n \geq 3$. Next we consider BH_n . Since $|F| \leq 2n - 3$, by Pigeonhole Principle, there must exist a dimension $d \in \{0, 1, \dots, n-1\}$ such that $|E_d \cap F| \geq 2$ whenever $n \geq 4$. Thus, $|E(B^i) \cap F| \leq 2n - 5$, $i \in \{0, 1, 2, 3\}$ (we can also use Lemma 12 as induction basis when $n = 3$). Suppose without loss of generality that $d = n - 1$. So we divide BH_n into four subcubes B^i ($i \in \{0, 1, 2, 3\}$) by deleting E_{n-1} . By Lemma 2, BH_n is vertex transitive, we may assume that $s_1 \in V(B^0)$ and $|V(B^0) \cap \{s_2, t_1, t_2\}| \geq |V(B^j) \cap \{s_2, t_1, t_2\}|$ for $j \in \{1, 2, 3\}$. We consider the following cases.

Case 1. $|V(B^0) \cap \{s_2, t_1, t_2\}| = 0$. We further deal with the following cases.

Case 1.1. $s_2 \in V(B^1)$, $t_1 \in V(B^2)$ and $t_2 \in V(B^3)$. Since $4^{n-1} \geq 2n - 3$ whenever $n \geq 3$, there always exists a fault-free edge $u_3 a_0 \in E_{3,0}$. In addition, there exists a fault-free edge $v_3 b_0 \in E_{3,0}$ such that $u_3 \neq v_3$ and $b_0 \neq a_0$ (Let u and v be two vertices with distance two and let w be a common neighbor of them in B^i . We denote the set of edges incident to w , except uw and vw , in B^i by A , then $|A| = 2n - 4$. Note that $|F^i| \leq 2n - 4$ when $n = 3$ and $|F^i| \leq 2n - 5$ when $n > 3$, there may exist at most one pair of vertices u and v such that $A \subseteq F$ only if $n = 3$. It is easy to choose u and v to avoid this situation, so we do not mention this condition in the following proof.). Similarly, there exist two fault-free edges $u_0 a_1 \in E_{0,1}$ and $u_2 a_3 \in E_{2,3}$ such that $u_0 \neq s_1$ and $a_3 \neq t_2$. By Lemma 9, there exist a fault-free Hamiltonian path P_1 of $B^1 - F$ from s_2 to a_1 , and a fault-free Hamiltonian path P_2 of $B^2 - F$ from u_2 to t_1 . By induction hypothesis, there exist two vertex-disjoint paths P_{01} and P_{02} cover all vertices of $B^0 - F$, where P_{01} connects u_0 to a_0 and P_{02} connects s_1 to b_0 ; there exist two vertex-disjoint paths P_{31} and P_{32} cover all vertices of $B^3 - F$, where P_{31} connects u_3 to t_2 and P_{32} connects v_3 to a_3 . Hence, $\langle s_1, P_{02}, b_0, v_3, P_{32}, a_3, u_2, P_2, t_1 \rangle$

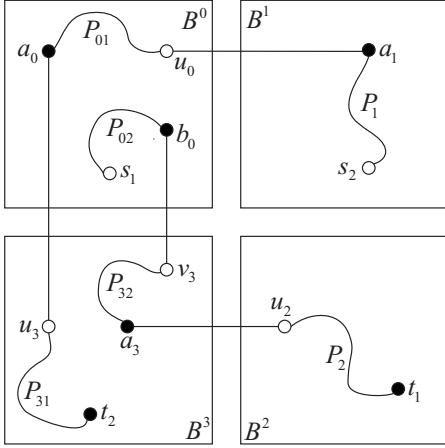

Fig. 5. Illustration of Cases 1.1.

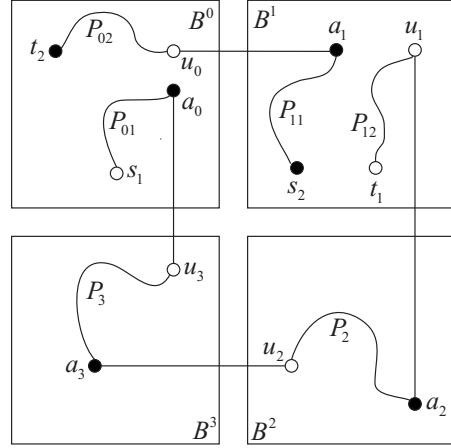

Fig. 6. Illustration of Case 2.1.2.

and $\langle s_2, P_1, a_1, u_0, P_{01}, a_0, u_3, P_{31}, t_2 \rangle$ are two vertex-disjoint paths required (see Fig. 5).

Case 1.2. $s_2 \in V(B^1)$, $t_1 \in V(B^3)$ and $t_2 \in V(B^2)$. There always exist two edges $u_3a_0, v_3b_0 \in E_{3,0}$ such that $u_3 \neq v_3$ and $a_0 \neq b_0$. Similarly, there exist an edge $u_0a_1 \in E_{0,1}$ such that $u_0 \neq s_1$, and an edge $u_2a_3 \in E_{2,3}$ such that $a_3 \neq t_1$. By Lemma 9, there exist a fault-free Hamiltonian path P_1 of $B^1 - F$ from s_2 to a_1 , and a fault-free Hamiltonian path P_2 of $B^2 - F$ from u_2 to t_2 . By induction hypothesis, there exist two vertex-disjoint paths P_{31} and P_{32} cover all vertices of $B^3 - F$, where P_{31} connects v_3 to t_1 and P_{32} connects u_3 to a_3 ; there exist two vertex-disjoint paths P_{01} and P_{02} cover all vertices of $B^0 - F$, where P_{01} connects u_0 to a_0 and P_{02} connects s_1 to b_0 . Hence, $\langle s_1, P_{02}, b_0, v_3, P_{31}, t_1 \rangle$ and $\langle s_2, P_1, a_1, u_0, P_{01}, a_0, u_3, P_{32}, a_3, u_2, P_2, t_2 \rangle$ are two vertex-disjoint paths required.

Case 1.3. $s_2 \in V(B^2)$, $t_1 \in V(B^1)$ and $t_2 \in V(B^3)$. There always exist two edges $u_3a_0, v_3b_0 \in E_{3,0}$ such that $u_3 \neq v_3$ and $a_0 \neq b_0$, and two edges $u_1a_2, v_1b_2 \in E_{1,2}$ such that $u_1 \neq v_1$ and $a_2 \neq b_2$. Similarly, there exist an edge $u_0a_1 \in E_{0,1}$ such that $u_0 \neq s_1$ and $a_1 \neq t_1$, and an edge $u_2a_3 \in E_{2,3}$ such that $u_2 \neq s_2$ and $a_3 \neq t_2$. By induction hypothesis, there exist two vertex-disjoint paths P_{01} and P_{02} cover all vertices of $B^0 - F$, where P_{01} connects u_0 to a_0 and P_{02} connects s_1 to b_0 ; there exist two vertex-disjoint paths P_{11} and P_{12} cover all vertices of $B^1 - F$, where P_{11} connects v_1 to t_1 and P_{12} connects u_1 to a_1 ; there exist two vertex-disjoint paths P_{21} and P_{22} cover all vertices of $B^2 - F$, where P_{21} connects u_2 to b_2 and P_{22} connects s_2 to a_2 ; there exist two vertex-disjoint paths P_{31} and P_{32} cover all vertices of $B^3 - F$, where P_{31} connects v_3 to

a_3 and P_{32} connects u_3 to t_2 . Hence, $\langle s_1, P_{02}, b_0, v_3, P_{31}, a_3, u_2, P_{21}, b_2, v_1, P_{11}, t_1 \rangle$ and $\langle s_2, P_{22}, a_2, u_1, P_{12}, a_1, u_0, P_{01}, a_0, u_3, P_{32}, t_2 \rangle$ are two vertex-disjoint paths required.

Case 1.4. $s_2 \in V(B^2)$, $t_1 \in V(B^3)$ and $t_2 \in V(B^1)$. Obviously, there exist two non-faulty edges $u_3a_0 \in E_{3,0}$ and $u_1a_2 \in E_{1,2}$. By Lemma 9, there exist a fault-free Hamiltonian path P_0 of $B^0 - F$ from s_1 to a_0 , a fault-free Hamiltonian path P_1 of $B^1 - F$ from u_1 to t_2 , a fault-free Hamiltonian path P_2 of $B^2 - F$ from s_2 to a_2 , and a fault-free Hamiltonian path P_3 of $B^3 - F$ from u_3 to t_1 . Hence, $\langle s_1, P_0, a_0, u_3, P_3, t_1 \rangle$ and $\langle s_2, P_2, a_2, u_1, P_1, t_2 \rangle$ are two vertex-disjoint paths required.

Case 2. $|V(B^0) \cap \{s_2, t_1, t_2\}| = 1$. We further deal with the following cases.

Case 2.1. For some $j \in \{0, 1, 2\}$, $|V(B^j) \cap \{s_2, t_1, t_2\}| = 2$.

Case 2.1.1. $t_1 \in V(B^0)$ and $s_2, t_2 \in V(B^1)$. By Lemma 9, there exists a fault-free Hamiltonian path P_0 of $B^0 - F$ from s_1 to t_1 . Since $4^{n-1} - 3 \geq 2(2n - 3)$ whenever $n \geq 3$ and any vertex incident to two faulty $(n - 1)$ -dimension edges will eliminate the choice of two edges on P_0 , we can choose an edge $u_0a_0 \in E(P_0)$ such that there exist two non-faulty edges $u_0a_1 \in E_{0,1}$ and $u_3a_0 \in E_{3,0}$. Deleting u_0a_0 from P_0 will give rise to two disjoint paths P_{01} and P_{02} , where P_{01} connects s_1 to u_0 and P_{02} connects a_0 to t_1 . Additionally, there exist a fault-free edge $u_1a_2 \in E_{1,2}$ such that $u_1 \neq s_2$, and an edge $u_2a_3 \in E_{2,3}$. By induction hypothesis, there exist two vertex-disjoint paths P_{11} and P_{12} cover all vertices of $B^1 - F$, where P_{11} connects a_1 to u_1 and P_{12} connects s_2 to t_2 . Moreover, there exist a fault-free Hamiltonian path P_2 of $B^2 - F$ from a_2 to u_2 , and a fault-free Hamiltonian path P_3 of $B^3 - F$ from a_3 to u_3 . Hence, $\langle s_1, P_{01}, u_0, a_1, P_{11}, u_1, a_2, P_2, u_2, a_3, P_3, u_3, a_0, P_{02}, t_1 \rangle$ and $\langle s_2, P_{12}, t_2 \rangle$ are two vertex-disjoint paths required.

Case 2.1.2. $t_2 \in V(B^0)$ and $s_2, t_1 \in V(B^1)$. There exist fault-free edges $u_0a_1 \in E_{0,1}$ such that $u_0 \neq s_1$ and $a_1 \neq t_1$, $u_1a_2 \in E_{1,2}$ such that $u_1 \neq s_2$, $u_2a_3 \in E_{2,3}$ and $u_3a_0 \in E_{3,0}$ such that $a_0 \neq t_2$. By induction hypothesis, there exist two vertex-disjoint paths P_{01} and P_{02} cover all vertices of $B^0 - F$, where P_{01} connects s_1 to a_0 and P_{02} connects u_0 to t_2 ; there exist two vertex-disjoint paths P_{11} and P_{12} cover all vertices of $B^1 - F$, where P_{11} connects u_1 to t_1 and P_{12} connects s_2 to a_1 . By Lemma 9, there exist a fault-free Hamiltonian path P_2 of $B^2 - F$ from u_2 to a_2 , and a fault-free Hamiltonian path P_3 of $B^3 - F$ from u_3 to a_3 . Hence, $\langle s_1, P_{01}, a_0, u_3, P_3, a_3, u_2, P_2, a_2, u_1, P_{11}, t_1 \rangle$ and $\langle s_2, P_{12}, a_1, u_0, P_{02}, t_2 \rangle$ are two vertex-disjoint paths required (see Fig. 6).

Case 2.1.3. $t_1 \in V(B^0)$ and $s_2, t_2 \in V(B^2)$. By Lemma 9, there exists a fault-free Hamiltonian path P_0 of $B^0 - F$ from s_1 to t_1 . We can choose an edge $u_0a_0 \in E(P_0)$

such that there exist two fault-free edges $u_0a_1 \in E_{0,1}$ and $u_3a_0 \in E_{3,0}$. Deleting u_0a_0 from P_0 will give rise to two disjoint paths P_{01} and P_{02} , where P_{01} connects s_1 to u_0 and P_{02} connects a_0 to t_1 . There exist a fault-free edge $u_1a_2 \in E_{1,2}$ such that $a_2 \neq t_2$, and a fault-free edge $u_2a_3 \in E_{2,3}$ such that $u_2 \neq s_2$. By induction hypothesis, there exist two vertex-disjoint paths P_{21} and P_{22} cover all vertices of $B^2 - F$, where P_{21} connects a_2 to u_2 and P_{22} connects s_2 to t_2 . By Lemma 9, there exist a fault-free Hamiltonian path P_1 of $B^1 - F$ from a_1 to u_1 , and a fault-free Hamiltonian path P_3 of $B^3 - F$ from a_3 to u_3 . Hence, $\langle s_1, P_{01}, u_0, a_1, P_1, u_1, a_2, P_{21}, u_2, a_3, P_3, u_3, a_0, P_{02}, t_1 \rangle$ and $\langle s_2, P_{22}, t_2 \rangle$ are two vertex-disjoint paths required.

Case 2.1.4. $t_2 \in V(B^0)$ and $s_2, t_1 \in V(B^2)$. There exist fault-free edges $u_0a_1 \in E_{0,1}$ such that $u_0 \neq s_1$, $u_1a_2 \in E_{1,2}$ such that $a_2 \neq t_1$, $u_2a_3 \in E_{2,3}$ such that $u_2 \neq s_2$ and $u_3a_0 \in E_{3,0}$ such that $a_0 \neq t_2$. By induction hypothesis, there exist two vertex-disjoint paths P_{01} and P_{02} cover all vertices of $B^0 - F$, where P_{01} connects s_1 to a_0 and P_{02} connects u_0 to t_2 ; there exist two vertex-disjoint paths P_{21} and P_{22} cover all vertices of $B^2 - F$, where P_{21} connects u_2 to t_1 and P_{22} connects s_2 to a_2 . By Lemma 9, there exist a fault-free Hamiltonian path P_1 of $B^1 - F$ from u_1 to a_1 , and a fault-free Hamiltonian path P_3 of $B^3 - F$ from u_3 to a_3 . Hence, $\langle s_1, P_{01}, a_0, u_3, P_3, a_3, u_2, P_{21}, t_1 \rangle$ and $\langle s_2, P_{22}, a_2, u_1, P_1, a_1, u_0, P_{02}, t_2 \rangle$ are two vertex-disjoint paths required.

Case 2.1.5. $s_2 \in V(B^0)$ and $t_1, t_2 \in V(B^1)$. There always exist two fault-free edges $u_3a_0, v_3b_0 \in E_{3,0}$ such that $u_3 \neq v_3$ and $a_0 \neq b_0$, two fault-free edges $u_1a_2, v_1b_2 \in E_{1,2}$ such that $u_1 \neq v_1$ and $a_2 \neq b_2$, and two fault-free edges $u_2a_3, v_2b_3 \in E_{2,3}$ such that $u_2 \neq v_2$ and $a_3 \neq b_3$. By induction hypothesis, there exist two vertex-disjoint paths P_{01} and P_{02} cover all vertices of $B^0 - F$, where P_{01} connects s_1 to a_0 and P_{02} connects s_2 to b_0 ; there exist two vertex-disjoint paths P_{11} and P_{12} cover all vertices of $B^1 - F$, where P_{11} connects u_1 to t_1 and P_{12} connects v_1 to t_2 ; there exist two vertex-disjoint paths P_{21} and P_{22} cover all vertices of $B^2 - F$, where P_{21} connects u_2 to a_2 and P_{22} connects v_2 to b_2 ; there exist two vertex-disjoint paths P_{31} and P_{32} cover all vertices of $B^3 - F$, where P_{31} connects u_3 to a_3 and P_{32} connects v_3 to b_3 . Hence, $\langle s_1, P_{01}, a_0, u_3, P_{31}, a_3, u_2, P_{21}, a_2, u_1, P_{11}, t_1 \rangle$ and $\langle s_2, P_{02}, b_0, v_3, P_{32}, b_3, v_2, P_{22}, b_2, v_1, P_{12}, t_1 \rangle$ are two vertex-disjoint paths required.

Case 2.1.6. $s_2 \in V(B^0)$ and $t_1, t_2 \in V(B^2)$. By Lemma 14, there exist four vertices $a, c \in V_0$ and $b, d \in V_1$ of B^3 such that:

- (1) $a = p(c)$, $b = p(d)$ and a, b, c and d form a 4-cycle in B^3 ;
- (2) there exists an $(n-1)$ -dimension neighbor a_0 of a and c such that $a_0a, a_0c \notin F$;

(3) there exist two $(n - 1)$ -dimension neighbors u_2 and v_2 of b and d such that $u_2b, u_2d, v_2b \notin F$ and $cd \notin F$;

(4) there exists a neighbor u of b and d in B^3 such that $ub_0 \notin F$ is an $(n - 1)$ -dimension edge;

(5) there exists a longest path P_3 from u to a covering all vertices of $B^3 - F$ but b, c and d .

It is obvious that $a_0 \neq p(b_0)$. By induction hypothesis, there exist two vertex-disjoint paths P_{01} and P_{02} cover all vertices of $B^0 - F$, where P_{01} connects s_1 to a_0 and P_{02} connects s_2 to b_0 ; there exist two vertex-disjoint paths P_{21} and P_{22} cover all vertices of $B^2 - F$, where P_{21} connects u_2 to t_1 and P_{22} connects v_2 to t_2 . Let u_0 (resp. a_2) be the neighbor of a_0 (resp. u_2) on P_{01} (resp. P_{21}). For convenience, we denote $P_{01} - a_0$ by P_{03} , that is, P_{03} is a path from s_1 to u_0 . Similarly, we denote $P_{21} - a_2$ by P_{23} , that is, P_{23} is a path from a_2 to t_1 . If $|e_{n-1}(u_0) \cap F| = 2$ or $|e_{n-1}(a_2) \cap F| = 2$, say $|e_{n-1}(u_0) \cap F| = 2$, let $u'_0 \in V(B^0)$ such that $u'_0 = p(u_0)$. Moreover, if $u'_0a_0 \notin F$, we can replace u_0 by u'_0 on P_{03} . Otherwise we have at least three fault edges incident to u_0 and u'_0 . Since there are $2n - 2$ common neighbors of u_0 and u'_0 in B^0 , fault edges incident to u_0 and u'_0 may affect $2n - 2$ vertices as the choice of a_0 . Since $3 \times ((4^{n-1} - 2)/2)/(2n - 2) > 2n - 3$ whenever $n \geq 3$, we can always choose such $u_0 \in V(B^0)$ and $a_2 \in V(B^2)$ that there exist two fault-free $(n - 1)$ -dimension edges $u_0a_1 \in E_{0,1}$ and $u_1a_2 \in E_{1,2}$. Then there exists a fault-free Hamiltonian path P_1 of $B^1 - F$ from a_1 to u_1 . Hence, $\langle s_1, P_{03}, u_0, a_1, P_1, u_1, a_2, P_{23}, t_1 \rangle$ and $\langle s_2, P_{02}, b_0, u, P_3, a, a_0, c, d, u_2, b, v_2, P_{22}, t_2 \rangle$ are two vertex-disjoint paths required (see Fig. 7).

Case 2.1.7. $s_2 \in V(B^0)$ and $t_1, t_2 \in V(B^3)$. By Lemma 17, there exist four vertices $u, a, c \in V_0$ and $b \in V_1$ of B^3 with $a = p(c)$ such that:

(1) there exists an $(n - 1)$ -dimension neighbor a_0 of a and c such that $a_0a, a_0c \notin F$ and there exists an $(n - 1)$ -dimension neighbor u_2 of b such that $u_2b \notin F$, where b ($b \neq t_1, t_2$) is a common neighbor of a and c ;

(2) there exists an $(n - 1)$ -dimension neighbor b_0 of u such that $ub_0 \notin F$;

(3) there exist two vertex-disjoint paths P_{31} and Q of $B^3 - F$ cover all vertices of it, where P_{31} connects u to t_2 , and Q connects c to t_1 and $\langle c, b, a \rangle$ is a subpath of Q .

Deleting ab from Q will generate two vertex-disjoint paths bc and P_{32} , where P_{32} connects a to t_1 . By induction hypothesis, there exist two vertex-disjoint paths P_{01} and P_{02} cover all vertices of $B^0 - F$, where P_{01} connects s_1 to a_0 and P_{02}

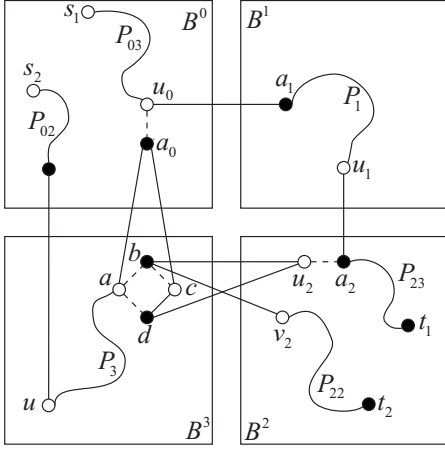

Fig. 7. Illustration of Cases 2.1.6.

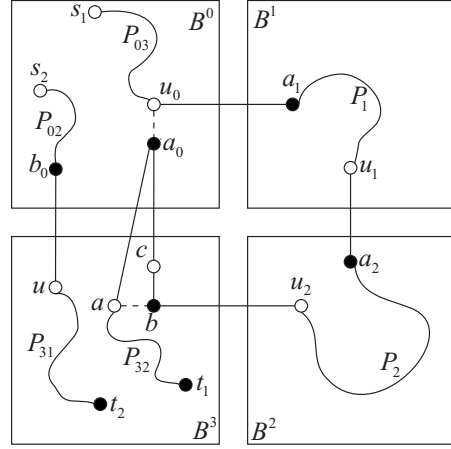

Fig. 8. Illustration of Case 2.1.7.

connects s_2 to b_0 . Similar to the proof of Case 2.1.6, let u_0 be the neighbor of a_0 on P_{01} such that $u_0a_1 \in E_{0,1}$ is a fault-free edge. For convenience, we denote $P_{01} - a_0$ by P_{03} , that is, P_{03} is a path from s_1 to u_0 . By Lemma 6, there must exist a fault-free edge $u_1a_2 \in E_{1,2}$. Additionally, there exist a fault-free Hamiltonian path P_1 of $B^1 - F$ from a_1 to u_1 , and a fault-free Hamiltonian path P_2 of $B^2 - F$ from a_2 to u_2 . Hence, $\langle s_1, P_{03}, u_0, a_1, P_1, u_1, a_2, P_2, u_2, b, c, a_0, a, P_{32}, t_1 \rangle$ and $\langle s_2, P_{02}, b_0, u, P_{31}, t_2 \rangle$ are two vertex-disjoint paths required (see Fig. 8).

Case 2.2. For all $j \in \{0, 1, 2\}$, $|V(B^j) \cap \{s_2, t_1, t_2\}| \leq 1$.

Case 2.2.1. $t_1 \in V(B^0)$.

Case 2.2.1.1. $t_2 \in V(B^1)$ and $s_2 \in V(B^2)$. There exist fault-free edges $u_0a_1 \in E_{0,1}$ such that $u_0 \neq s_1$, $u_1a_2, v_1b_2 \in E_{1,2}$ such that $u_1 \neq v_1$ and $a_2 \neq b_2$, $u_2a_3 \in E_{2,3}$ such that $u_2 \neq s_2$, and $u_3a_0 \in E_{3,0}$ such that $a_0 \neq t_1$. By induction hypothesis, there exist two vertex-disjoint paths P_{01} and P_{02} cover all vertices of $B^0 - F$, where P_{01} connects s_1 to a_0 and P_{02} connects u_0 to t_1 ; there exist two vertex-disjoint paths P_{11} and P_{12} cover all vertices of $B^1 - F$, where P_{11} connects u_1 to a_1 and P_{12} connects v_1 to t_2 ; there exist two vertex-disjoint paths P_{21} and P_{22} cover all vertices of $B^2 - F$, where P_{21} connects u_2 to a_2 and P_{22} connects s_2 to b_2 . By Lemma 9, there exists a fault-free Hamiltonian path P_3 of $B^3 - F$ from u_3 to a_3 . Hence, $\langle s_1, P_{01}, a_0, u_3, P_3, a_3, u_2, P_{21}, a_2, u_1, P_{11}, a_1, u_0, P_{02}, t_1 \rangle$ and $\langle s_2, P_{22}, b_2, v_1, P_{12}, t_2 \rangle$ are two vertex-disjoint paths required.

Case 2.2.1.2. $t_2 \in V(B^1)$ and $s_2 \in V(B^3)$. There exist two non-faulty edges $u_1a_2 \in E_{1,2}$ and $u_2a_3 \in E_{2,3}$. By Lemma 9, there exist a fault-free Hamiltonian path

P_0 of $B^0 - F$ from s_1 to t_1 , a fault-free Hamiltonian path P_1 of $B^1 - F$ from u_1 to t_2 , a fault-free Hamiltonian path P_2 of $B^2 - F$ from u_2 to a_2 , and a fault-free Hamiltonian path P_3 of $B^3 - F$ from s_2 to a_3 . Hence, $\langle s_1, P_1, t_1 \rangle$ and $\langle s_2, P_3, a_3, u_2, P_2, a_2, u_1, P_1, t_2 \rangle$ are two vertex-disjoint paths required.

Case 2.2.1.3. $t_2 \in V(B^2)$ and $s_2 \in V(B^3)$. There exist fault-free edges $u_0a_1 \in E_{0,1}$ such that $u_0 \neq s_1$, $u_1a_2 \in E_{1,2}$ such that $a_2 \neq t_2$, $u_2a_3, v_2b_3 \in E_{2,3}$ such that $a_3 \neq b_3$ and $u_2 \neq v_2$, and $u_3a_0 \in E_{2,3}$ such that $u_3 \neq s_2$ and $a_0 \neq t_1$. By induction hypothesis, there exist two vertex-disjoint paths P_{01} and P_{02} cover all vertices of $B^0 - F$, where P_{01} connects s_1 to a_0 and P_{02} connects u_0 to t_1 ; there exist two vertex-disjoint paths P_{21} and P_{22} cover all vertices of $B^2 - F$, where P_{21} connects u_2 to a_2 and P_{22} connects v_2 to t_2 ; there exist two vertex-disjoint paths P_{31} and P_{32} cover all vertices of $B^3 - F$, where P_{31} connects u_3 to a_3 and P_{32} connects s_2 to b_3 . By Lemma 9, there exists a fault-free Hamiltonian path P_1 of $B^1 - F$ from u_1 to a_1 . Hence, $\langle s_1, P_{01}, a_0, u_3, P_{31}, a_3, u_2, P_{21}, a_2, u_1, P_1, a_1, u_0, P_{02}, t_1 \rangle$ and $\langle s_2, P_{32}, b_3, v_2, P_{22}, t_2 \rangle$ are two vertex-disjoint paths required.

Case 2.2.1.4. $t_2 \in V(B^2)$ and $s_2 \in V(B^1)$. There exist fault-free edges $u_0a_1 \in E_{0,1}$ such that $u_0 \neq s_1$, $v_1b_2 \in E_{1,2}$ such that $v_1 \neq s_2$ and $b_2 \neq t_2$, $u_2a_3, v_2b_3 \in E_{2,3}$ such that $a_3 \neq b_3$ and $u_2 \neq v_2$, and $u_3a_0 \in E_{3,0}$ such that $a_0 \neq t_1$. By induction hypothesis, there exist two vertex-disjoint paths P_{01} and P_{02} cover all vertices of $B^0 - F$, where P_{01} connects u_0 to a_0 and P_{02} connects s_1 to t_1 ; there exist two vertex-disjoint paths P_{21} and P_{22} cover all vertices of $B^2 - F$, where P_{21} connects v_2 to b_2 and P_{22} connects u_2 to t_2 . Moreover, there must exist an edge v_0b_0 in P_{01} or P_{02} , say P_{02} such that there exist two fault-free $(n-1)$ -dimension edges $v_0b_1 \in E_{0,1}$ and $v_3b_0 \in E_{3,0}$, where $v_3 \neq u_3$ and $b_1 \neq a_1$. Deleting v_0b_0 from P_{02} will generate two vertex-disjoint paths P_{03} and P_{04} , where P_{03} connects s_1 to b_0 and P_{04} connects v_0 to t_1 . Analogously, there exist two vertex-disjoint paths P_{11} and P_{12} cover all vertices of $B^1 - F$, where P_{11} connects v_1 to b_1 and P_{12} connects s_2 to a_1 ; there exist two vertex-disjoint paths P_{31} and P_{32} cover all vertices of $B^3 - F$, where P_{31} connects v_3 to b_3 and P_{32} connects u_3 to a_3 . Hence, $\langle s_1, P_{03}, b_0, v_3, P_{31}, b_3, v_2, P_{21}, b_2, v_1, P_{11}, b_1, v_0, P_{04}, t_1 \rangle$ and $\langle s_2, P_{12}, a_1, u_0, P_{01}, a_0, u_3, P_{32}, a_3, u_2, P_{22}, t_2 \rangle$ are two vertex-disjoint paths required.

Case 2.2.1.5. $t_2 \in V(B^3)$ and $s_2 \in V(B^1)$. The proof is quite analogous to that of Case 2.2.1.4, we omit it.

Case 2.2.1.6. $t_2 \in V(B^3)$ and $s_2 \in V(B^2)$. The proof is quite analogous to that of Case 2.2.1.4, we omit it.

Case 2.2.2. $t_2 \in V(B^0)$.

Case 2.2.2.1. $t_1 \in V(B^1)$ and $s_2 \in V(B^2)$. There exist fault-free edges $v_0b_1 \in E_{0,1}$ such that $v_0 \neq s_1$ and $b_1 \neq t_1$, $u_1a_2, v_1b_2 \in E_{1,2}$ such that $u_1 \neq v_1$ and $a_2 \neq b_2$, $u_2a_3 \in E_{2,3}$ such that $u_2 \neq s_2$, and $u_3a_0 \in E_{3,0}$ such that $a_0 \neq t_2$. By induction hypothesis, there exist two vertex-disjoint paths P_{01} and P_{02} cover all vertices of $B^0 - F$, where P_{01} connects s_1 to a_0 and P_{02} connects v_0 to t_2 ; there exist two vertex-disjoint paths P_{11} and P_{12} cover all vertices of $B^1 - F$, where P_{11} connects u_1 to t_1 and P_{12} connects v_1 to b_1 ; there exist two vertex-disjoint paths P_{21} and P_{22} cover all vertices of $B^2 - F$, where P_{21} connects u_2 to a_2 and P_{22} connects s_2 to b_2 . By Lemma 9, there exists a Hamiltonian path P_3 of $B^3 - F$ from u_3 to a_3 . Hence, $\langle s_1, P_{01}, a_0, u_3, P_3, a_3, u_2, P_{21}, a_2, u_1, P_{11}, t_1 \rangle$ and $\langle s_2, P_{22}, b_2, v_1, P_{12}, b_1, v_0, P_{02}, t_2 \rangle$ are two vertex-disjoint paths required.

Case 2.2.2.2. $t_1 \in V(B^1)$ and $s_2 \in V(B^3)$. There exist fault-free edges $v_0b_1 \in E_{0,1}$ such that $v_0 \neq s_1$ and $b_1 \neq t_1$, $u_1a_2, v_1b_2 \in E_{1,2}$ such that $u_1 \neq v_1$ and $a_2 \neq b_2$, $u_2a_3, v_2b_3 \in E_{2,3}$ such that $u_2 \neq v_2$ and $a_3 \neq b_3$, and $u_3a_0 \in E_{3,0}$ such that $a_0 \neq t_2$ and $u_3 \neq s_2$. By induction hypothesis, there exist two vertex-disjoint paths P_{01} and P_{02} cover all vertices of $B^0 - F$, where P_{01} connects s_1 to a_0 and P_{02} connects v_0 to t_2 ; there exist two vertex-disjoint paths P_{11} and P_{12} cover all vertices of $B^1 - F$, where P_{11} connects u_1 to t_1 and P_{12} connects v_1 to b_1 ; there exist two vertex-disjoint paths P_{21} and P_{22} cover all vertices of $B^2 - F$, where P_{21} connects u_2 to a_2 and P_{22} connects v_2 to b_2 ; there exist two vertex-disjoint paths P_{31} and P_{32} cover all vertices of $B^3 - F$, where P_{31} connects u_3 to a_3 and P_{32} connects s_2 to b_3 . Hence, $\langle s_1, P_{01}, a_0, u_3, P_{31}, a_3, u_2, P_{21}, a_2, u_1, P_{11}, t_1 \rangle$ and $\langle s_2, P_{32}, b_3, v_2, P_{22}, b_2, v_1, P_{12}, b_1, v_0, P_{02}, t_2 \rangle$ are two vertex-disjoint paths required.

Case 2.2.2.3. $t_1 \in V(B^2)$ and $s_2 \in V(B^1)$. There exist fault-free edges $v_0b_1 \in E_{0,1}$ such that $v_0 \neq s_1$, $u_2a_3 \in E_{2,3}$, and $u_3a_0 \in E_{3,0}$ such that $a_0 \neq t_2$. By induction hypothesis, there exist two vertex-disjoint paths P_{01} and P_{02} cover all vertices of $B^0 - F$, where P_{01} connects s_1 to a_0 and P_{02} connects v_0 to t_2 . By Lemma 9, there exist a fault-free Hamiltonian path P^1 of $B^1 - F$ from s_2 to b_1 , a fault-free Hamiltonian path P^2 of $B^2 - F$ from u_2 to t_1 , and a fault-free Hamiltonian path P^3 of $B^3 - F$ from u_3 to a_3 . Hence, $\langle s_1, P_{01}, a_0, u_3, P_3, a_3, u_2, P_2, t_1 \rangle$ and $\langle s_2, P_1, b_1, v_0, P_{02}, t_2 \rangle$ are two vertex-disjoint paths required.

Case 2.2.2.4. $t_1 \in V(B^2)$ and $s_2 \in V(B^3)$. The proof is quite analogous to that of Case 2.2.2.1, we omit it.

Case 2.2.2.5. $t_1 \in V(B^3)$ and $s_2 \in V(B^1)$. There exist fault-free edges $v_0b_1 \in E_{0,1}$ such that $v_0 \neq s_1$, $u_1a_2 \in E_{1,2}$ such that $u_1 \neq s_2$, $u_2a_3 \in E_{2,3}$ such that $a_3 \neq t_1$,

and $v_3a_0 \in E_{3,0}$ such that $a_0 \neq t_2$. By induction hypothesis, there exist two vertex-disjoint paths P_{01} and P_{02} cover all vertices of $B^0 - F$, where P_{01} connects v_0 to t_2 and P_{02} connects s_1 to a_0 . Moreover, there must exist an edge u_0b_0 on P_{01} or P_{02} , say P_{02} such that there exist two fault-free $(n-1)$ -dimension edges $u_0a_1 \in E_{0,1}$ and $u_3b_0 \in E_{3,0}$, where $u_3 \neq v_3$ and $a_1 \neq b_1$. Deleting u_0b_0 from P_{02} will generate two vertex-disjoint paths P_{03} and P_{04} , where P_{03} connects s_1 to b_0 and P_{04} connects u_0 to a_0 . Analogously, there exist two vertex-disjoint paths P_{11} and P_{12} cover all vertices of $B^1 - F$, where P_{11} connects u_1 to a_1 and P_{12} connects s_2 to b_1 ; there exist two vertex-disjoint paths P_{31} and P_{32} cover all vertices of $B^3 - F$, where P_{31} connects v_3 to t_1 and P_{32} connects u_3 to a_3 . By Lemma 9, there exist a fault-free Hamiltonian path P_2 of $B^2 - F$ from u_2 to a_2 . Hence, $\langle s_1, P_{03}, b_0, u_3, P_{32}, a_3, u_2, P_2, a_2, u_1, P_{11}, a_1, u_0, P_{04}, a_0, v_3, P_{31}, t_1 \rangle$ and $\langle s_2, P_{12}, b_1, v_0, P_{01}, t_2 \rangle$ are two vertex-disjoint paths required.

Case 2.2.2.6. $t_1 \in V(B^3)$ and $s_2 \in V(B^2)$. There exist fault-free edges $v_0b_1 \in E_{0,1}$ such that $v_0 \neq s_1$, $v_1b_2 \in E_{1,2}$, and $u_3a_0 \in E_{3,0}$ such that $a_0 \neq t_2$. By induction hypothesis, there exist two vertex-disjoint paths P_{01} and P_{02} cover all vertices of $B^0 - F$, where P_{01} connects s_1 to a_0 and P_{02} connects v_0 to t_2 . By Lemma 9, there exist a fault-free Hamiltonian path P_1 of $B^1 - F$ from v_1 to b_1 , a fault-free Hamiltonian path P_2 of $B^2 - F$ from s_2 to b_2 , and a fault-free Hamiltonian path P_3 of $B^3 - F$ from u_3 to t_1 . Hence, $\langle s_1, P_{01}, a_0, u_3, P_3, t_1 \rangle$ and $\langle s_2, P_2, b_2, v_1, P_1, b_1, v_0, P_{02}, t_2 \rangle$ are two vertex-disjoint paths required.

Case 2.2.3. $s_2 \in V(B^0)$.

Case 2.2.3.1. $t_1 \in V(B^1)$ and $t_2 \in V(B^2)$. There exist fault-free edges $u_1a_2 \in E_{1,2}$ such that $a_2 \neq t_2$, $u_2a_3, v_2b_3 \in E_{2,3}$ such that $u_2 \neq v_2$ and $a_3 \neq b_3$, and $u_3a_0, v_3b_0 \in E_{3,0}$ such that $u_3 \neq v_3$ and $a_0 \neq b_0$. By induction hypothesis, there exist two vertex-disjoint paths P_{01} and P_{02} cover all vertices of $B^0 - F$, where P_{01} connects s_1 to a_0 and P_{02} connects s_2 to b_0 ; there exist two vertex-disjoint paths P_{21} and P_{22} cover all vertices of $B^2 - F$, where P_{21} connects u_2 to a_2 and P_{22} connects v_2 to t_2 ; there exist two vertex-disjoint paths P_{31} and P_{32} cover all vertices of $B^3 - F$, where P_{31} connects u_3 to a_3 and P_{32} connects v_3 to b_3 . By Lemma 9, there exists a fault-free Hamiltonian path P_1 of $B^1 - F$ from u_1 to t_1 . Hence, $\langle s_1, P_{01}, a_0, u_3, P_{31}, a_3, u_2, P_{21}, a_2, u_1, P_1, t_1 \rangle$ and $\langle s_2, P_{02}, b_0, v_3, P_{32}, b_3, v_2, P_{22}, t_2 \rangle$ are two vertex-disjoint paths required.

Case 2.2.3.2. $t_1 \in V(B^1)$ and $t_2 \in V(B^3)$. The proof is quite analogous to that of Case 2.2.3.1, we omit it.

Case 2.2.3.3. $t_1 \in V(B^2)$ and $t_2 \in V(B^3)$. By Lemma 17, there exist four vertices

$u, a, c \in V_1$ and $b \in V_0$ of $B^0 - F$ with $a = p(c)$ such that:

(1) there exists an $(n-1)$ -dimension neighbor u_3 of a and c such that $u_3a, u_3c \notin F$ and there exists an $(n-1)$ -dimension neighbor a_1 of b such that $a_1b \notin F$, where b ($b \neq s_1, s_2$) is a common neighbor of a and c ;

(2) there exists an $(n-1)$ -dimension neighbor v_3 of u such that $uv_3 \notin F$;

(3) there exist two vertex-disjoint paths P_{01} and Q of $B^0 - F$ cover all vertices of it, where P_{01} connects s_2 to u , and Q connects s_1 to c and $\langle c, b, a \rangle$ is a subpath of Q .

Deleting ab from Q will generate two vertex-disjoint paths P_{02} and bc , where P_{02} connects s_1 to a and bc is an edge. Let $a_3 \in V_1$ be a vertex in B^3 such that $a_3 \neq t_2$ and $u_2a_3 \in E_{2,3}$ is a fault-free edge. In addition, there exist two vertex-disjoint paths P_{31} and P_{32} cover all vertices of $B^3 - F$, where P_{31} connects v_3 to t_2 and P_{32} connects u_3 to a_3 . Similar to the proof of Case 2.1.6, let b_3 be the neighbor of u_3 on P_{32} such that $v_2b_3 \in E_{2,3}$ is a fault-free edge. For convenience, we denote $P_{32} - u_3$ by P_{33} , that is, P_{33} is a path from b_3 to a_3 . By Lemma 6, there must exist a fault-free edge $u_1a_2 \in E_{1,2}$ such that $a_2 \neq t_1$. Thus, there exist two vertex-disjoint paths P_{21} and P_{22} cover all vertices of $B^2 - F$, where P_{21} connects u_2 to t_1 and P_{22} connects a_2 to v_2 . Additionally, there exist a fault-free Hamiltonian path P_1 of $B^1 - F$ from a_1 to u_1 . Hence, $\langle s_1, P_{02}, a, u_3, c, b, a_1, P_1, u_1, a_2, P_{22}, v_2, b_3, P_{33}, a_3, u_2, P_{21}, t_1 \rangle$ and $\langle s_2, P_{01}, u, v_3, P_{31}, t_2 \rangle$ are two vertex-disjoint paths required.

Case 3. $|V(B^0) \cap \{s_2, t_1, t_2\}| = 2$.

Case 3.1. $t_1, t_2 \in V(B^0)$ and $s_2 \in V(B^1)$. There exist a fault-free edge $v_0b_1 \in E_{0,1}$ such that $v_0 \neq s_1$. By induction hypothesis, there exist two vertex-disjoint paths P_{01} and P_{02} cover all vertices of $B^0 - F$, where P_{01} connects v_0 to t_2 and P_{02} connects s_1 to t_1 . Moreover, there must exist an edge u_0a_0 on P_{01} or P_{02} , say P_{02} such that there exist two fault-free $(n-1)$ -dimension edges $u_0a_1 \in E_{0,1}$ and $u_3a_0 \in E_{3,0}$, where $a_1 \neq b_1$. Deleting u_0a_0 from P_{02} will generate two vertex-disjoint paths P_{03} and P_{04} , where P_{03} connects s_1 to a_0 and P_{04} connects u_0 to t_1 . In addition, there exist two fault-free edges $u_1a_2 \in E_{1,2}$ and $u_2a_3 \in E_{2,3}$, where $u_1 \neq s_2$. Analogously, there exist two vertex-disjoint paths P_{11} and P_{12} cover all vertices of $B^1 - F$, where P_{11} connects u_1 to a_1 and P_{12} connects s_2 to b_1 . Moreover, by Lemma 9, there exist a fault-free Hamiltonian path P_2 of $B^2 - F$ from u_2 to a_2 and a fault-free Hamiltonian path P_3 of $B^3 - F$ from u_3 to a_3 . Hence, $\langle s_1, P_{03}, a_0, u_3, P_3, a_3, u_2, P_2, a_2, u_1, P_{11}, a_1, u_0, P_{04}, t_1 \rangle$ and $\langle s_2, P_{12}, b_1, v_0, P_{01}, t_2 \rangle$ are two vertex-disjoint paths required.

Case 3.2. $t_1, t_2 \in V(B^0)$ and $s_2 \in V(B^2)$. There exist a fault-free edge $v_0b_1 \in E_{0,1}$

such that $v_0 \neq s_1$. By induction hypothesis, there exist two vertex-disjoint paths P_{01} and P_{02} cover all vertices of $B^0 - F$, where P_{01} connects v_0 to t_2 and P_{02} connects s_1 to t_1 . Moreover, there must exist an edge u_0a_0 on P_{01} or P_{02} , say P_{02} such that there exist two fault-free $(n-1)$ -dimension edges $u_0a_1 \in E_{0,1}$ and $u_3a_0 \in E_{3,0}$, where $a_1 \neq b_1$. Deleting u_0a_0 from P_{02} will generate two vertex-disjoint paths P_{03} and P_{04} , where P_{03} connects s_1 to a_0 and P_{04} connects u_0 to t_1 . In addition, there exist fault-free edges $u_1a_2, v_1b_2 \in E_{1,2}$ such that $u_1 \neq v_1$ and $a_2 \neq b_2$, and $u_2a_3 \in E_{2,3}$. Analogously, there exist two vertex-disjoint paths P_{11} and P_{12} cover all vertices of $B^1 - F$, where P_{11} connects u_1 to a_1 and P_{12} connects v_1 to b_1 ; there exist two vertex-disjoint paths P_{21} and P_{22} cover all vertices of $B^2 - F$, where P_{21} connects u_2 to a_2 and P_{22} connects s_2 to b_2 . Moreover, by Lemma 9, there exist a fault-free Hamiltonian path P_3 of $B^3 - F$ from u_3 to a_3 . Hence, $\langle s_1, P_{03}, a_0, u_3, P_3, a_3, u_2, P_{21}, a_2, u_1, P_{11}, a_1, u_0, P_{04}, t_1 \rangle$ and $\langle s_2, P_{22}, b_2, v_1, P_{12}, b_1, v_0, P_{01}, t_2 \rangle$ are two vertex-disjoint paths required.

Case 3.3. $t_1, t_2 \in V(B^0)$ and $s_2 \in V(B^3)$. There exist fault-free edges $v_0b_1 \in E_{0,1}$ such that $v_0 \neq s_1$, $v_1b_2 \in E_{1,2}$, and $v_2b_3 \in E_{2,3}$. By induction hypothesis, there exist two vertex-disjoint paths P_{01} and P_{02} cover all vertices of $B^0 - F$, where P_{01} connects s_1 to t_1 and P_{02} connects v_0 to t_2 . By Lemma 9, there exist a fault-free Hamiltonian path P_1 of $B^1 - F$ from v_1 to b_1 , a fault-free Hamiltonian path P_2 of $B^2 - F$ from v_2 to b_2 , and a fault-free Hamiltonian path P_3 of $B^3 - F$ from s_2 to b_3 . Hence, $\langle s_1, P_{01}, t_1 \rangle$ and $\langle s_2, P_3, b_3, v_2, P_2, b_2, v_1, P_1, b_1, v_0, P_{02}, t_2 \rangle$ are two vertex-disjoint paths required.

Case 4. $s_2, t_1, t_2 \in V(B^0)$. By induction hypothesis, there exist two vertex-disjoint paths P_{01} and P_{02} cover all vertices of $B^0 - F$, where P_{01} connects s_1 to t_1 and P_{02} connects s_2 to t_2 . Since $l(P_{01}) + l(P_{02}) = 4^{n-1} - 2$ and any vertex has two $(n-1)$ -dimension neighbors, there must exist an edge u_0a_0 on P_{01} or P_{02} , say P_{01} such that there exist two non-faulty edges $u_0a_1 \in E_{0,1}$ and $u_3a_0 \in E_{3,0}$. Thus, deleting u_0a_0 from P_{01} will generate two vertex-disjoint paths P_{03} and P_{04} , where P_{03} connects s_1 to a_0 and P_{04} connects u_0 to t_1 . In addition, there exist non-faulty edges $u_1a_2 \in E_{1,2}$ and $u_2a_3 \in E_{2,3}$. By Lemma 9, there exist a fault-free Hamiltonian path P_1 of $B^1 - F$ from u_1 to a_1 , a fault-free Hamiltonian path P_2 of $B^2 - F$ from u_2 to a_2 , and a fault-free Hamiltonian path P_3 of $B^3 - F$ from u_3 to a_3 . Hence, $\langle s_1, P_{03}, a_0, u_3, P_3, a_3, u_2, P_2, a_2, u_1, P_1, a_1, u_0, P_{04}, t_1 \rangle$ and $\langle s_2, P_{02}, t_2 \rangle$ are two vertex-disjoint paths required.

Thus, this completes the proof. \square

4. Conclusions

In this paper, we consider paired two-disjoint path cover of the balanced hypercube with some faulty edges. We use induction to prove that the balanced hypercube BH_n , $n \geq 2$, is paired two-disjoint path coverable when at most $2n - 3$ edge faults occur.

Let $s_1, s_2 \in V_0$ and $t_1, t_2 \in V_1$ be four vertices in BH_n . There exists a balanced hypercube BH_n with $2n - 2$ edge faults containing no vertex-disjoint paths P_i , $i = 1, 2$, that cover all vertices of it, where P_i connects s_i to t_i and $V(P_1) \cup V(P_2) = V(BH_n)$. For example, let s_1 and s_2 be two vertices differing only from the inner index and let w be any common neighbor of s_1 and s_2 . One can consider that the $2n - 2$ edges incident to w (except s_1w and s_2w) are all faulty (see Fig. 9). Obviously, w has exactly two fault-free edges incident to it. Therefore, it is impossible to have vertex-disjoint s_1, t_1 -path and s_2, t_2 -path that cover all vertices of BH_n . Hence, our results are optimal.

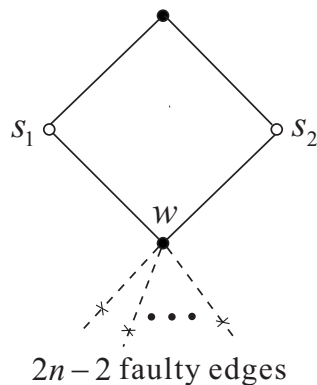

Fig. 9. BH_n has no paired two-disjoint path cover with $2n - 2$ faulty edges.

Acknowledgments

I am grateful to Simon R. Blackburn for fruitful discussions during my visit to Royal Holloway, University of London.

References

- [1] J.A. Bondy, U.S.R. Murty, Graph theory, Springer, New York, 2007.

- [2] J. Cai, An algorithm for hamiltonian cycles under implicit degree conditions, *Ars Comb.* 121 (2015) 305–313.
- [3] J. Cai, H. Li, Hamilton cycles in implicit 2-heavy graphs, *Graphs Comb.* 32 (2016) 1329–1337.
- [4] X.-B. Chen, Paired 2-disjoint path covers of faulty k -ary n -cubes, *Theor. Comput. Sci.* 609 (2016) 494–499.
- [5] D. Cheng, R. Hao, Y. Feng, Two node-disjoint paths in balanced hypercubes, *Appl. Math. Comput.* 242 (2014) 127–142.
- [6] Q. Dong, J. Zhou, Y. Fu, H. Gao, Hamiltonian connectivity of restricted hypercube-like networks under the conditional fault model, *Theor. Comput. Sci.* 472 (2013) 46–59.
- [7] J. Dybizbański, A. Szepietowski, Hamiltonian paths in hypercubes with local traps, *Inform. Sci.* 375 (2017) 258–270.
- [8] J. Fan, X. Lin, X. Jia, Optimal path embeddings of paths with various lengths in twisted cubes, *IEEE Trans. Parallel Distrib. Syst.* 18 (4) (2007) 511–521.
- [9] R.J. Gould, Advances on the hamiltonian problem - a survey, *Graphs Comb.* 19 (2003) 7–52.
- [10] R.-X. Hao, Z. Ru, Y.-Q. Feng, Hamiltonian cycle embedding for fault tolerance in balanced hypercubes, *Appl. Math. Comput.* 244 (2014) 447–456.
- [11] K. Huang, J. Wu, Fault-tolerant resource placement in balanced hypercubes, *Inform. Sci.* 99 (1997) 159–172.
- [12] S. Jo, J.-H. Park, K.-Y. Chwa, Paired many-to-many disjoint path covers in faulty hypercubes, *Theor. Comput. Sci.* 513 (2013) 1–24.
- [13] S.-Y. Kim, J.-H. Park, Paired many-to-many disjoint path covers in recursive circulants $G(2^m, 4)$, *IEEE Trans. Comput.* 62 (12) (2013) 2468–2475.
- [14] F.T. Leighton, *Introduction to Parallel Algorithms and Architectures*. San Mateo, 1992, Calif.: Morgan Kaufmann Publishers.

- [15] P. Li, M. Xu, Edge-fault-tolerant edge-bipancyclicity of balanced hypercubes, *Applied. Math. Comput.* 307 (2017) 180–192.
- [16] H. Lü, X. Li, H. Zhang, Matching preclusion for balanced hypercubes, *Theor. Comput. Sci.* 465 (2012) 10–20.
- [17] H. Lü, H. Zhang, Hyper-Hamiltonian laceability of balanced hypercubes, *J. Supercomput.* 68 (2014) 302–314.
- [18] H. Lü, On extra connectivity and extra edge-connectivity of balanced hypercubes, *Inter. J. Comput. Math.* 94 (4) (2017) 813–820.
- [19] H. Lü, X. Gao, X. Yang, Matching extendability of balanced hypercubes, *Ars Comb.* 129 (2016) 261–274.
- [20] J.-H. Park, H.-C. Kim, H.-S. Lim, Many-to-many disjoint path covers in hypercube-Like interconnection networks with faulty elements, *IEEE Trans. Paral. Distrib. Systems* 17 (3) (2006) 227–240.
- [21] J.-H. Park, H.-C. Kim, H.-S. Lim, Many-to-many disjoint path covers in presence of faulty elements, *IEEE Trans. Comput.* 58 (4) (2009) 528–540.
- [22] C.-H. Tsai, Linear array and ring embeddings in conditional faulty hypercubes, *Theor. Comput. Sci.* 314 (2004) 431–443.
- [23] C.-H. Tsai, J.J. M. Tan, Y.-C. Chuang, L.-H. Hsu, Hamiltonian properties of faulty recursive circulant graphs, *J. Interconnection Networks* 3 (2002) 273–289.
- [24] F. Wang, H. Zhang, Hamiltonian laceability in hypercubes with faulty edges, *Discrete Appl. Math.* 236 (2018) 438–445.
- [25] S. Wang, S. Zhang, Y. Yang, Hamiltonian path embeddings in conditional faulty k -ary n -cubes, *Inform. Sci.* 268 (2014) 463–488.
- [26] J. Wu, K. Huang, The balanced hypercube: a cube-based system for fault-tolerant applications, *IEEE Tran. Comput.* 46 (4) (1997) 484–490.
- [27] M. Xu, H. Hu, J. Xu, Edge-pancyclicity and Hamiltonian laceability of the balanced hypercubes, *Appl. Math. Comput.* 189 (2007) 1393–1401.

- [28] J. Yan, S. Zhang, J. Cai, Fan-type condition on disjoint cycles in a graph, *Discrete Math.* 341 (2018) 1160–1165.
- [29] M. Yang, Bipanconnectivity of balanced hypercubes, *Comput. Math. Appl.* 60 (2010) 1859–1867.
- [30] M. Yang, Conditional diagnosability of balanced hypercubes under the PMC model, *Inform. Sci.* 222 (2013) 754–760.
- [31] M. Yang, Super connectivity of balanced hypercubes, *Appl. Math. Comput.* 219 (2012) 970–975.
- [32] Q. Zhou, D. Chen, H. Lü, Fault-tolerant Hamiltonian laceability of balanced hypercubes, *Inform. Sci.* 300 (2015) 20–27.
- [33] J.-X. Zhou, Z.-L. Wu, S.-C. Yang, K.-W. Yuan, Symmetric property and reliability of balanced hypercube, *IEEE Trans. Comput.* 64 (3) (2015) 876–871.
- [34] J.-X. Zhou, J. Kwak, Y.-Q. Feng, Z.-L. Wu, Automorphism group of the balanced hypercube, *Ars Math. Contemp.* 12 (2017) 145–154.