

# RIBBON INVARIANTS I

SIMEON STEFANOV

## CONTENTS

1. Introduction	2
2. Definition of the main ribbon invariant $\gamma$	4
3. Some arguments about $\gamma$	10
4. Discretization of the ribbon space	21
5. Splitting of ribbons and extensions	24
6. Economic extensions	27
7. The cluster number	32
8. General estimates of $\gamma$	33
9. The ribbon invariants $\gamma_0, \gamma_{\text{ext}}, \gamma_{\text{sad}}$	37
10. Zeroes of gradient fields on $\mathbb{B}^2$	43
11. Geometric restatement of the problem	45
12. A general algorithm for computing $\gamma$	49
13. When does $\gamma = 0$ ?	52
14. Changes of $\gamma$ during elementary moves	58
15. Proof of $\gamma \leq \frac{n}{2} + 1$	62
16. Truncated $C^1$ -ribbons	65
17. Truncated $C^0$ -ribbons	70
18. Estimate for the number of components of the critical set	73
19. The ribbon invariant $\gamma_\infty$ for functions on $\mathbb{R}^2$	75
20. Local and global stability of the critical set	78
21. The ribbon semigroup	79
22. Partial ordering of the ribbon space	85
23. Algebraic ribbon invariants	88
24. Final remarks and open questions	92

---

2010 *Mathematics Subject Classification.* 58K05, 05E99, 26B99.

*Key words and phrases.* critical point, gradient flow, ribbon, multiplicity results.

ABSTRACT. A non-negative integer invariant, estimating from below the number of geometrically different critical points of a smooth function  $f$  defined in the 2-disk,  $f : \mathbb{B}^2 \rightarrow \mathbb{R}$ , is considered. (We denote it by " $\gamma$ " in the text.) It depends on combined  $C^0 + C^1$  type conditions on the boundary  $\partial(\mathbb{B}^2) = \mathbb{S}^1$ , that we call *ribbons* here. It turns out to be an alternative to the degree of the gradient map and almost independent from it. Note that the computation of the degree *does not* guarantee multiple critical points, unlike the ribbon invariant  $\gamma$ . In fact, this invariant is counting the number of essential components of the critical set, rather than simply the number of critical points. Various estimates of  $\gamma$  are established. Some other *ribbon type* invariants of geometrical nature are defined and investigated. All these invariants turn out to be more combinatorial, rather than algebraic, in nature. Algorithms for the calculation of the ribbon invariants are presented. Interconnections with some different areas, such as the theory of immersed curves in the plane or independent domination in graphs, as well as various geometric applications, are commented. The latter topics will be investigated in detail in Part II of the present article. At the end, different questions about  $\gamma$  are asked.

## 1. INTRODUCTION

Let us specify at the beginning that the *ribbons* and *ribbon invariants* under consideration in the present article *do not refer* to ribbon knots or graphs, although there is some visual (geometrical) resemblance with latter objects. Our *ribbons* are simpler and are mainly related to multiplicity results about critical points. In fact, a big part of the material in the paper seems elementary, or even trivial sometimes, and often becomes evident from picture, so we shall omit here and there annoying technical details and appeal to reader's imagination. On the other hand, the main problems seem to be quite hard, as they are not susceptible to any algebraic methods or simple formulas as a rule. Such is for example the central problem with the computation of the main ribbon invariant  $\gamma$ .

We shall start with some key observations that will be justified later in the text.

Let  $f : \mathbb{B}^2 \rightarrow \mathbb{R}$  be a smooth function on the unit disk with a compact set of critical points  $\text{Crit}(f)$  not intersecting the boundary  $\mathbb{S}^1$ . Suppose that the degree of the gradient field  $\nabla f$  along  $\mathbb{S}^1$  is zero:

$$\deg(\nabla f|_{\mathbb{S}^1}) = 0.$$

Then, according to Hopf's Degree Theorem ([1]), the field  $\nabla f|_{\mathbb{S}^1}$  may be extended inside  $\mathbb{B}^2$  to some field  $V$  without zeroes. Now, it is a natural question to ask whether there exists a *gradient* vector field  $V_1$  extending  $\nabla f|_{\mathbb{S}^1}$  without zeroes, in other words, whether the function  $f$  may be extended from some neighbourhood of  $\mathbb{S}^1$  to its interior without critical points. It turns out that in general the answer to this question *is negative!* So, there is a nontrivial problem here! Naturally, it may happen that critical points free extensions exist, but in other cases the number of critical points cannot be reduced under some positive integer limit, depending on the boundary data. This low limit is, roughly speaking, the main "ribbon invariant"  $\gamma$  we deal with in this article. Of course, this invariant is defined for functions with arbitrary integer value of  $\deg(\nabla f|_{\mathbb{S}^1})$ , not only zero. To justify the above observation in this general setting, consider the following situation.

Let  $C = \mathbb{S}^1 \times [1, 2]$  be an annulus and  $f : C \rightarrow \mathbb{R}$  be a smooth function with a critical set  $\text{Crit}(f)$  not intersecting the boundary  $\partial C$ . Let  $\partial C = C_1 \cup C_2$ , where

$C_1 = \mathbb{S}^1 \times \{1\}$  and  $C_2 = \mathbb{S}^1 \times \{2\}$  and suppose that  $\deg(\nabla f|_{C_1}) = \deg(\nabla f|_{C_2})$ . Then, by Hopf's Theorem, the fields  $\nabla f|_{C_1}, \nabla f|_{C_2}$  are homotopic by a *stationary points free* homotopy  $H : C \rightarrow \mathbb{R}$ . Now, it turns out again that there might be no a *gradient stationary points free* homotopy  $H$  connecting the above fields, though any such gradient homotopy should have some minimal number of critical points, which may be greater than zero. Therefore we obtain some integer invariant somehow measuring the *gradient distance* between the fields  $\nabla f|_{C_1}, \nabla f|_{C_2}$  on  $\mathbb{S}^1$  (which is defined, of course, for arbitrary values of  $\deg(\nabla f|_{C_1})$  and  $\deg(\nabla f|_{C_2})$ ). So, in this situation we have a problem with the calculation of this minimal number, yet the answer being not obvious or simple as a procedure at all.

Another curious observation. Let  $f : \mathbb{R}^2 \rightarrow \mathbb{R}$  be a smooth function with bounded set of critical points  $\text{Crit}(f)$ . Suppose that there is a simple closed curve  $\lambda$  surrounding  $\text{Crit}(f)$ , such that  $\deg(\nabla f|_\lambda) = 0$ . Now, let us try to “kill” its critical points by a smooth homotopy (perturbation) with compact support. It turns out again that the number of critical points cannot be reduced under certain limit, contrary to the expectation that we may kill all of them, in view of  $\deg(\nabla f|_\lambda) = 0$ . For example, it is possible to construct a Morse function  $f : \mathbb{R}^2 \rightarrow \mathbb{R}$  with  $\text{Crit}(f)$  consisting of  $k$  local extrema and  $k$  non-degenerate saddles, such that the number of critical points cannot be reduced under  $2k$  by a smooth homotopy with compact support. This contradicts the natural expectation that extrema and saddles may “annihilate” by pairs. And the cause again is the ribbon number *at infinity*  $\gamma_\infty$  of function  $f$  (see [Section 19](#), which is a modification of the main invariant  $\gamma$ ).

There is a simple motivating example in dimension 1.

Let  $f : [a, b] \rightarrow \mathbb{R}$  be a smooth function. Consider the numbers  $d = f(b) - f(a)$ ,  $\alpha = f'(a)$ ,  $\beta = f'(b)$  and suppose they are nonzero. Then, according to the signs of  $d, \alpha, \beta$  one may predict a minimal number  $\Gamma$  of critical points of  $f$ . For example, if  $d > 0, \alpha > 0, \beta > 0$ , then  $\Gamma = 0$ , while if  $d > 0, \alpha < 0, \beta < 0$ , then  $\Gamma = 2$  ([Fig. 1](#)). Here  $d$  may be treated as a  $C^0$ -boundary datum, while  $\alpha, \beta$  are  $C^1$ -boundary data. If  $d = 0$  and we neglect the sign of  $\alpha$  and  $\beta$ , then  $\Gamma = 1$  and this is, of course, Rolle's Theorem. This simple situation raises the question what happens in higher dimensions. The most general question of this kind should be: *Given a manifold  $M$  with boundary  $\partial M$  and a smooth function  $\varphi$  defined in a small neighbourhood of  $\partial M$ , which is critical points free, then what is the biggest number  $\Gamma$  such that any (smooth) extension of  $\varphi, \Phi : M \rightarrow \mathbb{R}$  has at least  $\Gamma$  distinct critical points in  $M$ ?*

As such a (finite) number always exists, we get some integer “invariant”  $\Gamma = \Gamma(\varphi)$ , that gives rise to different questions, such as: how large can  $\Gamma$  be, how to compute it, can we “discretize” the boundary data and, of course, is this invariant “interesting”, in particular, are there consistent examples where  $\Gamma$  may be, more or less, easily found? Another keystone is to show that this invariant *does not hold* from the simple calculation of the degree of the gradient field  $\nabla \varphi|_{\partial M}$ . In fact, as we shall see later, these two numbers are almost independent from each other, except for some obvious inequalities. Yet another significant difference between these is the fact that our invariant is subadditive and combinatorial in nature, unlike the degree, which is an additive algebraic invariant.

Note also that a straightforward generalization of Rolle's Theorem would presume the function  $\varphi$  being defined only on  $\partial M$ , neglecting in such a way the  $C^1$

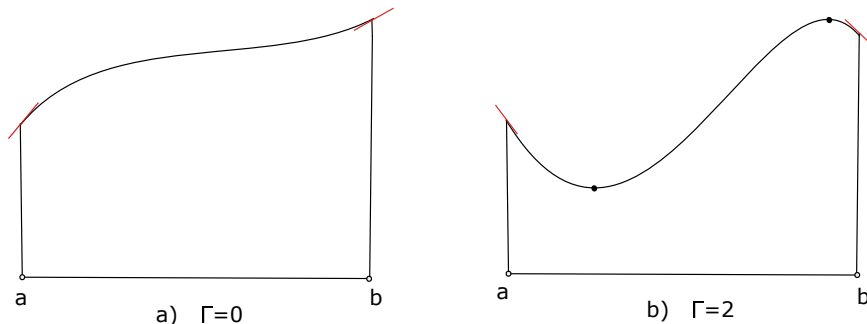

FIGURE 1. 1-dimensional example: a Rolle-type situation.

part of the boundary data. However, as we shall see later, this almost trivializes the problem, as then multiplicity results are not available. On the other hand, taking into account only the  $C^1$ -data and neglecting the  $C^0$ -part of the boundary conditions, may provide us with nontrivial multiplicity results, in some cases (see [Section 16](#)).

We shall suppose for simplicity that  $\varphi|_{\partial M}$  is a Morse function of class  $C^\infty$ ; this allows us, in some cases, to discretize the boundary data. The restriction  $\varphi|_{\partial M}$  may be treated as the  $C^0$ -part of the boundary condition, while the restriction of the gradient  $\nabla\varphi|_{\partial M}$  should be its  $C^1$ -part. Of course, the above question sounds fairly general in this form and we shall focus our attention on the case  $M = \mathbb{B}^2$ , so

*our manifold  $M$  will be the 2-dimensional disk  $\mathbb{B}^2$  from now on.*

This case turns to be difficult and interesting enough for itself.

Let us note that the computation of  $\Gamma$  may be of some practical interest, as we get an estimate from below of the number of *distinct* critical points only from some boundary conditions. From this point of view it is easy to imagine that varying the boundary, we obtain different estimates of this number from below and this allows us in addition to localize the critical set of a function  $f : \mathbb{R}^2 \rightarrow \mathbb{R}$ .

## 2. DEFINITION OF THE MAIN RIBBON INVARIANT $\gamma$

Let  $\varphi : \mathbb{S}^1 \rightarrow \mathbb{R}$  be a Morse function, i.e. a smooth (class  $C^\infty$ ) function with finite number of critical points, all being non-degenerate extrema with different values. Let the extrema be  $p_1, \dots, p_n$ , then  $n$  is an even number. Henceforth, we shall call them “nodes”. We assign to any node  $p_i$  its “sign”  $\nu(p_i) \in \{-1, +1\}$  in an arbitrary manner. If  $\nu(p_i) = +1$ , we say that  $p_i$  is a *positive node* and if  $\nu(p_i) = -1$ , then  $p_i$  is a *negative node*. This information will be the boundary condition of our problem. Now we consider all smooth extensions of  $\varphi$  on  $\mathbb{B}^2$  with prescribed behaviour at  $p_i$ . More precisely, let  $f : \mathbb{B}^2 \rightarrow \mathbb{R}$  be a smooth function such that

- 1)  $f|_{\mathbb{S}^1} = \varphi$
- 2)  $\text{sign}(\nabla f(p_i), p_i) = \pm\nu(p_i)$ , where “+” is taken if  $p_i$  is a local maximum and “-” is taken if  $p_i$  is a local minimum.

Note that condition 2) implies that  $\nabla f|_{\mathbb{S}^1} \neq 0$  everywhere on  $\mathbb{S}^1$ .

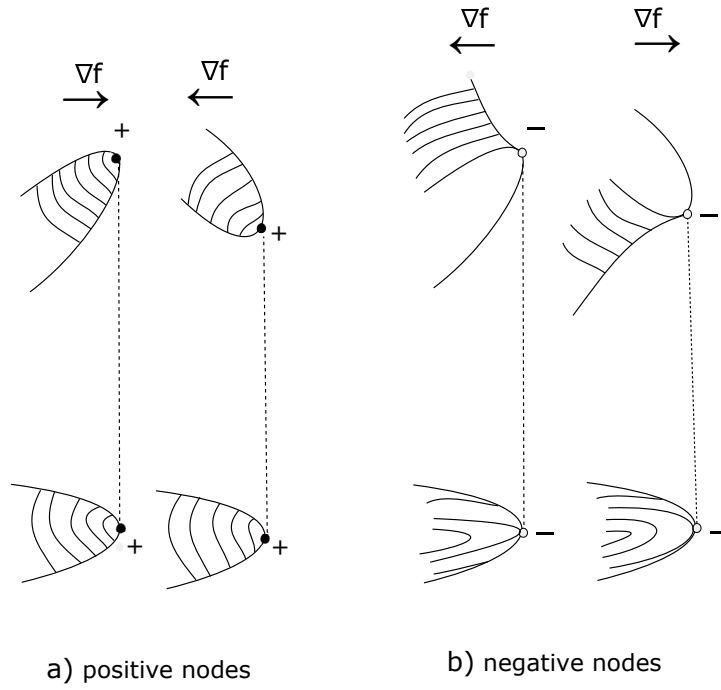

FIGURE 2. Behaviour of extensions at nodes.

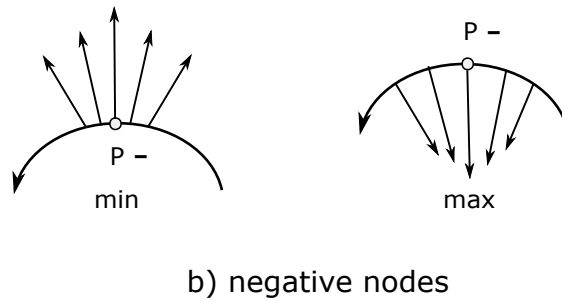
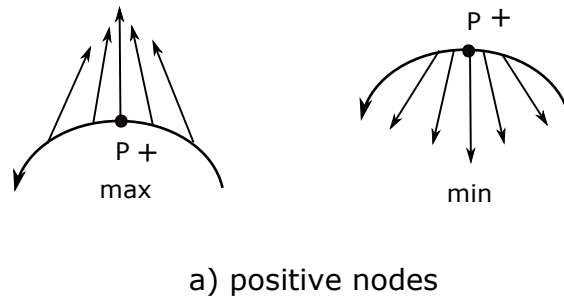

FIGURE 3. Behaviour of the gradient field at nodes.

Fig. 2 illustrates the desired behaviour of the extension  $f$  according to the sign of  $\nu(p_i)$ , while at Fig. 3 the behaviour of the gradient field of  $f$  is depicted. Observe that in a positive node the level lines of  $f$  are touching the boundary  $\mathbb{S}^1$  from outside, while in a negative node, they are touching the boundary from inside. Henceforth, a line which is touching the boundary from inside and is not containing any critical points will be called a *regular touching line*, or simply a *touching line*. Clearly, a touching line may be either a topological segment or a topological circle. So, the boundary conditions include 2 types of data - the function  $\varphi$  ( $C^0$ -data) and the assignment  $p_i \rightarrow \nu(p_i)$  ( $C^1$ -data). The latter means that we have some function  $\nu : P \rightarrow \{-1, +1\}$ , where  $P$  is the set of extrema of  $\varphi$ . For the moment, the boundary condition is the pair  $(\varphi, \nu)$  (later we shall discretize it). In this manner, the boundary condition is a “ribbon type” condition, so it is convenient to name the pair  $(\varphi, \nu)$  a “ribbon”. We may think of *ribbon* as a thin noncritical band situated above  $\mathbb{S}^1$ . Fortunately, this object may be easily discretized, at least for the goals of this article.

**Definition 2.1.** *The pair  $a = (\varphi, \nu)$  is called a “ribbon”. The set  $\mathcal{A}$  of all ribbons will be called “the ribbon space”. The class of functions  $f : \mathbb{B}^2 \rightarrow \mathbb{R}$  satisfying 1) and 2) will be denoted by  $\mathcal{F}(a)$ . We shall often say that  $f$  is an extension of ribbon  $a$ .*

*A ribbon with all nodes being positive will be called a “positive ribbon”. The set of all positive ribbons will be denoted by  $\mathcal{A}^+$ . Similarly is defined the set  $\mathcal{A}^-$  of “negative ribbons”. The set of all ribbons with  $n$  nodes will be denoted by  $\mathcal{A}_n$ .*

It is convenient to consider ribbons up to translation:  $(\varphi, \nu) \sim (\varphi + C, \nu)$  and rotation:  $(\varphi, \nu) \sim (\varphi r_\alpha, \nu)$ , where  $C$  is a constant and  $r_\alpha$  is a rotation at some angle  $\alpha$ . We shall also often denote for simplicity the sign  $\nu(p_i)$  of a node by  $+$  or  $-$ , instead of  $+1, -1$ .

**Remark.** *It is not difficult to show that any ribbon  $a = (\varphi, \nu) \in \mathcal{A}$  is physically realizable by a thin band above  $\mathbb{S}^1$ , thus  $\mathcal{F}(a)$  is a nonempty set.*

Now we give our main definition.

**Definition 2.2.** *Let  $a = (\varphi, \nu) \in \mathcal{A}$  be a ribbon. Then we shall denote by  $\gamma(a)$  the minimal number of critical points of  $f$ , where  $f : \mathbb{B}^2 \rightarrow \mathbb{R}$  varies among all extensions  $f \in \mathcal{F}(a)$ . In such a way, we get some map*

$$\gamma : \mathcal{A} \rightarrow \mathbb{N} \cup \{0\},$$

*that we shall refer to as a “ribbon invariant”.*

Although somewhat tautological, let us emphasize the principal property of the ribbon invariant  $\gamma$ :

*For a given ribbon  $a = (\varphi, \nu)$ , any its extension  $f \in \mathcal{F}(a)$  has at least  $\gamma(a)$  critical points. There is an extension with exactly  $\gamma(a)$  critical points.*

Note that all the critical points of an extension realizing  $\gamma$  should be of nonzero index, since a critical point of index 0 may be “killed” by a small perturbation not disturbing the other critical points of  $f$ .

Let us make some clarifying remarks. First, it is easy to see that  $\gamma(a)$  always exists, as there are extensions satisfying 1) and 2) with finite number of critical points. In such a way, the above definition of  $\gamma$  is more a notation, rather than a “true” definition. Second,  $\gamma(a)$  is the minimal number of *geometrically distinct*

critical points, without taking care about their indices. (Note that the calculation of the degree  $\nabla f|_{\mathbb{S}^1}$  may provide us with at most 1 critical point, in case it is nonzero.) And third, the definition of  $\gamma$  makes sense equally for ribbons, which are not in general position and may have coinciding critical values. For now, we shall not consider such ribbons, unless the opposite is specified. It turns out that for such ribbons almost all the theory of general position ribbons remains valid. These appear in a natural way when performing a generic homotopy of a ribbon.

From now on, “ $n$ ” will stay for the number of nodes of the ribbon under consideration.

Now we list in advance some facts about the ribbon invariant  $\gamma$ .

a)  $\gamma$  takes the same value on any two *similar* ribbons (Section 4), legitimating in such a way the term “invariant”. This also allows us to “discretize” the problem and to attack it algorithmically.

b)  $\gamma$  is attained on a set of quite simple and natural extensions that we call here “economic” extensions (Section 6). This is the key tool for its investigation, as the economic extensions of a given ribbon are finite in number, up to combinatorial equivalence.

c) the ribbon invariant satisfies some basic inequalities:

$$1) 0 \leq \gamma \leq \frac{n}{2} + 1$$

Let  $s_+$  and  $s_-$  be the number of positive and negative nodes, respectively. Consider the *signature*  $\sigma = s_+ - s_-$  (it is an even number). Then we have

$$2) 1 - \frac{\sigma}{2} \leq \gamma \leq n - 1 - \frac{\sigma}{2}.$$

Inequalities 1) and 2) are proved in Section 15 and Section 8, respectively. Somewhat paradoxically, 1) turns out to be much harder than 2). Note also that 1) and 2) immediately imply that in  $\mathcal{A}^-$  we have  $\gamma = \frac{n}{2} + 1$ . This follows from the fact that  $\sigma = -n$  in  $\mathcal{A}^-$ . On the other hand, the class of positive ribbons  $\mathcal{A}^+$  turns out to be much more intriguing and complicated, unlike the class of negative ribbons  $\mathcal{A}^-$ , where everything is clear from point of view of ribbon invariants.

d) no simple formulas or procedures for the computation of  $\gamma$  are known to us. We shall present in Section 12 a “brute force” ramifying algorithm for its computation, which seems to be quite slow as  $n$  grows. Probably, the problem of computation of  $\gamma$  is NP-hard. However, in some extremal cases the ribbon invariant will be exactly computed by direct estimations.

The calculation of  $\gamma$  is hard enough even in  $\mathcal{A}^+$ . In Part II of the article we shall present an algorithm based on the reduction of positive ribbons to either a *ladder* or an *alternation* by elementary moves. (These are two extremal opposite cases of ribbons, see next section.) Then we make use of the fact that the ribbon invariant of ladders and alternations is quite easily computable, while at each move we may say by how many  $\gamma$  changes. This is much faster than the “brute force” algorithm. Moreover, this method finds the set of *all* minimal extensions of a ribbon  $a \in \mathcal{A}^+$ . Furthermore, we shall discuss a similar algorithm in  $\mathcal{A}$ , where much more variants are available.

e) the set of discrete ribbons of rank  $n$  is quite large (for big  $n$ ). Its cardinality and asymptotics are computed in Section 4. This is one of the reasons for the difficulties with the computation of  $\gamma$ , at least for the “brute force” algorithm described in Section 12. The other two main obstacles are the *subadditivity* of  $\gamma$  and the fact that it takes only non-negative values, so we can hardly expect it being algebraic in nature. Consider for example the situation from Fig. 4, where some

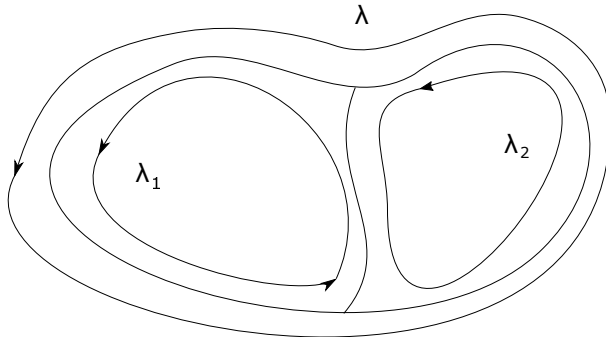

$$\gamma(\lambda) \leq \gamma(\lambda_1) + \gamma(\lambda_2)$$

FIGURE 4.  $\gamma$  is subadditive.

function  $f$  is supposed to be defined in a region of the picture and let us identify, for a moment, each curve with the *induced ribbon* in a small region on it. Then it turns out that  $\gamma(\lambda) \leq \gamma(\lambda_1) + \gamma(\lambda_2)$ , where strict inequality is possible, while for the degree  $i(\lambda) = \deg(\nabla f|_\lambda)$ , one has  $i(\lambda) = i(\lambda_1) + i(\lambda_2)$  and this is one of the main differences between the ribbon invariant and the degree. Note also that strict inequality for  $\gamma$  is much more likely than equality.

f)  $\gamma$  gives in fact an estimate from below for the number of essential *components* of the critical set of an arbitrary extension, rather than only for the number of critical points. So, any extension of a given ribbon  $a$  has at least  $\gamma(a)$  components of its critical set, each one of nonzero index (Section 18).

g) the invariant  $\gamma$  has some “stability” properties, for example, it is true that for any  $m > 0$  there is  $d > 0$  such that if  $\|\nabla f\| < m$  for an extension  $f \in \mathcal{F}(a)$ , then there exist  $\gamma$  critical points of  $f$ ,  $p_1, \dots, p_\gamma$  such that  $|p_i - p_j| \geq d$  for  $i \neq j$ . So we may say that there are  $\gamma$  critical points *distant* from each other. The same is true for the components of the critical set with respect to the Hausdorff distance. Global stability properties under homotopy of the ribbon invariant are discussed later (Section 20).

h) there are some relationships of the ribbon invariant  $\gamma$  with other areas, such as the theory of immersed curves in the plane (the problem of self-overlapping) or independent domination in graphs. In Part II some relation between  $\gamma$  and the problem of recognition of self-overlapping curves in the plane (see [3]) is established. Therein, a geometric invariant of immersed curves is defined by means of  $\gamma$ . Furthermore, it is shown that the economic extensions of a given ribbon  $a$  are in one-to-one correspondence with the maximal independent subsets of some so-called *critical graph*  $G$  associated with  $a$ , and that the (weighted) *independent domination number* of  $G$  equals the ribbon invariant  $\gamma(a)$ . Varying the weight system, we may obtain in such a manner description of the other ribbon invariants of *geometric* nature.

i) note also that besides  $\gamma$ , we consider here some other “ribbon type” invariants -  $\gamma_0$ ,  $\gamma_{\text{ext}}$ ,  $\gamma_{\text{sad}}$  defined in Section 9. Like  $\gamma$ , they are counting critical points, but



in different geometrical context. All these invariants may be computed by one and the same algorithm (up to some initial normalization).

j) finally, in [Section 21](#) we consider two natural algebraic operations in the class  $\mathcal{A}$  of rigid ribbons, getting in such a way some algebraic object, we refer to as the *ribbon semigroup*. Then we define axiomatically the *algebraic* ribbon invariants similarly to the F-invariant (Lusternik-Schnirelmann) approach to critical points problems. It is shown by examples that the class of such invariants is quite large. Moreover, it turns out that  $\gamma$  is the supremum of all algebraic ribbon invariants satisfying the corresponding normalization conditions. This is equally valid for the other 3 ribbon invariants of geometric origin, we deal in the present article.

As for the methods for proving things in the article, we should note that these are elementary in nature and do not involve any complicated machinery. Among others, there is one central natural method - *splitting* a ribbon into simpler pieces, which allows one to prove things by induction on some natural lexicographic order defined in the ribbon class  $\mathcal{A}$ .

We shall consider further another invariant  $\beta$  estimating from below the number of different *critical values* of an extension, rather than the number of critical points.

**Definition 2.3.** *Let  $a = (\varphi, \nu) \in \mathcal{A}$  be a ribbon. Then we shall denote by  $\beta(a)$  the minimal number of critical values of  $f$ , where  $f : \mathbb{B}^2 \rightarrow \mathbb{R}$  varies among all extensions  $f \in \mathcal{F}(a)$ .*

Clearly,

$$\gamma(a) \geq \beta(a).$$

It turns out that  $\beta$  is a *ribbon invariant* as well, in the sense that it satisfies some natural subadditivity conditions ([Section 23](#)). It is clear that in fact  $\beta$  is estimating the number of values of the critical points which are *not* local extrema, since one may occupy no more than 2 values for all local extrema. So, in the case of finite number of critical points,  $\beta$  is estimating from below the number of values of saddle points of  $f$ . On the other hand, in class  $\mathcal{A}^+$ ,  $\beta$  is equal to the *cluster number* of the corresponding ribbon (the latter defined in [Section 7](#)). As in many cases the cluster number may be easily found (estimated), we get an “easy” estimate from below of  $\gamma$  via the inequality  $\gamma \geq \beta$ .

Looking for interconnections between our investigations and some well-known area, we shall note a direct analogy between the ribbon invariant  $\gamma$  and the so-called *F-invariant* which is aiming similar multiplicity results.

### Parallel with the F-invariant and Lusternik-Schnirelmann problems.

Recall in brief the definition of the F-invariant (see [\[5\]](#)) and some basic facts about it.

Let  $M$  be a compact  $n$ -dimensional smooth manifold (with or without boundary). Then  $F(M)$  is the minimal number of critical points of maps  $f : M \rightarrow \mathbb{R}$ , where  $f$  varies among the class of all smooth functions. Clearly, like  $\gamma$ , this is more a notation rather than a “true” definition, since this (finite) number exists by itself. Then come the difficulties with the computation of  $F(M)$  and  $\gamma$ . It turns out that the exact computation is quite hard, so it is convenient to look for some consistent estimates from below. In the case of  $F(M)$  there are two nice such invariants - the Lusternik-Schnirelmann *category* and *cup length*.

For a given space  $X$ , its Lusternik-Schnirelmann category  $\text{cat}(X)$  is the least number  $k$ , such that  $X$  may be decomposed into  $k$  (closed) subsets  $F_1, \dots, F_k$  so that the  $F_i$ 's are ambient contractible in  $X$  into a point.

The cup length of  $X$  is the greatest number  $m$  such that there exist  $a_1, \dots, a_m \in H^*(X)$  for which  $a_1 \cup \dots \cup a_m \neq 0$ . (Here  $H^*(X)$  is the cohomologies ring of  $X$ .) Then we set  $\text{length}(X) = m$ . Note that in many cases the cup length may be effectively calculated.

It is a basic fact that for a closed manifold  $M$

$$F(M) \geq \text{cat}(M) \geq \text{length}(M) + 1,$$

where strong inequalities are possible, as examples show. However, in many interesting cases all these 3 numbers coincide, so it is, more or less, easy to calculate  $F(M)$ . For example,  $F(\mathbb{R}P^n) = F(\mathbb{C}P^n) = F(\mathbb{T}^n) = n + 1$  and  $F(M^2) = 3$ , for any closed 2-surface of genus  $\geq 1$ , which follows from the direct calculation of the cup length.

Similarly to the  $F$ -invariant, the ribbon invariant  $\gamma$  is pretty hard to be exactly calculated, anyway, there are some ‘‘a priori’’ estimates from below:

$$\gamma \geq \delta_0, \quad \gamma \geq i - 1 - \frac{\sigma}{2} \text{ in } \mathcal{A}, \quad \gamma \geq \delta \text{ in } \mathcal{A}^+.$$

(See [Section 7](#) for the definition of the cluster numbers  $\delta$  and  $\delta_0$ .) Note that the latter inequalities are not so good and there might be a large gap between the corresponding values. So, it would be interesting to find some effectively calculable invariant which gives a consistent estimate from below of  $\gamma$ .

As for estimations from above (not so interesting, though), yet there is some analogy between the  $F$ - and the  $\gamma$ - invariant.

- 1) If  $M$  is a compact  $n$ -dimensional manifold, then a)  $F(M) \leq n$ , if  $\partial(M) = \emptyset$ ,  
b)  $F(M) \leq n - 1$ , if  $\partial(M) \neq \emptyset$ .
- 2) For any ribbon  $a \in \mathcal{A}_n$  it holds that  $\gamma(a) \leq \frac{n}{2} + 1$  (see [Section 15](#)).

### 3. SOME ARGUMENTS ABOUT $\gamma$

We shall give here some simple examples and arguments justifying our interest in the ribbon invariant.

**0.** First of all, let us see what happens for  $n = 2$  and  $n = 4$ . This may be done ‘‘by hand’’.

For  $n = 2$  there are 4 ribbons (up to *similarity*) with 3 possible values of  $\gamma$  equal to 0, 1 and 2. The corresponding cases, with the corresponding minimal solutions, are depicted at [Fig. 5](#). The most simple ribbon  $(1^+, 2^+)$  with  $\gamma = 0$  is called by us a ‘‘minimal ribbon’’ ([Fig. 5-a](#)). Albeit elementary, it is important for the *ribbon semigroup* defined in [Section 21](#). It is the minimal element in the ordered set of discrete ribbons (see next section).

For  $n = 4$  there are 32 ribbons (up to similarity) with possible values of  $\gamma$  equal to 0, 1, 2 and 3. Three of them are shown at [Fig. 6](#). At [Fig. 7](#) we give the level portrait of a ‘‘good’’ extension of some ribbon  $a \in \mathcal{A}_4^-$  with 5 critical points, that does not realize the ribbon invariant, since later we show that  $\gamma(a) = 3$  for any ribbon from  $\mathcal{A}_4^-$ . The corresponding solution is given at [Fig. 8](#).

Let us make a practical convention: *From now on, in examples, we shall denote for simplicity a ribbon  $a = (\varphi, \nu)$  in a following manner: If  $l_i = \varphi(p_i)$  are the level*

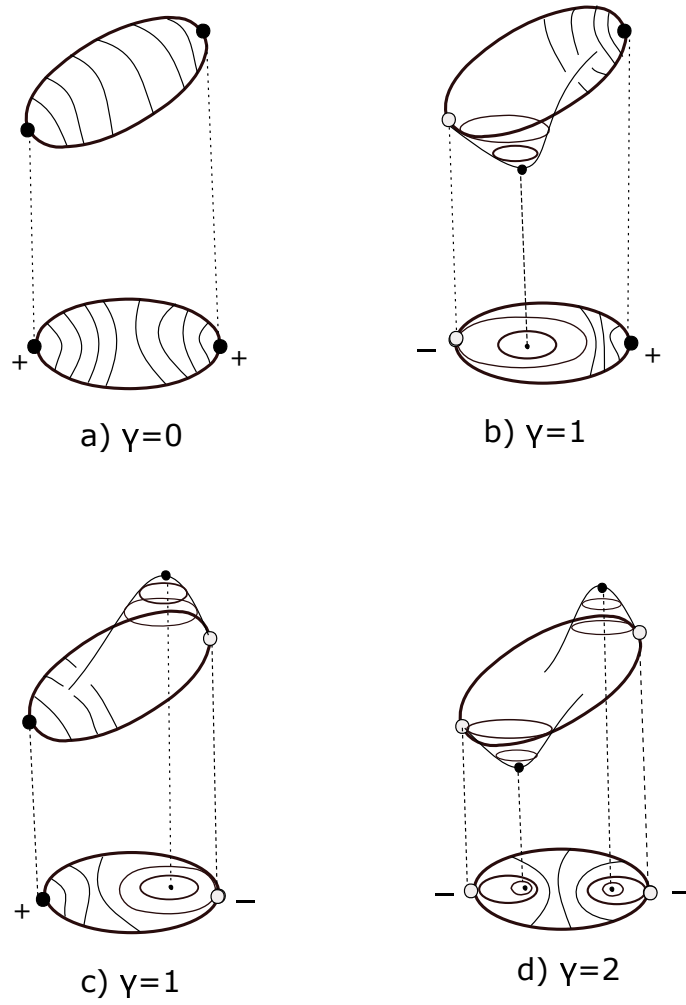

FIGURE 5. Ribbons with 2 nodes and the minimal extensions.

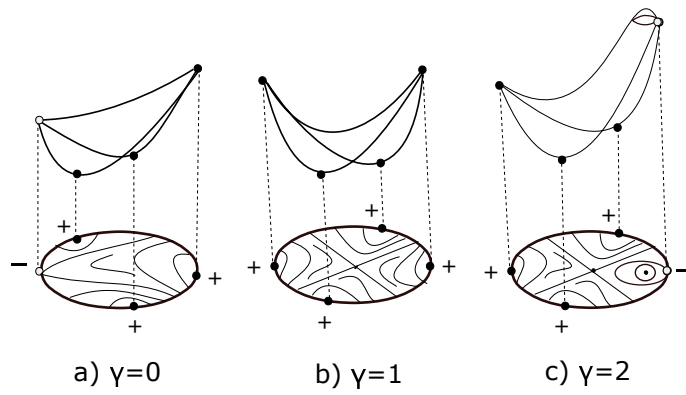
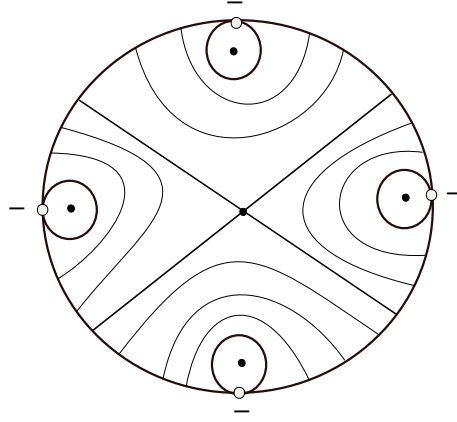
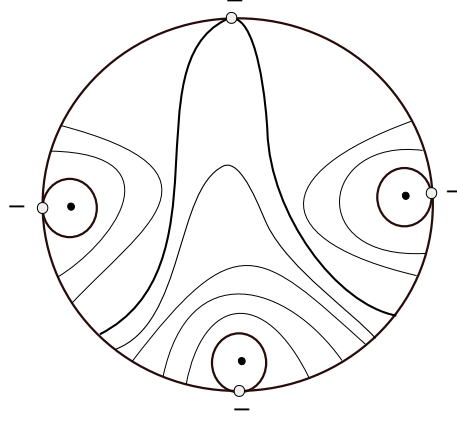

FIGURE 6. Some ribbons with 4 nodes.

FIGURE 7. An extension with 5 critical points not realizing  $\gamma = 3$ .FIGURE 8. The solution  $\gamma = 3$  in  $\mathcal{A}_4^-$ .

nodes, then we shall write

$$a = (l_1^{\nu(p_1)}, \dots, l_n^{\nu(p_n)}),$$

for example, we shall write things like  $a = (1^+, 3^-, 2^+, 4^+)$  and this will be enough for identifying the ribbon.

Furthermore, as it is a little bit hard to depict complex ribbons by their graph like in Fig. 6, we adopt some simpler schematic way to represent them linearly as in Fig. 19. Positive nodes are depicted by black dots, negative - by white ones. In order to link easily the ribbon with the corresponding level lines portrait of some extension, we number the nodes monotonically:  $(1, 2, 3, 4, 5, 6)$ , and, of course, this is **not** the zig-zag permutation expressing the  $C^0$ -part of the ribbon.

**1.** An almost trivial observation: Let  $a = (\varphi, \nu)$  be a ribbon such that  $\varphi$  attains its minimum and maximum at nodes  $p$  and  $q$ , respectively, and  $p$  and  $q$  are negative nodes (Fig. 9). Then  $\gamma(a) \geq 2$ , as any extension  $f$  of  $\varphi$  should have both a global minimum and maximum inside  $\mathbb{B}^2$ . This situation is analogous to the 1-dimensional one depicted at Fig. 1-b). We shall call, up to some inaccuracy,  $p$  and  $q$  *minimal*

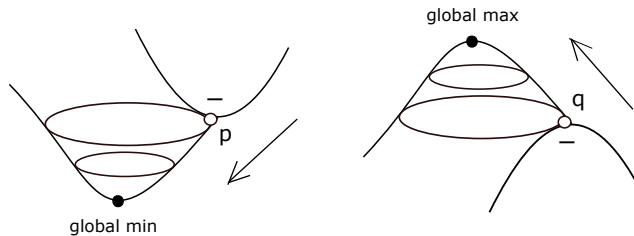

FIGURE 9. Situations of a forced global extremum.

and *maximal* nodes of the ribbon. It turns out that, in aiming the calculation of  $\gamma$ , we may restrict ourselves to the case of positive minimal and maximal nodes, as we may replace any such negative node by a positive one and then  $\gamma$  decreases by 1. More precisely, if  $a'$  is the ribbon obtained from  $a$  by *making* the minimal and maximal nodes  $p$  and  $q$  positive, then

$$\gamma(a') = \gamma(a) - \varepsilon,$$

where  $\varepsilon$  is the number of negative nodes among  $p, q$  ( $\varepsilon = 0, 1, 2$ ). However, we do *not* suppose the minimal and maximal nodes being positive from now on. This assumption will be useful when defining the “connected sum” of two ribbons (Section 21).

**2.** Another simple, but useful observation. Let  $n \geq 4$ , the nodes  $p_i$  are cyclically ordered on  $\mathbb{S}^1$  and  $p_i, p_{i+1}$  are two consecutive *positive* nodes. Suppose that the segment  $[\varphi(p_i), \varphi(p_{i+1})]$  does not contain any *level*  $\varphi(p_j)$ , where  $p_j$  varies among all *negative* nodes. Then any extension  $f$  of  $\varphi$  has a critical point  $x \in \mathbb{B}^2$ , such that  $f(x) \in [\varphi(p_i), \varphi(p_{i+1})]$ . To see this, it suffices to observe that supposing the contrary, then each level line of  $f$  starting from a point of the arc  $(p_i, p_{i+1})$  should finish somewhere on  $\mathbb{S}^1$  at a point different from a node (Fig. 10) and thus intersecting transversely  $\mathbb{S}^1$ . Now the simple flow-box and continuity argument implies that there are no other nodes except  $p_i, p_{i+1}$  which contradicts the assumption  $n \geq 4$ . So, there is a critical point  $x \in \mathbb{B}^2$  which is “attached” to the segment  $[p_i, p_{i+1}]$ . Note that  $x$  cannot be a local extremum of  $f$ , so, in case  $f$  has a finite number of critical points,  $x$  is either a saddle (possibly degenerated), or a non essential singularity. The latter will be discussed in Section 6. Note also that there might be many different saddles “attached” to  $[p_i, p_{i+1}]$  (see Fig. 12).

The above argument allows one to construct easily ribbons with big ribbon invariant  $\gamma$ . Here is a basic example relying on this observation.

**3. Ladders.** Consider a ribbon  $a \in \mathcal{A}$  of the form

$$a = (1^\pm, 3^\pm, 2^\pm, 5^\pm, 4^\pm, 7^\pm, \dots, (n-2)^\pm, n^\pm),$$

where the signs  $\pm$  are arbitrarily chosen from the set  $\{+, -\}$ . This situation for  $n = 8$  is schematically depicted at Fig. 11. We shall call such a ribbon a *ladder*. It turns out that the ribbon invariant  $\gamma$  of a ladder is very easy to calculate (see Section 12, Proposition 12.4). If the ladder  $a$  has only positive nodes ( $a \in \mathcal{A}^+$ ), we say that  $a$  is a *positive* ladder. Then the above remarks imply that for an arbitrary

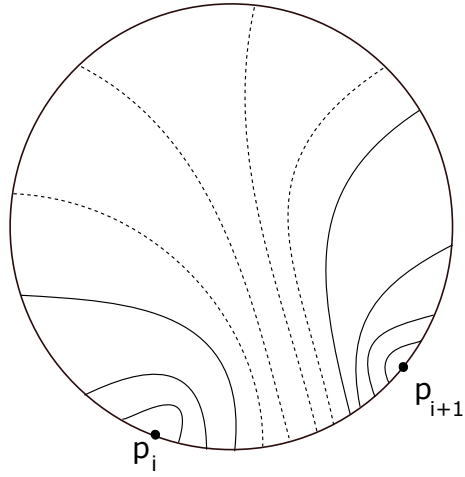

FIGURE 10. There should be some critical point here, as  $n \geq 4$ .

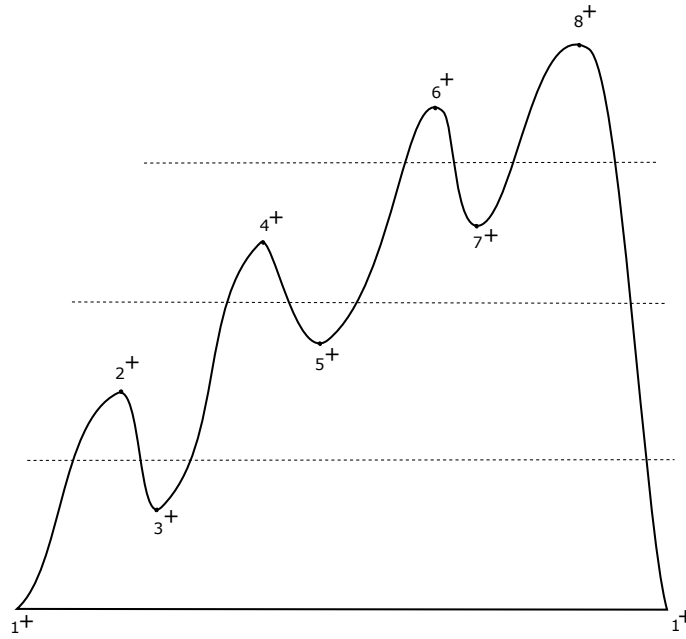

FIGURE 11. A positive ladder.

extension  $f$  of a positive ladder, any of the segments  $(2, 3), (4, 5), \dots, (n-2, n-1)$  contains a critical level of  $f$ . But the number of all such segments is  $\frac{n}{2} - 1$  and since they are disjoint, it follows that  $f$  has at least  $\frac{n}{2} - 1$  distinct critical points. Therefore for this ribbon we have  $\gamma(a) \geq \frac{n}{2} - 1$ . It is easy to see that in fact

$$\gamma(a) = \frac{n}{2} - 1.$$

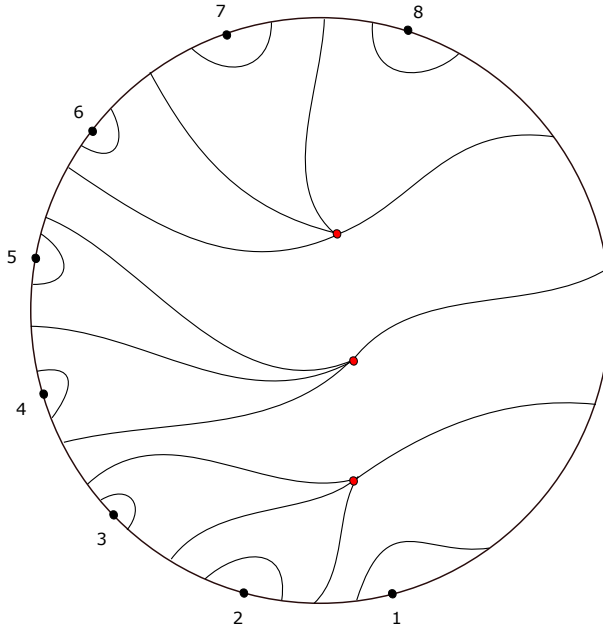

FIGURE 12. The solution,  $\gamma = 3$ .

The level lines picture of the corresponding extension is shown at Fig. 12. It has 3 non-degenerate saddles. Later we shall see that a positive ladder has only one “good” solution with  $\frac{n}{2} - 1$  nondegenerate saddles. Note that there are different variants of the ladder - see for example Fig. 13, where a two-sided positive “ladder” (with missing steps!) is depicted. The level portrait of an extension realizing  $\gamma$  for this ribbon is shown at Fig. 14. Furthermore, at Fig. 15 some general ladder is drawn and a corresponding solution  $\gamma = 2$  is shown at Fig. 16. For all these variations, in the positive case, we have  $\gamma = \frac{n}{2} - 1$ . It is not hard to see that the combinatorial number of positive ladders with  $n$  nodes is  $2^{\frac{n}{2}-1}$ , whereby the number of all (general) ladders equals  $2^{\frac{3n}{2}-1}$ .

So, let us give an exact definition of a ladder: A ribbon  $a = (\varphi, \nu) \in \mathcal{A}$  with  $n \geq 4$  nodes is a *ladder*, if for any critical value  $c$ , different from the global minimal and maximal ones, we have

$$|\varphi^{-1}(c)| = 3.$$

This definition covers all types of “ladders”. (An alternative definition is to say that for any noncritical value  $c$  we have  $|\varphi^{-1}(c)| \leq 4$ .) As we noticed above, the ribbon invariant  $\gamma$  of all ladders is completely computable (Proposition 12.4).

Ladders have another useful property: Let  $a = (\varphi, \nu) \in \mathcal{A}_n$  be an arbitrary ribbon and  $b = (\varphi', \nu) \in \mathcal{A}_n$  be a ladder with the same number of nodes and the same marking  $\nu$ . Then for any extension  $f$  of  $b$  there is an extension  $g$  of  $a$  with exactly the same level lines portrait as  $f$ . Ladders are also crucial for the “fast” algorithm for the calculation of  $\gamma$  and the other ribbon invariants (Part II).

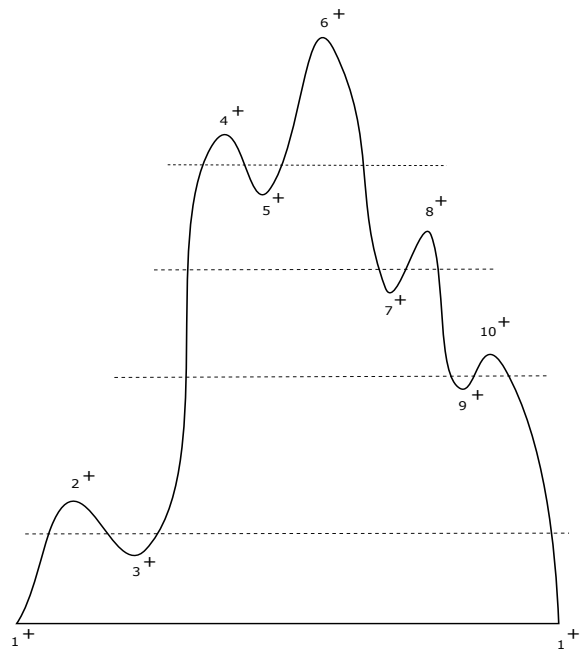
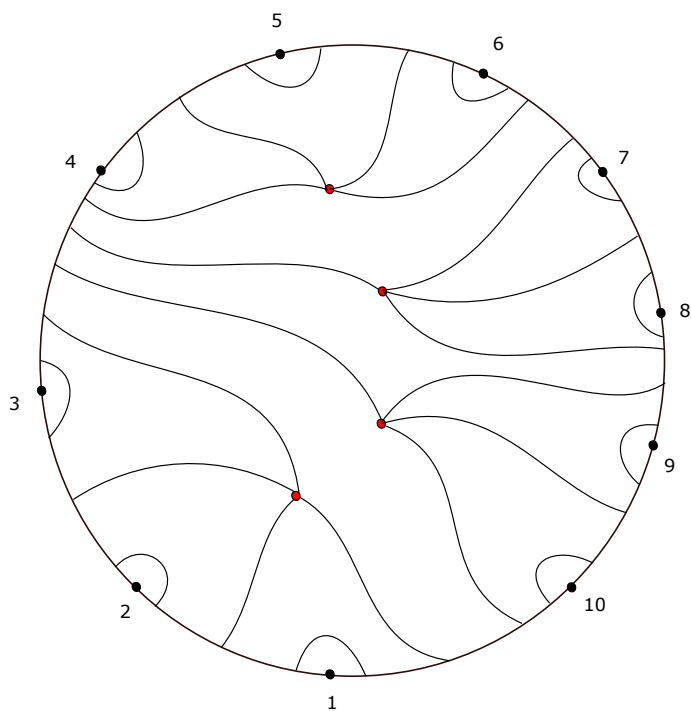

FIGURE 13. Two - sided positive ladder.

FIGURE 14. The solution,  $\gamma = 4$ .



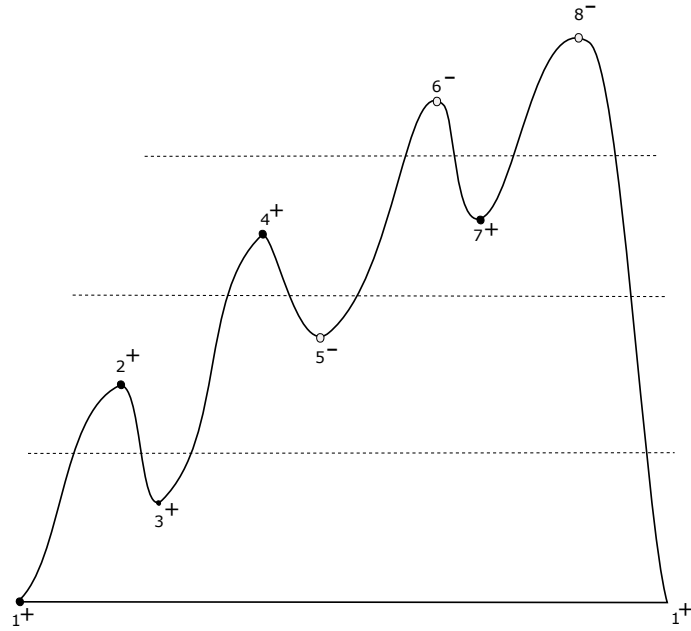

FIGURE 15. A general ladder.

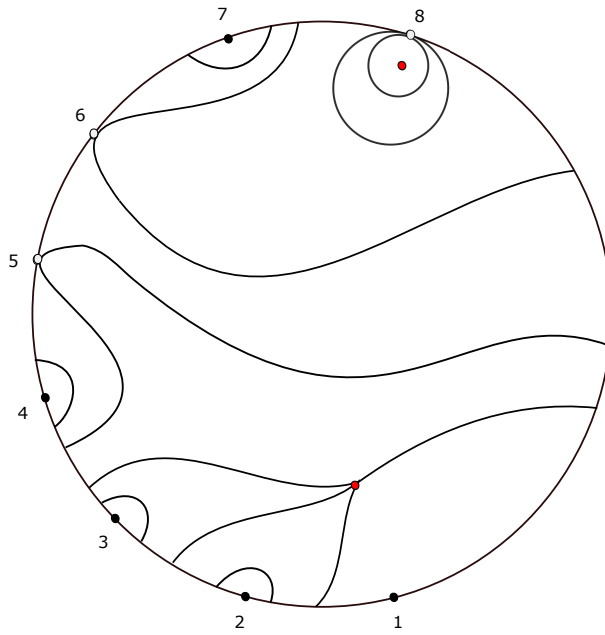

FIGURE 16. A solution  $\gamma = 2$  for the ribbon from Fig. 15.

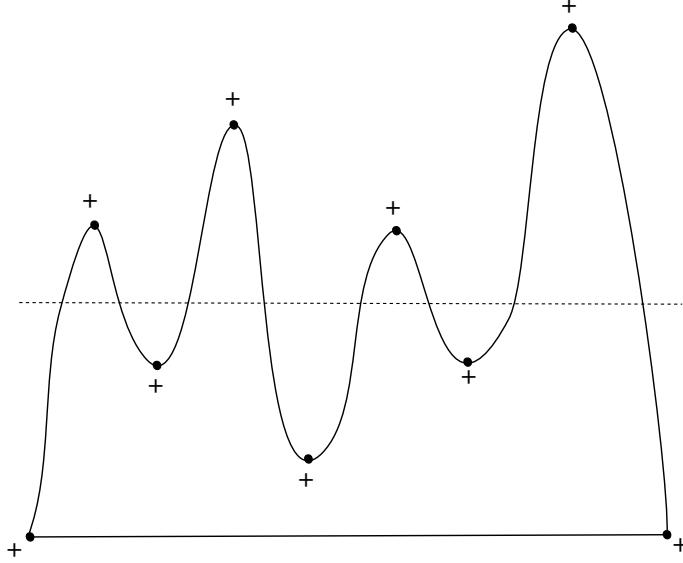

FIGURE 17. An alternation (always supposed positive).

**4. Alternations.** Consider a ribbon  $a$  with only positive nodes ( $a \in \mathcal{A}^+$ ) and node levels  $l_i = \varphi(p_i)$  such that

$$\bigcap_{i=1}^{n-1} [l_i, l_{i+1}] \neq \emptyset.$$

Let  $n \geq 4$ . We shall call such a ribbon *alternation* (by analogy with functions oscillating between two values). An example of an alternation is shown at Fig. 17. It turns out that for an alternation  $a$  we have

$$\gamma(a) = 1.$$

Indeed, take some  $\alpha \in \bigcap_{i=1}^{n-1} [l_i, l_{i+1}]$ , then for any maximal node  $p_i$  we have  $l_i = \varphi(p_i) > \alpha$  and for any minimal node  $p_i$ ,  $l_i = \varphi(p_i) < \alpha$ . Now, one finds an extension  $f$  with only one critical level  $\alpha$  and an unique saddle-type critical point  $P$  (Fig. 18). For  $n = 4$  the saddle  $P$  is non degenerate, while for  $n > 4$ ,  $P$  is a degenerate saddle. As in the case of ladders, we shall consider *general* alternations, that is, alternations with arbitrary marking of the nodes. A not very complicated calculation shows that the number of (positive) alternations with  $n$  nodes equals  $(\frac{n}{2})! (\frac{n}{2} - 1)!$ , so the number of general alternations is  $2^n (\frac{n}{2})! (\frac{n}{2} - 1)!$ . Let us note that for general alternations the invariant  $\gamma$  is not at all easily computable, unlike the case of ladders. In some sense, in class  $\mathcal{A}^+$ , ladders and alternations are two opposite extremal cases from point of view of the ribbon invariant  $\gamma$ . As we shall see later, all the positive alternations with the same number of nodes  $n$  may be somehow treated as one and the same ribbon  $\beta_n$ . In particular, many ribbon invariants take one and the same value on any ribbon from  $\beta_n$  and belongs to the set of *irreducible* (elementary) ribbons (see Section 23).

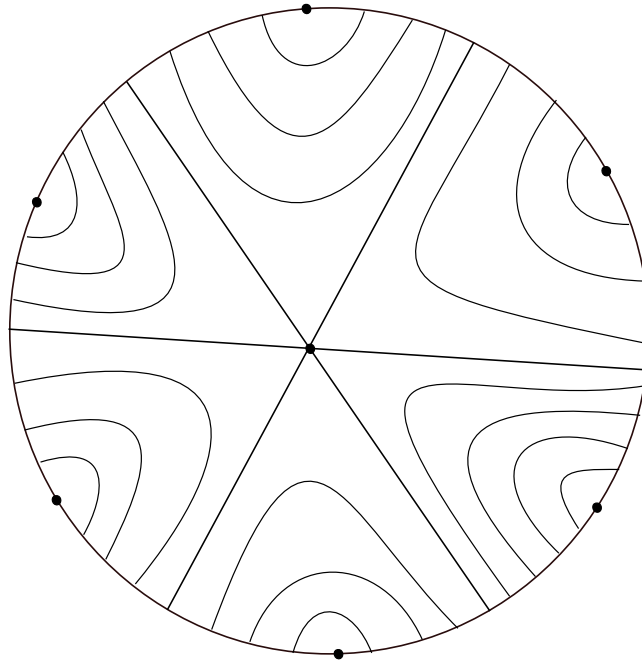

FIGURE 18. The solution for an alternation,  $\gamma = 1$ .

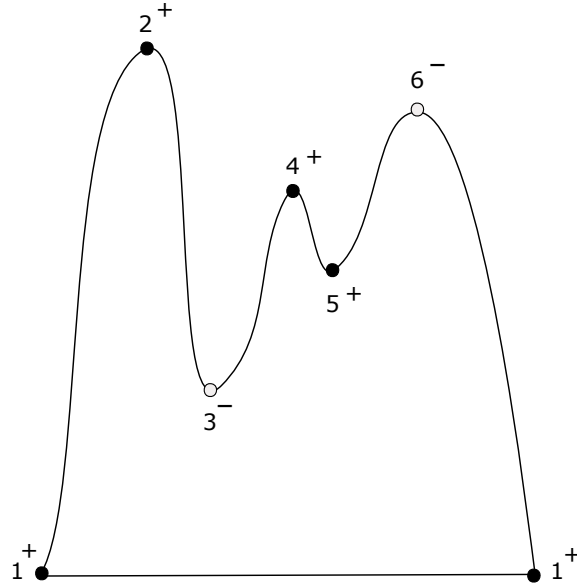

FIGURE 19. The ribbon  $a = (1^+, 6^+, 2^-, 4^+, 3^+, 5^-)$ .

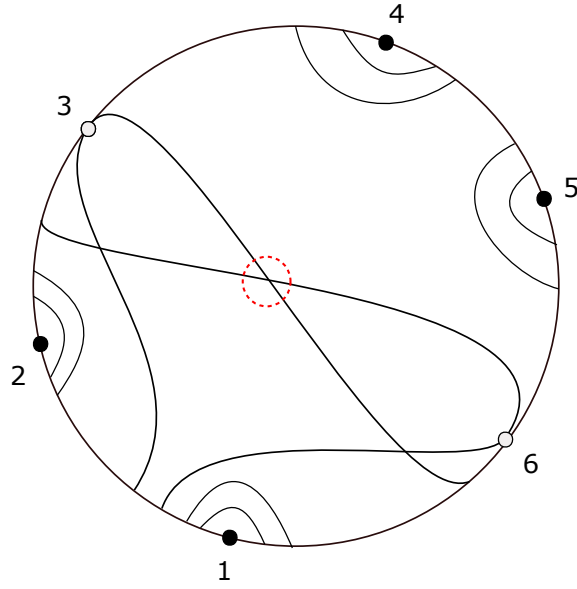
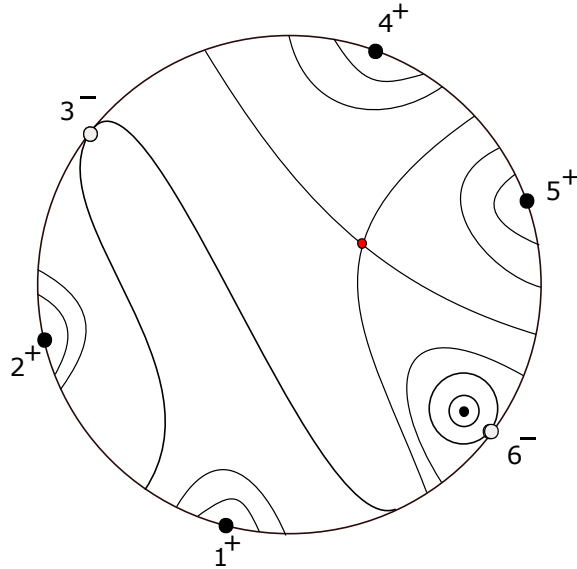

FIGURE 20. Nodes 3 and 6 are in conflict.

FIGURE 21. A solution,  $\gamma = 2$ .

5. The following example illustrates the introductory remarks. Consider the ribbon  $a = (1^+, 6^+, 2^-, 4^+, 3^+, 5^-)$ . It is shown at Fig. 19. Since the signature  $\sigma = s_+ - s_- = 4 - 2 = 2$ , it follows that for any extension  $f$  of  $a$  we have  $\deg(\nabla f|_{\mathbb{S}^1}) = 0$  and is due to the fact that  $\deg(\nabla f|_{\mathbb{S}^1}) = 1 - \frac{\sigma}{2}$ . So, the expectation is that there is some extension without critical points, i.e.  $\gamma(a) = 0$ . But it turns in fact that  $\gamma(a) > 0$  (actually  $\gamma(a) = 2$ )! Indeed, the segment  $[4, 3]$  has positive ends and

does not contain levels of negative nodes. Then, according to remark 2 of the present section,  $f$  should have a critical point. There is another purely geometrical argument: Suppose that there is a critical points free extension and consider the corresponding level lines portrait. Then the level lines passing through the negative nodes  $2^-$  and  $5^-$  should finish in a single way somewhere on the boundary, but it is easy to see that, by Jordan's Separation Theorem, they are in conflict (see Fig. 20) and thus have to intersect, which is a contradiction. A minimal extension with 2 critical points solving the problem is shown at Fig. 21. Note that there is yet another combinatorially different solution.

#### 4. DISCRETIZATION OF THE RIBBON SPACE

It is natural first to consider ribbons up to "similarity", as it is almost clear that  $\gamma$  takes the same value on any two *similar* ribbons.

**Definition 4.1.** *Two ribbons  $a = (\varphi, \nu)$  and  $a' = (\varphi', \nu')$  are said to be similar, if there is an orientation preserving diffeomorphism  $\psi : \mathbb{S}^1 \rightarrow \mathbb{S}^1$  such that*

- 1)  $\psi$  is sending the critical points set of  $\varphi$  onto the critical points set of  $\varphi'$ :  $\psi(p_i) = p'_i$ , preserving their type (minimum or maximum)
- 2)  $\nu(p_i) = \nu'(p'_i)$
- 3)  $\psi$  is preserving the critical levels order:

$$(\varphi(p_i) - \varphi(p_j))(\varphi'(p'_i) - \varphi'(p'_j)) > 0 \text{ for } i \neq j.$$

It is clear that two similar ribbons  $a, a'$  are identical from combinatorial/topological point of view, so  $\gamma(a) = \gamma(a')$ . We shall denote the similarity classes by  $\mathcal{A}_0$ . We shall call the elements of  $\mathcal{A}_0$  "soft" ribbons and the elements of  $\mathcal{A}$  - "rigid" ribbons. It is clear that  $\mathcal{A}_0$  is countable and of combinatorial essence. So, it is natural to identify it with some purely combinatorial structure, discretizing in such a way the problem.

It turns out that the so called *zig-zag permutations* are the appropriate combinatorial tool for studying the ribbon invariant, as they model the alternation "min-max" of the boundary data.

**Definition 4.2.** *Let  $(c_1, c_2, \dots, c_n)$  be a permutation of the numbers  $\{1, 2, \dots, n\}$ . Then it is called zig-zag permutation, if its entries alternately rise and descend:  $c_1 < c_2 > c_3 < \dots$*

Sometimes such a permutation is called *up-down alternating permutation* in contrast with *down-up* permutations:  $c_1 > c_2 < c_3 > \dots$ . The number of zig-zag permutations is found by André [2] via generating functions.

Let  $A_n$  be the number of zig-zag permutations of  $n$  elements. Consider the series  $A(x) = \sum_{n=1}^{\infty} A_n \frac{x^n}{n!}$ . Then André's Theorem states that

$$A(x) = \tan x + \sec x,$$

in other words,  $\tan x + \sec x$  is an exponential generating function for sequence  $A_n$ .

It should be noted that since  $\tan x$  is odd and  $\sec x$  is even, these two functions control the number of odd and even zig-zag permutations separately.

Consider now the ribbon space  $\mathcal{A}$  and take some  $a = (\varphi, \nu) \in \mathcal{A}$ . Let the extrema of  $\varphi$  (the nodes) be  $p_1, \dots, p_n$ , (then  $n$  is an even number). Now, since the critical values  $l_i = \varphi(p_i)$  are all different and go up-down, it is clear that we may model function  $\varphi$  by a cyclic zig-zag permutation  $(c_1, c_2, \dots, c_n)$ . Moreover,

it is convenient to suppose  $c_1 = 1$  and to consider linear zig-zag permutations, instead of cyclic ones. For example,  $(1, 3, 2, 4)$ ,  $(1, 6, 2, 4, 3, 5)$  are two cyclic zig-zag permutations in a linear notation. Furthermore, we may define the *mark* function  $\nu : P \rightarrow \{-1, +1\}$  setting  $\nu(c_i) = \nu(p_i)$ . In such a way, we get some marked cyclic zig-zag permutation, which contains all the boundary information of ribbon  $a$ .

**Definition 4.3.** Let  $\mathcal{B}$  be the set of all pairs  $(t, \nu)$ , where  $t = (c_1, c_2, \dots, c_n)$  is a cyclic zig-zag permutation with  $n$  even, and  $\nu(c_i) = \pm 1$  is some mark function. We shall refer to  $\mathcal{B}$  as the discrete ribbon space (or simply the ribbon space). Its elements  $b = (t, \nu)$  will be called discrete ribbons (or simply ribbons). The set of ribbons of order  $n$  will be denoted by  $\mathcal{B}_n$ .

It is clear that we get some natural map  $j : \mathcal{A} \rightarrow \mathcal{B}$  such that the co-images of discrete ribbons are similarity classes in  $\mathcal{A}$ . Now one defines the ribbon invariant  $\gamma$  on  $\mathcal{B}$  by setting for  $b \in \mathcal{B}$

$$\gamma(b) = \gamma(a), \text{ where } a \in j^{-1}(b).$$

It is clear also that  $\mathcal{A}_0 \approx \mathcal{B}$  by a natural isomorphism.

In such a way, the problem of computing  $\gamma$  turns into a purely discrete one and we shall see further that some inductive algorithm solves it. Of course, it is not very fast and one of the reasons for this may be the obvious fact, that the number of ribbons with  $n$  nodes grows very fast as  $n \rightarrow \infty$ . A better algorithm based on elementary moves and reduction to ladders is proposed in Part II.

So, let us see an expression for this number, based on André's Theorem.

**Proposition 4.4.** Let  $2 \tan 2x = \sum_{n=2}^{\infty} B_{n-1} \frac{x^{n-1}}{(n-1)!}$ . Then  $B_{n-1}$  is the number of ribbons with  $n$  nodes.

*Proof.* As we noticed above, cyclic zig-zag permutations with  $n$  nodes may be identified with ordinary zig-zag permutations of type  $(1, c_2, \dots, c_n)$ . But the number of latter equals the number of down-up permutations of order  $n-1$ , so it is  $A_{n-1}$  (the numbers of down-up and up-down permutations are equal via the involution  $k \rightarrow n-k+1$ ). Now one has  $B_{n-1} = 2^n A_{n-1}$ , as there are  $2^n$  mark functions. By André's theorem

$$\begin{aligned} \tan x &= \sum_{n=2}^{\infty} A_{n-1} \frac{x^{n-1}}{(n-1)!}, \text{ so} \\ 2 \tan 2x &= \sum_{n=2}^{\infty} 2A_{n-1} \frac{(2x)^{n-1}}{(n-1)!} = \sum_{n=2}^{\infty} B_{n-1} \frac{x^{n-1}}{(n-1)!}. \end{aligned}$$

□

If one prefers to get as a generating function  $\tan 2x$  instead of  $2 \tan 2x$ , it suffices to identify a cyclic permutation with the same one, but going in reverse order (with the same marking), which is convenient from geometric point of view and does not affect the ribbon invariant  $\gamma$ . (This is equivalent to allowing orientation-reversing diffeomorphisms  $\psi : \mathbb{S}^1 \rightarrow \mathbb{S}^1$  in the definition of similar ribbons). However, we shall distinguish two such permutations furthermore.

Note that  $2 \tan 2x = \frac{4}{1!}x + \frac{32}{3!}x^3 + \frac{1024}{5!}x^5 \dots$  that agrees with the fact that there are 4 ribbons with 2 nodes, 32 ribbons with 4 nodes, etc. It is clear that the number of ribbons grows very fast as  $n \rightarrow \infty$ . For example, the number of ribbons with 10 nodes is  $|\mathcal{A}_{10}| = 1449132032$ .

**Corollary 4.5.** *Combining Proposition 4.4 with the well known relation between the Taylor expansion of  $\tan x$  and Bernoulli numbers, on one hand, and the asymptotics of Bernoulli numbers on the other, one obtains for the asymptotics of the number of ribbons with  $n$  nodes the following formula*

$$|\mathcal{A}_n| \sim \frac{2^n(2^n - 1)(n - 1)!}{\pi^n}, \text{ as } n \rightarrow \infty.$$

**Remark.** *The number of positive ribbons  $a \in \mathcal{A}_n^+$  is computed via generating function  $\tan x$ , i.e., if  $\tan x = \sum_{n=2}^{\infty} C_{n-1} \frac{x^{n-1}}{(n-1)!}$ , then  $C_{n-1}$  is the cardinality of  $\mathcal{A}_n^+$ .*

This is a simple corollary of André's Theorem and the fact that positive ribbons may be identified with zig-zag permutations. Of course, this allows one to get easily the asymptotics of  $|\mathcal{A}_n^+|$ , the latter number coinciding with the number of similarity classes of Morse functions  $\varphi : \mathbb{S}^1 \rightarrow \mathbb{R}$ ,

$$|\mathcal{A}_n^+| \sim \frac{(2^n - 1)(n - 1)!}{2\pi^n}, \text{ as } n \rightarrow \infty.$$

Clearly,  $|\mathcal{A}_n^+| = |\mathcal{A}_n^-|$  in a trivial way. Moreover, if  $\mathcal{A}(n, \sigma)$  is the set of ribbons with  $n$  nodes and signature  $\sigma$  it is easy to see that

$$|\mathcal{A}(n, \sigma)| = \binom{n}{\frac{n+\sigma}{2}} |\mathcal{A}_n^+|.$$

Therefore, for the asymptotics of  $|\mathcal{A}(n, \sigma)|$  one gets

$$|\mathcal{A}(n, \sigma)| \sim \binom{n}{\frac{n+\sigma}{2}} \frac{(2^n - 1)(n - 1)!}{2\pi^n}, \text{ as } n \rightarrow \infty.$$

Here  $\sigma$  is mainly assumed to be a fixed constant, but it also may be thought as a function  $\sigma(n)$ , such that  $|\sigma(n)| \leq n$  and the limit  $\lim_{n \rightarrow \infty} \frac{\sigma(n)}{n}$  exists. For example,  $\sigma(n) = \pm n$  covers both the case of positive and negative ribbons. Clearly,  $\sigma = 0$  implies the strongest possible asymptotics.

In order to carry out induction in the ribbon space  $\mathcal{B}$ , it is convenient to define some linear (lexicographic) order in  $\mathcal{B}$ .

Let  $a = (t, \nu) \in \mathcal{B}$ , where  $t = (c_1, c_2, \dots, c_n)$ . Set  $\nu(t) = (\nu(c_1), \dots, \nu(c_n))$ . Consider the triple  $(n, t, \nu(t))$ . It is clear now that we may introduce a lexicographic ordering in these triples, assuming that  $+1 < -1$ . In such a way,  $\mathcal{B}$  is totally ordered and has a minimal element  $\alpha_0 = (1^+, 2^+)$  - the "minimal" ribbon. We shall denote it by " $<$ " again and write  $a < b$ . Clearly, this ordering of  $\mathcal{B}$  may be considered as a partial order in  $\mathcal{A}$  as well. Observe that the minimal and the maximal element of  $\mathcal{A}_n$  are both ladders (an ascending and descending one, respectively), while the alternations are situated somewhere at "the middle" of  $\mathcal{A}_n$  with respect to this ordering. It should not be confused with the partial order in  $\mathcal{A}$  defined in Section 22, the latter being more geometric and interesting, in nature.

Let us finally make a practical convention, concerning notations:

*We shall denote by  $\mathcal{A}$  the space of both rigid and soft ribbons and the particular case will either be clear from the context, or will it be mentioned specially.*

We shall mainly think of  $\mathcal{A}$  as the class of soft/discrete ribbons, or, equivalently, marked cyclic zig-zag permutations.

## 5. SPLITTING OF RIBBONS AND EXTENSIONS

Splitting of ribbons along a pair/triple of points and splitting of extensions along a level line (regular or touching) is the main technical tool to prove things by induction. Throughout this section  $\mathcal{A}$  will denote the class of *soft* ribbons, i.e. we consider ribbons up to similarity, or equivalently - discrete ribbons. Let  $a = (\varphi, \nu) \in \mathcal{A}$  be a ribbon,  $c$  be a non-critical level of  $\varphi$  and  $x_1, x_2 \in \mathbb{S}^1$  be such that  $\varphi(x_1) = \varphi(x_2) = c$  and  $\varphi'(x_1)\varphi'(x_2) < 0$ , where  $\varphi'$  is the derivative with respect to the natural parameter. So  $\varphi$  has opposite monotonicity at points  $x_1$  and  $x_2$  and we may split  $a$  into two other ribbons  $a = a_1 \# a_2$ ,  $a_1 = (\varphi_1, \nu_1)$  and  $a_2 = (\varphi_2, \nu_2)$ , as follows:

1) if  $l_1$  and  $l_2$  are the components of  $\mathbb{S}^1 \setminus \{x_1, x_2\}$  (arcs) and  $p_1 : l_1 \rightarrow \mathbb{S}^1$ ,  $p_2 : l_2 \rightarrow \mathbb{S}^1$  are such that  $p_i$  are one-to-one on  $l_i \setminus \{x_1, x_2\}$  and  $p_i(x_1) = p_i(x_2)$ , set

$$\varphi_i(x) = \varphi(p_i^{-1}(x)), i = 1, 2,$$

in such a way each  $\varphi_i$  gets a new-born extremum,

2)  $\nu_i$  inherits the marking from  $l_i$ , while the new-born extrema are marked as “positive”.

See Fig. 22-a for an example of a ribbon splitting. Note that  $a_1 \# a_2$  is not an algebraic operation here, in contrast with Section 21, where the *ribbon semigroup* is defined in the class of *rigid* ribbons.

Let now  $a \in \mathcal{A}$  and  $f \in \mathcal{F}(a)$  ( $f$  is an extension of  $a$ ). Let  $l$  be a non-critical level line of  $f$ , so  $l$  is a topological segment intersecting transversely the boundary of  $\mathbb{B}^2$  in points  $x_1, x_2$ . We may split  $f$  along  $l$ :  $f = f_1 \vee f_2$  as follows. Let  $L_1, L_2$  be the components of  $\mathbb{B}^2$ , take maps  $P_1 : \bar{L}_1 \rightarrow \mathbb{B}^2$ ,  $P_2 : \bar{L}_2 \rightarrow \mathbb{B}^2$  such that  $P_i(l) = y_i$  (a point) and  $P_i$  are one-to-one on  $L_i \setminus l$ . Then set

$$f_i(x) = f(P_i^{-1}(x)), i = 1, 2.$$

Functions  $f_i$  are correctly defined, since  $f|_l = \text{const}$ .

Note that the ribbon  $a$  splits then in a natural way into two other ribbons  $a = a_1 \# a_2$  (along points  $x_1, x_2$ ), such that  $f_i \in \mathcal{F}(a_i)$ . See Fig. 22-b for an example by the level portrait of some  $f$ .

*Notes.* 1) After the splitting we should “smoothen” both ribbons and extensions in order to fall in the smooth class again. This will be explained in Part II. Another approach is to consider from the beginning piecewise smooth (or even piecewise linear) functions, but then we shall lose the gradient flow, which is important for our further investigations.

2) Splitting is defined for discrete ribbons in a similar way, but we have to re-label the elements of the new zig-zag permutations. This will be explained in full details in Section 12, where the algorithm for calculating the ribbon invariant is described.

It turns out that we need another type of splitting, depending on the negative nodes (if any). Let  $p$  be a negative node and  $x_1, x_2 \in \mathbb{S}^1$  be such that  $\varphi(x_1) = \varphi(x_2) = \varphi(p)$  and  $\varphi'(x_1)\varphi'(x_2) < 0$ . (In such a way  $\varphi(p)$  is different from the minimal and maximal value of  $\varphi$ ). Then we may define a splitting of  $a$  into three ribbons:  $a = a_1 * a_2 * a_3$  analogically to the above splitting  $\#$ :

1) if  $l_1, l_2$  and  $l_3$  are the components of  $\mathbb{S}^1 \setminus \{x_1, x_2, p\}$  and  $p_1 : l_1 \rightarrow \mathbb{S}^1$ ,  $p_2 : l_2 \rightarrow \mathbb{S}^1$ ,  $p_3 : l_3 \rightarrow \mathbb{S}^1$  are such that  $p_i$  are one-to-one on  $l_i \setminus \{x_1, x_2, p\}$  and  $p_i(x_1) = p_i(x_2)$ ,



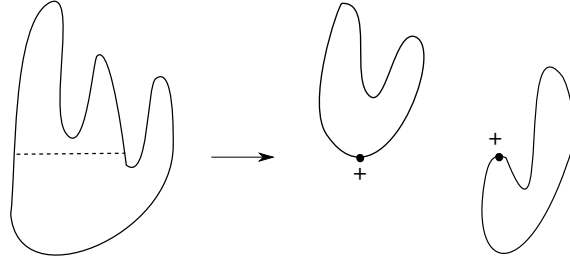

a) binary splitting of a ribbon

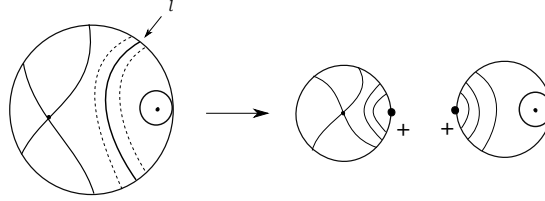

b) binary splitting of an extension

FIGURE 22. Binary splittings.

set

$$\varphi_i(x) = \varphi(p_i^{-1}(x)), \quad i = 1, 2, 3.$$

As above, each  $\varphi_i$  gets a new-born extremum.

2)  $\nu_i$  inherits the marking from  $l_i$ , while the new-born extrema are marked as “positive”.

Just as above, each extension  $f \in \mathcal{F}(a)$  splits  $f = f_1 \circ f_2 \circ f_3$ , splitting  $a$  into  $a = a_1 * a_2 * a_3$ , in such a way that  $f_i \in \mathcal{F}(a_i)$ . (See Fig. 23)

We shall call  $a_1 \# a_2$  *binary* splitting and  $a_1 * a_2 * a_3$  *ternary* splitting. Splittings are of geometrical nature:  $a_1 \# a_2$  corresponds to a splitting along a regular level line, while  $a_1 * a_2 * a_3$  corresponds to a splitting along a level line touching the boundary from inside in a negative node. It turns out that the ribbon invariant is subadditive with respect to splittings.

**Definition 5.1.** *The ribbon  $a$  is called reducible, if for any extension  $f \in \mathcal{F}(a)$  there is a non-critical level line  $l$ , either regular, or touching, such that after splitting  $a$  along  $l$ ,  $a = a_1 \# a_2$  or  $a = a_1 * a_2 * a_3$ , we have  $a_i \prec a$ ,  $\forall i$  (in the defined above partial order). Otherwise  $a$  is called irreducible.*

**Lemma 5.2.** *The only irreducible ribbons are  $\alpha_0 = (1^+, 2^+)$ ,  $\alpha_1 = (1^+, 2^-)$ ,  $\alpha_2 = (1^-, 2^+)$ , as well as all the positive alternations  $\beta_n$ ,  $n = 4 \dots$*

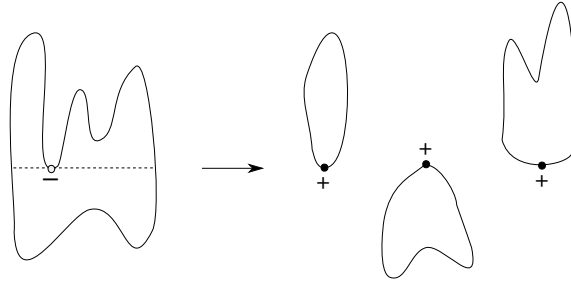

a) ternary splitting of a ribbon

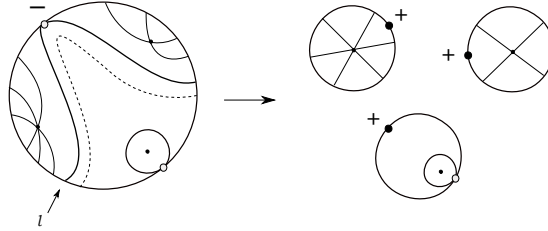

b) ternary splitting of an extension

FIGURE 23. Ternary splittings.

*Proof.* Note that the second and the third ribbon are in fact identical. It is clear that the first three are irreducible. Let  $a \in \mathcal{A}^+$  be an alternation. Then  $\gamma(a) = 1$  and if we take the unique  $f \in \mathcal{F}(a)$  realizing  $\gamma(a)$ , (see Fig. 18), it is evident from picture that  $a$  is irreducible. Let  $a$  be some ribbon different from the listed ones. We shall prove that it is reducible. Suppose first that  $a$  has a negative node  $p$  and let  $f \in \mathcal{F}(a)$  be realizing  $\gamma(a)$ . Let  $l$  be the level line of  $f$  passing through  $p$ . There are two cases: a)  $l$  is closed. Take some level line  $l'$  close to  $l$  situated in the exterior of  $l$ . Then  $l'$  is regular and we may split  $a$  along  $l'$ :  $a = a_1 \# a_2$ . But now it is easy to see that  $a_i \prec a$ ,  $i = 1, 2$ . Indeed, one of them, say  $a_1$  is equivalent to  $(1^+, 2^-)$ , while then  $a_2 \prec a$ , since  $a_2$  is identical with  $a$ , except for one node, which has become “positive”. b)  $l$  is a regular touching line. Then, after splitting  $a$  along  $l$ :  $a = a_1 * a_2 * a_3$ , it is clear that  $a_i \prec a$ ,  $i = 1, 2, 3$ , since  $a_i$  has smaller number of nodes than  $a$ . Suppose now that  $a \in \mathcal{A}^+$ . Consider the node levels  $l_i = \varphi(p_i)$  and the system  $\omega = \{[l_i, l_{i+1}]\}$ ,  $i = 1, \dots, n$  (assuming  $l_{n+1} = l_1$ ). Take the minimal non-empty intersections of elements of  $\omega$ . These are called later *clusters* (Section 7). It is not hard to see that each such minimal intersection has the form  $C = [\varphi(p_i), \varphi(p_j)]$ , where  $p_i$  and  $p_j$  have opposite type (a minimum and a maximum) and there are no other critical levels of  $\varphi$  in  $C$ . Thus, the system  $\beta$  of all clusters is disjoint. Since  $a$  is not an alternation, there are at least two elements

$C_1, C_2$  of  $\beta$ . We may suppose that  $C_1, C_2$  are adjacent elements of  $\beta$ . Take a non-critical value  $c$  of  $f$  between  $C_1$  and  $C_2$ . Consider the pairing  $\psi : \varphi^{-1}(c) \rightarrow \varphi^{-1}(c)$  induced by  $f$ , i.e. satisfying  $f(x) = f(\psi(x))$ . Let  $\varphi^{-1}(c) = \{x_1, x_2, \dots, x_k\}$ . We shall show the following property of  $\psi$ : there is a pair  $(x_i, \psi(x_i))$  which is dividing the set of nodes of  $\varphi$  into 2 groups, each of them containing at least 3 nodes. Indeed, suppose the contrary, then each pair  $(x_i, \psi(x_i))$  is dividing the nodes into 2 groups  $A_i$  and  $B_i$  such that  $|A_i| = 1, |B_i| = n - 3$ . Consider the set  $M = \cup A_i$ . It is easily seen that the nodes in  $M$  have the same type, suppose that they are all maximums. But then  $\varphi$  has no minimums above level  $c$  and we get contradiction with the choice of  $c$  since it is impossible to exist some cluster in  $[c, \max \varphi]$  (it has to be of the form  $C = [\varphi(p_i), \varphi(p_j)]$ , where  $p_i$  and  $p_j$  have opposite type). Now, let  $(x_i, \psi(x_i))$  be a pair which is dividing the set of nodes into 2 groups, each of them containing at least 3 nodes. Let  $l$  be the level line of  $f$  joining  $x_i$  with  $\psi(x_i)$ . Split  $f$  along  $l$ :  $f = f_1 \vee f_2$ , thus inducing a splitting  $a = a_1 \# a_2$ . But now one has  $a_1 \prec a, a_2 \prec a$ , as  $a_1$  and  $a_2$  have less nodes than  $a$ . The lemma is proved.  $\square$

This concept is useful when carrying out induction on the lexicographic order, then we have first to check the assertion for irreducible ribbons. Note also that later, in [Section 21](#) we adopt some more simple notation for splittings, interpreted as algebraic operations in  $\mathcal{A}$ .

## 6. ECONOMIC EXTENSIONS

It is natural to look for extensions of a given ribbon  $a$ , which are minimizing the number of critical points within a class of simple “good” extensions. It turns out that there is such a class, that we call “economic” extensions here. (The term “good function” is overused in the literature, so we prefer another one instead.) The basic fact about them is that for any ribbon  $a \in \mathcal{A}$  there is an economic extension with  $\gamma(a)$  critical points, and moreover, any general position extension with  $\gamma(a)$  critical points *is indispensably* economic. Before giving the definition, we show some graphical examples of economic and non-economic extensions at [Fig. 24](#) and [Fig. 25](#). Note that not any Morse extension is an economic one.

**Definition 6.1.** *Let  $a = (\varphi, \nu) \in \mathcal{A}$  be a ribbon and  $f : \mathbb{B}^2 \rightarrow \mathbb{R}$  be an extension with the corresponding boundary data ( $f \in \mathcal{F}(a)$ ). Then  $f$  is called “economic”, if*

- 1)  *$f$  has a finite number of critical points with different critical values*
- 2) *each critical point is either a non degenerate local extremum, or a saddle point (possibly degenerate)*
- 3) *the separatrices of each saddle finish transversely on the boundary*
- 4) *the level line passing through a negative node is either a) a topological segment ending transversely on the boundary, or b) a simple closed curve with exactly one critical point in its interior (then, of course, it is an extremum)*

This definition needs some clarification. In ([\[9\]](#)) A. O. Prishlyak proved the following: Let  $f : M \rightarrow \mathbb{R}$  be a smooth function on a closed surface  $M$  with isolated critical points. Then in a neighbourhood of a critical point of nonzero index, which is not a local extremum,  $f$  is (topologically) conjugated with  $\operatorname{Re}(z^k)$  for some nonnegative integer  $k$ . It follows from this result that in a neighbourhood of a critical point of nonzero index, the function  $f$  is conjugated to either 1) a typical local extremum:  $f = \pm(x^2 + y^2)$ , or 2) a typical saddle point:  $f = (y -$

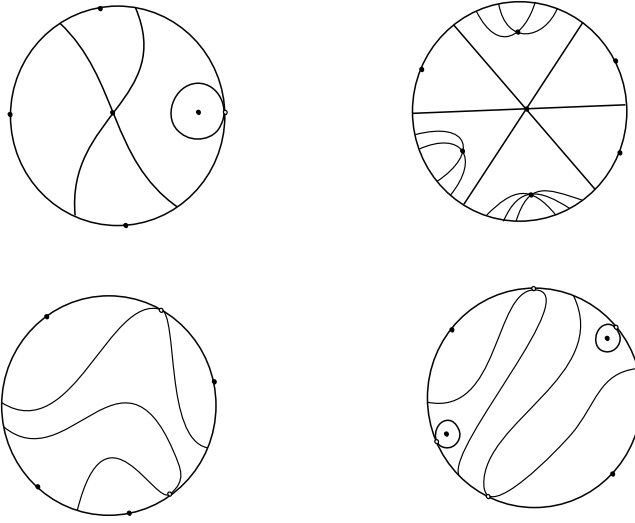

FIGURE 24. Economic extensions.

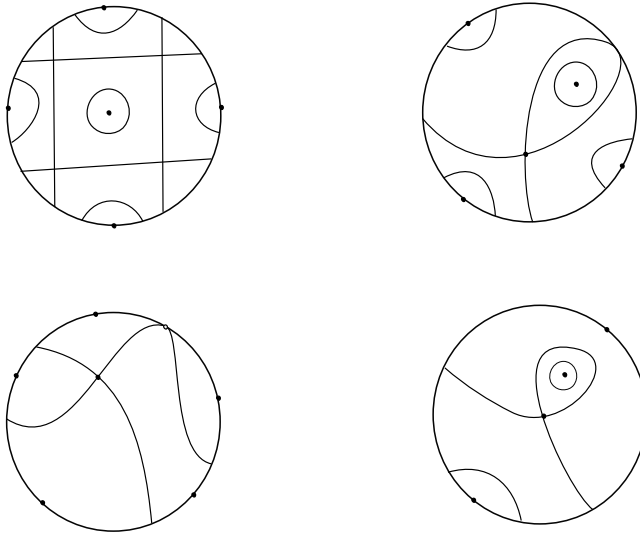

FIGURE 25. Non economic extensions.

$x)(y - 2x) \dots (y - nx)$ ,  $n \geq 2$  (for  $n = 2$  it is non degenerate). A saddle has always an even number of separatrices going out of it. (In both examples the critical point is  $O$ ). Note that an economic extension cannot have a critical point of index zero. The above arguments justify the definition of economic extensions. Of course, we may speak about economic *functions*, instead of *extensions* in [Definition 6.1](#).

It may be shown that the economic extensions of any  $a \in \mathcal{A}_n$  have  $\leq \frac{3n}{2} - 1$  critical points (equality possible), that gives us the estimate  $\gamma \leq \frac{3n}{2} - 1$ , but we won't do that here, since the sharper inequality  $\gamma \leq \frac{n}{2} + 1$  holds true. Note also that if we allow ribbons with coinciding critical values, then a larger class of economic

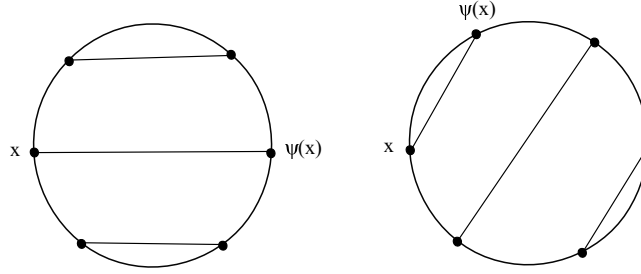

FIGURE 26. Two different pairings.

extensions should be considered, where a level line may touch the boundary multiple times.

Let  $a = (\varphi, \nu) \in \mathcal{A}$  be a ribbon and  $c$  be a non-critical value of  $\varphi$ . Then  $\varphi^{-1}(c) = \{x_1, x_2, \dots, x_k\}$ , where  $k$  is even and  $\varphi$  has opposite monotonicity at  $x_i$  and  $x_j$  for  $i - j$  odd. We shall call such a pair  $(x_i, x_j)$  *proper*. Splitting of ribbons is possible only along proper pairs.

**Definition 6.2.** Let  $c$  be a non-critical value of  $\varphi$ . A pairing in  $\varphi^{-1}(c)$  is an involution  $\psi : \varphi^{-1}(c) \rightarrow \varphi^{-1}(c)$ , such that any two different pairs  $(x, \psi(x)), (y, \psi(y))$  are not linked in  $\mathbb{S}^1$ , i.e. the segments with the corresponding ends are not intersecting in  $\mathbb{B}^2$ .

It is easy to see that for a pairing  $\psi$  any pair  $(x, \psi(x))$  is proper. At Fig. 26 two different pairings are presented.

**Definition 6.3.** A proper pair  $(x_i, x_j)$  will be called *essential*, if after splitting ribbon  $a$  along  $(x_i, x_j)$ ,  $a = a_1 \# a_2$ , we have both  $a_1 \prec a$  and  $a_2 \prec a$  in the lexicographic order (see Section 4).

A non-critical value  $c$  of  $\varphi$  will be called *essential*, if for any pairing  $\psi : \varphi^{-1}(c) \rightarrow \varphi^{-1}(c)$  there is a pair  $(x, \psi(x))$ , which is essential.

Note that non-essential values exist; for example if the maximal value  $M$  of  $\varphi$  is marked as “positive” and  $c$  is near  $M$ , then  $\varphi^{-1}(c) = \{x_1, x_2\}$ , but it is easy to see that this pair is non-essential.

**Lemma 6.4.** Let  $n \geq 4$  and  $a \in \mathcal{A}_n^+$  be a ribbon without essential values. Then  $a$  is an alternation.

*Proof.* Suppose first that the cluster number of  $a$  is  $\delta(a) \geq 2$ , so  $a$  has (at least) two clusters  $C_1$  and  $C_2$ . (For the definition of cluster number see Section 7.) Take a non-critical value  $c$  between  $C_1$  and  $C_2$ , then there are two groups of nodes  $P_1$  and  $P_2$ , such that  $\varphi^{-1}(c)$  is a partition between them and  $|P_1| \geq 3, |P_2| \geq 3$ . Take now some pairing  $\psi : \varphi^{-1}(c) \rightarrow \varphi^{-1}(c)$ , then it is easily seen that some pair  $(x, \psi(x))$  is a partition between  $P_1$  and  $P_2$ . But then splitting  $a$  along  $(x, \psi(x))$ ,  $a = a_1 \# a_2$ , one has that  $a_1 \prec a$  and  $a_2 \prec a$  since  $a_1$  and  $a_2$  have smaller number of nodes than  $a$ . Thus  $c$  is an essential value. So we have  $\delta(a) = 1$ , i.e. for the node levels  $l_i = \varphi(p_i)$  we have  $\cap_{i=1}^{n-1} [l_i, l_{i+1}] \neq \emptyset$ . But since by assumption all nodes are positive,  $a$  is an alternation. Note that some alternations may have essential values, but this will not be important for us.  $\square$

Now we shall prove that the ribbon invariant is subadditive with respect to splittings.

**Lemma 6.5.** *The following inequalities hold*

$$\gamma(a_1\#a_2) \leq \gamma(a_1) + \gamma(a_2), \quad \gamma(a_1 * a_2 * a_3) \leq \gamma(a_1) + \gamma(a_2) + \gamma(a_3),$$

*Proof.* The proofs of both inequalities are short and very similar and we shall do here only the first one. Let  $a = a_1\#a_2$  and  $f_1 \in \mathcal{F}(a_1)$ ,  $f_2 \in \mathcal{F}(a_2)$  are extensions realizing  $\gamma(a_1)$  and  $\gamma(a_2)$ , respectively. Now it is not difficult to construct  $f \in \mathcal{F}(a)$ , so that  $f = f_1 \vee f_2$ . But then  $f$  has  $\gamma(a_1) + \gamma(a_2)$  critical points, therefore  $\gamma(a_1\#a_2) \leq \gamma(a_1) + \gamma(a_2)$  by the definition of  $\gamma$ .  $\square$

**Lemma 6.6.** *a) Suppose  $f \in \mathcal{F}(a)$  is realizing  $\gamma(a)$ ,  $l$  is a non-critical level line of  $f$  and  $f = f_1 \vee f_2$  is a splitting along  $l$ , inducing the splitting  $a = a_1\#a_2$ . Then*

$$\gamma(a_1\#a_2) = \gamma(a_1) + \gamma(a_2).$$

*b) Suppose  $f \in \mathcal{F}(a)$  is realizing  $\gamma(a)$ ,  $l$  is a regular level touching line and  $f = f_1 \circ f_2 \circ f_3$  is a splitting along  $l$ , inducing the splitting  $a = a_1 * a_2 * a_3$ . Then*

$$\gamma(a_1 * a_2 * a_3) = \gamma(a_1) + \gamma(a_2) + \gamma(a_3).$$

*Proof.* a) In view of [Lemma 6.5](#), suppose that  $\gamma(a_1\#a_2) < \gamma(a_1) + \gamma(a_2)$ . Then, since  $f_1 \in \mathcal{F}(a_1)$ ,  $f_2 \in \mathcal{F}(a_2)$ , it is clear that at least one of  $f_1, f_2$  has less than  $\gamma(a_1)$  or  $\gamma(a_2)$  critical points, a contradiction. b) is proved analogically.  $\square$

Before passing to the main result in the present section, let us make some technical remark.

Suppose  $a \in \mathcal{A}$  is a ribbon with a negative node  $p$  and that the extension  $f \in \mathcal{F}(a)$  is realizing  $\gamma(a)$ . Then there is an extension  $f_0 \in \mathcal{F}(a)$  which is realizing  $\gamma(a)$  as well, and the level set through  $p$  is a regular touching line.

**Theorem 6.7.** *For any ribbon  $a \in \mathcal{A}$  there is an economic extension  $f_0 \in \mathcal{F}(a)$  realizing  $\gamma(a)$ .*

*Proof.* We shall proceed by induction on the lexicographic order in  $\mathcal{A}$ . For  $n \leq 4$  this is very easily done “by hand”. Another easy case is when  $a$  is an alternation. Then  $\gamma(a) = 1$  and the economic extension with one saddle (with  $n$  separatrices) is the obvious solution. (Note that in this case  $\gamma(a) > 0$ , since otherwise one gets contradiction with the necessary condition for  $\gamma(a) = 0$ , see [Fact 8.3](#).) Suppose that  $f \in \mathcal{F}(a)$  is some extension realizing  $\gamma(a)$ . Let now  $a \in \mathcal{A}_n$ , where  $n \geq 6$  and assume that the theorem is true for any ribbon  $b$  such that  $b \prec a$ . Suppose first that  $a$  has a negative node  $p$ . As following from the above remark, we may suppose that the level set of  $f$  through  $p$  is a regular touching line  $l$ . There are two cases a)  $l$  is closed. Then let  $a_0$  be the ribbon identical with  $a$ , except in node  $p$ , which is made “positive”. It is clear that  $\gamma(a) = \gamma(a_0) + 1$  and  $a_0 \prec a$ . Thus, there is an economic extension  $g \in \mathcal{F}(a_0)$  realizing  $\gamma(a_0)$ . Now, it is clear that we may define an economic extension  $f_0 \in \mathcal{F}(a)$  with  $\gamma(a_0) + 1$  critical points, thus realizing  $\gamma(a)$ . b)  $l$  is a topological segment. Let  $f = f_1 \circ f_2 \circ f_3$  be a splitting along  $l$ , inducing the splitting  $a = a_1 * a_2 * a_3$ . It is easily seen that  $a_i \prec a$ ,  $i = 1, 2, 3$  since each  $a_i$  has  $< n$  nodes. Then by assumption, there are economic extensions  $g_i \in \mathcal{F}(a_i)$  realizing  $\gamma(a_i)$ . Thus we may define an economic extension  $f_0 \in \mathcal{F}(a)$  realizing  $\gamma(a_1) + \gamma(a_2) + \gamma(a_3)$ , but then [Lemma 6.6](#), b) implies that  $f_0$  is realizing  $\gamma(a)$ . Let now  $a \in \mathcal{A}_n^+$ . Then we may suppose that  $a$  has an essential value  $c$ , since otherwise

it is an alternation by Lemma 6.4. Consider the pairing  $\psi : \varphi^{-1}(c) \rightarrow \varphi^{-1}(c)$  naturally induced by  $f$  as follows:  $y = \psi(x)$  iff  $x$  and  $y$  are the ends of some non-critical level line of  $f$ . Since  $c$  is essential, there is an essential pair  $(x, \psi(x))$ . Let  $l$  be the non-critical level line of  $f$  connecting  $x$  with  $\psi(x)$ . Then if  $f = f_1 \vee f_2$  is a splitting along  $l$ , inducing the splitting  $a = a_1 \# a_2$ , we have  $a_i \prec a$ ,  $i = 1, 2$ . By assumption, there are economic extensions  $g_i \in \mathcal{F}(a_i)$  realizing  $\gamma(a_i)$ . Thus we may define an economic extension  $f_0 \in \mathcal{F}(a)$  realizing  $\gamma(a_1) + \gamma(a_2)$ , but then Lemma 6.6, a) implies that  $f_0$  is realizing  $\gamma(a)$ .  $\square$

**Remark.** *In fact, we proved in the above theorem that any extension  $f \in \mathcal{F}(a)$  which is realizing  $\gamma(a)$ , is actually an economic one.*

We shall denote the set of economic extensions (up to topological equivalence) of  $a$  by  $\mathcal{F}^e(a)$ . The set of all economic extensions will be denoted by  $\mathcal{F}^e$  and the set of all economic extensions of ribbons of order  $n$  by  $\mathcal{F}_n^e$ .

Theorem 6.7 allows us to somehow “finitize” the problem, as it is clear that there is only a finite number of economic extensions of a given ribbon (up to, either combinatorial, or topological equivalence). A “brute force” method for finding  $\gamma$  would be to construct *all* economic extensions and then to look which ones have minimal number of critical points. Of course, this is counterproductive (from point of view of computation of  $\gamma$ ), as the sets  $\mathcal{A}_n$  and  $\mathcal{F}_n^e$  are very large and difficult to store and to search within for big  $n$ . Moreover, we may consider the problem of finding the (combinatorial) number  $\phi_r(a)$  of economic extensions of a given ribbon  $a$  with exactly  $r$  critical points. It is clear that

$$\gamma(a) = \min\{r \mid \phi_r(a) \neq 0\}.$$

Furthermore, it is not that difficult to see that

$$\phi_{r_1+r_2}(a\#b) \geq \phi_{r_1}(a)\phi_{r_2}(b), \quad \phi_{r_1+r_2+r_3}(a*b*c) \geq \phi_{r_1}(a)\phi_{r_2}(b)\phi_{r_3}(c).$$

Take now in the above inequalities  $r_i = 0$ . Then

$$\phi_0(a\#b) \geq \phi_0(a)\phi_0(b), \quad \phi_0(a*b*c) \geq \phi_0(a)\phi_0(b)\phi_0(c),$$

so,  $\phi_0$  is a kind of *super-multiplicative* invariant. Clearly,  $\phi_0$  makes sense only on the space of ribbons with  $\gamma = 0$ , as it counts the number of critical points free economic extensions. Note that every critical points free extension *is* economic in fact. We suppose that the calculation of  $\phi_0$  is a nontrivial task, although it may be attacked algorithmically.

**Question 1.** For a given ribbon  $a \in \mathcal{A}$ , what is the cardinality of  $\mathcal{F}^e(a)$ ?

**Question 2.** What is the cardinality of  $\mathcal{F}_n^e$ ?

**Question 3.** Are there any consistent estimates of the number  $\phi_r$  (especially for  $\phi_0$ )?

As we noticed above, it is not difficult to show by induction that for any ribbon  $a \in \mathcal{A}_n$ , one has

$$|\mathcal{F}^e(a)| \leq \frac{3n}{2} - 1,$$

where equality is possible for each  $n$ . Note also that there are ribbons with unique economic extension ( $|\mathcal{F}^e(a)| = 1$ ). Such are all the *positive ladders* in addition with the 4 ribbons from  $\mathcal{A}_2$ .

Another hard problem would be to find the number of *topologically* different economic extensions of a given ribbon  $a$  with exactly  $r$  critical points (the number  $\phi_r(a)$  is counting *combinatorially* different extensions). This seems to be the

most difficult problem of this kind, so we won't discuss it furthermore and shall concentrate our attention mainly on the problems related to  $\gamma$ .

## 7. THE CLUSTER NUMBER

Here we shall define a simple and useful invariant of a given ribbon, the so-called *cluster number*, which is related to the ribbon invariant  $\gamma$ . It turns out that the cluster number is a *ribbon invariant* itself (see [Section 23](#)). The cluster number provides us with a simply checkable estimate of  $\gamma$  from below. However, as a rule this estimate is quite far from reality, but may be useful in some situations (for example when establishing  $\gamma > 0$ .)

**Definition 7.1.** *Let  $\omega = \{X_i\}$  be a finite covering of set  $X$ . Its cluster number  $\delta(\omega)$  is defined as the minimal cardinality of finite subsets  $A$  of  $X$ , intersecting all elements of  $\omega$ :  $A \cap X_i \neq \emptyset$  for any  $i$ .*

Sometimes the cluster number is called *transversal number* (in the context of hypergraphs).

Furthermore, we shall call the minimal non-empty intersections of elements of  $\omega$  *clusters* of covering  $\omega$ . It is easily seen that the cluster number  $\delta(\omega)$  is less or equal to the number of clusters of  $\omega$ . In general, the cluster number *does not* equal the number of clusters. Let us note that, from algorithmic point of view, the number of clusters is much easier to be found than the cluster number  $\delta$ .

**Definition 7.2.** *Let  $a = (\varphi, \nu)$  be a ribbon with nodes  $p_1, \dots, p_n$ , where  $n \geq 4$ . Consider the node levels  $l_i = \varphi(p_i)$  and the system  $\omega = \{[l_i, l_{i+1}]\}$ ,  $i = 1, \dots, n$  (assuming  $l_{n+1} = l_1$ ). Then the cluster number of  $a$  is defined as the cluster number of  $\omega$  and will be denoted by  $\delta(a)$ . The cluster number of the ribbons with two nodes is set to zero by convention. We shall call  $\omega$  a level system of ribbon  $a$ .*

For example, the cluster number of an alternation equals one:  $\delta(a) = 1$ , since the elements of  $\omega$  have non-empty intersection. On the other hand, the cluster number of a ladder equals  $\frac{n}{2} - 1$ , as it is not difficult to be seen. Note also that clusters coincide with the segments of the form  $C = [\varphi(p_i), \varphi(p_j)]$ , where  $p_i$  and  $p_j$  have opposite type (a minimum and a maximum) and there are no other critical levels of  $\varphi$  in  $C$ .

**Theorem 7.3.** *Let  $a = (\varphi, \nu) \in \mathcal{A}^+$  be a positive ribbon. Then the inequality*

$$\gamma(a) \geq \delta(a)$$

*holds true.*

*Proof.* We shall carry out induction on the lexicographic order of  $a$ . If  $a$  is the minimal ribbon, we have  $\gamma(a) = \delta(a) = 0$ . For alternations  $a \in \mathcal{A}^+$  one has  $\gamma(a) = \delta(a) = 1$ . So, the inequality is true for irreducible ribbons in  $\mathcal{A}^+$ . Suppose the proposition is true for ribbons  $b$  such that  $b \prec a$  and  $a$  is reducible. Let  $f : \mathbb{B}^2 \rightarrow \mathbb{R}$  be an economic extension of  $a$ :  $f \in \mathcal{F}^e(a)$  realizing  $\gamma(a)$ . Then  $f$  has a regular level  $l$  such that for the corresponding splitting  $a = a_1 \# a_2$  we have  $a_1 \prec a$ ,  $a_2 \prec a$ . (Note that  $f$  has no touching level lines, since  $a \in \mathcal{A}^+$  and has no negative nodes). Then by the induction hypothesis  $\gamma(a_i) \geq \delta(a_i)$ ,  $i = 1, 2$ . By [Lemma 6.6](#) we have  $\gamma(a) = \gamma(a_1 \# a_2) = \gamma(a_1) + \gamma(a_2)$ , since  $f$  is realizing  $\gamma(a)$ . It is clear also



that  $\delta(a_1) + \delta(a_2) \geq \delta(a)$ , as any cluster of  $\omega$  is a cluster either of  $\omega_1$  or of  $\omega_2$ , where  $\omega_i$  is the level system of  $a_i$ . Finally

$$\gamma(a) = \gamma(a_1) + \gamma(a_2) \geq \delta(a_1) + \delta(a_2) \geq \delta(a).$$

The theorem is proved.  $\square$

This theorem will be obtained in a different way in [Section 23](#) where some maximal property of  $\gamma$  among all *ribbon-type* invariants is proved. Note also that the cluster number is actually estimating from below the number of different *critical values*, rather than the number of critical points.

It turns out that in class  $\mathcal{A}^+$  the cluster number  $\delta$  is a consistent estimate of  $\gamma$  from below in many cases. Of course, for the majority ribbons in  $\mathcal{A}^+$  we have  $\gamma \gg \delta$ . For example it is not difficult to construct ribbons with  $\delta = 2$  and arbitrarily large  $\gamma$ , it suffices to make function  $\varphi$  oscillate between two “cluster values” many times. On the other hand, ribbons from  $\mathcal{A}^+$  with  $\gamma = \delta$  have some interesting properties. We shall call them *quasi-ladders*. For true ladders we have  $\gamma = \delta = \frac{n}{2} - 1$ . The elements of  $\mathcal{A}_n^+$  with maximal ribbon invariant  $\gamma$  are true ladders.

It would be interesting to find the mathematical expectation of  $\frac{\delta}{n}$  in class  $\mathcal{A}^+$ . A much harder problem is to find the expectation of  $\frac{\gamma}{n}$  in class  $\mathcal{A}$ .

Let now  $a \in \mathcal{A}$  be an arbitrary ribbon. Then the inequality  $\gamma(a) \geq \delta(a)$  fails. For example, take some function  $f : \mathbb{B}^2 \rightarrow \mathbb{R}$  without critical points and consider the ribbon  $a$  defined by  $f$ . Then  $\gamma(a) = 0$ , while  $\delta(a)$  may be arbitrarily large. Anyway, it is possible to define a variant of the cluster number that gives estimation from below of  $\gamma(a)$  in this case.

**Definition 7.4.** Let  $a = (\varphi, \nu)$  be a ribbon with nodes  $p_1, \dots, p_n$ , where  $n \geq 4$ . Consider the level system  $\omega$  of  $a$  and the subsystem  $\omega_0 \subset \omega$  with elements of the type  $[\varphi(p_i), \varphi(p_{i+1})]$  where  $p_i, p_{i+1}$  are positive nodes and  $[\varphi(p_i), \varphi(p_{i+1})]$  does not contain any  $\varphi(p_j)$ , where  $p_j$  varies among all negative nodes. Then the reduced cluster number of  $a$  is defined by  $\delta_0(a) = \delta(\omega_0)$ . Clearly,  $\delta_0(a) = \delta(a)$  for  $a \in \mathcal{A}^+$ . It may be proved that the reduced cluster number gives estimation from below of  $\gamma$ :

**Theorem 7.5.** The inequality  $\gamma \geq \delta_0$  holds in class  $\mathcal{A}$  of arbitrary ribbons.

We shall omit the proof as it follows almost literally that of [Theorem 7.3](#). So, it turns out that  $\delta_0$  is an a priori estimate for  $\gamma$ . It can be easily shown that  $\delta_0$  is a ribbon invariant; however, it is not a quite consistent estimate for  $\gamma$  (in general,  $\gamma$  is much greater than  $\delta_0$ ). Anyway, it may be useful in some situations, especially for proving that  $\gamma > 0$  for a given ribbon.

In fact, the above inequality may be specified as follows:

$$\gamma \geq \beta \geq \delta_0,$$

where  $\beta$  is the minimal number of critical values of all extensions of the ribbon (see [Section 2](#)). It turns also that in class  $\mathcal{A}^+$  the invariant  $\beta$  equals exactly the cluster number  $\delta$ :

**Theorem 7.6.** For any ribbon  $a \in \mathcal{A}^+$  we have  $\beta(a) = \delta(a)$ .

## 8. GENERAL ESTIMATES OF $\gamma$

We shall establish here some general inequalities involving the ribbon invariant.

Let the ribbon  $a \in \mathcal{A}_n$  have  $s_+$  positive and  $s_-$  negative nodes (so,  $n = s_+ + s_-$ ). The signature  $\sigma(a)$  is defined by

$$\sigma(a) = s_+ - s_-.$$

Note that  $\sigma$  is an even number. It turns out that the signature is an useful invariant, as it is involved in many results about  $\gamma$ . One of the reasons for this is the following fact:

**Proposition 8.1.** *Let  $a \in \mathcal{A}$  and  $f \in \mathcal{F}(a)$ . Then*

$$\deg(\nabla f|_{\mathbb{S}^1}) = 1 - \frac{\sigma}{2},$$

where  $\sigma = \sigma(a)$  is the signature of  $a$ .

For example, if  $a$  is the minimal ribbon, we have  $\sigma = 2$ , so the above degree is 0, which agrees with the fact that there is an extension without critical points. We shall omit the proof of the proposition, as this is a common fact that becomes evident from a simple calculation of the degree. Let us note some immediate corollaries from this proposition.

**Fact 8.2.** *Let  $f \in \mathcal{F}(a)$  have a finite number of critical points. Then the algebraic sum of their indices equals  $1 - \frac{\sigma}{2}$ , where  $\sigma = \sigma(a)$ .*

This is an immediate corollary from Hopf's Theorem and [Proposition 8.1](#).

**Fact 8.3.** *If  $\gamma(a) = 0$ , then  $\sigma(a) = 2$ .*

This is equally clear, since if there is a critical points free  $f \in \mathcal{F}(a)$ , then  $\deg(\nabla f|_{\mathbb{S}^1}) = 0$  and [Proposition 8.1](#) implies  $\sigma = 2$ .

Note that the converse is *not* true and this is one of the motivating reasons for the appearance of this article. It suffices to look at the ribbon from [Fig. 19](#) where  $\sigma = 2$ , but  $\gamma > 0$ , as it was shown previously in the text. Another almost trivial situation is a ribbon with  $\sigma = 2$  which has a negative minimal or maximal node. Then it is obvious that any extension should have a critical point, so  $\gamma > 0$ .

For a given ribbon  $a$ , it is convenient to denote

$$i(a) = 1 - \frac{\sigma(a)}{2}.$$

We shall call  $i(a)$  *index* of  $a$ . Note that the signature  $\sigma$  is not additive under splittings, while the index is.

**Lemma 8.4.** *a)  $i(a_1 \# a_2) = i(a_1) + i(a_2)$ , b)  $i(a_1 * a_2 * a_3) = i(a_1) + i(a_2) + i(a_3)$ .*

As this is a common property of the degree, we leave the proof of [Lemma 8.4](#) to the reader.

It is a simple observation that the signature has some nontrivial topological meaning concerning the ribbon space  $\mathcal{A}$ . In fact, under some natural convention about the admissible moves in  $\mathcal{A}$ , it turns out that

*the subspaces of  $\mathcal{A}$  of fixed signature  $\sigma$  are in fact the components of space  $\mathcal{A}$ .*

Here we explain in brief the situation. Let us allow, for the moment, ribbons with coinciding critical values as well as "birth-death" of a pair of consecutive nodes of type  $(p_i^+ p_{i+1}^-)$  or  $(p_i^- p_{i+1}^+)$ , which operation does not affect any of the ribbon invariants. Then it is not difficult to see that any two ribbons  $a, b$  of the same signature  $\sigma(a) = \sigma(b)$  may be connected by a path in  $\mathcal{A}$ , and of course, if

$\sigma(a) \neq \sigma(b)$  this cannot be done. The topology of the ribbon space  $\mathcal{A}$  will be considered in more detail in Part II.

The following is the main general inequality for the ribbon invariant.

**Theorem 8.5.** *For any ribbon the following inequality holds*

$$1 - \frac{\sigma}{2} \leq \gamma \leq n - 1 - \frac{\sigma}{2}. \quad (1)$$

*Proof.* We proceed by induction on the ordering of  $\mathcal{A}$ . Consider the first part  $1 - \frac{\sigma}{2} \leq \gamma$ , that is in fact  $i \leq \gamma$ . For irreducible ribbons it is obvious. Let  $a \in \mathcal{A}$  be a reducible one and suppose the inequality is true for any  $b \in \mathcal{A}$  with  $b \prec a$ . Let  $f \in \mathcal{F}(a)$  is realizing  $\gamma(a)$ . Then there is a non-critical level line  $l$  (either regular, or touching) such that after splitting  $a$  along  $l$ ,  $a = a_1 \# a_2$  or  $a = a_1 * a_2 * a_3$  we have  $a_k \prec a$ ,  $\forall k$ . By induction hypothesis  $i(a_k) \leq \gamma(a_k)$ ,  $k = 1, 2, 3$ , so

$$i(a) = i(a_1 \# a_2) = i(a_1) + i(a_2) \leq \gamma(a_1) + \gamma(a_2) = \gamma(a), \text{ or}$$

$$i(a) = i(a_1 * a_2 * a_3) = i(a_1) + i(a_2) + i(a_3) \leq \gamma(a_1) + \gamma(a_2) + \gamma(a_3) = \gamma(a),$$

which proves the first part. Note that for the last equalities we make use of [Lemma 6.6](#). Consider now the second part  $\gamma \leq n - 1 - \frac{\sigma}{2}$ , which is equivalent to  $\gamma \leq n - 2 + i$ . As above, it is clear for irreducible ribbons. Under the above assumptions, take a reducible  $a \in \mathcal{A}$  and consider first a binary splitting  $a = a_1 \# a_2$ . Let  $n_1, n_2$  be the number of nodes of  $a$ , lying respectively in  $a_1, a_2$ , then the number of nodes of  $a_1, a_2$  equals  $n_1 + 1, n_2 + 1$ , respectively. Now

$$\gamma(a) \leq \gamma(a_1) + \gamma(a_2) \leq n_1 + 1 - 2 + i(a_1) + n_2 + 1 - 2 + i(a_2) = n - 2 + i(a).$$

Consider now a ternary splitting  $a = a_1 * a_2 * a_3$ . If as above  $n_i$  is the number of nodes of  $a$ , lying in  $a_k$ , then the number of nodes of  $a_k$  equals  $n_k + 1$ . Note that  $n = n_1 + n_2 + n_3 + 1$ . Then we have  $\gamma(a_k) \leq n_k + 1 - 2 + i_k = n_k - 1 + i_k$  by induction hypothesis. Now one has

$$\gamma(a) \leq \gamma(a_1) + \gamma(a_2) + \gamma(a_3) \leq n_1 + n_2 + n_3 - 3 + i(a) = n - 4 + i(a) < n - 2 + i(a).$$

The theorem is proved.  $\square$

Let us make some remarks about this inequality and its proof.

We shall show later, that in fact any  $f \in \mathcal{F}(a)$  has  $\geq 1 - \frac{\sigma}{2}$  local extrema.

Note that in the second part we may take  $f \in \mathcal{F}(a)$  simply being an economic extension, not supposing that it is realizing  $\gamma(a)$ . In such a way, we prove that for any economic  $f \in \mathcal{F}(a)$  with  $\Gamma$  critical points we have

$$1 - \frac{\sigma}{2} \leq \Gamma \leq n - 1 - \frac{\sigma}{2},$$

as  $\gamma(a) \leq \Gamma$ . Note also that in the final part of the proof there is a ‘‘gap’’ of 2 units, that will be important for us in order to improve the second part of the inequality by reducing the upper limit. In some cases the quantity  $n - 1 - \frac{\sigma}{2}$  is too big and gives an inconsistent estimate of  $\gamma$  from above. For example if  $a \in \mathcal{A}^-$ , we have  $\sigma = -n$  and we get  $\frac{3n}{2} - 1$  as an upper limit for  $\gamma(a)$ , which is very far from reality, since later we show that  $\gamma = \frac{n}{2} + 1$  in class  $\mathcal{A}^-$  (and in general  $\gamma \leq \frac{n}{2} + 1$ ).

The first part  $\gamma \geq 1 - \frac{\sigma}{2}$  gives a simple ‘‘a priori’’ estimate of  $\gamma$  and makes sense only for  $\sigma \leq 0$ . It does not depend on the  $C^0$ -data of the ribbon. Later we shall explore it to estimate the number of critical points of a function on the 2-sphere. Note also that not all non-negative integers in  $[1 - \frac{\sigma}{2}, n - 1 - \frac{\sigma}{2}]$  arise as a ribbon invariant of a ribbon with corresponding data  $n, \sigma$ . It even happens that not all

such integers arise as the number of critical points of an economic extension of a ribbon with the corresponding data. For example, there are no economic extensions with  $\Gamma = 1$  critical points of a ribbon with  $\sigma = 2$  although  $1 \in [0, n - 2]$ . It implies that  $\gamma = 1$  is not a realizable value among all ribbons with  $\sigma = 2$ . This is easily seen from the fact that  $i(a) = 1 - \frac{\sigma}{2} = 0$ , so supposing that there is an economic extension with unique critical point  $p$ , then the index of  $p$  should equal zero. But this is impossible in the economic class.

In order to improve the second part of the general inequality (1) we shall define another invariant of a ribbon  $a$ , counting the maximal possible number of touching lines among all extensions of  $a$ .

**Definition 8.6.** *Let  $a \in \mathcal{A}$  be a ribbon, then by  $t(a)$  we shall denote the maximal possible number of regular touching lines of  $f$ , when  $f \in \mathcal{F}^e(a)$  varies among all economic extensions of  $a$ . We shall call  $t(a)$  “touching number” of ribbon  $a$ .*

For example, for the ribbon from Fig. 19 we have  $t = 1$ , since  $t = 2$  is contradictory, as shown at Fig. 20.

**Remark.** *As in the case of  $\gamma$ , it may be shown that  $t(a)$  has the same value when varying  $f$  among all extensions  $f \in \mathcal{F}(a)$ , not only the economic ones. Anyway, this won't be of crucial importance for us, so we shall not prove it here.*

**Proposition 8.7.** *For any ribbon we have*

$$\gamma \leq n - 1 - \frac{\sigma}{2} - 2t, \quad (2)$$

where  $t$  is the touching number of the ribbon.

*Proof.* To get this improved variant of (1), one has only to notice that in the proof of the last inequality there is a “gap” of 2 units (in our favor) and this is due to the fact that we are splitting along a regular touching line. Now, if we take  $f \in \mathcal{F}^e(a)$  with  $t = t(a)$  such lines, we get a “gap” of  $2t$  units, which gives the improved inequality (2).  $\square$

To demonstrate the consistency of (2), take an arbitrary  $a \in \mathcal{A}^-$ . It may be shown that in this case  $t = \frac{n}{2} - 1$ , so (2) gives  $\gamma \leq n - 1 + \frac{n}{2} - n + 2 = \frac{n}{2} + 1$ , which is in fact the right value of  $\gamma$ , in contrast with the non improved version, which gave  $\frac{3n}{2} - 1$  as an upper limit for  $\gamma$ .

It seems that the “simple” inequality  $\gamma \leq \frac{n}{2} + 1$  for arbitrary ribbons is the hardest one to prove, as it is not affordable by induction. It will be proved later (Theorem 15.4), but we shall use it in advance. By the way, a simple calculation based on (2) shows that  $t \geq \frac{\sigma}{2} - 1$  implies  $\gamma \leq \frac{n}{2} + 1$ , but this is equally hard.

**Proposition 8.8.** *a)  $\gamma \leq \frac{n}{2} - 1$  for  $a \in \mathcal{A}^+$     b)  $\gamma = \frac{n}{2} + 1$  for  $a \in \mathcal{A}^-$*

*Proof.* a) In this case  $\sigma = n$  and by the general inequality (1) we have  $\gamma \leq \frac{n}{2} - 1$ . b) Now  $\sigma = -n$  and the first part of (1) gives  $\gamma \geq \frac{n}{2} + 1$ , thus  $\gamma = \frac{n}{2} + 1$ . We show later that any  $a \in \mathcal{A}^-$  has in fact at least  $\frac{n}{2} + 1$  local extrema.  $\square$

This proposition means that the class  $\mathcal{A}^+$  is, in some sense, more interesting than class  $\mathcal{A}^-$ , since for the latter  $\gamma$  is computed and does not depend on the  $C^0$ -part of the boundary data.

As a consequence of a) we get also that  $\gamma = \frac{n}{2} - 1$  for positive ladders. Indeed, we have  $\gamma \geq \delta = \frac{n}{2} - 1$ , which combined with a) gives  $\gamma = \frac{n}{2} - 1$ .

**The involution**  $a \rightarrow \bar{a}$ .

Let us define an useful involution in  $\mathcal{A}$ .

**Definition 8.9.** Let  $a = (\varphi, \nu) \in \mathcal{A}$ , then set  $\bar{a} = (\varphi, \bar{\nu})$ , where  $\bar{\nu} = -\nu$ .

In such a way  $a \rightarrow \bar{a}$  is changing the marking of any node to the opposite one.

**Proposition 8.10.** Let  $a \in \mathcal{A}$  be a ribbon with signature  $\sigma \neq \pm 2$ . Then we have

$$\gamma(a) + \gamma(\bar{a}) \geq 2 + \frac{|\sigma|}{2}.$$

*Proof.* Note that  $\sigma(\bar{a}) = -\sigma(a)$ . We may assume that  $\sigma < 0$ , then by [Theorem 8.5](#)  $\gamma(a) \geq 1 - \frac{\sigma}{2} = 1 + \frac{|\sigma|}{2}$ . But  $\gamma(\bar{a}) \geq 1$ , since  $\sigma \neq \pm 2$ , whence  $\gamma(a) + \gamma(\bar{a}) \geq 2 + \frac{|\sigma|}{2}$ .  $\square$

This simple inequality will be useful for the estimation of the number of critical points on the 2-sphere in [Section 16](#).

Let us finally ask some curious question of geometric nature.

Let us call a ribbon  $a = (\varphi, \nu) \in \mathcal{A}$  *harmonic* if the (unique) solution  $f$  of the Dirichlet problem  $\Delta f = 0$ ,  $f|_{\mathbb{S}^1} = \varphi$  is inducing ribbon  $a$  itself on  $\mathbb{S}^1$ . Clearly, not any ribbon is harmonic, as simple examples show. So,

*Describe the class of harmonic ribbons.*

As the answer may sensibly depend on the  $C^0$ -part of the ribbon, here is a discrete version of the problem:

*Describe the class of discrete ribbons which are similar to a harmonic one.*

## 9. THE RIBBON INVARIANTS $\gamma_0$ , $\gamma_{\text{ext}}$ , $\gamma_{\text{sad}}$

Let  $a \in \mathcal{A}$  be a ribbon. One may be interested in extensions  $f \in \mathcal{F}(a)$ , which are Morse functions and to look for the minimal possible number of critical points in this class.

**Definition 9.1.** Let  $a = (\varphi, \nu) \in \mathcal{A}$  be a ribbon. Then we shall denote by  $\gamma_0(a)$  the minimal number of critical points of  $f$ , where  $f : \mathbb{B}^2 \rightarrow \mathbb{R}$  varies among all Morse functions  $f \in \mathcal{F}(a)$ .

The class of Morse functions  $f \in \mathcal{F}(a)$  will be denoted by  $\mathcal{F}_0(a)$ . Of course, here  $f$ 's are Morse functions in the context of manifolds with boundary. These have only non degenerate saddles and local extrema as critical points.

It is clear that  $\gamma_0$  is finite and  $\gamma_0 \geq \gamma$ . It turns out that  $\gamma_0$  is an invariant, which is interesting for itself, as the computation of  $\gamma$  does *not* imply automatic computation of  $\gamma_0$ , and conversely. Anyway, the algorithm for  $\gamma$  may be adapted to  $\gamma_0$  with minor changes. Of course, it is possible that  $\gamma_0 = \gamma$ , but in general  $\gamma_0 > \gamma$ .

**Fact 9.2.**  $\gamma = 0$  is equivalent to  $\gamma_0 = 0$ .

**Fact 9.3.** For  $a \in \mathcal{A}^+$ ,  $\gamma_0 = \frac{n}{2} - 1$ .

**Fact 9.4.** For  $a \in \mathcal{A}^-$ ,  $\gamma_0 = \gamma = \frac{n}{2} + 1$ .

**Fact 9.5.** For positive ladders  $\gamma_0 = \gamma = \frac{n}{2} - 1$ .

**Fact 9.6.** For alternations  $\gamma_0 = \frac{n}{2} - 1 \geq 1 = \gamma$ .

These facts are almost clear, the first one is obvious, the second follows from the fact that the minimizing Morse extension  $f \in \mathcal{F}_0(a)$  has only non-degenerate saddles and no extrema, the third one follows from [Proposition 8.8](#) and the observation that the extension realizing  $\gamma$  is Morse and the other two follow easily from our further investigations.

**Proposition 9.7.** *The next properties of  $\gamma_0$  hold*

$$a) \gamma_0 \geq \left|1 - \frac{\sigma}{2}\right|, \quad b) \gamma_0 \equiv \left(1 - \frac{\sigma}{2}\right) \pmod{2}$$

$$c) \gamma_0 \leq n - 1 - \frac{\sigma}{2} - 2t, \quad \text{where } t \text{ is the touching number.}$$

*Proof.* Let  $a \in \mathcal{A}$  be a ribbon and  $f \in \mathcal{F}_0(a)$  be a Morse extension realizing  $\gamma_0(a)$ . Let  $f$  have  $m$  local extrema and  $k$  saddles. Then  $\gamma_0 = m + k$ , the index  $i(a) = m - k = 1 - \frac{\sigma}{2}$ , thus

$$\gamma_0 = m + k \geq |m - k| = \left|1 - \frac{\sigma}{2}\right|,$$

which proves a) and

$$\gamma_0 = m + k \equiv (m - k) \pmod{2} = \left(1 - \frac{\sigma}{2}\right) \pmod{2},$$

which proves b). To show c), it is enough to prove it for irreducible ribbons and then to follow the proof of [Proposition 8.7](#). For the 3 small irreducible ribbons it is obvious. Take now an alternation  $a \in \mathcal{A}_n^+$ , then as following from [Fact 8.1](#),  $\gamma_0(a) = \frac{n}{2} - 1$ , and since  $\sigma = n$ ,  $t = 0$ , c) is fulfilled.  $\square$

Note that neither a), nor b) is true for  $\gamma$ . Indeed, a) fails for any alternation with  $\geq 6$  nodes and b) fails for an alternation with 6 nodes (or with  $4k + 2$  nodes). We shall show later that  $\gamma_0 \leq \frac{n}{2} + 1$ .

Note also that the gap between  $\gamma_0$  and  $\left|1 - \frac{\sigma}{2}\right|$  may be done large ( $\sim \frac{n}{2}$ ). This is equally true for  $\gamma$ . In [Section 19](#) we construct a ribbon with  $\gamma = \gamma_0 \sim \frac{n}{2}$  and  $\sigma = 2$ .

It is clear, that  $\gamma_0$  is very similar to  $\gamma$  and many of the results for  $\gamma$  may be automatically transferred to  $\gamma_0$ .

**Proposition 9.8.** *For any ribbon  $a \in \mathcal{A}$  there is an economic extension  $f \in \mathcal{F}_0(a)$  realizing  $\gamma_0(a)$ . The invariant  $\gamma_0$  is subadditive under splittings*

$$\gamma_0(a_1 \# a_2) \leq \gamma_0(a_1) + \gamma_0(a_2), \quad \gamma_0(a_1 * a_2 * a_3) \leq \gamma_0(a_1) + \gamma_0(a_2) + \gamma_0(a_3).$$

*If the splitting is along a level line of an extension  $f \in \mathcal{F}_0(a)$  realizing  $\gamma_0$ , then equality occurs in the above formulas.*

The proof follows step by step the proof of the corresponding proposition about  $\gamma$ .

**Proposition 9.9.** *For any ribbon  $a \in \mathcal{A}$ ,*

$$\gamma_0(a) + \gamma_0(\bar{a}) \geq |\sigma|.$$

*Proof.* By [Proposition 9.7](#), a)  $\gamma_0(a) + \gamma_0(\bar{a}) \geq \left|1 - \frac{\sigma}{2}\right| + \left|1 + \frac{\sigma}{2}\right| = 2\left\lceil \frac{|\sigma|}{2} \right\rceil = |\sigma|$ . The equality holds, since  $\frac{\sigma}{2}$  is integer.  $\square$

Note that in case  $\sigma = 0$ , still  $\gamma_0(a) + \gamma_0(\bar{a}) \geq 2$ , as  $\gamma_0(a) + \gamma_0(\bar{a}) \geq \gamma(a) + \gamma(\bar{a}) \geq 2$  (Proposition 8.10).

Now we introduce two other invariants, estimating from below the number of local extrema and saddle points of a given ribbon's extension.

**Definition 9.10.** Let  $a = (\varphi, \nu) \in \mathcal{A}$  be a ribbon. Then  $\gamma_{\text{ext}}(a)$  will denote the minimal number of local extrema of  $f$ , when  $f$  varies among all extensions  $f \in \mathcal{F}(a)$ . Similarly, by  $\gamma_{\text{sad}}(a)$  we shall denote the minimal number of saddle points of function  $f$ , when  $f$  varies among all economic extensions  $f \in \mathcal{F}^e(a)$ .

**Remark.** For the definition of  $\gamma_{\text{sad}}$  one has to consider economic extensions, as we may always “destroy” saddle points at the price of the appearance of infinite number of critical points, while  $\gamma_{\text{ext}}$  is stable under such perturbations.

Evidently,  $\gamma_{\text{ext}} = 0$  in  $\mathcal{A}^+$  and  $\gamma_{\text{sad}} = 0$  in  $\mathcal{A}^-$ .

Note also that similarly to  $\gamma$  and  $\gamma_0$ , the invariants  $\gamma_{\text{ext}}$  and  $\gamma_{\text{sad}}$  satisfy the inequalities in Proposition 9.8, i.e. these are subadditive under splittings.

It turns out that the general estimate from below for  $\gamma$  is in fact an estimate for the number of local extrema. Also, there is an estimate from below of  $\gamma_{\text{sad}}$  involving the cluster number  $\delta$ .

Note that even in case  $\sigma = 2$ , it may happen  $\gamma_{\text{ext}} > 0$ . For example for  $a = (1^+, 6^+, 2^-, 4^+, 3^+, 5^-)$  it holds that  $\gamma_{\text{ext}} = \gamma_{\text{sad}} = 1$ ,  $\gamma = \gamma_0 = 2$ , although  $\sigma = 2$ .

**Proposition 9.11.** For the touching number we have

$$a) t = \frac{1}{2}(n - \sigma) - \gamma_{\text{ext}} \quad b) t \leq \frac{n}{2} - 1.$$

*Proof.* To prove a), it suffices to note that  $t + \gamma_{\text{ext}} = s_- = \frac{1}{2}(n - \sigma)$ , since maximizing  $t$  means minimizing  $\gamma_{\text{ext}}$ . Now Proposition 9.12 and a) immediately imply  $t \leq \frac{n}{2} - 1$ .  $\square$

**Proposition 9.12.** For any ribbon  $a \in \mathcal{A}$ ,

$$1) \gamma_{\text{ext}}(a) \geq 1 - \frac{\sigma}{2} \quad 2) \gamma_{\text{sad}}(a) \geq \delta_0(a) + \frac{1}{2}(\sigma - n). \quad (3)$$

*Proof.* 1) For irreducible ribbons it is obvious. Now we have only to follow literally the proof of the first part of Theorem 8.5. 2) Recall that  $\delta_0(a)$  denotes the reduced cluster number (see Section 7). As we noted above,  $s_- = \frac{1}{2}(n - \sigma)$ , so the wanted inequality is equivalent to  $\gamma_{\text{sad}} \geq \delta_0 - s_-$ . Now, this is almost obvious: indeed, for a given extension  $f$ , to any principal cluster should be attached at least one critical point (of saddle type), but the number of such clusters is clearly  $\geq \delta_0 - s_-$ .  $\square$

**Remark.** The maximal possible number of nondegenerate saddles of extensions  $f \in \mathcal{F}^e(a)$  equals  $\gamma_{\text{ext}}(a) + \frac{\sigma}{2} - 1$ . Indeed, for any  $f \in \mathcal{F}^e(a)$  we may perform a morsification of saddles and get some  $f' \in \mathcal{F}^e(a)$  with  $m$  extrema and  $k$  saddles. Then by Hopf Theorem,  $m - k = i = 1 - \frac{\sigma}{2}$ . The minimal possible value of  $m$  is  $\gamma_{\text{ext}}(a)$  and, clearly, minimizing  $m$  means maximizing  $k$ , hence the maximal value of  $k$  equals  $\gamma_{\text{ext}}(a) + \frac{\sigma}{2} - 1$ . Note that according to Proposition 9.12 1), this number is nonnegative. Note also that we get the same number if  $f$  varies in the class  $\mathcal{F}(a)$  of all extensions, not only the economic ones.

In order to measure the gap between  $\gamma_0$  and  $\gamma$  it is convenient to introduce the compression  $\varkappa$  of a ribbon, defined as follows. Let  $a$  be a ribbon and  $f \in \mathcal{F}^e(a)$ .

For any saddle  $P$  of  $f$  with  $k$  separatrices, define  $\varkappa(P) = \frac{k}{2} - 2$ . Note that  $\varkappa(P)$  is the number of new born critical points through a “morsification” of saddle  $P$ . Now let  $\varkappa(f)$  be the sum  $\sum \varkappa(P_i)$ , where the sum runs over all saddles of  $f$ . Set finally

$$\varkappa(a) = \max\{\varkappa(f) \mid f \in \mathcal{F}^e(a)\}.$$

It is clear that  $\varkappa(a)$  is a finite number, since the number of critical points of economic extensions is bounded from above by  $\frac{3n}{2} - 1$ . We call  $\varkappa(a)$  *compression* of ribbon  $a$ . For example, the compression of a ladder is 0, while the compression of an alternation is  $\frac{n}{2} - 2$ .

**Proposition 9.13.** 1)  $\gamma \geq \gamma_{\text{ext}} + \gamma_{\text{sad}}$     2)  $\gamma_0 - \gamma \leq \varkappa$ .

*Proof.* 1) This is almost obvious, just consider some  $f \in \mathcal{F}^e(a)$  realizing  $\gamma(a)$ , then the number of extrema and saddles of  $f$  is greater or equal to  $\gamma_{\text{ext}}$  and  $\gamma_{\text{sad}}$ , respectively. 2) Let  $f \in \mathcal{F}^e(a)$  be realizing  $\gamma(a)$  and has  $m$  extrema and  $k$  saddles, so  $\gamma = m + k$ . Perform a “morsification” of  $f$ , then it is easy to see that the “increment” of critical points is exactly  $\varkappa(a)$ . But then one has  $m + k + \varkappa \geq \gamma_0$ , whereby  $\varkappa \geq \gamma_0 - \gamma$ .  $\square$

Note that it may happen for some ribbons that  $\gamma > \gamma_{\text{ext}} + \gamma_{\text{sad}}$ . Here is a corresponding example.

**Example 9.14.** Let  $a = (\varphi, \nu) \in \mathcal{A}_8$  be a general alternation

$$a = (p_1^-, p_2^+, p_3^+, p_4^+, p_5^-, p_6^+, p_7^+, p_8^+)$$

such that  $\varphi(p_5)$  is a minimum, which is the closest one to  $\varphi(p_1) = \min \varphi$  (see Fig. 27). Then it is not difficult to see that  $\gamma_{\text{ext}} = \gamma_{\text{sad}} = 1$ , while  $\gamma = 3$ . This is evident from Fig. 28 where the only 2 minimal economic extensions are depicted. The second one shows that  $\gamma_0 = \gamma = 3$ .

This example shows that the knowledge of a solution for  $\gamma$  does not automatically solve the problem with either  $\gamma_0$ ,  $\gamma_{\text{ext}}$  or  $\gamma_{\text{sad}}$ . In some sense, we have four, more or less, independent problems and the calculation of some of the ribbon invariants does not imply anything about the other three, except the obvious inequalities.

**Remark.** We cannot estimate from below the number of either local maxima or local minima of an extension separately, but only their sum:  $\gamma_{\text{ext}} \geq 1 - \frac{\sigma}{2}$ . In fact, for any ribbon with positive maximal node we may find an extension without local maxima at all. Surely, the same is equally true for local minima. This is easily seen for ladders and then for an arbitrary ribbon  $a$  it follows from the fact that we may obtain it from a ladder  $b$  by performing only “meetings”. Then any solution for  $b$  remains valid for  $a$  as well, since the old “contact zones” of the ribbon remain untouched along such a move.

Of course, one may formally define “invariants”  $\gamma_{\text{max}}$ ,  $\gamma_{\text{min}}$  estimating from below the number of maxima (minima) of a ribbon’s extensions, but then these become almost trivial in view of the above remark and depend only on whether the maximal (negative) node of the ribbon is positive or negative (and take value 0 or 1). On the other hand, albeit elementary,  $\gamma_{\text{max}}$  and  $\gamma_{\text{min}}$  are examples of *algebraic* ribbon invariants (Section 23) with the corresponding normalization rules on elementary



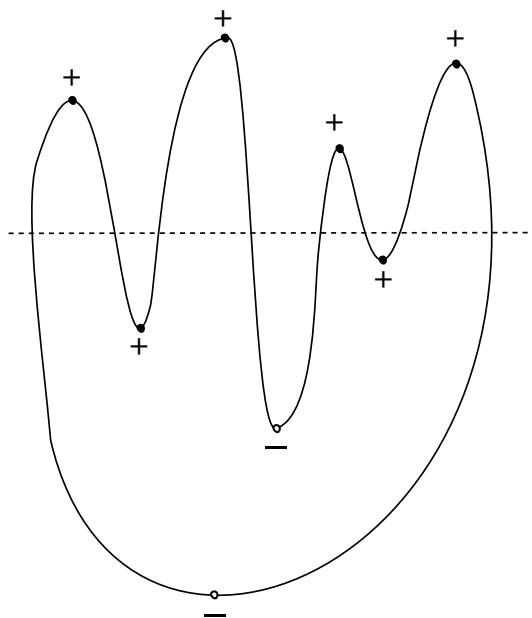

FIGURE 27. A ribbon for which  $\gamma > \gamma_{\text{ext}} + \gamma_{\text{sad}}$ .

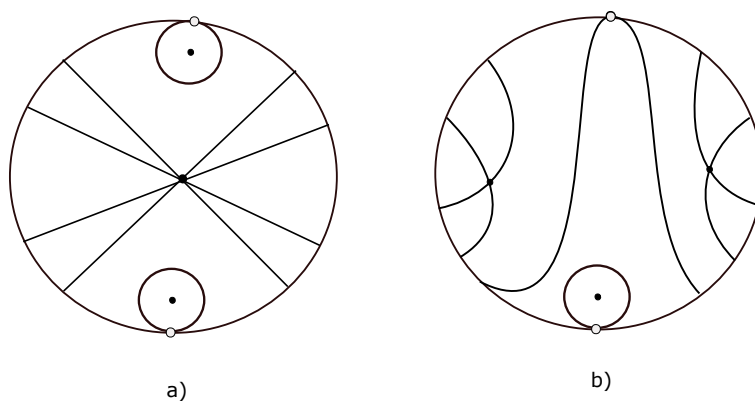

FIGURE 28. a)  $\gamma_{\text{sad}} = 1$ , b)  $\gamma_{\text{ext}} = 1$ , but  $\gamma = 3$ .

ribbons. For example, for  $\gamma_{\text{min}}$  the normalization should be  $\gamma_{\text{min}}(\alpha_0) = \gamma_{\text{min}}(\alpha_1) = 0$ ,  $\gamma_{\text{min}}(\alpha_2) = 1$ ,  $\gamma_{\text{min}}(\beta_n) = 0$ .

Now we shall give a general estimate of  $\gamma$ , which is an improvement of the basic estimate (1) and involves  $\gamma_{\text{ext}}$  and  $\gamma_{\text{sad}}$ .

**Theorem 9.15.** *It holds that*

$$1 - \frac{\sigma}{2} + \gamma_{\text{sad}} \leq \gamma \leq -1 + \frac{\sigma}{2} + 2\gamma_{\text{ext}}.$$

*Proof.* The first part is easy,  $\gamma \geq \gamma_{\text{ext}} + \gamma_{\text{sad}} \geq 1 - \frac{\sigma}{2} + \gamma_{\text{sad}}$  (Proposition 9.12). For the second part, combine  $\gamma \leq n - 1 - \frac{\sigma}{2} - 2t$  with  $t = \frac{1}{2}(n - \sigma) - \gamma_{\text{ext}}$  (Propositions 8.7, 9.11). It is easy to see that this result is stronger than the basic inequality (Theorem 8.5).  $\square$

The invariants  $\gamma, \gamma_0, \gamma_{\text{ext}}, \gamma_{\text{sad}}$  are almost independent from each other, except for some general inequalities, but there is a common algorithm for their calculation, we have only to assign different weights to the irreducible ribbons and then to proceed by induction on the lexicographic order. This will be explained in Section 12.

**The problem with the realization of a pair  $(\sigma, \gamma)$ .** Consider the general estimate (1) for  $\gamma$ :

$$1 - \frac{\sigma}{2} \leq \gamma \leq n - 1 - \frac{\sigma}{2}.$$

It turns out that for a given  $n$ , not every pair  $(\sigma, \gamma)$  satisfying the above inequality may be realized by some ribbon. Two simple examples are given below:

1.  $(\sigma \neq 2, \gamma = 0)$ . Such pairs are impossible by the basic property of the ribbon invariant  $\gamma = 0 \implies i = 1 - \frac{\sigma}{2} = 0 \implies \sigma = 2$ .
2.  $(\sigma = 2, \gamma = 1)$ . Suppose that there is such a minimal economic extension with unique critical point  $P$ . But then  $i = 0$  and since the sum of the indices of all critical points equals  $i$ , it follows that the index of  $P$  is zero. However, economic extensions don't have such elements, a contradiction. Note that we prove in such a way that there are no economic extensions with  $\sigma = 2$  and unique critical point. So, this situation is, in some sense, *strongly* non-realizable.

Now we shall find an infinite series of non-realizable pairs  $(\sigma, \gamma)$  satisfying the general estimate. It is based on case 2.

**Proposition 9.16.** *There are no ribbons with  $\sigma < 0$  and  $\gamma = 2 - \frac{\sigma}{2}$ .*

*So, the pairs  $(\sigma = -2, \gamma = 3)$ ,  $(\sigma = -4, \gamma = 4)$ ,  $(\sigma = -6, \gamma = 5)$ , ... are all non-realizable, although they are satisfying the general inequality (1).*

*Proof.* Suppose that there is a ribbon  $a$  with  $\sigma < 0$  and  $\gamma = 2 - \frac{\sigma}{2}$ . Take  $f \in \mathcal{F}^e(a)$  with  $2 - \frac{\sigma}{2}$  critical points. By (3) we have  $\gamma_{\text{ext}}(a) \geq 1 - \frac{\sigma}{2}$ , so  $f$  has (at least)  $1 - \frac{\sigma}{2}$  extrema  $P_i$ . Consider the corresponding circles touching the boundary at negative nodes  $p_i$ . Now, make nodes  $p_i$  *positive*, obtaining in such a way some ribbon  $b$  with extension  $g \in \mathcal{F}^e(b)$  with 1 critical point. It is easy to see that the signature of  $b$  is  $\sigma(b) = \sigma + 2(1 - \frac{\sigma}{2}) = 2$ . But this is a contradiction with case 2 considered above. Note that we proved in fact that the pairs  $(\sigma < 0, \gamma = 2 - \frac{\sigma}{2})$  are *strongly* non-realizable, in other words, non-realizable by an economic extension with  $\Gamma = 2 - \frac{\sigma}{2}$  critical points.  $\square$

It is clear that some general question may be asked about the possible pairs  $(\sigma, \gamma)$ :

**Question.** For which pairs  $(\sigma, \gamma)$  do a ribbon exist with signature  $\sigma$  and ribbon invariant  $\gamma$ ?

Another more general problem is to study the topology (the homology) of *rigid* ribbons from class  $\mathcal{A}(\sigma, \gamma)$  containing ribbons with signature  $\sigma$  and ribbon invariant  $\gamma$ . This will be discussed later in Part II. For example, we show that the class of ribbons with a critical points free extension, or equivalently, the ribbons with  $\gamma = 0$ , is a connected subspace of  $\mathcal{A}$  (in the appropriate topology). Equivalently, we may say that the space  $\mathcal{A}(2, 0)$  is connected. Let us ask another natural

**Question.** Is it true that  $\mathcal{A}(\sigma, \gamma)$  has finite number of components?

Note that different questions about realization of the ribbon invariant may be asked, for example:

**Question.** Let  $\sigma$  be fixed and  $t$  be a zig-zag permutation with  $n$  nodes. Then for which numbers  $k \in [1 - \frac{\sigma}{2}, n - 1 - \frac{\sigma}{2}]$  does a marking  $\nu$  of the nodes of  $t$  exist with signature  $\sigma(\nu) = \sigma$ , such that for the corresponding ribbon  $a = (t, \nu)$  we have  $\gamma(a) = k$ ?

To see that this question makes sense and the answer depends essentially on  $t$ , consider the following two examples:

1) Let  $\sigma = 2$  and  $t$  be the alternation with 6 nodes from Fig. 19. Then the “suspected” values are  $k \in \{0, 1, 2, 3, 4\}$ , but only  $\{0, 2, 3\}$  are realizable by a ribbon.

2) Let again  $\sigma = 2$  and  $t$  be a ladder with 6 nodes. Then, as above,  $k \in \{0, 1, 2, 3, 4\}$ , but in this case only  $\{0, 2, 4\}$  are the realizable values of  $\gamma$ .

Note that in both cases  $k = 1$  is a generally forbidden value, as we showed earlier that  $(\sigma = 2, \gamma = 1)$  is an impossible case.

Of course, similar “realization” questions may be asked about the other ribbon invariants.

## 10. ZEROES OF GRADIENT FIELDS ON $\mathbb{B}^2$

The main problem of the present article may be reformulated in terms of some class of vector fields on  $\mathbb{S}^1$  and their gradient extensions on the 2-dimensional disk  $\mathbb{B}^2$ . This class contains the fields which are restriction of gradient ones on the disk. Note that similar problems, in terms of gradient homotopy have been previously investigated by A. Parusiński [10], but therein results seem not to intersect with ours. In fact, the main result in [10] is that any two gradient fields in  $\mathbb{B}^n$  non vanishing on  $\mathbb{S}^{n-1}$  are homotopic by a gradient homotopy non vanishing on  $\mathbb{S}^{n-1} \times [0, 1]$ , but this doesn't tell us anything about the zero set of the gradient fields under consideration. We shall formulate in the present section sufficient conditions for existence of zeroes of a gradient field  $v$  on the disk  $\mathbb{B}^2$  that explore only information from the restriction  $v|_{\mathbb{S}^1}$  and do not correlate in general with the degree  $\deg(v|_{\mathbb{S}^1})$ . It turns out that even in case  $\deg(v|_{\mathbb{S}^1}) = 0$ , it may happen that  $v$  has some minimal (positive) number of zeroes inside  $\mathbb{B}^2$  that cannot be “killed” by a gradient homotopy not disturbing  $v|_{\mathbb{S}^1}$ . Let us note that in the introductory lines in [10] the same problem is formulated, but in our opinion, the author is solving a different one.

The method consists in constructing some ribbon  $a_v$  associated with vector field  $v$  and then computing the ribbon invariant  $\gamma(a_v)$  which guarantees at least  $\gamma(a_v)$  geometrically different zeroes of field  $v$  inside  $\mathbb{B}^2$ . The  $C^0$ -part of ribbon  $a_v$  depends only on the tangential component  $v_\tau = \langle v, \tau \rangle$  of  $v|_{\mathbb{S}^1}$ , where  $\tau$  is the unit tangent vector field on  $\mathbb{S}^1$ , while the  $C^1$ -part depends on the direction of vector  $v$  at the zeroes of  $v_\tau$  on  $\mathbb{S}^1$ .

First we shall describe a simple procedure which associates a permutation to any finite string of different real numbers.

Let  $t = (\alpha_1, \dots, \alpha_n)$  be a string of different reals  $\alpha_i \in \mathbb{R}$ . Define

$$k_i = \# \{s \mid \alpha_s \leq \alpha_i\}$$

and then set  $t^* = (k_1, \dots, k_n)$ . It is easy to see that  $t^*$  is a permutation of  $\{1, 2, \dots, n\}$  which preserves the order in  $t$ . For example, if  $t = (7.1, -0.5, 6.9)$  then  $t^* = (3, 1, 2)$ .

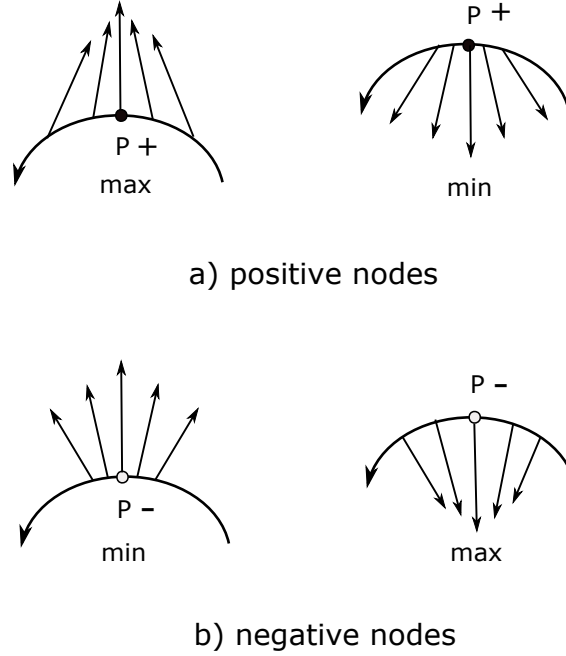
FIGURE 29. Behaviour of field  $v$  at the nodes.

Consider now some generic gradient field  $v : \mathbb{B}^2 \rightarrow \mathbb{R}^2$  which is nonzero at  $\mathbb{S}^1$ . Let  $p_1, \dots, p_n$  be the zeroes of the scalar product  $\langle v|_{\mathbb{S}^1}, \tau \rangle$ , where  $\tau$  is the unit tangent field on  $\mathbb{S}^1$ , we shall refer to them as “nodes”. We suppose that the nodes are cyclically ordered. Note that  $n$  is an even number. Now we shall define some marking  $\nu$  of the nodes following a simple rule.

Let  $p_i$  be a node. Set first  $\text{sign}(p_i) = +1$ , if  $\langle v|_{\mathbb{S}^1}, \tau \rangle$  is changing its sign from  $+$  to  $-$  at  $p_i$ , and  $\text{sign}(p_i) = -1$  otherwise (here the natural parameter is running counter clockwise). Then define

$$\nu(p_i) = \text{sign}(p_i) \cdot \text{sgn} \langle v|_{\mathbb{S}^1}, n \rangle |_{p_i}, \quad (4)$$

where  $n$  is the normal vector field on  $\mathbb{S}^1$ . So we get some marking of the nodes which divides them into “positive” and “negative” ones. The 4 general cases for the behaviour of field  $v|_{\mathbb{S}^1}$  at a node  $p_i$  are depicted at Fig. 29. This defines the  $C^1$ -part of ribbon  $a_\nu$ . Now we define its  $C^0$ -part as follows.

Let  $L_i = [p_1, p_i]$  be the arc of  $\mathbb{S}^1$  between nodes  $p_1$  and  $p_i$ ,  $i = 2, \dots, n+1$  (assuming  $p_{n+1} \equiv p_1$ ). Consider the quantities

$$\alpha_i = \int_{L_i} \langle v|_{\mathbb{S}^1}, \tau \rangle ds$$

which are all different as  $v$  is assumed generic. Note that  $\alpha_{n+1} = \int_{\mathbb{S}^1} \langle v|_{\mathbb{S}^1}, \tau \rangle ds = 0$ , since  $v$  is a gradient field. Consider now the string  $t = (\alpha_2, \dots, \alpha_{n+1})$  and its reduction  $t^*$  which is a permutation of  $\{1, 2, \dots, n\}$ . Observe that  $t^*$  is an alternating permutation, as  $\langle v|_{\mathbb{S}^1}, \tau \rangle$  is changing sign at any node  $p_i$ . We may assume that  $t^*$  is a cyclic alternating permutation.

**Theorem 10.1.** *Let  $a_v \in \mathcal{A}_n$  be the ribbon  $a_v = (t^*, \nu)$  where the marking  $\nu$  is defined by (4). Then field  $v$  has at least  $\gamma(a_v)$  geometrically distinct zeroes inside  $\mathbb{B}^2$ . (Here  $\gamma$  is the main ribbon invariant defined in Section 2.)*

*Proof.* The proof is a straightforward application of the previous results; it suffices to take a function  $F : \mathbb{B}^2 \rightarrow \mathbb{R}$  such that  $\nabla F = v$  and to note that the induced ribbon coincides with  $a_v$  by the construction procedure of the latter.  $\square$

**Remark.** *Similar results hold true for the other ribbon invariants  $\gamma_0, \gamma_{\text{ext}}, \gamma_{\text{sad}}$ .*

## 11. GEOMETRIC RESTATEMENT OF THE PROBLEM

There is a geometric way to state the problem of finding  $\gamma$  and the other ribbon invariants. Although it does not give much for the calculation of  $\gamma$ , this method enlightens the economic extensions from geometric point of view and is suitable for finding solution for small  $n$  “by hand”.

Let  $a = (\varphi, \nu) \in \mathcal{A}$  be a ribbon, so  $\varphi : \mathbb{S}^1 \rightarrow \mathbb{R}$  is a Morse function and  $\nu$  is a marking of the nodes. Let  $Q$  be a polygon inscribed in  $\mathbb{S}^1$ . A vertex of  $Q$  will be called *regular*, if it is not a node. We shall say that  $Q$  is an *iso-gon*, if  $\varphi$  is constant on the set of its vertices. A *0-gon* is a disk touching  $\mathbb{S}^1$  from inside. We distinguish 3 types of such objects, which will play the role of critical points:

- 1) iso-gons with even number of vertices all being regular
- 2) iso-triangles with one vertex being a negative node and two regular vertices
- 3) 0-gons touching  $\mathbb{S}^1$  at a negative node

We shall call such figures *critical elements* of first, second and third kind, respectively. Furthermore, we shall consider *only* critical elements  $Q$  satisfying the following condition:

*each component of  $\mathbb{S}^1 \setminus Q$  contains an odd number of nodes.*

Let  $q = \{Q_i\}$  be a system of critical elements inside  $\mathbb{S}^1$ .

**Definition 11.1.** *We shall call  $q$  packing of  $a$ , if*

- a)  $Q_i$  are disjoint
- b) any negative node belongs to either an iso-triangle, or to a 0-gon from  $q$
- c) each component of  $\mathbb{S}^1 \setminus \cup Q_i$  contains no more than one positive node
- d) each component of  $\mathbb{S}^1 \setminus \cup Q_i$  not containing a positive node touches exactly two elements of  $q$ .

See Fig. 30 and Fig. 31 for examples of packings and no-packings. Of course, the geometric size of the critical elements does not matter to us, so we are treating  $q$  as a purely combinatorial object. Let us note that there is a different way to say that  $q$  is a packing:  $q$  is a *disjoint maximal* (with respect to inclusion) collection of critical elements inscribed in  $\mathbb{S}^1$ .

Let us assign to any critical element  $Q$  its *weight* as follows:

- 1)  $w(Q) = 1$  if  $Q$  is of first or third kind
- 2)  $w(Q) = 0$  if  $Q$  is of second kind

and let

$$w(q) = \sum w(Q_i) \tag{5}$$

be the *weight* of the packing  $q$ . It is more or less geometrically evident, that packings correspond to economic extensions and finding  $\gamma$  means minimizing  $w(q)$ .

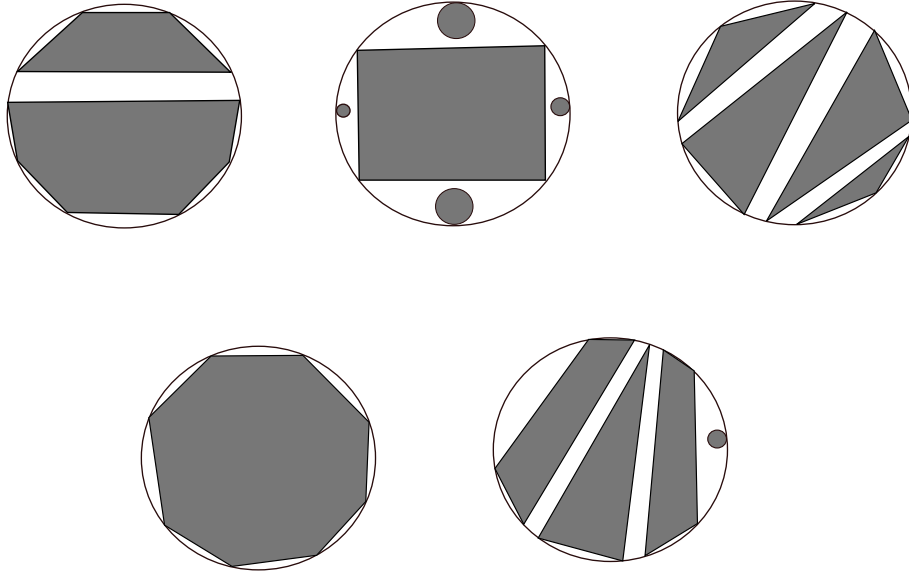

FIGURE 30. Examples of packings.

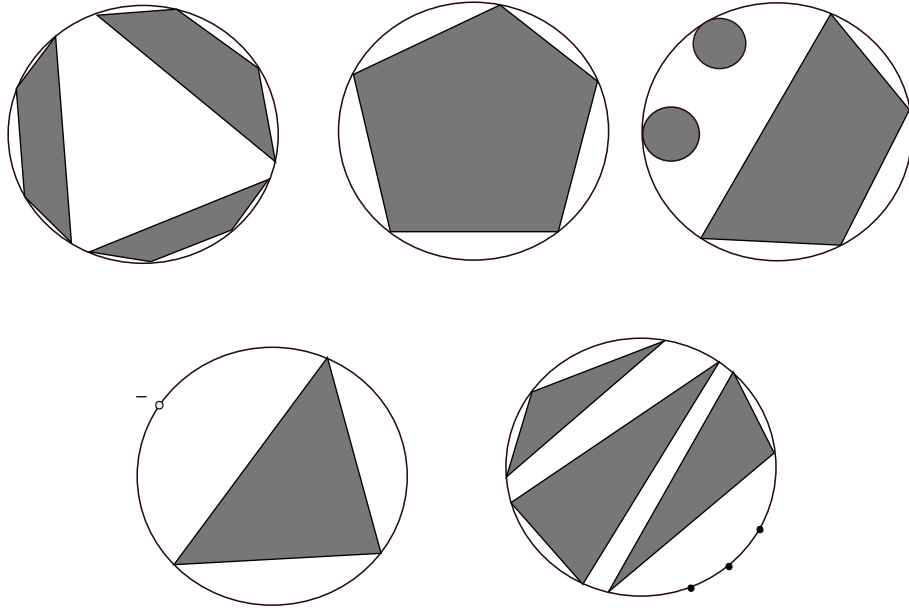

FIGURE 31. No-packings.

**Theorem 11.2.** *Let  $a = (\varphi, \nu) \in \mathcal{A}$  be a ribbon, then there is a one-to-one correspondence between the economic extensions  $f \in \mathcal{F}^e(a)$  of  $a$  (up to combinatorial equivalence), and the packings of  $a$ . The ribbon invariant  $\gamma(a)$  equals then the minimal value of  $w(q)$ , when  $q$  varies among all packings of  $a$ .*

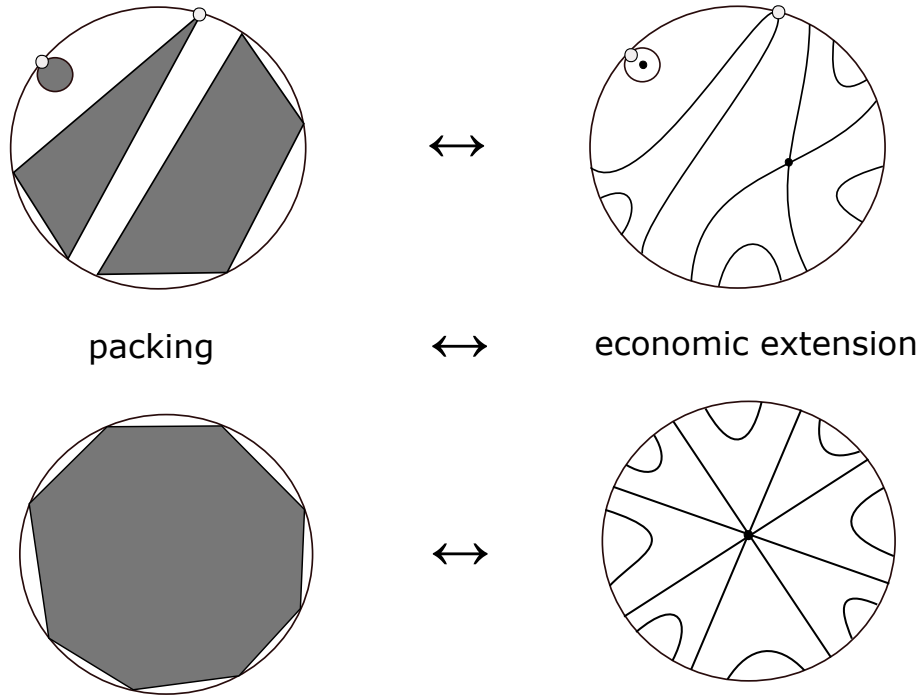

FIGURE 32. Correspondence between packings and economic extensions.

*Proof.* Let first  $f \in \mathcal{F}^e(a)$  be an economic extension of  $a$ . One may define the corresponding packing as follows: If  $x$  is a saddle of  $f$  whose separatrices are ending at points  $x_1, \dots, x_{2k} \in \mathbb{S}^1$ , then the polygon with vertices  $x_1, \dots, x_{2k}$  is a critical element of first kind corresponding to  $x$ . If  $x$  is a local extremum of  $f$ , there is a closed level line  $l$  surrounding  $x$  and touching  $\mathbb{S}^1$  at a negative node  $p$ . Then take a little disk touching  $\mathbb{S}^1$  at  $p$  from inside. This is a critical element of third kind corresponding to  $x$  in this case. Finally, let  $l$  be a touching line of  $f$  which touches the boundary at a negative node  $p$  and has two ends  $x_1, x_2 \in \mathbb{S}^1$ . Then we associate with  $l$  an iso-triangle with vertices  $p, x_1, x_2$ , which is a critical element of second kind. It is not difficult to see that we obtain, in such a way, some packing of  $a$ . The inverse correspondence is also geometrically evident (see Fig. 32). The only “delicate” moment is the attachments of noncritical bands between the critical elements. But here comes to help condition d) from the definition of a packing, it allows us to do it correctly in a monotonic way. Now, the statement about  $\gamma(a)$  is straightforward, since the critical elements of first and third kind correspond to saddles and extrema, while an element of second kind corresponds to a touching line.  $\square$

Note that it is almost a discretization of the problem of finding  $\gamma$ , as for a given ribbon there are only a finite number of possibilities for arranging a packing. We may also describe via packings all the economic extensions  $f \in \mathcal{F}^e(a)$ .

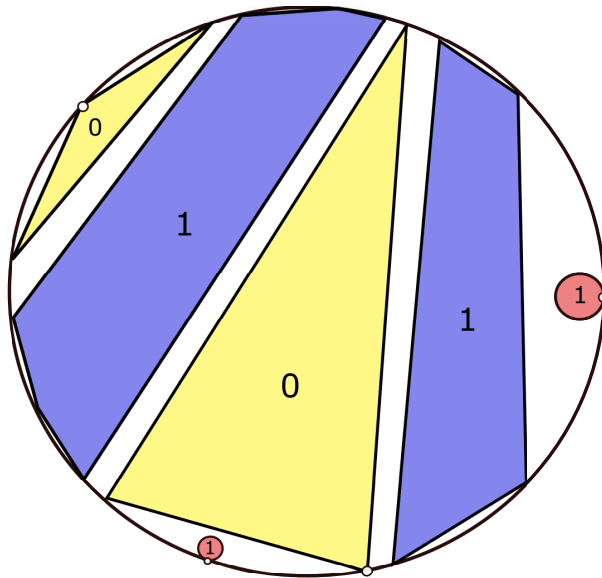

FIGURE 33. A packing with  $w = 4$ ,  $w_0 = 5$ ,  $w_{\text{ext}} = 2$ ,  $w_{\text{sad}} = 2$ .

Let us look now at the other ribbon invariants. It turns out that the problem here may be resolved just in the same way, we have only to assign different weights to the critical elements.

a) For  $\gamma_0$  we have to take the following weight system:

1) If  $Q$  is of first kind and is a  $2k$ -gon, set  $w_0(Q) = k - 1$ . This is due to the fact that the morsification of a saddle with  $2k$  separatrices contains  $k - 1$  non-degenerate saddles. (This morsification may be performed by a small perturbation in each saddle with  $> 4$  separatrices.) An equivalent way is to consider from the beginning packings with only quadrilateral iso-gons of first kind.

2)  $w_0(Q) = 0$  if  $Q$  is of second kind

3)  $w_0(Q) = 1$  if  $Q$  is of third kind

b) for  $\gamma_{\text{ext}}$  only extrema matter, so take

1)  $w_{\text{ext}}(Q) = 0$  if  $Q$  is of first or second kind

2)  $w_{\text{ext}}(Q) = 1$  if  $Q$  is of third kind

c) for  $\gamma_{\text{sad}}$  only saddles matter, so take

1)  $w_{\text{sad}}(Q) = 1$  if  $Q$  is of first kind

2)  $w_{\text{sad}}(Q) = 0$  if  $Q$  is of second or third kind.

Now we have to look for packings minimizing the corresponding weight function (5), to determine the value of the corresponding ribbon invariant.

At Fig. 33 we present a packing  $q$  where different types of elements are differently coloured: first kind - blue, second kind - yellow, third kind - red. The  $w$ -weights are also given at the picture. Note that  $w(q) = 4$ ,  $w_0(q) = 5$ ,  $w_{\text{ext}}(q) = 2$ ,  $w_{\text{sad}}(q) = 2$ .

This geometrical description of the ribbon invariants is a base for another combinatorial description via graphs given in Part II. Therein, for a given ribbon, a



particular graph of *virtual critical elements* is constructed and its *weighted independent domination number* turns out to be equal to some of the four ribbon invariants, depending on the weight system selected.

## 12. A GENERAL ALGORITHM FOR COMPUTING $\gamma$

We describe in this section some general “brute force” algorithm for parallel computation of all the ribbon invariants. It is based on splittings and induction on the lexicographic ordering in the space  $\mathcal{B}$  of discrete ribbons. In fact, we already used before such a procedure for proving things by induction.

Recall first the ordering of  $\mathcal{A}$ . Let  $a = (\varphi, \nu) \in \mathcal{A}$  be a ribbon, then we may consider its “discretization”  $i(a) \in \mathcal{B}$ , where  $\mathcal{B}$  is the set of pairs  $b = (t, \nu)$ , such that  $t = (c_1, c_2, \dots, c_n)$  is a cyclic zig-zag permutation of  $\{1, 2, \dots, n\}$  with  $n$  even, and  $\nu(c_i) = \pm 1$  is some mark function. The discretization is defined in [Section 4](#). Set  $\nu(t) = (\nu(c_1), \dots, \nu(c_n))$ . Consider the triple  $(n, t, \nu(t))$ . It is clear now that we may introduce a lexicographic ordering in these triples, assuming that  $+1 \prec -1$ . In such a way  $\mathcal{B}$  is linearly ordered and  $\mathcal{A}$  inherits a linear order as well.

Before exposing the algorithm, we shall define some very simple operation that we call “short cancellation” and which should be performed at the beginning. It does not affect  $\gamma$  (and the other ribbon invariants defined before).

Let the ribbon  $a = (\varphi, \nu)$  have two consecutive nodes of type  $(p_i^+, p_{i+1}^-)$  or  $(p_i^-, p_{i+1}^+)$  such that there are no node levels  $l_j$  between  $l_i$  and  $l_{i+1}$ , or equivalently for discrete ribbons,  $|l_i - l_{i+1}| = 1$ . Then this pair is cancellable by a *short cancellation* which consists in removing its nodes from  $a$  (see [Fig. 35](#)). It is clear that the new ribbon  $a'$  has the same signature as  $a$ , moreover, it is not difficult to see that  $\gamma(a) = \gamma(a')$ . The latter holds true for the other ribbon invariants  $\gamma_*$  as well.

In brief, the algorithm (before discretization) consists in the next steps:

0) perform all the possible *short cancellations* in  $a$  (if any).

1) if  $a = (\varphi, \nu) \notin \mathcal{A}^+$ , i.e. there is a negative node  $p$ , then there are 2 cases

1a)  $\varphi(p)$  equals  $\min \varphi$  or  $\max \varphi$ . Then we take  $a' = (\varphi, \nu')$ , where  $\nu'$  is identical to  $\nu$ , except for node  $p$ , which is marked as “positive”. Consequently  $a' \prec a$  and we have  $\gamma(a) = \gamma(a') + 1$ .

1b)  $\varphi(p)$  does not equal  $\min \varphi$  or  $\max \varphi$ . Let  $\varphi^{-1}(\varphi(p)) = \{p, x_1, \dots, x_k\}$  consider the *proper* pairs  $(x_i, x_j)$  i.e. for which  $i - j$  is odd. For any such pair perform the ternary splitting of  $a$  along  $\{p, x_i, x_j\}$

$$a = a_1 * a_2 * a_3.$$

Then  $a_i \prec a$ ,  $i = 1, 2, 3$ , since each  $a_i$  has less nodes than  $a$ . So, we may compute the number  $\gamma_{i,j} = \gamma(a_1) + \gamma(a_2) + \gamma(a_3)$  and store it in some massif  $Z$ . Now take as in 1a)  $a' = (\varphi, \nu')$ , where  $\nu'$  is identical to  $\nu$ , except for node  $p$ , which is marked as “positive”. Consequently  $a' \prec a$  and we may compute  $\gamma(a')$ . Then add the value  $\gamma(a') + 1$  to massif  $Z$ . This corresponds to the possibility the extension  $f \in \mathcal{F}^e(a)$  which is realizing  $\gamma(a)$  to have a touching circle at  $p$ . After the end of this procedure it turns out that

$$\gamma(a) = \min Z.$$

This is due to the fact that any extension  $f \in \mathcal{F}^e(a)$  which is realizing  $\gamma(a)$  has either a touching level line  $l$  which is passing through some triple  $\{p, x_i, x_j\}$ , or a touching circle at  $p$ . Finally, we refer to [Lemma 6.6](#).

2) Let  $a = (\varphi, \nu) \in \mathcal{A}^+$ , then it is easy to find the clusters  $C_i$ . There are two cases

2a) There is only one cluster. Then  $\delta(a) = 1$ ,  $a$  is an alternation and one has  $\gamma(a) = 1$ .

2b) There are at least two clusters, so  $\delta(a) \geq 2$ . Then take some non-critical value  $c$  of  $\varphi$  which is situated between two adjacent clusters  $C_1$  and  $C_2$  and let  $\varphi^{-1}(c) = \{x_1, \dots, x_k\}$ . Consider now the *proper pairs* of type  $(x_i, x_j)$  for which  $i - j$  is odd. For any such pair perform the binary splitting of  $a$  along  $\{x_i, x_j\}$

$$a = a_1 \# a_2.$$

Then we take into account only such binary splittings, for which  $a_i \prec a$ ,  $i = 1, 2$ , since the value  $c$  is essential and hence for any pairing in  $\varphi^{-1}(c)$  there exists some essential pair  $(x_i, x_j)$ , which is *paired* (Section 5). So, we may compute the number  $\gamma_{i,j} = \gamma(a_1) + \gamma(a_2)$  and store it in some massif  $Z$ . After the end of this procedure, one has  $\gamma(a) = \min Z$  again. This follows from the fact that any extension  $f \in \mathcal{F}^e(a)$  which is realizing  $\gamma(a)$  has a regular level line  $l$  which is passing through some pair  $\{x_i, x_j\}$ . Now, refer to Lemma 6.6 again.

Note that the result surely does not depend on the particular choice of the negative node  $p$  in case 1), or the choice of the non-critical value  $c$  in case 2). It gives us the freedom to choose an appropriate splitting level where the ribbon is as “thin” as possible. This might reduce calculations.

Note also that in fact we do not use effectively the lexicographic order of the zig-zag permutations  $t$ . The only things that matter are the rank (the number of nodes) and the lexicographic ordering of  $\nu(t)$ .

This procedure is common for all invariants  $\gamma$ ,  $\gamma_0$ ,  $\gamma_{\text{ext}}$ ,  $\gamma_{\text{sad}}$ . The only difference is that we have to assign different values on the irreducible ribbons as follows. Let  $\alpha_0 = (1^+, 2^+)$ ,  $\alpha_1 = (1^+, 2^-)$ ,  $\beta_n \in \mathcal{A}_n^+$  be an arbitrary alternation. Then we set the normalization rules:

- 1)  $\gamma(\alpha_0) = \gamma_0(\alpha_0) = \gamma_{\text{ext}}(\alpha_0) = \gamma_{\text{sad}}(\alpha_0) = 0$
- 2)  $\gamma(\alpha_1) = \gamma_0(\alpha_1) = \gamma_{\text{ext}}(\alpha_1) = 1$ ,  $\gamma_{\text{sad}}(\alpha_1) = 0$
- 3)  $\gamma(\beta_n) = 1$ ,  $\gamma_0(\beta_n) = \frac{n}{2} - 1$ ,  $\gamma_{\text{ext}}(\beta_n) = 0$ ,  $\gamma_{\text{sad}}(\beta_n) = 1$ .

Note that furthermore we shall somehow identify all the positive alternations  $\beta_n \in \mathcal{A}_n^+$  and this may be justified by the fact that all geometric ribbon invariants take the same values on these ribbons. Another argument for this to be done is the observation that any two alternations  $\beta_n, \beta'_n \in \mathcal{A}_n^+$  may be transformed into each other only by positive *bypasses*, which are self-inverse elementary moves (see Section 14).

Of course, if one wants to write a program or at least a flowchart for realizing this algorithm, it certainly should be done for discrete ribbons from class  $\mathcal{B}$ . Anyhow, we won't do that here. Note only that the presented algorithm is in essence inductively ramifying and thus should be heavy and slow for big  $n$ . Another serious obstacle is the “immensity” of the ribbon space  $\mathcal{B}_n$  for big  $n$  and the fact that the algorithm presumes that we have to keep a previously built up library of *all* smaller ribbons (together with their invariants).

**Remark.** *From aesthetical point of view it would be fine to find an algorithm which avoids ternary splittings. However, this is not possible for the presented one. Indeed, there exist general alternations  $\notin \mathcal{A}^+$  without essential values. Then the only thing that remains is to do a ternary splitting at a negative node. Anyway, in some*

cases an essential value can be found even in this setting. For example, let  $a$  be a general alternation with two negative nodes  $p_i$  and  $p_j$ , such that  $i - j$  is even. Then taking  $c$  inside the unique cluster, it is easy to see that  $c$  is an essential value and we may keep on calculations without ternary splitting. On the other hand, ternary splitting may be useful, if performed at a suitable negative node.

Let us now give two examples and some general calculation based on the algorithm.

**Example 12.1.** Let  $a = (1^+, 3^+, 2^+, 5^+, 4^+, 7^+, 6^-, 9^+, 8^+, 10^+)$ . We shall find  $\gamma(a)$ . Schematically, the algorithm works as follows: choose the negative node  $6^-$ ; it is easy to see that: making  $6^-$  positive  $\rightarrow 1 + 4 = 5$ , ternary splitting along  $6^- \rightarrow 0 + 1 + 2 = 3$ . Hence  $Z = \{5, 3\}$ , thus  $\gamma(a) = 3$ .

**Example 12.2.** Let  $a = (1^+, 6^+, 2^-, 4^+, 3^+, 5^-)$  be the ribbon from Fig. 19. Work at  $2^-$ ; making  $2^-$  positive  $\rightarrow 1 + 1 = 2$ , ternary splitting along  $2^- \rightarrow 0 + 0 + 2 = 2$ . Thus  $Z = \{2, 2\}$  and  $\gamma(a) = 2$ .

Look now for  $\gamma_{\text{sad}}$ . The same scheme gives  $\rightarrow 0 + 1 = 1$ ,  $\rightarrow 0 + 0 + 1 = 1$ . Thus  $Z = \{1, 1\}$  and  $\gamma_{\text{sad}}(a) = 1$ .

Note that  $a$  from the first example is a ladder (see Section 3). The next proposition finds  $\gamma$  for all such ribbons.

**Proposition 12.3.** Let  $a = (\varphi, \nu) \in \mathcal{A}$  be a ladder with nodes  $p_1, \dots, p_n$ . Suppose that the minimal and the maximal nodes of  $a$  are positive. Then

$$\gamma(a) = \# \left\{ k \mid \nu(p_{2k})\nu(p_{2k+1}) > 0, k = 1, \dots, \frac{n}{2} - 1 \right\}.$$

*Proof.* It suffices to make binary splittings at the non-critical levels  $c_k = \frac{4k-1}{2}$ ,  $k = 1, \dots, \frac{n}{2} - 1$  decomposing in such a way  $a$  into  $\frac{n}{2} - 1$  elementary ribbons  $a_k \in \mathcal{A}_4$  with positive minimal and maximal nodes. Now observe that  $\gamma(a_k) = 1$  if the other two nodes of  $a_k$  have the same marking, and  $\gamma(a_k) = 0$  otherwise. It may also be seen that  $\gamma_0 = \gamma$  for such ladders.  $\square$

**Question.** Is it true that  $\gamma_0(a) = \gamma(a)$  implies that the ribbon  $a$  is a ladder?

Note that the convention about the minimal and the maximal nodes, say  $p$  and  $q$ , is not restrictive, since if it is not assumed, anyway one easily finds  $\gamma(a) = \gamma(a') + \varepsilon$ , where  $a'$  is obtained from  $a$  by making  $p$  and  $q$  positive, and  $\varepsilon$  is the number of negative nodes among  $p, q$ . It is also clear that the other ribbon invariants may be found in a similar way, relying on the corresponding splitting equality. More precisely, we have the following

**Proposition 12.4.** Let  $a$  be a ladder as in Proposition 12.3. Then

- 1)  $\gamma_0(a) = \gamma(a) = \# \left\{ k \mid \nu(p_{2k})\nu(p_{2k+1}) > 0, k = 1, \dots, \frac{n}{2} - 1 \right\}$
- 2)  $\gamma_{\text{ext}}(a) = \# \left\{ k \mid \nu(p_{2k})\nu(p_{2k+1}) > 0 \text{ and } \nu(p_{2k}) < 0, k = 1, \dots, \frac{n}{2} - 1 \right\}$
- 3)  $\gamma_{\text{sad}}(a) = \# \left\{ k \mid \nu(p_{2k})\nu(p_{2k+1}) > 0 \text{ and } \nu(p_{2k}) > 0, k = 1, \dots, \frac{n}{2} - 1 \right\}$ .

These formulas about ladders will be important for the general “fast” algorithm for parallel computation of the ribbon invariants presented in Part II. Another interesting property of ladders is that the class of economic extension  $f \in \mathcal{F}^e(a)$  realizing the ribbon invariants may be quite easily described (up to topological similarity).

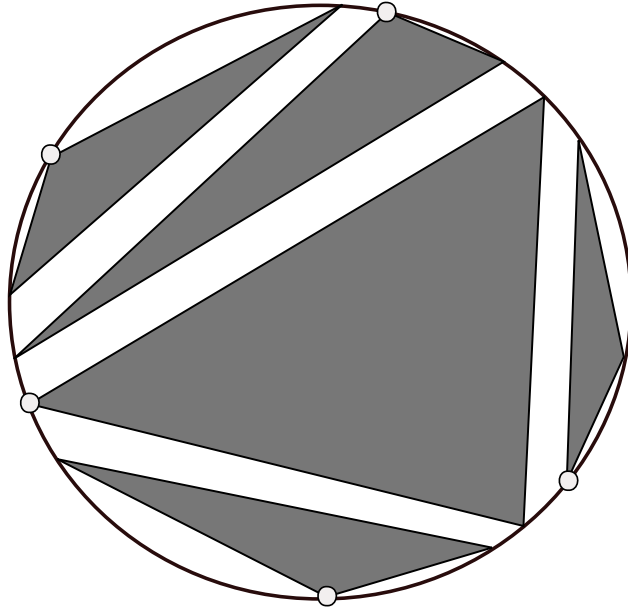

FIGURE 34. A packing of triangles yields  $\gamma = 0$ .

### 13. WHEN DOES $\gamma = 0$ ?

It is natural to be interested in the case  $\gamma = 0$ , as this would answer the question under what boundary conditions there is a critical points free extension. Note that for a general position function  $\varphi : \mathbb{S}^1 \rightarrow \mathbb{R}$  critical points free extensions always exist (Section 17). In the setting of ribbons, an obvious necessary condition for this is, of course,  $\sigma = 2$ , which means that for any extension  $f$  of the corresponding ribbon we have  $\deg(\nabla f|_{\mathbb{S}^1}) = 0$ . However, as we pointed out on several occasions,  $\sigma = 2$  is not sufficient for  $\gamma = 0$ . We shall try, in this section, to describe all such ribbons. Again, it turns out that there is no easy or immediate answer to the problem. Of course, one may apply the general algorithm for  $\gamma$ , but, as we pointed above, it is very heavy and slow. Here we present another algorithm for establishing  $\gamma = 0$  based on “cancellations”.

From the geometrical point of view adopted in Section 11, we have  $\gamma = 0$  if and only if there is a packing consisting only of triangles (Fig. 34). Let us call a face of a triangle *boundary*, if it is adjacent to a positive node. The number of such faces equals  $\frac{n}{2} + 1$ , the number of positive nodes. Now, it is evident that there is a boundary face  $l$ , having an end which is a negative node  $p$ . Let  $q$  be the positive node adjacent to  $l$ . Roughly speaking, we shall “cancel” nodes  $p$  and  $q$ , obtaining in such a way a new ribbon with  $n - 2$  nodes. It turns out that the new ribbon has  $\gamma = 0$  again and we may proceed by induction. Then we should finally finish with the minimal ribbon  $\alpha_0 = (1^+, 2^+)$ .

Of course, this scheme works only if we were told in advance that  $\gamma$  equals zero and a triangle packing were presented, but this is actually the problem! In fact, supposing the problem is resolved for  $n - 2$ , we have to perform all *admissible*

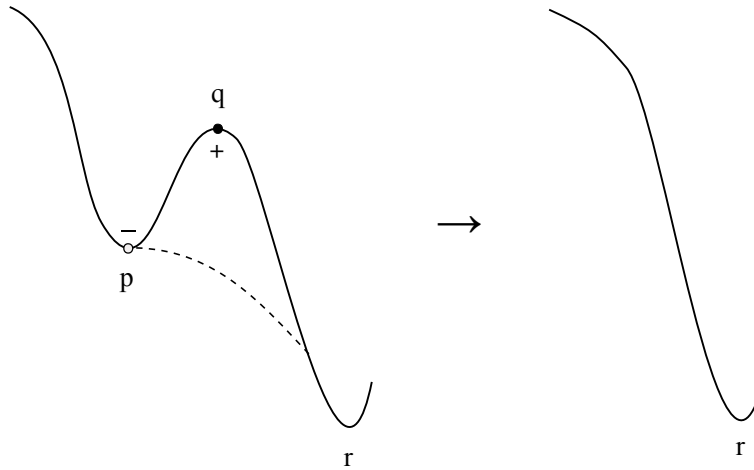

FIGURE 35. Cancellation of the pair  $(p^-, q^+)$ .

cancellations and to look whether they lead to some ribbon with  $\gamma = 0$  or not. This is the inductive variant of the algorithm which implies a previously built library of ribbons with  $\gamma = 0$  and  $\leq n - 2$  nodes. The other way is to present a ramifying algorithm which ends when reaching  $\alpha_0 = (1^+, 2^+)$ . Anyway, both algorithms are expensive, but not so bad as the general algorithm for calculating  $\gamma$ .

Let  $a = (\varphi, \nu) \in \mathcal{A}$  be a ribbon,  $p, q$  and  $r$  be consecutive nodes (in either orientation of the circle) such that  $p$  is negative,  $q$  is positive and  $|\varphi(p) - \varphi(q)| < |\varphi(q) - \varphi(r)|$ . We shall say that the pair  $(p, q)$  is *cancellable*, since we may consider the ribbon  $a'$  obtained from  $a$  by removing nodes  $p$  and  $q$  and keeping unchanged the other information of  $a$ . The only difference between  $a$  and  $a'$  is that we replace the “twist”  $(p, q)$  by a monotonic piece in the graph of  $\varphi$ . (See Fig. 35)

**Definition 13.1.** *We shall call the described above operation  $a \rightarrow a'$  “cancellation” of nodes  $p$  and  $q$ . The inverse operation will be called “extension” of the ribbon. Then two new born nodes  $p$  and  $q$  appear.*

Note that cancellation and extension do not change the signature  $\sigma$ . It should be noted also that these are “long” operations and may change  $\gamma$ , in contrast with “death” and “birth” of a couple  $(p, q)$  which are “short” operations and do not affect  $\gamma$ .

For discrete ribbons cancellation is defined analogically:

Let  $a = (t, \nu) \in \mathcal{B}$  be a discrete ribbon, where  $t = (1, c_2, \dots, c_n)$  is a cyclic zig-zag permutation and  $\nu(c_i) = \pm 1$  is some marking. Suppose for some  $i$  that  $\nu(c_i) = -1, \nu(c_{i+1}) = +1$  and  $|c_i - c_{i+1}| < |c_{i+1} - c_{i+2}|$ . Then removing  $c_i$  and  $c_{i+1}$  and rearranging the rest nodes, we get the canceled ribbon  $a'$ .

**Lemma 13.2.** *Let  $a$  be a ribbon with  $\gamma(a) = 0$ . Then it has a cancellable pair of nodes  $(p, q)$ .*

*Proof.* Let  $f \in \mathcal{F}^e(a)$  be some critical points free extension. Take an arbitrary positive node  $p$  and consider the closest to it touching line  $l$ . Let  $l$  is touching the

boundary at some negative node  $q$ . Then it is evident that  $(p, q)$  is a cancellable pair.  $\square$

**Lemma 13.3.** *Let  $a'$  be obtained from  $a$  by cancellation. Then  $\gamma(a') \geq \gamma(a)$ .*

*Proof.* Let  $f \in \mathcal{F}^e(a')$  be an extension of  $a'$  with  $\gamma(a')$  critical points. Since  $a$  is obtained from  $a'$  by extension, it is evident from picture that we may attach a noncritical “shoulder” to  $f$ , obtaining in such a way an extension of  $a$  with  $\gamma(a')$  critical points again.  $\square$

This inequality sounds a little bit paradoxically, as “simplifying” the ribbon, its ribbon invariant is increasing as a result! On the other hand, it is clear that such jumps of  $\gamma$  are possible: Imagine, for example, that  $\gamma(a) = 0$ , but after cancellation some negative node of  $a'$  becomes a maximal one. Then, surely,  $\gamma(a') > 0$ . Other examples show that the jump of  $\gamma$  after a single cancellation may be large enough. This is due to the fact that such a cancellation may be done continuously and the examination of the jump of  $\gamma$  at the possible elementary moves shows that  $\gamma$  may only increase (see [Section 14](#)).

Now we may summarize the above considerations in the following proposition:

**Theorem 13.4.** *The equality  $\gamma(a) = 0$  holds true if and only if ribbon  $a$  may be connected with the trivial ribbon  $\alpha_0 = (1^+, 2^+)$  by a chain of cancellations.*

Note that it follows from this theorem, that  $\sigma(a) = 2$  is a necessary condition for  $\gamma(a) = 0$ , which was our starting observation.

The following proposition is not crucial for this section, but enlightens the behaviour of the ribbon invariant through extensions. It turns out that the ribbon invariant of any ribbon may be reduced by extensions to the minimal possible value for ribbons with the same signature  $\sigma$ . It is easy to see that this is in fact the number  $i_0(\sigma)$ , defined as follows:

$$i_0(\sigma) = 1 - \frac{\sigma}{2}, \text{ if } \sigma \leq 2 \text{ and } i_0(\sigma) = 1, \text{ if } \sigma > 2.$$

**Proposition 13.5.** *Any ribbon  $a$  with signature  $\sigma$  may be upgraded by extensions to a ribbon  $a'$  with  $\gamma(a') = i_0(\sigma)$ .*

For example, any ribbon with  $\sigma = 2$  may be extended to a ribbon with  $\gamma = 0$ . The proof is by induction on the number of nodes. Clearly, it may be done by  $\leq \gamma(a) - i_0(\sigma)$  extensions. Moreover, by the same method it may be shown that any integer from  $[i_0(\sigma), \gamma(a)]$  may be realized by extensions of ribbon  $a$ . The proof of [Proposition 13.5](#) is easily done by induction and the splitting technique.

Now we present a simple (but not fast) algorithm for resolving the problem whether  $\gamma = 0$  for a given ribbon.

**The algorithm.** Of course, it is convenient to work with discrete ribbons. Now, in view of [Lemmas 13.2](#) and [13.3](#), the procedure of checking whether  $\gamma = 0$  is quite clear:

0) Check  $\sigma = 2$ , if “yes”: continue, if “no”: stop:  $\gamma > 0$ .

Perform all possible cancellations in  $a$ , obtaining in such a way a set  $R_{n-2}$  of ribbons if order  $n - 2$ , then perform all cancellations of the elements of  $R_{n-2}$ , obtaining the set  $R_{n-4}$ , etc. After the process stops, there are two cases:

1)  $R_2 \neq \emptyset$ . Then  $\gamma(a) = 0$ , since we connected  $a$  with the minimal ribbon  $(1^+, 2^+) \in R_2$  through cancellations, which, in view of [Lemma 13.3](#) are raising  $\gamma$ .

2)  $R_2 = \emptyset$ . Then  $\gamma(a) \neq 0$ , as if  $\gamma(a) = 0$ , there should be a path from  $a$  to  $(1^+, 2^+)$  through cancellations, as we pointed out at the beginning of the section. This case is available if the cancellation process always stops at some ribbon with  $\geq 4$  nodes.

Surely, this algorithm, being inductively ramifying, should be expensive in time.

There are some situations, when the algorithm may be shortened.

a) It is not necessary to find all paths leading to  $R_2$ , we may stop at the first moment when  $R_2 \neq \emptyset$  is established. Anyway, if one wants to find *all* critical points free extensions (in case they exist), it is equivalent to finding *all* paths leading to  $R_2$ .

b) We don't need to follow a path which leads to a ribbon with a negative minimal or maximal node, since then surely  $\gamma > 0$  for that ribbon and  $\gamma$  cannot decrease through cancellations. If, by chance, the initial ribbon is so, we should stop immediately.

At Fig. 36 and Fig. 37 we present graphical example of application of the algorithm for two almost identical ribbons with  $\sigma = 2$ , that lead to different results. Note that in the second example we don't need to follow both paths, only one of them suffices to establish  $\gamma = 0$ .

As we pointed out, another inductive variant of the algorithm is possible, based on a previously built library of ribbons of rang  $\leq n - 2$  with  $\gamma = 0$ . Then the problem for a ribbon of rank  $n$  is resolved by  $\leq \frac{n}{2}$  cancellations. The problem here is that this algorithm would be expensive in storage.

It would be interesting to find/estimate the number of ribbons from  $\mathcal{A}_n$  with  $\gamma = 0$ , but this seems to be a hard task. Anyway, it is easy to find a relation between the ribbons with  $\gamma = 0$  and those with  $\gamma_{\text{sad}} = 0$ .

**Proposition 13.6.** *Let  $N^0$  be the number of ribbons from  $\mathcal{A}_n$  with  $\gamma = 0$  and  $N_{\text{sad}}^0$  be the number of ribbons from  $\mathcal{A}_n$  with  $\gamma_{\text{sad}} = 0$ . Then*

$$N_{\text{sad}}^0 = 2^{\frac{n}{2}+1} N^0.$$

*Proof.* Let  $a$  be a ribbon with  $n$  nodes with  $\gamma = 0$ . It is evident that making some positive node  $p$  of  $a$  negative, we get a ribbon  $b$  with  $\gamma_{\text{sad}}(b) = 0$ , since we may modify the solution for  $a$  by attaching a local extremum at  $p$ . On the other hand, it is easy to see that any ribbon with  $\gamma_{\text{sad}} = 0$  may be obtained from some ribbon with  $\gamma = 0$  by multiple application of the above operation. But the number of positive nodes of  $a$  equals  $\frac{n}{2} + 1$  (since  $\sigma(a) = 2$ ), whence the above formula.  $\square$

**A “ribbon game”.** Here we describe some game based on the ribbon invariant.

At the beginning, a cyclic zig-zag permutation  $t$  of even order  $n$  is automatically generated. Two players, say A and B, are playing consecutively. Player A has  $\frac{n}{2} - 1$  “negative” pools, while player B has  $\frac{n}{2} - 1$  “positive” pools. At each move, the corresponding player is putting a pool on some element of the permutation  $t$ , marking it in such a way either positive, or negative. The minimal and the maximal elements of  $t$  are marked as “positive” automatically from the beginning. Player A starts first. At the end, we get some discrete ribbon  $a = (t, \nu) \in \mathcal{B}$ . The score is calculated according to the rule:

If  $\gamma(a) \neq 0$ , then player A wins, if  $\gamma(a) = 0$ , then player B wins.

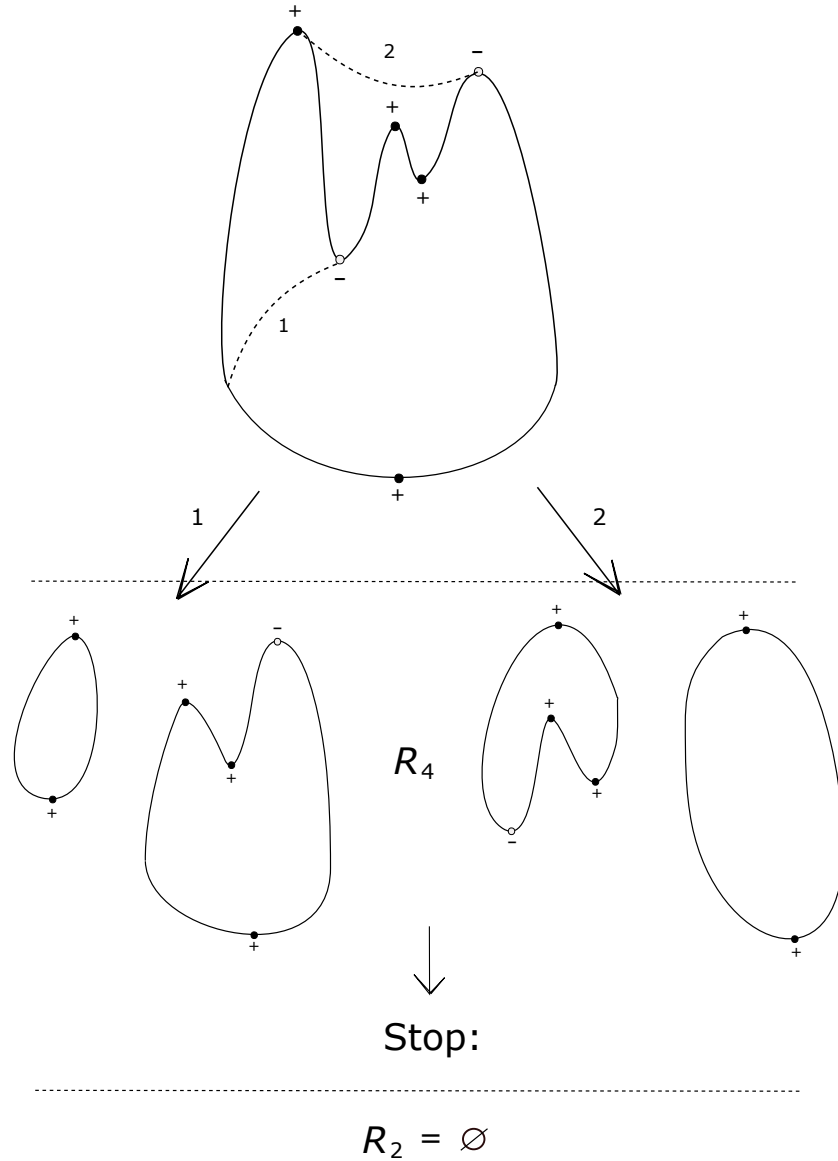
FIGURE 36.  $R_2 = \emptyset \Rightarrow \gamma \neq 0$ .

In such a way, player A is trying to “destroy” the ribbon making  $\gamma(a)$  as big as possible, while player B is trying to minimize  $\gamma(a)$ , reducing it finally to zero. Note that the final ribbon has signature  $\sigma = 2$ , which is necessary for  $\gamma = 0$ . From practical point of view, it seems reasonable to play with permutations of order  $\leq 8$ , otherwise it may happen that the players cannot determine who is the winner. Another variant is to generate ribbons with some symmetry, that allows the players to follow a particular strategy.

We conjecture here the following:

**There is a winning strategy for player B.**



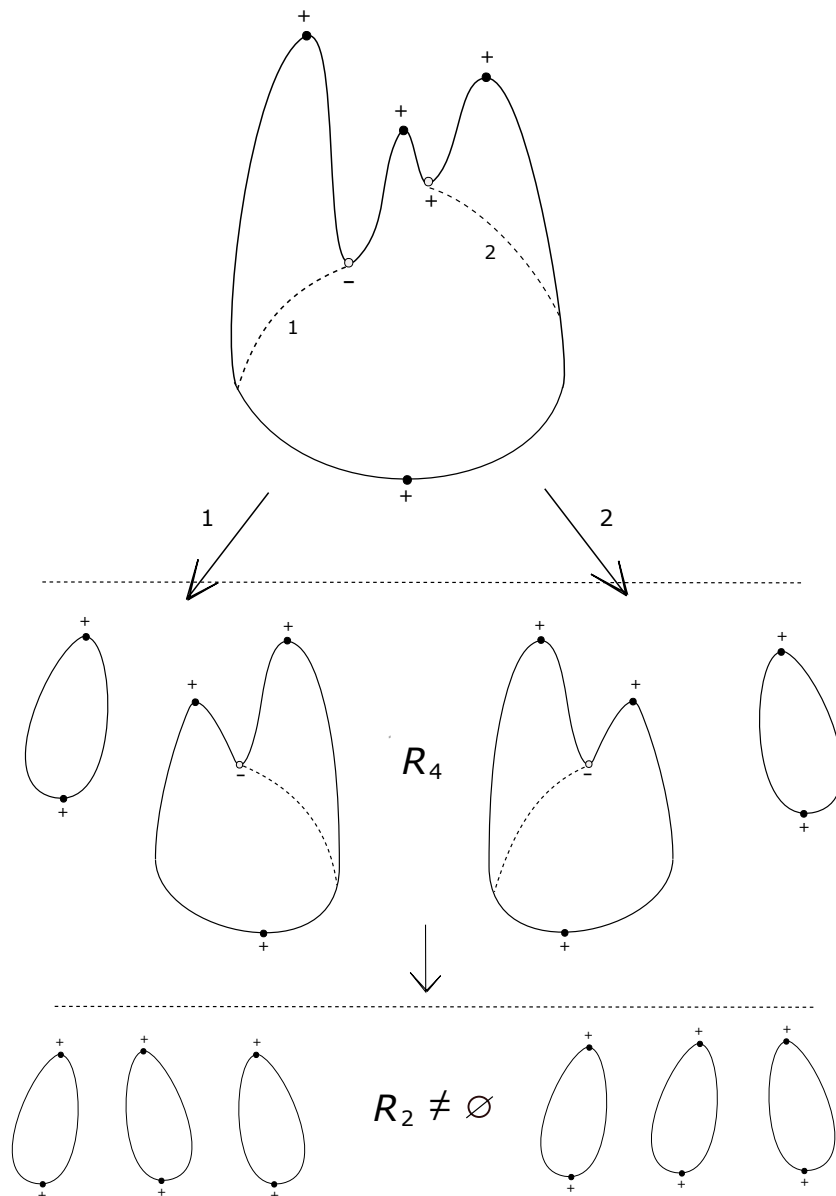

FIGURE 37.  $R_2 \neq \emptyset \Rightarrow \gamma = 0$ .

In other words, player B may always minimize the ribbon invariant to 0, by putting positive pools. Here is an example of such a strategy for some basic class of zig-zag permutations.

Let  $t = (1, 3, 2, 5, 4, 7, \dots, (n-2), n)$  be a “ladder”. Then the winning strategy for player B is the following one:

- 1) If A selects  $2k$ , then B selects  $2k + 1$
- 1) If A selects  $2k + 1$ , then B selects  $2k$ .

So we get at the end some marked ladder, then, as follows from [Proposition 12.3](#), this ribbon surely has  $\gamma = 0$ , thus player B wins.

Yet another example. Consider the zig-zag permutation from [Fig. 19](#) (it is a  $C^0$ -alternation) and let's play the ribbon game. Then the winning strategy for player B is quite simple: if A selects node  $\{3\}$ , then B selects node  $\{6\}$ , and vice versa, if A selects node  $\{6\}$ , then B selects node  $\{3\}$ . Similarly, if A selects  $\{5\}$ , then B selects  $\{4\}$ , if A selects  $\{4\}$ , then B selects  $\{5\}$ . Then it is easy to see that player B wins. The crucial moment here is not to allow nodes  $\{3, 6\}$  to be marked simultaneously as “negative” (then the situation from [Fig. 20](#) occurs), neither nodes  $\{4, 5\}$  to be marked simultaneously as “positive”. These two examples suggest that there might be a general algorithm based on some *pairing* of the nodes.

There is a stronger variant of the game, when the result is calculated according to whether the final ribbon is *Jordan*, or not (see p. 62). If a ribbon  $a$  is Jordan, then surely  $\gamma(a) = 0$ . Note that this variant is more geometric than the original one. We suppose again that there is a winning strategy for player B in this *Jordan game*. Of course, this yields a winning strategy for player B in the original game.

A more general variant of the game for arbitrary value of  $\sigma$  is possible to consider, where, roughly speaking, player A is trying to maximize  $\gamma$ , while player B is trying to minimize it. The difference with the above variant is that at the beginning some quantity of random pools is automatically distributed between players. Anyhow, we won't go into details about that possible variant of the game.

#### 14. CHANGES OF $\gamma$ DURING ELEMENTARY MOVES

Suppose now the ribbon  $a = (\varphi, \nu) \in \mathcal{A}_n$  is moving in a generic way in class  $\mathcal{A}_n$ . This means that we consider the path  $a_t = (\varphi_t, \nu) \in \mathcal{A}_n$ , where  $\varphi_t$  is a generic homotopy. In general, there are two types of elementary moves - a *meeting* (and its inverse - *separation*) and a *bypass*. These are depicted at [Fig. 38](#). The inverse of a bypass is a bypass itself. It is natural to look at the possible jumps of the ribbon invariant when the ribbon passes through a non general position state. We shall list in this section all possible changes of  $\gamma$  (and the other invariants) both for noncritical and critical elementary moves. Roughly speaking, any such a move changes the invariant by  $0, \pm 1, \pm 2$  (some jumps are impossible). Of course, nobody tells us what exactly the jump should be (if any) at a given moment. In this sense, the ribbon invariant  $\gamma$  is a *global* invariant, as its behaviour depends on the whole situation and is not defined by any local rules, in contrast with the cluster number  $\delta$  for example ([Section 7](#)).

What is an elementary move? When a soft ribbon  $a = (\varphi, \nu) \in \mathcal{A}$  is moving in a generic way, there are moments when he is changing its type. The process of passing through such a “degenerate” position is called *elementary move*. In general, there are two types of such moves:

1. Noncritical moves. These are moves during which the band of the ribbon remains critical points free. At such moves the signature  $\sigma$  remains unchanged.
2. Critical moves. These moves allow the appearance of a single critical point at the boundary. Strictly speaking, at the critical moment the ribbon is not a *true* ribbon anymore, but we shall accept them as true ribbons in the present section. During a critical move, the signature changes by  $\pm 2$ .

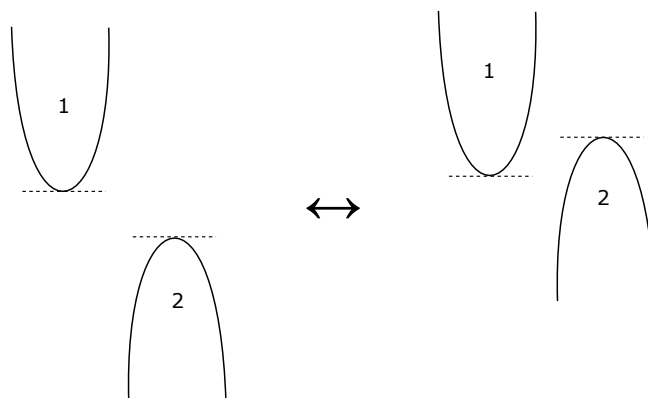

a) meeting - separation

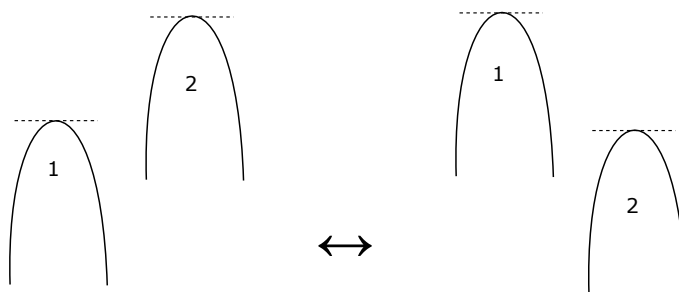

b) bypass

FIGURE 38. Elementary moves.

In general, the noncritical moves are: meeting, separation, bypass, birth and death. Meeting, separation and bypass (Fig. 38) are actually interchanging two consecutive critical levels; when they are of opposite type it is a meeting or separation, otherwise - a bypass. Meeting and separation are mutually inverse operations, bypass is self inverse. Birth is the appearance of a couple of close nodes with opposite marking  $(+-)$  or  $(-+)$ , death is the opposite action. As we pointed above, noncritical moves do not change the signature of the ribbon. Birth and death change the number of nodes by  $\pm 2$ .

There is only one type of critical moves - change of the marking of a single node to the opposite one:  $(+) \rightarrow (-)$ , or  $(-) \rightarrow (+)$ . From geometric point of view, it corresponds to the tilt of the ribbon at a node, making it for a moment horizontal and then changing the marking of the node to the opposite one. These moves will be important for us in the next section while proving the basic inequality  $\gamma \leq \frac{n}{2} + 1$ .

Now we shall specify the possible jumps of  $\gamma$ . Most of them are geometrically evident.

**Theorem 14.1.** *Let  $a$  be a ribbon and  $a'$  be obtained from  $a$  by an elementary move. Let  $\gamma(a') = \gamma(a) + \varepsilon$ . Then the possible values of the jump  $\varepsilon$  are:*

- |   |                            |
|---|----------------------------|
| a) meeting of two positive nodes,                                       | $\varepsilon = 0, -1$      |
| b) separation of two positive nodes,                                    | $\varepsilon = 0, +1$      |
| c) meeting or separation of two negative nodes,                         | $\varepsilon = 0$          |
| d) meeting of a positive and a negative node,                           | $\varepsilon = 0, -1, -2$  |
| e) separation of a positive and a negative node,                        | $\varepsilon = 0, +1, +2$  |
| f) bypass of the positive or two negative nodes,                        | $\varepsilon = 0$          |
| g) a positive node is bypassing a negative one,                         | $\varepsilon = 0, -1, -2$  |
| h) a negative node is bypassing a positive one,                         | $\varepsilon = 0, +1, +2$  |
| i) birth/death of a couple of nodes,                                    | $\varepsilon = 0$          |
| j) for a critical move $(+) \rightarrow (-)$ or $(-) \rightarrow (+)$ , | $\varepsilon = 0, \pm 1$ . |

*All listed values of the jump  $\varepsilon$  are attained in some situations.*

Detailed proof with the corresponding bifurcation diagrams will be exposed in Part II of the article. It should be noted that although  $\varepsilon = 0$  in some cases, the set of solutions may change at the corresponding elementary move. Note also that a similar table for the jumps  $\varepsilon_*$  of the other ribbon invariants  $\gamma_*$  are available, but we shall deal with it in Part II of the article. For example, for move g) with  $\varepsilon = 0, -1, -2$  we have  $\varepsilon_0 = 0, -2$ ,  $\varepsilon_{\text{ext}} = 0, -1$ ,  $\varepsilon_{\text{sad}} = 0, -1$ .

It turns out that elementary moves may be counted by suitable “invariants”, which are, in some sense, similar to the Arnold’s  $J^\pm$  invariants, the latter being introduced for immersed curves in the plane [4]. Like Arnold’s invariants, these are changing in a deterministic way at elementary moves. On the other hand, they may be useful for the estimation of  $\gamma$ , in some situations. We describe below one of these “invariants”.

1) The number  $cl^{++}$ . Let  $p$  and  $q$  be positive nodes of ribbon  $a$ . Then  $cl^{++}$  changes in a deterministic way at their meeting or separation by  $0, \pm 1$ . It may be defined as follows.

Let  $p$  and  $q$  be two positive nodes of  $a$  subject to meeting or separation. Clearly,  $p$  and  $q$  are different from the minimal and the maximal node and are not adjacent in the corresponding zig-zag permutation  $\tau$ . Then they are of different type (minimum or maximum) and have consecutive values, say  $k$  and  $k + 1$  in  $\tau$ . Now we define  $cl^{++}$  as the number of all such pairs  $k, k + 1$  in  $\tau$  where  $k$  is of maximal type (i.e. it is evenly placed in  $\tau$ ). Then, of course,  $k + 1$  is of minimal type and is oddly placed. It is clear that  $cl^{++}$  is the number of *positive* clusters in the level system of the ribbon. In such a way, it is an “invariant” in some trivial way.

*Examples.* 1) If  $a \in \mathcal{A}_n^+$  is a positive ladder, then it is easy to see that  $cl^{++}(a) = \frac{n}{2} - 2$ . For example, if  $a = (1^+, 3^+, 2^+, 5^+, 4^+, 7^+, 6^+, 8^+)$ , then  $(3, 4)$  and  $(5, 6)$  are the only countable pairs, so  $cl^{++}(a) = 2$ .

2) If  $a \in \mathcal{A}_n^+$  is a positive alternation, then  $cl^{++}(a) = 1$ . It suffices to notice that the only countable pair is  $(k, k + 1)$ , where  $k$  is the maximal minimum and  $k + 1$  is the minimal maximum.

3) Let  $a \in \mathcal{A}_n$  be a general ladder, then it is not difficult to see that  $cl^{++}(a)$  equals the number of *positive* pairs of type  $(2k + 1, 2k)$  in  $a$ . In case  $a \in \mathcal{A}_n^+$  all such pairs are positive, and since their number is  $\frac{n}{2} - 2$ , we get ex. 1).

It may be of some interest to describe dynamically the change of  $cl^{++}$  under elementary moves.

First of all, we shall divide the nodes of a ribbon  $a \in \mathcal{A}$  into two types - *primary* and *secondary* ones. A positive node  $p$  is *primary*, if it is the end of a positive cluster. Otherwise it is defined as *secondary* (so, all the negative nodes are secondary by definition). Now we consider the following indicator function on the nodes of a given ribbon  $a$ :

$$\xi(p) = 1, \text{ if } p \text{ is a primary node, and } \xi(p) = 0, \text{ if } p \text{ is a secondary one.}$$

**Proposition 14.2.** *Let  $a \in \mathcal{A}$  be a ribbon and we perform a “meeting” of two of its nodes  $p$  and  $q$ , obtaining in such a way the ribbon  $a'$ . Then for the “jump”  $\varepsilon = cl^{++}(a') - cl^{++}(a)$  of  $cl^{++}$  we have*

$$\varepsilon = 1 - \xi(p) - \xi(q).$$

*Proof.* It suffices to check this equality for all possible values of the pair  $(\xi(p), \xi(q))$ , namely that for  $(\xi(p), \xi(q)) \rightarrow \varepsilon$  we have

$$\begin{aligned} (1, 1) &\longrightarrow \varepsilon = -1 \\ (1, 0) &\longrightarrow \varepsilon = 0 \\ (0, 1) &\longrightarrow \varepsilon = 0 \\ (0, 0) &\longrightarrow \varepsilon = 1, \end{aligned}$$

but this is quite easy to be verified. For example,  $(1, 1) \rightarrow \varepsilon = -1$  follows from the observation that after the meeting of two primary nodes one new positive cluster is “born”, but two old ones “die”.  $\square$

Of course, at separations the jump should be  $\varepsilon = \xi(p) + \xi(q) - 1$ , where  $p$  and  $q$  are the nodes after separation.

Denote by  $\varkappa$  the difference between the new and the old value of  $cl^{++}$ . Now, if we have a series of elementary moves bringing  $a$  to  $b$ , set  $d(a, b) = \sum_m \varkappa_m$ , where the sum is taken over all elementary moves. It is clear that we have

$$d(a, b) = cl^{++}(b) - cl^{++}(a),$$

since  $cl^{++} + \varkappa$  is the new value of  $cl^{++}$  by definition after the corresponding move. In such a way, our invariant may be defined in class  $\mathcal{A}$  by the above rules and the normalization rule  $cl^{++}(a) = 1$  for any alternation  $a$ . It follows from the above, that if  $a$  is sent to  $b$  by a generic homotopy, the result about  $cl^{++}$  does not depend on the path selected.

From this point of view, there is some analogy between the number  $cl^{++}$  and Arnold’s  $J^\pm$  invariants [4]. The latter are defined for immersed curves in the plane and are changing in a prescribed manner at the moments of self-crossing of a given type. Another unifying property between all these invariants is that all are of a *local* type, i.e., they are changing in a deterministic way at elementary crossings. We shall see later, that this is not the case with the ribbon invariant  $\gamma$ , which changes in an *irrational* (unpredictable, at least to us) way at crossings. This gives us the ground to say that  $\gamma$  is a *global* type invariant, as its behaviour depends on the whole ribbon’s information.

Note also that  $cl^{++}$  is *not* changing by  $-1$  at meeting and by  $+1$  at separation, but is subject to more complicated rules. This raises the following

**Question.** Consider in class  $\mathcal{A}^+$  the number  $\rho$  which is changing by  $-1$  at meeting and by  $+1$  at separation (and has the initial value  $\frac{n}{2} - 2$  on ladders with  $n$  nodes). Then is this number  $\rho$  an invariant, i.e. is it independent of the path selected

in  $\mathcal{A}^+$ ? If so, does it have some intrinsic definition in terms of the corresponding zig-zag permutation?

**Remark.** If  $a = (\varphi, \nu) \in \mathcal{A}^+$  is moving in a generic way in class  $\mathcal{A}^+$  (so, the number of nodes may change), we have to add two new rules:

- 1) “birth” of a couple of nodes  $cl^{++} \rightarrow cl^{++} + 1$
- 2) “death” of a couple of nodes  $cl^{++} \rightarrow cl^{++} - 1$ .

This is caused by the fact that a little cluster is born or, respectively, dies. In such a way we may control  $cl^{++}$  during an arbitrary generic homotopy in class  $\mathcal{A}^+$ .

Note finally that we may define and investigate in a similar way several other “invariants” (say  $cl^{--}$ ,  $cl^{+-}$ , etc.), which are changing during meeting/separation of negative nodes, of a negative and a positive node and finally, a bypass of a negative and a positive node. Note that the bypass of two positive or two negative nodes does not produce a nontrivial invariant, since these are self-inverse moves.

## 15. PROOF OF $\gamma \leq \frac{n}{2} + 1$

As we mentioned in the beginning, the most “simple” inequality  $\gamma \leq \frac{n}{2} + 1$  turns out to be quite nonelementary, as it is not attackable by induction via splittings. We shall give, in this section, a proof based on critical moves.

**Proposition 15.1.** *Let  $\varphi : \mathbb{S}^1 \rightarrow \mathbb{R}$  be a general position smooth function. Then there is a marking  $\nu : P \rightarrow \{-1, +1\}$  of its critical set  $P$ , such that for the corresponding ribbon  $a = (\varphi, \nu)$  we have  $\gamma(a) = 0$ .*

*Proof.* We shall define the marking  $\nu$  as follows:  $\nu(p) = +1$  if either  $\varphi$  has a maximum in  $p$ , or an absolute minimum in  $p$ , and  $\nu(p) = -1$  otherwise. We shall show that for the ribbon  $a = (\varphi, \nu)$  we have  $\gamma(a) = 0$ . (Note that  $a$  has signature  $\sigma = 2$ , which is necessary for  $\gamma = 0$ .) It is easy to see that one can find smooth function  $\psi : \mathbb{S}^1 \rightarrow \mathbb{R}$  such that for the map  $F = (\varphi, \psi) : \mathbb{S}^1 \rightarrow \mathbb{R}^2$  the image  $F(\mathbb{S}^1)$  is a Jordan curve in  $\mathbb{R}^2$ . Indeed, suppose that  $\varphi(p_0) = \min \varphi$  and take a small arc  $(x, y) \subset \mathbb{S}^1$  around  $p_0$ . Now, it suffices to define  $\psi$  as strictly increasing in the “big” arc  $(y, x)$  and strictly decreasing in the small arc  $(x, y)$ ; then it is evident that  $F(\mathbb{S}^1)$  is a simple closed curve (Fig. 39). By Jordan-Schoenflies Theorem, there is an extension of  $F$ ,  $\tilde{F} : \mathbb{B}^2 \rightarrow \mathbb{R}^2$  ( $\tilde{F}|_{\mathbb{S}^1} = F$ ), which is a homeomorphism. Now let  $p_1 : \mathbb{R}^2 \rightarrow \mathbb{R}$  be the projection onto the first factor. Clearly,  $p_1 \tilde{F} \in \mathcal{F}(a)$  is a critical points free extension of  $a$ , thus  $\gamma(a) = 0$ .  $\square$

Note that the ribbon  $a$  satisfies some stronger condition except simply  $\gamma(a) = 0$ : it has a *representation* by a Jordan curve. It turns out that not any ribbon with  $\gamma = 0$  has such a representation. In this sense, ribbons like  $a$  may be regarded as the most simple ones. We shall call these *Jordan ribbons*. It is not obvious at all when a ribbon with  $\gamma = 0$  is a Jordan one. There exist some, more or less obvious obstacles for a ribbon with  $\gamma = 0$  (thus  $\sigma = 2$ ) to be a Jordan one. We shall discuss these in Part II in more detail.

**Question.** Describe the class of Jordan ribbons.

There is a relationship between the ribbon invariant and the theory of immersed curves in the plane, this will be explained in Part II of the article. The construction in the above proposition is a quite simple example of this connection.

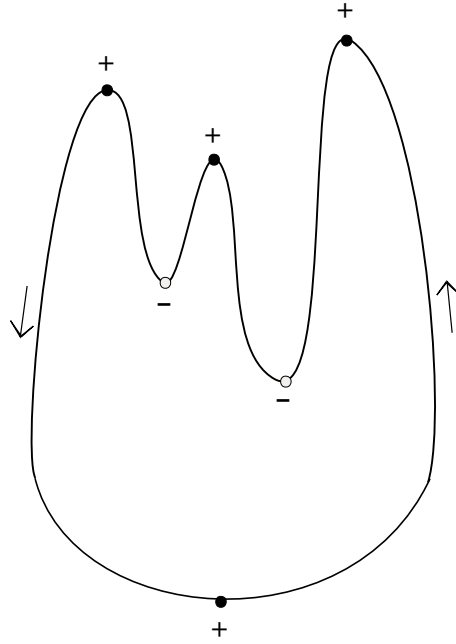

FIGURE 39. The ribbon  $a = (1^+6^+2^-4^+3^-5^+)$  coded by a Jordan curve.

**Corollary 15.2.** *Any general position smooth function  $\varphi : \mathbb{S}^1 \rightarrow \mathbb{R}$  has a critical points free extension  $\Phi : \mathbb{B}^2 \rightarrow \mathbb{R}$ .*

Later we shall investigate the case of non general position (Section 17).

Now we shall improve Proposition 15.1 in the following way.

**Lemma 15.3.** *Any ribbon  $a$  may be transformed into a ribbon  $a'$  with  $\gamma(a') = 0$  by  $\leq \frac{n}{2} + 1$  critical moves  $(+) \leftrightarrow (-)$ .*

*Proof.* We shall proceed by induction on the number of nodes  $n$ . For  $n = 2$  it is obvious: any ribbon transforms into  $(1^+, 2^+)$  by  $\leq 2$  critical moves. Suppose the proposition is true for  $n - 2$  and  $a$  has  $n$  nodes. It is not difficult to see that by  $\leq 1$  critical move we may provide a *cancellable* pair of nodes. Recall that a pair of a negative node  $p$  and a positive node  $q$  is cancellable, if  $p, q$  are consecutive nodes and taking the other neighbour  $r$  of  $q$  (different from  $p$ ) we have  $|\varphi(p) - \varphi(q)| < |\varphi(q) - \varphi(r)|$ . Indeed, for  $n \geq 4$  a tetrad of consecutive nodes  $s, p, q, r$  always exists such that  $|\varphi(s) - \varphi(p)| > |\varphi(p) - \varphi(q)| < |\varphi(q) - \varphi(r)|$ . Now, if  $p$  and  $q$  have opposite marking,  $(p, q)$  is clearly a cancellable pair. In case  $p$  and  $q$  have the same marking, then changing the marking of, say  $p$ , to the opposite one by a critical move, we get a cancellable pair again. Let  $a_0$  be the ribbon obtained from  $a$  by cancellation. Then, according to the induction hypothesis,  $a_0$  may be transformed into a ribbon  $a'_0$  with  $\gamma(a'_0) = 0$  by  $\leq \frac{n-2}{2} + 1 = \frac{n}{2}$  critical moves  $(+) \leftrightarrow (-)$ . Now let  $a'$  be obtained from  $a'_0$  by the *inverse cancellation*, actually an *extension*. By Lemma 13.3, we have

$$\gamma(a') \leq \gamma(a'_0) = 0,$$

hence  $\gamma(a') = 0$ . In such a way,  $a'$  is obtained from  $a$  by  $\leq \frac{n}{2} + 1$  critical moves and the lemma is proved.  $\square$

Now we are a step away from the proof of the desired inequality.

**Theorem 15.4.** *For any ribbon  $a \in \mathcal{A}$  we have  $\gamma(a) \leq \frac{n}{2} + 1$ .*

*Proof.* This follows immediately from [Lemma 15.3](#) and the fact that  $\gamma$  makes a jump of  $\varepsilon = 0, \pm 1$  during a critical move ([Theorem 14.1](#), i)).  $\square$

As we have the inequality  $0 \leq \gamma \leq \frac{n}{2} + 1$ , it is natural to ask which values of  $\gamma$  in the range  $[0, \frac{n}{2} + 1]$  are realizable by a ribbon. The affirmative answer, in some strong sense, is given below.

**Proposition 15.5.** *Let  $\varphi : \mathbb{S}^1 \rightarrow \mathbb{R}$  be a general position smooth function. Then for any  $i \in [0, \frac{n}{2} + 1]$  there is a marking  $\nu$  of the critical set, such that for the ribbon  $a = (\varphi, \nu)$  we have  $\gamma(a) = i$ .*

*Proof.* By [Proposition 15.1](#) there is a marking  $\nu : P \rightarrow \{-1, +1\}$  of the critical set  $P$ , such that for the ribbon  $a_0 = (\varphi, \nu)$  we have  $\gamma(a_0) = 0$ . Since  $\sigma(a_0) = 2$ , the ribbon  $a_0$  has  $s_- = \frac{n}{2} - 1$  negative nodes. Let us perform now consecutively critical moves of type  $(+) \rightarrow (-)$ , obtaining in such a way a series of ribbons  $a_0, a_1, \dots, a_{n/2}$ . It is clear that  $a_{n/2} \in \mathcal{A}_-$ , hence  $\gamma(a_{n/2}) = \frac{n}{2} + 1$ . But since the number of the ribbons  $a_i$  is  $\frac{n}{2} + 1$  and the jump of  $\gamma$  at a critical move is  $\varepsilon = 0, \pm 1$ , it follows that actually all jumps equal  $\varepsilon = +1$  and therefore  $\gamma(a_i) = i$ .  $\square$

Note that this result, combined with the construction from [Proposition 15.1](#), provides us a method for effective geometric construction of ribbons with arbitrary ribbon invariant. All these ribbons have negative nodes. It is not difficult to construct such ribbons from class  $\mathcal{A}^+$ . Another straightforward corollary from [Proposition 15.5](#) is the fact that the quantities  $\frac{\gamma(a)}{n(a)}$  cover all the rationals in  $\mathbb{Q} \cap [0, 1/2]$ , when  $a \in \mathcal{A}$  ( $n(a)$  stands for the number of nodes of ribbon  $a$ ). In fact, one has

**Proposition 15.6.**  $\left\{ \frac{\gamma(a)}{n(a)} \mid a \in \mathcal{A} \right\} = (\mathbb{Q} \cap [0, 1/2]) \cup \left\{ \frac{1}{2} + \frac{1}{n}, n \text{ even} \right\}$ .

The numbers  $\frac{1}{2} + \frac{1}{n}$  come from the extremal ribbons with  $\gamma = \frac{n}{2} + 1$ . Such are for example all ribbons from class  $\mathcal{A}^-$ , although there are some others with this property. This raises the question about the distribution of the quantity  $\frac{\gamma}{n}$  in  $[0, 1/2]$ . More precisely, let  $\mathcal{A} = \{a_i\}$  be ordered by the lexicographic order ([Section 4](#)).

**Question.** What is the distribution of the sequence  $\left\{ \frac{\gamma(a_i)}{n(a_i)} \right\}$  in  $[0, 1/2]$ ? For example, is it uniformly distributed or it has some other peculiar behaviour?

Suppose now that the signature is fixed:  $\sigma = \sigma_0$ , then one may ask again about the distribution of  $\frac{\gamma}{n}$ .

**Proposition 15.7.** *Consider the class  $\mathcal{A}(\sigma_0)$  of ribbons with signature  $\sigma_0$ . Then we have*

$$\overline{\lim} \left\{ \frac{\gamma(a)}{n(a)} \mid a \in \mathcal{A}(\sigma_0) \right\} = \frac{1}{2}.$$

*Proof.* We construct later in [Section 19](#) a ribbon  $a \in \mathcal{A}_n$  with  $\sigma(a) = 2$  and  $\gamma(a) = \frac{n}{2}$  ([Example 19.5](#)). Then by  $|\sigma_0| \pm 2$  critical elementary moves of type  $(+) \leftrightarrow (-)$  we may transform  $a$  into some ribbon  $b$  with  $\sigma(b) = \sigma_0$ . Now, one has  $\gamma(b) \geq$



$\gamma(a) - |\sigma_0| - 2 = \frac{n}{2} - |\sigma_0| - 2$ , thus  $\frac{\gamma(b)}{n} \geq \frac{1}{2} - \frac{|\sigma_0|}{n} - \frac{2}{n}$ , which implies that the above limit superior equals  $\frac{1}{2}$ .  $\square$

Note that the set  $\left\{ \frac{\gamma(a)}{n(a)} \mid a \in \mathcal{A}(\sigma_0) \right\}$  is surely not dense in  $[0, 1/2]$  for  $\sigma_0 < 0$ , in view of the basic inequality  $\gamma \geq 1 - \frac{\sigma}{2}$ .

Another issue should be to consider the distribution of  $\frac{\gamma}{n}$  in class  $\mathcal{A}^+$ . It seems likely that every rational number from  $[0, 1/2)$  is a value of  $\frac{\gamma}{n}$  for some positive ribbon from  $\mathcal{A}^+$ .

Of course, many questions of that kind may be asked, for example: What is the probability while picking a ribbon with  $\sigma = 2$  to get a ribbon with  $\gamma = 0$ , or about the probability while picking a ribbon with  $\gamma = 0$  to get a *Jordan* one, etc.

Let us note finally that the *dual* statement to [Proposition 15.5](#) does not hold true in general. This situation seems more intriguing and complicated.

**Question.** Let  $P \subset \mathbb{S}^1$  be a set of  $n$  points (*nodes*),  $n$  is even, and  $\nu : P \rightarrow \{+, -\}$  be a *marking* with signature  $\sigma$ . Then, under what conditions is it true that for a given number  $k$ , satisfying the general inequality  $1 - \frac{\sigma}{2} \leq k \leq n - 1 - \frac{\sigma}{2}$ , there is a smooth function  $\varphi : \mathbb{S}^1 \rightarrow \mathbb{R}$  with node set  $P$ , such that for the ribbon  $a = (\varphi, \nu)$  we have  $\gamma(a) = k$ ?

Note that the answer in general is “no”, as we pointed out in [Proposition 9.16](#) that some *admissible* pairs  $(\sigma, k)$  are not realized by any ribbon  $a$ . Note also that this is a more detailed variant of this question in [Section 9](#).

The general solution is not known to us, anyway, in some particular cases we have a positive answer to the above question. For example, if  $\sigma = 2$  and  $k = 0$ , this may be done as follows. First, the equality  $\sigma = 2$  allows one to find a *topological* solution to the problem, i.e. a level lines portrait without critical points, which agrees with the marking  $\nu$ . Then it is easy to find some  $\varphi : \mathbb{S}^1 \rightarrow \mathbb{R}$  with this level lines portrait, therefore for the ribbon  $a = (\varphi, \nu)$  we have  $\gamma(a) = 0$ .

## 16. TRUNCATED $C^1$ -RIBBONS

Let  $a = (\varphi, \nu) \in \mathcal{A}$  be a ribbon. Then the function  $\varphi$  may be treated as the  $C^0$ -part of the ribbon, while the mark function  $\nu$  should be its  $C^1$ -part. It is natural to ask what happens if we neglect one of the two parts and look what can be said about the critical points set in the corresponding case. It turns out that separating  $C^0$  from  $C^1$  data is not a very good idea, as the problem is losing geometric flavor and difficulty. Anyway, some results may be obtained in these cases that seem to have interesting applications. So, we deal with such problems in the present and the next sections, resolving them, more or less, completely. At least, no algorithm is needed for solution of the problem, unlike the general case.

The  $C^1$ -part of a ribbon  $a$  is simply a cyclic permutation of two symbols - (+) and (-). In fact, all the smooth information is carried by the signature  $\sigma = s_+ - s_-$ . Curiously, in some cases a satisfactory estimate of the critical set of any extension of the ribbon  $a$  exists. Actually, we have already obtained such an estimate in [Proposition 9.12](#), where the inequality

$$\gamma \geq \gamma_{\text{ext}} \geq 1 - \frac{\sigma}{2}$$

for any ribbon is proved. Therefore, we may take for granted the existence of  $\geq 1 - \frac{\sigma}{2}$  different local extrema of any extension of  $a$ . Of course, this makes sense

only for  $\sigma \leq 0$ . Now we shall use this simple inequality to obtain an estimate from below of the number of critical points of a function on the 2-sphere.

**Theorem 16.1.** *Let  $f : \mathbb{S}^2 \rightarrow \mathbb{R}$  be a smooth function and  $\lambda \subset \mathbb{S}^2$  be a general position smooth simple closed curve. Suppose that  $\nabla f|_\lambda \neq 0$  and let the level lines of  $f$  be touching inwards  $\lambda$  in  $s_+$  points, and are respectively touching outwards  $\lambda$  in  $s_-$  points (no matter the orientation of  $\lambda$ ). Set  $\sigma = s_+ - s_-$  and suppose  $\sigma \neq \pm 2$ . Then for the number  $\Gamma_f$  of critical points of  $f$ , the following inequality holds*

$$\Gamma_f \geq 2 + \frac{|\sigma|}{2}.$$

Moreover,  $f$  has at least  $1 + \frac{|\sigma|}{2}$  local extrema, situated from one and the same side of  $\lambda$ .

If in addition  $f$  is supposed to be a Morse function, then we have a sharper estimate:

$$\Gamma_f \geq |\sigma|.$$

*Proof.* Note first that the inequalities do not depend on the orientation of  $\lambda$ , as we have  $|\sigma|$  in the right-hand side. Considering now a small neighbourhood of  $\lambda$  we get some ribbon  $a_\lambda = (\varphi, \nu)$ , where  $\varphi = f|_\lambda$  and the marking  $\nu$  is assigning  $+1$  at a point of inward touching between  $\lambda$  and a level line of  $f$ , and  $-1$  elsewhere. Note that  $\sigma(a_\lambda) = \pm\sigma$ , depending on the chosen orientation of  $\lambda$ . By Jordan's Theorem  $\lambda$  is separating  $\mathbb{S}^2$  into two regions  $S_1$  and  $S_2$  and clearly,  $f|_{S_1}$  is an extension of, say  $a_\lambda$ , and then  $f|_{S_2}$  is an extension of the ribbon  $\overline{a_\lambda}$ . Now, taking the sum of critical points of both extensions and referring to [Proposition 8.10](#), we have

$$\Gamma_f \geq \gamma(a_\lambda) + \gamma(\overline{a_\lambda}) \geq 2 + \frac{|\sigma|}{2}.$$

As following from [Proposition 9.12](#),  $\gamma_{\text{ext}}(a_\lambda) \geq 1 + \frac{|\sigma|}{2}$ , or  $\gamma_{\text{ext}}(\overline{a_\lambda}) \geq 1 + \frac{|\sigma|}{2}$  is fulfilled, whence the remark about the local extrema. In case  $f$  is a Morse function, we have to refer to [Proposition 9.9](#):

$$\Gamma_f \geq \gamma_0(a_\lambda) + \gamma_0(\overline{a_\lambda}) \geq |\sigma|.$$

It would be interesting to find similar estimates for the other closed 2-manifolds.  $\square$

For  $\sigma = 0, \pm 2$  some minor specifications can be made.

a) If  $\sigma = \pm 2$ , then  $f$  has two local extrema of different type (min and max), situated from one and the same side of  $\lambda$ .

b) If  $\sigma = 0$ , then  $f$  has two local extrema of different type, situated from different sides of  $\lambda$ .

(See [Fig. 40](#) for visualization.)

Clearly, the possible applications of the above theorem depend on the suitable choice of the curve  $\lambda$ . For example, if  $\lambda \subset \mathbb{S}^2$  is a "small" generic curve, then  $\sigma = \pm 2$  and we get only the trivial estimate  $\Gamma_f \geq 2$ . So, it is a good idea to look for some more "globally" situated curve  $\lambda$  providing us with a bigger number of critical points.

At [Fig. 40](#) and [Fig. 41](#) we illustrate [Theorem 16.1](#) for the case of a Morse, and non Morse function  $f$ , correspondingly, where  $f$  is a projection of an embedded copy of  $\mathbb{S}^2$  on a line. Furthermore, at [Fig. 42](#) and [Fig. 43](#) we give the corresponding level portraits. The touching lines of curve  $\lambda$  with the level lines, counting  $\sigma$ , are red colored. Note that there is yet another extremum situated "from behind",

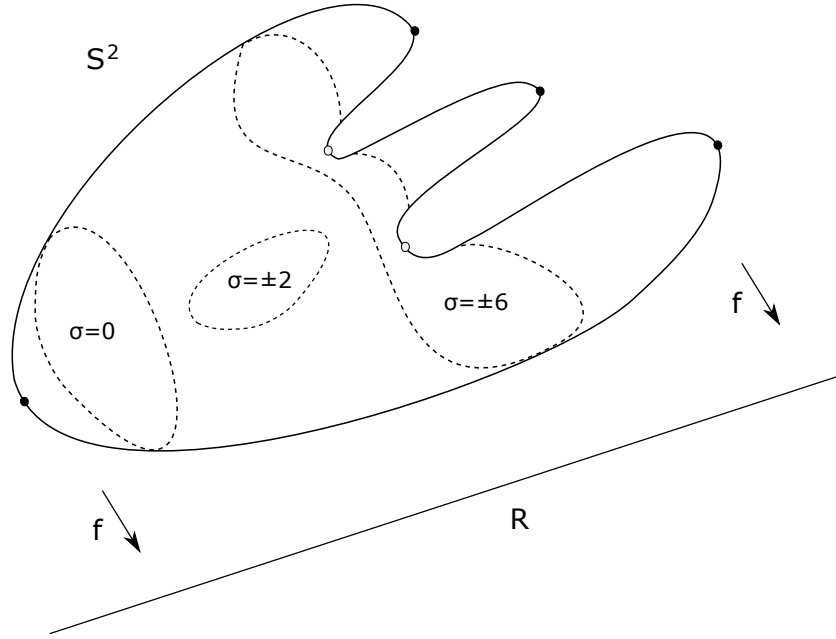

FIGURE 40.  $\sigma = \pm 6$ ,  $\Gamma_f \geq |\sigma| = 6$ , Morse  $f$ .

corresponding to the global minimum of  $f$ . Observe that in the second example (Fig. 41, Fig. 43) the curve  $\lambda$  does not provide us with the actual number of critical points  $\Gamma_f = 7$ .

Note that in the proof of Theorem 16.1 we don't refer to the  $C^0$ -part of ribbon  $a$ , as we get some estimate of the critical set only from the signature  $\sigma$ . Yet from the proof it follows that we may get a stronger estimate of  $\Gamma_f$ , since  $\gamma(a_\lambda) + \gamma(\bar{a}_\lambda)$  may be quite bigger than  $2 + \frac{|\sigma|}{2}$ , due to the  $C^0$ -part of ribbons  $a$  and  $\bar{a}$ . It is not difficult to find  $f$  and  $\lambda$  such that  $\sigma = 0$ , while  $\gamma(a_\lambda) + \gamma(\bar{a}_\lambda)$  is arbitrarily large. So, it seems appropriate to formulate the corresponding estimates in full strength.

**Definition 16.2.** Let  $f : \mathbb{S}^2 \rightarrow \mathbb{R}$  be a smooth function and  $\lambda \subset \mathbb{S}^2$  be a general position smooth simple closed curve such that  $\nabla f|_\lambda \neq 0$ . Let  $a_\lambda$  denote the ribbon associated with  $\lambda$  defined (up to orientation) in Theorem 16.1. Consider the following two numbers

1) the critical index:

$$\mu(f) = \max\{\gamma(a_\lambda) + \gamma(\bar{a}_\lambda) \mid \lambda \subset \mathbb{S}^2\},$$

where  $\lambda$  runs over all curves in  $\mathbb{S}^2$  with the above property

2) the Morse critical index:

$$\mu_0(f) = \max\{\gamma_0(a_\lambda) + \gamma_0(\bar{a}_\lambda) \mid \lambda \subset \mathbb{S}^2\}$$

where  $\lambda$  runs in the same class.

Then, in Theorem 16.1 we have proved in fact that for arbitrary  $f$

$$\Gamma_f \geq \mu(f),$$

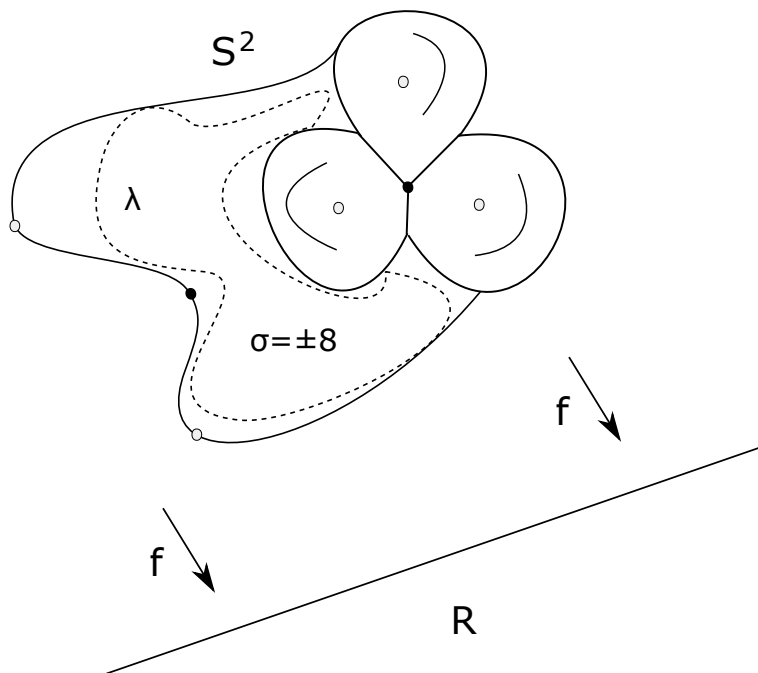

FIGURE 41.  $\sigma = \pm 8$ ,  $\Gamma_f \geq 2 + \frac{|\sigma|}{2} = 6$ , but  $\Gamma_f = 7$ , non Morse  $f$ .

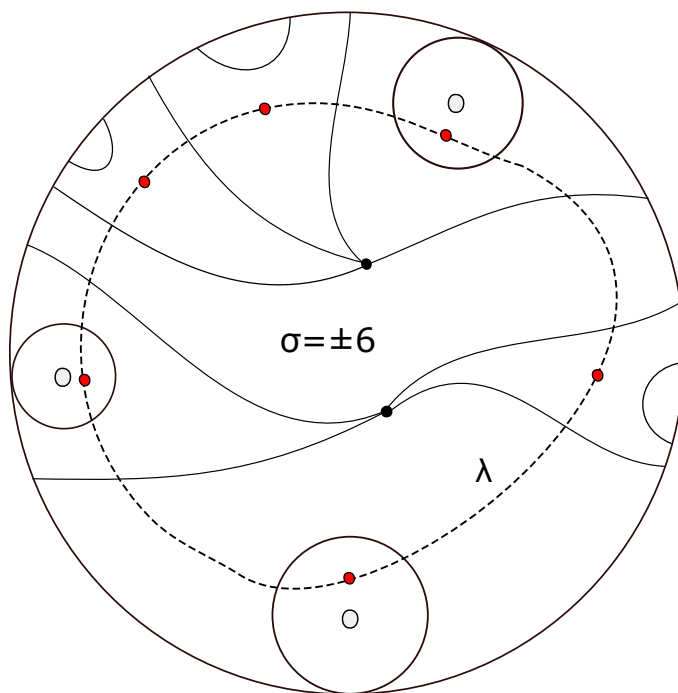

FIGURE 42. A level picture of Fig. 40, Morse  $f$ .

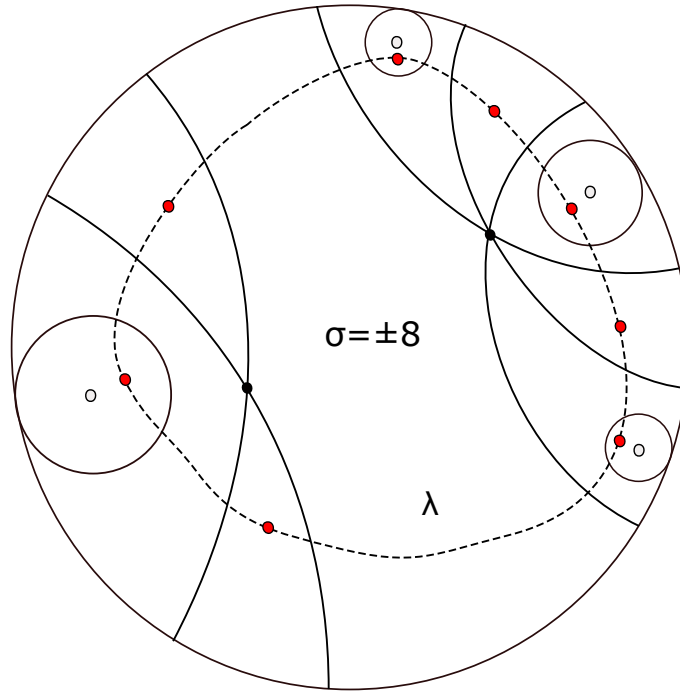

FIGURE 43. A level picture of Fig. 41, non Morse  $f$ .

while for a Morse function  $f$

$$\Gamma_f \geq \mu_0(f).$$

Note that for arbitrary  $f$  it may happen  $\Gamma_f > \mu(f)$ . For example, if  $f$  has 3 critical points, one of which has index 0 (removable singularity), then  $\Gamma_f = 3$ , while it is easy to see that  $\mu(f) = 2$ .

On the other hand, for a Morse function  $f$  such examples with a removable critical point do not exist. So, let us ask the following

**Question.** If  $f : \mathbb{S}^2 \rightarrow \mathbb{R}$  is a Morse function, is it true that  $\Gamma_f = \mu_0(f)$ ?

From point of view of multidimensional ribbons, that we don't investigate here, but anyway mentioned in the introduction, it is clear that we may look for some ribbon-based method strengthening the Lusternik-Schnirelmann and Morse inequalities. In the case of  $\mathbb{S}^2$  these inequalities give the trivial estimate 2 for the number of critical points. It is clear that for an arbitrary "random" function  $f$  the number of critical points  $\Gamma_f$  is surely greater than 2 and the critical index  $\mu(f)$  is also surely greater than 2. So, there is a reason to look for  $\mu(f)$  in order to obtain a valuable estimate for  $\Gamma_f$ .

Let us formulate, anyway, some result for the multidimensional case, as it is straightforward and needs only the right ribbon definitions.

Let  $M$  be a closed  $n$ -manifold and  $f : M \rightarrow \mathbb{R}$  be a smooth function. Denote by  $b(M)$  the sum of the Betti numbers of  $M$ , and by  $\text{cat}(M)$  the Lusternik-Schnirelmann category of  $M$ . Then for the number  $\Gamma_f$  of critical points of  $f$ , the following inequalities hold:

$$\Gamma_f \geq \mu(f) \geq \text{cat}(M),$$

and in the case of a Morse function  $f$

$$\Gamma_f \geq \mu_0(f) \geq b(M).$$

The left inequalities are proved above, while  $\mu(f) \geq \text{cat}(M)$  and  $\mu_0(f) \geq b(M)$  follow from the fact that both quantities  $\gamma(a_\lambda) + \gamma(\overline{a_\lambda})$  and  $\gamma_0(a_\lambda) + \gamma_0(\overline{a_\lambda})$  are realizable as the number of critical points of some  $f$ , which in the second case is Morse, and of course, from the fundamental inequalities in Lusternik-Schnirelmann and Morse theories. The multidimensional generalizations of the ribbon invariant will be discussed later, although almost nothing is done in the present article in this direction. Note at this stage, that we have to be careful with the definition of a multidimensional ribbon and  $\gamma$ , as these have to be elaborated for the case of a manifold with boundary  $(M, \partial M)$ , instead of  $(\mathbb{B}^n, \mathbb{S}^{n-1})$ .

## 17. TRUNCATED $C^0$ -RIBBONS

The most simple situation of a Rolle type problem in dimension 2 arises when considering a smooth function  $\varphi : \mathbb{S}^1 \rightarrow \mathbb{R}$  and asking whether  $\varphi$  has a critical points free extension on the 2-disk, or not. We may say that  $\varphi$  is a truncated  $C^0$ -ribbon, as we are “forgetting” the  $C^1$ -information of some ribbon  $a = (\varphi, \nu)$ . Note that for a general position function  $\varphi$  (with different critical levels), a critical points free extension always exists, according to [Proposition 15.1](#). So, this question is not very interesting for a generic  $\varphi$ .

In this section, we shall anyway prove some result about non generic functions  $\varphi$ , where coincidence of critical levels is allowed. Roughly speaking, this result says that if  $\varphi$  has sufficiently many absolute extrema (absolute majority), then any smooth extension of  $\varphi$  has a critical point.

Let us say that  $\varphi : \mathbb{S}^1 \rightarrow \mathbb{R}$  is a *Rolle function*, if any its extension  $f : \mathbb{B}^2 \rightarrow \mathbb{R}$  has a critical point. In the ribbon terminology,  $\varphi$  is a Rolle function, if for any marking  $\nu$  of the node set the ribbon  $a = (\varphi, \nu)$  has nonzero ribbon invariant:  $\gamma(a) > 0$ . Here we shall allow non general position ribbons with coinciding critical levels.

**Theorem 17.1.** *Let  $\varphi : \mathbb{S}^1 \rightarrow \mathbb{R}$  be a smooth function with  $n$  local and  $s$  absolute extrema. Then  $\varphi$  is a Rolle function if and only if*

$$s > \frac{n}{2} + 1.$$

*Proof.* Let  $s > \frac{n}{2} + 1$  for  $\varphi : \mathbb{S}^1 \rightarrow \mathbb{R}$ . Suppose that  $\varphi$  is not a Rolle function, i.e. it has an extension  $f : \mathbb{B}^2 \rightarrow \mathbb{R}$  without critical points. Then at each absolute extremum of  $\varphi$  the marking of the corresponding ribbon is positive, since otherwise  $f$  should have an absolute extremum in an internal point of  $\mathbb{B}^2$ , and thus a critical point. Therefore for the ribbon corresponding to  $f$  we have  $s_+ > \frac{n}{2} + 1$ , hence  $\sigma = s_+ - s_- \geq 4$ . But we know that the equality  $\sigma = 2$  is necessary for the existence of a critical points free extension (even for non general position ribbons), which is a contradiction. Let now  $\varphi : \mathbb{S}^1 \rightarrow \mathbb{R}$  be a function satisfying  $s \leq \frac{n}{2} + 1$ . We have to show that  $\varphi$  has an extension  $f : \mathbb{B}^2 \rightarrow \mathbb{R}$  without critical points. But this is not that difficult to be done by induction on  $n$  by cancellation of a pair of nodes. For  $n = 2$  the statement is trivially true. Suppose it is true for  $n - 2$ . Take 3 consecutive nodes  $p, q$  and  $r$  such that  $\varphi$  has a non absolute extremum in  $p$  and an absolute one in  $q$ .

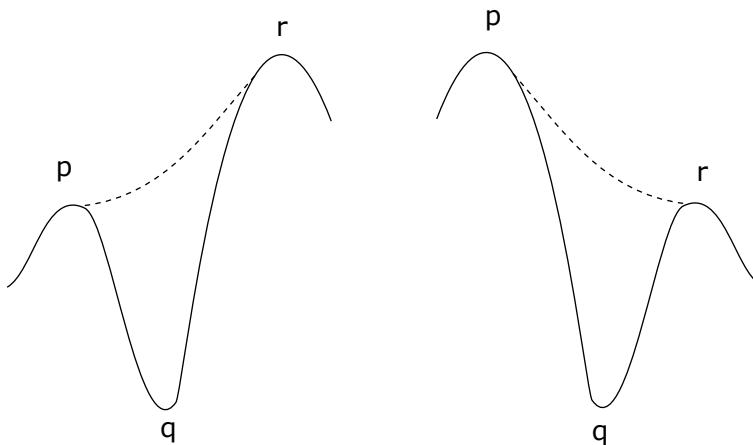

FIGURE 44. Two types of cancellation.

There are 2 cases (see Fig. 44): 1)  $|\varphi(p) - \varphi(q)| \leq |\varphi(q) - \varphi(r)|$ . Then  $p$  is not a node of absolute extremum and we may do cancellation of  $p$  and  $q$  (see Definition 13.1), obtaining in such a way a new function  $\varphi'$ . 2)  $|\varphi(p) - \varphi(q)| \geq |\varphi(q) - \varphi(r)|$ . Then  $r$  is not a node of absolute extremum and we may perform cancellation of  $q$  and  $r$ , obtaining again some  $\varphi'$ . Now, in both cases  $\varphi'$  is satisfying the assumed inequality. Indeed,  $\varphi'$  has  $n - 2$  nodes and  $s - 1$  absolute extrema, hence  $s - 1 \leq \frac{n-2}{2} + 1$ , as the latter is equivalent to  $s \leq \frac{n}{2} + 1$ . Therefore,  $\varphi'$  has a critical points free extension  $f' : \mathbb{B}^2 \rightarrow \mathbb{R}$ . Let  $a' = (\varphi', \nu')$  be the ribbon defined by  $f'$ . Now, define the ribbon  $a = (\varphi, \nu)$  so that the marking  $\nu$  coincides with  $\nu'$  in the common nodes, the canceled absolute extremum is made “positive” and the other canceled node - “negative”. Since  $a'$  is obtained from  $a$  by cancellation, we have  $\gamma(a) \leq \gamma(a')$  (Lemma 13.3). But as  $\gamma(a') = 0$ , it follows that  $\gamma(a) = 0$ , i.e.  $\varphi$  has a critical point free extension on  $\mathbb{B}^2$ .  $\square$

It would be interesting to describe the (combinatorially/topologically) different critical points free extensions of a function satisfying  $s \leq \frac{n}{2} + 1$ . Even in the case of a general position function (then  $s = 2$ ), this may be of some interest. In particular, one may ask about some estimates of the number of critical points free extensions of such functions. For example, in the case of a ladder with  $n$  nodes, this number equals exactly  $2^{\frac{n}{2}-1}$ , as follows easily from Proposition 12.4.

There is a geometrical application of Theorem 17.1 about the realization of a given direction by a membrane in  $\mathbb{R}^3$  spanned by a fixed frame. The setting of the problem is the following.

Let  $l$  be an immersed smooth closed curve in  $\mathbb{R}^3$  and  $\xi$  be some fixed direction. Then the problem is:

Under what conditions is it true that any smooth immersed 2-disk  $M$  with boundary  $\partial M = l$  is realizing direction  $\xi$ , i.e., some normal to  $M$  is parallel to  $\xi$ ?

Note that the answer to this question may be viewed as a 2-dimensional variant of Lagrange’s Theorem in  $\mathbb{R}$ . In some more geometric terminology, we may say that

$l$  is a frame and  $M$  is a membrane spanned by  $l$ . It is now clear, that [Theorem 17.1](#) provides us with an easy sufficient condition for realization of direction  $\xi$ .

**Proposition 17.2.** *Let  $l$  be an immersed smooth closed curve in  $\mathbb{R}^3$  which is the image of a smooth map  $h : \mathbb{S}^1 \rightarrow \mathbb{R}^3$  and  $\xi$  be some fixed direction. Take some line  $L$  with direction  $\xi$  and let  $\pi : \mathbb{R}^3 \rightarrow L$  be the projection. Suppose that the composition  $\pi h : \mathbb{S}^1 \rightarrow L$  has  $n$  local and  $s$  absolute extrema, so that  $s > \frac{n}{2} + 1$ . Then for any smooth immersed 2-disk  $M$  with boundary  $\partial M = l$  there is a point  $x \in M$  where the normal vector is parallel to  $\xi$ .*

*Proof.* This is a straightforward corollary from [Theorem 17.1](#), as the set of points  $x \in M$  with normal vector parallel to  $\xi$  coincides with the set of critical points of  $\pi h$ .  $\square$

It would be interesting to prove the converse proposition. This could be done by following the next plan: since  $s \leq \frac{n}{2} + 1$ , by [Theorem 17.1](#) there is a critical points free extension  $f : \mathbb{B}^2 \rightarrow \mathbb{R}$  of  $\pi h$ . Now, if we can find an immersion  $H : \mathbb{B}^2 \rightarrow \mathbb{R}^3$  such that  $H\pi = f$ , then  $M = H(\mathbb{B}^2)$  would be a membrane spanned by  $l$ , not realizing  $\xi$  as a normal direction. Unfortunately, we don't have a proof that such an immersion  $H$  exists.

**Question.** Does an immersion  $H$  with the above properties exists?

It is natural also to ask, given some frame  $l \subset \mathbb{R}^3$ , whether there exists some vector  $\xi$  which is realizable as a normal direction of any membrane spanned by  $l$ . This would be a kind of 2-dimensional variant of Lagrange's Theorem. It turns out that, in general, the answer to this question is negative. However, in some "non general position" cases, such directions do exist. We give below some example of a frame, such that any membrane spanned by it realizes the principal directions  $\mathbf{i}, \mathbf{j}, \mathbf{k}$ .

For a given membrane  $M$ , let us denote by  $N(M)$  the set of all normal directions to  $M$ . Now, if  $l \subset \mathbb{R}^3$ , let us define

$$\Xi(l) = \cap \{N(M) \mid \partial M = l\},$$

i.e.  $\Xi(l)$  is the set of directions realizable by any membrane spanned by  $l$ .

**Fact 17.3.**  $\Xi(l) = \emptyset$  for a generic frame  $l$ .

We shall not prove this here, but rather will give an example in the opposite direction.

**Example 17.4.** *There is a frame  $l$  with  $\Xi(l) \supset \{\mathbf{i}, \mathbf{j}, \mathbf{k}\}$ .*

We shall sketch the corresponding example, without going into full technical details. Let us say for brevity, that a function  $\varphi : \mathbb{S}^1 \rightarrow \mathbb{R}$  with  $n$  local and  $s$  absolute extrema is a *quasi-alternation*, if  $s > \frac{n}{2} + 1$ . Such a function oscillates sufficiently often between  $\min \varphi$  and  $\max \varphi$ . Let  $\pi_i : \mathbb{R}^3 \rightarrow \mathbb{R}$  be the  $i$ -th projection. Now, the construction of the desired frame  $l$  proceeds in 3 stages. First, we construct some map  $\lambda_1 : [0, 1] \rightarrow \mathbb{R}^3$  such that  $\pi_1 \lambda_1$  oscillates sufficiently many times between two values (say, -1 and 1), while  $\pi_2 \lambda_1$  and  $\pi_3 \lambda_1$  are monotonic. This can be easily provided. Then we repeat the same procedure, obtaining maps  $\lambda_2$  and  $\lambda_3$ . Set  $l_i = \lambda_i([0, 1])$  and finally glue together the arcs  $l_i$  into a frame  $l$  by 3 simple "buffer" segments. Now, it follows from the construction that if  $h : \mathbb{S}^1 \rightarrow \mathbb{R}^3$  is a parametrization of  $l$ , then  $\pi_i h$  is a quasi-alternation for  $i = 1, 2, 3$ . But then from



[Proposition 17.2](#) we conclude that the principal directions  $\mathbf{i}, \mathbf{j}, \mathbf{k}$  are realized by any membrane spanned by  $l$ .

This example gives rise to the following general

**Question.** For any finite set of vectors  $\xi_1, \dots, \xi_n$ , is it true that a frame  $l$  exists, such that  $\Xi(l) \supset \{\xi_1, \dots, \xi_n\}$ ?

As following from [Theorem 17.1](#), a general position function  $\varphi : \mathbb{S}^1 \rightarrow \mathbb{R}$  has a critical points free extension. So, it is natural to ask about the number of all such extensions (distinguished combinatorially). Here we shall give only an estimation from below of this number.

It turns out that the critical points free extensions are in one-to-one correspondence with the extension of the correspondent ribbon from  $\mathcal{A}^-$ , which is realizing the ribbon invariant.

**Proposition 17.5.** *Let  $\varphi : \mathbb{S}^1 \rightarrow \mathbb{R}$  be a general position (Morse) function and  $a = (\varphi, \nu^-) \in \mathcal{A}^-$  be the ribbon with all nodes marked as negative. Then the critical points free extensions of  $\varphi$  are in a natural one-to-one correspondence with the extensions of  $a$ , realizing  $\gamma(a)$ . (Recall that  $\gamma = \frac{n}{2} + 1$  in  $\mathcal{A}^-$ .)*

It is not difficult to see that for a negative ladder  $a$  the number of the extensions of  $a$ , realizing  $\gamma(a)$  equals  $2^{\frac{n}{2}-1}$ . Now, by the critical moves technique and [Proposition 12.4](#) one gets

**Theorem 17.6.** *Let  $\varphi : \mathbb{S}^1 \rightarrow \mathbb{R}$  be a general position smooth function. Then the number of critical points free extensions of  $\varphi$  is  $\geq 2^{\frac{n}{2}-1}$ .*

So, there is a natural

**Question.** For a general position function  $\varphi : \mathbb{S}^1 \rightarrow \mathbb{R}$ , what is the number of critical points free extensions of  $\varphi$ ? Is it true that this number is the same for all alternations  $\varphi$ ?

#### 18. ESTIMATE FOR THE NUMBER OF COMPONENTS OF THE CRITICAL SET

The ribbon invariant  $\gamma(a)$  gives an estimate from below of the number of critical points of the extensions  $f \in \mathcal{F}(a)$  of a given ribbon  $a$ . However, it is not clear what can be said about the number of components of the critical set  $\text{Crit}(f)$  of an arbitrary extension  $f \in \mathcal{F}(a)$ . For example, our previous investigations around  $\gamma$  do not exclude a situation when  $\gamma(a)$  is big, but there is some  $f \in \mathcal{F}(a)$  with connected set of critical points. However, we will show in the present section that this is impossible, since  $\gamma(a)$  is an estimate from below of the number of components of the critical set  $\text{Crit}(f)$  of any extension  $f \in \mathcal{F}(a)$ .

**Lemma 18.1.** *Let  $a = (\varphi, \nu)$  be a ribbon and  $f \in \mathcal{F}(a)$ . Suppose that  $p$  is a negative node of  $a$ . Then there is a ribbon  $a' \sim a$  and some  $f_0 \in \mathcal{F}(a')$  such that  $\text{Crit}(f_0) = \text{Crit}(f)$  and the level line of  $f_0$  through  $p$  is a regular touching line.*

*Proof.* By Sard's Theorem, we may find  $x', x'' \in \mathbb{S}^1$  close to  $p$ , situated from different sides of  $p$  and such that  $\varphi(x') = \varphi(x'') = \alpha$  is a noncritical level of  $f$ . Then, by a small perturbation near  $p$ , we may define the ribbon  $a' = (\varphi', \nu)$  in such a way that  $\varphi'(p') = \alpha$ , where  $p'$  is a negative node. Then  $f$  perturbs to some  $f_0$ , according to the picture at [Fig. 45](#). Thus, the level line of  $f_0$  through  $p'$  is regular. Now, since  $a'$  is obtained from  $a$  by a small perturbation, it follows that  $a' \sim a$ . Note that the perturbation does not affect the critical set  $\text{Crit}(f)$ . From geometrical point of

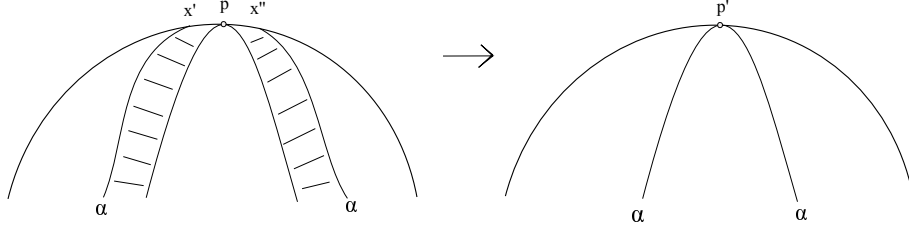

FIGURE 45. Regularization at a negative node.

view this perturbation corresponds to a small vertical move of the ribbon at node  $p$ , so that the new value  $\varphi(p)$  becomes noncritical.  $\square$

**Theorem 18.2.** *Let  $a \in \mathcal{A}$  be a ribbon and  $f \in \mathcal{F}(a)$  be some extension. Then the number of components of the critical set  $\text{Crit}(f)$  is  $\geq \gamma(a)$ .*

*Proof.* We shall use induction on the lexicographic ordering in  $\mathcal{A}$ . For irreducible ribbons the theorem is obvious. Suppose it is true for ribbons with  $\leq n - 2$  nodes and let  $a \in \mathcal{A}_n$ . There are 2 cases. 1) The ribbon  $a$  has a negative node  $p$ . Then, according to Fig. 45, we may suppose that the level line  $l$  of  $f$  passing through  $p$  is a regular touching line. Perform a ternary splitting  $f = f_1 \circ f_2 \circ f_3$  along  $l$ , which induces a splitting  $a = a_1 * a_2 * a_3$ . Then  $\gamma(a_i) \prec \gamma(a)$ ,  $i = 1, 2, 3$ . The line  $l$  is dividing  $\mathbb{B}^2$  into 3 regions  $W_1, W_2, W_3$ . We may suppose that the number of components of  $\text{Crit}(f)$  is finite, say  $k$ . Let  $k_i$  be the number of components of  $W_i \cap \text{Crit}(f)$ , then  $k_i$  is the number of components of  $\text{Crit}(f_i)$  and  $k_1 + k_2 + k_3 = k$ . By the induction hypothesis  $\gamma(a_i) \leq k_i$ . Thus

$$\gamma(a) \leq \gamma(a_1) + \gamma(a_2) + \gamma(a_3) \leq k_1 + k_2 + k_3 = k.$$

2)  $a \in \mathcal{A}_+$ . If the cluster number  $\delta(a)$  equals 1, then  $a$  is an alternation and the theorem is obvious. Suppose that  $\delta(a) \geq 2$  and let  $C_1, C_2$  be two different clusters. Take some regular level  $c$  of  $f$  between  $C_1$  and  $C_2$  (such a level exists according to Sard's Theorem). Then  $f$  has a regular level line  $l$  at level  $c$ . We proceed now as in 1). Perform a binary splitting  $f = f_1 \vee f_2$  along  $l$ , which induces a splitting  $a = a_1 \# a_2$ . Since  $c$  is between  $C_1$  and  $C_2$ , we have  $\gamma(a_i) \prec \gamma(a)$ ,  $i = 1, 2$ . The line  $l$  is dividing the disk into 2 regions  $W_1, W_2$ . Let  $k_i$  be the number of components of  $W_i \cap \text{Crit}(f)$ , then  $k_i$  is the number of components of  $\text{Crit}(f_i)$  and  $k_1 + k_2 = k$  is the number of components of  $\text{Crit}(f)$ . Now, since  $\gamma(a_i) \leq k_i$  by the induction hypothesis, we have

$$\gamma(a) \leq \gamma(a_1) + \gamma(a_2) \leq k_1 + k_2 = k.$$

The theorem is proved.  $\square$

**Corollary 18.3.** *Let  $f : \mathbb{R}^2 \rightarrow \mathbb{R}$  be a smooth function and  $K$  be an isolated component of the critical set  $\text{Crit}(f)$ . Take a smooth simple closed curve  $\lambda$  such that if  $W$  is its interior, then  $\overline{W} \cap \text{Crit}(f) = K$ . Let  $a_\lambda$  denote the ribbon defined by the restriction of  $f$  on  $\lambda$ . Then*

$$\gamma(a_\lambda) \leq 1.$$

*Moreover,  $\gamma(a_\lambda) = 0$  if and only if  $\sigma(a_\lambda) = 2$  ( $\sigma$  is the signature).*

*Proof.* This is an immediate corollary from [Theorem 18.2](#), as  $f|_{\overline{W}}$  is an extension of  $a_\lambda$  with connected critical set. Hence, by the theorem  $1 \geq \gamma(a_\lambda)$ . Note that  $\gamma = 0 \Rightarrow \sigma = 2$ , but the converse is not true for arbitrary ribbons. (Recall that  $\sigma = 2 \Leftrightarrow \deg(\nabla f|_\lambda) = 0$ .) Let  $\sigma(a_\lambda) = 2$  and suppose that  $\gamma(a_\lambda) \neq 0$ . Then  $\gamma(a_\lambda) = 1$ , but we know that the case  $(\sigma = 2, \gamma = 1)$  is impossible ([Proposition 9.16](#)), a contradiction.  $\square$

In such a way, we have either  $\gamma(a_\lambda) = 0$ , or  $\gamma(a_\lambda) = 1$ . Of course, both cases are possible in general. However, if  $f|_{\overline{W}}$  is an economic extension of  $a_\lambda$ , then  $\gamma(a_\lambda) = 0$  is impossible, since then  $K$  would be a single point of zero index, but economic extensions don't have such critical points.

Note also that [Corollary 18.3](#) has some geometrical meaning:

*Under the above assumptions, we may transform  $K = \text{Crit}(f)$  into a single point, or into  $\emptyset$ , by a smooth homotopy which does not disturb a small neighborhood of  $\lambda$ . If  $\deg(\nabla f|_\lambda) = 0$ , then the critical set may be completely removed by such a homotopy, while in case  $\deg(\nabla f|_\lambda) = k \neq 0$ , it can be reduced to a single point of index  $k$ .*

This will be discussed in the next section in a more general setting. In higher dimensions, it would be interesting whether similar statement holds true, say in case  $K$  is homologically trivial.

## 19. THE RIBBON INVARIANT $\gamma_\infty$ FOR FUNCTIONS ON $\mathbb{R}^2$

Consider a Morse function  $f : \mathbb{R}^2 \rightarrow \mathbb{R}$  with one local maximum  $p$ , one (non-degenerate) saddle  $q$  and no other critical points. Let us perturb  $f$  by a smooth homotopy  $f_t$  with compact support, i.e. such that

$$f_t(x) = f(x) \text{ for } x \in \mathbb{R}^2 \setminus W, t \in [0, 1],$$

where  $W$  is some bounded region in  $\mathbb{R}^2$ . The natural expectation is that  $p$  and  $q$  may “annihilate” so that the final function  $f_1(x)$  will not have critical points in  $\mathbb{R}^2$ . This expectation relies on the fact that such a pair  $p, q$  always may be born by an elementary bifurcation in a critical points free zone. Well, it turns out that this is not true in general - there are cases when  $p$  and  $q$  may “annihilate”, and other ones, when this cannot be done and each  $f_t$  will have at least two critical points. Such examples are given later in this section. It is clear that the particular case depends on the behaviour of  $f$  “at infinity”. We shall show, in the present section, that there is a simple ribbon type invariant  $\gamma_\infty(f)$  which is controlling the minimal number of critical points during a homotopy of  $f$  with compact support.

Let  $\lambda_1$  and  $\lambda_2$  be two simple closed curves in  $\mathbb{R}^2$  such that  $\lambda_1$  lies in the interior of  $\lambda_2$ . Then we shall write for brevity  $\lambda_1 \prec \lambda_2$ . If  $f : \mathbb{R}^2 \rightarrow \mathbb{R}$  is a smooth function and  $\lambda$  is a closed curve not intersecting  $\text{Crit}(f)$ , recall that by  $a_\lambda(f)$  we denote the ribbon defined by the restriction of  $f$  and  $\nabla f$  on  $\lambda$ . Of course, we implicitly suppose that  $\lambda$  is a generic curve, so that  $a_\lambda(f) \in \mathcal{A}$ .

**Proposition 19.1.** *Let  $f : \mathbb{R}^2 \rightarrow \mathbb{R}$  be a smooth function and  $\lambda_1$  and  $\lambda_2$  be two simple closed curves containing  $\text{Crit}(f)$  in its interior. Then if  $\lambda_1 \prec \lambda_2$ , we have*

$$\gamma(a_{\lambda_1}(f)) \geq \gamma(a_{\lambda_2}(f)).$$

*Proof.* Let  $W_1$  be the interior of  $\lambda_1$  and  $W$  be the open annulus between  $\lambda_1$  and  $\lambda_2$ . Suppose that  $\gamma(a_{\lambda_1}(f)) = k$ , then there is an extension  $f_1 : \overline{W}_1 \rightarrow \mathbb{R}$  of the ribbon  $a_{\lambda_1}(f)$  with  $k$  critical points. We may suppose that  $f \equiv f_1$  in some small

neighbourhood of  $\lambda_1$ . Now one defines an extension  $f_2 : \overline{W}_1 \cup W \rightarrow \mathbb{R}$  of  $a_{\lambda_2}(f)$  by setting

$$f_2|_{\overline{W}_1} = f_1 \text{ and } f_2|_W = f.$$

It is now clear that  $f_2$  has  $k$  critical points, as  $f$  is critical points free in  $W$ . Therefore  $\gamma(a_{\lambda_2}(f)) \leq k$ , thus  $\gamma(a_{\lambda_1}(f)) \geq \gamma(a_{\lambda_2}(f))$ .  $\square$

**Proposition 19.2.** *Let  $f : \mathbb{R}^2 \rightarrow \mathbb{R}$  be a smooth function and  $\lambda_1 \prec \lambda_2 \prec \dots$  be an infinite sequence of simple closed curves containing  $\text{Crit}(f)$  in its interior. Then the following limit exists*

$$L = \lim_{i \rightarrow \infty} \gamma(a_{\lambda_i}(f)).$$

*Proof.* By [Proposition 19.1](#), the sequence  $\gamma(a_{\lambda_i}(f))$  is decreasing in  $i$ , hence the above limit surely exists, since  $\gamma(a_{\lambda_i}(f)) \in \mathbb{N} \cup \{0\}$ .  $\square$

Denote by  $B_r$  the disk  $x^2 + y^2 \leq r$ . Let  $\lambda$  is containing the origin in its interior  $W$ , then we shall denote by  $d(\lambda)$  the number

$$d(\lambda) = \sup\{r \mid B_r \subset W\}.$$

**Theorem 19.3.** *Let  $f : \mathbb{R}^2 \rightarrow \mathbb{R}$  be a smooth function with bounded critical set and  $\lambda_1 \prec \lambda_2 \prec \dots$  be an infinite sequence of simple closed curves such that  $d(\lambda_i) \rightarrow \infty$ . Suppose that  $a_{\lambda_i}(f) \in \mathcal{A}$ . Then the following limit exists*

$$\gamma_\infty(f) = \lim_{i \rightarrow \infty} \gamma(a_{\lambda_i}(f)),$$

*and does not depend on the choice of sequence  $\lambda_i$ . Furthermore, for any homotopy  $f_t$  with compact support such that  $f_0 = f$ , we have  $\gamma_\infty(f_1) = \gamma_\infty(f)$ .*

This is an immediate corollary from [Propositions 19.1, 19.2](#). We shall call  $\gamma_\infty$  ribbon number *at infinity*. Clearly,  $\gamma_\infty(f)$  controls the minimal number of critical points under perturbations of  $f$  with compact support. For example,  $\gamma_\infty = 0$  is equivalent to the possibility to remove all critical points by such a perturbation. From the properties of  $\gamma$  we have

$$\gamma_\infty(f) \geq \deg(\nabla f|_\lambda)$$

for any  $\lambda$  surrounding  $\text{Crit}(f)$ . Of course, strict inequality is possible, as elementary examples further show.

Note that we may consider similarly all other ribbon invariants *at infinity*, obtaining in such a way some numbers  $\gamma_\infty^0$ ,  $\gamma_\infty^{ext}$ ,  $\gamma_\infty^{sad}$ . The argumentation about these is identical with that one about  $\gamma$ .

There is a simple method for constructing different examples, by extending the boundary of a ribbon “at infinity”.

**Proposition 19.4.** *Let  $a \in \mathcal{A}$  be a ribbon and  $f : \mathbb{B}^2 \rightarrow \mathbb{R}$  be its extension,  $f \in \mathcal{F}(a)$ . Then there is a smooth function  $f_0 : \mathbb{R}^2 \rightarrow \mathbb{R}$  such that  $f_0|_{\mathbb{B}^2} = f$ ,  $\text{Crit}(f_0) = \text{Crit}(f)$  and  $\gamma_\infty(f_0) = \gamma(a)$ .*

**Example 19.5.** *We shall give an example of a Morse function  $f : \mathbb{R}^2 \rightarrow \mathbb{R}$  such that its critical set consists of  $k$  nondegenerate extrema and  $k$  nondegenerate saddles with  $\gamma_\infty(f) = \gamma_\infty^0(f) = 2k$ ,  $\gamma_\infty^{ext}(f) = \gamma_\infty^{sad}(f) = k$ . This means that the total number of critical points cannot be reduced under  $2k$ , moreover, the number of local extrema and of saddle points cannot be reduced under  $k$  by a smooth homotopy  $f_t$  with compact support. (Of course, in order this to be true in the part concerning*

saddles, we have to suppose that  $\text{Crit}(f_t)$  is finite for each  $t$ , since otherwise we may destroy saddles at the price of the birth of infinite number of critical points.) In such a way, roughly speaking, no one pair extremum-saddle of  $f$  can annihilate under such a homotopy.

Here is the example. Take an arbitrary  $a \in \mathcal{A}_{2k}^-$  and let  $b \in \mathcal{A}_{2k+2}^+$  be a positive ladder. Now let  $a_1$  be the ribbon, which is identical to  $a$ , except for the maximal node, which is made “positive”. We know that  $\gamma(a) = \gamma_{\text{ext}}(a) = \frac{2k}{2} + 1 = k + 1$ ,  $\gamma(b) = \gamma_{\text{sad}}(b) = \frac{2k+2}{2} - 1 = k$ . Furthermore,  $\gamma(a_1) = \gamma(a) - 1 = k$ , as we know from the opening remarks. Now we may consider the “connected sum”  $a_1 \# b$ , which is obtained by applying the maximal node of  $a_1$  to the minimal one of  $b$  and then “canceling” them. (This is explained in details in [Section 21](#).) It is quite easy to show that the ribbon invariants are additive under such operation:  $\gamma(a_1 \# b) = \gamma(a_1) + \gamma(b) = k + k = 2k$ ,  $\gamma_{\text{ext}}(a_1 \# b) = \gamma_{\text{ext}}(a_1) + \gamma_{\text{ext}}(b) = k + 0 = k$ ,  $\gamma_{\text{sad}}(a_1 \# b) = \gamma_{\text{sad}}(a_1) + \gamma_{\text{sad}}(b) = 0 + k = k$ . Take the natural Morse extension  $g \in \mathcal{F}(a_1 \# b)$  which is realizing  $\gamma$  and all other ribbon invariants. We shall finally refer to [Proposition 19.4](#) finding in such a way some  $f : \mathbb{R}^2 \rightarrow \mathbb{R}$  with the desired properties.

Note that  $\gamma_\infty$  is in fact a function from some sheaf  $\mathcal{C}$  into  $\mathbb{N} \cup \{0\}$ . The sheaf  $\mathcal{C}$  has for germs the classes of smooth functions  $f : \mathbb{R}^2 \rightarrow \mathbb{R}$ , where  $f \sim g$  if there is a disk  $D$  such that  $f(x) = g(x)$  for  $x \in \mathbb{R}^2 \setminus D$ . It is now clear, that we have some correctly defined function

$$\gamma_\infty : \mathcal{C} \rightarrow \mathbb{N} \cup \{0\}.$$

From this point of view, it would be of some interest to determine whether  $\gamma_\infty$  interacts in some manner with the algebraic structure on  $\mathcal{C}$ ; anyway, we won't go in this direction here.

There is another situation, when  $\gamma_\infty$  gives some geometrical information. Let  $W \subset \mathbb{R}^2$  be some open set,  $p_0 \in W$  and  $f : W \setminus \{p_0\} \rightarrow \mathbb{R}$  be a smooth function. Suppose that  $f$  is critical points free in some neighbourhood of  $p_0$ . Let  $\lambda_1$  and  $\lambda_2$  be two Jordan curves surrounding  $p_0$  and sufficiently close to it such that  $\lambda_1 \succ \lambda_2$ . Consider the corresponding induced ribbons  $a_{\lambda_1}(f)$ ,  $a_{\lambda_2}(f)$ . Then [Proposition 19.1](#) implies that

$$\gamma(\bar{a}_{\lambda_1}(f)) \geq \gamma(\bar{a}_{\lambda_2}(f)).$$

This is easily seen by inversion of the plane and observing that a ribbon  $a$  passes into  $\bar{a}$  by inversion. Take now a sequence  $\lambda_1 \succ \lambda_2 \succ \dots$  of Jordan curves surrounding  $p_0$  and such that  $\text{diam}(\lambda_i) \rightarrow 0$ . Then the following limit exists:

$$\bar{\gamma}(f, p_0) = \lim_{i \rightarrow \infty} \gamma(\bar{a}_{\lambda_i}(f)).$$

Clearly,  $\bar{\gamma}(f, p_0)$  is an invariant of the “singularity” at  $p_0$  which does not depend on the choice of the sequence  $\lambda_i$ . On the other hand, one may consider the limit

$$\gamma(f, p_0) = \lim_{i \rightarrow \infty} \gamma(a_{\lambda_i}(f)),$$

in case the latter exists, as  $\gamma(a_{\lambda_i}(f))$  is an increasing sequence of integers and may diverge. Note that if  $f$  may be defined in  $p_0$  in such a way, that the extension is smooth, then  $\gamma(f, p_0) \leq 1$ . In case  $\gamma(f, p_0) = \infty$ , one still may examine the divergence rate of the sequence  $\gamma(a_{\lambda_i}(f))$  and this probably carries some geometrical information about the singularity at  $p_0$ .

## 20. LOCAL AND GLOBAL STABILITY OF THE CRITICAL SET

Till now we may claim only the existence of  $\gamma$  different critical points under the corresponding boundary conditions. It is natural to ask whether this group of points is, in some sense, stable and may be controlled under perturbations. There are two types of stability results: a local stability under small perturbations, and a global one - under homotopy.

Our first stability result is a local one. Roughly speaking, it claims that the  $\gamma$  critical points are “distinguishable”, i.e. distant from each other under certain natural conditions. Of course, one may concentrate all the critical points in some small region at the cost of a blow up of the gradient, so we have to control gradient’s norm.

**Theorem 20.1.** *Let  $a \in \mathcal{A}$  be a ribbon. Then for any  $m > 0$  there is  $d > 0$  such that if  $f \in \mathcal{F}(a)$  is an extension of  $a$  with  $\|\nabla f\| < m$ , then there exist  $\gamma = \gamma(a)$  critical points of  $f$ ,  $p_1, \dots, p_\gamma$  such that  $|p_i - p_j| \geq d$  for  $i \neq j$ .*

Probably, the distance  $d$  in the above theorem may be written as a simple expression of the gradient  $\|\nabla f\|$  and then the constant  $m$  is needless. Another local stability result should be a variant of [Theorem 20.1](#), controlling the distance between the critical values of an extension, rather than the distance between the critical points. Then, clearly, one has to consider the invariant  $\beta$  instead of  $\gamma$ . Recall that  $\beta$  is controlling the number of critical values (see [Section 2](#)). So, a literal restatement of the theorem holds true, where “critical points” and “ $\gamma$ ” are replaced by “critical values” and “ $\beta$ ”, correspondingly.

Let us focus now our attention on the global stability properties of the critical set under homotopy. We have the following situation: Given some ribbon  $a \in \mathcal{A}$  and a smooth path (homotopy)  $f_t$  in  $\mathcal{F}(a)$ ,  $t \in [0, 1]$ , then are the components of the critical set  $\text{Crit}(f_t)$  “stable” in some sense? We know that  $\text{Crit}(f_t)$  has at least  $\gamma(a)$  essential components. Of course, we cannot claim that there are  $\gamma(a)$  monotonic in  $t$  branches of the critical set, since various bifurcations can occur. However, it turns out that there are  $\gamma(a)$  components of the set

$$F = \bigcup_t \text{Crit}(f_t) \subset \mathbb{B}^2 \times [0, 1]$$

which are essential, in some sense, and therefore are intersecting both  $\mathbb{B}^2 \times \{0\}$  and  $\mathbb{B}^2 \times \{1\}$ .

**Lemma 20.2.** *Let  $a \in \mathcal{A}$  be a ribbon and  $f_t \in \mathcal{F}(a)$  be a smooth homotopy,  $t \in [0, 1]$ . Let  $K$  be a component of the set  $F = \bigcup_t \text{Crit}(f_t)$ . Then the index of  $K \cap (\mathbb{B}^2 \times \{t\})$  with respect to the field  $\nabla f_t$  is constant (not depending on  $t$ ). So, if this index is nonzero, then  $K$  intersects both  $\mathbb{B}^2 \times \{0\}$  and  $\mathbb{B}^2 \times \{1\}$ .*

A component  $K$  of nonzero index will be called *essential*.

**Theorem 20.3.** *For any ribbon  $a \in \mathcal{A}$  and any smooth homotopy  $f_t \in \mathcal{F}(a)$  there exist  $\gamma(a)$  essential components of the set  $F = \bigcup_t \text{Crit}(f_t)$ .*

Probably, the Hausdorff distance between these components may be estimated from below in terms of the gradient’s norm  $\|\nabla f_t\|$ .

## 21. THE RIBBON SEMIGROUP

In Section 5 we introduced two splittings of ribbons - a binary and a ternary one. Broadly speaking, the first one is performed at a regular value (Fig. 22), while the second one is done at a negative node (Fig. 23). In the present section we shall introduce two operations in the class of ribbons, that are, in some sense, inverse to splittings. This endows the ribbon set  $\mathcal{A}$  with some algebraic structure, that we shall refer to as “the ribbon semigroup”. Of course, like in the definition of fundamental group, where some base point is selected at the beginning, this can be correctly done only after the choice of some particular nodes of each ribbon, which serve as application points.

Let us specify from the beginning that we define these operations in the class  $\mathcal{A}$  of rigid ribbons considered up to translations. Moreover, we shall allow ribbons with coinciding node values, in order to get correctly defined operations in  $\mathcal{A}$ . Note also that a discrete variant of the ribbon semigroup is available, where zig-zag permutations with repetitions are considered.

First, we consider a very natural operation, which *is not* our basic binary operation, but anyway, has some advantages *per se*.

**Connected sum of ribbons.**

This is a simple operation, which may be useful for constructing examples, though it does not define some very interesting algebraic structure in  $\mathcal{A}$ .

The connected sum operation is defined for ribbons with positive minimal and maximal nodes. As we explained at the beginning, this is not a constraint from point of view of  $\gamma$ .

**Definition 21.1.** *Let  $a, b \in \mathcal{A}$  be ribbons with positive minimal and maximal nodes. Then their connected sum is the ribbon  $a\#b$  obtained by applying the maximal node of  $a$  to the minimal one of  $b$  (Fig. 46).*

Clearly, this is an associative, but non commutative operation, which is defining some semigroup  $A_{\#}$ . Note that there is no a natural unit in  $A_{\#}$ , although any ribbon  $a$  equivalent to  $\alpha_0 = (1^+, 2^+)$  may be thought of as a “unit”, since  $a\#b \sim b\#a \sim b$  for any  $b \in A_{\#}$ . Furthermore, we may add to  $A_{\#}$  the elementary ribbons  $\alpha_1 = (1^+, 2^-)$  and  $\alpha_2 = (1^-, 2^+)$  with the convention that  $\alpha_1$  may be subject only to left multiplication, whereas  $\alpha_2$  - to right multiplication. Then we obtain an extended version of  $A_{\#}$  which contains all the possible ribbons.

**Remark.** *In fact, we get some operation in the class of discrete (soft) ribbons, defining in such a way some countable semigroup  $B_{\#}$ . This is due to the obvious fact that*

$$\text{if } a_1 \sim a \text{ and } b_1 \sim b, \text{ then } a_1\#b_1 \sim a\#b.$$

Note that  $B_{\#}$  is a *monoid* (semigroup with unity), where the unit is the class of any ribbon equivalent to  $a_0 = (1^+, 2^+)$ . Of course, there is a natural morphism  $A_{\#} \rightarrow B_{\#}$ .

**Example 21.2.** *If  $a \in \mathcal{A}_n$  is a ladder, then*

$$a = a_1\#a_2\#\dots\#a_{n/2-1},$$

*where  $a_i \in \mathcal{A}_4$ . Conversely, if  $a \in \mathcal{A}_n$  may be written as a connected sum of  $\frac{n}{2} - 1$  ribbons with 4 nodes, then  $a$  is a ladder.*

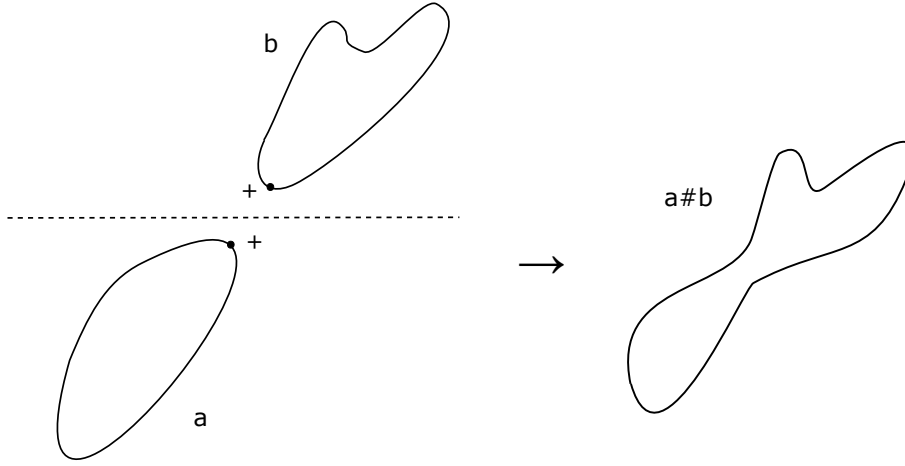

FIGURE 46. Connected sum of ribbons.

Except the fact that the connected sum is defined for discrete ribbons, it has the advantage that the ribbon invariants  $\gamma_*$  are additive under taking connected sum.

**Proposition 21.3.** *For any two  $a, b \in A_\#$ , we have*

$$\gamma_*(a\#b) = \gamma_*(a) + \gamma_*(b),$$

where  $\gamma_*$  is any of the ribbon invariants  $\gamma$ ,  $\gamma_0$ ,  $\gamma_{\text{ext}}$ ,  $\gamma_{\text{sad}}$ .

*Proof.* This is straightforward, since by definition the ribbon  $a\#b = (\varphi, \nu)$  has a “thin” level  $c_0$  such that  $|\varphi^{-1}(c_0)| = 2$  and  $c_0$  is separating  $a$  from  $b$ . Then any extension  $f \in \mathcal{F}(a\#b)$  surely has a level line connecting both points of  $\varphi^{-1}(c_0)$ . Note also that we have additivity in the extended version of  $A_\#$  too.  $\square$

Of course, the degree is also additive under connected sums:  $i(a\#b) = i(a) + i(b)$ .

The bad news about  $\#$  is that almost any element  $a$  of  $A_\#$  is *prime*, i.e. if  $a = b\#c$ , then either  $a \sim b$ , or  $a \sim c$ , as there might not exist a “thin” essential level in  $a$ , and this is the typical situation. In such a way, there is no any simple base in  $A_\#$  consisting of prime elements, unlike the case with the main binary and ternary operations in  $\mathcal{A}$  defined below.

### The main operations.

As usual, in order to define correctly an operation in the class of objects under consideration, one has to select some distinguished application point(s) either in any object, or in the ambient space. Let  $A$  denote the class of rigid ribbons  $a$  with two positive nodes selected, say  $p_1(a)$  and  $p_2(a)$ , such that  $p_1(a)$  is of minimal, and  $p_2(a)$  is of maximal type. We shall say that  $a$  is a *marked* ribbon and  $p_1(a)$  is the *origin*, while  $p_2(a)$  is the *end* of  $a$ . Clearly, there is a *forgetful* map

$$q : A \rightarrow \mathcal{A},$$

whose image  $q(A)$  consists of the ribbons with at least two positive nodes of opposite type.

Now we may define the superposition of marked ribbons:



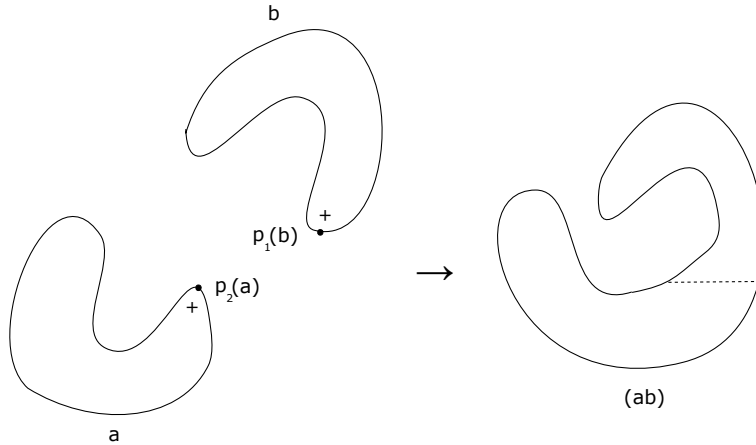

FIGURE 47. The main binary operation  $c = ab$ .

**Definition 21.4.** Let  $a, b \in A$ , then  $c = ab$  is the ribbon obtained by applying  $p_2(a)$  to  $p_1(b)$ . For the new ribbon  $c$  we set  $p_1(c) = p_1(a)$ ,  $p_2(c) = p_2(b)$  (Fig. 47). In some sense, this operation is inverse to a binary splitting.

It is clear that we get some associative binary operation in  $A$ :  $(ab)c = a(bc)$ , which is, of course, non commutative. Moreover, we don't have a natural unit in  $A$ , since the only candidate would be a ribbon  $a$  equivalent to  $\alpha_0 = (1^+, 2^+)$ , but such a ribbon produces different result when applied to an arbitrary other ribbon, depending on the difference between the minimal and the maximal value of  $a$ . So,  $A$  is not a *natural* monoid. Of course, "small" ribbons equivalent to  $\alpha_0 = (1^+, 2^+)$  may be thought of as "local" units with respect to some fixed ribbon. Their application does not change any of the ribbon invariants, as the result is equivalent to the original ribbon.

Let us emphasize the difference between the connected sum  $a\#b$  and the operation  $ab$ , the latter being defined in a larger class of marked ribbons.

Now we define the ternary operation in  $A$ , which is necessary for full characterization of the ribbon invariant  $\gamma$ .

**Definition 21.5.** Let  $a, b, c \in A$ , then  $x = [abc]$  is the ribbon obtained by the triple application of  $p_2(a)$ ,  $p_2(b)$  and  $p_1(c)$  at one and the same level  $l_0$  (Fig. 48). Then a newborn negative node appears at level  $l_0$  and we set  $p_1(x) = p_1(a)$  and  $p_2(x) = p_2(c)$ .

Furthermore, by  $y = x'$  we denote the image of  $x$  via the *inversion* from Fig. 49. We set  $p_1(x') = p_2(x)$  and  $p_2(x') = p_1(x)$ . This involution is necessary in order to obtain all kind of ribbons from the elementary ones, since only the binary and ternary operations are not enough. The reason is that the ternary operation  $[abc]$ , as defined, gives birth to a negative node which is a local maximum, but, of course, there are ribbons with negative nodes at a local minimum. For example, the ribbon  $x'$  from Fig. 49 cannot be obtained without inversion from the elementary ribbons. Clearly, inversion does not affect any of the ribbon invariants.

FIGURE 48. The ternary operation  $[abc]$ .

FIGURE 49. The inversion.

It turns out that there are several natural relations involving binary and ternary operations.

**Proposition 21.6.** *The following relations hold true in  $A$ :*

- 1)  $(ab)c = a(bc)$ ,  $(ab)' = b'a'$
- 2)  $[[abc]de] = [ab[cde]]$
- 3)  $[abc]d = [ab(cd)]$ ,  $a[bcd] = [(ab)cd]$
- 4)  $\sigma(ab) = \sigma(a) + \sigma(b) - 2$
- 5)  $\sigma([abc]) = \sigma(a) + \sigma(b) + \sigma(c) - 4$ .

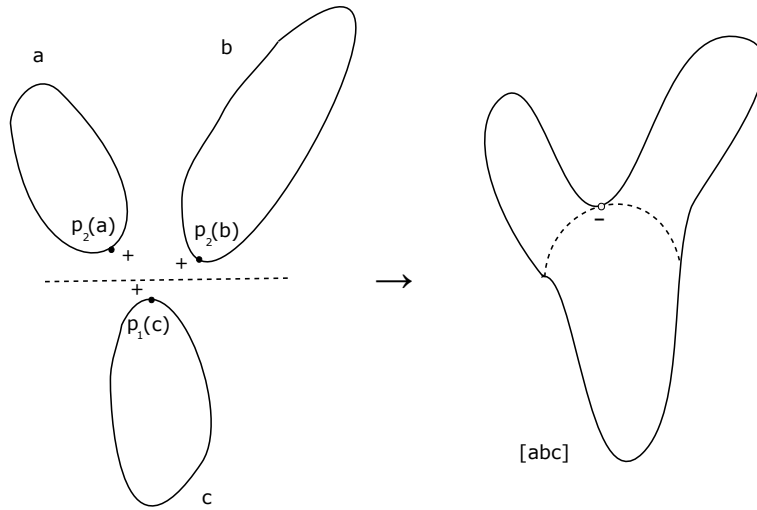
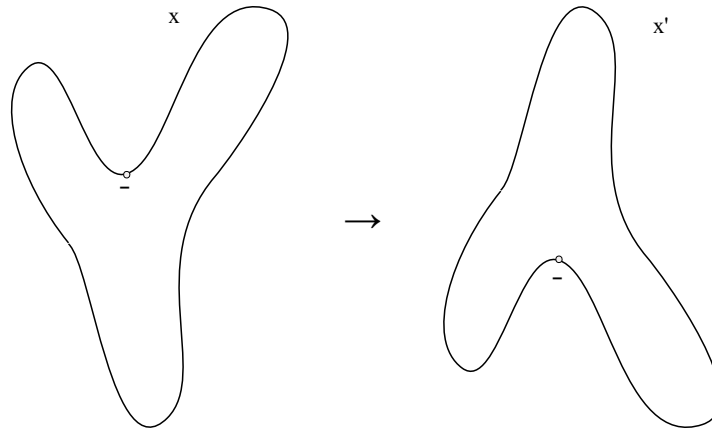
Here  $\sigma(a)$  is the signature of ribbon  $a$ . Then 4) and 5) easily imply that the index  $i = 1 - \frac{\sigma}{2}$  is additive under both operations in  $A$ :

$$i(ab) = i(a) + i(b), \quad i([abc]) = i(a) + i(b) + i(c).$$

Conversely to the above equalities, the ribbon invariant  $\gamma$  turns out to be subadditive function in  $A$ . Of course, this holds true for all the other ribbon invariants  $\gamma_*$ :

**Theorem 21.7.** *The invariants  $\gamma_*$  are subadditive in  $A$ :*

$$\gamma_*(ab) \leq \gamma_*(a) + \gamma_*(b), \quad \gamma_*([abc]) \leq \gamma_*(a) + \gamma_*(b) + \gamma_*(c).$$

This was proved in fact in [Section 5](#), where these inequalities were established for binary and ternary splittings. Note also that the above inequalities are basic in the general algebraic definition of a *ribbon invariant* and this will be subject of the next section.

**Lemma 21.8.** *Every  $a \in A$  may be represented as a composition of irreducible elements of  $A$  via the binary and ternary operations and inversion.*

The proof is by splittings and induction on the number of nodes. Of course, the above representation is not unique at all, as simple examples show.

We shall say that an element  $a \in A$  is *essential*, if it is not equivalent to  $(1^+, 2^+)$ . Clearly, for any essential *irreducible* ribbon  $x \in A$  we have  $\gamma(x) = 1$ , otherwise  $\gamma(x) = 0$ .

**Definition 21.9.** *Let  $a \in A$  be a ribbon. Then its representations are all possible expressions of  $a$  as a superposition of irreducible ribbons via the binary and ternary operations  $(ab, [abc])$  and inversion  $(a')$ . (E.g.  $a = [[xyz]'uv]$ ). A representation of  $a$  will be denoted by  $r(a)$  and their collection by  $R(a)$ . The weight of a representation  $r(a)$  is the number of its essential elements and is denoted by  $w(r(a))$ .*

**Lemma 21.10.** *Any ribbon  $a \in A$  has a representation.*

Now we give an algebraic description of  $\gamma$  in terms of the semigroup  $A$ .

**Theorem 21.11.** *Let  $a \in A$ . Then the ribbon invariant  $\gamma(a)$  equals the minimal weight  $w(r(a))$ , when  $r \in R(a)$  runs over all representations of ribbon  $a$ :*

$$\gamma(a) = \min_{r \in R(a)} w(r(a)).$$

Furthermore, let us call a representation of a ribbon *a simple*, if it is a superposition *only* of binary operations. Clearly, any positive ribbon  $a \in A^+$  has a simple representation by positive alternations (ternary operations give birth to a negative node), so  $A^+$  is an ordinary semigroup. In such a way, the problem of calculating  $\gamma$  in  $A^+$  is settled, from algebraic point of view, in a much more simple situation.

Consider, on the other hand the class  $\Gamma_0$  of ribbons with  $\gamma = 0$ . Then it may be algebraically characterized as follows:

**Proposition 21.12.** *The class  $\Gamma_0$  is generated by the ribbons equivalent to the minimal one,  $\alpha_0 = (1^+, 2^+)$ , subject only to ternary multiplication and inversion.*

In such a way, the class  $\Gamma_0$  of ribbons with  $\gamma = 0$  may be inductively constructed *bottom-up* and may probably be geometrically well described by *marked trees* (in the sense that each vertex is assigned its *level*).

Let us see now what happens with the other *geometric* ribbon invariants  $\gamma_* = \gamma_0, \gamma_{\text{ext}}, \gamma_{\text{sad}}$ . It is not difficult to see that in these cases it is convenient to define the weight  $w_*$  of a representation  $r(a)$  as the sum of the ribbon invariants  $\gamma_*$  of its

	$\alpha_0$	$\alpha_1$	$\alpha_2$	$\beta_n$
$w$	0	1	1	1
$w_0$	0	1	1	$n/2 - 1$
$w_{\text{ext}}$	0	1	1	0
$w_{\text{sad}}$	0	0	0	1

TABLE 1. Weights of the ribbon invariants.

elements (the latter being obvious), and then the following natural improvement of [Theorem 21.11](#) holds:

**Theorem 21.13.** *Let  $a \in A$  be a ribbon. Then*

$$\gamma_*(a) = \min_{r \in R(a)} w_*(r(a)),$$

where  $\gamma_* = \gamma, \gamma_0, \gamma_{\text{ext}}, \gamma_{\text{sad}}$ .

Recall the weight systems  $w_*$  for the elementary ribbons  $\alpha_0 = (1^+, 2^+)$ ,  $\alpha_1 = (1^+, 2^-)$ ,  $\alpha_2 = (1^-, 2^+)$ ,  $\beta_n \in \mathcal{A}_n^+$  - the positive alternations. These are depicted at [Table 1](#).

Here by  $\beta_n$  we mean *any* positive alternation with  $n$  nodes.

If  $A^*$  denotes the set of all types of ribbons, yet in this case any  $a \in A^*$  has a representation  $r(a)$ , which is a composition of elementary ribbons. For example,  $(1^-, 2^-) = (1^-, 2^+)(1^+, 2^-)$ . Then [Theorem 21.13](#) still holds true (though  $A^*$  has no longer completely defined internal algebraic operations).

The following observation is about the fact that any representation  $r(a)$  of a given ribbon  $a \in A^*$  corresponds to an economic extension  $f \in \mathcal{F}^e(a)$  of  $a$ , and vice versa.

**Theorem 21.14.** *For any ribbon  $a \in A^*$  the set of economic extensions  $\mathcal{F}^e(a)$  is in one-to-one correspondence with the set of algebraic representations  $R(a)$  of ribbon  $a$ .*

The proof is geometrically self-evident, as any procedure of splitting of an economic extension  $f \in \mathcal{F}^e(a)$  into elementary regions corresponds to a procedure of constructing some representation  $r \in R(a)$  of ribbon  $a$ .

Consider now the set

$$\mathcal{F}^* = \cup \{f \in \mathcal{F}^e(a) \mid a \in A^*\}$$

of all economic extensions. It is easy to see that both algebraic operations (and inversion) may be correctly defined in  $\mathcal{F}^*$ . We shall preserve the same notation about these:  $fg, [fgh], f'$ . Let  $f \in \mathcal{F}^e(a)$ , then we shall write  $a_f = a$ . In such a way,  $f \rightarrow a_f$  is a *forgetful* functor. Clearly, one has

$$a_{fg} = a_f a_g, a_{[fgh]} = [a_f a_g a_h], a_{f'} = (a_f)'$$

so, if we define  $j(f) = a_f$ , then we get a natural *forgetful* morphism  $j : \mathcal{F}^* \rightarrow A^*$ . In the functors-morphisms terminology, the functor defined by  $j$  is *fully faithful*. Obviously,  $j^{-1}(a)$  is the set of all economic extensions of  $a$ .

**Remark. 1)** In order to finitize the situation, it is convenient to consider “truncated” versions of the above semigroups. For a given  $n$ , denote by  $A_{(n)}^*$  the elements of  $A^*$  with  $\leq n$  nodes. We furthermore add to  $A_{(n)}^*$  an “artificial” unit  $\{1\}$ , making in such a way  $A_{(n)}^*$  a “monoid”. Now we define  $ab = \{1\}$  and  $[abc] = \{1\}$ , in case the number of nodes of  $ab$ , respectively  $[abc]$  exceeds  $n$ . Then working in the class of discrete ribbons (with coinciding levels allowed), we get some finite algebraic object  $A_{(n)}^*$ , which is a monoid with respect to binary multiplication, though having in addition ternary multiplication and inversion. The same way is defined  $\mathcal{F}_{(n)}^*$ . Clearly,  $A^*$  and  $\mathcal{F}^*$  are direct limits of systems  $A_{(n)}^*$  and  $\mathcal{F}_{(n)}^*$ , respectively. This truncation will be exploited in the next section for finitization of algebraic ribbon invariants.

2) In the class of positive ribbons the ternary operation is missing (neither need we involution), so we get some finite semigroup  $A_{(n)}^+$ , and the situation is pretty simplified.

## 22. PARTIAL ORDERING OF THE RIBBON SPACE

The above results raise the natural question whether we may define some equivalence relation in class  $\mathcal{A}$  of ribbons following the common general idea:

*Two ribbons  $a$  and  $b$  are equivalent, if there is a noncritical membrane  $C$  which “connects” them.*

So, in some sense, there is a critical points free function  $F : C \rightarrow \mathbb{R}$  and  $\partial C = a \cup b$ . Unfortunately, it turns out that all our efforts to define correctly such an equivalence relation are failing. One reason is that, in order to provide transitivity, the membrane  $C$  has to connect  $a$  with the complementary ribbon  $\bar{b}$ , but then we are loosing symmetry. Another reason is that we can hardly expect that a ribbon can be connected to itself by a noncritical membrane, so we don’t have reflexivity. This idea leads only to some partial ordering of  $\mathcal{A}$ , which anyway gives useful information about the structure of the ribbon space and agrees with the ribbon invariants theory. Furthermore, we define the same way a partial order in the class of gradient (nonzero) vector fields on  $\mathbb{S}^1$ . Both partial orderings turn out to be continuous in the corresponding natural topology. Here we face up with the problem of determining when  $a \prec b$ , and it turns out again that this problem may be solved only algorithmically (at least by the author).

Note also that this ordering “ $\prec$ ” should not be confused with the lexicographic ordering of the ribbon space defined at the beginning of the article in [Section 4](#).

Let us make the agreement that in this section all ribbons are *rigid* in the strongest possible sense, and these cannot be subject to translation and rotation without obtaining a different ribbon. Later we shall discuss the possibility to define such an ordering in the class of discrete ribbons.

**Definition 22.1.** *Let  $C = \mathbb{S}^1 \times [1, 2]$  be an annulus and  $F : C \rightarrow \mathbb{R}$  be a smooth critical points free function. If  $\partial C = C_1 \cup C_2$ , where  $C_1 = \mathbb{S}^1 \times \{1\}$  and  $C_2 = \mathbb{S}^1 \times \{2\}$ , consider the boundary ribbons  $a_1$  and  $a_2$  defined by the restrictions  $F|_{C_1}$  and  $F|_{C_2}$ , respectively. Then we shall write  $a_1 \prec a_2$ . Clearly, we define in such a way some relation in the ribbon space  $\mathcal{A}$ , which turns out to be a partial ordering.*

Here we allow ribbons to have any Jordan curve for a domain, and won’t restrict ourselves to the case of the unit circle  $\mathbb{S}^1$ . Note also that the membrane  $C$  is “connecting”  $a_2$  with the complementary ribbon  $\bar{a}_1$ , rather than  $a_2$  with  $a_1$ .

**Lemma 22.2.** *The relation “ $\prec$ ” is an anti-reflexive partial ordering of  $\mathcal{A}$ , which is continuous with respect to the natural ( $C^1$ ) topology in the ribbon space.*

*Proof.* The transitivity is straightforward, the anti-reflexivity,  $a \not\prec a$ , is obtained as follows. Suppose that  $a \prec a$  for some ribbon  $a$ , so, it can be connected to its inverse by some membrane  $F : C \rightarrow \mathbb{R}$ . But then, if  $p$  is the maximal node of  $a$  and supposing it being positive (for example), then  $p$  is a maximal node of  $\bar{a}$  which is negative and then it is obvious that function  $F$  defining the membrane should have an absolute maximum in  $C \setminus \partial C$ , which contradicts the condition that  $F$  is critical points free. Continuity means that if  $a_i \rightarrow a$ ,  $b_i \rightarrow b$  in  $\mathcal{A}$  and  $a_i \prec b_i$ , then  $a \prec b$ , but this is not that difficult to be done as well.  $\square$

The following simple fact will be proved later, during the description of the algorithm for recognizing when  $a \prec b$ .

**Fact 22.3.** *If  $a \prec b$ , then  $\sigma(a) = \sigma(b)$ .*

In such a way, two elements  $a, b \in \mathcal{A}$  are comparable via the relation “ $\prec$ ”, only if these lay in one and the same component of  $\mathcal{A}$ . Of course, the converse is not true, i.e. the components of  $\mathcal{A}$  are not *totally* ordered by “ $\prec$ ”.

It is not difficult to see that the ribbon invariant  $\gamma$  is an anti-monotone function on  $\mathcal{A}$  with respect to the partial ordering.

**Proposition 22.4.** *If  $a_1, a_2 \in \mathcal{A}$  and  $a_1 \prec a_2$ , then  $\gamma(a_1) \geq \gamma(a_2)$ .*

*Proof.* Let  $f \in \mathcal{F}(a_1)$  be an extension of ribbon  $a_1$  with  $k = \gamma(a_1)$  critical points. Since  $a_1 \prec a_2$ , there is a noncritical membrane  $F : C \rightarrow \mathbb{R}$  connecting  $a_2$  with  $\bar{a}_1$ . But then it is clear that  $f$  and  $F$  may be arranged so that we get an extension  $f' \in \mathcal{F}(a_2)$  of  $a_2$  with  $k$  critical points, thus  $\gamma(a_1) \geq \gamma(a_2)$ . Easy examples show that strict inequality is possible.  $\square$

Of course, the above proposition holds true for the other ribbon invariants  $\gamma_0$ ,  $\gamma_{\text{ext}}$ ,  $\gamma_{\text{sad}}$ : If  $a_1 \prec a_2$ , then  $\gamma_*(a_1) \geq \gamma_*(a_2)$ .

Note that in fact the function  $F : C \rightarrow \mathbb{R}$  defines some *generalized* ribbon in a small neighbourhood of  $\partial C = C_1 \cup C_2$ , which has ribbon invariant 0. We allow here coinciding critical values of  $a_1, a_2$ . As we pointed out at the beginning, all the definitions and invariants remain correctly defined and relevant in this *non general position* situation.

Now, one may consider the general situation as follows.

**Definition 22.5.** *In the settings of Definition 22.1 we shall write*

$$d(a_1, a_2) = k,$$

*if  $k$  is the minimal cardinality of critical points of a membrane  $F : C \rightarrow \mathbb{R}$  connecting  $a_2$  with  $\bar{a}_1$ .*

Clearly,  $d(a_1, a_2) = 0$  if and only if  $a_1 \prec a_2$ . It turns that  $d$  is a kind of a “distance” function. In fact, the triangle inequality

$$d(a, b) \leq d(a, c) + d(c, b)$$

follows immediately from the definition. On the other hand, simple examples show that it is not symmetric, neither is it reflexive. Moreover, every ribbon is “distanced” from itself.

**Proposition 22.6.** *For any ribbon  $a \in \mathcal{A}$ , the next inequality holds*

$$d(a, a) \geq 3.$$

*Proof.* Suppose that the membrane  $F : C \rightarrow \mathbb{R}$  is connecting  $a$  with  $\bar{a}$ . Then it is easy to see that  $F$  may be considered in fact as a function on the torus  $\mathbb{T}^2$ . Now, it is a common fact that each such function has at least 3 critical points, as the Lusternik-Schnirelmann category of the  $\mathbb{T}^2$  equals 3 (see [5]).  $\square$

Now we shall see what can be done about the problem of recognition of the relation  $a_1 \prec a_2$ . As we pointed at the beginning, only an algorithmic approach seems to be relevant here. This problem is closely related to the problem of recognition of  $\gamma(a) = 0$  (Section 13), which is also only algorithmically solved therein. In fact, we shall present two different algorithms for solving the problem whose complexity is close to that for  $\gamma = 0$ .

**Proposition 22.7.** *Let  $a_1, a_2 \in \mathcal{A}$ ,  $a_1 \prec a_2$  and  $F : C \rightarrow \mathbb{R}$  be the corresponding membrane. Then there is  $c \in \mathbb{R}$  such that  $F^{-1}(c)$  is a regular Jordan curve separating  $C_1 = \mathbb{S}^1 \times \{1\}$  from  $C_2 = \mathbb{S}^1 \times \{2\}$ , if and only if  $F(C_1) \cap F(C_2) = \emptyset$ . Then  $\sigma(a_1) = \sigma(a_2) = 0$  and moreover, if  $F(C_1) \cap F(C_2) = \emptyset$  and, say  $F(C_1)$  is situated “under”  $F(C_2)$ , then the maximal node of  $a_1$  is positive and the minimal node of  $a_2$  is negative.*

In Section 13 we defined *cancellation* of a pair of nodes and this concept was crucial for the algorithm for recognizing  $\gamma = 0$ . According to the order and type of the canceled pair, we shall call this cancellation of  $(-, +)$  type. Now, changing the types of the nodes to the opposite ones, we define cancellations of  $(+, -)$  type. (Note that there may be situations, when two consecutive nodes of opposite type cannot be canceled by any type cancellation.) Both types are needed for one of the algorithms discussed later.

First we deal with some particular case of disposition of ribbons  $a_1 = (\varphi_1, \nu_1)$  and  $a_2 = (\varphi_2, \nu_2)$ .

**Case 1.**  $\varphi_1(C_1) \cap \varphi_2(C_2) = \emptyset$ . Then the following lemma solves the problem.

**Lemma 22.8.** *Let case 1 be present for  $a_1, a_2 \in \mathcal{A}$  and suppose, without loss of generality, that  $\varphi_1(C_1)$  is situated “under”  $\varphi_2(C_2)$ . Consider the ribbon  $b_1$  which is obtained from  $\bar{a}_1$  by “making” its maximal node positive (the latter being negative), and ribbon  $b_2$  which is obtained from  $a_2$  by “making” its maximal node positive as well. Then  $a_1 \prec a_2$  if and only if  $\gamma(b_1) = \gamma(b_2) = 0$ .*

**Case 2.**  $\varphi_1(C_1) \cap \varphi_2(C_2) \neq \emptyset$ .

**Method 1.** Consider all (combinatorially different) pairs  $x \in C_1, y \in C_2$  such that  $\varphi_1(x) = \varphi_2(y)$ . Then perform a “cut” of the annulus  $C$  along the pair  $x, y$  obtaining in such a way some ribbon  $a \in \mathcal{A}$ , for which the two new-born nodes are marked as positive.

**Lemma 22.9.** *In case 2, we have  $a_1 \prec a_2$  if and only if there is a cut as above such that  $\gamma(a) = 0$  for the corresponding ribbon.*

Note that ribbon  $a$  is not a general position ribbon, yet the ribbon invariant  $\gamma$  being defined for such ribbons and the algorithm from Section 13 for detecting  $\gamma = 0$  works as well.

**Method 2.** This algorithm relies on appropriate cancellations of ribbons  $a_1, a_2$  and reducing them finally to ribbons  $b_1, b_2$  which are bounding an *elementary band*.

**Definition 22.10.** *The ribbons  $b_1, b_2$  with the same number of nodes are bounding an elementary band, if there is an order preserving bijection between their nodes  $j : P_1 \rightarrow P_2$  such that*

- 1)  $p$  and  $j(p)$  have the same marking
- 2)  $\varphi_1''(p)(\varphi_2(j(p)) - \varphi_1(p)) < 0$  for any node  $p$  of  $b_1$ .

It is easy to see that if  $b_1$  and  $b_2$  are bounding an elementary band, then there is a noncritical membrane  $C$  between them. Roughly speaking, elementary bands are sufficiently thin noncritical membranes.

**Lemma 22.11.** *In the presence of case 2, we have  $a_1 \prec a_2$  if and only if there is a cancellation of  $a_1$  of type  $(+, -)$  and a cancellation of  $a_2$  of type  $(-, +)$  which reduce them to ribbons  $b_1$  and  $b_2$ , respectively, which are bounding an elementary band.*

Clearly, the number of cancellations of  $a_1$  and  $a_2$  may differ.

Note finally that in both cases it is not difficult to present more detailed algorithms for establishing the relation  $a_1 \prec a_2$  between two given ribbons. However these algorithms cannot be faster than the algorithm for detecting  $\gamma = 0$ , the latter being ramifying by nature and thus slow for large number of nodes.

In our concluding remarks in this section, we shall comment some partial ordering of *gradient* vector fields on the circle. First of all, by a *gradient field on  $\mathbb{S}^1$*  we mean a (smooth) nonzero function  $v : \mathbb{S}^1 \rightarrow \mathbb{R}^2$  such that

$$\int_{\mathbb{S}^1} \langle v, \tau \rangle ds = 0,$$

where  $\tau$  is the unit tangent vector field on  $\mathbb{S}^1$ . Of course, this is not the usual definition of “gradient field”, which has to be tangent to the underlying manifold. It is not difficult to see that for a gradient vector field  $v$  on  $\mathbb{S}^1$  there is a critical points free function  $F$  defined in a small neighbourhood  $U$  of  $\mathbb{S}^1$  such that

$$\nabla F|_{\mathbb{S}^1} = v.$$

Of course, the restriction  $\varphi = F|_{\mathbb{S}^1}$  is defined by  $v$  up to translation. Moreover, some ribbon  $a_v = (\varphi, \nu)$  is defined up to translation  $(\varphi, \nu) \rightarrow (\varphi + C, \nu)$ .

**Definition 22.12.** *If  $v_1$  and  $v_2$  are gradient fields on  $\mathbb{S}^1$  and  $a_{v_1} = (\varphi_1, \nu_1)$ ,  $a_{v_2} = (\varphi_2, \nu_2)$  are the corresponding ribbons, we shall write*

$$v_1 \prec v_2,$$

*if there is a constant  $C$  such that  $(\varphi_1 + C, \nu_1) \prec (\varphi_2, \nu_2)$ .*

It is easy to see that this is a partial ordering in the class of gradient fields. On the other hand, examples show that the relation  $v \prec v$  is possible, unlike in the case of rigid ribbons (it suffices to consider the linear field).

### 23. ALGEBRAIC RIBBON INVARIANTS

In the present section we consider the ribbon invariants from purely algebraic point of view. There is a natural definition of a ribbon invariant as a subadditive function on the ribbon space, with some initial values on the elementary ribbons



defined. We shall see that the class of algebraic invariants is quite large. Then, considering a natural partial ordering of ribbon invariants, we establish the following fact:

*$\gamma$  is the (unique) maximum in the ordered set of ribbon invariants.*

The same is equally true for the other 3 invariants  $\gamma_0$ ,  $\gamma_{\text{ext}}$ ,  $\gamma_{\text{sad}}$  in the space of invariants with the corresponding normalization on elementary ribbons.

**Definition 23.1.** *We say that the function  $\eta : A \rightarrow \mathbb{N} \cup \{0\}$  is an algebraic  $\gamma_*$ -ribbon invariant, if*

- 1)  $\eta(ab) \leq \eta(a) + \eta(b)$
- 2)  $\eta([abc]) \leq \eta(a) + \eta(b) + \eta(c)$
- 3)  $\eta(a') = \eta(a)$
- 4)  $\eta(x) = \gamma_*(x)$  for any elementary ribbon  $x$
- 5)  $\eta(a\#b) = \eta(a) + \eta(b)$
- 6) if  $q(a) = q(b)$ , then  $\eta(a) = \eta(b)$  ( $q : A \rightarrow \mathcal{A}$  is the forgetful map).

Note that 6) implies that  $\eta$  may be considered as an invariant on the set  $q(A) \subset \mathcal{A}$ , which is “almost” the whole  $\mathcal{A}$ . Also, the additivity of  $\eta$  under connected sums (property 5)) is somewhat consistent from geometric point of view; it is available for all the  $\gamma_*$ -invariants and their derivatives described below.

Of course,  $\gamma_*$  is an algebraic  $\gamma_*$ -ribbon invariant itself, but we shall show later that this class is quite larger.

Recall that the values of the 4 ribbon invariants  $\gamma_*$  on elementary ribbons are given at [Table 1](#). Of course, one may consider algebraic ribbon invariants with different normalization on elementary ribbons, by excluding 4) from the definition. Clearly,  $\eta \equiv 0$  is a ribbon invariant in this sense.

We shall focus our attention mainly on the principal case  $\gamma_* = \gamma$  with the usual normalization:  $\gamma(\alpha_0) = 0$ ,  $\gamma(\alpha_1) = \gamma(\alpha_2) = 1$ ,  $\gamma(\beta_n) = 1$ .

**Examples.** Here we give some examples of algebraic ribbon invariants.

**0.** It is clear that  $\gamma_{\text{ext}} + \gamma_{\text{sad}}$  is a  $\gamma$ -ribbon invariant, which is different from  $\gamma$  itself, since we showed in [Section 9](#) that  $\gamma \geq \gamma_{\text{ext}} + \gamma_{\text{sad}}$  and there are examples of strict inequality.

Another example of a  $\gamma$ -ribbon invariant is  $\beta$  - the minimal number of critical values of an extension of the ribbon ([Section 2](#)). Surely,  $\beta \neq \gamma$ , since for example  $\beta \ll \gamma$  in  $\mathcal{A}^+$ . Note also that the cluster number  $\delta$  is a  $\gamma_{\text{sad}}$ -ribbon invariant, since it has the same normalization as  $\gamma_{\text{sad}}$  on elementary ribbons.

**1. Truncation of an invariant  $\eta$ .**

Let  $\eta$  be a ribbon invariant and  $m$  be a natural number, then define

$$\eta_m(a) = \begin{cases} \eta(a) & \text{if } a \in \mathcal{A}_m \\ 0 & \text{otherwise} \end{cases}$$

Recall that  $\mathcal{A}_m$  is the space of ribbons with  $\leq m$  nodes. Then it is easily seen that  $\eta_m$  is a ribbon invariant defined on  $\mathcal{A}_m$ . Furthermore, as we shall see later, it is not difficult to see that the number of such invariants is finite, so various questions of combinatorial character may be raised here, for example:

*What is the number of  $\gamma_m$  - invariants?*

The same may be asked about the other  $(\gamma_*)_m$  - invariants.

Note that setting in addition  $\eta_m(a) = \gamma_*(a)$  for elementary ribbons, we get some  $\gamma_*$ -invariant of *finite type*, i.e. it equals 0 on each *non elementary* ribbon with sufficiently many nodes.

**2. Divisor invariants.**

Let  $a \in \mathcal{A}$  be a ribbon. We shall say that the ribbon  $b$  is a *divisor* of  $a$ , if there is a (nontrivial) representation of  $a$ , where  $b$  takes part. Clearly, this defines yet another partial ordering of the ribbon space. Let  $D(a)$  denote the set of all divisors of  $a$ . Now we may consider the following *divisor invariant*  $d_a$  associated to  $a$ :

$$d_a(x) = \begin{cases} 1 & \text{if } x \in D(a) \\ 0 & \text{otherwise} \end{cases}$$

It is easily seen that  $d_a$  is a ribbon invariant. Furthermore, we may modify it in a way, that it takes the usual  $\gamma$ -normalization values on the elementary ribbons, obtaining in such a way some  $\gamma$ -invariant  $\overline{d}_a$  of finite type. Note also that this construction may be generalized in the following way.

Take some set  $M \subset \mathcal{A}$  and denote by  $D(M)$  the set of all divisors of elements of  $M$ . Then we may define the ribbon invariants  $d_M$  and  $\overline{d}_M$  as above (simply replacing  $a$  by  $M$ ).

**3. Arithmetically generated invariants.**

Let  $\eta$  be some  $\gamma$ -ribbon invariant and  $k$  be a natural number, then define

$$\eta^{(k)} = \left[ \frac{\eta + k}{k + 1} \right].$$

It is easy to see that  $\eta^{(k)}$  is also a  $\gamma$ -ribbon invariant. In general, it differs from  $\eta$ , since asymptotically  $\eta^{(k)} \sim \eta/(k + 1)$ . Note also that  $\eta^{(k)}$  is not of *finite type*, if  $\eta$  is not so.

Now, repeating inductively this procedure, for any finite sequence of integers  $k_1, \dots, k_m$  we get some invariant  $\eta^{(k_1 \dots k_m)}$ . It is clear that

$$\eta^{(k_1 \dots k_m)} \xrightarrow{m \rightarrow \infty} 0,$$

in the sense that for a given ribbon  $a$  we have  $\eta^{(k_1 \dots k_m)}(a) = 0$  for sufficiently large  $m$ .

**Partial ordering of ribbon invariants.** Let us denote by  $RI$  the set of ribbon invariants. There is a natural partial order in  $RI$ :

$$\eta \leq \eta', \text{ if } \eta(a) \leq \eta'(a) \text{ for any } a \in \mathcal{A}.$$

Then various questions about the structure of the *poset*  $RI$  may be asked. (Recall that “poset” = partially ordered set.)

First of all, it turns out that  $RI$  is a *complete semi-lattice* in the sense that every non empty subset has a supremum (in particular,  $RI$  has a global maximum). It becomes evident from the following fact:

If  $A \subset RI$ , then  $\eta_{\max}(a) = \max \{ \eta(a) \mid \eta \in A \}$  is the supremum of family  $A$ .

The above maximum exists by the inequality  $\eta(a) \leq \frac{n}{2} + 1$ , which is proved later (here  $n$  is the number of nodes of  $a$ ). Note that the minimum of a set of invariants *may not be* a ribbon invariant itself, as simple examples show. In other words,  $RI$  is *not a lattice* with respect to the usual order.

Recall that the *width* of a poset is the maximal cardinality of its *antichains*, the subsets of mutually incomparable elements.

**Proposition 23.2.** *The width of  $RI$  is infinite.*

*Proof.* It is clear that one can find an infinite system of mutually incomparable ribbons  $\{a_i\}$ , i.e. such that  $a_i$  is not a divisor of  $a_j$  for  $i \neq j$ . Then the system  $\{d_{a_i}\}$  of the corresponding divisor-invariants is an antichain in  $RI$ , which becomes evident by testing it on the system of ribbons  $\{a_i\}$ .  $\square$

It is natural to consider the space  $RI_m$  of truncated  $\gamma$ -ribbon invariants, which is a finite poset. Now, one may ask the following

**Question.** What is the width of  $RI_m$ ? More generally - what can be said about its *structure*?

Of course, the same may be asked about the other truncated  $\gamma_*$ -ribbon invariants. Now we prove the central fact in this section.

**Theorem 23.3.** *Consider the poset  $RI$  of ribbon invariants with the usual  $\gamma$ -normalization. Then its global maximum is  $\gamma$ .*

*Proof.* It may be done by induction on the lexicographic order  $\prec$  in  $\mathcal{A}$ . Let  $\eta \in RI$  and  $a \in \mathcal{A}$  be a non-elementary ribbon. It suffices to show that  $\eta(a) \leq \gamma(a)$ . For a non-elementary ribbon  $a$ , we proved previously that at least one of the following two cases happens a) there is a binary splitting  $a = a_1a_2$ , such that  $\gamma(a) = \gamma(a_1) + \gamma(a_2)$  and  $a_i \prec a$ ,  $i = 1, 2$  b) there is a ternary splitting  $a = [a_1a_2a_3]$ , such that  $\gamma(a) = \gamma(a_1) + \gamma(a_2) + \gamma(a_3)$  and  $a_i \prec a$ ,  $i = 1, 2, 3$ . Suppose now that  $\eta(x) \leq \gamma(x)$  for any  $x \prec a$ . Then in case a) we have

$$\eta(a) \leq \eta(a_1) + \eta(a_2) \leq \gamma(a_1) + \gamma(a_2) = \gamma(a),$$

while in case b)

$$\eta(a) \leq \eta(a_1) + \eta(a_2) + \eta(a_3) \leq \gamma(a_1) + \gamma(a_2) + \gamma(a_3) = \gamma(a).$$

$\square$

**Corollary 23.4.** *If  $\eta$  is a  $\gamma$ -ribbon invariant, then  $\eta \leq \frac{n}{2} + 1$ .*

This follows from the basic inequality  $\gamma \leq \frac{n}{2} + 1$  proved in [Section 15](#). Similarly, all estimates from above for the other invariants  $\gamma_*$  remain valid for any ribbon invariant with the same normalization on elementary ribbons.

**Corollary 23.5.** *Let  $\eta$  be a  $\gamma$ -ribbon invariant different from  $\gamma$ . Then there is some ribbon  $a \in \mathcal{A}$  such that for any nontrivial splitting  $a = a_1a_2$  or  $a = [a_1a_2a_3]$  into “smaller” ribbons, we have*

$$\eta(a) < \eta(a_1) + \eta(a_2) \text{ and } \eta(a) < \eta(a_1) + \eta(a_2) + \eta(a_3).$$

It is not that easy to find such a “defective” ribbon for a given  $\gamma$ -invariant  $\eta \neq \gamma$ . For example for  $\eta = \gamma_{\text{ext}} + \gamma_{\text{sad}}$ , see [Example 9.14](#).

**Remark.** *[Theorem 23.3](#) remains equally true for the other three  $\gamma_*$ -ribbon invariants  $\gamma_0, \gamma_{\text{ext}}, \gamma_{\text{sad}}$ . So, we arrive at some curious observation:*

*The absolute maximum of all **algebraic** invariants is **geometric** in nature.*

## 24. FINAL REMARKS AND OPEN QUESTIONS

Let us summarize in this final section some open problems and trace the routes for further investigations.

First we list some general problems and speculations about ribbons.

**Q1.** Find “good” algorithms for the calculation of  $\gamma$  and the other geometric ribbon invariants. Is there a polynomial one for the calculation of  $\gamma$ ? Here by “good” algorithm we mean “fast” algorithm. In Part II of the present paper we describe an algorithm for calculation of  $\gamma$  in  $\mathcal{A}^+$  which is based on the reduction of a ribbon to a ladder by a sequence of elementary moves. It is by no means better than the general one described in [Section 12](#).

**Q2.** Note that the algebraic methods exposed here for managing ribbon invariants are not quite “algebraic” in nature. For example, we get *semigroups* instead of groups, *partial ordering* instead of equivalence relation classes, etc. In this sense, it would be interesting to find some more algebraically calculable aspects of the ribbon invariants.

**Q3.** Investigate the ribbon invariants for 2-surfaces with boundary (connected or not), instead of only for the disk  $\mathbb{B}^2$ . In [Section 22](#) we presented some specific results about the annulus.

**Q4.** Multidimensional ribbons. In [Section 16](#) we speculated about these by defining some *ribbon-term* in Morse and Lusternik-Schnirelmann inequalities. Of course, there is a bunch of problems here. For example, one of them is whether there is a class of good extensions analogous to the *economic* ones defined in [Section 6](#). Another problem is about the structure of the boundary data of a multidimensional ribbon. One way is to consider only Morse functions on the boundary. By the way, L. Nicolaescu [\[6\]](#) counted (and described) all Morse function on the sphere  $\mathbb{S}^2$ . On the other hand, we find reasonable to consider as boundary conditions some larger class of “economic” functions, admitting degenerated saddles. Of course, from point of view of the applications, we should be able to provide, by a little move, Morse type boundary conditions and then considering  $\gamma$ .

Also, it would be interesting to see whether ribbon type estimates may be obtained in the *symplectic* category.

**Q5.** Infinite dimensional ribbons, functionals. As we know, there are multiple variants of Morse theory where the ambient manifold  $M$  is infinite dimensional and the number of critical points of some functional are estimated from below (of course, under some compactness conditions), see [\[7\]](#). This provides results about the existence of solutions of the corresponding differential equation, associated with this functional. In this setting, it would be interesting to see whether some technique of *infinite dimensional ribbons* may be applied in order to obtain multiplicity results about the number of solutions of differential equations.

**Q6.** PL-ribbons and extensions. In fact all the ribbon theory may be settled in the PL-category instead of the differential one. Here the ribbons are defined by piecewise linear maps on polygonal Jordan curves, the extensions are also PL-maps, etc. The *critical points* of a 2-variables PL-function may be correctly defined and almost all the results remain the same. From this point of view,

*Ribbons and ribbon invariants are more a combinatorial phenomenon,  
rather than a differential one.*

**Q7.** Applications, computer simulations. As to applications, it is clear that this technique may be very useful for establishing various multiplicity results. For example, it is natural to consider the following situation:  $f(x, y)$  is a smooth function defined in some region  $D \subset \mathbb{R}^2$  and we want to count its critical points. Take some rectangle  $Q \subset D$  and estimate the number of critical points of  $f$  in  $Q$  in two steps

1) Find the induced ribbon  $a_Q(f)$  on  $\partial Q$ . This is not that difficult to be done, since the problem is in fact 1-dimensional for a rectangle.

2) Calculate  $\gamma(a_Q(f))$ , then  $f$  has at least  $\gamma(a_Q(f))$  critical points inside  $Q$ . Surely, this step depends on the available algorithm and may slow down the task, anyway, for small number of nodes it may be done in a reasonable time. Another way is to make use of the general estimates from below for  $\gamma$ , such as the *cluster number* or the *index* of a ribbon, which are much easier calculable. Note also that this method is appropriate for the localization of the critical set  $\text{Crit}(f)$  by moving rectangle  $Q$  inside  $D$ . Of course, one may use some different shape instead of rectangles, e.g. circles or even a free shape form.

As for computer simulations, maybe the PL-approach is the most convenient one, since it deals in fact only with finite numerical data concentrated at the nodes of the PL-subdivision.

Now we list some minor open problems that appear here and there in the text.

**q0.** What can be said about non general position ribbons? There are two cases of degeneracy of a ribbon - 1) coinciding critical values and 2) appearance of a critical point at a node of the ribbon itself. These ribbons are of importance when considering elementary moves in the ribbon space  $\mathcal{A}$ . Another question about such ribbons is whether there exists a nice generating function for these, analogous to the formula obtained in [Section 4](#), p. 22 for ordinary (general position) ribbons.

**q1.** For a given ribbon  $a \in \mathcal{A}$ , what is the cardinality of the set  $\mathcal{F}^e(a)$  of its economic extensions? Here extensions are combinatorially distinguished. Another, more difficult question, is about counting topologically different economic extensions.

**q2.** What is the cardinality of  $\mathcal{F}_n^e$  - the set of economic extensions of ribbons with  $\leq n$  nodes?

**q3.** Are there any consistent estimates of the number  $\phi_r(a)$  of economic extensions of a given ribbon  $a$  with exactly  $r$  critical points?

**q4.** For which pairs  $(\sigma, \gamma)$  do a ribbon exist with signature  $\sigma$  and ribbon invariant  $\gamma$ ? In [Section 9](#), p. 42 we showed that the basic inequality involving  $\sigma$  and  $\gamma$  does not guarantee the existence of such a ribbon. Let  $\Sigma_m$  be the space of (rigid) ribbons of signature  $\sigma = m$  and  $\Gamma_k$  be the space of ribbons with  $\gamma = k$ . Then the above question takes the form “When  $\Sigma_m \cap \Gamma_k \neq \emptyset$ ?” Another natural question is “When does  $\Sigma_m \cap \Gamma_k$  have a finite number of components?”

**q5.** What are the homologies (the homotopy type) of the space  $\Sigma_m \cap \Gamma_k$ ? This is the most general question of this sort.

**q6.** In Part II we prove that the space  $\Gamma_0$  of ribbons with  $\gamma = 0$  is connected. So, it is natural to ask:

Is  $\Gamma_0$  contractible? If not, then what is the fundamental group  $\pi_1(\Gamma_0)$ ?

**q7.** Is it true that  $\gamma_0(a) = \gamma(a)$  implies that the ribbon  $a$  is a ladder?

**q8.** Is there a winning strategy for player B in *the ribbon game* described in [Section 13](#), p. 55? The same question about the *Jordan* variant of the game.

**q9.** Consider in class  $\mathcal{A}^+$  the number  $\nu$  which is changing by  $-1$  at meetings and by  $+1$  at separations (and has some initial values on ladders). Then is this number  $\nu$  an *invariant*, i.e. is it independent of the path selected in  $\mathcal{A}^+$ ? If so, does it have some intrinsic definition in terms of the corresponding zig-zag permutation?

**q10.** What is the *mathematical expectation* of the quantity  $\frac{\gamma}{n}$ ? What is the distribution of the sequence  $\left\{ \frac{\gamma(a_i)}{n(a_i)} \right\}$  in  $[0, 1/2]$ , where the ribbons  $a_i \in \mathcal{A}$  are lexicographically ordered? For example, is it uniformly distributed or has it some other peculiar behaviour? The same may be asked under condition of fixed signature:  $\sigma = \sigma_0$ .

**q11.** Let  $P \subset \mathbb{S}^1$  be a set of  $n$  points (*nodes*),  $n$  is even, and  $\nu : P \rightarrow \{+, -\}$  be a *marking* with signature  $\sigma$ . Then, under what conditions is it true that for a given number  $k$ , satisfying the general inequality  $1 - \frac{\sigma}{2} \leq k \leq n - 1 - \frac{\sigma}{2}$ , there is a smooth function  $\varphi : \mathbb{S}^1 \rightarrow \mathbb{R}$  with node set  $P$ , such that for the ribbon  $a = (\varphi, \nu)$  we have  $\gamma(a) = k$ ?

**q12.** For any finite set of vectors  $\xi_1, \dots, \xi_n$  in  $\mathbb{R}^3$ , is it true that a frame  $l$  exists, such that any membrane  $M$  with  $\partial M = l$  realizes all  $\xi_i$ ,  $i = 1, \dots, n$  as normal directions?

**q13.** For a general position function  $\varphi : \mathbb{S}^1 \rightarrow \mathbb{R}$ , what is the number of critical points free extensions of  $\varphi$ ? (see p. 70) Is it true that this number is the same for all *alternations*  $\varphi$ ? Here the extensions are combinatorially distinguished. Recall that for a ladder-type  $\varphi$  this number equals  $2^{\frac{n}{2}-1}$  (where  $n$  is the number of critical points of  $\varphi$ ) and this is the minimal possible value among all functions  $\varphi$ . Another natural question is about the maximal value of the number of critical points free extensions (for fixed  $n$ ). It is not difficult to see that this value is attained at some alternation.

The same may be asked about functions  $\varphi$  with  $n$  local and  $s$  absolute extrema such that  $s \leq \frac{n}{2} + 1$ . In case  $s > \frac{n}{2} + 1$  we have 1 critical point guaranteed and one may be interested in the number of extensions with *exactly* 1 critical point. (Note that such an extension always exists - it suffices to take a *cone* over the graph of  $\varphi$  and then to perform smoothening at the vertex.)

**q14.** If  $M^n$  is a smooth  $n$ -dimensional manifold and  $f : M^n \rightarrow \mathbb{R}$  is a Morse function, does there exist an immersion  $\phi : M^n \rightarrow \mathbb{R}^{n+1}$ , such that  $\pi\phi = f$ , where  $\pi$  is the projection on some fixed line  $l \approx \mathbb{R}$ ?

**q15.** What is the cardinality and the width of the partially ordered set  $RI_m$ ? More generally - what can be said about its *structure*? The same question about the other truncated  $\gamma_*$ -ribbon invariants.

**q16.** Describe the class of *harmonic* ribbons. A ribbon  $a = (\varphi, \nu) \in \mathcal{A}$  is *harmonic* if the (unique) solution  $f$  of the Dirichlet problem  $\Delta f = 0$ ,  $f|_{\mathbb{S}^1} = \varphi$  is inducing ribbon  $a$  itself on  $\mathbb{S}^1$ .

**q17.** Describe the class of *Jordan* ribbons. A ribbon  $a = (\varphi, \nu) \in \mathcal{A}$  is *Jordan*, if it has a representation by a Jordan curve in the plane (Section 15, p. 62). A straightforward necessary condition for this is  $\gamma(a) = 0$ , however, various obstructions for such a ribbon to be *Jordan* may be formulated. The interconnection between ribbons and the theory of immersed curves in the plane will be discussed in more detail in Part II of the present article.

Note finally that a part of the material in the paper was communicated at the conference [8].

## REFERENCES

- [1] J. W. Milnor. *Topology from the Differentiable Viewpoint*. Princeton University Press, 1997.
- [2] D. André. Sur les permutations alternées. *Journal de mathématiques pures et appliquées*, 3e série, tome 7 (1881), 167–184.
- [3] P. W. Shor and C. J. Van Wyk. Detecting and decomposing self-overlapping curves. *Computational Geometry: Theory and Applications 2* (1992), Elsevier, 31–50.
- [4] V. I. Arnold. Plane curves. Their invariants, perestroikas and classifications. *Adv. in Soviet Math.* 21 (1994), 33–91.
- [5] F. Takens, The minimal number of critical points of a function on compact manifolds and the Lusternik-Schnirelmann category, *Inventiones Mathematicae* 6 (1968), 197–244.
- [6] L. I. Nicolaescu. Counting Morse functions on the 2-sphere. *Compositio Math.* 144 (2008), 1081–1106.
- [7] A. Floer. Witten’s complex and infinite dimensional Morse theory. *J. Differ. Geom.* 30(1989), 207–221.
- [8] S. Stefanov. An invariant counting critical points. II Intern. Conf. “Math. Days in Sofia”, July 10–14, 2017, Sofia.
- [9] A. O. Prishlyak. Topological equivalence of smooth functions with isolated critical points on a closed surface. [arXiv:math/9912004v1](https://arxiv.org/abs/math/9912004v1) [math.GT] 1 Dec 1999.
- [10] A. Parusiński. Gradient homotopies of gradient vector fields. *Studia Mathematica*, v. XCVI (1990), 73 - 80.

UNIVERSITY OF ARCHITECTURE, CIVIL ENGINEERING AND GEODESY (UACEG), SOFIA 1046,  
1 HR. SMIRNENSKI BLVD.

*E-mail address:* `sim.stef.ri@gmail.com`