

Technical Design Report for the AMoRE $0\nu\beta\beta$ Decay Search Experiment

V. Alenkov^a, P. Aryal^b, J. Beyer^c, R.S. Boiko^d, K. Boonin^e, O. Buzanov^a, N. Chanthima^e, M.K. Cheoun^f, D.M. Chernyak^d, J. Choi^g, S. Choi^g, F.A. Danevich^d, M. Djamel^h, D. Drung^c, C. Enssⁱ, A. Fleischmannⁱ, A.M. Gangapshev^j, L. Gastaldoⁱ, Yu.M. Gavriljuk^j, A.M. Gezhaev^j, V.I. Gurentsov^j, D.H. Ha^b, I.S. Hahn^k, J.H. Jang^b, E.J. Jeon^l, H.S. Jo^l, H. Joo^g, J. Kaewkhao^e, C.S. Kang^l, S.J. Kang^m, W.G. Kang^l, S. Karki^b, V.V. Kazalov^j, N. Khanbekov^{n,o}, G.B. Kim^l, H.J. Kim^b, H.L. Kim^b, H.O. Kim^l, I. Kim^g, J.H. Kim^p, K. Kim^g, S.K. Kim^g, S.R. Kim^l, Y.D. Kim^l, Y.H. Kim^l, K. Kirdsiri^e, V.V. Kobychyev^d, V. Kornoukhovⁿ, V.V. Kuzminov^j, H.J. Lee^l, H.S. Lee^l, J.H. Lee^p, J.M. Lee^p, J.Y. Lee^b, K.B. Lee^p, M.H. Lee^l, M.K. Lee^p, D.S. Leonard^l, J. Li^l, J. Li^q, Y.J. Li^q, P. Limkitjaroenporn^e, K.J. Ma^r, O.V. Mineev^j, V.M. Mokina^d, S.L. Olsen^l, S.I. Panasenkov^j, I. Pandey^b, H.K. Park^l, H.S. Park^p, K.S. Park^l, D.V. Poda^d, O.G. Polischuk^d, P. Polozovⁿ, H. Prihtiadi^h, S.J. Ra^l, S.S. Ratkevich^j, G. Rooh^s, K. Siyeon^t, N. Srisittipokakun^e, J.H. So^l, J.K. Son^b, J.A. Tekueva^j, V.I. Tretyak^d, A.V. Veresnikova^j, R. Wirawan^u, S.P. Yakimenko^j, N.V. Yershov^j, W.S. Yoon^l, Y.S. Yoon^l, and Q. Yue^q

^a*JSC FOMOS-Materials, Moscow 107023, Russia*

^b*Department of Physics, Kyungpook National University, Daegu 41566, Korea*

^c*Physikalisch-Technische Bundesanstalt (PTB), D-38116 Braunschweig, Germany*

^d*Institute for Nuclear Research, MSP 03680 Kyiv, Ukraine*

^e*Nakhon Pathom Rajabhat University, Nakhon Pathom 73000, Thailand*

^f*Department of Physics, Soongsil University, Seoul 06978, Korea*

^g*Department of Physics, Seoul National University, Seoul 08826, Korea*

^h*Institut Teknologi Bandung, Jawa Barat 40132, Indonesia*

ⁱ*Kirchhoff-Institute for Physics, D-69120 Heidelberg, Germany*

^j*Baksan Neutrino Observatory of INR RAS, Kabardino-Balkaria 361609, Russia*

^k*Ehwa Womans University, Seoul 03760, Korea*

^l*Center for Underground Physics, Institute of Basic Science, Daejeon 34047, Korea*

^m*Semyung University, Jecheon 27136, Korea*

ⁿ*Institute of Theoretical and Experimental Physics, Moscow 117218, Russia*

^o*National Research Nuclear University MEPhI, Moscow, 115409, Russia*

^p*Korea Research Institute for Standard Science, Daejeon 34113, Korea*

^q*Tsinghua University, 100084 Beijing, China*

^r*Department of Physics, Sejong University, Seoul 05000, Korea*

^s*Department of Physics, Abdul Wali Khan University, Mardan 23200, Pakistan*

^t*Department of Physics, Chung-Ang University, Seoul 06911, Korea*

^u*University of Mataram, Nusa Tenggara Bar. 83121, Indonesia*

December 21, 2015

Abstract

The AMoRE (Advanced Mo-based Rare process Experiment) project is a series of experiments that use advanced cryogenic techniques to search for the neutrinoless double-beta decay of ^{100}Mo . The work is being carried out by an international collaboration of researchers from eight countries. These searches involve high precision measurements of radiation-induced temperature changes and scintillation light produced in ultra-pure ^{100}Mo -enriched and ^{48}Ca -depleted calcium molybdate ($^{48\text{depl}}\text{Ca}^{100}\text{MoO}_4$) crystals that are located in a deep underground laboratory in Korea. The ^{100}Mo nuclide was chosen for this $0\nu\beta\beta$ decay search because of its high Q -value and favorable nuclear matrix element. Tests have demonstrated that CaMoO_4 crystals produce the brightest scintillation light among all of the molybdate crystals, both at room and at cryogenic temperatures. $^{48\text{depl}}\text{Ca}^{100}\text{MoO}_4$ crystals are being operated at milli-Kelvin temperatures and read out via specially developed metallic-magnetic-calorimeter (MMC) temperature sensors that have excellent energy resolution and relatively fast response times. The excellent energy resolution provides good discrimination of signal from backgrounds, and the fast response time is important for minimizing the irreducible background caused by random coincidence of two-neutrino double-beta decay events of ^{100}Mo nuclei. Comparisons of the scintillating-light and phonon yields and pulse shape discrimination of the phonon signals will be used to provide redundant rejection of alpha-ray-induced backgrounds. An effective Majorana neutrino mass sensitivity that reaches the expected range of the inverted neutrino mass hierarchy, i.e., 20-50 meV, could be achieved with a 200 kg array of $^{48\text{depl}}\text{Ca}^{100}\text{MoO}_4$ crystals operating for three years.

Contents

1	Introduction	3
2	Scientific goals	6
2.1	Brief summary of $\beta\beta$ experiments	6
2.2	Choice of ^{100}Mo for $0\nu\beta\beta$ experiments	9
2.3	Development of CaMoO_4 crystal scintillators	10
2.4	AMoRE project - Parameters	11
2.5	Sensitivity of AMoRE	12
3	CaMoO_4 crystal scintillators	16
3.1	Production of high-purity crystals	16
3.1.1	Synthesis of CaMoO_4 raw material	19
3.1.2	CaMoO_4 crystal growth	20
3.2	Luminescence and scintillation properties of CaMoO_4 crystals	20
3.2.1	Luminescence properties of CaMoO_4 crystals	20
3.2.2	Light yield measurements	21
3.2.3	Absolute light yield measurement	22
3.2.4	Light yield comparison of different CaMoO_4 crystals	23
3.2.5	Room-temperature energy resolution of CaMoO_4 crystals	23
3.2.6	Pulse shape discrimination (PSD)	25
3.2.7	Temperature dependence of the light yield of CaMoO_4 crystals	25
3.3	^{48}Ca -depleted, ^{100}Mo -enriched $^{48\text{depl}}\text{Ca}^{100}\text{MoO}_4$ crystals	26
3.4	Growth of large radio-pure $^{48\text{depl}}\text{Ca}^{100}\text{MoO}_4$ crystals	27
3.5	Radioactive contaminants in CaMoO_4 crystal scintillators	29
3.5.1	Low-background setup at Y2L	29
3.5.2	Contamination of CaMoO_4 crystals by thorium and radium.	31
4	Cryogenic particle detection	33
4.1	Principle of thermal detection in low temperature calorimeters	34
4.2	Magnetic Metallic Calorimeter (MMC)	35
4.3	Phonon measurement with large CaMoO_4 crystals	36
4.4	Development of low-temperature photon sensors	38
4.5	Simultaneous measurement of phonon and photon signals	40

5	Experimental design	43
5.1	Overview	43
5.2	AMoRE-Pilot	43
5.2.1	Experimental arrangement	43
5.2.2	Inner shielding	46
5.2.3	Outer shielding	46
5.3	AMoRE-I	47
5.4	AMoRE-II	51
5.4.1	Crystals for AMoRE-II	51
6	Simulation tools and background estimations	53
6.1	Geometry of simulation configuration	54
6.2	Internal background in CaMoO_4	55
6.3	Backgrounds from materials in detector system	56
6.4	Cosmic ray induced background	59
6.4.1	Muon energy spectrum	60
6.4.2	Schematic layout of simulation geometry	60
6.4.3	Muon and muon-induced neutron backgrounds	61
6.5	Other backgrounds	61
6.6	Summary of Background Estimation	62
7	Supply, purification and recovery of enriched materials	64
7.1	^{100}Mo	64
7.2	$^{48\text{depl}}\text{Ca}$	65
7.3	Purification of calcium and molybdenum oxides and recovery of enriched materials after crystal production	66
7.4	Deep purification of CaCO_3 powder	66
7.5	Deep purification of MoO_3 powder	71
7.6	Calcium and molybdenum recovery from CaMoO_4 crystals	76
7.6.1	Decomposition of CaMoO_4 crystals with 65% HNO_3	76
7.6.2	Decomposition of CaMoO_4 crystal material with 36% HCl	78
8	Offline software	80
8.1	Environment	81
8.2	Modules	81
9	Time, Schedule	82
9.1	Schedules	82

Chapter 1

Introduction

Even though we now know that neutrinos have mass, their absolute masses and their fundamental nature still remain a mystery [1, 2]. The Standard Model of three-neutrino mixing has been firmly established by a number of neutrino oscillation measurements, including the recent determination of θ_{13} by the Daya Bay, Double-Chooz and RENO experiments. However, mixing measurements do not discriminate between Majorana- and Dirac-type neutrinos and only provide information on mass differences, not on mass values themselves. At present, five fundamental questions about neutrinos remain:

- (i) Are they Majorana-type or Dirac-type?
- (ii) What is their absolute mass scale?
- (iii) What is the mass hierarchy between the three neutrinos?
- (iv) Is lepton number conserved?
- (v) Does neutrino mixing violate CP symmetry?

Among these, the first question about the nature of neutrinos is most fundamental in that it remains the major unknown aspect of the Standard Model. Moreover it is an essential element for any theoretical model of neutrino masses.

The universe is comprised of matter and not antimatter; the cause of this matter-antimatter asymmetry is not understood. Since the now well established CP -symmetry violation in the quark sector is not sufficient to generate the observed matter excess, particle physicists suspect that the neutrino sector may be responsible for the current matter-antimatter asymmetry (by a process called leptogenesis). If this turns out to be the case, this will solve one of the most interesting and fundamental puzzles about the development of the universe. However, even if CP is observed to be violated in neutrino oscillation experiments, the theory for a leptogenesis-induced matter-antimatter asymmetry depends sensitively on whether or not neutrinos are Majorana particles. Investigation of neutrinoless double-beta decays ($0\nu\beta\beta$) is the only practical way to determine the nature of the neutrino (Majorana or Dirac particle), check lepton-number conservation, and determine the absolute scale and the neutrino mass hierarchy [2, 3, 4, 5, 6, 7, 8].

The half-life of $0\nu\beta\beta$ decay, $T_{1/2}(0\nu\beta\beta)$, is related to the effective Majorana neutrino mass ($\langle m_{\beta\beta} \rangle$) and nuclear matrix element ($M_{0\nu}$), as follows:

$$[T_{1/2}^{0\nu}]^{-1} = G_{0\nu} |M_{0\nu}|^2 \left(\frac{\langle m_{\beta\beta} \rangle}{m_e} \right)^2, \quad (1.1)$$

where $G_{0\nu}$ is the phase-space factor and $\langle m_{\beta\beta} \rangle$ is given by

$$\langle m_{\beta\beta} \rangle = \Sigma m_i U_{ei}^2 \sim \frac{1}{2} \left| m_1 + m_2 e^{2i\beta} + m_3 e^{2i(\gamma-\delta)} \right|. \quad (1.2)$$

Here U_{ei} is the Pontecorvo-Maki-Nakagawa-Sakata (PMNS) neutrino mixing matrix, m_i are the light Majorana neutrino eigenstate masses, and β , γ and δ are CP-violating phases.

Neutrino oscillation experiments give the mass differences: $\Delta m_{23}^2 \sim 2.43 \times 10^{-3} \text{ eV}^2$, $\Delta m_{12}^2 \sim 8.0 \times 10^{-5} \text{ eV}^2$, and the mixing angles. The expected value of $\langle m_{\beta\beta} \rangle$ is shown as a function of the smallest neutrino mass in Fig. 1.1. For high $\langle m_{\beta\beta} \rangle$ values (and correspondingly lower $0\nu\beta\beta$ half-lives), the neutrino mass scale is larger than the mass differences and the neutrinos are nearly degenerate. If the value of $\langle m_{\beta\beta} \rangle$ approaches that of the mass differences, $\langle m_{\beta\beta} \rangle$ lies in one of the horizontal bands, depending on the neutrino mass hierarchy; for the inverted hierarchy, the value of $\langle m_{\beta\beta} \rangle$ is in the 0.02 – 0.05 eV range. This interval of neutrino masses could be accessed with a zero background $0\nu\beta\beta$ detector with a total mass of several hundred kilograms. On the other hand, orders-of-magnitude larger-scale experiments would be needed to access the normal neutrino mass hierarchy.

It should be stressed that $0\nu\beta\beta$ decay-like signals could result from the influence of hypothetical, beyond the Standard Model particles and/or interactions. This might involve, for example, an admixture of right-handed currents in weak interactions, the emission of massless (or very light) Nambu-Goldstone bosons (so-called Majorons), or a variety of other processes that have been proposed in extensions of the SM [6, 7, 15, 16]. Therefore, investigations of $0\nu\beta\beta$ decay processes are powerful methods for searching for beyond-the-SM effects.

The AMoRE experiment's aim is to search for $0\nu\beta\beta$ decay of ^{100}Mo nuclei using CaMoO_4 scintillating crystals operating at milli-Kelvin temperatures. The ultimate goal of the experiment is to achieve a sensitivity that covers the entire $\langle m_{\beta\beta} \rangle$ range that is allowed by the inverted neutrino mass hierarchy. This will require advancing the current states-of-the-art in background rejection, radio-pure crystal growing, and cryogenic radiation detector techniques. To accomplish these ambitious goals, we have formed an international team of researchers that includes experts in each of these areas and plan on using a phased approach that starts with modest experiments with current state-of-the-art technologies and advance from there. This report describes the status of our R&D efforts and accomplishments in radio-pure crystal growing, cryogenic detection, background simulation and suppression, and the current status of, and plans for, our step-wise approach to a full experiment with a 200 kg detector.

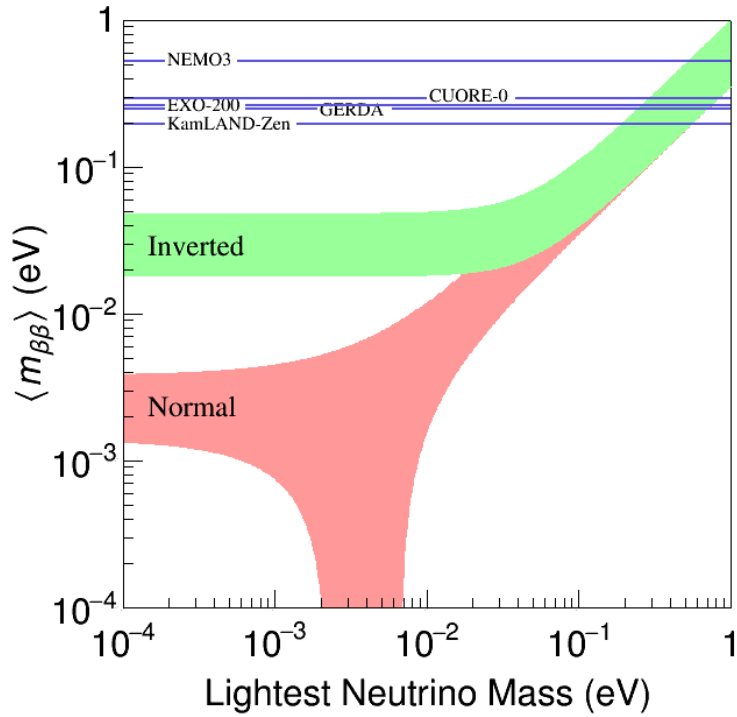

Figure 1.1: Effective Majorana neutrino mass ($\langle m_{\beta\beta} \rangle$) as a function of the mass of the lightest neutrino together with current limits on the mass from a selection of the most sensitive experiments [9, 10, 11, 12, 13]. To convert the experimental half life limits to $\langle m_{\beta\beta} \rangle$ limits, the products of $G_{0\nu}|M_{0\nu}|^2$ were chosen as the central values from the ranges given in [14]. (See Sec. 2.5 for the sensitivity of AMoRE-II experiment after five years of data taking).

Chapter 2

Scientific goals

2.1 Brief summary of $\beta\beta$ experiments

Many experimental techniques for double-beta-decay searches have been developed, starting with the first experiment in 1948 that used Geiger counters, but did not see $\beta\beta$ any signal [17]. The SM-allowed, second-order weak two-neutrino double-beta ($2\nu\beta\beta$) decay mode was first observed in tellurium and selenium by means of geochemical techniques (for a review, see, e.g., [18]). The first observation of $2\nu\beta\beta$ decay in a direct counting experiment was accomplished in 1987 with an apparatus that consisted of a time-projection chamber that surrounded a thin ^{82}Se film source [19]. At present, $2\nu\beta\beta$ decay modes have been detected for eleven nuclides: ^{48}Ca , ^{76}Ge , ^{82}Se , ^{96}Zr , ^{100}Mo , ^{116}Cd , ^{128}Te , ^{130}Te , ^{136}Xe , ^{150}Nd and ^{238}U (for reviews, see refs. [20, 21, 22] and references therein). Indications for two-neutrino double-electron capture in ^{78}Kr [23] and ^{130}Ba [24, 25] have also been reported.

In contrast, despite more than sixty years of experimental effort, no unambiguous examples of $0\nu\beta\beta$ decays have yet to be observed. The best half-life limits are at levels of $T_{1/2} = 10^{23} \sim 10^{25}$ yrs, depending on the nuclide (see [20, 26, 27, 28] and results of recent experiments [29, 30, 31, 32, 9]). These half-life limits have been used to restrict (using currently available theoretical calculations of the nuclear matrix elements) the effective Majorana neutrino mass to be below the level of $\langle m_{\beta\beta} \rangle \sim (0.2 - 2)$ eV. The best limits on the half-lives for the most studied nuclei and the effective Majorana neutrino mass are summarized in Table 2.1.

There is also a claim by Klapdor-Kleingrothaus *et al.* for the detection of $0\nu\beta\beta$ decays of ^{76}Ge with a half-life of $T_{1/2} \sim 2 \times 10^{25}$ yrs ($\langle m_{\beta\beta} \rangle > \sim 0.3$ eV) [33]. This was derived from the data of the Heidelberg-Moscow experiment [34] that utilized an 11 kg array of ^{76}Ge -enriched high-purity germanium (HPGe) detectors [35, 36]. In the context of the SM, this half-life implies nearly degenerate neutrino masses. This claimed observation was criticized in refs. [37, 38, 39] and was recently challenged by the GERDA experiment that used a similar HPGe spectrometry technique [30] and found no evidence for $0\nu\beta\beta$ decay of ^{76}Ge and set a lower limit at the level of $\lim T_{1/2} = 2.1 \times 10^{25}$ yr. Unfortunately, the GERDA experiment exposure (21.6 kg \times yr) was sufficient to permit only a

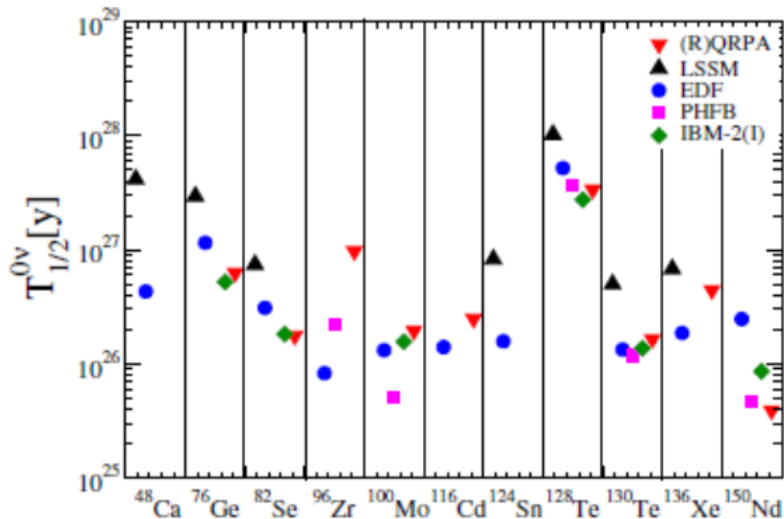

Figure 2.1: The $0\nu\beta\beta$ -decay half-lives calculated for an effective Majorana neutrino mass $\langle m_{\beta\beta} \rangle = 0.05$ eV using different theoretical methods to calculate the nuclear matrix element (Figure 24 from ref. [7]).

marginal exclusion of the Klapdor claim.

However, as one can see in Fig. 1.1, even the most sensitive current experiments only explore the degenerate region of the neutrino mass pattern. Several new experiments have been proposed to reach the minimum $\langle m_{\beta\beta} \rangle$ region allowed for the inverted neutrino mass hierarchy, i.e., $\langle m_{\beta\beta} \rangle \leq 0.05$ eV (see reviews in refs. [5, 26, 27, 28, 47, 48, 49, 50, 51] and original proposals [52, 53, 54, 55, 56, 57, 58, 59, 60, 61, 62]). To cover this region, the half-life sensitivity of the next generation experiments should be at the level of $T_{1/2} \sim 10^{26} - 10^{27}$ yrs (see Fig. 2.1).

To accomplish these ambitious goals, detectors are required to: sample a sufficiently large number of $\beta\beta$ -active nuclei (i.e., $10^{27} \sim 10^{28}$ nuclei, which corresponds to $10^3 \sim 10^4$ moles of the isotope of interest); have as low as possible (ideally zero) radioactive background and as high as possible (ideally 100%) detection efficiency; have the ability to distinguish a $0\nu\beta\beta$ signal from different background components; and, especially, have excellent energy resolution.

The choice of the candidate nuclide is determined by the scale of the experiment, the extreme background requirements, the possibility of using calorimetric (“source=detector”) techniques to achieve high detection efficiency, and the energy resolution. Among the theoretically most promising nuclides (see Fig. 2.1), the mass production of enriched isotopes is available for ^{76}Ge , ^{82}Se , ^{100}Mo , ^{116}Cd , ^{130}Te and ^{136}Xe [47, 48]. Suppression of background is easier for $\beta\beta$ nuclides that have a $Q_{\beta\beta}$ -value that is above the 2615 keV gamma line from ^{208}Tl (a daughter nuclide in the ^{232}Th chain). This limits the most promising candidate nuclides to ^{82}Se , ^{100}Mo and ^{116}Cd .

Table 2.1: Half-life and Majorana-neutrino-mass limits from the most sensitive neutrinoless double-beta decay experiments.

Nucleus	$Q_{\beta\beta}$ [40][keV]	Natural abundance [41]	$T_{1/2}$ [years]	$\langle m_{\beta\beta} \rangle$ [eV]	Experiment Technique	Enrichment [%]	Ref.
^{48}Ca	4267.0(4)	0.187(21)	$> 5.8 \times 10^{22}$	$< 3.5 - 22$	Elegant VI CaF ₂ (Eu) scintillator	Nat.	[42]
^{76}Ge	2039.06(1)	7.73(12)	$> 1.9 \times 10^{25}$	< 0.35	H-M, HPGe	86	[34]
			$> 1.57 \times 10^{25}$	$< 0.33 - 1.35$	IGEX, HPGe	86	[43]
			$2.23^{+0.44}_{-0.31}$	0.32 ± 0.03	HPGe	86	[33]
			$> 2.1 \times 10^{25}$	$< 0.2 - 0.4$	GERDA, HPGe	86	[30]
^{82}Se	2996.4(15)	8.73(22)	$> 3.6 \times 10^{23}$	$< 0.89 - 2.43$	NEMO-3, tracking	97	[13]
^{100}Mo	3034.37(40)	9.82(31)	$> 1.1 \times 10^{24}$	$< 0.3 - 0.9$	NEMO-3 tracking	95-99	[32]
^{116}Cd	2813.50(13)	7.49(18)	$> 1.7 \times 10^{23}$	$< 1.5 - 1.7$	Solotvina, $^{116}\text{CdWO}_4$ scintillator	83	[44]
^{128}Te	866.5(9)	31.74(8)	$> 8.1 \times 10^{24}$	$< 1.1 - 1.5$	Geochem.		[45]
^{130}Te	2527.51(1)	34.08(62)	$> 4.0 \times 10^{24}$	$< 0.27 - 0.76$	Cuoricino, CUORE-0 Cryogenic TeO ₂ bolometer	Nat.	[9]
^{136}Xe	2457.99(27)	8.8573(44)	$> 1.1 \times 10^{25}$	$< 0.19 - 0.45$	EXO-200, TPC	80.6	[29]
			$> 2.6 \times 10^{25}$	$< 0.14 - 0.28$	KamLAND- Zen, Liquid scintillator	90	[31]
^{150}Nd	3371.38(20)	5.638(28)	$> 1.8 \times 10^{22}$	$< 4.0 - 6.3$	NEMO-3 tracking	91	[46]

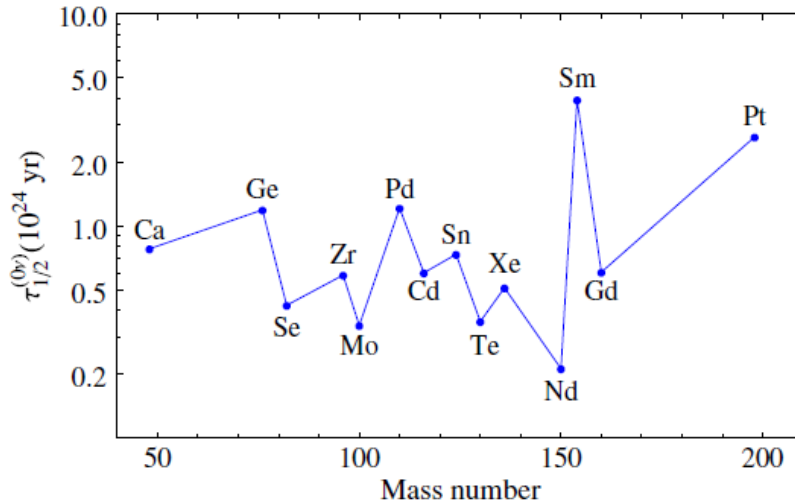

Figure 2.2: The computed neutrinoless double-beta decay half-lives for various nuclei for $\langle m_{\beta\beta} \rangle = 1$ eV (Figure 2 from [8]).

2.2 Choice of ^{100}Mo for $0\nu\beta\beta$ experiments

Among the double-beta-decaying nuclides, we selected ^{100}Mo for the AMoRE experiment because of its high transition energy ($Q_{\beta\beta} = 3034.40(17)$ keV [63]), relatively large natural isotopic abundance ($\delta = 9.82(31)\%$ [41]), and the encouraging theoretical predictions for the nuclear matrix-element [64, 65, 66, 67, 68, 69, 70, 71, 72]. As shown in Figs. 2.1 and 2.2, the $0\nu\beta\beta$ half-life for ^{100}Mo is expected to be relatively shorter than those for other candidate nuclei. It should be noted that hundreds of kilograms of the ^{100}Mo isotope can be enriched at a reasonable price by centrifugation methods [73].

The most precise measurement to-date of the ^{100}Mo $2\nu\beta\beta$ half-life was reported by the NEMO-3 experiment: $T_{1/2} = (7.11 \pm 0.54) \times 10^{18}$ years [74]. The best 90% confidence-level lower limits on the half-life for the $0\nu\beta\beta$ mode of ^{100}Mo are $T_{1/2}(0\nu\beta\beta) > 5.5 \times 10^{22}$ yrs from the ELEGANT V experiment [75], which used a 171 g sample of 94.5%-enriched ^{100}Mo , and $T_{1/2}(0\nu\beta\beta) > 1.1 \times 10^{24}$ yrs from NEMO-3, which used a 6.9 kg ^{100}Mo sample [32]. Both experiments used a spectroscopic (passive source) technique with tracking devices exposed to thin Mo foils. In both cases, the energy resolution was moderate (8% \simeq 12% FWHM) and the detection efficiency (11% \simeq 19%) was relatively low. AMoRE is using a calorimetric (source=detector) technique with active scintillating crystals that contain ^{100}Mo .

Several molybdate crystal scintillators that would allow for the realization of a high-detection-efficiency experiment have been identified. The most promising of these are ZnMoO_4 [54, 73, 76, 77, 78, 79, 80, 81], CaMoO_4 [82, 83, 84, 85], CdMoO_4 [86], PbMoO_4 [87] and Li_2MoO_4 [88, 89, 90]. Among these, CaMoO_4 crystal scintillators have the advantages of a high mass-fraction of molybdenum (48%), the highest scintillation efficiency (it is the only molybdate that scintil-

Year	Summary
2002	CaMoO ₄ idea for DBD, First CaMoO ₄ crystal was grown in Korea
2003	ITEP(Russia)-Korea collaboration on CaMoO ₄ R&D
2004	First conference presentation
2005-2007	1 st ISTC project for large CaMoO ₄ growing
2006	INR (Ukraine) joined the collaboration, CaMoO ₄ grown in Ukraine
2007	R&D on cryogenic readout techniques for CaMoO ₄ started
2008	2 nd ISTC project for enriched ^{48depl} Ca ¹⁰⁰ MoO ₄ growing
2009	AMoRE collaboration formed with institutions from 5 countries
2010-2011	^{48depl} Ca ¹⁰⁰ MoO ₄ crystal characterization and internal background studies
2012	ITEP group awarded 8.7M\$ for ^{48depl} Ca ¹⁰⁰ MoO ₄ production line R&D

lates at room temperature), and excellent low-temperature bolometric properties.

2.3 Development of CaMoO₄ crystal scintillators

Among the inorganic scintillating materials that contain Mo in the structural form of Scheelite or Wolframite, CaMoO₄ produces the largest amount of scintillation light at room temperature. We recognized the potential of CaMoO₄ crystals for a ¹⁰⁰Mo $0\nu\beta\beta$ decay search and started developing CaMoO₄ crystals in 2002, when the first CaMoO₄ crystal was grown with the Czochralski (CZ) technique in Korea. Discussions with V. Kornoukhov (ITEP, Russia) at the 4th International Conference on Non-accelerator New Physics (2003) led to a collaborative R&D program to study the application of ¹⁰⁰Mo-enriched CaMoO₄ crystals for a $0\nu\beta\beta$ -decay search experiment. Kornoukhov subsequently sent Russian-grown CaMoO₄ crystals to Korea for evaluation. This R&D program confirmed that CaMoO₄ is a promising material for a $0\nu\beta\beta$ search experiment and first results were presented in 2004 [91]. As part of these R&D activities, other molybdate crystals and cryogenic readout techniques were considered [82]. The INR (Ukraine) group led by F. Danevich was invited to join the CaMoO₄ collaboration in 2006. This group, which had already performed a sensitive experimental search using a CdWO₄ scintillating crystal [44, 92] that demonstrated the applicability of scintillation crystal techniques for $0\nu\beta\beta$ decay searches, added valuable operational experience to our team. Some CaMoO₄ crystals were produced at the Institute of Materials (IM), Lviv, Ukraine, and results from characterization and background studies of these crystals were published in Ref. [83].

These R&D efforts gained support from the International Science and Technology Center (ISTC), an intergovernmental organization connecting scientists from Russia and other countries of the Commonwealth of Independent States (CIS) with their peers in other countries, including Korea. Our first ISTC Project (#3293) was carried out between 2005 and 2007. A large, high-quality crystal (200 mm×30 mm×30 mm) was grown [93] and characterized [94]. Fig-

ures 3.3, 3.4 and 3.5 show photographs of CaMoO_4 crystals produced at different places. The initial CaMoO_4 crystals were produced by the Bank at Pusan National University, Korea. Subsequently, better quality and larger CaMoO_4 crystals were produced by the Innovation Center of the Moscow Steel and Alloy Institute (ICMSAI) in Moscow, Russia, while others were produced at the Institute of Materials (IM) in Lviv, Ukraine.

In 2007, a KRISS (Korea Research Institute for Standards and Science) group specialized in advanced detector development joined our collaboration and initiated the development of cryogenic techniques for reading out CaMoO_4 crystals; results from their initial studies were published in Ref. [84]. A second ISTC Project started in 2008 with the primary goal of growing a $^{48\text{depl}}\text{Ca}^{100}\text{MoO}_4$ crystal with 3 kg of ^{100}Mo -enriched and ^{48}Ca -depleted, radio-pure powders. Characterization and background studies of these crystals were reported in Ref. [95].

The AMoRE collaboration, with members from nine different institutions from five countries was officially formed in 2009. The collaboration has subsequently expanded to ~ 90 researchers from 17 institutions from eight countries. Recently, the Russian members of the AMoRE collaboration were awarded a \$8.7M (US) grant to support further development of large-scale quantities of ultra-low-background $^{48\text{depl}}\text{Ca}^{100}\text{MoO}_4$ crystals for the 200 kg phase of AMoRE.

2.4 AMoRE project - Parameters

The basic parameters of the AMoRE experiment are summarized as follows:

- $^{48\text{depl}}\text{Ca}^{100}\text{MoO}_4$ cryogenic scintillating detectors enriched in ^{100}Mo and depleted in ^{48}Ca
- ^{100}Mo enrichment $> 95\%$
- Operating temperature: 10-30 mK
- Energy resolution: 5 keV @ 3 MeV
- Individual detector-element mass: 0.5 kg
- Location: Y2L (Yangyang underground laboratory) 700 meter depth (AMoRE-pilot, AMoRE Phase I) & a new deeper underground laboratory (for AMoRE Phase II)
- Collaboration: 8 countries, 17 institutes, ~ 90 researchers
- Phases

	AMoRE-pilot	Phase I	Phase II
Mass of $^{48\text{depl}}\text{Ca}^{100}\text{MoO}_4$	1.5 kg	5 kg	200 kg
Background [counts/(keV·kg·year)]	10^{-2}	10^{-3}	10^{-4}
$T_{1/2}$ sensitivity [years]	3.2×10^{24}	2.7×10^{25}	1.1×10^{27}
$\langle m_{\beta\beta} \rangle$ sensitivity [meV]	210–400	70–140	12–22
Schedule	2015–2016	2016–2018	2018–2022

2.5 Sensitivity of AMoRE

The sensitivity for a $0\nu\beta\beta$ experiment is usually defined as the half-life level, $T_{1/2}^{0\nu}$, at which the expected signal would have the same strength as a 1σ fluctuation of the background level. For a source=detector arrangement, this is given by

$$T_{1/2}^{0\nu} = \ln 2 \times N_A \frac{a}{A} \varepsilon \sqrt{\frac{M \cdot t}{b \cdot \Delta E}} \times 10^3, \quad (2.1)$$

where N_A is Avogadro's number, a is the isotopic abundance, ε is the detection efficiency, A is the (dimensionless) atomic mass number of the decaying nuclide, M is the total detector mass of the nuclide of interest (in kilograms), t is the exposure time (in years), b is the background level in the signal region (in counts/keV/kg/yr) and ΔE is the energy window where the signal is expected, in keV (comparable to FWHM energy resolution). For the AMoRE experiment, where we aim for “zero-background¹,” the experimental half-life sensitivity can be expressed as:

$$T_{1/2}^{0\nu} = \ln 2 \times \frac{a \varepsilon N_A}{A} \frac{M \cdot t}{n_{CL}} \times 10^3, \quad (2.2)$$

where $n_{CL} = 2.4$ corresponds to a 90% confidence level. This expression gives a sensitivity that is, at least in principle, independent of both the background level and the detector resolution. In the following, the zero-background relation is used for the evaluation of the experiments, including those in the current proposal. Figure 2.3 shows the resulting $n_{CL} = 2.4$, 90% confidence level $0\nu\beta\beta$ half-life sensitivities *versus* time for 10 kg and 200 kg arrays of enriched CaMoO_4 . The effective Majorana neutrino mass ($\langle m_{\beta\beta} \rangle$) sensitivity as a function of data taking time is shown in Fig. 2.4.

Our strategy for achieving a large mass “zero-background” experiment includes the following considerations:

- Since the highest energy single- β/γ quanta from naturally occurring radio-nuclides is the 2615 keV γ -line from ^{208}Tl , we have focused on candidate $0\nu\beta\beta$ nuclides with $Q_{\beta\beta}$ values above this level. Our currently preferred nuclide is ^{100}Mo , which has $Q = 3034$ keV.
- Since most naturally occurring α emitters have $Q_{\beta\beta}$ -values above 3034 keV, we need powerful and reliable methods to distinguish α -induced signals from β/γ -induced signals. We have demonstrated that in CaMoO_4 crystals, the amount of scintillation light and the pulse-shape of the temperature signals provide two independent β/γ - α discriminators, each with a more than 5σ discrimination power.
- The effects of accidental time overlap of two low-energy signals combining to form one of higher energy (i.e., pileup) will be controlled by segmenting the detector array into ~ 400 g independent elements and by application of pulse-shape discrimination of randomly coinciding events.

¹Less than 0.1 events in the experimental region of interest

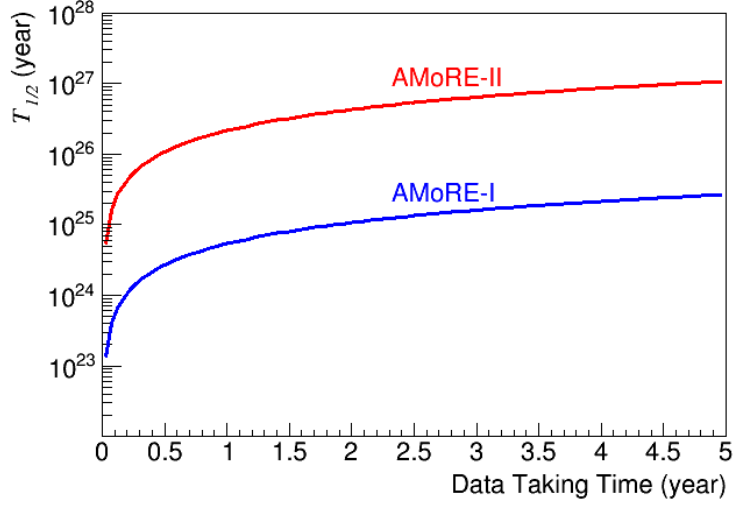

Figure 2.3: Expected half-life sensitivity for AMoRE-I and AMoRE-II as a function of running time.

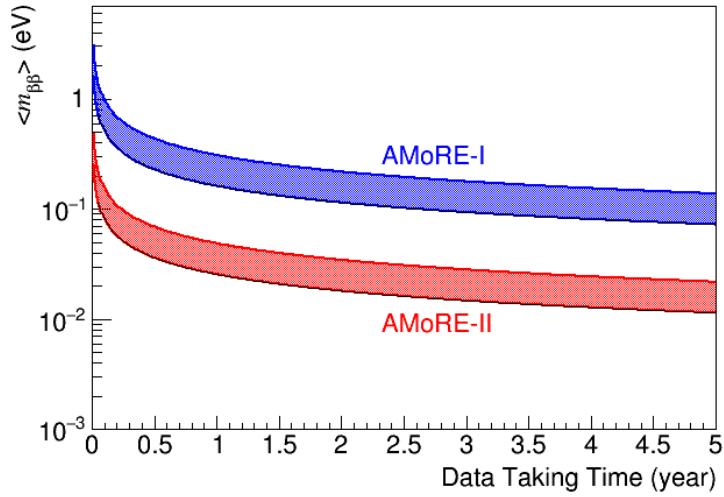

Figure 2.4: Effective Majorana neutrino mass ($\langle m_{\beta\beta} \rangle$) sensitivity vs. data taking time for AMoRE-I and AMoRE-II. The widths of the bands correspond to a range of nuclear matrix element calculations from Refs. [8, 14, 96].

- In the case of CaMoO_4 , background from $2\nu\beta\beta$ decay of ^{48}Ca will be reduced by using crystals produced from calcium depleted in ^{48}Ca .
- We will continue and expand our aggressive R&D program on reducing radioactive contaminations in the crystal powder preparation and growing procedures that was started over ten years ago.
- The levels of radioactive contaminants in all materials used in the detector, including the cryostat elements and the external-radioactivity shields, will be measured and their influence on the experiment will be carefully simulated.
- The experiment will be done in a series of phases where at each phase we will exploit what is learned from the previous one.
- The cosmic muon flux will be minimized by the underground location of the experiments and by installation of an active muon veto system.

As mentioned above, we plan to perform CaMoO_4 experiments in two phases. We are currently commissioning an array of five ^{100}Mo -enriched $^{48\text{depl}}\text{Ca}^{100}\text{MoO}_4$ crystals, with total mass of 1.5 kg in a cryostat located in the A5 area of Y2L, as an initial “pilot” experiment. We will start data-taking with this setup later this year (2015) and continue to take data for about a year. Using measured background rates in these detectors (as discussed below), we estimate a background rate in the $0\nu\beta\beta$ signal region of ~ 0.01 counts/keV/kg/yr and a half-life sensitivity of $T_{1/2}^{0\nu} > 1.1 \times 10^{24}$ yrs, which is comparable to the current world-best value from NEMO 3 [32]. While this pilot experiment is running, we will exploit the experience we gain from implementing, commissioning and operating it to prepare and assemble “AMoRE-I,” a ~ 5 kg array of CaMoO_4 crystals that will, when ready, replace the pilot array. Our goal for AMoRE-I is a background level on the order of 10^{-3} counts/keV/kg/yr and a $T_{1/2}^{0\nu}$ sensitivity for a two-year exposure of $\sim 8 \times 10^{24}$ yrs, which would correspond to an effective Majorana neutrino mass in the range of 0.07 eV – 0.14 eV (see Fig. 2.4), and could confirm or rule out the controversial $0\nu\beta\beta$ evidence reported by Klapdor. The next phase will be “AMoRE-II,” which will start with a 70 kg array of $^{48\text{depl}}\text{Ca}^{100}\text{MoO}_4$ crystals with a background level that is an order-of-magnitude below that for AMoRE-I is planned. As background conditions permit, we will increase the detector mass to as much as ~ 200 kg. The projected sensitivity of a five-year exposure with AMoRE-II would be $T_{1/2} \approx 1 \times 10^{27}$ years ($\langle m_{\beta\beta} \rangle \approx 20$ meV). Figure 2.5 compares the projected sensitivity with the inverted neutrino hierarchy region and existing limits. Such a sensitivity will require exquisite energy resolution and an order-of-magnitude improvement in background rejection power. Since the available space at the existing Y2L underground laboratory will not be sufficient to accommodate an experiment of this scale, we are proposing the development of a larger and deeper underground laboratory in Korea.

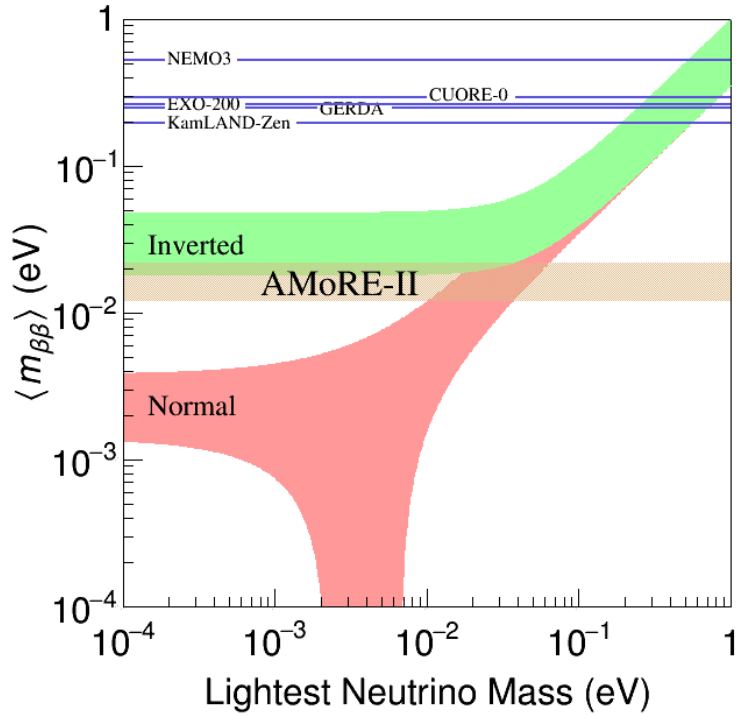

Figure 2.5: Effective Majorana neutrino mass ($\langle m_{\beta\beta} \rangle$) as a function of the mass of the lightest neutrino together with current limits on the mass from a selection of the most sensitive experiments [9, 10, 11, 12, 13], as compared with expectations for AMoRE-II with five years of data taking. To convert the experimental half life limits to $\langle m_{\beta\beta} \rangle$ limits, the products of $G_{0\nu}|M_{0\nu}|^2$ were chosen as the central values from the ranges given in [14]. For comparison with the inverted hierarchy region, the AMoRE-II band is shown using the full range of values.

Chapter 3

CaMoO₄ crystal scintillators

3.1 Production of high-purity crystals

The Czochralski crystal-growing technique is a universally used method for production of high-quality tungstate and molybdate crystals. For details see ref. [97], the very first review of this technique. For reviews of the history and status of the development of the Czochralski method see ref. [98]. A sketch of the Czochralski method is shown in Fig. 3.1; a photograph of an operational system is shown in Fig. 3.2. Natural CaMoO₄ occurs in nature as tetragonal-stolzite, scheelite-type, and monoclinic-raspite crystals. X-ray diffraction measurements of synthetic, Czochralski-grown CaMoO₄ crystals have been determined to be scheelite-type crystals with a tetragonal symmetry with a space group of $I4_1/a$.

Our initial CaMoO₄ crystals were produced in Korea at Pusan National University's Crystal Bank. Subsequently, larger and better-quality CaMoO₄ crystals were produced at the Innovation Center of the Moscow Steel and Alloy Institute (ICMSAI) in Moscow, Russia and at the Institute of Materials (IM) in Lviv, Ukraine (see Fig. 3.3).

An extensive R&D program on the optimization of growth techniques for the large-sized CaMoO₄ crystals was carried out in the framework of ISTC program #3293 [93]. As part of this program, crystals as large as 30×30×200 mm³ were successfully grown, as shown in Figs. 3.4 and 3.5. On the basis of this R&D program, we established crystal growing techniques that are satisfactory for the AMoRE experiment.

The technique for growing single CaMoO₄ crystals can be briefly summarized as a series of steps:

1. Raw material preparation:
 - Preparation of chemicals and chemical labware
 - Purification of Ca and Mo containing components
 - CaMoO₄ raw material synthesis, drying and calcination
2. Melting (compactization) of raw material
3. Initial Czochralski growing of raw CaMoO₄ single crystals

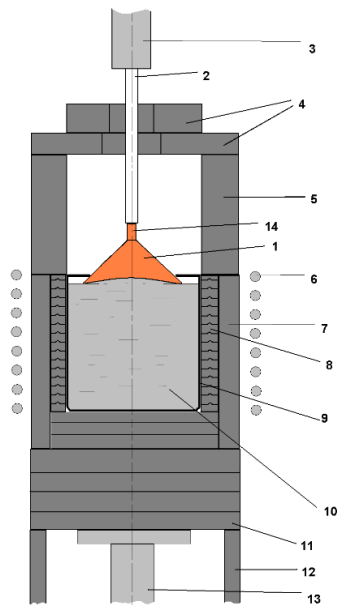

Figure 3.1: a sketch of a Czochralski crystal-growth system. 1– crystal; 2– seedholder; 3–main shaft; 4,5–heat insulation screens; 6–induction coil; 7,8,11– heat insulation ceramics; 9–crucible; 10–melt; 12–bottom support; 13– bottom shaft; 14–seed crystal



Figure 3.2: A photograph of a CRYSTAL-3M Crystal puller (at JSC Fomos-Materials).

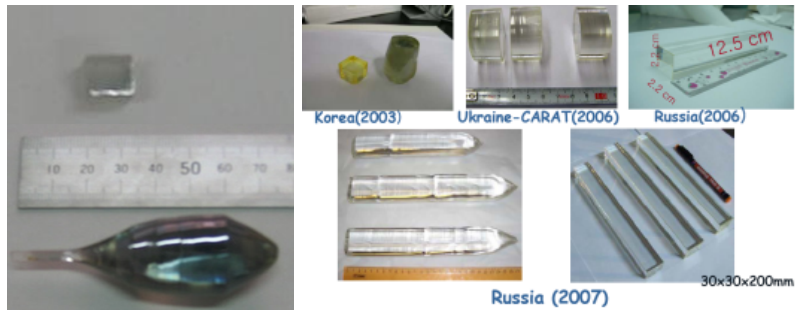

Figure 3.3: (left) The first CaMoO_4 crystal grown in Korea. (right) Various CaMoO_4 crystals grown in Korea, Ukraine and Russia.

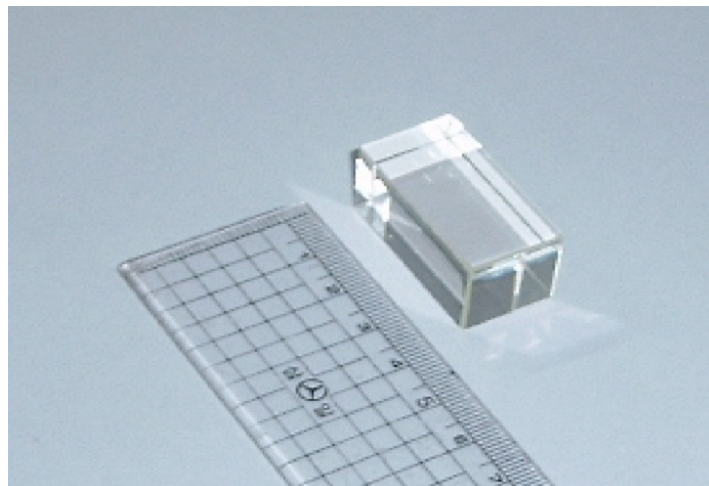

Figure 3.4: The first CaMoO_4 crystal from the ISTC project. Crystals with volumes as large as 15 cm^3 and light yields of ~ 400 photons/MeV were produced.

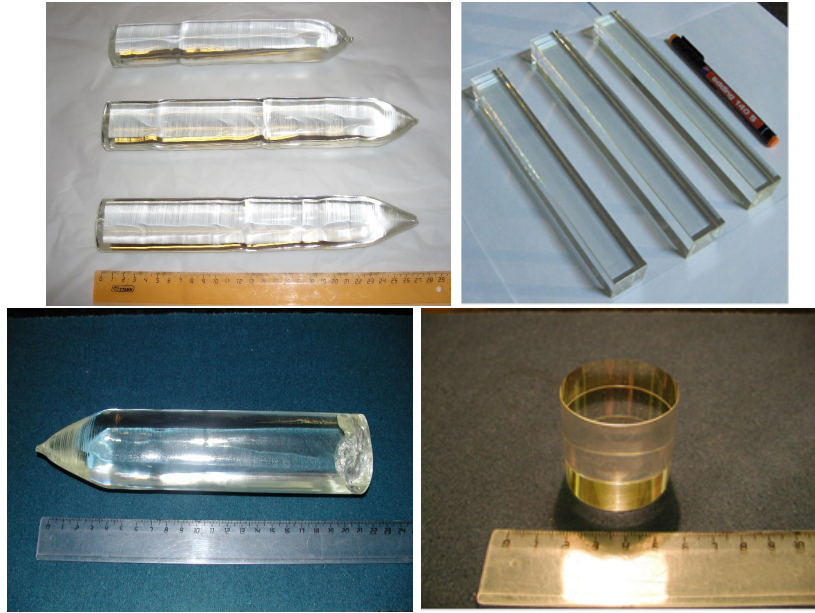

Figure 3.5: Crystals grown as part of ISTC program #3293 (Lead organization: ITEP (Moscow)).

4. Final Czochralski growing of CaMoO_4 single crystal and initial annealing
5. Principal annealing under high temperature in an oxygen atmosphere
6. Cutting, lapping and polishing to form the scintillation elements.

3.1.1 Synthesis of CaMoO_4 raw material

There are two well-known techniques to synthesize the CaMoO_4 raw material (charge):

1. solid-phase synthesis of the oxides (CaO and MoO_3) mixed in a stoichiometric ratio,
2. a co-precipitation reaction:

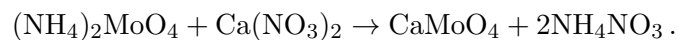

The advantages of the co-precipitation reaction are:

- a guaranteed stoichiometry of the crystal material;
- the possibility of including additional purification steps in the process;
- “the remains” of the reaction (NH_4NO_3) are easily removed by washing and heat treatment.

In the framework of the Russian government’s Federal Aiming Program (FAP), we used a different Ca-compound (calcium formate: $\text{Ca}(\text{HCOO})_2$) instead of $\text{Ca}(\text{NO}_3)_2$ because of its much higher purity [99].

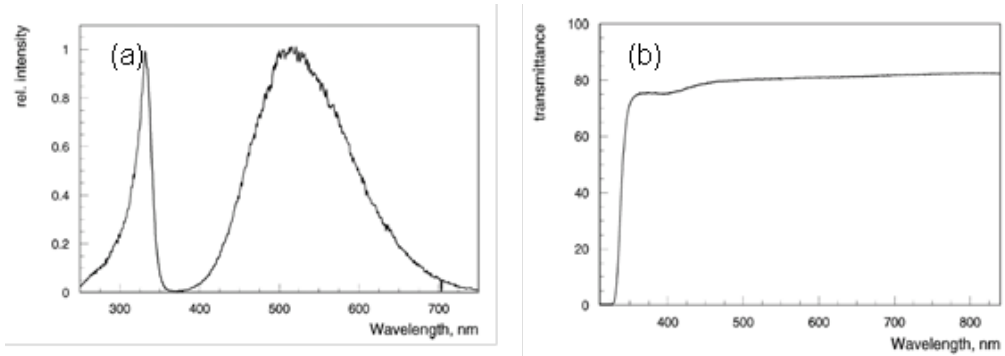

Figure 3.6: (a) The room temperature emission spectrum of a CaMoO₄ crystal. (b) The transmittance of the same CaMoO₄ crystal (also at room temperature).

3.1.2 CaMoO₄ crystal growth

The CaMoO₄ melting temperature ($T=1445^{\circ}\text{C}$) allows for the crystals to be pulled in normal atmosphere from crucibles made from platinum ($T_{\text{melt}} = 1769^{\circ}\text{C}$), or in an oxygen-free atmosphere from an iridium crucible ($T_{\text{melt}} = 2454^{\circ}\text{C}$). Both approaches were investigated during our preliminary tests. After analyses of the resulting samples, it was decided to use the first method and pull crystals from a platinum crucible with diameter 90 mm and height 70 mm. In these experiments, we also optimized the growth direction relative to the crystallographic axis of the crystal. The crystal structure consists of complex layers perpendicular to the c -axis. Each layer has a two-dimensional, CsCl-like cubic arrangement with a Ca cation and MoO₄ anion surrounded by eight ions of opposite sign (see Fig. 1 in ref. [100]). There are at least two optimal directions for the seeding and further growth of the CaMoO₄ crystal. Crystals of similar quality can be pulled in the directions close to the a - or the c -axis. The crystals grown along the a -axis exhibit an elliptically shaped cross-section with a ~ 1.3 ratio of maximal to minimal diameter. We found that by tilting the a -axis by ~ 25 degrees relative to the pulling direction, we were able to produce a nearly circular cross-section, having a diameter ratio of ~ 1.15 .

3.2 Luminescence and scintillation properties of CaMoO₄ crystals

3.2.1 Luminescence properties of CaMoO₄ crystals

The luminescence and transmission properties for some of the CaMoO₄ crystal samples were investigated. Figure 3.6(a) shows the excitation and emission spectra for one of the samples. The emission spectrum has a broad peak between 400 nm and 700 nm with a maximum at around 520 nm. Figure 3.6(b) shows the transmittance, which demonstrates that the crystal is highly transparent to the scintillation light.

Room-temperature, X-ray-induced emission spectra were measured with a

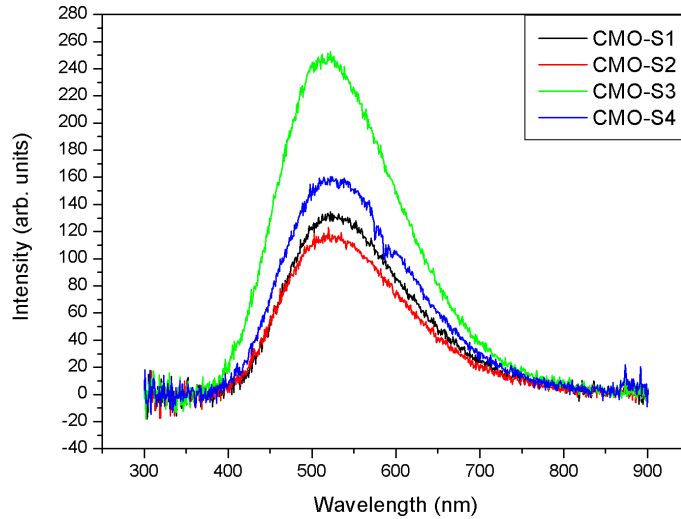

Figure 3.7: The room-temperature emission spectra for four different CaMoO_4 crystals.

QE65000 fiber optic spectrometer (Ocean Optics Co.). The luminescence spectra for different crystals are shown in Fig. 3.7. They all have broad emission bands in the 400 to 700 nm range with a peak emission at 520 nm, results that are in good agreement with the measured photo-luminescence spectrum. Although the light yields are different for different crystals, the shapes of the spectra are all quite similar.

3.2.2 Light yield measurements

Green-extended, three-inch RbC photocathode photo-multiplier tubes (PMT) (model D726Uk from Electron tube Ltd.) were directly attached to the test crystal surfaces. The RbC photocathode has a response that is well matched to the 520 nm peak emission of the CaMoO_4 crystals; the effective quantum efficiency (QE) is 14%.

Single photoelectron (SPE) signals can be identified at low energy by means of a 400 MHz FADC that is used to digitize the PMT output pulses. In scintillators with long decay times, the identification and counting of individual SPEs can reduce noise effects and improve the energy resolution. A typical CaMoO_4 response is shown in Fig. 3.8. We investigated the scintillation characteristics of the crystals by counting the number of SPEs detected during a 24 μs time window using an offline clustering algorithm that is specially developed to isolate SPEs [101, 102]. Scintillation light yields of various CaMoO_4 crystal samples from different manufacturers were tested. The number of detected SPEs measured for 662 keV γ -rays from a ^{137}Cs radioactive source ranged from 0.3 to 0.6 photoelectrons/keV, depending on the crystal. The light yield of one

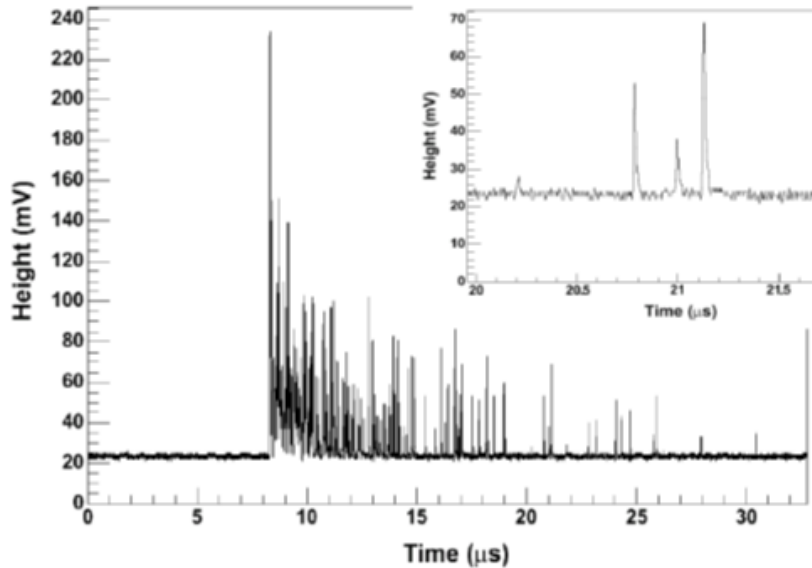

Figure 3.8: A typical CaMoO_4 signal pulse. The inset shows a time-expanded view of the $t \approx 20 \mu\text{s}$ region.

of the best-quality crystals was also measured at a temperature of 6°C . In this case, the FADC time window was extended to $82 \mu\text{s}$ because of the longer decay time for cooled crystals. For this cooled crystal, we obtained 1.04 photoelectrons/keV from ^{137}Cs radioactive source measurements. If only photoelectron statistics are considered, the energy resolution of this cooled crystal at the 3 MeV $0\nu\beta\beta$ endpoint of ^{100}Mo is inferred to be 4% FWHM.

3.2.3 Absolute light yield measurement

We also measured the number of electron-hole (e-h) pairs and the absolute light yield of some of the CaMoO_4 crystals with a UV-sensitive, windowless large-area avalanche photodiode (LAAPD) produced by Advanced Photonics Co. [103]. This has close to 80% quantum efficiency for visible and near-infrared photons. The number of e-h pairs and the absolute light yield of one of the best crystals were measured at room temperature. The sample crystal was optically coupled to the LAAPD that was read out by a spectroscopic amplifier with a $10 \mu\text{s}$ shaping time constant. The crystal was irradiated with 5.5 MeV α particles from a ^{241}Am source that produced a clearly identifiable peak; an α/β quenching factor (QF) of 0.20 was used for the light yield estimation. After calibration with an ^{55}Fe source, the number of e-h pairs of the crystal was determined to be $3,500 \pm 350$ e-h/MeV. This absolute light yield was adjusted to $4,900 \pm 490$ photons/MeV after correction for the light collection efficiency and losses in the Teflon reflector (90%). SPE signals from the PMT were also used to infer the absolute light yield, even though this method has more systematic effects that have to be considered [103]. The room temperature light yield obtained this way was $4,500 \pm 1,000$ photons/MeV.

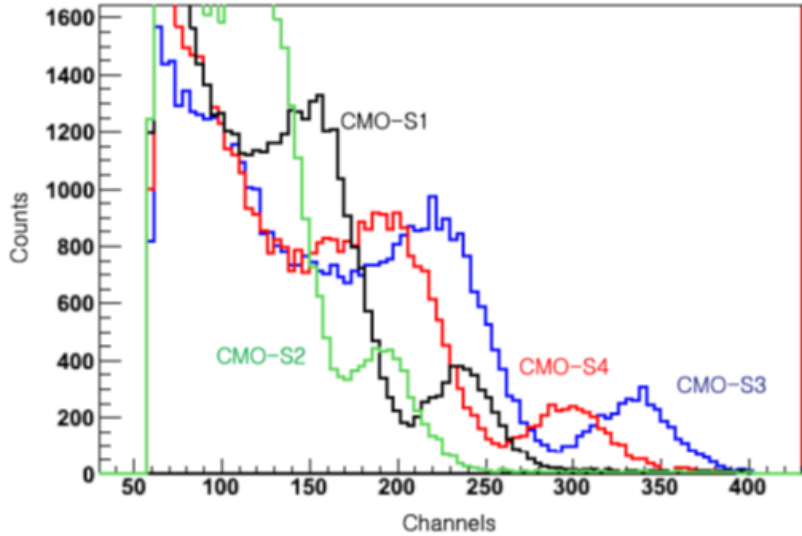

Figure 3.9: Responses of different crystals to 662 keV γ -rays from a ^{137}Cs radioactive source.

This large absolute light yield at room temperature, which is about 10% of that of the most efficient scintillating crystals such as CsI(Tl) , is sufficient to enable crystal-quality tests and radiopurity measurements to be carried out at ordinary temperatures. This greatly simplifies detector material development and manufacturing quality control during the production of large numbers of crystals.

3.2.4 Light yield comparison of different CaMoO_4 crystals

The relative light yields of small (1 cm^3) CaMoO_4 crystals produced in different places were compared using 662 keV γ -rays from a ^{137}Cs radioactive source (see Fig. 3.9). The crystal produced at IM shows highest light yield while the crystal produced at ICMSAI had the lowest light yields; these results are consistent with X-ray luminescence measurements. Crystals recently produced by ICMSAI show similar performance as the IM-produced crystals.

3.2.5 Room-temperature energy resolution of CaMoO_4 crystals

The energy resolutions of CaMoO_4 crystal samples from different manufacturers have been compared using 662 keV ^{137}Cs γ -rays. The room temperature energy resolutions of the tested crystals range between 10.3 to 14% FWHM. The best energy resolution was obtained with the IM-produced CaMoO_4 crystal as shown in Fig. 3.10 [83]. The energy resolution for the crystal measured at 6°C was 11.9%.

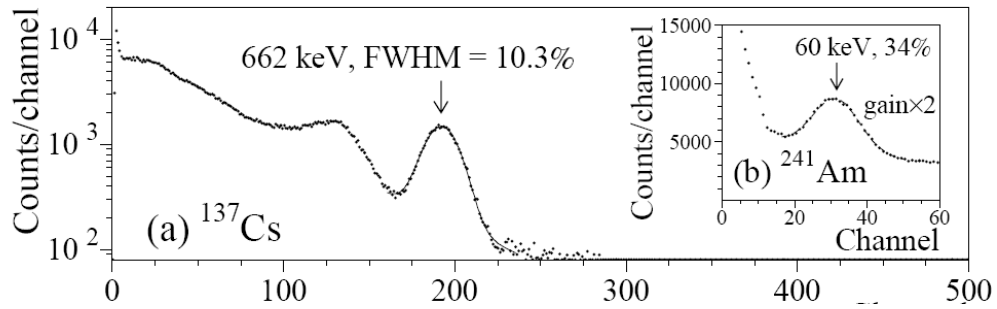

Figure 3.10: Response of the IM-produced CaMoO_4 crystal to a ^{137}Cs source. The inset shows the low-energy response of the same crystal to 60 keV γ -rays from a ^{241}Am source.

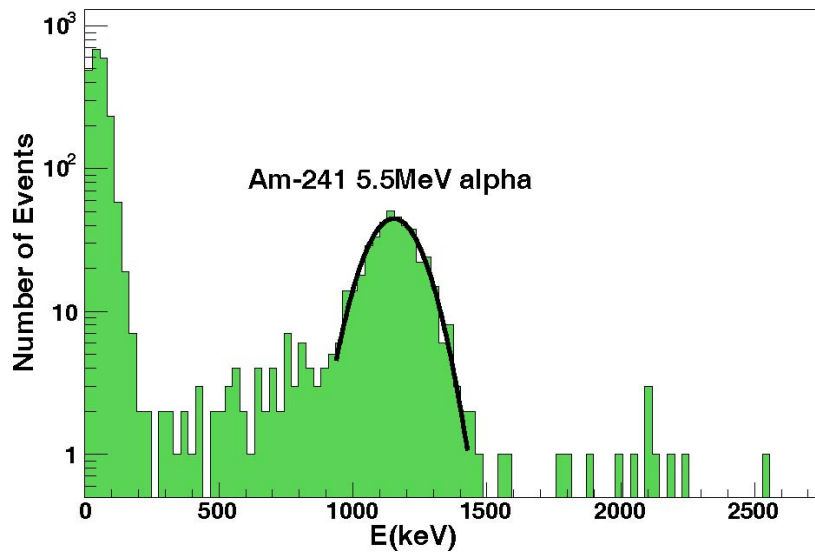

Figure 3.11: Response of a CaMoO_4 scintillator to 5.5 MeV ^{241}Am alpha particles. The energy scale was calibrated with γ rays.

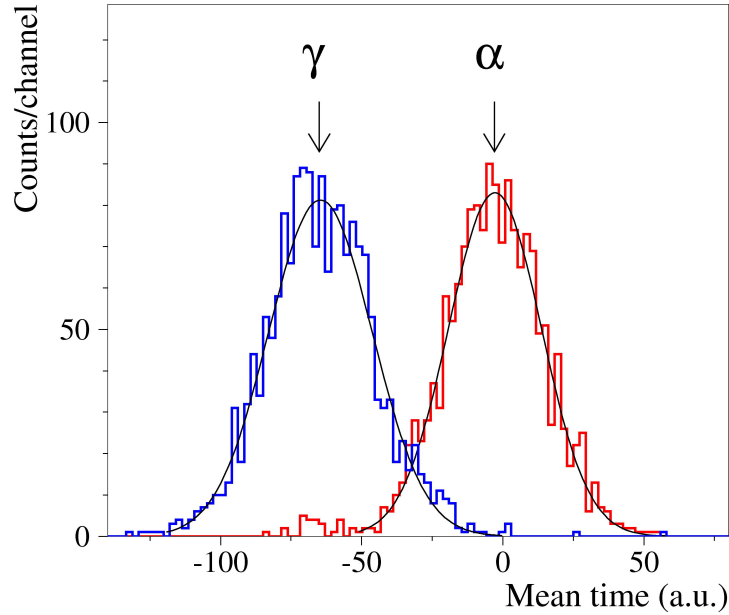

Figure 3.12: Mean-time distributions for alpha and gamma radiation.

3.2.6 Pulse shape discrimination (PSD)

Scintillation light signals from highly ionizing particles, such as alphas, usually have different light yields and decay-time characteristics than those produced by electron- and gamma-radiation-induced signals. The resulting pulse-shape differences can be used to separate α -induced signals from β/γ -ray-induced signals. Even though the 5.5 MeV alpha particles from a ^{241}Am source stop in the crystal, the visible energy that is recorded by the PMT is only about 20% of that for a γ -ray of the same energy, as shown in Fig. 3.11. This is referred to as the alpha-particle quenching factor. The decay time of alpha-induced signals is also quite distinct from that for γ -ray-induced signals. A simple energy-weighted mean-time was used to characterize the decay time of scintillation signals. The mean-time-determined Pulse Shape Discrimination (PSD) between alpha-induced and gamma-induced signals is demonstrated in Fig. 3.12 [83]. PSD is a powerful tool for rejecting backgrounds that are induced by alpha particles produced by contaminants from the U and Th decay chains.

3.2.7 Temperature dependence of the light yield of CaMoO_4 crystals

The temperature dependence of the relative light output and decay time of CaMoO_4 crystals was studied by Mikhailik et al. [104], as shown in Fig. 3.13. At liquid nitrogen temperatures, the light output is six times larger than at room-temperature. The scintillation efficiency at temperatures below 1K is not known and should be measured.

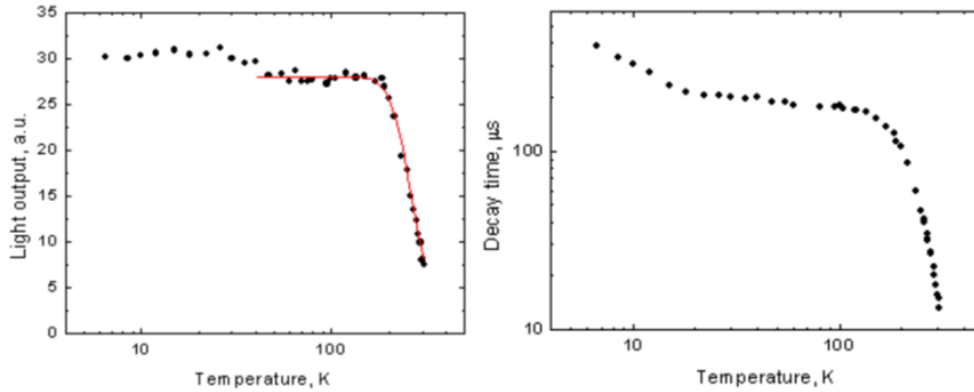

Figure 3.13: The temperature dependence of the light output (left) and decay time (right) of CaMoO_4 crystal scintillators [104].

The high detection efficiency and good energy resolution of CaMoO_4 crystal scintillators make them very suitable sources and detectors for $0\nu\beta\beta$ -decay searches. As mentioned above, successful experiments with CdWO_4 crystals [44, 92] demonstrated the applicability of scintillating crystal techniques for $0\nu\beta\beta$ -decay searches.

3.3 ^{48}Ca -depleted, ^{100}Mo -enriched $^{48\text{depl}}\text{Ca}^{100}\text{MoO}_4$ crystals

CaMoO_4 crystals produced from enriched ^{48}Ca could be also used to search for 0ν decays of ^{48}Ca . However, for AMoRE the $2\nu\beta\beta$ decay of ^{48}Ca poses an irreducible background. The natural abundance of ^{48}Ca is 0.187% and the half-life for $2\nu\beta\beta$ ^{48}Ca decay is 4.2×10^{19} yrs. Since the Q -value for ^{48}Ca is 4272 keV, this decay would produce a serious background counting rate in the $0\nu\beta\beta$ signal region for ^{100}Mo . For a CaMoO_4 crystal made with natural Ca, the background level from ^{48}Ca decay at the ^{100}Mo Q -value (3034 keV) would be 0.01 counts/keV/kg/yr. Therefore, the concentration of ^{48}Ca in the CaMoO_4 crystals has to be reduced by at least a factor of 100 to get its associated background below our ultimate, AMoRE-II, goal of 10^{-4} counts/keV/kg/yr.

A 4.5 kg quantity of ^{48}Ca -depleted ($\leq 0.001\%$) calcium carbonate powder with ICP-MS-measured ^{238}U and ^{232}Th contaminations below 0.2 ng/g and 0.8 ng/g, respectively, was produced by the Russian ElectroKhimPribor Integrated Plant (EKP). However, a γ -spectroscopy analysis of the $^{48\text{depl}}\text{CaCO}_3$ powder showed the specific activities due to ^{226}Ra and its progenies to be at the few hundred mBq/kg level. Therefore, this $^{48\text{depl}}\text{CaCO}_3$ material was subjected to additional purification.

A 8.25 kg quantity of ^{100}Mo -enriched (96%) molybdenum in the form of MoO_3 powder was produced by the JSC Production Association Electrochemical plant (Zelenogorsk, Russia) by a gas centrifugation technique. The enriched material is very pure with respect to radioactive elements: the results of ICP-

• **SB28**
weight 196 g



• **SB29**
weight 390 g

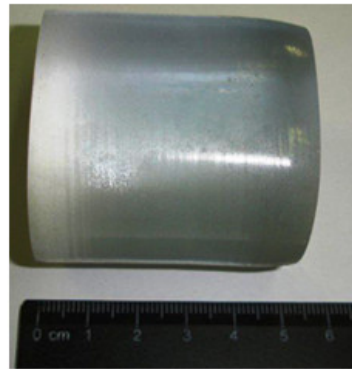

• **S35**
weight ~300 g



Figure 3.14: $^{48\text{depl}}\text{Ca}^{100}\text{MoO}_4$ crystals grown at the Innovation Center of the Moscow Steel and Alloy Institute (ICMSAI) in Russia.

MS measurements show that the concentrations of ^{238}U and ^{232}Th in the oxide are below 0.07 ng/g and 0.1 ng/g, respectively.

3.4 Growth of large radio-pure $^{48\text{depl}}\text{Ca}^{100}\text{MoO}_4$ crystals

The $^{48\text{depl}}\text{Ca}^{100}\text{MoO}_4$ crystal growing process includes the following stages:

1. initial powder ICP-MS analyses;
2. preparation of pellets – 550 g each;
3. initial charge for crystal growing preparation including a small mass excess of MoO_3 ;
4. growth of the initial crystallized charge - crystals up to 550 g each;
5. initial crystallized charge for final-crystal growing preparation;
6. crystallizer assembly and final-crystal growing;

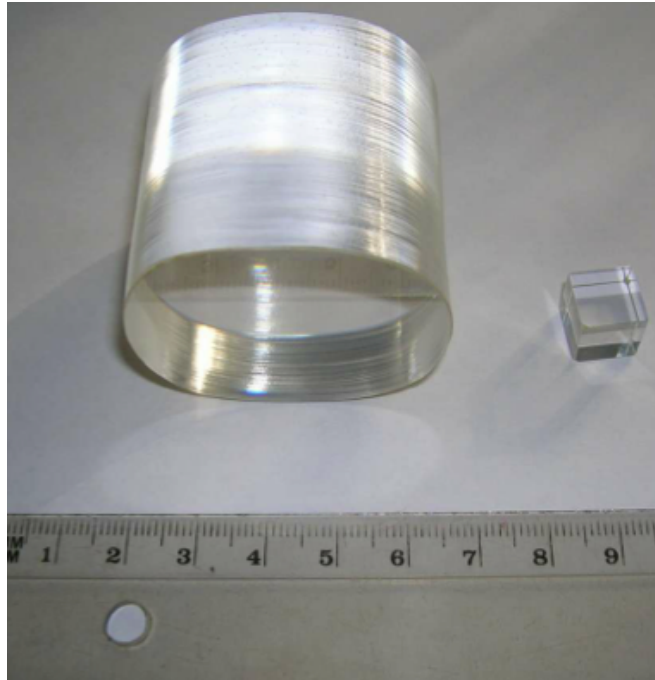

Figure 3.15: A $^{48\text{depl}}\text{Ca}^{100}\text{MoO}_4$ single crystal after annealing in oxygen and a cubic sample cut from the same crystal boule.

7. two crystal annealing procedures;
8. production of CaMoO_4 scintillation elements according to the mechanical specifications by cutting, lapping and polishing.

A commonly used technique for the synthesis of the CaMoO_4 raw material (charge) is the co-precipitation reaction discussed above. This reaction method offers some essential advantages, including the possibility of additional purification of the starting compounds and better control of the final-product stoichiometry. $^{48\text{depl}}\text{Ca}^{100}\text{MoO}_4$ crystals have been pulled by JSC Fomos-Materials (Russia) in air from a platinum crucible by means of the Czochralski technique. The technology of $^{48\text{depl}}\text{Ca}^{100}\text{MoO}_4$ single crystal production (the so-called double crystallization procedure, or re-crystallization) can be summarized as the following sequence of steps: the charge of $^{48\text{depl}}\text{Ca}^{100}\text{MoO}_4$ in powder form is heated to the melting temperature to convert it into pellets with density similar to the density of crystals; the pellets are loaded into a crucible, melted, and the raw crystal is pulled; raw crystals produced in this way are loaded into the crucible, melted again, and the final crystal is pulled.

The technology that was developed for the production of $^{48\text{depl}}\text{Ca}^{100}\text{MoO}_4$ single crystals can be summarized by the following sequence of consecutive steps:

1. The charge of $^{48\text{depl}}\text{Ca}^{100}\text{MoO}_4$ in powder form is loaded in crucible and heated to the melting temperature.

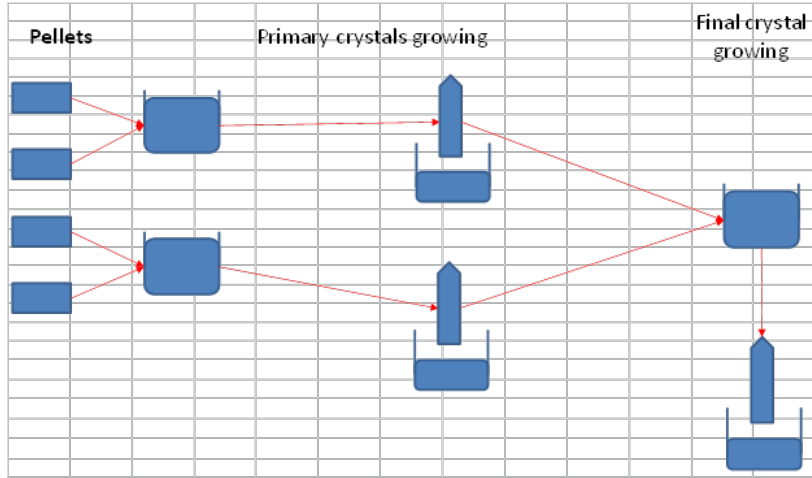

Figure 3.16: Crystal growth process scheme at Fomos Materials

2. The seeding starts at a rotation speed of $5 - 12 \text{ min}^{-1}$ and the raw crystal is produced at a high pulling speed ($3 - 5 \text{ mm/hr}$).
3. The resulting (raw) crystals are loaded into the crucible, melted and the final crystal is pulled at a slower speed ($2 - 3 \text{ mm/hr}$).
4. The produced crystal is subjected to initial annealing heat treatment while still in the setup for 12 hours.

The $^{48\text{depl}}\text{Ca}^{100}\text{MoO}_4$ crystals produced in this way have an elliptic cylindrical shape with major and minor diameters of $45 \sim 55 \text{ mm}$ and $40 - 50 \text{ mm}$ respectively, lengths of $40 - 60 \text{ mm}$ (from an original overall length of $\sim 100 \text{ mm}$), and a total mass of $\approx 0.55 \text{ kg}$.

The possible evaporation of MoO_3 during the crystal growth can result in the formation of defects. The best possible optical transparency and light output are ensured by growing the crystals from recrystallized raw materials with an approximate 1.0% mass-excess of MoO_3 added to the charge. The as-grown crystal has a notoriously strong blue coloration due to oxygen depletion and a deficiency of Mo^{6+} ions (see Fig. 3.14). It has been demonstrated that this coloration can be removed by prolonged annealing in an oxygen atmosphere [82, 104]. Almost transparent $^{48\text{depl}}\text{Ca}^{100}\text{MoO}_4$ crystals were obtained after the annealing (see Figs. 3.14 and 3.15). The crystal growth process developed by Fomos Materials is shown in Fig. 3.16.

3.5 Radioactive contaminants in CaMoO_4 crystal scintillators

3.5.1 Low-background setup at Y2L

Radioactive contamination levels in the CaMoO_4 crystals were studied in a specially designed low-radiation setup at the Yangyang Underground Laboratory

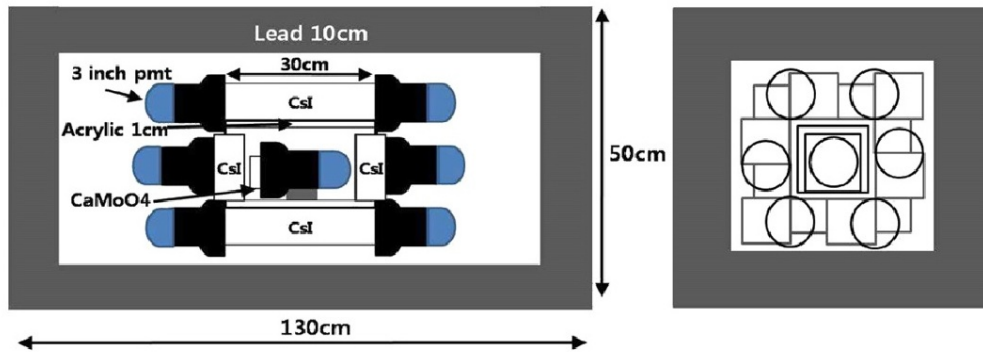

Figure 3.17: A schematic drawing of the CsI(Tl)-crystal shield 4π -veto cavity.

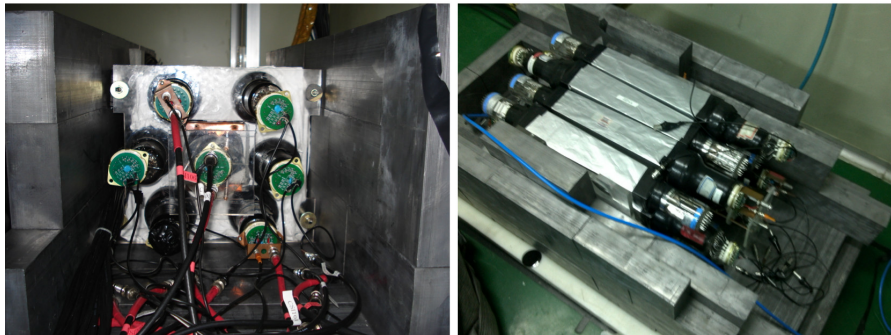

Figure 3.18: The 4π CsI(Tl) active shielding structure at the Y2L laboratory.

(Y2L).

The CaMoO_4 crystals being tested were fixed by an acrylic support inside a cavity in an array of CsI(Tl) crystal scintillators that are used to veto external gamma and neutron radiation and residual cosmic muons. The CsI(Tl) crystals that are used to form the “barrel” region of the cavity are trapezoidal with a length of 30 cm, a larger area of $6.5 \text{ cm} \times 6.5 \text{ cm}$, and smaller area of $5.5 \text{ cm} \times 5.5 \text{ cm}$. Twelve crystals that are read out by twelve, 3-inch PMTs form the barrel. For the data reported here, each PMTs was attached to a pair of crystals, forming an interleaved zigzag pattern at the end of the array, in which each PMT monitored two crystals, and each crystal was monitored by two PMTs, one at each end. The two end-cap regions were covered by crystals that each have only one readout PMT, as shown in Fig. 3.17. The CsI(Tl) crystal veto array was surrounded by a 10 cm thick passive lead shield. The acrylic cavity was flushed with a Nitrogen gas flow of 4 L/min in order to eliminate ambient radon [84]. Photographs of the 4π -veto system are shown in Fig. 3.18.

Recently, this 4π -veto system was upgraded to improve the veto efficiency. Now each of the twelve crystals in the barrel section have their own pair of PMTs that are distinct for each crystal. In addition, a 20 cm thick polyethylene shield was placed outside of the lead shielding to attenuate external neutron backgrounds.

Table 3.1: Summary of decays of short-lived isotopes and their coincident progenitor decays in the ^{238}U , ^{235}U and ^{232}Th decay chains.

	^{232}Th family (^{228}Th sub-chain)	^{235}U family (^{227}Ac sub-chain)	^{238}U family (^{226}Ra sub-chain)
Progenitor Isotope (prompt decay)	^{220}Rn Q = 6.40 MeV $T_{1/2}$ = 55.6 s	^{219}Rn Q = 6.95 MeV $T_{1/2}$ = 3.96 s	^{214}Bi Q = 3.27 MeV $T_{1/2}$ = 19.9 min.
Short-lived daughter isotope (delayed decay)	^{216}Po Q = 6.91 MeV $T_{1/2}$ = 0.145 s	^{215}Po Q = 7.53 MeV $T_{1/2}$ = 1.78 ms	^{214}Po Q = 7.83 MeV $T_{1/2}$ = 164 μs

Radioactive contamination of the ^{100}Mo -enriched S35, SB28, NSB29 and SS68 crystals by thorium and radium was studied. As indicated in Figure 3.14, the SB28, SB29 and S35 crystals were grown at ICMSAI. Since the transmittance of SB29 was poor, it was re-annealed at Fomos Materials and the crystal was re-named as NSB29. To avoid the need for a re-annealing procedure to cure a possible oxygen deficiency, the SS68 crystal was grown with a low-level doping of Nb. The data were analyzed with the time-amplitude method described in the following section. The method selects fast sequences of $\beta - \alpha$ decays in the ^{238}U chain and $\alpha - \alpha$ decays in ^{232}Th chain. Background data were accumulated for more than 70 days for the S35 crystal and 40 days for the SB28 crystal. The data were taken in the Y2L 4π -gamma veto system, which severely attenuated external backgrounds.

3.5.2 Contamination of CaMoO_4 crystals by thorium and radium.

The time-amplitude analysis method enables the identification of subchains containing short lived isotopes in the ^{232}Th , ^{235}U and ^{238}U chains. Because of the very low counting rates, the probability of signals from two uncorrelated decays to occur in a small time interval is quite low. Thus, time correlations between consecutive events can provide unambiguous signatures for specific isotopes (see Table 3.1). In these analyses pulse-mean-time PSD results are also used to distinguish between β -induced and α -induced events.

As can be seen in Table 3.1, Polonium isotopes in the decay chains have relatively short half-lives. After a Po nuclei is produced via Bi, Rn or Bi decays, it quickly decays to Pb with a characteristic lifetime. Figure 3.19 illustrates the terms used below and their definitions.

For example, to identify ^{214}Po in ^{238}U decay chain, we examine a 100 μs to 600 μs time window after a detected β -decay. If this β originated from $^{214}\text{Bi} \rightarrow ^{214}\text{Po}$ beta decay, this time interval includes 57.6 % of subsequent $^{214}\text{Po} \rightarrow ^{210}\text{Pb}$ alpha decays. Thus, most of the alpha decay events that occur in this time window should have a kinetic energy that is equal to the 7.83 MeV Q -value for $^{214}\text{Po} \rightarrow ^{210}\text{Pb}$ alpha decay and a tag-time distribution should display a 164 μs ^{214}Po -lifetime dependence.

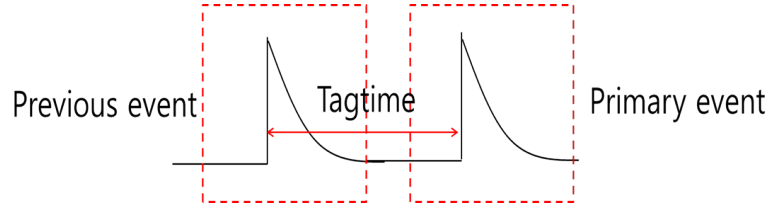

Figure 3.19: Time difference between two signals.

Table 3.2: Radioactive contamination of ^{48}Ca -depleted, ^{100}Mo -enriched CaMoO_4 crystals by ^{227}Ac , ^{226}Ra and ^{228}Th . All units are in $\mu\text{Bq/kg}$. For comparison data are also shown for the CaMoO_4 crystal produced by IM (Lviv, Ukraine) with natural isotopic composition. It should be stressed that the IM crystal was produced with no special attempts to purify the initial materials from radioactive contamination.

	^{228}Th ^{232}Th Chain	^{227}Ac ^{235}U Chain	^{226}Ra ^{238}U Chain
SS68	30 ± 5	200 ± 14	60 ± 8
NSB29	80 ± 9	700 ± 26	200 ± 14
S35	500 ± 22	1200 ± 35	4400 ± 66
IM (Lviv, Ukraine)	230 ± 15	90 ± 10	1500 ± 39
SE1	50 ± 15	60 ± 8	40 ± 12
SB28	70 ± 8	—	80 ± 9

Using selection efficiencies that were computed by GEANT4 simulations, we converted the measured ^{215}Po (^{235}U chain), ^{214}Po (^{238}U chain), and ^{216}Po (^{232}Th chain) decay rates to contamination levels in the ^{48}Ca -depleted, ^{100}Mo -enriched CaMoO_4 crystals that are currently on hand, namely SS68, NSB29, S35 and SB28. The results are listed in Table 3.2. The measured contamination levels of crystal S35 are relatively high, so we now use it as a control sample to estimate the alpha/beta discrimination efficiency.

Chapter 4

Cryogenic particle detection

Cryogenic particle detectors have been developed in response to the need for detectors with superior energy resolution and ultra-low thresholds in nuclear and particle physics. Recent developments of these detectors have demonstrated energy resolution and threshold performance levels that exceed the extreme limits of conventional semiconductor-based detectors. Cryogenic detection techniques have been adopted for rare-event searches and have become important measurement tools for many other applications [105].

In general, the energy deposited in matter by the interaction of radiation with the atoms in matter can be converted into measurable effects such as ionized charged particles, scintillation light, and phonons. The ionization can be measured by collecting the charges with an applied electric field. Scintillation light is, at least in principle, easily measured with photon sensors such as photomultiplier tubes or photo-diodes. However, the major portion of the energy deposition is converted into the phonons. This suggests that phonon measurements can be more effective than ionization or scintillation measurements.

However, the accurate measurement of phonons created by particle or radiation absorption is not trivial, particularly at room temperatures, since huge numbers of phonons exist naturally in any condensed material, with a statistical frequency/energy distribution that is determined by the temperature of the material. When an absorber is thermally attached to a heat reservoir the thermal energy of the absorber fluctuates, resulting in a phonon distribution that changes with time. These thermal fluctuations can easily overwhelm the phonons created by radiation absorption. At low temperatures, however, the available thermal energy (i.e., the heat capacity) is greatly reduced, as are the fluctuations. Moreover, because the heat capacity of the absorber is typically lower at low temperatures, the resulting temperature increase caused by radiation-induced energy is increased.

The intrinsic energy resolution of the detector is determined by the fluctuations of the produced quanta in the energy-loss process. The energy needed to produce an electron-hole pair or a scintillation photon is typically a few to 10 eV. However, in the phonon measurement case, the average energy of a phonon at a temperature T is about $k_B T$ where k_B is the Boltzmann constant. At 10 mK, $k_B T$ is close to 10^{-6} eV.

In the case of a thermal detector attached to an ideal temperature measurement device, statistical fluctuations in the thermal energy limit the intrinsic resolution. If the total thermal energy of a detector with a heat capacity C is approximated as CT , the average number of energy quanta can be expressed by $N \approx CT/k_B T$. Thus, the statistical thermal noise or the ultimate limit on the energy resolution due to thermal energy fluctuations is $(\delta E)_{\text{rms}} \approx CT(N)^{1/2} \approx (k_B T^2 C)^{1/2}$. For a 1 kg CaMoO_4 detector at $T=10$ mK, the fluctuation limit on the resolution is about 20 eV (FWHM).

4.1 Principle of thermal detection in low temperature calorimeters

When a particle interacts with a solid-state absorber, its energy is transferred to the electrons and nuclei in the material of the absorber. Most of this transferred energy is eventually converted into the thermal energy of the solid. If a suitable thermometer is attached to the absorber, the temperature change caused by the initial energy transfer can be measured. Typical low temperature calorimeters consist of two parts: one is an absorber to make initial interactions with the particles; the other is a temperature sensor that measures the temperature change of the absorber. Usually, the absorber and the temperature sensor are in good thermal contact, while one of them is connected to a thermal reservoir, or heat bath, by a weak thermal link. The bath should have a sufficiently large heat capacity so that its temperature, typically well below 1 K, does not change with time.

One of the commonly used temperature sensors for low temperature calorimeters is the thermistor, which is a critically doped semiconductor operating at a temperature that is near, but below, its metal-insulator transition. Neutron transmutation doped (NTD) Ge thermistors are commonly used for low-temperature, rare-event searches. The thermistors are fairly easy to use because they can be operated with conventional electronics, such as Field-Effect Transistors (FETs), and do not require sophisticated superconducting electronics. They are typically current-biased and radiation-induced voltage changes across the thermistor are amplified with a FET located at a higher temperature level. NTD Ge sensors are widely used as thermal detectors for various crystals because of their reproducibility and their uniformity in doping density. Mass production of NTD sensors is also possible. The CUORE, LUCIFER and LUMINEU double-beta experiments all use NTD Ge thermistors as their temperature sensors.

Transition Edge Sensors (TESs) are one of the most highly developed type of cryogenic thermometers. A TES is a superconducting strip operating at its superconducting-normal transition temperature. The superconducting strip is often made from a thin pure superconducting film (W) or from a bilayer of superconductor and a noble metal, such as Mo/Au, Mo/Cu or Ti/Au. The transition temperature width of the films is typically a few mK or less. The resistance in the normal state is usually a few tens of $m\Omega$. Well developed devices have a very sharp transition with a transition width that is narrower

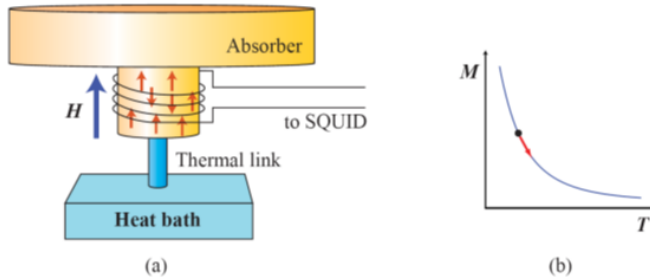

Figure 4.1: (a) A simplified MMC setup with an absorber. (b) Typical M-T characteristics of an Au:Er sensor in a magnetic field. Energy input into an absorber results in a change in the magnetization of the MMC sensor attached to the absorber.

than 1 mK. Thus, at the transition, a small change in temperature produces a large change in resistance. This makes it a very sensitive thermometer, but one that only works in a very narrow range of operating temperatures.

One advantage of using a TES for particle detection is that the superconducting sensor can be directly evaporated on to the surface of an absorber. This direct contact provides an efficient heat transfer from the absorber to the TES, and this results in a much faster response time for TESs than that for NTD sensors. It is also suitable for detecting athermal phonons that directly deposit their energy in the sensor. TESs have been used as the temperature sensor for the CDMS and CRESST dark-matter search experiments.

4.2 Magnetic Metallic Calorimeter (MMC)

Metallic Magnetic Calorimeters (MMCs) utilize a magnetic material whose magnetization is a function of temperature. The sensor material is a gold alloy with small concentration (100-2000 $\mu\text{g/g}$) of erbium, denoted as Au:Er. The diluted magnetic ions in the metallic host have paramagnetic properties that can be approximated as a spin 1/2 system with a Lande g value of 6.8. The magnetization is inversely proportional to the temperature, a simple paramagnetic relation known as Curie's law. This means that a measurement of magnetization can be used to measure the temperature of a paramagnetic material. This makes a magnetic thermometer attached to an absorber effectively a "magnetic calorimeter" for particle detection. Au:Er maintains its paramagnetic properties at tens of mK temperatures. A simplified MMC setup is illustrated in Fig. 4.1.

In early applications of MMCs for particle detection, the Au:Er sensor was placed inside the loop of a SQUID. In this early design, the SQUID loop itself was used as a pickup coil [106]. The state-of-the-art development of SQUID technologies guaranteed an accurate and fast measurement of the magnetization change with low noise for any temperature change caused by energy absorption. The SQUID converts the change of magnetic flux into a measurable voltage signal on the basis of a quantum interference measurement operating at low

temperatures.

The detection principle of an MMC can be characterized as $E \rightarrow \Delta T \rightarrow \Delta M \rightarrow \Delta \Phi \rightarrow \Delta V$, where E, T, M, Φ and V indicate the physical quantities of energy, temperature, magnetization, magnetic flux and voltage, respectively. An MMC setup with a two-stage SQUID system achieved an energy resolution of 1.6 eV FWHM for X-rays from a ^{55}Fe source in Heidelberg [107]. This detection method has recently been adopted by KRISS for MeV-region alpha spectrometry and Q -spectrometry measurements for radionuclide analysis. Moreover, MMCs permit the investigation of the thermal properties of crystal absorbers and the detectors' responses to a wide range of energy inputs because of their superior energy resolution, fast response time, and flexible operating temperatures and magnetic fields. By choosing the dimensions of the temperature sensor and the concentration of the magnetic material in it appropriately, the detector can be scaled up to a large mass because an optimal detector design that minimizes the energy-sensitivity degradation caused by the larger heat capacity can be easily achieved [106].

A meander-type MMC sensor has been developed to be used with an absorber with a large heat capacity [108, 109]. This “meander-type” MMC was first tested with a $2 \times 2 \times 0.07 \text{ mm}^3$ gold foil. The volume of the metal absorber is smaller than typical dimensions of crystal absorbers. However, the heat capacity of this absorber is 0.2 nJ/K and 0.4 nJ/K at 10 mK and 20 mK, respectively, while a 60 cm^3 CaMoO_4 crystal has heat capacities of 0.17 nJ/K and 1.4 nJ/K at these same temperatures. The performance of the detector is shown in Fig. 4.2. In measurements with an external ^{241}Am alpha source, this detector had a measured energy resolution of 1.2 keV FWHM for 5.5 MeV alphas. This resolution, which was inferred from a fit with a Gaussian-width function that takes source straggling effect into account by means of exponential convolutions, was the best measured resolution ever reported for an ^{241}Am alpha spectrum. Moreover, simultaneously, the lower-energy 60 keV gamma line was clearly seen, along with other low energy X-ray and conversion-electron lines. The resolution of the 60 keV gamma line was 400 eV FWHM. These measurements indicate promising possibilities for high performance applications of the MMC technique with large absorbers, with very good energy resolution over a very wide dynamic range.

4.3 Phonon measurement with large CaMoO_4 crystals

An early stage of MMC development for the AMoRE project used an 0.6 cm^3 CaMoO_4 crystal to test the applicability of the medium for use in a $0\nu\beta\beta$ search [84]. This successful experiment showed simultaneous good detector performance in both the keV and MeV energy regions. The next experiment used a larger crystal absorber corresponding to a factor of 80 volume increase. A cylindrical CaMoO_4 crystal, 4 cm in diameter and 4 cm in height, and a mass of 220 g, was instrumented with a meander-type MMC sensor similar to the one described in the previous subsection. Figure 4.3 shows pictures of the detector setup. The crystal was mechanically supported by 12 Teflon-coated phosphor-

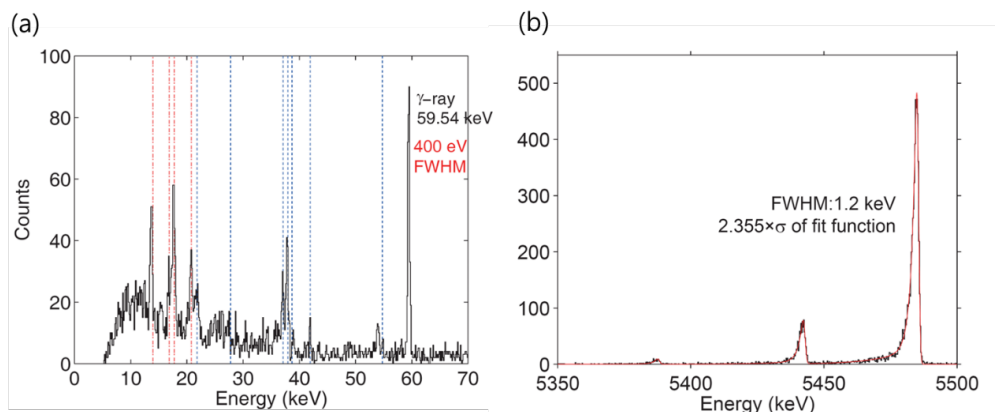

Figure 4.2: The ^{241}Am spectrum for an MMC setup with a gold foil absorber. (a) The below 70 keV low-energy spectrum. (b) Alpha peaks in the 5.5 MeV region. The resolution at 60 keV is of 0.4 keV FWHM. The vertical lines in (a) indicate the expected positions of low energy X-ray and conversion electron lines [109].

bronze springs (one was eventually not used in order to accommodate the meander and SQUID chip). In order to make a good thermal connection between the crystal and the temperature sensor, a gold film was evaporated on one of the flat crystal surfaces. Annealed gold wires were attached between the film and the Au:Er section of the meander chip. A meander-type pickup loop for the MMC sensor was connected to the input pads of a current-sensing dc-SQUID. The measurement circuit formed a superconducting loop that produced a current change in response to a temperature-rise-induced magnetization change in the MMC sensor. Details of the experimental setup are described in [110].

The low temperature measurement with the MMC and the crystal was carried out with a dilution refrigerator in a surface-level laboratory. The cryostat of the refrigerator was surrounded by a 10-cm-thick lead shield (with an open top) to reduce environmental gamma-ray background.

The rise time of the MMC signals was about 1 ms at 40 mK for both electron- and alpha-induced events, with a slightly faster rise time for alphas. When irradiated with an external ^{232}Th source, the 2615 keV peak was 11 keV wide (FWHM); the 583 keV peak width was 6.5 keV (FWHM) [110].

The two-dimensional scatter plot in Fig. 4.4(a) shows the distribution of signal height versus the mean-time pulse-shaping parameter MT, where MT is equivalent to the one-dimensional center-of-mass of the pulse when its shape is treated as the density function of a 1-D object. The pulses in the distribution can be grouped into two distinct event types according to their MT values. The horizontal band of signals above $\text{MT}=7.3$ ms is produced by electrons and gammas incident on the CaMoO_4 crystal. These β/γ events include signals generated by cosmic-ray muons passing through the crystal and environmental gamma ray backgrounds. The group of signals below the cosmic-ray muons are produced by alpha particles.

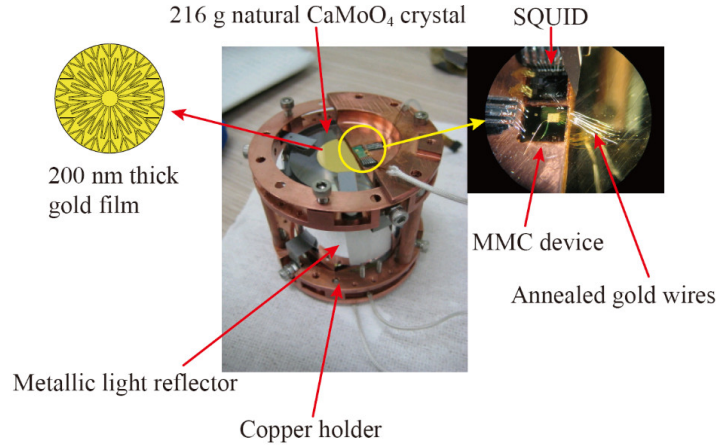

Figure 4.3: A CaMoO_4 detector setup with an MMC phonon sensor.

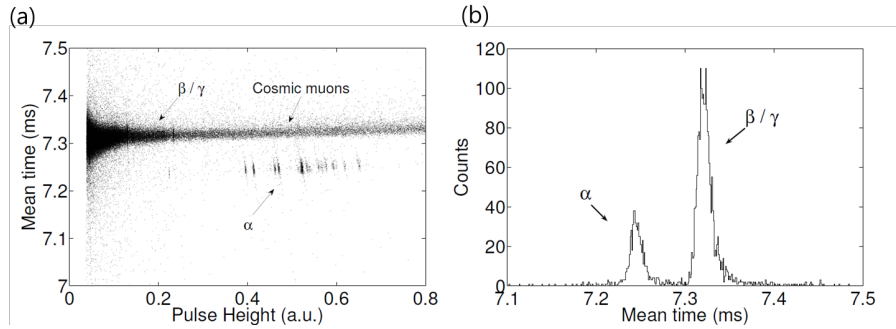

Figure 4.4: (a) A scatter plot of the mean-time *vs* pulse height obtained from a 95 hr background measurement in a surface laboratory. α and β/γ (including cosmic muons) events are clearly distinguishable by their mean-time values. (b) The mean time distribution in the 4 – 5 MeV region of alpha-equivalent energy [110].

The distribution of MT parameters in the 4 – 5 MeV region of alpha-equivalent energies has two distinct peaks as shown in Fig. 4.4(b). The $\alpha - \beta/\gamma$ discrimination power was determined to be 7.6σ by fitting each peak with a normal Gaussian function, although small high-mean-time tails are noticeable on the right-hand sides of each peak. These results indicate the pulse shape discrimination with high separation power can be realized with phonon signals only.

4.4 Development of low-temperature photon sensors

Two of the most important parameters that characterize a scintillating bolometer are the light yield and scintillation quenching factor. An MMC-based light sensor is being developed by our group in order to explore/exploit indications that the

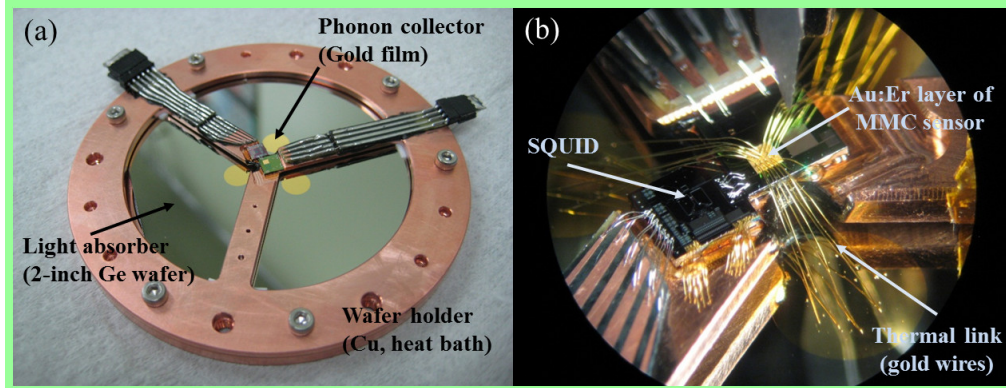

Figure 4.5: (a) The prototype cryogenic photon detector. The bottom side of the wafer faces a CaMoO_4 crystal to measure scintillation light produced therein. (b) A magnified image near the center of the detector [111].

low-temperature QF-based light-phonon separation power of CaMoO_4 detectors will be superior due to their large light output.

The images in Fig. 4.5 show a completed light sensor, in which a two-inch diameter, 0.5-mm-thick polished Ge wafer is used as a photon absorber. The wafer was fixed with three small Teflon clips at its edge that were clamped with two flat copper rings. The top ring had three spokes in the middle, whereas the bottom ring (not visible in the photograph) had an open hole for light collection.

The performance of the light detector was investigated in a surface-level cryogen-free adiabatic demagnetization refrigerator (ADR). The ADR cryostat was surrounded by a 5-cm-thick lead shield. Two sets of experiments were performed using ^{55}Fe and ^{241}Am radioactive sources. With the ^{55}Fe source, an energy resolution with $\text{FWHM} = 545$ eV was obtained for 6 keV X-rays. The temperature-dependence of the ^{241}Am source's 60 keV gamma-induced signal sizes was studied.

As the operating temperature of the light detector was decreased, the 60 keV signal sizes increased, as shown in Fig. 4.6a. This is expected because the wafer heat capacity decreases and the MMC sensitivity increases with decreasing temperatures. However, the signal rise times are found to be almost constant at about 0.2 ms for all of the measured temperatures as shown by the pulses normalized by their maximum pulse height in Fig. 4.6b. Heat-flow via athermal phonons is likely responsible for the temperature-independent time constant. Photon signals from MMC have a faster rise-time than that for phonons, which should increase the efficiency for distinguishing real events from random overlapping events, which will be serious backgrounds for AMoRE, especially random coincidences of $2\nu\beta\beta$ ^{100}Mo decays.

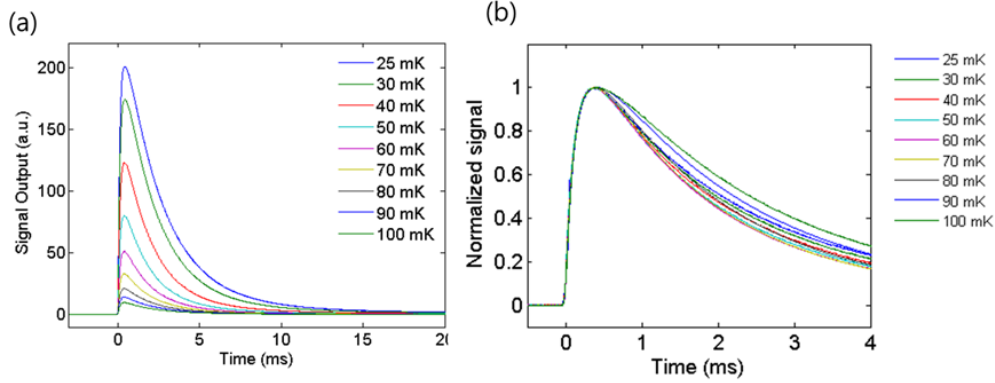

Figure 4.6: (a) Typical 60 keV gamma ray signals at various ADR temperatures. (b) The same signals normalized by maximum pulse height. The temperature-independent rise-time is $\simeq 0.2$ ms [111].

4.5 Simultaneous measurement of phonon and photon signals

Simultaneous measurements of phonon and photon signals were made using combinations of the phonon and photon detectors described in the previous sections. These were done in a dilution refrigerator located in a surface-level laboratory. A doubly enriched $^{48\text{depl}}\text{Ca}^{100}\text{MoO}_4$ crystal (SB28) with a mass 196 g was used as the absorber. The optical properties of this crystal and its internal background levels from room-temperature measurements are described in Chapter 3.

A copper sample-holder for the elliptical cylindrically shaped crystal has a rectangular-prism shaped structure, as shown in Fig. 4.7a. The phonon collector is located on the bottom surface of the crystal shown in the image. The photon detector described in the previous section was placed on the top of the crystal to measure the scintillation light (see Fig. 4.7b). A light reflecting foil covers all sides of the sample holder other than the top surface.

Figure 4.8a shows a two-dimensional scatter plot of the signal sizes from the two sensors. Roughly four groups of signals appear in the simultaneous measurement. Cosmic-ray muons passing through the Ge wafer and the CaMoO_4 crystal produce the upper horizontal band in the scatter plot; the cosmic-ray-induced photon-sensor signals were saturated by the muon energy deposits. Environmental backgrounds that are absorbed only in the photon detector produce the vertical band near zero phonon signal sizes. The β/γ events absorbed in the CaMoO_4 crystal show a linear relation between the two signal sizes. Muons passing through the CaMoO_4 crystal but not the Ge wafer, extend this β/γ event behavior to higher energies. Alpha-induced signals also show a linear relation between the two sensors but with smaller light signals than those for β/γ signals. These relative differences of the phonon and photon signals for alpha and β/γ events can be clearly seen in Fig. 4.8b, where the ratio of the two sensors are plotted. A separation power of 8.6σ for signals over a wide region of

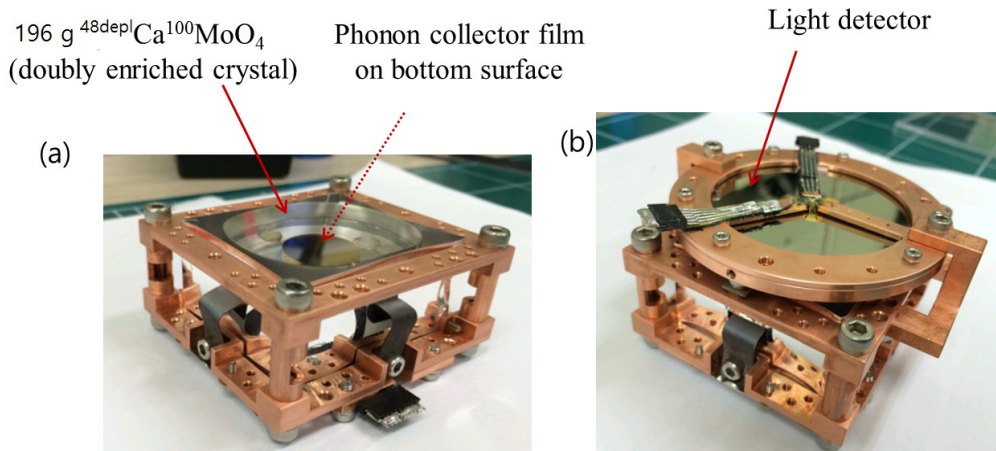

Figure 4.7: The setup for simultaneous measurements with phonon and photon sensors. (a) The phonon collector and MMC sensor are located on the bottom of the CaMoO_4 crystal; (b) the Ge light-photon detector is placed on the top.

alpha-equivalent energies ($4 \text{ MeV} < E_\alpha < 7 \text{ MeV}$) is found.

There is a clear light-yield difference between α - and β/γ -induced events in the CaMoO_4 crystal. This effect, together with PSD from the phonon sensor alone, will provide a powerful tool for attaining our goal of a “zero background” $0\nu\beta\beta$ decay search experiment.

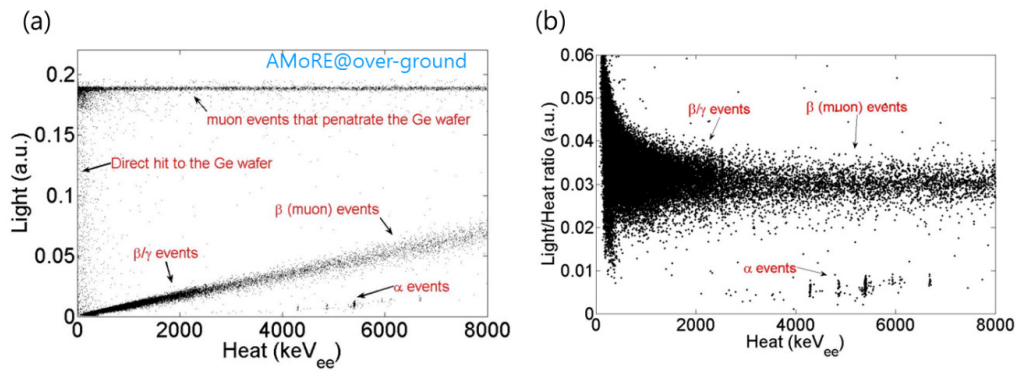

Figure 4.8: Surface-level phonon-photon measurements with the 196 g $^{48\text{depl}}\text{Ca}^{100}\text{MoO}_4$ bolometer in coincidences with a Ge-based light detector. (a) A two-dimensional scatter plot of signal sizes from the two sensors. (b) The signal size ratios; α - and β/γ - (including cosmic muons) induced events are clearly separated.

Chapter 5

Experimental design

5.1 Overview

We have recently completed the assembly of the “AMoRE-Pilot” experiment that consists of an array of the five $^{48\text{depl}}\text{Ca}^{100}\text{MoO}_4$ R&D crystals that are currently on hand, with a total mass of approximately 1.5 kg. The goals of AMoRE-Pilot are: a better understanding of the background conditions; gain experience with the assembly and operation of the experiment; and reach the current state-of-the-art level of $0\nu\beta\beta$ half-life sensitivity for ^{100}Mo . After about a year of data taking, we will move to the first phase of the experiment, dubbed AMoRE-I, that will consist of approximately 5 kg of $^{48\text{depl}}\text{Ca}^{100}\text{MoO}_4$ crystals in the same cryostat and shielding as AMoRE-Pilot with modifications based on what we learn from our experience with the Pilot run. This will start at the beginning of 2017 and will run for about three years. During this time, we will continue to pursue our vigorous program of R&D on the deep purification of CaMoO_4 and studies of other candidate crystals. Based on our R&D studies and our experience with the early AMoRE-I data, we will make decisions on the crystal production and procurement for the second phase, AMoRE-II. This phase of the experiment will start in early 2020 with about 70 kg of crystals instrumented in a new, larger cryostat situated in a new, deeper laboratory. This will be subsequently upgraded in mass to a maximum of 200 kg if the background levels are low enough to warrant this.

5.2 AMoRE-Pilot

5.2.1 Experimental arrangement

Figure 5.1 provides a schematic view of the cryostat interior for the AMoRE-Pilot experiment that has been assembled and is currently being commissioned. The cryostat has five different temperature stages and two separate vacuum chambers. The 4K stage defines the boundary between the inner and outer vacuum volumes. The cryostat is surrounded by an external, 15-cm-thick lead shield in the low-temperature room in the A5 tunnel of Y2L.

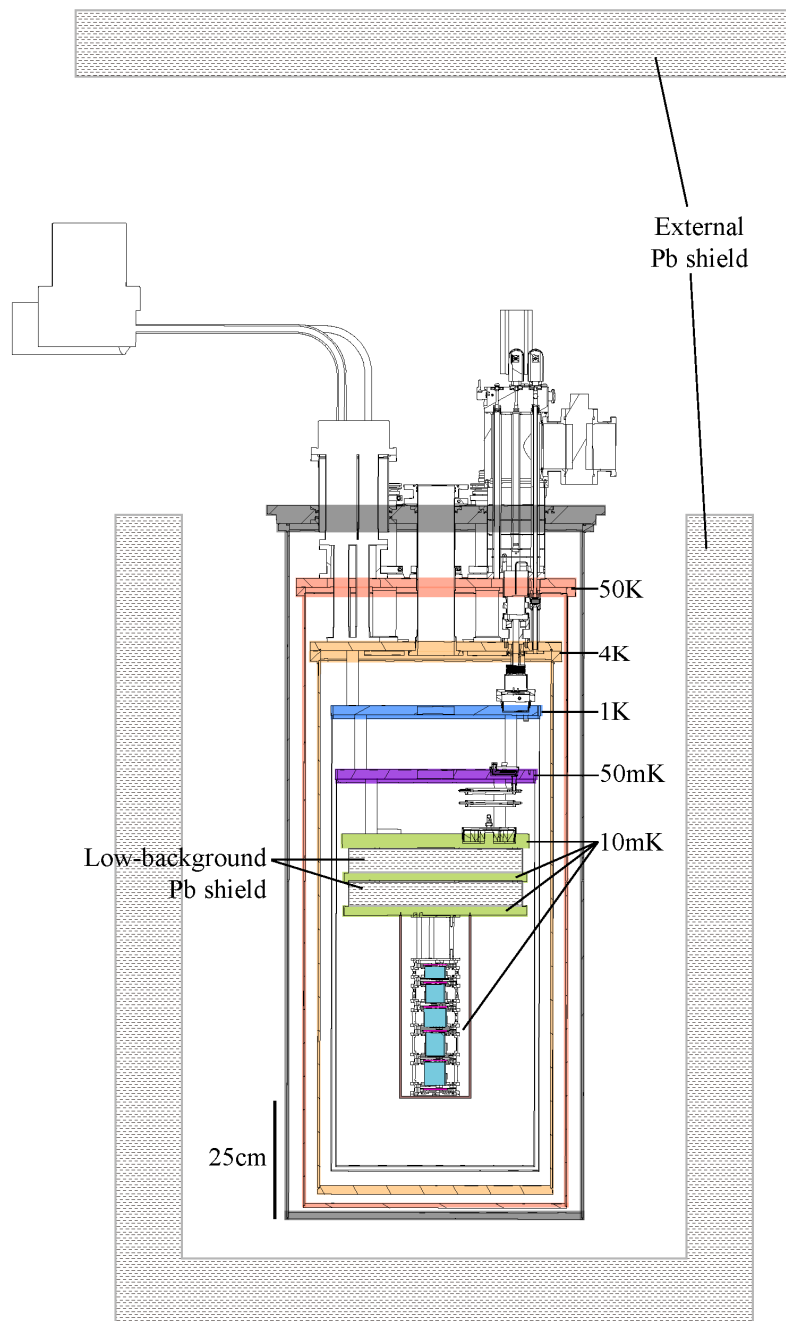

Figure 5.1: A schematic view of the AMoRE-Pilot experimental arrangement.

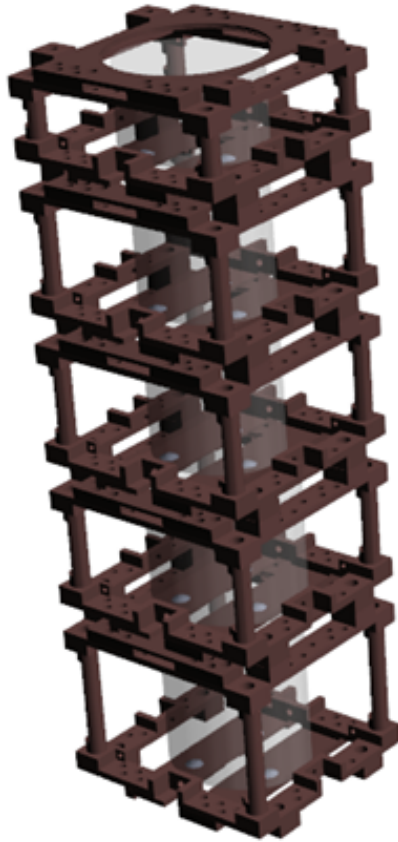

Figure 5.2: A schematic view of the AMoRE-Pilot array of crystals with copper holders.

The AMoRE-Pilot and the AMoRE-I experiments use the same dilution refrigerator with a cooling power of 1.4 mW at 120 mK and a base temperature of 10 mK. The refrigerator can cool and maintain a CaMoO_4 crystal array with a total mass as large as 10 kg at temperatures as low as 10 mK. A pulse-tube-based cryo-cooler is used to bring the system down to 4 K, cooling the leak-tight inner vacuum chamber walls, the CaMoO_4 crystals, and the inner shielding to 4 K by helium heat-exchange gas. The AMoRE-Pilot array of 300 – 400 g crystals with their copper frames (see Fig. 5.2) is located in the dilution refrigerator’s mixing chamber where the base temperature can be brought down to as low as 10 mK. A sketch of the Pilot crystal array is shown in Fig. 5.2 and the individual crystal dimensions and masses are listed in Table 5.1.

The dilution refrigerator’s mixing chamber is shielded from background radiation from the outer stainless-steel walls of the cryostat by a 1-cm-thick assembly of four concentric copper cylinders that surround the bottom and sides of the array as shown in Fig. 5.1. Radiation from radioactive contaminants in the upper layers of the cryostat are attenuated by a double layer of 5-cm-thick, 40-cm-diameter disks of low-background lead (total mass $\simeq 150$ kg) mounted on a

Table 5.1: The dimensions and masses of the AMoRE-Pilot $^{48\text{depl}}\text{Ca}^{100}\text{MoO}_4$ crystals.

	SB28	NSB29	S35	SS68	SS81
Height (mm)	25.5	51	40	40	52
Major axis (mm)	49.5	50	45	53	45
Minor axis (mm)	40.5	42.5	40	47.2	41
Mass (g)	196	390	256	352	354

Table 5.2: The measured radioactivity for the internal shielding lead.

^{210}Po [Bq/kg]	Total α rate [$\text{cm}^{-2}\text{h}^{-1}$]	Total γ from U, Th, K and Cs [mBq/kg]
(0.30 ± 0.08)	0.01	< 7.4

1-cm-thick low-background copper plate that is supported from the lowest temperature stage of the cryostat. The CaMoO_4 crystal detector array is encased in a 2-mm-thick cylindrical structure made from the same low-background lead. This cylinder, which is superconducting at the operating temperature of the experiment, shields the detector from external magnetic fields. An additional magnetic shield is provided by two layers of mu-metal placed between the cryostat's outer vacuum vessel and the external lead radiation shield (not shown in Fig. 5.1). This magnetic shielding is necessary for reducing possible electronic noise that is produced in the detector's readout wires from ground-vibration-induced wire motions.

5.2.2 Inner shielding

The lead shielding that is inside the cryostat is designed to reduce backgrounds due to scattered gammas from the gap of the external shield and from radioactive contaminants of the cryostat components, such as electrical wires, cooling pipes, and other sources from the upper layers of the cryostat. Two layers of standard-thickness lead bricks from ancient lead taken from sunken Roman ships that was purchased from and machined by LEMER PAX in France are used; the total lead thickness is 10 cm. The supporting disk is made from 1-cm-thick OFHC copper plate with U/Th levels below 50 pg/g. The radioactivity levels in the ancient lead were measured underground in the Modane laboratory in France and are listed in Table 5.2.

5.2.3 Outer shielding

The cryostat is situated inside a supporting structure made from steel H beams, as shown Fig. 5.3. This structure supports an array of cosmic-ray veto scintillation counters and an external shield formed from a total of 15 tons of lead bricks that attenuate gammas from the surrounding environment such as the rock walls of the A5 cavity. The main lead-shielding structure sits on a 3-mm-thick stainless-steel bottom plate and surrounds the bottom and sides of the

cryostat with transverse dimensions of $1.5 \times 1.1 \text{ m}^2$ and a height of 1.75 m. The structure is built in two halves that can be independently moved apart to provide access to the cryostat. The top is covered by a separate lead ceiling at the top of the support structure, with a gap between it and the sidewall shield for electrical wires and cooling pipes that run from the cryostat to the readout and cooling control systems elsewhere in the experimental hall (see Fig. 5.4). The transverse dimensions of the top lead shield are determined to be sufficient to prevent any external gamma to have an unshielded, direct path to the crystal array.

The shield is assembled from standard-sized lead bricks, dimension of $50 \text{ mm} \times 100 \text{ mm} \times 200 \text{ mm}$, that were purchased from JL Goslar GmbH in Germany. They were cleaned and machined by a local company in Korea. The total thickness of the external lead shield is 15 cm. The ^{232}Th and ^{238}U contents in the brick were measured to be 3.8 pg/g and 6.9 pg/g, respectively, with an Inductively-Coupled-Plasma Mass Spectrometer (ICP-MS). The ^{210}Pb activity was measured to be $(59 \pm 6) \text{ Bq/kg}$ at PTB (Physikalisch-Technische Bundesanstalt) in Germany.

Cosmic-ray Muon Veto Counters

The top and sides of the external lead shield are surrounded by a cosmic-ray muon veto system based on 5-cm-thick plastic scintillators. Each scintillator panel (EJ-200 by Eljen Company) is coupled to 2 inch PMTs via light guides as shown in Fig. 5.5. The muon-veto scintillation counters are installed on the outside of the shielding structure as shown in Fig. 5.6.

5.3 AMoRE-I

The AMoRE-I experiment will use about 5 kg of double enriched $^{48\text{depl}}\text{Ca}^{100}\text{MoO}_4$ detectors (about 15 crystals). The crystals are under preparation by the Fomos-Materials company in Russia. A schematic view of the planned crystal array is shown in Figure 5.7 for a 10 kg configuration. With this system, 5 kg of natural CaMoO_4 crystals may be used together with the 5 kg of enriched crystals.

The cryostat and the shielding structure will be the same as AMoRE-Pilot experiment; our current intent is to phase from AMoRE-Pilot to AMoRE-I experiment by adding more crystals from Fomos Materials. We plan to begin the AMoRE-I experiment in 2017. The main purpose of the AMoRE-I experiment is to verify that the background levels are consistent with a zero-background environment. At the same time, we will finalize the crystal choice for the AMoRE-II experiment, that is, whether we will use CaMoO_4 crystals for the next phase or switch to another molybdate crystal, such as ZnMoO_4 or Li_2MoO_4 crystal scintillators. The decision will be made while we run the AMoRE-I experiment.

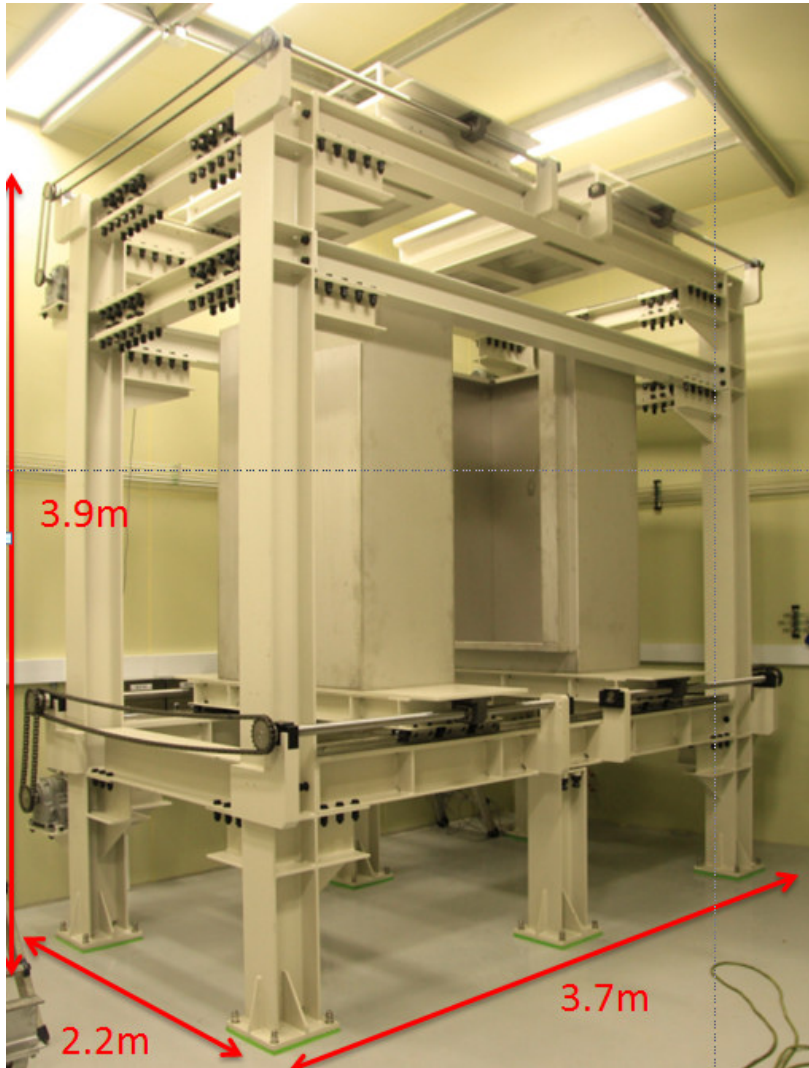

Figure 5.3: The support structure for scintillating counters, external lead shielding and cryostat.

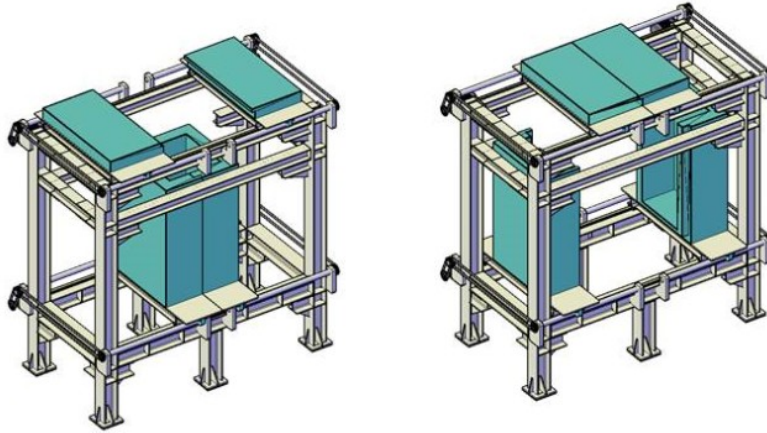

Figure 5.4: The lead-shielding structure. The top (left) and main (right) structure can slide in and out independently.

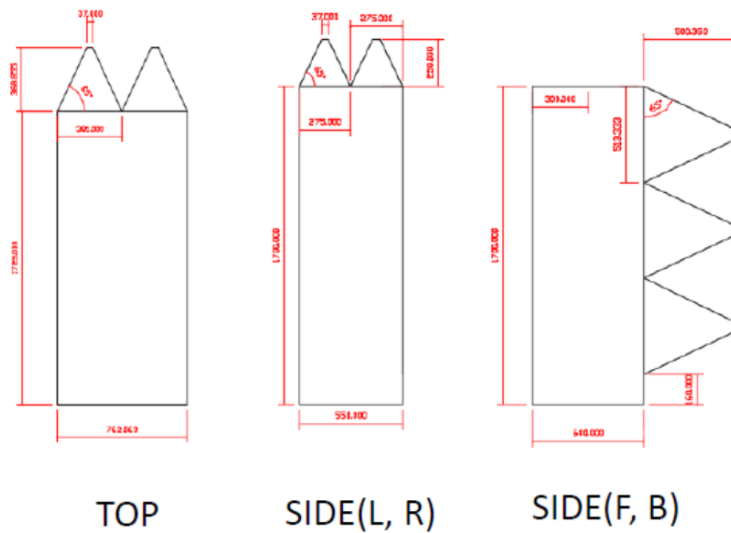

Figure 5.5: Different sizes of plastic scintillators that cover the shielding structure.

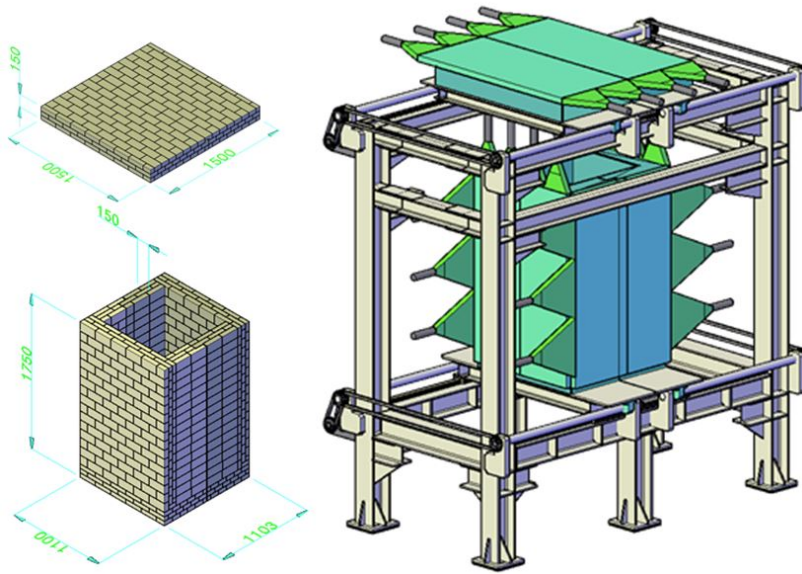

Figure 5.6: A schematic view of the muon veto system.

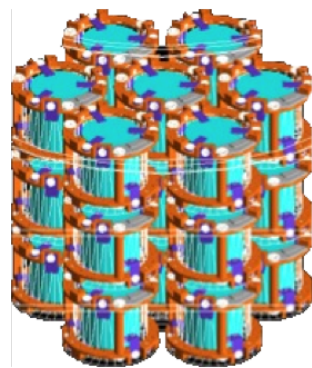

Figure 5.7: A schematic view of a possible AMoRE-I crystal array.

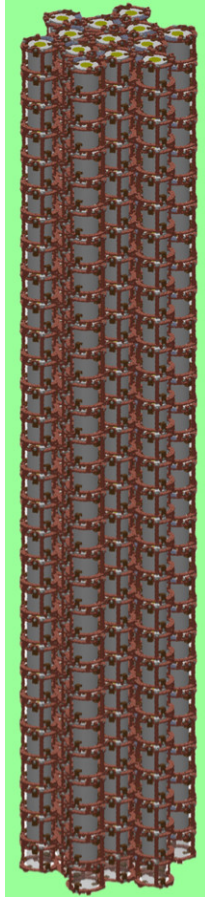

Figure 5.8: A schematic view of a possible configuration of the AMoRE-II crystal array.

5.4 AMoRE-II

For the AMoRE-II experiment, we aim to ultimately operate with a 200 kg array of molybdate crystals; a schematic diagram of a possible crystal arrangement in which the AMoRE-I configuration is stretched into long towers is shown in Fig. 5.8. The configuration can be changed, and the arrangement shown in Figure 5.8 is only one possibility. Our goal is to settle on the AMoRE-II design in the middle of year 2019.

For a 200 kg array of the crystals, we will need a much larger cryostat than that being used for AMoRE-Pilot and AMoRE-I experiments. The design of the larger cryostat will begin in 2017 and continue for about a year.

5.4.1 Crystals for AMoRE-II

To maintain a zero-background environment that fully exploits the increase in detector mass, the crystals for AMoRE-II must have internal background levels

that are an order-of-magnitude below those of the current state-of-the-art crystals that will be used in AMoRE-I. Moreover, to reach our total mass goal at reasonable cost, we have to be able to recover the precious $^{48\text{depl}}\text{Ca}$ and ^{100}Mo isotopes from the scrap material produced in the crystal-growing and cutting processes with high efficiency. To accomplish these tasks we are engaged in an aggressive R&D program aimed at improving chemical purification and recovery processes. As part of this we have set up our own chemical purification laboratory and recruited a PhD-level chemist specialized in low-level impurity extraction to manage it and supervise a small staff of purification laboratory (mostly PhD students). In addition, we have constructed our own crystal growing facility to research crystal-growing techniques. This is managed by a PhD physicist with a specialty in crystal-growing.

Chapter 6

Simulation tools and background estimations

To estimate background conditions in the AMoRE experiments, we are performing simulations with the GEANT4 toolkit [112, 113]. Since radiation originating within the CaMoO_4 will probably be the dominant source of backgrounds, internal CaMoO_4 crystal backgrounds from the full ^{238}U , ^{232}Th , and ^{235}U decay chains, as well as from ^{40}K , were simulated and their effects on the ^{100}Mo $0\nu\beta\beta$ decay signal region were investigated. For the AMoRE-I experimental configuration, backgrounds from materials in the nearby detector systems, including the internal lead shielding plate, G10 fiberglass, and the outer lead shielding box, were simulated, as well as backgrounds from more remote external sources, such as the surrounding rock material. Simulation results were normalized to measured activity levels. Activities of ^{238}U , ^{232}Th , ^{40}K , and ^{235}U were measured by HPGe detectors or inductively coupled plasma mass-spectroscopy. The ICP-MS measurements were all performed by the KAIST Analysis Center for Research Advancement (KARA). For all simulations, except as otherwise stated below (with particular exception for the ^{210}Pb subchain) we presently assume that the decay chains of ^{238}U , ^{235}U , and ^{232}Th are each in equilibrium, thus all related activities within the chains are simply equal to the ^{238}U , ^{235}U , and ^{232}Th activities multiplied by the branching ratios for decay of the daughter isotopes.

For backgrounds that originate from decays outside of the cryostat, such as from the lead shield or rock shell, only gamma de-excitations were found to produce signals in the crystals. Random coincidences of radiation from different background sources were found to have the most significant effect on the ^{100}Mo $0\nu\beta\beta$ decay signal region. These are reported here explicitly for sources where they were found to be significant. When not explicitly stated, random coincidences are not included. Cosmic-ray induced backgrounds were also simulated. Other sources of background (cosmogenic ^{88}Y , residual ^{48}Ca in $^{48\text{depl}}\text{Ca}^{100}\text{MoO}_4$, and ^{214}Bi in copper) are not expected to contribute significantly to the background near the signal region, but they will be considered in the future.

Results from background simulations described in this section are distinguished as α - or β/γ -like. A separation power of 8.6σ is demonstrated in Sec. 4.5 for separation of α - and β/γ -like events, implying that significant α background

rates in the region of interest, $\text{ROI} \equiv 3034 \pm 10 \text{ keV}$, can be safely rejected. Results are reported in Table 6.7 and can be compared to the AMoRE-I background goal of 0.002 counts/keV/kg/yr.

6.1 Geometry of simulation configuration

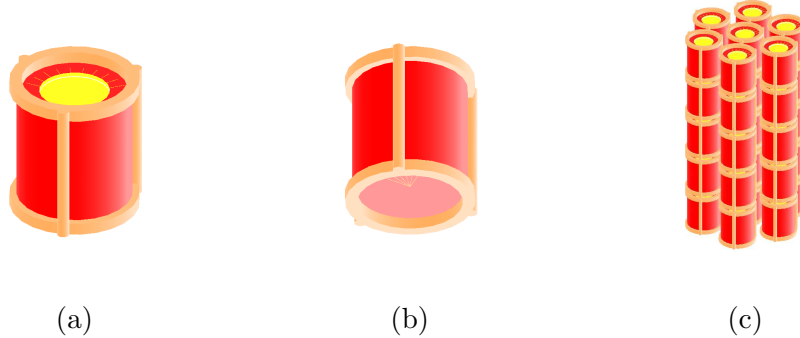

Figure 6.1: (a) CaMoO_4 crystal with Vikuiti reflector and Cu supporting frame; (b) bottom view of CaMoO_4 crystal; (c) the 35 CaMoO_4 crystals were stacked up in 5 layers and 7 columns.

The detector geometry of the AMoRE-I simulation includes the CaMoO_4 crystals, the shielding layers internal to the cryostat, the external lead shielding box, and the outer rock shell. An array of 35 CaMoO_4 crystals is located inside the cryostat. Each crystal has a cylindrical shape with a 4.5 cm diameter, 4.5 cm height, and a mass of 310 g. The total simulated crystal mass is 10.9 kg. The 35 crystals are arranged in seven vertical columns, each with five crystals stacked coaxially, with one center column surrounded by six external ones. The side surface of each crystal is covered by a Vikuiti ESR reflecting film.

As discussed above, each crystal is contained in a copper mounting frame as shown in Fig. 6.1. A 10-cm-thick lead plate (diameter 40.8 cm and mass 148.3 kg) placed on a 1-cm-thick copper plate is located just above the CaMoO_4 crystal array to attenuate backgrounds from cryogenic piping, electrical connectors, and other internal cryostat structures. The array is contained inside of four concentric copper cylinders with a total Cu thickness of 10 mm, all within an outer stainless-steel vacuum cylinder that is 5 mm thick. Sequential top plates are connected with G10 tubes. In the current version of the simulation, a simple top plate without any features or structures is used. Realistic structures and features have been positioned on each of the top plates for use in future simulations.

The cryostat is located inside a 15-cm-thick external lead shield. The top plate of the lead shield was placed above the lead shield and covering an area of $150 \times 150 \text{ cm}^2$. A 50-cm-thick rock shell surrounds the lead shield and cryostat, representing the rock cavern at the YangYang Underground Laboratory (Y2L) where the AMoRE-I experiment will operate.

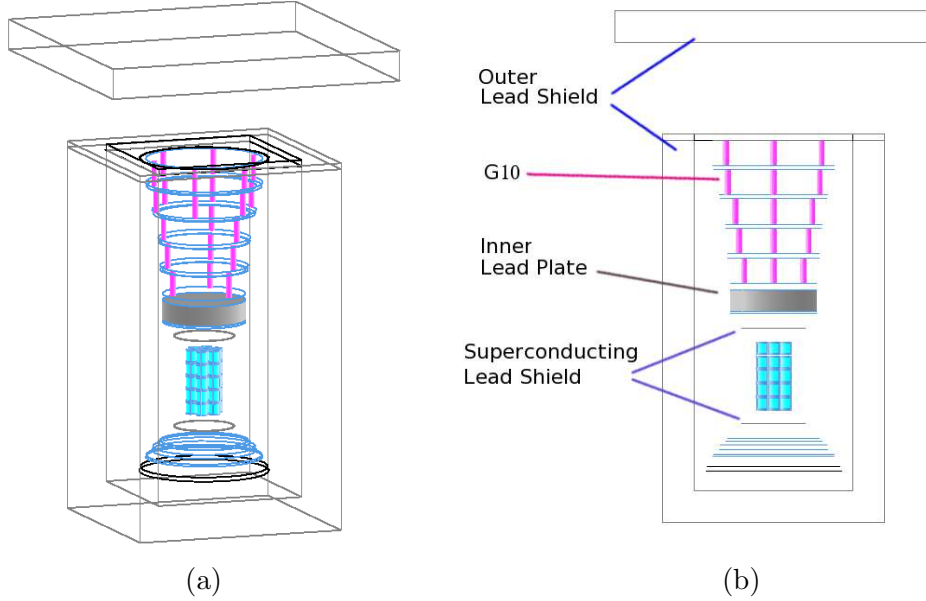

Figure 6.2: Geometry of the AMoRE-I Monte Carlo Simulation. The outer vacuum cylinder (OVC) and four Cu shields surround the CaMoO_4 crystals. Inside the cryostat, the Inner Lead plate (gray) on top of a Cu plate (blue) is located above the crystals. This lead plate attenuates radiation from the G10 support rods (magenta) and other materials in the upper cryostat.

6.2 Internal background in CaMoO_4

We simulated the full ^{238}U , ^{232}Th and ^{235}U decay chains, as well as ^{40}K , with contamination taken to be uniformly distributed inside the thirty-five crystals. The assumed radioactivity levels of the contaminants, listed in Table 6.1, were based on the measurements described above in Section 3.5. About 10^6 events each for ^{238}U , ^{232}Th , ^{40}K and ^{235}U , and about 10^7 ^{210}Pb events were simulated.

Table 6.1: Levels of radioactive contaminants based on SB28 measurement.

	^{210}Pb	^{238}U	^{232}Th	^{40}K	^{235}U
Activity [mBq/kg]	10	0.1	0.05	1	1

Background rate estimates were determined from the numbers of events in the ^{100}Mo $0\nu\beta\beta$ ROI, as shown in Table 6.2. Most of the events in the signal region are found to originate from α decays. The β -decay-induced events are mostly from the ^{232}Th chain and originate from ^{208}Tl . Because the ^{208}Tl half-life is only 3.1 minutes, decays of ^{208}Tl can be rejected using time correlations with the α -signal from the preceding $^{212}\text{Bi} \rightarrow ^{208}\text{Tl}$ α decays. Rejection of β events that occur within 15 minutes after a 6.207 MeV α event in the same crystal, results in a 94% veto efficiency for ^{208}Tl -induced β events in the signal

region, while introducing a negligible dead-time.

Table 6.2: Simulated background rates (counts/keV/kg/yr) in the ROI for sources within the crystals, before analysis cuts.

	^{210}Pb	^{238}U	^{232}Th	^{40}K	^{235}U
Total anti-coincidence rate	0.023	0.0020	0.0278	0	0.012
α event rate	0.023	0.0017	0.0005	0	0.012
β event rate	0	0.0003	0.0273	0	0

The $2\nu\beta\beta$ decay in a CaMoO_4 approaches zero rate at the end-point energy, but random coincidence of these events can sum together (pileup) creating backgrounds for the 0ν decay signal. The expected rate of $2\nu\beta\beta$ decay in a single CaMoO_4 crystal is 0.00284 counts/s, as listed in Table 6.3 with an energy distribution as shown in Fig. 6.3 (left).

Table 6.3: Expected rate of $2\nu\beta\beta$ decays.

	one crystal	35 crystals
Mass (kg)	0.31	10.87
$2\nu\beta\beta$ rate (counts/s)	2.84×10^{-3}	9.93×10^{-2}

When 5×10^8 $2\nu\beta\beta$ events were simulated in the CaMoO_4 crystals (310 g each), corresponding to about 335 years of operation, $\sim 98.6\%$ of events deposited energy in one crystal (single-hit events) and the remaining events produced hits in multiple crystals. The random coincidence rate of two $2\nu\beta\beta$ decays was calculated by convolving two single-hit $2\nu\beta\beta$ decay energy distributions (see Fig. 6.3), and the accidental rate, assuming an 0.5 ms coincidence window, is 1.18×10^{-4} counts/keV/kg/yr in the ROI. This is substantially lower than the AMoRE-I background goal of 0.002 counts/keV/kg/yr.

6.3 Backgrounds from materials in detector system

We simulated the full decay chains of backgrounds in the outer lead shielding box and in other items such as the inner lead plate, the copper support frame for the crystals, the G10 fiberglass structural elements of the cryostat, and the superconducting-lead magnetic shield. The assumed concentrations of radioactive background nuclides were based mostly on ICP-MS measurements [85] and were used to normalize the simulation results.

The ICP-MS technique measures concentrations of ^{39}K in the material. The concentrations of ^{40}K were calculated by assuming the ratio of concentrations of ^{39}K to ^{40}K is equal to the natural abundance ratio. The concentrations shown in Table 6.4 were based on our measurements, some of which were provided by the vendors.

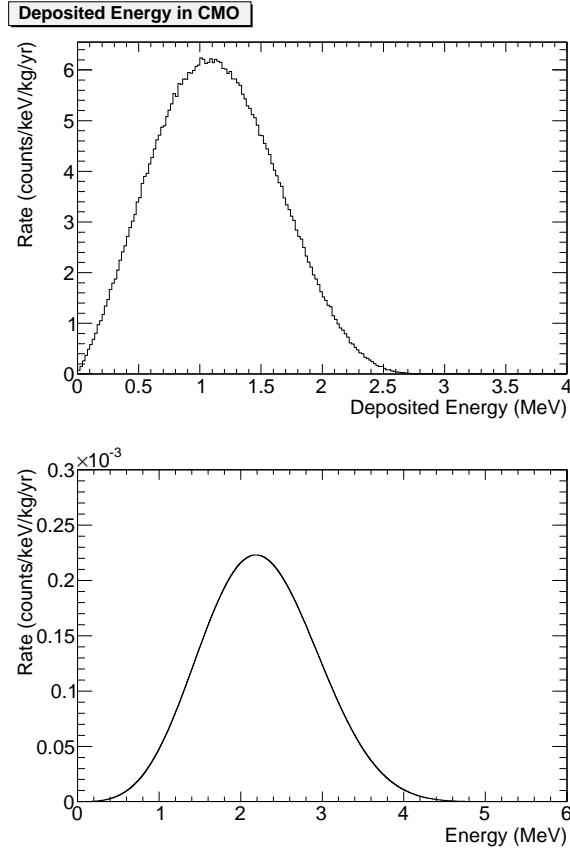

Figure 6.3: The energy distribution (bottom) of random coincidences of two $2\nu\beta\beta$ decays of ^{100}Mo . The random coincidence spectrum is derived by convolving two $2\nu\beta\beta$ spectra (top), and was normalized according to the $2\nu\beta\beta$ rate assuming an 0.5 ms coincidence window.

In order to reduce backgrounds from the lead shield inside the cryostat, we purchased T2FA lead bricks from Pax Lemer with a certified activity of ^{210}Pb of 0.3 Bq/kg of ^{238}U and ^{232}Th of < 1 pg/g. The concentration of ^{40}K is not yet known but decays of ^{40}K are expected to produce a negligible background contribution. The low Q -value of these decays implies that they can only contribute to the CaMoO_4 $0\nu\beta\beta$ ROI by way of accidental coincidence.

We itemize below the items inside the detector shielding for which radioactive backgrounds have been measured:

- CaMoO_4 copper support frame (the yellow elements in Fig. 6.1);
- G10 fiberglass support tubes for cryostat (the magenta elements of Fig. 6.2);
- lead plate inside cryostat (the gray item in Fig. 6.2);
- superconducting lead magnetic shield (this surrounds the inner crystal array).

Table 6.4: Levels of radioactive contaminants in materials inside the cryostat. Values marked with "*" were arbitrary assumptions.

	^{210}Pb	^{238}U	^{232}Th	$^{\text{nat}}\text{K}$	^{235}U
Crystal-supporting copper frame	-	0.027 ng/g	0.051 ng/g	-	-
Inner plate lead from Lemer PAX T2FA	0.3 Bq/kg	1* pg/g	1* pg/g	9* ng/g	1* pg/g
G10 fiberglass	-	1932 ng/g	12380 ng/g	360 $\mu\text{g/g}$	-
Superconducting shield, Lemer PAX T2FA lead,	0.3 Bq/kg	1* pg/g	1* pg/g	-	-
Outer shield lead from JL Goslar Gmbh	59 ± 6 Bq/kg	6.9 pg/g	3.8 pg/g	-	-

In order to attenuate gammas that originate from the surrounding rock a 15-cm-thick lead shielding box surrounds the cryostat. The top lead plate is located 46.4 cm above the top of the lead side-walls. The total mass is 15.6 tons. The lead was purchased from JL Goslar GmbH in Germany. The lead came with a ^{210}Pb certification from PTB, the National Standards Laboratory of Germany and was measured by ICP-MS at KARA for ^{238}U and ^{232}Th contamination. Activities are listed in Table 6.4. The expected number of ^{238}U , ^{232}Th decays originating from the lead shield were calculated based on the inferred activities and natural isotope abundance ratios. For ^{238}U and ^{232}Th no simulated events were found in the experimental ROI.

The expected rate of ^{210}Pb decays in the lead shield is 1.08×10^{11} counts/day (3.943×10^{13} counts/yr) when the concentration of ^{210}Pb in the lead shield is on the level of 60 Bq/kg, (The lead vendor provided a certification of 59 ± 6 Bq/kg). We simulated 4.4×10^9 ^{210}Pb events uniformly distributed within the lead shielding. This corresponds to the expected number of events for 1.25 hr for a concentration of 60 Bq/kg. The expected event rate of ^{210}Pb from the lead shield in CaMoO_4 is 8.9×10^5 counts/keV/kg/yr. No events were produced in the signal ROI.

To check the effectiveness of the outer shield at attenuating gammas from the surrounding rock, and to optimize the size of the top lead plate, mono-energetic γ 's of 2615 keV (emitted from ^{208}Tl) and 1461 keV (from ^{40}K) were generated randomly in a 50-cm-thick layer of the surrounding rock shell (Figure 6.4). The total mass of the 50 cm rock shell is 5.7×10^8 g. The measured concentrations of ^{238}U , ^{232}Th and K in the rock material are given in Table 6.5.

From these simulations we conclude that a top lead plate with transverse dimensions 150 cm \times 150 cm would be sufficient to block γ 's from entering through the gap in the shielding. The rate of events generated in the detector

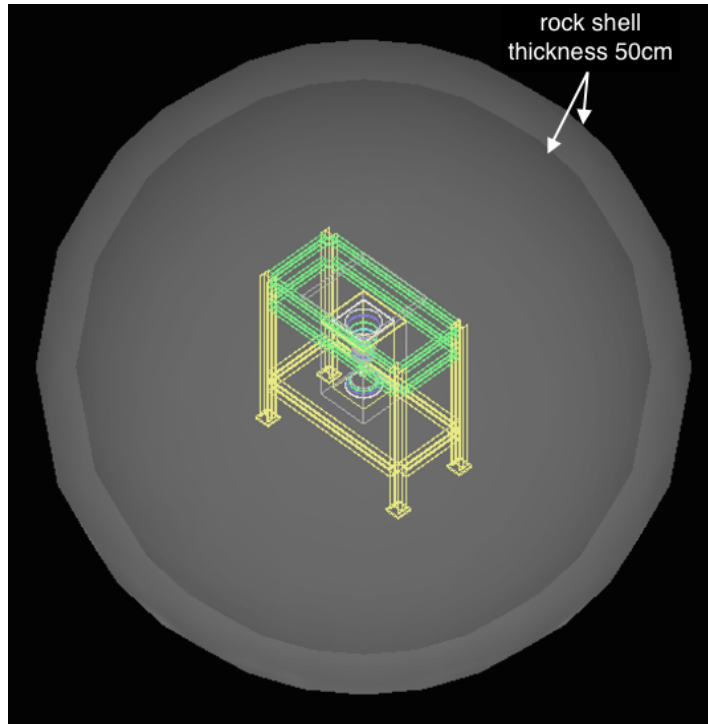

Figure 6.4: Geometry of the rock shell surrounding the setup.

Table 6.5: Concentrations of ^{238}U , ^{232}Th , and K in the rock sample from A5 tunnels in Y2L, measured by ICP-MS.

	^{238}U	^{232}Th	$^{\text{nat}}\text{K}$
Concentration ($\mu\text{g/g}$)	2.7	9.6	2100

from the rock is found to be smaller than the rate of events arising from ^{210}Pb in the shield, but the mean energies of gammas in the rock-produced gamma spectra are higher. No events were produced in the signal ROI. The rate of ^{100}Mo $2\nu\beta\beta$ decays in random coincidence with γ 's from ^{232}Th in the rock was estimated to be 1.01×10^{-4} counts/keV/kg/yr in the signal ROI.

6.4 Cosmic ray induced background

We have simulated cosmic muons and neutrons induced by muons passing through the detector system. We did not simulate the environmental neutrons produced by radioactive decays in underground rock since these neutrons have energies below 10 MeV and can be shielded with thick polyethylene blocks at outside of the detector.

6.4.1 Muon energy spectrum

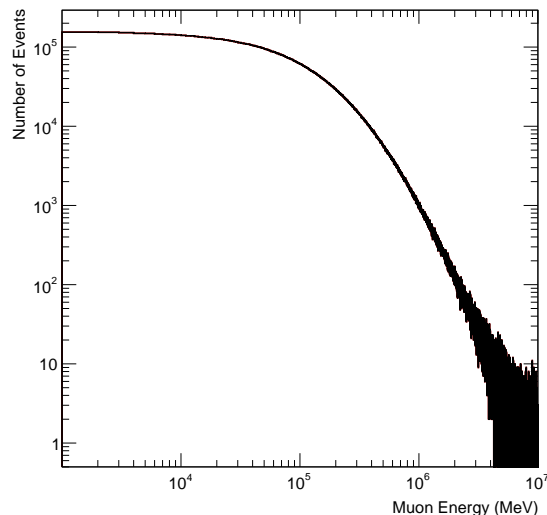

Figure 6.5: Muon energy spectrum at Yangyang.

High energy neutrons are produced primarily by muons passing through the materials in the detection system. These neutrons generate secondary neutrons via hadronic interactions in the surrounding materials. We simulated all the primary and secondary processes using GEANT4 simulation program starting with muons passing through the detector system. We used the muon energy spectrum provided by Mei and Hime [114]:

$$\frac{dN}{dE_\mu} = Ae^{-bh(\gamma_\mu-1)} \times (E_\mu + \epsilon_\mu(1 - e^{-bh}))^{-\gamma_\mu}, \quad (6.1)$$

where h is the rock slant depth in km.w.e. We used the parameters provided by Groom *et al.* [115] for ϵ_μ , b , and γ_μ . For Y2L, $h=1.8$ km.w.e. Figure 6.5 shows the muon energy spectrum generated at this depth. The average muon energy is 201 GeV, which is consistent with the measured values of Mei and Hime [114].

6.4.2 Schematic layout of simulation geometry

Muons were generated in a manner which produced all muons that pass within 1.5 m of the detector center, selected randomly for position and angle from the distribution of $\frac{dN}{d\Omega dA}$ proportional to $\cos^2 \theta$, as shown in Figure 6.6(a). The procedure insured that all muons were generated with vertices at least 3 m from the detector center. Figure 6.5 shows the energy spectrum of generated muons at the hemisphere. The muon flux at Yangyang is taken to be 2.7×10^{-7} muons/cm²/s or 3.7×10^7 muons/(3 m \times 3 m)/(48.3 years).

For the conceptual shielding configuration for AMoRE-II, we modeled 432 CaMoO₄ crystals, each with a diameter of 5 cm, a height of 5 cm, and a mass of 426 g.

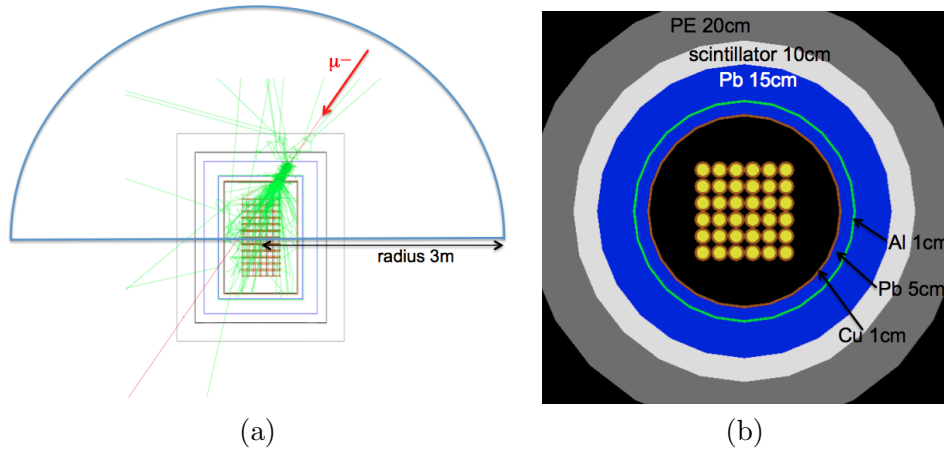

Figure 6.6: (a) Schematic layout of simulation geometry. (b) Shielding configuration

The total mass of crystals is 184 kg. The target crystals are located inside a 1 cm copper shield which is surrounded by lead and polyethylene (PE) shields as shown in Fig. 6.6(b). Plastic scintillators with 10 cm thickness are located outside of the lead shield.

6.4.3 Muon and muon-induced neutron backgrounds

In the AMoRE-II conceptual shielding configuration, muon and muon-induced neutron single-crystal background rates are found to be $\sim 1.1 \times 10^{-4}$ counts/keV/kg/yr, after applying a veto cut for events that are coincident with a hit in a muon scintillation counter. The veto efficiency for these events was taken to be 90%.

6.5 Other backgrounds

- Other sources of background (cosmogenic ^{88}Y , residual ^{48}Ca in the CaMoO_4 crystals, and ^{214}Bi in the copper) are not expected to contribute significantly to the background near the signal ROI. Nevertheless, they will also be considered in the future.
- Vikuiti reflector
We also simulated the effects of ^{238}U and ^{232}Th contaminants and their daughters, in reflecting foils that surround the CaMoO_4 crystals. An initial candidate for this part is 3M Vikuiti. Our HPGe counting of this material presently sets limits of about < 1.6 mBq/kg in the ^{238}U chain, < 0.9 mBq/kg for the ^{232}Th chain, and < 15 mBq/kg for ^{40}K . Preliminary simulation results are reported in Table 6.6. These results are very recent and potassium has not yet been included in the analysis.

Table 6.6: Simulated background rates from Vikuiti reflector (counts/keV/kg/yr) using measured activity limits. These results are very recent and potassium has not yet been included in the simulation analysis. ^{232}Th includes ^{228}Ra and ^{228}Ac with assumption of sub-chain equilibrium. We assume complete chain equilibrium for the ^{238}U chain.

Background source	Activities	Backgrounds in ROI [10^{-3} cnt/keV/kg/yr]		
		α events	β events	after applying cuts for events
Vikuiti reflector	^{238}U : 1.6 mBq/kg	7.4	-	0.007
	^{226}Ra : 1.6 mBq/kg	10	1.3	0.28
	^{232}Th : 0.74 mBq/kg	2.2	-	0.002
	^{228}Th : 0.90 mBq/kg	4.7	0.77	0.30
	^{40}K : 17 mBq/kg	-	-	-
Total		24	2.1	0.58

6.6 Summary of Background Estimation

Table 6.7 summarizes the major backgrounds expected in the AMoRE-I experiment. ^{238}U and ^{232}Th results are listed for major parts. Estimates of some ^{40}K concentrations are also listed. ^{40}K can contribute to backgrounds only through accidental pile-up, which is still being studied.

Table 6.7: Summary of backgrounds in major components of AMoRE-I, estimated with measurements and simulation. Limits are 95% C.L. Perfect alpha rejection is assumed (see Sec. 4.5). Here, items that have simulated times that are still less than a year and have not produced any counts in the ROI have not been translated into limits.

	Isotope	Activity [mBq/kg]	Simulated Time [years]	Backgrounds in ROI (3.03 ± 0.01 MeV) [10^{-3} cnt/keV/kg/yr]		
				α events	β -like events	after applying cuts for events
Internal CaMoO ₄	²¹⁰ Pb	10	31	23.0	-	-
	²³⁸ U	0.1	335	1.7	0.3	0.3
	²³² Th	0.05	698	0.5	27.3	1.5
	⁴⁰ K	1	232	<0.056	<0.056	<0.056
	²³⁵ U	1	32	12.0	<0.41	<0.41
Random coincidence of two $2\nu\beta\beta$			335	<0.039	0.12	0.12
CaMoO ₄ copper frame	²³⁸ U	0.330	96	0.63	0.45	~ 0 .
	²³² Th	0.207	207	0.46	1.43	~ 0.7
G10 fiberglass support tubes	²³⁸ U	240 000	0.1	-	-	-
	²³² Th	50 000	0.03	-	-	-
	⁴⁰ K	1.2	0.4	-	-	-
SC lead shield	²¹⁰ Pb	300	1.0	92.8	-	-
	²³⁸ U	.012	4425	0.007	0.004	~ 0.001
	²³² Th	.0041	17884	0.003	0.002	~ 0.001
Inner lead plate	²¹⁰ Pb	300	0.09	-	-	-
	²³⁸ U	.012	10	<1.3	<1.3	<1.3
	²³² Th	.0041	10	<1.3	<1.3	<1.3
Outer lead shield	²¹⁰ Pb	59 000	1.25 hr	-	-	-
	²³⁸ U	.085	0.28	-	-	-
	²³² Th	.015	0.53	-	-	-
γ from rock in random coincidence with $2\nu\beta\beta$	²³² Th	39 000	1.2 hr	-	0.10	0.10
Muons and muon-induced neutrons			48	-	1.1	0.11
Total				133.8	33.9	5.9

Chapter 7

Supply, purification and recovery of enriched materials

7.1 ^{100}Mo

Molybdenum isotopes are separated by centrifuge techniques, which are characterized by high productivity and reasonable cost. This technique can work for chemical elements that form volatile compounds at room temperature. Fortunately, Molybdenum forms the volatile MoF_6 compound at room temperature. There are several facilities at the world that have the capability for the separation of large quantities of Molybdenum: JSC Production Association Electrochemical plant (Zelenogorsk), JSC Ural Electrochemical plant (Novouralsk) and JSC Siberian Chemical Plant (Seversk) in Russia, and URENCO (Almelo) in the Netherlands. These plants have dealt with the enrichment of Uranium and also with enrichment of stable isotopes of some other chemical elements.

An 8.25 kg quantity of ^{100}Mo (enriched to 96%) was produced by the JSC Production Association Electrochemical Plant (ECP) in Zelenogorsk, Russia, by the gas centrifugation technique. This enriched material, supplied in the form of $^{100}\text{MoO}_3$, is very pure with respect to radioactive contaminants: the results of ICP-MS measurements show that the concentrations of ^{238}U and ^{232}Th in the $^{100}\text{MoO}_3$ powder do not exceed 0.07 ng/g and 0.1 ng/g, respectively.

The general scheme for ^{100}Mo production at the ECP is as follows:

- **Fluoridation:**

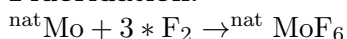

(gaseous impurities: $^{235,238}\text{UF}_6 + ^{\text{nat}}\text{WF}_6 + ^{\text{nat}}\text{GeF}_4 + \dots$)

Purification of: $\text{ThF}_4, \text{RaF}_2, \text{PaF}_4, \text{AcF}_3, \text{KF}$ - no volatile high-pressure fluorides at RT).

- **Centrifugation:**

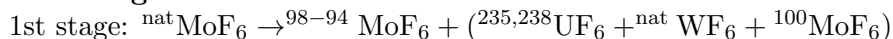

- **Conversion (“wet” chemistry):**

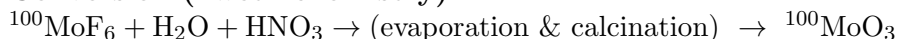



The ^{100}Mo production capacity at ECP is, at present, ~ 28 kg/yr, in form of $^{100}\text{MoO}_3$ with an isotopic enrichment $\text{IE} \geq 95\%$. At this rate, it would take about 3.5 years to produce 100 kg of enriched ^{100}Mo . It is not clear at this time if there is another plant capable of enriching ^{100}Mo at this rate. According to our underground background measurements at Y2L, the quality of the MoO_3 powder (from the point of view of chemical purity and ^{238}U and ^{232}Th contamination) is sufficient for CaMoO_4 crystal growing.

The cost to the AMoRE Collaboration is 90~100 \$/g for 100 kg quantities (mass of Mo) with an enrichment to 95%. There is strong “cost competition” between the application of Mo isotopes for Nuclear Medicine (^{98}Mo and ^{100}Mo for production of ^{99}Mo / $^{99\text{m}}\text{Tc}$)

and Underground Physics. This situation presents a risk to AMoRE (the cost of ^{98}Mo for Nuclear Medicine is at the level of 300 \$/g). The MoF_6 working gas for centrifugation is extremely corrosive. If a centrifuge cascade is devoted to Mo isotope enrichment, this production should continue “forever”, i.e., until the time of the cascade’s decommissioning.

7.2 $^{48\text{depl}}\text{Ca}$

Calcium isotopes can be separated by electromagnetic methods that are characterized by very low productivity and high cost. There are currently two sites in the world that possess large-scale facilities for this purpose: the Y-12 National Security Complex (Calutrons in Oak Ridge, DOE, USA) and FSUE Electrochimpribor (Lesnoy, Russia). At present, the Calutrons in Oak Ridge are closed. The SU-20 facility at FSUE Electrochimpribor (EKP) is in operation and is still producing ^{48}Ca (and $^{48\text{depl}}\text{Ca}$). In a search for existing ^{48}Ca -depleted material, we found that EKP has a sizable amount of Ca material from which the ^{48}Ca component was depleted by as much as a factor of 187 compared to that for natural calcium. The production of ^{48}Ca -depleted (or, equivalently, ^{40}Ca -enriched) material by means of industrial electromagnetic separators, has been going on continuously in the USSR/Russia to provide ^{48}Ca -, ^{44}Ca - and ^{46}Ca -enriched isotopes for medical and physics applications since the 1950s. The ^{48}Ca -depleted “left-over” material from these projects, which is currently stored in the form of $^{48\text{depl}}\text{CaCO}_3$, would be suitable for our needs. We are currently making an inventory of all the world’s quantities of Ca solutions that are depleted on ^{48}Ca at the level of less than 0.005%.

The first batches (of 4.5 kg in total) of the calcium carbonate depleted in the ^{48}Ca isotope ($\leq 0.001\%$) that were produced by EKP have been characterized with mass-spectrometry (ICP-MS) and HPGe detectors. The concentrations of ^{238}U and ^{232}Th in the powder measured by ICP-MS are below 0.2 ng/g and 0.8 ng/g, respectively. However, a γ -spectroscopic analysis of the $^{48\text{depl}}\text{CaCO}_3$ powder revealed some specific activity due to ^{226}Ra and its progenies at the level of a few hundred mBq/kg. Also, the content of Sr and Ba elements, which belong to the same sub-group of chemical elements as Ra, were quite high (Sr

= 25 $\mu\text{g/g}$ and Ba = 26 $\mu\text{g/g}$), and this also indicates the presence of some Ra impurity. Because of this, the $^{48\text{depl}}\text{CaCO}_3$ material was subjected to additional purification.

At present, there is 32 kg of $^{48\text{depl}}\text{Ca}$ available at EKP, in Lesnoy, Russia. It has less than 0.001% of ^{48}Ca . AMoRE-II needs about 40 kg of $^{48\text{depl}}\text{Ca}$. The small shortage could be covered by the anticipated production of ^{48}Ca -depleted Ca in the next few years.

7.3 Purification of calcium and molybdenum oxides and recovery of enriched materials after crystal production

The ultimate sensitivity of AMoRE is limited by internal CaMoO_4 backgrounds that are due to impurities in the form of natural radioactive isotopes, such as ^{208}Tl from the ^{232}Th chain and ^{214}Bi among the ^{226}Ra decay products in the ^{238}U chain [116]. Therefore, the removal of uranium, thorium and radium insures the removal of other isotopes in these chains and reduces internal backgrounds in the CaMoO_4 detectors. One of our approaches has been to utilize chemical purification methods to remove impurities from the raw materials used to grow the scintillation crystals.

In the process of making or cutting crystals, scraps (or crystal wastes) of $^{48\text{depl}}\text{Ca}^{100}\text{MoO}_4$ crystals are unavoidable. To reduce the project cost one should extract separately materials containing calcium and those containing molybdenum from those scraps. Subsequent mixtures of these two materials can be used to make $^{48\text{depl}}\text{Ca}^{100}\text{MoO}_4$ crystals. We have recently developed technologies to recover and purify calcium and molybdenum from crystal wastes.

In following section, we present the deep purification methods we use for $^{48\text{depl}}\text{CaCO}_3$ and $^{100}\text{MoO}_3$ and the methods for their recovery from the crystal wastes.

7.4 Deep purification of CaCO_3 powder

The CaCO_3 purification process uses an inorganic sorbent MDM that is based on manganese dioxide (MnO_2). A chromatographic column used for this purpose is made of stainless steel. The major steps in this purification process are discussed in the following.

About 500 grams of calcium carbonate powder are placed in a glass beaker and mixed with a calculated amount of dilute nitric acid (65%) until all of the CaCO_3 is completely dissolved. The chemical reaction for the dissolution of calcium carbonate in nitric acid is

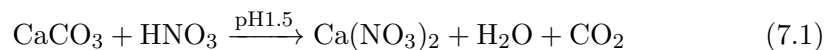

After mixing, the solution has a light brown color due to presence of insoluble impurities as shown in Fig. 7.1(a). Subsequent filtering removes these impurities

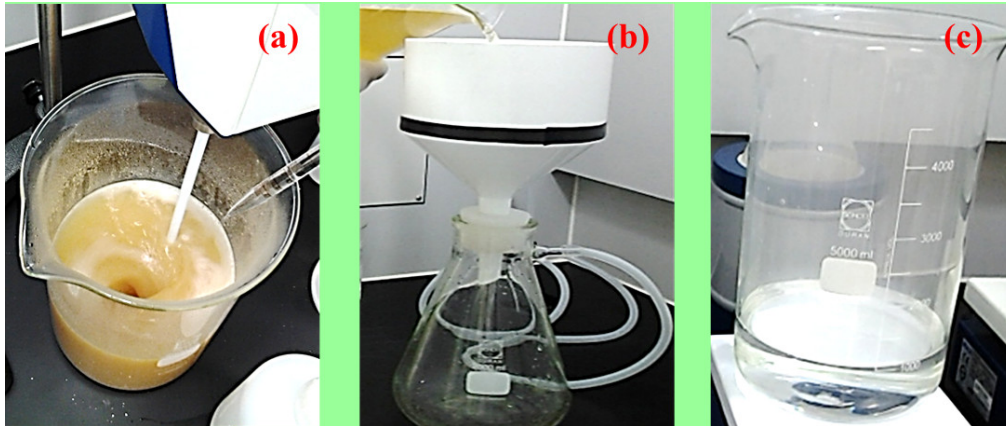
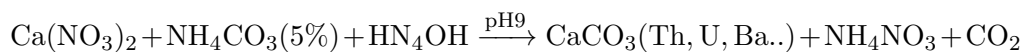

Figure 7.1: (a) Dissolution of CaCO_3 (b) Vacuum filtration (c) Final filtrate.

as shown in Fig. 7.1(b). The resulting solution after filtration is transparent and has a $\text{pH}=1.5$. Figure 7.1(c) shows the final filtrate obtained after vacuum filtration.

The filtrate is further purified by passing it through a sorption column filled with a granular MDM sorbent. The volume of the sorbent inside the column is 60 cm^3 . The feed solution is forced through the column by a peristaltic pump with a speed of 120 ml/h , as shown in Fig. 7.2. Filtrates after the column purification are collected and analyzed for concentrations of iron, uranium, thorium, strontium and barium by an ICP-MS system. Figure 7.3 shows a schematic drawing of the ion-exchange process using an MnO_2 resin.

After purification with the MDM sorbent, the solution is neutralized with aqueous ammonia to $\text{pH}=9.0$ and 50 g of ammonium carbonate are added to precipitate the remaining quantities of impurities in the calcium carbonate. The reaction of calcium nitrate solution with ammonium carbonate and aqueous ammonia precipitates 5% of CaCO_3 :



The solution is filtered to collect the impure precipitate of CaCO_3 on filter paper.

The remaining part of ammonium carbonate (680 g) is added to the filtrate solution until all of the calcium is precipitated. The reaction of the calcium nitrate solution with ammonium carbonate and aqueous ammonia to precipitate 95% of CaCO_3 is:

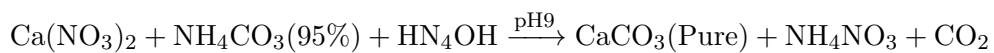

The resulting precipitate of calcium carbonate is filtered off, washed on filter paper with distilled water and collected in a quartz crucible. Figures 7.4(a), (b) and (c) show the precipitation of CaCO_3 with subsequent filtration and collection of precipitates, respectively.

The crucible containing the CaCO_3 precipitate is placed in an electric muffle furnace and heated initially to 100° C for 2 hours to remove water, and then at



Figure 7.2: Photographic view of purification of CaCO_3 using MnO_2 resin.

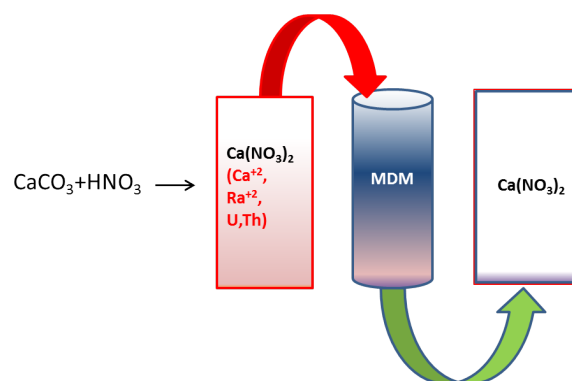

Figure 7.3: Schematic of purification of CaCO_3 by MnO_2 .

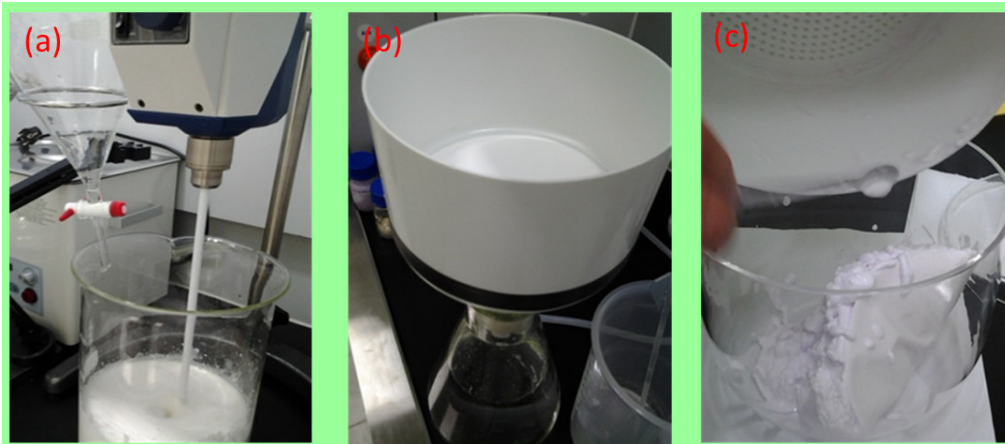

Figure 7.4: (a) Precipitation. (b) Vacuum filtration. (c) CaCO_3 pure precipitate.

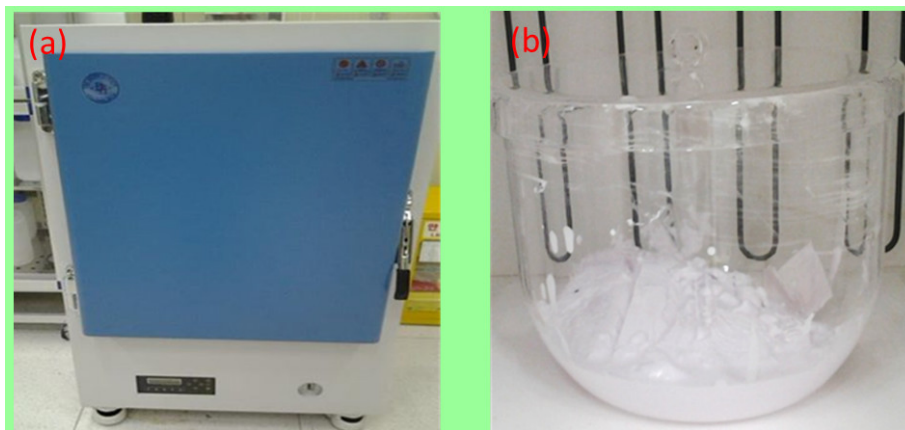

Figure 7.5: (a) Muffle Furnace. (b) CaCO_3 calcination in quartz crucible.

Table 7.1: ICP-MS results of the analysis of the filtrates after sorbent MDM.

Sample	Volume	Concentration [ng/g]				
	fraction					
	[ml]	Fe	Sr	Ba	Th	U
Initial solution	-	16120	8129	67.2	0.73	20.4
Filtrate (1F)	840	122	1400	0.089	0.011	0.04
Filtrate (2F)	840	66	565	0.021	0.003	0.025
Filtrate (3F)	880	146	171	0.053	0.0004	0.017
Filtrate (4F)	1420	359	132	0.023	0.00006	0.039

Table 7.2: Purification results for the MDM sorbent (DF is the decontamination factor).

Sample	Volume	DF				
	fract.					
	[ml]	Fe	Sr	Ba	Th	U
Filtrate(1F)	840	132	6	755	66	510
Filtrate(2F)	840	244	14	3200	243	816
Filtrate(3F)	880	110	48	1270	1825	1200
Filtrate(4F)	1420	45	62	2920	12170	523

450° C for 2 hours for the final calcination of the material. Figure 7.5 shows the calcination of CaCO₃ in the muffle furnace. The final weight of purified CaCO₃ is typically ~440 g, which is ~88% of the initial weight. This calcium carbonate sample is analyzed for impurities. Table 7.1 shows the ICP-MS analysis results for an initial and final calcium nitrate solution before and after being passed through the MnO₂-based ion exchange resin.

To quantify the level of purification, we use the decontamination factor, DF, defined as the ratio of initial-to-final specific radioactivity resulting from the chemical separation process. It numerically quantifies the efficiency with which impurities are removed from a chemical substance. In our case, this is the factor by which the radioactive contamination level is reduced. Taking C_{in} and C_f as the concentration of impurities in the initial and final materials, the decontamination factor is $DF = C_{in}/C_f$. A purification process that removes impurities will have a decontamination factor greater than one [117].

Table 7.2 lists measured decontamination factors: iron impurities are decreased by a factor of 100, strontium by factors of 10 to 15, barium by 1,000, thorium by between 100 to 10,000, and uranium by 100 to 1,000. From the results for barium, which is the closest family element to radium on the periodic table, it can be inferred that the decontamination factor for radium is also quite high (at least 2–3 orders of magnitude).

Table 7.3 shows results from a ICP-MS analysis of the purified CaCO₃ powder. The iron content in the purified product was reduced by approximately an order of magnitude, and the uranium and thorium content by 2 orders of mag-

Table 7.3: The concentration of impurities in the initial and purified calcium carbonate and decontamination factors (DF).

CaCO ₃	Concentration [ng/g]				
	Fe	Sr	Ba	Th	U
Initial powder	1.3×10^5	6.5×10^4	538	5.8	163
Purified powder	1.4×10^4	1.0×10^5	611	2.7	1.05
DF	9.3	0.63	0.88	2.1	155

nitude. No strontium and barium purification occurred. The purification results for thorium, strontium, and barium are entirely inconsistent with the results shown in Table 7.2. This may be due to the insufficient purity of the reagents used, especially ammonium carbonate.

Finally, the radioactive contamination of the initial (unpurified) CaCO₃ powder and of the CaCO₃ powder that was processed through the MnO₂ ion exchange resin were studied with a HPGe detector for background measurements at the Yangyang underground laboratory. From the HPGe results (Table 7.4), it can be seen that decontamination factors as high as 300 can be achieved for ²²⁶Ra; other radioactive elements are reduced by factors of 10 to 100.

7.5 Deep purification of MoO₃ powder

Molybdenum oxide (MoO₃) powder is purified in the form of an ammonium molybdate solution, which is prepared by dissolving MoO₃ powder in aqueous ammonia. In this section, we will describe our study of purification methods for MoO₃ powder, and R&D of MoO₃ purification methods that is in progress.

An ammonium molybdate solution can be prepared by mixing the MoO₃ powder with purified ammonia in an aqueous media with pH=7. The first step is the purification of the ammonia. About 500 ml of aqueous ammonia is placed in a plastic bottle that is connected via a Teflon tube to a collection bottle. The collection bottle is, in turn, connected to a bottle that is filled with 500 ml of deionized (DI) water. Impure ammonia in the first bottle is heated in a water bath and the water droplets emerging from the bottle accumulate in the collection bottle. Then the third bottle, which is placed in a cold water bath and filled with DI water, is used to collect the pure ammonia fumes. The reaction stops when temperature in the water reaches 80°C. This procedure is shown in Figure 7.6.

In order to prepare ammonium molybdate solution, about 200 g of MoO₃ powder is placed in a plastic beaker and dissolved in 50 ml of DI water to avoid dust formation with the ammonia. Then, with the pH maintained at 7, the purified ammonia is added until all of the MoO₃ powder dissolves completely. The principal reactions for this procedure are as follows.

At pH \sim 7:

Table 7.4: HPGe results. “Before” (“After”) stands for before (after) purification of CaCO₃ powder.

Chain	Element	Peak Energy [keV]	Rate [counts/day] (Before)	Rate [counts/day] (After)	DF
⁴⁰ K	⁴⁰ K	1460.83	164.9	9.31	17.61
²³⁸ U	²²⁶ Ra	186.2	2246.9	6.97	322.36
		²¹⁴ Pb	295.22	4592	41.48
	²¹⁴ Bi	351.94	8387.9	133.99	62.59
		609.31	6579.7	132.05	42.82
		1120.28	1526.4	17.6	86.72
		1764.51	1323.8	31.14	42.51
				12.8	103.42
		5.94	222.86		
²³² Th	²²⁸ Ac	911.2	151.2	3.54	42.71
		964.77	63.2	2.55	24.7
		968.92	76.2	4.54	16.78
	²²⁴ Ra	240.99		17.3	
	²¹² Pb	238.63	410.1	5.9	69.5
	²¹² Bi	727.33	51.8	0.46	112.6
	²⁰⁸ Tl	2614.53	45.4	4.51	10.06
		583.14	180.1	2.74	65.72
		510.77		2.06	87.42

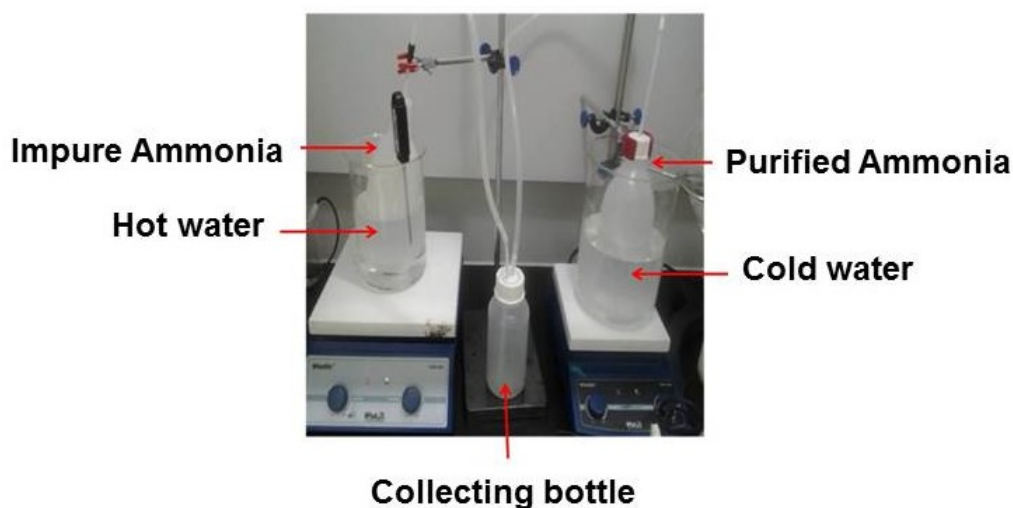

Figure 7.6: The procedure for purification of aqueous ammonia.

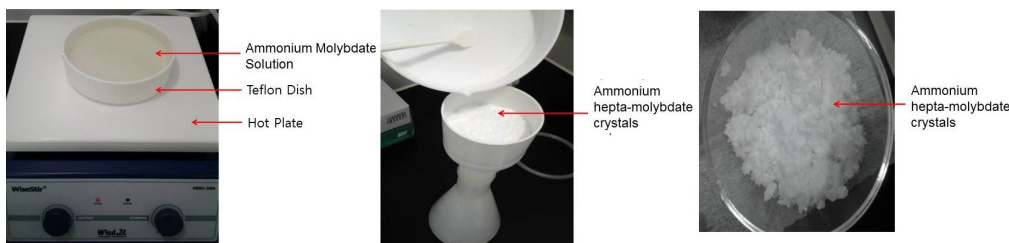
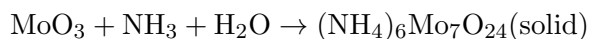
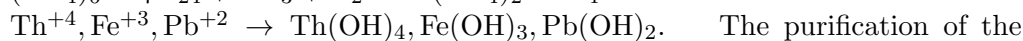
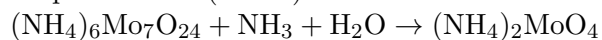

Figure 7.7: The recrystallization method procedure.



At pH above 7 (8 or 9):



MoO_3 powder starts with the solution of $(\text{NH}_4)_2\text{MoO}_4$. We have studied the following purification methods:

- Recrystallization
- Co-precipitation
- Sedimentation
- Column chromatography.

In the recrystallization method, we have the highest purity product, but a low yield. The purified molybdenum is in the form of ammonium hepta-molybdate $(\text{NH}_4)_6\text{Mo}_7\text{O}_{24} \cdot 4\text{H}_2\text{O}$ in aqueous solution. In this process, ammonium molybdate is continuously heated in a teflon evaporation dish to remove the aqueous media and purified crystals are collected on filter paper (see Fig. 7.7). In this method, the chemical reaction is:



Co-precipitation is an impurity selective method. Impurities of radium are separated in the form of calcium molybdate using calcium chloride (CaCl_2) in aqueous solution. In this method, we have to prepare pure calcium chloride using the reaction:



The main reaction in this method is

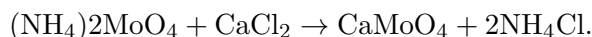

About 1% of the calcium molybdate crystals are collected on filter paper, while the filtrate solution contains purified ammonium molybdate. The procedure for the co-precipitation method is presented in Fig. 7.8.

In the sedimentation process we have a comparatively high product yield. Molybdate is collected as ammonium tetramolybdate $(\text{NH}_4)_2 \times \text{Mo}_4\text{O}_{13}$ from an aqueous solution of ammonium molybdate. The theoretical yield for this process is 96% to 97%. The procedure is (see Fig. 7.9)

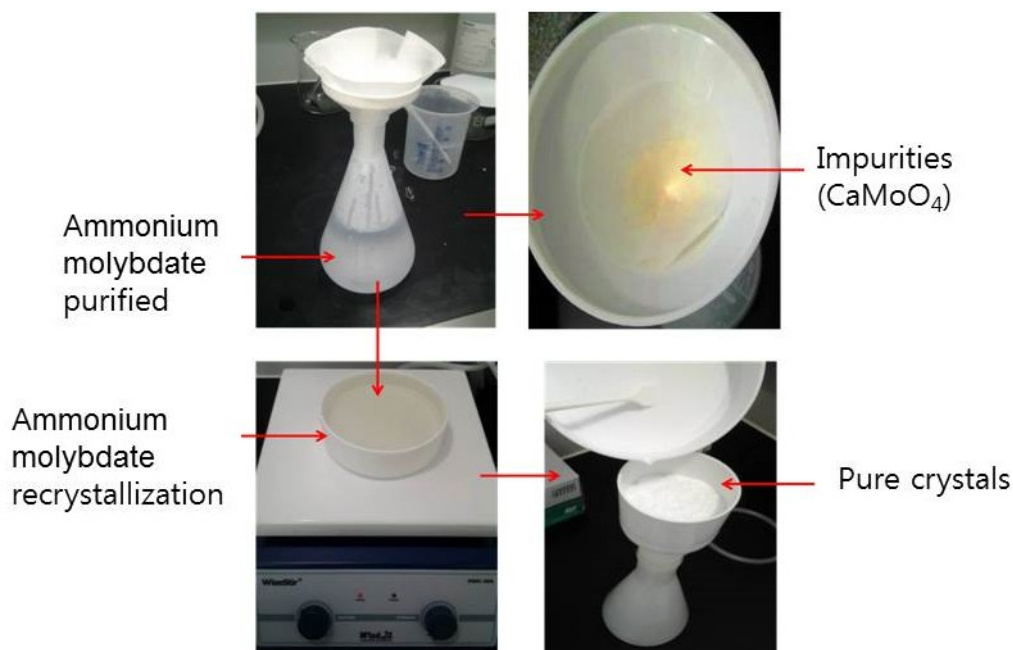
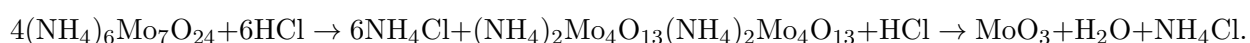

Figure 7.8: The co-precipitation method procedure.

- 200 ml of ammonium molybdate is placed in a plastic beaker;
- 100 ml of DI water is mixed with 100 ml of HCl;
- this solution is added to ammonium molybdate solution drop wise until the pH of the solution reaches 1;
- the precipitates are filtered off, collected on filter paper and dried.

The principal reactions for this method are:



The column-chromatography method is based on the different behavior of components in their mixtures with two phases, one stationary and the other mobile. Physical or chemical absorption takes place on the phase boundary. An initial ammonium molybdate solution has anions, $\text{Mo}_8\text{O}_{24}^{4-}$, $\text{Mo}_8\text{O}_{24}^{4-}$ and $\text{Mo}_8\text{O}_4^{2-}$, and cations, NH_4^+ , K , Pb^{2+} , $(\text{Th})^{n+}$, $(\text{U})^{n+}$, etc. We use the Amberlite IR-120 H-form cation exchange resin. A purified ammonium molybdate solution is produced. The column containing the resin is shown in Fig. 7.10. In this study, the diameter and height of column are 25 mm and 250 mm, respectively.

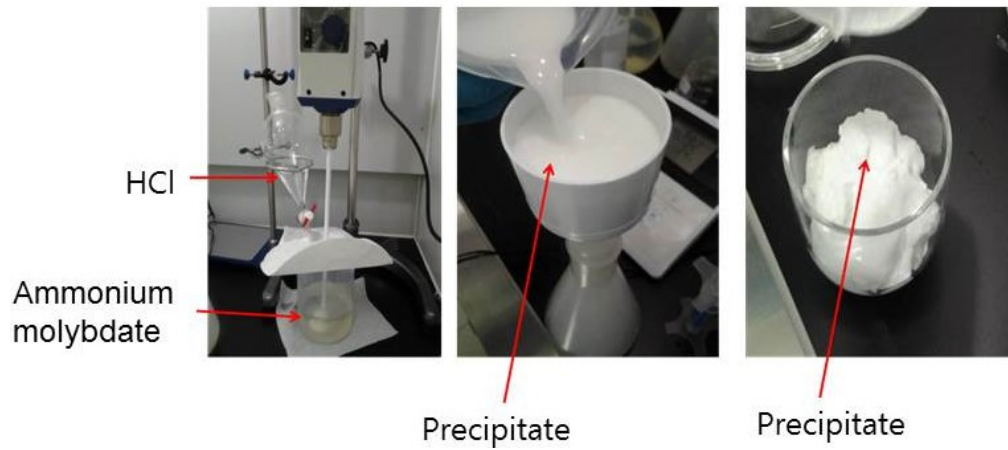

Figure 7.9: The sedimentation method procedure.

$$V(\text{resin}) = 100 \text{ mL}, d = 25 \text{ mm}, h = 250 \text{ mm}$$

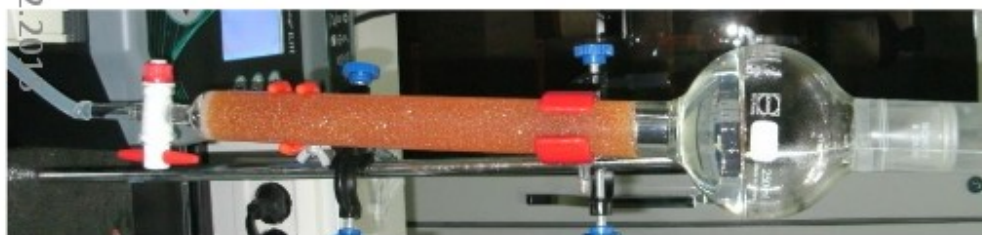

Figure 7.10: The column chromatography method. The resin is inside the cylinder.

7.6 Calcium and molybdenum recovery from CaMoO_4 crystals

In the procedure to recover calcium and molybdenum from $^{48\text{depl}}\text{Ca}^{100}\text{MoO}_4$ crystals, we first have to make a solution by means of a strong acid, either HCl or HNO_3 .

7.6.1 Decomposition of CaMoO_4 crystals with 65% HNO_3

The CaMoO_4 crystal is first crushed into small pieces using a pestle and mortar. Then the crushed CaMoO_4 is milled into a fine powder using a pulverizing milling machine. After this, milled powder is sieved to select diameters between 0.10 mm and 0.25 mm using a non-metallic sieve.

In the second step, about 300 g of the CaMoO_4 powder is placed inside a plastic bottle with 400 ml of 65% HNO_3 . The bottle is kept in a water bath and heated up to $70^\circ\text{C} - 80^\circ\text{C}$. This mixture is constantly stirred with a high-speed mechanical stirrer for 6 hours. During this procedure a thick, yellow-colored molybdic acid is formed via the reaction



In this reaction, all of the ammonium molybdate is in the molybdic acid form and calcium nitrate is in the solution form. In this way, we recover ammonium molybdate and calcium carbonate separately. The above solution is filtered under vacuum. The filtered cake is washed with a dilute solution of nitric acid. After filtration we obtain molybdic acid as a residue on the filter paper and calcium nitrate as the filtrate.

In the third step, the molybdic acid is dissolved in a 25% aqueous ammonium hydroxide solution until a transparent solution is obtained. The solution is then filtered under vacuum. The undissolved CaMoO_4 remains as a residue on filter paper and is collected in a quartz crucible and the filtrate solution is poured into a clean beaker. The solution in the beaker is neutralized with nitric acid up to $\text{pH}=1.65-1.70$. While this happens, a precipitate of fine polyammonium molybdate (PAM) crystals is formed. This precipitate solution is filtered under vacuum and the crystals are washed with a dilute ammonium nitrate solution with $\text{pH}=1.7$. The PAM residue on the filter paper is collected in a clean beaker and the filtrate solution is discarded. The PAM is again dissolved in aqueous ammonia until a transparent solution is obtained. Some of this solution is evaporated, leaving crystals of ammonium molybdate (AM). These crystals are collected and the remaining solution is evaporated, producing more crystals (see Fig. 7.11).

In the fourth step, the calcium nitrate solution is evaporated to remove excess nitric acid. After evaporation a wet salt of calcium nitrate is obtained and the obtained salt is dissolved in water until a transparent solution is obtained. This solution is neutralized with aqueous ammonia to $\text{pH}=8$. During this neutralization, a white precipitate of CaMoO_4 is formed. The precipitated solution is filtered under vacuum and the residue, which is collected on filter paper, is



Figure 7.11: Ammonium molybdate obtained from the recovery of CaMoO_4 crystals.



Figure 7.12: Pure CaCO_3 on filter paper (left), the purified CaCO_3 is collected in the quartz crucible (middle) and calcinated CaCO_3 in a furnace (right).

undissolved CaMoO_4 that is collected in a quartz crucible and the filtrate is collected in clean beaker. In the filtrate solution, enough ammonium carbonate is added so that 5% of the calcium carbonate precipitates out. During this procedure, aqueous ammonia is added to maintain $\text{pH}=9$. This solution is constantly stirred with a mechanical stirrer. The above precipitate solution is filtered under vacuum. The precipitate on the filter paper is calcium carbonate that contains a lot of impurities. This is discarded and the filtrate solution is collected in a clean beaker. In the filtrate solution we again add ammonium carbonate to precipitate the remaining 95% of the calcium carbonate. During this procedure, liquid NH_3 is added to maintain the pH at 9 and the solution is constantly stirred by a mechanical stirrer. The precipitate solution is filtered under vacuum and here the residue in the filter paper is purified CaCO_3 and the filtrate is waste. The purified CaCO_3 is collected in a quartz crucible and calcinated at 450°C for two hours inside a closed furnace (see Fig. 7.12).



Figure 7.13: The procedure to obtain crystals of molybdate; CaMoO_4 solution (left), neutralization with liquid NH_3 , vacuum filtration, and crystals of molybdate (right).

7.6.2 Decomposition of CaMoO_4 crystal material with 36% HCl

In the first step of Mo recovery and purification, about 300 g of CaMoO_4 powder is placed in a glass beaker, and 775 ml of HCl and 250 ml of DI water are added. The mixture is heated for 30 minutes while constantly being stirred by a magnetic stirrer until a transparent solution is obtained. The main reaction for this procedure is:



The CaCl_2 precipitate is filtered off. The remaining solution is neutralized with liquid NH_3 to $\text{pH}=1-1.5$. During the neutralization, a PAM precipitate is formed. The precipitated solution is then passed through a vacuum and the PAM residue is collected in one beaker and the filtrate in another. The residue is washed with a dilute ammonium chloride solution with $\text{pH}=1.7$. From the PAM, we separate AM and obtain calcium carbonate from the filtrated calcium chloride.

In the second step, the PAM is dissolved in liquid ammonia until a transparent solution is obtained. The solution is then vacuum filtered. The undissolved CaMoO_4 is collected as a residue on filter paper and collected in a quartz crucible while the filtrate is collected in a clean beaker. The obtained solution is evaporated to obtain ammonium molybdate crystals. The initially formed crystals are collected and the remaining solution is evaporated to obtain the remaining, purified crystals. The procedure is illustrated in Fig. 7.13.

In the third step, we obtain calcium carbonate from the calcium chloride solution as shown in Fig. 7.14. The neutralization of the calcium chloride solution is done with liquid NH_3 at $\text{pH}=8$. A precipitate of dissolved CaMoO_4 is formed. The precipitate solution is vacuum filtered. The residue on the filter paper is undissolved CaMoO_4 that is collected in the same beaker and the filtrate solution is collected in a clean beaker. In the filtrate solution, we add enough ammonium carbonate so that 5% of the calcium carbonate precipitates out. During this procedure aqueous ammonia is added to maintain $\text{pH}=9$. This solution is constantly stirred by a mechanical stirrer. The above precipitate solution is vacuum filtered. The precipitate on the filter paper is calcium carbonate that contains lots of impurities and is discarded, while the filtrate solution is collected in a



Figure 7.14: Calcium carbonate production: neutralization with liquid NH_3 (left), filtration, and purified product (right).

clean beaker. In the filtrate solution, we again add ammonium carbonate to precipitate the remaining 95% of the calcium carbonate. During this procedure, liquid NH_3 is added to maintain $\text{pH}=9$ and the solution is constantly stirred by a mechanical stirrer. The precipitate solution is vacuum filtered. The residue on the filter paper is purified CaCO_3 and the filtrate is discarded. The purified CaCO_3 is collected in a quartz crucible and is calcinated at $450\text{ }^\circ\text{C}$ for two hours inside a closed furnace.

Chapter 8

Offline software

The offline software will process measurement data recorded by the DAQ system as well as Monte Carlo (MC) simulation results (Chapter 6) (see Fig. 8.1). The offline framework will support consistent and systematic data processing for different experimental configurations or data formats. It will be used to maintain and handle data sets.

The raw data written by the DAQ system will be processed by the data analysis framework (Fig. 8.2), and processed measurements from triggered events will be stored in a file using a tree-structure called an ntuple. Similarly, MC simulation results will be processed by the same data analysis calculation routines, so that efficiencies of triggering and selection requirements can be determined.

An additional digitization processing of MC events will produce simulated pulse shapes, creating data records with the same structure as the real data for analysis by the same framework as the real data. The current AMoRE-I simulation package outputs the energy that is deposited in crystals, but does not generate a time-domain pulse shape. Software for pulse-shape generation of MC events is in progress.

Design of data analysis framework is not finalized yet. Research and development on the framework is on-going. The basic structure of the current version

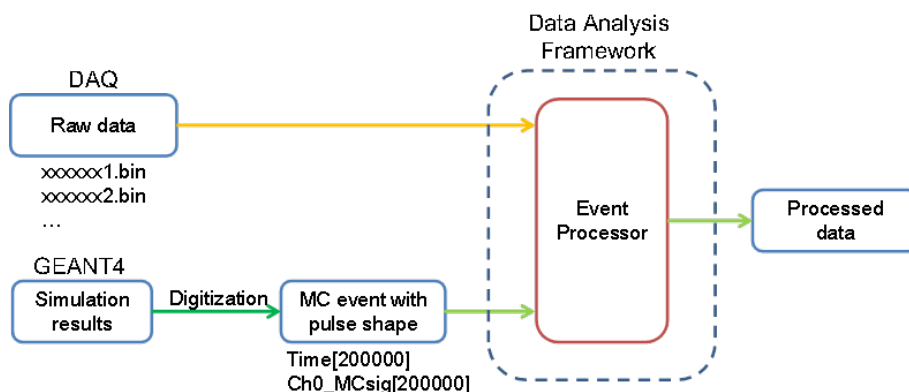

Figure 8.1: Offline framework overview.

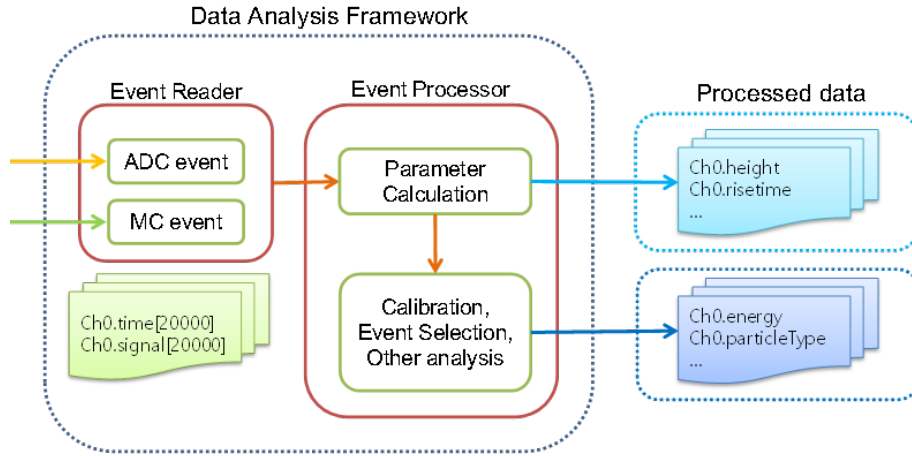

Figure 8.2: Data analysis framework scheme.

of the framework is shown in Figure 8.1.

8.1 Environment

The data analysis framework is being developed on a linux server, Scientific Linux 6.3. The measured data and the simulation results are stored in the same system at the Center for Underground Physics, IBS. The data analysis framework software is written in C/C++ and uses ROOT libraries (Ver. 5.24). The framework software will be executed by ROOT scripts or binary executable files.

8.2 Modules

The main processor of the data analysis framework, `EventProcessor`, consists of two subclasses, `EventReader` and `EventParameter`.

`EventReader` is a routine to read events from files. When the DAQ data format is modified, the read-out routine in the framework should be updated accordingly. Depending on the data format version, a proper read-out routine can be used. Similarly, a read-out routine for MC simulation data will be added as a module. `EventParameter` is a routine to calculate variables of each event such as, baseline, pulse height, rise time, etc. User-defined functions or calculation algorithm can be added as new modules.

More analysis routines, such as optimal filtering, event selection requirements will be implemented in the future.

Chapter 9

Time, Schedule

9.1 Schedules

The AMoRE project will start with the preparation of the 1st phase experiment and R&D for the 2nd phase. The 1st phase experiment will be performed also in two steps: first with 1.5 kg of CaMoO_4 crystals and later with 5 kg of the crystals. The 5 kg 1st phase will start at the end of 2016 and will run for about three years.

The R&D for the 2nd phase includes cryogenic techniques, the development of light sensors, and the reduction of background levels. After three years of R&D, the mass production of crystals and the design of the detector configuration for the 2nd phase will begin. The setup for the 2nd phase will be ready by the end of the 1st phase data-taking. The detailed schedule for each step is given in the Gantt plot below. The 2nd phase of the experiment will begin in early 2020 with 70 kg of CaMoO_4 , and will be upgraded to 200 kg in the following year.

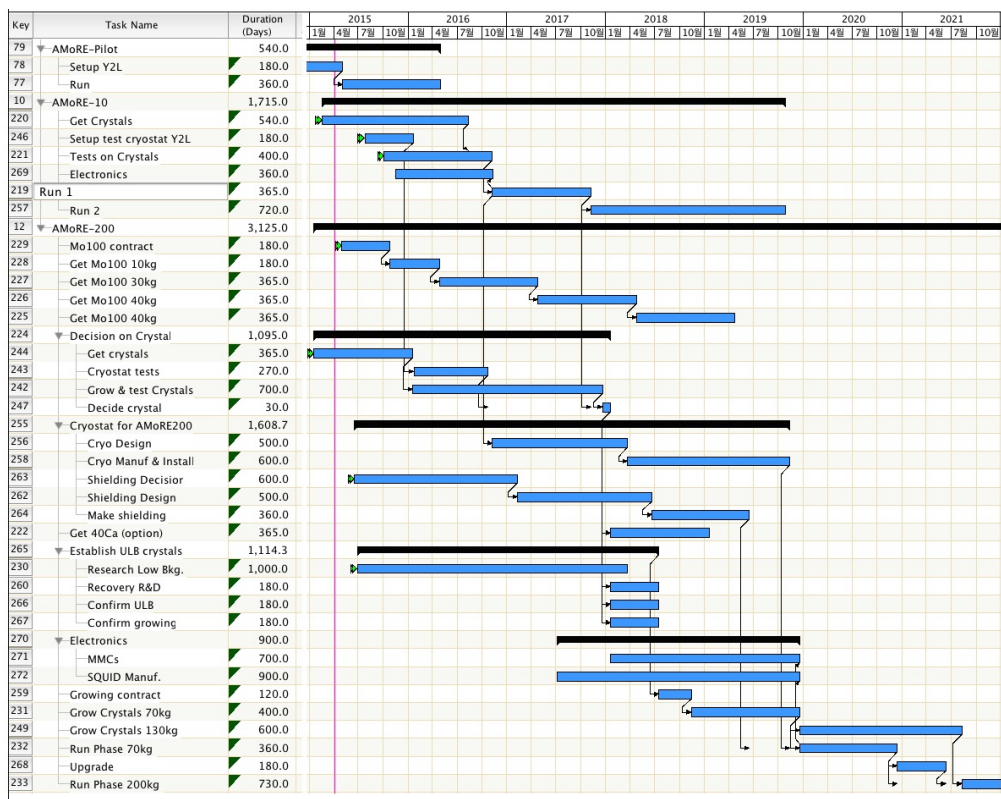

Figure 9.1: The time schedule of AMoRE project.

Bibliography

- [1] R. N. Mohapatra, S. Antusch, K. S. Babu, et al., Theory of neutrinos: A white paper, Rep. on Prog. Phys. 70 (2007) 1757.
- [2] C. Giunti, C. W. Kim, Fundamentals of neutrino physics and astrophysics, Oxford Press (2009).
- [3] J. D. Vergados, Neutrinoless double β decay from a modern perspective, Phys. Rep. 361 (2002) 1.
- [4] G. L. Fogli, Observables sensitive to absolute neutrino masses: A reappraisal after wmap 3-year and first MINOS results, Phys. Rev. D 75 (2007) 053001.
- [5] F. T. A. III, S. R. Elliott, J. Engel, Double beta decay, Rev. Mod. Phys. 80 (2008) 481.
- [6] W. Rodejohann, Neutrino-less double beta decay and particle physics, Int. J. Mod. Phys. E 20 (2011) 1833.
- [7] J. D. Vergados, H. Ejiri, F. Šimkovic, Rep. Prog. Phys. 75 (2012) 106301.
- [8] J. Barea, et al., Limits on neutrino masses from neutrinoless double- β decay, Phys. Rev. Lett. 109 (2012) 042501.
- [9] K. Alfonso, et al., Search for neutrinoless double beta decay of ^{130}Te with CUORE-0, Phys. Rev. Lett. 115 102502.
- [10] M. Auger, et al., Search for neutrinoless double-beta decay in ^{136}Xe with EXO-200, Phys. Rev. Lett. 109 (2012) 032505.
- [11] M. Agostini, et al., Limit on neutrinoless double beta decay of ^{76}Ge by GERDA, Phys. Procedia: *13th International Conference on Topics in Astroparticle and Underground Physics* 61 (2015) 828.
- [12] A. Gando, et al., Limit on neutrinoless $\beta\beta$ Decay of ^{136}Xe from the first phase of KamLAND-Zen and comparison with the positive claim in ^{76}Ge , Phys. Rev. Lett. 110 (2013) 062502.
- [13] A. S. Barabash, V. B. Brudanin (NEMO Collaboration), Investigation of double-beta decay with the NEMO-3 detector, Phys. At. Nucl. 74 (2011) 312.

- [14] A. Faessler, et al., Nuclear matrix elements for neutrinoless double-beta decay and double-electron capture, *J. Phys. G: Nucl. Part. Phys.* 39 (2012) 124006.
- [15] S. M. Bilenky, C. Giunti, Neutrinoless double-beta decay. a brief review, *Mod. Phys. Lett. A* 27 (2012) 1230015.
- [16] F. F. Deppisch, M. Hirsch, H. Pas, Neutrinoless double-beta decay and physics beyond the standard model, *J. Phys. G: Nucl. Part. Phys.* 39 (2012) 124007.
- [17] E. Fireman, Artificial radioactive substances, *Phys. Rev.* 74 (1948) 1238.
- [18] O. K. Manuel, Geochemical measurements of double-beta decay, *J. Phys. G: Nucl. Part. Phys.* 17 (1991) 5221.
- [19] S. R. Elliott, A. A. Hahn, M. K. Moe, Direct evidence for two-neutrino double-beta decay in ^{82}Se , *Phys. Rev. Lett.* 59 (1987) 2020.
- [20] V. I. Tretyak, Y. G. Zdesenko, *Atom. Data and Nucl. Data Tables* 80 (2002) 83.
- [21] A. S. Barabash, Precise half-life values for two-neutrino double- β decay, *Phys. Rev. C* 81 (2010) 035501.
- [22] R. Saakyan, Two-neutrino double-beta decay, *Ann. Rev. Nucl. Part. Sci.* 63 (2013) 503.
- [23] Y. M. Gavriluk, A. M. Gangapshev, V. V. Kazalov, V. V. Kuzminov, Indications of $2\nu 2K$ capture in ^{78}Kr , *Phys. Rev. C* 87 (2013) 035501.
- [24] A. P. Meshik, C. M. Hohenberg, O. V. Pravdivtseva, Y. S. Kapusta, Weak decay of ^{130}Ba and ^{132}Ba : Geochemical measurements, *Phys. Rev. C* 64 (2001) 935205.
- [25] M. Pujol, B. Marty, P. Burnard, P. Philippot, Xenon in archean barite: Weak decay of ^{130}Ba , mass-dependent isotopic fractionation and implication for barite formation, *Geochem. Cosmochem. Acta* 73 (2009) 6834.
- [26] S. R. Elliott, Recent progress in double beta decay, *Mod. Phys. Lett. A* 27 (2012) 123009.
- [27] A. Giuliani, A. Poves, *Advances in High Energy Physics* 2012 (012) 857016.
- [28] O. Cremonesi, M. Pavan, Challenges in double beta decay, *Advances in High Energy Physics* 2014 (2014) 951432.
- [29] J. B. Albert, et al., Search for Majorana neutrinos with the first two years of EXO-200 data, *Nature* 510 (2014) 229.
- [30] M. Agostini, et al., Results on neutrinoless double- β decay of ^{76}Ge from phase i of the GERDA experiment, *Phys. Rev. Lett.* 111 (2013) 122503.

- [31] K. Asakura, et al., Results from KamLAND-Zen, arXiv: 1409.0077v1.
- [32] R. Arnold, et al., Search for neutrinoless double-beta decay of ^{100}Mo with the NEMO-3 detector, *Phys. Rev. D* 89 (2014) 111101(R).
- [33] H. V. Klapdor-Kleingrothaus, I. V. Krivosheina, The evidence for the observation of $0\nu\beta\beta$ decay: the identification of $0\nu\beta\beta$ events from the full spectra, *Mod. Phys. Lett. A* 21 (2006) 1547.
- [34] H. V. Klapdor-Kleingrothaus, et al., Latest results from the Heidelberg-Moscow double beta decay experiment, *Eur. Phys. J. A* 12 (2001) 147.
- [35] H. V. Klapdor-Kleingrothaus, et al., Search for neutrinoless double beta decay with enriched ^{76}Ge in Gran Sasso 1990-2003, *Phys. Lett. B* 586 (2004) 198.
- [36] H. V. Klapdor-Kleingrothaus, et al., Data acquisition and analysis of the ^{76}Ge double beta experiment in Gran Sasso 1990-2003, *Nucl. Instr. Meth. A* 522 (2004) 371.
- [37] C. E. Aalseth, et al., Comment on evidence for neutrinoless double beta decay, *Mod. Phys. Lett. A* 17 (2002) 1475.
- [38] F. Feruglio, A. Strumia, F. Vissani, Neutrino oscillations and signals in β and $0\nu 2\beta$ experiments, *Nucl. Phys. B* 637 (2002) 345.
- [39] Y. G. Zdesenko, F. A. Danevich, V. I. Tretyak, Has neutrinoless double β decay of ^{76}Ge been really observed?, *Phys. Lett. B* 546 (2002) 206.
- [40] M. Wang, et al., The AME2012 atomic mass evaluation (II). Tables, graphs and references, *Chin. Phys. C* 36 (2012) 1603.
- [41] M. Berglund, M. E. Wieser, Isotopic compositions of the elements 2009 (IUPAC technical report), *Pure Appl. Chem.* 83 (2011) 397.
- [42] S. Umehara, et al., Neutrino-less double-beta decay of Ca-48 studied by Ca F(2)(Eu) scintillators, *Phys. Rev. C* 78 (2008) 058501.
- [43] C. E. Aalseth, et al., The IGEX ^{76}Ge neutrinoless double-beta decay experiment: prospects for next generation experiments, *Phys. Rev. D* 65 (2002) 092007.
- [44] F. A. Danevich, et al., Search for 2β decay of cadmium and tungsten isotopes: Final results from the Solotvina experiment, *Phys. Rev. C* 68 (2003) 035501.
- [45] T. Bernatowicz, et al., Precise determination of relative and absolute $\beta\beta$ -decay rates of ^{128}Te and ^{130}Te , *Phys. Rev. C* 47 (1993) 806.
- [46] J. Argyriades, et al., Measurement of the double- β decay half-life of ^{150}Nd and search for neutrinoless decay modes with the NEMO-3 detector, *Phys. Rev. C* 80 (2009) 032501(R).

- [47] A. Giuliani, Searches for neutrinoless double beta decay, *Acta Physica Polonica B* 41 (2010) 1447.
- [48] A. S. Barabash, The new generation of double beta decay experiments: are there any limitations?, *J. Phys. G: Nucl. Part. Phys.* 39 (2012) 085103.
- [49] J. J. Gomez-Cadenas, et al., The search for neutrinoless double beta decay, *Riv. Nuovo Cim.* 35 (2012) 29.
- [50] B. Schwingenheuer, Status and prospects of searches for neutrinoless double beta decay, *Ann. Phys.* 525 (2013) 269.
- [51] S. M. Bilenky, C. Giunti, Neutrinoless double-beta decay: A probe of physics beyond the standard model, *Int. J. Mod. Phys. A* 30 (2015) 1530001.
- [52] C. Arnaboldi, et al., CUORE: a cryogenic underground observatory for rare events, *Nucl. Instr. Meth. A* 518 (2004) 775.
- [53] R. Arnold, et al., Probing new physics models of neutrinoless double beta decay with SuperNEMO, *Eur. Phys. J. C* 70 (2010) 927.
- [54] J. W. Beeman, et al., A next generation neutrinoless double beta decay experiment based on ZnMoO_4 scintillating bolometers, *Phys. Lett. B* 710 (2012) 318.
- [55] V. Alvarez, et al., NEXT-100 technical design report (TDR). Executive summary, *JINST* 7 (2012) T06001.
- [56] J. J. Gomez-Cadenas, et al., Present status and future perspectives of the NEXT experiment, *Advances in High Energy Physics* 2014 (2014) 907067.
- [57] K. Graham (EXO Collaboration), The EXO search for neutrinoless double beta decay, *International Workshop on Double Beta Decay and Underground Science* (2014).
- [58] K. Ishidoshiro (KamLAND Collaboration), KamLAND-Zen, *International Workshop on Double Beta Decay and Underground Science DBD2014* (2014).
- [59] M. Heisel (GERDA Collaboration), Upgrades for GERDA Phase II, *International Workshop on Double Beta Decay and Underground Science DBD2014* (2014).
- [60] N. Abgrall (Majorana Collaboration), The MAJORANA Demonstrator neutrinoless double-beta decay experiment., *Advances in High Energy Physics* 2014 (2014) 36543.
- [61] N. M. Bongrand, Latest results of the NEMO experiment and status of SuperNEMO, *Proceedings of the TAUP 2013* (2013) 33.

- [62] P. G. Jones (SNO+ Collaboration), The SNO+ experiment, International Workshop on Double Beta Decay and Underground Science DBD2014 (2014).
- [63] S. Rahaman, et al., Q value of the ^{76}Ge and ^{100}Mo double-beta decay, Phys. Lett. B 662 (2008) 111.
- [64] V. A. Rodin, A. Faessler, F. Šimkovic, P. Vogel, Assessment of uncertainties in QRPA $0\nu\beta\beta$ -decay nuclear matrix elements, Nucl. Phys. A 766 (2006) 107.
- [65] V. A. Rodin, A. Faessler, F. Šimkovic, P. Vogel, Assessment of uncertainties in QRPA $0\nu\beta\beta$ -decay nuclear matrix elements, Nucl. Phys. A 793 (2007) 213.
- [66] M. Kortelainen, J. Suhonen, Nuclear matrix elements of $0\nu\beta\beta$ decay with improved short-range correlations, Phys. Rev. C 76 (2007) 024315.
- [67] F. Šimkovic, A. Faessler, V. Rodin, P. Vogel, J. Engel, Anatomy of the $0\nu\beta\beta$ nuclear matrix elements, Phys. Rev. C 77 (2008) 045503.
- [68] A. Faessler, et al., Overconstrained estimates of neutrinoless double beta decay within the QRPA, J. Phys. G: Nucl. Part. Phys. 35 (2008) 075104.
- [69] J. Barea, F. Iachello, Neutrinoless double- β decay in the microscopic interacting boson model, Phys. Rev. C 79 (2009) 044301.
- [70] J. Kotila, J. Suhonen, D. S. Delion, Description of the two-neutrino $\beta\beta$ decay of ^{100}Mo by pnMAVA, J. Phys. G 37 (2010) 0015101.
- [71] P. K. Rath, et al., Uncertainties in nuclear transition matrix elements for neutrinoless $\beta\beta$ decay within the projected-Hartree-Fock-Bogoliubov model, Phys. Rev. C 82 (2010) 064310.
- [72] T. R. Rodriguez, G. Martinez-Pinedo, Energy density functional study of nuclear matrix elements for neutrinoless $\beta\beta$ -decay, Phys. Rev. Lett. 105 (2010) 252503.
- [73] A. S. Barabash, et al., Enriched $\text{Zn}^{100}\text{MoO}_4$ scintillating bolometers to search for $0\nu\beta\beta$ decay of ^{100}Mo with the LUMINEU experiment, Eur. Phys. J. C 74 (2014) 3133.
- [74] R. Arnold, et al., First results of the search for neutrinoless double-beta decay with the NEMO 3 detector, Phys. Rev. Lett. 95 (2005) 182302.
- [75] H. Ejiri, et al., Limits on the majorana neutrino mass and right-handed weak currents by neutrinoless double β decay of ^{100}Mo , Phys. Rev. C 63 (2001) 065501.
- [76] L. Gironi, Performance of ZnMoO_4 crystal as cryogenic scintillating bolometer to search for double beta decay of molybdenum, J. Instrum. 5 (2010) P11007.

- [77] J. W. Beeman, et al., ZnMoO₄: A promising bolometer for neutrinoless double beta decay searches, *Astropart. Phys.* 35 (2012) 813.
- [78] J. W. Beeman, et al., An improved ZnMoO₄ scintillating bolometer for the search for neutrinoless double beta decay of ¹⁰⁰Mo, *J. Low Temp. Phys.* 167 (2012) 1021.
- [79] J. W. Beeman, et al., Performances of a large mass ZnMoO₄ scintillating bolometer for a next generation $0\nu\beta\beta$ experiment, *Eur. Phys. J. C* 72 (2012) 2142.
- [80] D. M. Chernyak, et al., Optical, luminescence and thermal properties of radiopure ZnMoO₄ crystals used in scintillating bolometers for double beta decay search, *Nucl. Instr. Meth. A* 729 (2013) 856.
- [81] L. Berge, et al., Purification of molybdenum, growth and characterization of medium volume ZnMoO₄ crystals for the LUMINEU program, *JINST* 9 (2014) 06004.
- [82] M. V. Korzhik, et al., CaMoO₄ scintillation crystal for the search of ¹⁰⁰Mo double beta decay, *IEEE Trans. Nucl. Sci.* 52 (2005) 1131.
- [83] A. N. Annenkov, et al., Development of CaMoO₄ crystal scintillators for a double beta decay experiment with ¹⁰⁰Mo, *Nucl. Instr. Meth. A* 584 (2008) 334.
- [84] S. J. Lee, et al., The development of a cryogenic detector with CaMoO₄ crystals for neutrinoless double beta decay search, *Astropart. Phys.* 34 (2011) 732.
- [85] J. H. So, et al., A study of CaMoO₄ crystals for the AMoRE experiment, *Nucl. Sci. Symp.* (2012) 1987.
- [86] V. B. Mikhailik, H. Kraus, Cryogenic scintillators in searches for extremely rare events, *J. Phys. D: Appl. Phys.* 39 (2006) 1181.
- [87] F. A. Danevich, et al., Feasibility study of PbWO₄ and PbMoO₄ crystal scintillators for cryogenic rare events experiments, *Nucl. Instr. Meth. A* 622 (2010) 608.
- [88] O. Barinova, First test of Li₂MoO₄ crystal as a cryogenic scintillating bolometer, *Nucl. Instr. Meth. A* 613 (2010) 54.
- [89] L. Cardani, et al., Development of a Li₂MoO₄ scintillating bolometer for low background physics, *JINST* 8 (2013) P10002.
- [90] T. B. Bekker, et al., Aboveground test of an advanced Li₂MoO₄ scintillating bolometer to search for neutrinoless double beta decay of ¹⁰⁰Mo, *Astropart. Phys.* 72 (2013) 38.
- [91] H. J. Kim, A search for the 0-neutrino double beta decay with the CaMoO₄ scintillation crystal, *Proc. New Views in Particle Physics (Vietnam)* (2004).

- [92] O. Polischuk, et al., Investigation of double beta decay of ^{116}Cd with the help of enriched $^{116}\text{CdWO}_4$ crystal scintillators, AIP Conf. Proc. 1686 (2015) 020017.
- [93] M. V. Korzhik, et al., Large volume CaMoO_4 scintillation crystals, IEEE Trans. Nucl. Sci. 55 (2008) 1473.
- [94] H. J. Kim, et al., Neutrino-less double beta decay experiment using $\text{Ca}^{100}\text{MoO}_4$ scintillation crystals, IEEE Trans. Nucl. Sci. 57 (2010) 1475.
- [95] J. H. So, et al., Scintillation properties and internal background study of $^{40}\text{Ca}^{100}\text{MoO}_4$ crystal scintillators for neutrino-less double beta decay search, IEEE Trans. Nucl. Sci. 59 (2012) 2214.
- [96] F. Šimkovic, A. Faessler, H. Muther, V. Rodin, M. Stauf, Anatomy of the $0\nu\beta\beta$ nuclear matrix elements, Phys. Rev. C 79 (2009) 055501.
- [97] K. Nassau, A. M. Broyer, Application of czochralski crystal-pulling technique to high-melting oxides, J. Am. Ceram. Soc. 45 (1962) 474.
- [98] M. Solskii, D. Y. Sugak, M. M. Vakiv, Growing large-size complex-oxide single crystals by the czochralski technique for electronic devices, Acta Physica Polonica. 124 (2013) 314.
- [99] F. A. Danevich, A. S. Georgadze, V. V. Kobychiev, V. M. Mokina, S. S. Nagorny, D. V. Poda, R. B. Podviynuk, V. I. Tretyak, S. S. Yurchenko, Measurements of scintillation properties and radioactive contamination of CaMoO_4 crystal scintillators for dark matter experiments. LPD technical report 01/2007, Tech. rep., INR NAS of Ukraine (06 Feb 2007).
- [100] A. Senyshyn, H. Kraus, V. B. Mikhailik, L. Vasilenkko, M. Knapp, Thermal properties of CaMoO_4 : Lattice dynamics and synchrotron powder diffraction studies, Phys. Rev. B 73 (2006) 014104.
- [101] H. S. Lee, et al., First limit on WIMP cross section with low background CsI(Tl) crystal detector, Phys. Lett. B 633 (2006) 201.
- [102] H. S. Lee, et al., Limits on interactions between weakly interacting massive particles and nucleons obtained with CsI(Tl) crystal detectors, Phys. Rev. Lett. 99 (2007) 091301.
- [103] J. T. M. de Hass, P. Dorenbos, C. W. E. van Eijk, Measuring the absolute light yield of scintillators, Nucl. Instr. Meth. A 537 (2005) 97.
- [104] V. B. Mikhailik, et al., Temperature dependence of CaMoO_4 scintillation properties, Nucl. Instr. Meth. A 583 (2007) 350.
- [105] in: C. Enss (Ed.), Cryogenic Particle Detection, Springer, 2005.
- [106] A. Fleischmann, C. Enss, G. M. Seidel, Metallic magnetic calorimeters, Top. Appl. Phys. 99 (2005) 151.

- [107] A. Fleischmann, Metallic magnetic calorimeters for atomic, molecular and particle physics, Tech. rep., Shanghai, China (11 2014).
- [108] P. C. Ranitzsch, et al., Development of cryogenic alpha spectrometers using metallic magnetic calorimeters, Nucl. Instr. Meth. A 652 (2011) 299.
- [109] W. S. Yoon, et al., Nucl. Instr. Meth. A 784 (2014) 143.
- [110] G. B. Kim, et al., A CaMoO_4 crystal low yemperature detector for the AMoRE neutrinoless double beta decay search, Advances in High Energy Physics 2014 (2014) 817530.
- [111] H. J. Lee, et al., Development of a scintillating light detector for a cryogenic rare-event-search experiment, Nucl. Instr. Meth. A 784 (2014) 508.
- [112] S. Agostinelli, et al., Geant4 – a simulation toolkit, Nucl. Instr. Meth. A 506 (2003) 250.
- [113] J. Allison, et al., Geant4 developments and applications, IEEE Trans. Nucl. Sci. 53 (2006) 270.
- [114] D. Mei, A. Hime, Muon-induced background study for underground laboratories, Phys. Rev. D 73 (2006) 053004.
- [115] D. E. Groom, N. V. Mokhov, S. I. Striganov, Muon stopping power and range tables 10 MeV-100 TeV, At. Data Nucl. Data Tables 78 (2001) 183.
- [116] N. Khanbekov, V. V. Alenkov, A. A. Burenkov, O. A. Buzanov, V. N. Kornoukhov, Data analysis of the internal background measurements of $^{40}\text{Ca}^{100}\text{MoO}_4$ scintillation crystals, Nucl. Phys. Atom. Energy 14 (2013) 199.
- [117] V. Kumar, R. Goel, R. Chawla, M. Silambarasan, R. K. Sharma, Chemical, biological, radiological, and nuclear decontamination: Recent trends and future perspectives, J. Pharm. Bioallied Sci. 2 (2010) 220.