

# Discrete Route/Trajectory Decision Making Problems

Mark Sh. Levin <sup>a \*</sup>

<sup>a</sup> Inst. for Information Transmission Problems, Russian Academy of Sciences  
19 Bolshoj Karetny Lane, Moscow 127994, Russia

The paper focuses on composite multistage decision making problems which are targeted to design a route/trajectory from an initial decision situation (origin) to goal (destination) decision situation(s). Automobile routing problem is considered as a basic “physical” metaphor. The problems are based on a discrete (combinatorial) operations/states “design/solving space” (e.g., digraph). The described types of discrete decision making problems can be considered as “intelligent” design of a route (trajectory, strategy) and can be used in many domains: (a) education (planning of student educational trajectory), (b) medicine (medical treatment), (c) economics (trajectory of start-up development).

Several types of the route decision making problems are described: (i) basic route decision making, (ii) multi-goal route decision making, (iii) multi-route decision making, (iv) multi-route decision making with route/trajectory change(s), (v) composite multi-route decision making (solution is a composition of several routes/trajectories at several corresponding domains), and (vi) composite multi-route decision making with coordinated routes/trajectories. In addition, problems of modeling and building the “design spaces” are considered. Numerical examples illustrate the suggested approach. Three applications are considered: educational trajectory (orienteering problem), plan of start-up company (modular three-stage design), and plan of medical treatment (planning over digraph with two-component vertices).

*Keywords:* Decision making, Routing, Trajectory design, Combinatorial optimization, Composition, Frameworks, Heuristics, Applications, Education, Medical treatment Firm development

## Contents

<b>1</b>	<b>Introduction</b>	<b>2</b>
<b>2</b>	<b>Route decision making problems</b>	<b>3</b>
2.1	Basic problems . . . . .	3
2.2	Design and structuring of design space . . . . .	5
2.3	Types of model nodes . . . . .	7
2.4	Basic solving strategies . . . . .	9
<b>3</b>	<b>Some applied route decision making problems</b>	<b>10</b>
3.1	Student orienteering problem (educational trajectory) . . . . .	10
3.2	Scenario planning for start-up company . . . . .	13
3.3	Simplified example for planning of medical treatment . . . . .	16
<b>4</b>	<b>Conclusion</b>	<b>20</b>

---

\*E-mail address: mslevin@acm.org

## 1. Introduction

This paper focuses on composite multistage discrete decision making problems which are targeted to design a route (trajectory, strategy) from an initial decision situation (source point, origin) to goal (destination) decision situation(s). The problems are based on discrete (combinatorial) operations/states (i.e., a “space”, e.g., digraph/network, automata model). A generalized three-part scheme (morphological structure) of the examined domain (route/trajectory decision making problems) is depicted in Fig. 1. Evidently, various versions of the shortest path problem correspond to a basis (“reference” problem) for the considered class of combinatorial problems (e.g., [2,9,27,31,35,42,53,109,123]). Another basic problem corresponds to control engineering: designing a control trajectory (e.g., for controller) (e.g., [34,39,56,86,93,96]). The third basic analogue for the problem corresponds to planning of mobile robot trajectory (e.g., [11,66,106,110]). The fourth basic analogue for the considered problem may be found as a search strategy in problem solving (e.g., [80,85,103]). Two well-known problems as basic “physical” metaphors are: (i) automobile routing problems (e.g., [15,32,38,63]), (ii) team orienteering problems (e.g., [5,20,44,50,115]).

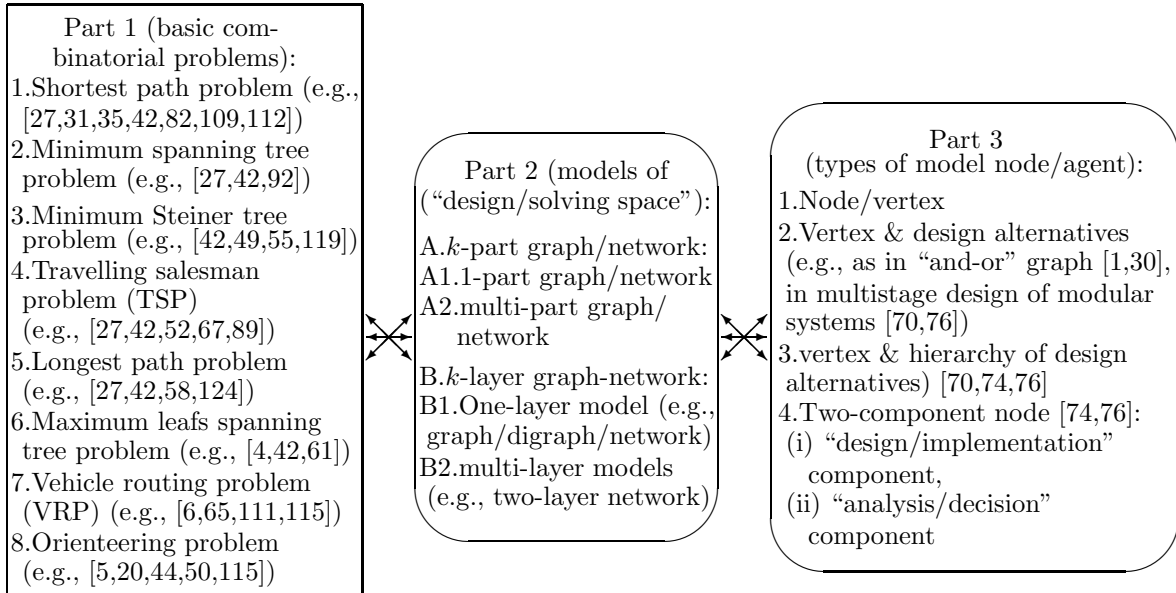

Fig. 1. Generalized three-part scheme of route/trajectory decision making problems

In this paper, the shortest path problem (part 1 from Fig. 1) is composed with one/two-layer model (part 2 from Fig. 1) and various versions of node/agent types (part 3 from Fig. 2). In addition, the team orienteering problem is used as well (in an educational example). A list of various route/trajectory-like decision making problems is pointed out in Table 1.

The suggested type of composite decision making problems can be considered as “intelligent” design of a route (trajectory, strategy) in many domains, for example: (a) education (e.g., planning of student educational trajectory [69]), (b) medicine (e.g., medical treatment planning/scheduling [70,76,77,91]), (c) tourism (e.g., tourism route planning/recommendation [44,45,104,113,114]). Here, it is necessary to do the following: (1) to build the operations (design/solving) “space”; (2) to specify the goal (possible resultant) point (or set of goal points); (3) to design the route at the design “space”, (4) online analysis of the route implementation and online modification of the route (if needed).

In the paper, several types of the route decision making problems are described: (i) basic route decision making, (ii) multi-goal route decision making, (iii) multi-route decision making, (iv) multi-route decision making with route change(s), (v) composite multi-route decision making (solution is a composition of several routes at several corresponding domains), and (vi) composite multi-route decision making with coordinated routes. The suggested composite approaches/frameworks are illustrated by numerical examples including three applications: (i) design of an individual educational trajectory for a Bachelor student (version of multicriteria orienteering problem), (ii) planning a development trajectory for a start-

up company (modular three-stage design based on hierarchical morphological design), and (iii) planning a medical treatment (route/trajectory over digraph with two-component vertices).

**Table 1.** Route (trajectory/strategy) decision making problems

No.	Problem	Illustration	Source
1.	Basic “reference” problems:		
1.1.	Shortest path problem (including $k$ -path and multicriteria formulations)		[12,27,31,35,42,53,82] [109,112,123]
1.2.	Design of control trajectory in parameter space		[34,39,56,86,93,96]
1.3.	Design of search strategy in problem solving		[80,85,103]
1.4.	Design of trajectory for mobile robot movement		[11,59,66,106,110,120]
1.5.	Design of a mission for airplane/aerospace apparatus (e.g., unmanned aerial vehicles UAVs)		[8,13,17,57,60,99] [102,107,121]
1.6.	Vehicle routing problems		[6,65,111]
1.7.	X-cast (i.e., anycast broadcast, multicast, unicast, geocast) routing in communication/sensor networks		[18,19,26,37,51,62,68] [79,81,83,87,88] [90,95,98,118]
1.8.	Design of system development trajectory for modular system (multistage design)		[70,76]
2.	Basic route DM problems and applied problems:		
2.1.	Basic route DM problem	Fig. 2	
2.2.	Motion planning, navigation (urban traffic planning, automobile routing, robot motion planning, inspection path planning, etc.)		[15,25,28,32,38,59,63] [64,66,108]
2.3.	Team orienteering problem (visiting a subset of graph nodes, combination of knapsack problem and TSP)	Fig. 7	[5,20,21,45,105,115]
2.4.	Tourism route planning/recommendation (Tourist Trip Design Problem)		[44,45,104,113,114]
2.5.	Trajectory search in information systems (e.g., web, including hotlink assignment problems)		[14,29,40,73,76,117]
2.6.	Planning of system maintenance		
2.7.	Scenario planning/multistage scenario planning		[16,24,47,97,101,116]
2.8.	Planning of student educational trajectory	Fig. 18	[69]
2.9.	Medical treatment planning/scheduling (two-layer “design space” and problem)	Fig. 25	[70,76,77,91]
2.10.	Trajectory of start-up development		[76]
3.	Examined structural problems:		
3.1.	Multi-route DM problem	Fig. 4	
3.2.	Multi-goal multi-route DM problem	Fig. 5	
3.3.	Multi-route DM problem with route change(s)	Fig. 6	
3.4.	Composite (multi-domain) multi-route DM problem (solution is a composition of several routes)	Fig. 10	
3.5.	Composite (multi-domain) multi-route DM problem with coordinated routes	Fig. 11	
3.6.	Composite three-domain multi-route DM problem (three basic combinatorial problems)	Fig. 12	
3.6.	Composite two-layer five-domain multi-route DM problem in communication system	Fig. 13	

## 2. Route decision making problems

### 2.1. Basic problems

The basic routing decision making problem (“physical” car routing) is depicted in Fig. 2. Here, graph  $G = (H, E)$  is given, initial vertex  $h^0 \in H$  and goal (destination) vertex  $h^g \in H$  are pointed out, each

edge/arc  $e \in E$  has a length (i.e., positive weight, cost)  $a(e)$ . The problem is:

Find the route (path) from vertex  $h^0$  to vertex  $h^g$   $L = \langle h^0, \dots, h^g \rangle$  that minimizes the length (cost) of the path (i.e., the sum of the path edges/arcs weights).

Note, various versions of the problems are under examination including searching for  $k$ -path problem, multi-objective problems, online problems (e.g., [27,31,35,42,53,109,123]). Several polynomial algorithms have been suggested for the problem (including polynomial algorithms for multi-objective versions) (e.g., [23,27,31,42,82,109,112,122])

Generally, the following support problems can be pointed out: (i) building the route (design), (ii) online analysis of the route implementation and online modification (correction) of the route. Basic simplification approach consists in partitioning the initial solving “space” into series of “subspaces” (Fig. 3). This approach is close to dynamic programming scheme.

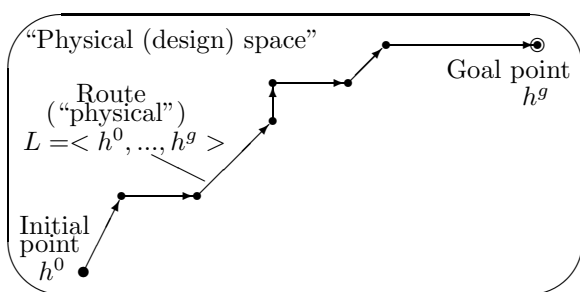

Fig. 2. Basic routing problem (e.g., car routing)

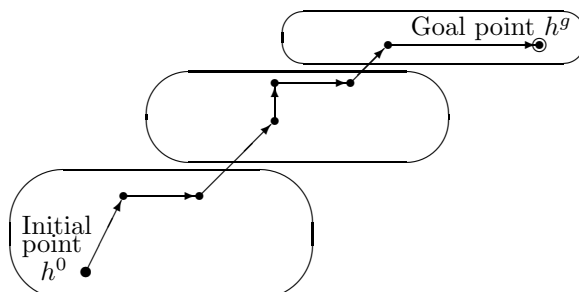

Fig. 3. Simplified/partitioned “solving space”

Now let us consider some other versions of basic route/trajectory DM problems.

A multi-route DM problem is depicted in Fig. 4 (i.e., searching for the best  $k$  routes or concurrent examination of several different basic (e.g., shortest path) problems). On other hand, an analogical multi-goal problem can be considered (Fig. 5) (e.g., a set of basic problems with different goal nodes).

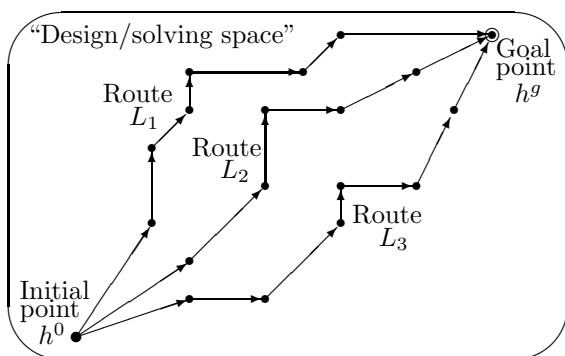

Fig. 4. Multi-route DM problem

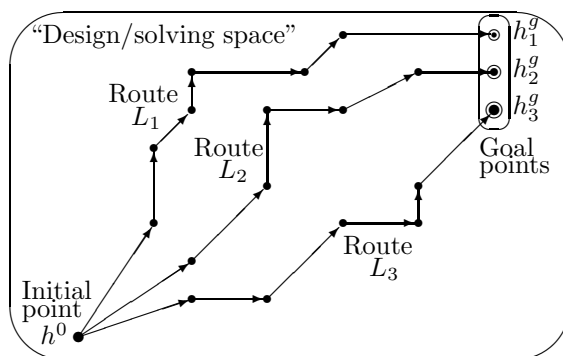

Fig. 5. Multi-goal, multi-route DM problem

Illustration for multi-route DM problem with route changes is depicted in Fig. 6. This approach can be useful in case of online taking into account external environment and changing the solution. Thus, the solving framework is the following:

*Stage 1 (preliminary).* Analysis of initial environment (i.e., situation) and obtaining several solutions (paths).

*Stage 2 (start).* Selection of the best path and its execution.

*Stage 3 (intermediate).* Analysis of external environment (i.e., change of the situation). Change the path (if it needed): (i) selection of the best of the solution (path), (ii) movement to the selected path.

*Stage 4.* Stop.

Note, some basic route DM problems (and their variants) are well-known, for example (Fig. 1): (a) minimum spanning tree problems (e.g., [27,42,49,55,92,119]); (b) traveling salesman problem (e.g., [27,42,52,89]); (c) longest path problem (e.g., [27,42,58,124]); (d) maximum leaves spanning tree problem (e.g., [4,42,61]); (e) vehicle routing problem (VRP) (e.g., [6,12,65,84,111,115]).

Further, the orienteering problem and its modifications will be used as basic ones (main applied domains: logistics, sport, tourism) (e.g., [5,20,21,43,44,45,46,50,104,105,114,115]) (Fig. 7). In fact, the problem integrates knapsack problem and TSP. Here, graph  $G = (H, E)$  ( $|H| = n$ ) is given, each vertex  $h \in H$  has a nonnegative score (profit)  $\theta(h)$ , each edge/arc  $e \in E$  has a nonnegative length (cost, travel time)  $\lambda(e)$ . The problem is (e.g., [5,20,21,43,44,45,46,50,115]):

Find a route (a path from the start point  $h^0 \in H$  to the end point  $h^g \in H$ ) over a subset of the most important graph vertices that maximizes the sum of the scores of the selected vertices while taking into account a constraint for route length (cost) (i.e., combination of knapsack problem and TSP).

The mathematical model is formulated as follows:  $H = \{1, \dots, i, \dots, n\}$  is the set of vertex/nodes, vertex 1 is the start point of the route, vertex  $n$  is the end (goal) point of the route, binary variable  $x_{ij} = 1$  if the built route (path) contains arc  $(i, j)$  and  $x_{ij} = 0$  otherwise (vertex  $i$  precedes  $j$ ),  $\theta_i$  is the vertex profit,  $\lambda_{ij}$  is the arc cost (if arc  $(i, j) \in E$ ), ( $d$  is a distance constraint for the built path). The model is:

$$\max \sum_{i=1}^n \sum_{j=1}^n \theta_i x_{ij}$$

$$s.t. \sum_{j=2}^n x_{1j} = \sum_{i=1}^{n-1} x_{in} = 1; \quad \sum_{i=2}^{n-1} x_{ik} = \sum_{j=2}^{n-1} x_{kj} \leq 1, \quad k = \overline{2, n-1}; \quad \sum_{i=1}^n \sum_{j=1}^n \lambda_{ij} x_{ij} \leq d;$$

$$x_{ij} \in \{0, 1\}, \quad i = \overline{1, n}, \quad j = \overline{1, n}.$$

The problem is NP-hard [50]. Multicriteria problem statement can be examined as well (e.g., the score of each vertex is a vector estimate and the objective function is a vector based on the score components summarization).

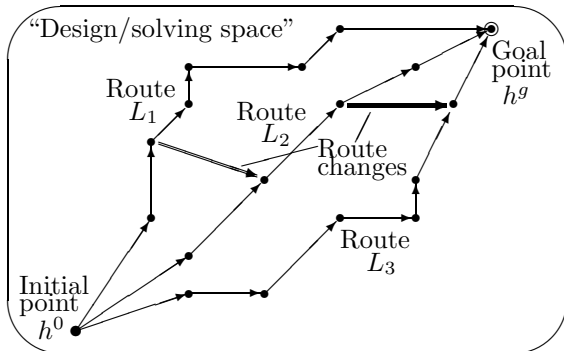

Fig. 6. Multi-route DM problem (route change)

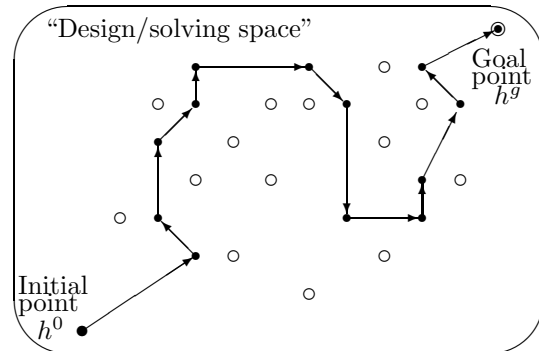

Fig. 7. Team orienteering problem

## 2.2. Design and structuring of design space

Building and structuring of design spaces are crucial problems in many domains (e.g., engineering design, technology forecasting, combinatorial chemistry/drug design, management/decision making) (e.g., [7,41,48,69,70,76,100,125]). Here, “design/solving space” is modeled as a digraph/network. The following possible extensions of “design/solving space” are used:

1. multi-layer structure of “design/solving space” (illustrations are depicted in Fig. 8, Fig. 9);
2. multi-domain case (or multi-part digraph/network) (illustrations are depicted in Fig. 10, Fig. 11, Fig. 12);

3. combined case.

Composite multi-domain route DM problem is illustrated in Fig. 10: composite four-domain route (trajectory)  $S = L_1 \star L_2 \star L_3 \star L_4$  (the design space consists of four subspaces with subsolutions).

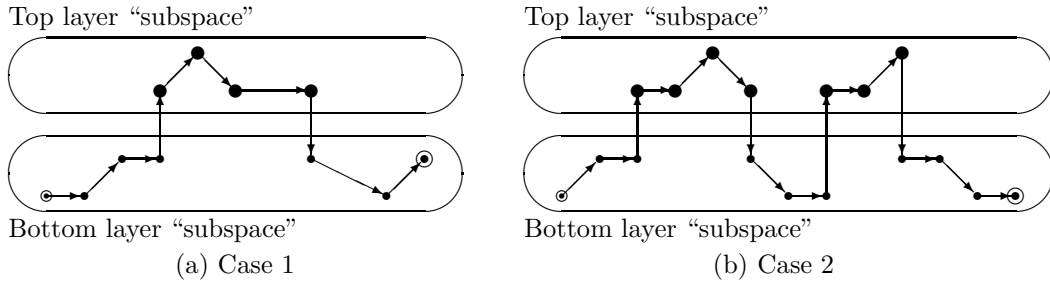

Fig. 8. Two-layer "design/solving spaces"

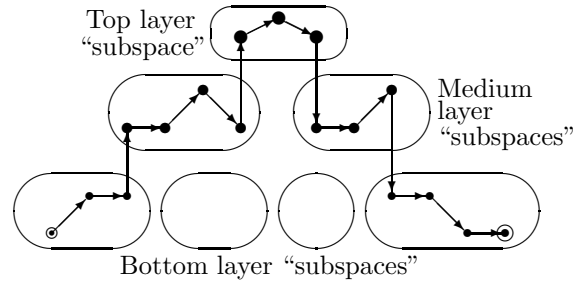

Fig. 9. Three-layer "design/solving space"

In addition, it may be reasonable to consider this multi-domain routing DM problem with coordination of the subsolutions/routes (i.e.,  $L_1, L_2, \dots$ ) at each intermediate time moment ( $\{\tau^1, \tau^2, \dots, \tau^l\}$ ) between start moment  $\tau^0$  and end moment  $\tau^g$ :  $\tau^0 < \tau^1 < \tau^2 < \dots < \tau^l < \tau^g$ . Fig. 11 illustrates the coordination of four routes ( $\{L_1, L_2, L_3, L_4\}$ ) at two time moments:

- (a) coordination 1 at time moment  $\tau'$ : points  $h'_1, h'_2, h'_3, h'_4$ ;
- (b) coordination 2 at time moment  $\tau'' > \tau'$ : points  $h''_1, h''_2, h''_3, h''_4$ .

Three-domain route/trajectory DM problem based on different basic combinatorial optimization route problems (TSP, orienteering problem, shortest path) is depicted in Fig. 12.

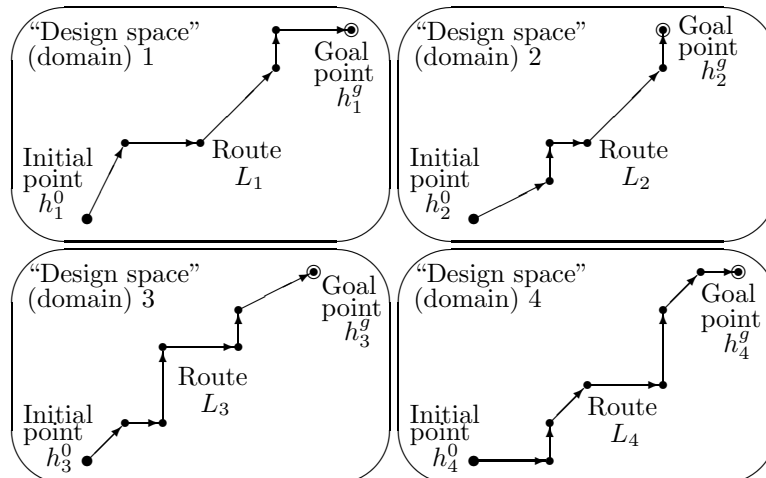

Fig. 10. Four-domain route DM problem

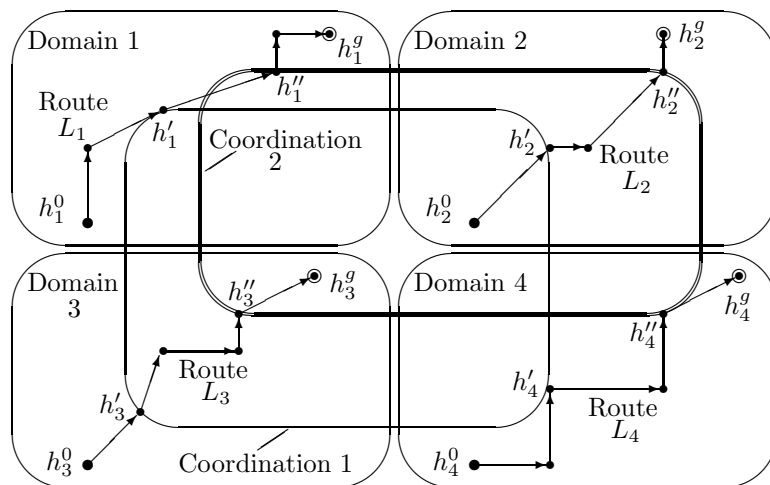

Fig. 11. Four-domain route DM problem with coordination

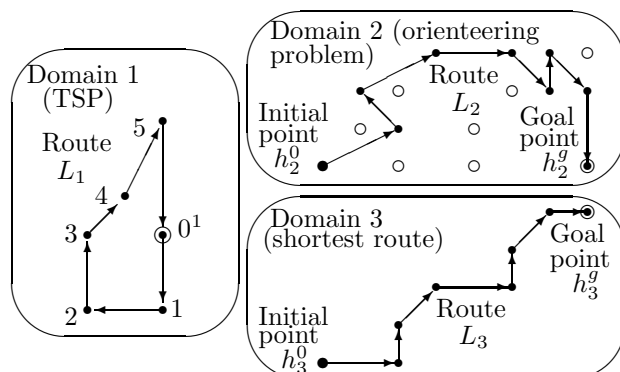

Fig. 12. Three-domain route DM problem

An illustration for two-layer multi-domain routing in communication (sensor) systems is depicted in Fig. 13: from sender node (origin)  $h^0$  to goal nodes (destinations)  $h_{31}^g, h_{32}^g, h_{33}^g, h_{41}^g, h_{42}^g, h_{51}^g, h_{52}^g, h_{53}^g$ . In general, a certain routing problem can be used in each domain (e.g., the shortest path, minimum spanning tree).

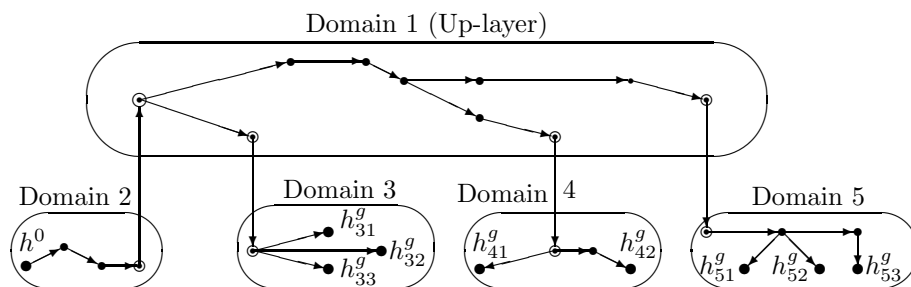

Fig. 13. Illustration of routing in two-layer communication system

### 2.3. Types of model nodes

In this material, “design/solving space” is modeled as a digraph/network. Here, our types of elements (i.e., model nodes/vertices) are considered (Fig. 14):

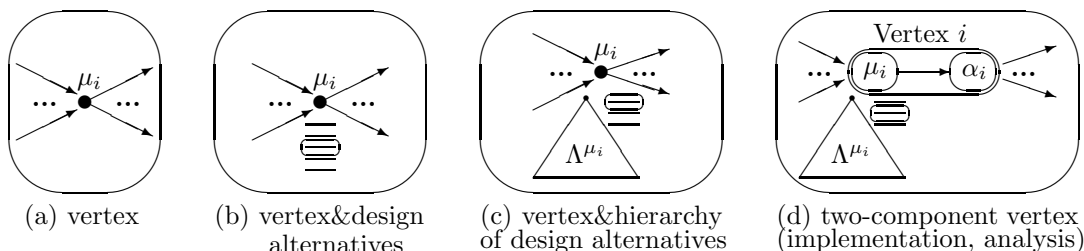

Fig. 14. Four versions of elements in “design/solving spaces”

1. Vertex/node ( $\mu_i$ ) (Fig. 14a). This case corresponds to traditional situation when a digraph is used (e.g., in the shortest path problem).

2. Vertex/node ( $\mu_i$ ) with corresponding design alternatives  $\{A_1^{\mu_i}, \dots, A_{q_{\mu_i}}^{\mu_i}\}$  (problem: selection of the best design alternative for the vertex) (Fig. 14b). This case can be used in routing in “and-or” digraphs (e.g., [1,30,33]), in network routing with selection of the best communication protocol at each node for the implementation (e.g., [22,72,75,94]).

3. Vertex/node ( $\mu_i$ ) and corresponding hierarchy of design alternatives  $\Lambda^{\mu_i}$  (problem: composition of the best composite design alternative(s) on the basis of hierarchy above) (Fig. 14c). This case can be used in network routing with hierarchical modular design of the implemented communication protocol at each node, in combinatorial planning of immunoassay technology (e.g., [70,76,78]).

4. Composite (multi-component) vertex ( $i$ ), for example: two components as follows:

(a) “design/implementation” part ( $\mu_i$ ) (problem: composition of the best composite design alternative on the basis of hierarchy above to implement) and

(b) “analysis/decision” part ( $\alpha_i$ ) (to analyze the result of the implementation above and selection of next way/path, based on logical rules) (Fig. 14d).

This case can be used in combinatorial planning of medical treatment (i.e., design/implementation and analysis) (e.g., [74,76]).

**Example 1.** An illustrative example for routing based on design alternatives in each graph/network vertex is the following. For each vertex, the resultant design alternative can be selected in online mode or on the basis of off-line solving process (e.g., [74,76]). Here, each vertex of “design space” corresponds to Fig. 14b. The example involves the following (Fig. 15):

(i)  $G = (H, E)$  is a digraph, vertex set  $H = \{\mu_1, \mu_2, \mu_3, \mu_4, \mu_5, \mu_6, \mu_7, \mu_8\}$ , arc set  $E = \{(\mu_1, \mu_2), (\mu_1, \mu_3), (\mu_2, \mu_3), (\mu_2, \mu_4), (\mu_2, \mu_5), (\mu_3, \mu_5), (\mu_3, \mu_6), (\mu_4, \mu_6), (\mu_3, \mu_7), (\mu_5, \mu_6), (\mu_5, \mu_7), (\mu_6, \mu_7), (\mu_6, \mu_8), (\mu_7, \mu_8)\}$ ;

(ii)  $\mu_1$  is an initial point,  $\mu_8$  is a goal point;

(iii) there exist three design alternatives for each vertex  $\mu_i$  ( $i = \overline{1,8}$ ):  $A_1^{\mu_i}, A_2^{\mu_i}, A_3^{\mu_i}$ ;

(iv) selected alternatives (for each vertex) are:  $A_3^{\mu_1}, A_3^{\mu_2}, A_1^{\mu_3}, A_2^{\mu_4}, A_2^{\mu_5}, A_1^{\mu_6}, A_1^{\mu_7}, A_2^{\mu_8}$  (In Fig. 14, the alternatives are pointed out by “oval”);

(v) the designed global route (by vertices) is:  $L = \langle \mu_1, \mu_2, \mu_5, \mu_6, \mu_8 \rangle$ ;

(vi) the resultant route consisting of design alternatives is:  $\hat{L} = \langle A_3^{\mu_1}, A_3^{\mu_2}, A_2^{\mu_5}, A_1^{\mu_6}, A_2^{\mu_8} \rangle$ .

Evidently, in the problem the selected design alternatives in neighbor path vertices have to be “good” compatible as in combinatorial synthesis approach (morphological clique problem) (e.g., [69,70,71,76]).

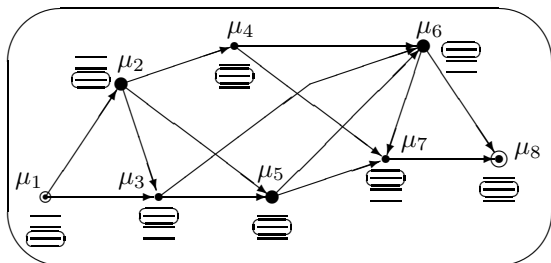

Fig. 15. Design alternatives for vertices

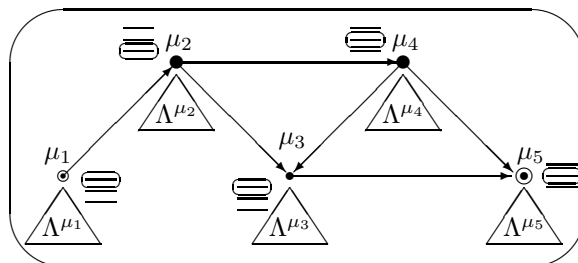

Fig. 16. Hierarchies of alternatives for vertices



**Example 2.** An illustrative example for routing based hierarchy of design alternatives in each graph/network vertex is the following. In each vertex, the resultant set of design alternative can be design in online mode or on the basis of offline solving process. Here, each vertex of “design space” corresponds to Fig. 14d. In [74,76], this problem is examined as multi-stage design of modular systems. The example involves the following (Fig. 16):

- (i)  $G = (H, E)$  is a digraph, vertex set  $H = \{\mu_1, \mu_2, \mu_3, \mu_4, \mu_5\}$ , arc set  $E = \{(\mu_1, \mu_2), (\mu_2, \mu_3), (\mu_2, \mu_4), (\mu_3, \mu_5), (\mu_4, \mu_3), (\mu_4, \mu_5)\}$ ;
- (ii)  $\mu_1$  is an initial point,  $\mu_5$  is a goal point;
- (iii) there exists a hierarchy of design alternatives for each vertex  $\mu_i$  ( $i = \overline{1, 5}$ ):  $\Lambda^{\mu_i}$ ;
- (iv) three design alternatives are composed for each vertex  $\mu_i$  ( $i = \overline{1, 5}$ ):  $A_1^{\mu_i}, A_2^{\mu_i}, A_3^{\mu_i}$ ;
- (v) selected alternatives (for each vertex) are:  $A_1^{\mu_1}, A_3^{\mu_2}, A_1^{\mu_3}, A_2^{\mu_4}, A_2^{\mu_5}$  (in Fig. 15, the alternatives are pointed out by “oval”);
- (vi) the designed global route (by vertices) is:  $L = \langle \mu_1, \mu_2, \mu_4, \mu_5 \rangle$ ;
- (vii) the resultant route consisting of design alternatives is:  $\hat{L} = \langle A_1^{\mu_1}, A_3^{\mu_2}, A_2^{\mu_4}, A_2^{\mu_5} \rangle$ .

Evidently, in the problem the selected design alternatives in neighbor path vertices have to be “good” compatible as in combinatorial synthesis approach (morphological clique problem) (e.g., [69,70,71,76]).

#### 2.4. Basic solving strategies

Let us consider one-layer route DM problem with nodes as “vertex& alternatives” and “vertex& hierarchy alternatives” (Fig. 14c and Fig. 15, Fig. 14d and Fig. 16). In general, the following two basic solving strategies can be pointed out for these problem types:

*Strategy 1.* “Global” route strategy:

- (1.1) designing a “global” route over graph vertices,
- (1.2) selection/design of the best design alternative for each graph vertex,
- (1.3) designing a resultant route from the best alternatives.

This strategy 1 is illustrated in Example 1 and in Example 2 (Fig. 15, Fig. 16). The strategy was used in [74,76].

*Strategy 2.* Extended digraph strategy:

- (2.1) transformation/extension of the initial graph/network model as examination of design alternatives for each model node instead of the node (e.g., Fig. 17 instead of Fig. 16),
- (2.2) designing the best route over the obtained extended graph/network.

Evidently, this strategy increases the problem dimension.

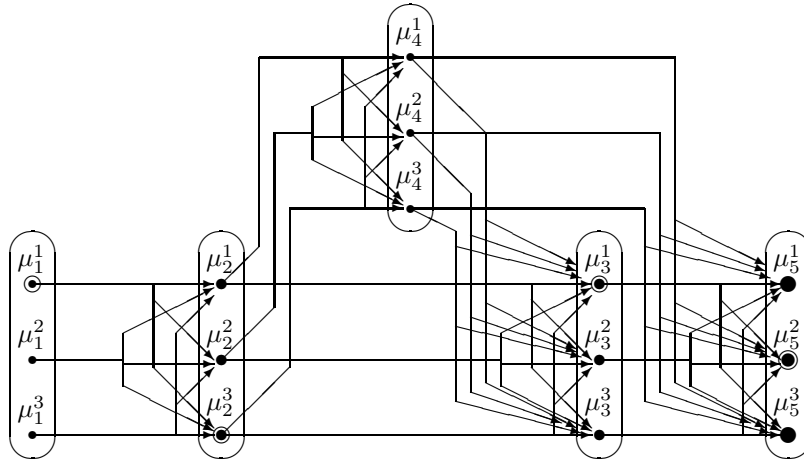

Fig. 17. Illustration for extended digraph strategy

**Example 3.** Here, digraph  $G = (H, E)$  from example 2 above (Fig. 16) is considered as an initial one. For each vertex, three alternatives are examined (Fig. 16), and resultant digraph  $\hat{G} = (\hat{H}, \hat{E})$  (where  $\hat{H} = \{\mu_1^1, \mu_1^2, \mu_1^3, \mu_2^1, \mu_2^2, \mu_2^3, \mu_3^1, \mu_3^2, \mu_3^3, \mu_4^1, \mu_4^2, \mu_4^3, \mu_5^1, \mu_5^2, \mu_5^3\}$ ) is shown in Fig. 17. (Here, “superscript”

index corresponds to the number of alternative, i.e.,  $\mu_i^j$  corresponds to design alternative  $A_j^{\mu_i}$ . In this problem, it is necessary to select the initial point from the set  $\{\mu_1^1, \mu_1^2, \mu_1^3\}$  and the goal point from the set  $\{\mu_5^1, \mu_5^2, \mu_5^3\}$ . Further, the route has to be build.

For example,  $\mu_1^1$  is the initial point (as in Fig. 16),  $\mu_5^2$  is the goal point (as in Fig. 16). The global route is:  $L = \langle \mu_1, \mu_2, \mu_3, \mu_5 \rangle$ . The resultant route (by design alternatives) is:  $\hat{L} = \langle \mu_1^1, \mu_2^3, \mu_3^1, \mu_5^2 \rangle$ .

### 3. Some applied route decision making problems

#### 3.1. Student orienteering problem (educational trajectory)

In educational domain, the following route decision making problem has been examined: design of educational route (e.g., for student/teenager) (e.g., [69]). Here, support problems are the following: (i) analysis/diagnosis of initial situation (i.e., point), (ii) definition/specification/design of goal point(s), (iii) design of route “space” (i.e., a set of education/life operations), (iv) design of educational route, (v) online analysis of the route implementation and online modification (correction) of the route.

Further, a simplified plan (educational trajectory) for a BS student of Moscow Inst. of Physics and Technology (State Univ.) (Faculty of Radio Engineering and Cybernetics) is examined. A BS degree in Communication Engineering from Moscow Inst. of Physics and Technology (Communication Engineering) is considered as an initial point  $a_1$ . Other educational points/nodes are presented in Table 2 including their characteristics and estimates upon criteria (ordinal scale [1, 5], 5 corresponds to the best level): (i) quality of education (i.e., a set of disciplines, basic lectures, seminars)  $C_1$ , (ii) possible research results (including publication activity)  $C_2$ , (iii) integrated index of professional degree prestige (World University Rating, quality of professional education/research, scientific school(s), etc.)  $C_3$ .

**Table 2.** Digraph model nodes/vertices for student planning (characteristics, estimates)

No.	Notation (node/vertex)	Degree level	University	Profession	Time (years) $\tau$	$\theta^1$	$\theta^2$	$\theta^3$
1.	$a_1$ (initial, origin)	BS	MIPT, Russia	Commun. Eng.	4			
2.	$b_1$	MS	MIPT, Russia	Commun. Eng.	2	5	2	4
3.	$b_2$	MS	MIPT, Russia	Appl. Math.	2	5	4	4
4.	$b_3$	MS	USA univ.	Commun. Eng.	2	3	5	5
5.	$b_4$	MS	USA univ.	Inform. Syst.	2	3	5	5
6.	$b_5$	MS	Canadian univ.	Commun. Eng.	2	3	4	4
7.	$b_6$	MS	UK univ.	OR/Algorithms	2	4	5	4
8.	$b_7$	MS	German univ.	Inform. Syst.	2	3	2	4
9.	$g_1$	MS (2nd)	USA univ.	Commun. Eng.	1	3	5	5
10.	$g_2$	MS (2nd)	USA univ.	Inform. Syst.	1	3	5	5
11.	$g_3$	MS (2nd)	Canadian univ.	Commun. Eng.	1	3	4	4
12.	$g_4$	MS (2nd)	UK univ.	OR/Algorithms	1	4	5	4
13.	$g_5$	MS (2nd)	German univ.	Inform. Syst.	1	3	4	4
14.	$h_1$	PhD	MIPT, Russia	Commun. Eng.	3	5	3	4
15.	$h_2$	PhD	MIPT, Russia	Appl. Math.	3	5	4	5
16.	$h_3$	PhD	USA univ.	Commun. Eng.	3	4	5	5
17.	$h_4$	PhD	USA univ.	Inform. Syst.	3	4	5	5
18.	$h_5$	PhD	Canadian univ.	Commun. Eng.	3	4	4	5
19.	$h_6$	PhD	UK univ.	OR/Algorithms	3	5	5	5
20.	$h_7$	PhD	German univ.	Inform. Syst.	3	4	4	4
21.	$f_1$	PhD (2nd)	USA univ.	Commun. Eng.	2	4	5	5
22.	$f_2$	PhD (2nd)	USA univ.	Inform. Syst.	2	4	5	5
23.	$f_3$	PhD (2nd)	Canadian univ.	Commun. Eng.	2	4	5	5
24.	$p_1$ (goal, destination)	PostDoc	USA univ.	Commun. Eng.	3	3	5	5

Here, four basic “generalized” educational routes/trajectories can be examined ( $\iota = \overline{1, 7}$ ,  $\kappa = \overline{1, 5}$ ,  $v = \overline{1, 7}$ ,  $\xi = \overline{1, 3}$ ):  $L^1 = \langle a_1, b_\iota, h_v, p_1 \rangle$  (Fig. 18a);  $L^2 = \langle a_1, b_\iota, g_\kappa, h_v, p_1 \rangle$  (Fig. 18b);  $L^3 = \langle$

$a_1, b_l, h_v, f_\xi, p_1 >$  (Fig. 18c);  $L^4 = \langle a_1, b_l, g_\kappa, h_v, f_\xi, p_1 \rangle$  (Fig. 18d). Table 3, Table 4, Table 5 contain ordinal complexity estimates of movement between model nodes (scale [1, 5], 5 corresponds to the most complex movement; absence of estimate corresponds to impossible movement: the digraph arc is absent).

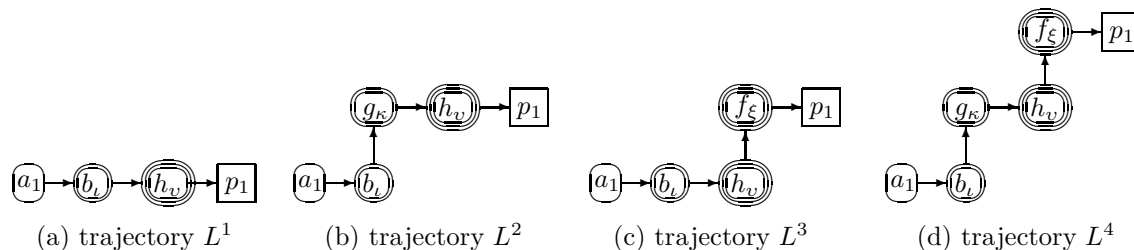

Fig. 18. Four basic generalized educational trajectories

**Table 3.** Ordinal estimates of movement complexity  $\lambda(a_1 \rightarrow b_i)$

$a_1 \setminus b_i$	$b_1$	$b_2$	$b_3$	$b_4$	$b_5$	$b_6$	$b_7$
$a_1$	1	2	4	5	4	5	3

**Table 4.** Ordinal estimates of movement complexity:  $\lambda(b_i \rightarrow g_\kappa)$ ,  $\lambda(b_i \rightarrow h_v)$

$b_i \setminus g_\kappa/h_v$	$g_1$	$g_2$	$g_3$	$g_4$	$g_5$	$h_1$	$h_2$	$h_3$	$h_4$	$h_5$	$h_6$	$h_7$
$b_1$	1	2	1	3	2	1	3	3	4	3	5	4
$b_2$	1	1	1	1	1	2	1	4	4	4	4	3
$b_3$		1		1				1	2	1	3	1
$b_4$	1		1					2	1	1	3	1
$b_5$	1	1		1				2	2	1	3	1
$b_6$	1	1	1					1	1	1	1	1
$b_7$	1	1	1	1				2	2	2	3	1

**Table 5.** Ordinal estimates of movement:  $\lambda(g_\kappa \rightarrow h_v)$ ,  $\lambda(h_v \rightarrow f_\xi)$ ,  $\lambda(h_v \rightarrow p_1)$ ,  $\lambda(f_\xi \rightarrow p_1)$

$g_\kappa/h_v \setminus h_v/f_\xi, p_1$ $\setminus f_\xi/p_1$	$h_1$	$h_2$	$h_3$	$h_4$	$h_5$	$h_6$	$h_7$	$f_1$	$f_2$	$f_3$	$p_1$
$g_1$			1	2	1	3	1				
$g_2$			2	1	1	3	1				
$g_3$			3	3	1	3	1				
$g_4$			1	1	1	1	1				
$g_5$			2	2	2	3	1				
$h_1$								2	3	2	5
$h_2$								1	1	1	5
$h_3$									1		2
$h_4$								1		1	3
$h_5$									1		3
$h_6$								1	1	1	3
$h_7$								3	0	2	4
$f_1$											1
$f_2$											2
$f_3$											2

First, a modification of orienteering problem (three objective functions, constraint for maximum arc length, constraint for aggregated (summarized) time of visited vertices) is considered as follows:  $H = \{1, \dots, i, \dots, n\}$  is the set of vertex/nodes, vertex 1 is the start point of the route (origin), vertex  $n$  is the end (goal) point of the route (destination), binary variable  $x_{ij} = 1$  if the built route (path) contains arc  $(i, j)$  and  $x_{ij} = 0$  otherwise (vertex  $i$  precedes  $j$ ),  $\theta_i$  is the vertex profit,  $\lambda_{ij}$  is the arc cost (if arc  $(i, j) \in E$ ),  $d^{max}$  is a distance constraint for movement between neighbor vertices in the built route/path,  $T$  is a time constraint for the built route as summarization of times of path vertices.

The basic model is:

$$\begin{aligned} & \max \sum_{i=1}^n \sum_{j=1}^n \theta_i^1 x_{ij}, \quad \max \sum_{i=1}^n \sum_{j=1}^n \theta_i^2 x_{ij}, \quad \max \sum_{i=1}^n \sum_{j=1}^n \theta_i^3 x_{ij}, \\ \text{s.t. } & \sum_{j=2}^n x_{1j} = \sum_{i=1}^{n-1} x_{in} = 1; \quad \sum_{i=2}^{n-1} x_{ik} = \sum_{j=2}^{n-1} x_{kj} \leq 1, \quad k = \overline{2, n-1}; \\ & \lambda_{ij} x_{ij} \leq d^{max} \quad \forall i, j; \quad \sum_{i=1}^n \sum_{j=1}^n \tau_i x_{ij} \leq T; \\ & x_{ij} \in \{0, 1\}, \quad i = \overline{1, n}, \quad j = \overline{1, n}. \end{aligned}$$

Here, the Pareto-efficient solutions have to be searched for. Clearly, the problem is NP-hard. In our case,  $a_1$  is the start point (i.e., graph vertex),  $p_1$  is the end (goal) point (i.e., graph vertex). The optimization model has to be solved for each generalized trajectory above (i.e.,  $L^1, L^2, L^3, L^4$ ).

Let  $L = \langle l_1, \dots, l_i, \dots, l_q \rangle$  be an admissible route solution (i.e., educational trajectory). The characteristics of the solution are as follows: (a)  $\theta^1(L) = \sum_{i=2}^q \theta_i^1$  is integrated quality of education; (b)  $\theta^2(L) = \sum_{i=2}^q \theta_i^2$  is integrated quality of research results (including publication results); (c)  $\theta^3(L) = \sum_{i=2}^q \theta_i^3$  is integrated parameter of resultant prestige of the obtained academic degrees; (d)  $\tau(L) = \sum_{i=2}^q \tau_i$  is integrated required time (years) of the educational trajectory; (e)  $d(L) = \sum_{i=1}^{q-1} \lambda(l_i \rightarrow l_{i+1})$  is integrated estimate of movement complexity (between neighbor educational institutions). As a result, the problem can be formulated as the following:

Find the route  $L$  (solution) such that

- (1) it fulfils two constraints:  $\tau(L) \leq T$  and  $d(L) \leq d^{max}$ ;
- (2) it is a Pareto-efficient one by four criteria (objective functions):  $\max \theta^1(L), \max \theta^2(L), \max \theta^3(L), \min d(L)$ .

Note, the usage of educational generalized trajectories ( $L^1, L^2, L^3, L^4$ ) leads to simplified/partitioned “solving space(s)”. As a result, the optimization problem can be transformed into a version of the multicriteria shortest path problem or multicriteria multiple choice problem). Thus, a concurrent” general solving framework is used (Fig. 19).

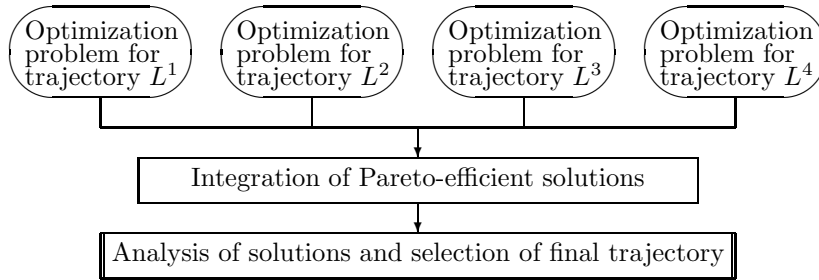

Fig. 19. General solving framework for educational trajectory

In the numerical example, the following simplified heuristic solving scheme is considered:

*Stage 1.* Searching for a solution with minimum  $d(L)$  for each generalized trajectory ( $L^1, L^2, L^3, L^4$ ). The resultant solutions and their estimates are presented in Table 6.

*Stage 2.* Selection of Pareto-efficient solutions:  $L_1^1 = \langle a_1, b_3, h_3, p_1 \rangle$ ,  $L_1^2 = \langle a_1, b_1, g_1, h_3, p_1 \rangle$ ,  $L_1^3 = \langle a_1, b_2, h_2, f_1, p_1 \rangle$ , and  $L_1^4 = \langle a_1, b_2, g_2, h_4, f_1, p_1 \rangle$ .

*Stage 3.* Selection of the best solution (i.e., expert judgment).

For example, solution  $L_1^3 = \langle a_1, b_2, h_2, f_1, p_1 \rangle$  can be selected while taking into account obtained additional skills in applied mathematics (it may be crucial for the future).

**Table 6.** Pareto-efficient solutions and their parameters (vector estimate)

No.	Route $L$	$\theta^1(L)$	$\theta^2(L)$	$\theta^3(L)$	$\tau(L)$	$d(L)$
1.	$L_1^1 = \langle a_1, b_3, h_3, p_1 \rangle$	10	15	15	8	7
2.	$L_1^2 = \langle a_1, b_1, g_1, h_3, p_1 \rangle$	15	17	19	9	5
3.	$L_1^3 = \langle a_1, b_2, h_2, f_1, p_1 \rangle$	15	18	19	10	5
4.	$L_1^4 = \langle a_1, b_1, g_1, h_7, f_1, p_1 \rangle$	19	21	23	11	6
5.	$L_2^2 = \langle a_1, b_1, g_3, h_3, f_2, p_1 \rangle$	19	21	23	11	6
6.	$L_3^4 = \langle a_1, b_2, g_2, h_4, f_1, p_1 \rangle$	19	22	24	11	6

### 3.2. Scenario planning for start-up company

Here, three-stage planning process for a start-up company is considered. Hierarchical Morphological Multicriteria Design (HMMD) based on morphological clique problem is used (combinatorial synthesis) (e.g., [69,70,76]). A brief description of HMMD (basic version) is the following. An examined composite (modular) system consists of components and their interconnection or compatibility (IC). Basic assumptions of HMMD are the following: (a) a tree-like structure of the system; (b) a composite estimate for system quality that integrates components (subsystems, parts) qualities and qualities of IC (compatibility) across subsystems; (c) monotonic criteria for the system and its components; (d) quality estimates of system components and IC are evaluated by coordinated ordinal scales. The designations are: (1) design alternatives (DAs) for nodes of the model; (2) priorities of DAs ( $r = \overline{1, k}$ ; 1 corresponds to the best level of quality); (3) an ordinal compatibility estimate for each pair of DAs ( $w = \overline{0, l}$ ;  $l$  corresponds to the best level of quality). The basic phases of HMMD are: 1. design of the tree-like system model; 2. generation of DAs for leaf nodes of the model; 3. hierarchical selection and composing of DAs into composite DAs for the corresponding higher level of the system hierarchy.

Let  $S$  be a system consisting of  $m$  parts (components):  $P(1), \dots, P(i), \dots, P(m)$ . A set of design alternatives (DAs) is generated for each system part above. The problem is:

*Find composite design alternative  $S = S(1) \star \dots \star S(i) \star \dots \star S(m)$  (one representative design alternative  $S(i)$  for each system component/part  $P(i)$ ,  $i = \overline{1, m}$ ) with non-zero IC estimates between the representative design alternatives.*

A discrete “space” of the integrated system excellence is based on the following vector:  $N(S) = (w(S); n(S))$ , where  $w(S)$  is the minimum of pairwise compatibility between DAs which correspond to different system components (i.e.,  $\forall P_{j_1}$  and  $P_{j_2}$ ,  $1 \leq j_1 \neq j_2 \leq m$ ) in  $S$ ,  $n(S) = (n_1, \dots, n_r, \dots, n_k)$ , where  $n_r$  is the number of DAs of the  $r$ th quality in  $S$  ( $\sum_{r=1}^k n_r = m$ ). As a result, composite decisions which are nondominated by  $N(S)$  (i.e., Pareto-efficient solutions) are searched for. In the numerical example, ordinal scale [1, 2, 3] is used for quality of DAs and ordinal scale [0, 1, 2, 3] is used for compatibility.

The basic simplified hierarchical structure of the considered start-up company is (including used DAs):

**0.** Hierarchical model  $S = P \star T \star M$ .

**1.** Product  $P = A \star B \star E \star W$ :

1.1. Models and algorithms  $A$ : prototype(s)  $A_1$ , basic model(s)  $A_2$ , advanced models  $A_3$ ;

1.2. Algorithms  $B$ : prototype(s) (e.g., simple heuristics)  $B_1$ , library of well-known algorithms  $B_2$ , extended library of algorithms (including advanced algorithms/heuristics)  $B_3$ ;

1.3. Information base of applications  $E$ : none  $E_1$ , simple library of applied examples  $E_2$ , extended library of applied examples with educational modes  $E_3$ ;

1.4. Web-site  $W$ : None  $W_1$ , simplified site-prototype  $W_2$ , site with an interactive mode(s) for a base of users  $W_3$ ;

**2.** Team  $T = L \star R \star I \star K$ :

2.1. Project leader  $L$ : basic leader  $L_1$ , extended group of leaders  $L_2$ ;

2.2. Researcher  $R$ : basic researcher (models, algorithms)  $R_1$ , extended group of researchers (including applications in R&D and engineering, educational technology)  $R_2$ ;

2.3. Engineer-programmer  $I$ : none  $I_1$  engineer  $I_2$ , group of engineers  $I_3$ , extended group of engineers (including specialist in Web-design)  $I_4$ ;

2.4. Specialist in marketing  $K$ : none  $K_1$ , basic specialist  $K_2$ .

**3.** Marketing part  $M = U \star V$ :

3.1. Marketing strategy  $U$ : none  $U_1$ , “go-to-market”  $U_2$ , expanding market (e.g., additional market segment(s))  $U_3$ .

3.2. Market segment  $V$ : none  $V_1$ , education  $V_2$ , R&D  $V_3$ . engineering  $V_4$ . education and R&D  $V_5 = V_2 \& V_3$ .

Three time stages are examined:  $\tau_1, \tau_2, \tau_3$ . The examined trajectory  $S^1 \implies S^2 \implies S^3$  is illustrated in Fig. 20. The hierarchical structures above for the time stages (including DAs and their ordinal priorities in parentheses for each time stage, expert judgment) are presented in Fig. 21, Fig. 22, and Fig. 23 (accordantly). For stage 1, the initial situation (origin) is considered as the following:

$$S_1^1 = P_1 \star T_1 \star M_1 = (A_1 \star B_1 \star E_1 \star W_1) \star (L_1 \star R_1 \star I_1 \star K_1) \star (U_1 \star V_1).$$

Table 7, Table 8, Table 9 contain ordinal estimates of compatibility (expert judgment) between DAs.

The resultant Pareto-efficient composite DAs for system at each time stage (on the basis on hierarchical combinatorial synthesis) are presented in Fig. 21, Fig. 22, Fig. 23:

$$(1) \text{ for stage 1 } (\tau_1): S_1^1 = P_1^1 \star T_1^1 \star M_1^1 = (A_1 \star B_1 \star E_1 \star W_1) \star (L_1 \star R_1 \star I_1 \star K_1) \star (U_1 \star V_1);$$

$$(2) \text{ for stage 2 } (\tau_2): S_1^2 = P_1^2 \star T_1^2 \star M_1^2 = (A_2 \star B_2 \star E_2 \star W_2) \star (L_1 \star R_2 \star I_3 \star K_2) \star (U_2 \star V_2),$$

$$S_2^2 = P_1^2 \star T_1^2 \star M_1^2 = (A_2 \star B_2 \star E_2 \star W_2) \star (L_1 \star R_2 \star I_3 \star K_2) \star (U_2 \star V_3);$$

$$(3) \text{ for stage 3 } (\tau_3): S_1^3 = P_1^3 \star T_1^3 \star M_1^3 = (A_3 \star B_3 \star E_3 \star W_3) \star (L_2 \star R_2 \star I_3 \star K_2) \star (U_2 \star V_2),$$

$$S_2^3 = P_1^3 \star T_1^3 \star M_1^3 = (A_3 \star B_3 \star E_3 \star W_3) \star (L_2 \star R_2 \star I_3 \star K_2) \star (U_3 \star V_3).$$

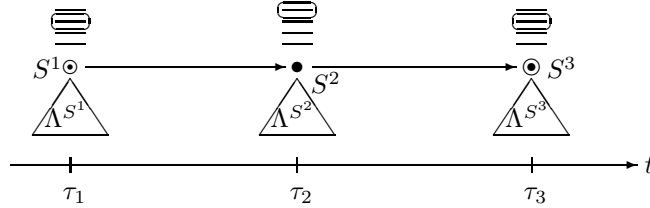

Fig. 20. Three-stage scheme for company development

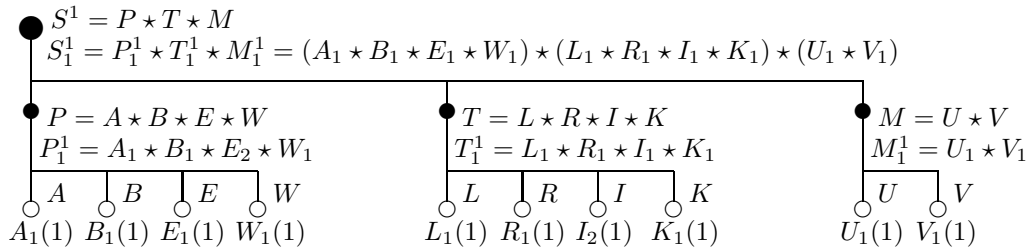

Fig. 21. Hierarchical structure of start-up company  $S^1$  (stage 1)

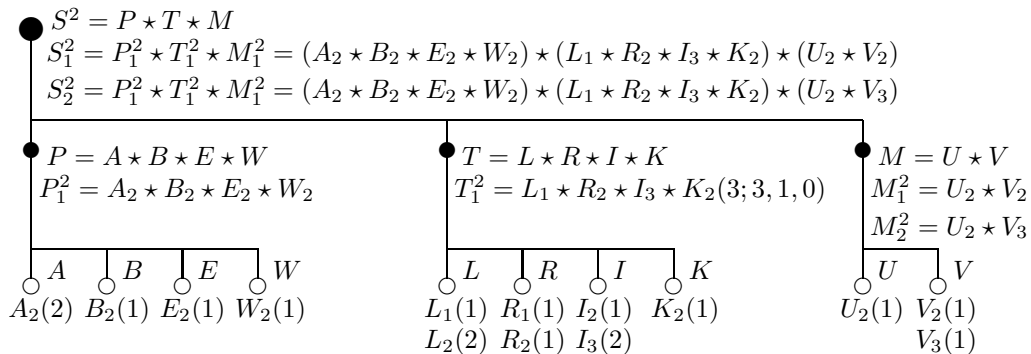
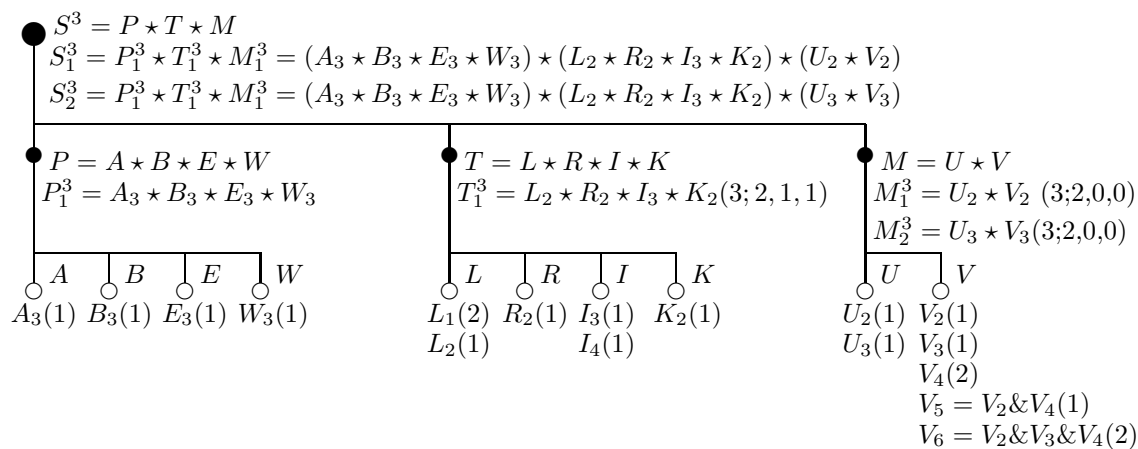

Fig. 22. Hierarchical structure of start-up company  $S^2$  (stage 2)

Fig. 23. Hierarchical structure of start-up company  $S^3$  (stage 3)**Table 7.** Compatibility

	$B_1$	$B_2$	$B_3$	$E_1$	$E_2$	$E_3$	$W_1$	$W_2$	$W_3$
$A_1$	3	0	0	3	3	1	3	2	0
$A_2$	0	3	0	0	3	3	0	3	2
$A_3$	0	0	3	0	2	3	0	3	1
$B_1$				3	0	0	3	3	2
$B_2$				0	3	3	3	3	3
$B_3$				0	3	3	3	0	3
$E_1$							3	0	0
$E_2$							3	3	0
$E_3$							0	0	3

**Table 8.** Compatibility

	$V_1$	$V_2$	$V_3$	$V_4$	$V_5$	$V_6$
$U_1$	3	0	0	0	0	0
$U_2$	0	3	2	2	1	1
$U_3$	0	2	3	2	1	1

**Table 9.** Compatibility

	$R_1$	$R_2$	$I_1$	$I_2$	$I_3$	$I_4$	$K_1$	$K_2$
$L_1$	3	3	2	3	3	2	3	3
$L_2$	2	3	0	0	3	3	0	3
$R_1$			2	3	2	1	3	3
$R_2$			0	2	3	3	0	3
$I_1$							3	0
$I_2$							0	3
$I_3$							0	3
$I_4$							0	3

Table 10 contains ordinal estimates of compatibility (expert judgment) between DAs for the composite system at time stages. The final Pareto-efficient system trajectory is (hierarchical combinatorial synthesis) (Fig. 24):  $\alpha = \langle S_1^1, S_1^2, S_1^3 \rangle$ .

**Table 10.** Compatibility

	$S_1^2$	$S_2^2$	$S_1^3$	$S_2^3$
$S_1^1$	3	0	3	0
$S_1^2$			3	2
$S_2^2$			3	3

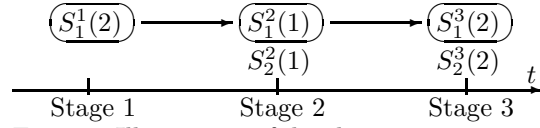

Fig. 24. Illustration of development trajectory

**3.3. Simplified example for planning of medical treatment**

Generally, there exists a significant problem in medicine (Fig. 25): planning of medical treatment (as a treatment route) for a certain patient (e.g., [70,77]) or joint planning/designing a route of diagnosis/treatment operations (e.g., [73,76]).

A two-phase scheme of medical treatment planning and implementation is depicted in Fig. 26 (basic flow-chart that can involve online modes, support layer).

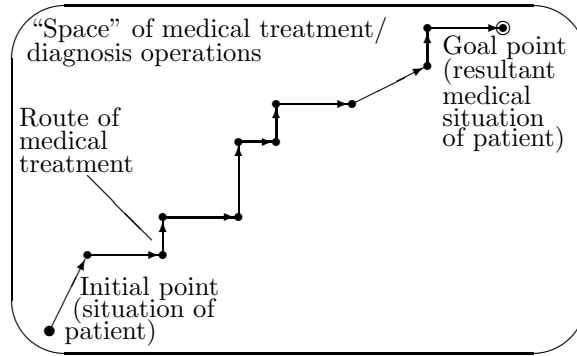

Fig. 25. Routing as medical treatment planning

In Fig. 26, a general networked framework of medical treatment (diagnosis, desing/planning, implementation) is presented.

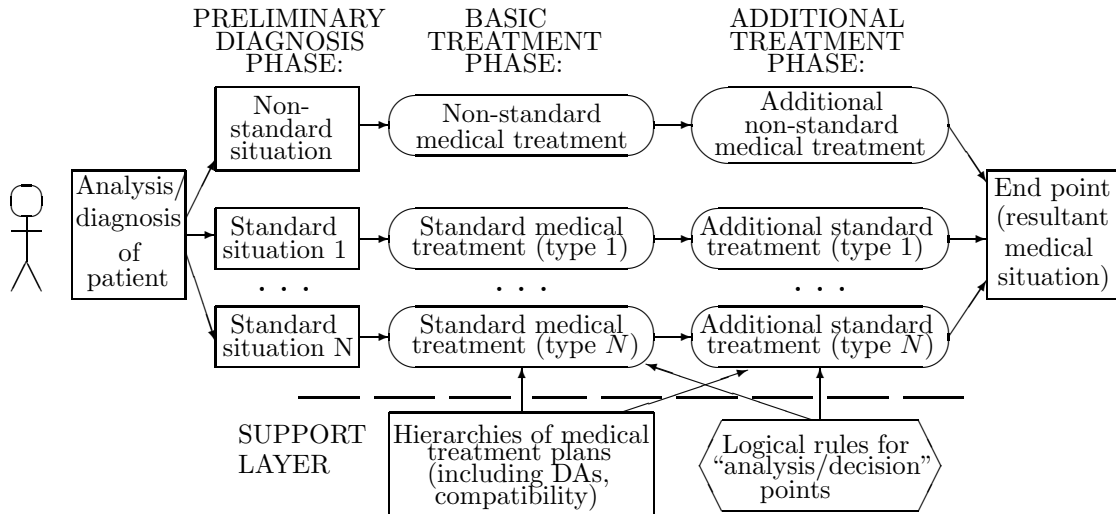

Fig. 26. General networked framework of medical treatment

Here, a simplified illustrative example for designing a two-phase trajectory for medical treatment of children asthma is briefly described (for standard medical treatment, for non-standard medical treatment). The scheme is based on materials from [73,76,77]. A two-phase scheme of medical treatment planning and implementation is depicted in Fig. 27 (basic flow-chart that can involve online modes, support layer).



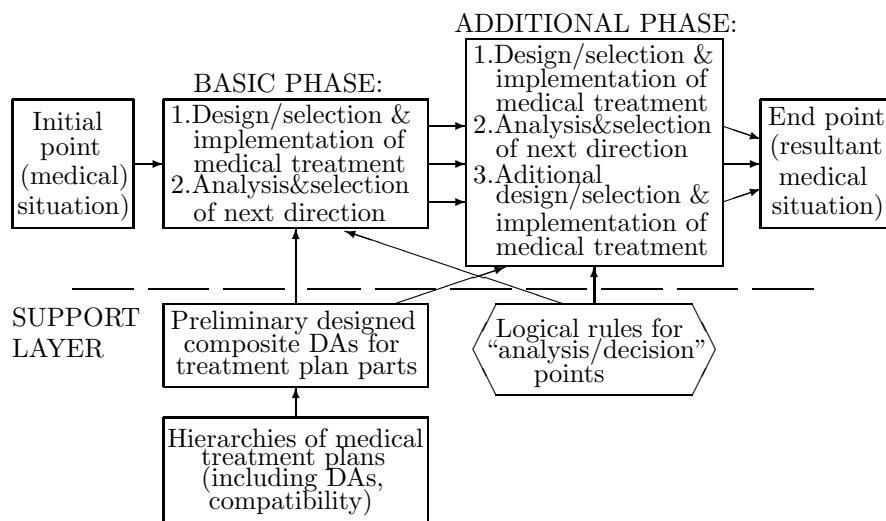

Fig. 27. Two-phase scheme of medical treatment

The considered general trajectory scheme for medical treatment is depicted in Fig. 28 with two kinds of node elements (points): (i) “design/implementation” elements (based on hierarchies of design alternatives and their estimates), (ii) “analysis/decision” elements (based on logical rules).

Table 11 contains descriptions of design/implementation points. Table 12 contains descriptions (logical rules) of “analysis/decision” points.

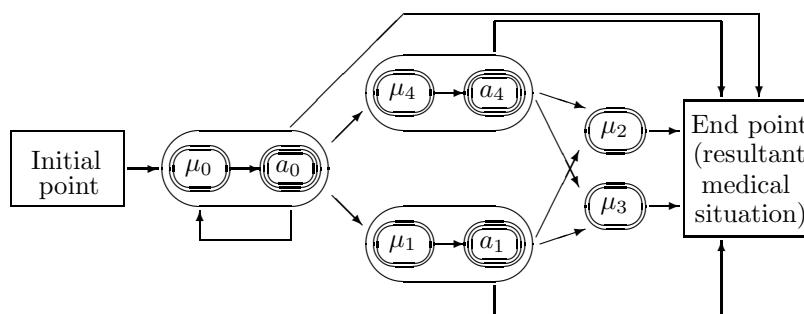

Fig. 28. Medical treatment scheme (basis of medical trajectories)

**Table 11.** Design/implementation points (design/selection & implementation of plan parts)

No.	Design/implementation point	Description
1.	$\mu_0$	Design&implementation of initial (basic) treatment plan
2.	$\mu_1$	Design&implementation of additional environmental treatment
3.	$\mu_2$	Design&implementation of additional treatment by relaxation
4.	$\mu_3$	Design&implementation of additional physical therapy
5.	$\mu_4$	Design&implementation of additional joint physical therapy and drug based treatment

**Table 12.** “Analysis/decision” points

No.	“Analysis/” “decision” point	Description (logical rules)
1.	$a_0$	(i) repetition of basic treatment is required, “Go To” $\mu_0$ (ii) excellent medical results, “Go To” “End point” (iii) good medical results, “Go To” $\mu_1$ (additional environmental treatment) (iv) about sufficient medical results, “Go To” $\mu_4$
2.	$a_1$	(i) good medical results, “Go To” $\mu_2$ (relaxation) (ii) excellent medical results, “Go To” “End point” (iii) about sufficient medical results, “Go To” $\mu_3$ (additional physical therapy)
3.	$a_4$	(i) good medical results, “Go To” $\mu_2$ (additional environmental treatment) (ii) excellent medical results, “Go To” “End point” (iii) about sufficient medical results, “Go To” $\mu_3$

Each “design/implementation” node element (point) of the treatment trajectory (i.e., node  $\mu_i, i = \overline{0,4}$ ) is based on a simplified hierarchical structure of medical treatment that has been suggested in [77]. Combinatorial synthesis (HMMD) is used for composition of composite DAs (brief description is presented in previous section). The basic hierarchical structure of medical treatment is presented in Fig. 29 (priorities of DAs are shown in parentheses, expert judgment):

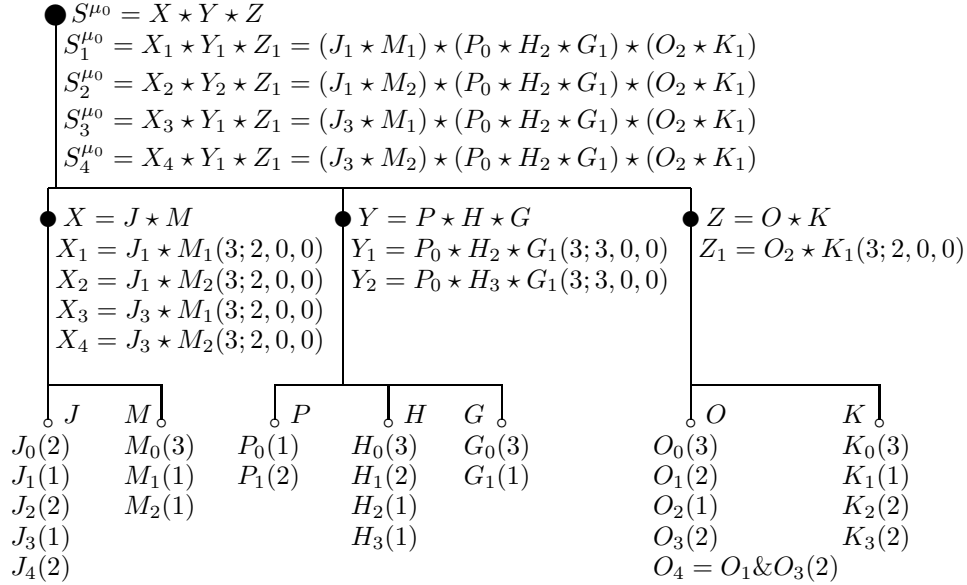

Fig. 29. Hierarchical model of medical treatment plan

**0.** Plan of medical treatment  $S = X \star Y \star Z$ .

**1.** Basic treatment  $X = J \star M$ :

**1.1.** Physical therapy  $J$ : none  $J_0(2)$ , massage  $J_1(1)$ , laser-therapy  $J_2(2)$ , massage for special centers/points  $J_3(1)$ , halo-cameras or salt mines  $J_4(2)$ .

**1.2.** Drug based treatment  $M$ : none  $M_0(3)$ , vitamins  $M_1(1)$ , sodium chromoglycate  $M_2(1)$ .

**2.** Improvement of psychological and ecological environment  $Y = P \star H \star G$ :

**2.1.** Psychological climate  $P$ : none  $P_0(1)$ , consulting of a psychologist  $P_1(2)$ .

**2.2.** Home ecological environment  $H$ : none  $H_0(3)$ , to clean a book dust  $H_1(2)$ , to exclude contacts with home animals  $H_2(1)$ , to take away flowers  $H_3(1)$ .

**2.2.** General ecological environment  $G$ : none  $G_0(3)$ , improving the area of the residence  $G_1(1)$ .

**3.** Improvement of mode, rest and relaxation  $Z = O \star K$ :

**3.1.** Mode  $O$ : none  $O_0(3)$ , special physical actions (drainage, expectoration)  $O_1(2)$ , sport (running, skiing, swimming)  $O_2(1)$ , comfort shower-bath  $O_3(2)$ . aggregated alternative  $O_4 = O_1 \& O_3(2)$ .

3.2. Relaxation/rest  $K$ : none  $K_0(3)$ , rest at forest-like environment  $K_1(1)$ , rest near see  $K_2(2)$ , special treatment in salt mines  $K_3(2)$ .

In Fig. 29, the hierarchy (i.e., morphological structure) corresponds to design/implementaiton point  $\mu_0$  (Fig. 28). Estimates of compatibility for DAs are presented in Table 13, Table 14, and Table 15 [70,77] (as simplified version, the estimates are the same ones for all points  $\{\mu_0, \mu_1, \mu_2, \mu_3, \mu_4, \mu_5, \mu_6\}$ ). Estimates of compatibility for DAs at the higher hierarchical level are presented in Table 16 (for point  $\mu_0$ ).

**Table 13.** Compatibility

	$M_0$	$M_1$	$M_2$
$J_0$	0	3	3
$J_1$	2	3	3
$J_2$	2	3	3
$J_3$	2	3	3
$J_4$	1	3	2

**Table 14.** Compatibility

	$K_0$	$K_1$	$K_2$	$K_3$
$O_0$	0	3	3	3
$O_1$	0	3	3	2
$O_2$	0	3	3	2
$O_3$	0	3	3	1
$O_4$	0	3	3	3

**Table 15.** Compatibility

	$G_0$	$G_1$	$H_0$	$H_1$	$H_2$	$H_3$
$P_0$	1	3	0	3	3	3
$P_1$	3	2	2	3	3	3
$G_0$			0	0	0	0
$G_1$			0	3	3	3

**Table 16.** Compatibility

	$Y_1$	$Y_2$	$Z_1$
$X_1$	3	3	3
$X_2$	3	3	3
$X_3$	3	3	3
$X_4$	3	3	3
$Y_1$			3
$Y_2$			1

For basic (initial) point  $\mu_0$  (Fig. 29), the resultant composite Pareto-efficient DAs are:

(1) local Pareto-efficient solutions for subsystem  $X$ :  $X_1 = J_1 \star M_1$ ,  $N(X_1) = (3; 2, 0, 0)$ ;  $X_2 = J_1 \star M_2$ ,  $N(X_2) = (3; 2, 0, 0)$ ;  $X_3 = J_3 \star M_1$ ,  $N(X_3) = (3; 2, 0, 0)$ ;  $X_4 = J_3 \star M_2$ ,  $N(X_4) = (3; 2, 0, 0)$ ;

(2) local Pareto-efficient solutions for subsystem  $Y$ :  $Y_1 = P_0 \star H_2 \star G_1$ ,  $N(Y_1) = (3; 3, 0, 0)$ ;  $Y_2 = P_0 \star H_3 \star G_1$ ,  $N(Y_2) = (3; 3, 0, 0)$ ;

(3) local Pareto-efficient solutions for subsystem  $Z$ :  $Z_1 = O_2 \star K_1$ ,  $N(Z_1) = (3; 2, 0, 0)$ .

(4) final composite Pareto-efficient DAs for system  $S$  ( $N(S_l^{\mu_0}) = (3; 3, 0, 0)$ ,  $l = \overline{1, 4}$ ): (a)  $S_1^{\mu_0} = X_1 \star Y_1 \star Z_1$ , (b)  $S_2^{\mu_0} = X_2 \star Y_1 \star Z_2$ , (c)  $S_3^{\mu_0} = X_3 \star Y_1 \star Z_1$ , (d)  $S_4^{\mu_0} = X_4 \star Y_1 \star Z_1$ .

Further, composite DAs for points  $\mu_1, \mu_2, \mu_3, \mu_4$  are designed. Here, compatibility estimates correspond to Table 13, Table 14, Table 15; priorities of DAs are based on new expert judgment (Fig. 30, Fig. 31, Fig. 32, Fig. 33; in parentheses).

For point  $\mu_1$  (Fig. 30), the resultant composite Pareto-efficient DA are: (a)  $S_1^{\mu_1} = P_0 \star H_2 \star G_1$ ,  $N(S_1^{\mu_1}) = (3; 3, 0, 0)$ ; (b)  $S_2^{\mu_1} = P_0 \star H_3 \star G_1$ ,  $N(S_1^{\mu_1}) = (3; 3, 0, 0)$ .

For point  $\mu_2$  (Fig. 31, and for  $\mu_5$ ), the resultant composite Pareto-efficient DAs are: (a)  $S_1^{\mu_2} = O_4 \star K_1$ ,  $N(S_1^{\mu_2}) = (3; 2, 0, 0)$ ; (b)  $S_2^{\mu_2} = O_4 \star K_3$ ,  $N(S_2^{\mu_2}) = (3; 2, 0, 0)$ .

For point  $\mu_3$  (Fig. 32), the resultant composite Pareto-efficient DAs are: (a)  $S_1^{\mu_3} = J_3$ , (b)  $S_2^{\mu_3} = J_4$ .

For point  $\mu_4$  (Fig. 33, and for  $\mu_6$ ), the resultant composite Pareto-efficient DAs are: (a)  $S_1^{\mu_4} = J_3 \star M_1$ ,  $N(S_1^{\mu_2}) = (3; 2, 0)$ ; (b)  $S_2^{\mu_4} = J_4 \star M_1$ ,  $N(S_2^{\mu_2}) = (3; 2, 0)$ .

Fig. 30. Treatment for point  $\mu_1$ Fig. 31. Treatment for point  $\mu_2$ Fig. 32. Treatment for point  $\mu_3$ Fig. 33. Treatment for point  $\mu_4$ 

Fig. 34 depicts an individual version of medical treatment scheme with designed Pareto-efficient composite DAs. Evidently, the scheme version has to be designed for the certain patient at a preliminary phase (i.e., the individual scheme). An example of the final individual medical treatment trajectory is:

$$L^{ind} = \langle S_3^{\mu_0} \rightarrow S_1^{\mu_0} \rightarrow S_2^{\mu_4} \rightarrow S_1^{\mu_2} \rangle.$$

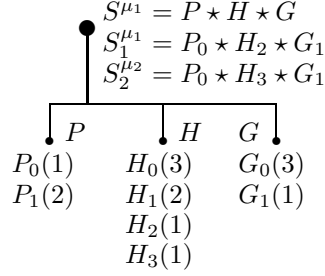
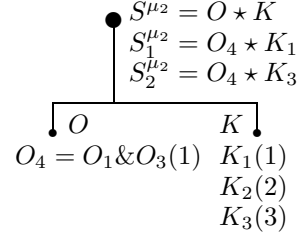
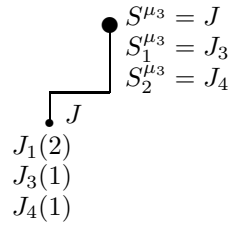
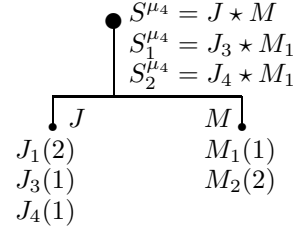
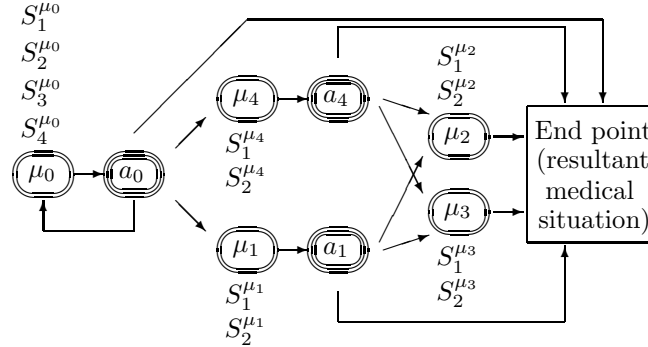

Fig. 34. Individual version of treatment scheme with DAs

#### 4. Conclusion

In the paper, a new class of composite multistage decision making problems has been suggested and described: route/trajectory DM problems. This problem class is an extension (by several ways) of the well-known routing problem as the shortest path problem. The suggested problems can be considered as “intelligent” routing at special “design/solving space(s)” based on a digraph over a set of connected composite objects/agents. The composite objects can contain the following: several alternatives, hierarchy of alternatives, subobject of implementation and subobject of analysis). In general, the “design/solving space(s)” can have multi-layer and/or multi-domain structure. The solving frameworks are two level ones: (i) bottom level as decision making operations/problems over the composite objects (e.g., selection/composition of alternatives) and (ii) top-level as routing problem(s) over the “design/solving space” (over the set of objects/agents). Mainly, problem descriptions are based on structural approach. New

problems, models, solving frameworks, and applications are discussed. In addition, restructuring approach for considered route decision making problems is described as well.

Some future research directions can include the following: 1. analysis, modeling and usage of various kinds of “design/solving spaces” including dynamical “design/solving spaces”; 2. study and usage of various basic combinatorial routing problems (e.g., spanning trees problems, versions of TSP) for construction of the corresponding route/trajectory DM problems; 3. study of multi-layer (hierarchical) “design/solving spaces” and route/trajectory DM problems over them; 4. special investigation of multiple vehicle routing problems (i.e., multi-domain problems) including coordination solving modes (e.g., as in multi-robot motion planning problems, in cooperative path planning for multiple UAVs [8,25,36,54,64,66,108]); 5. usage of route/trajectory DM problems for testing/inspection/maintenance of networked systems; 6. applications of the examined route/trajectory DM problems in economics/management (e.g., modeling of firm/project development, forecasting, scenario planning); 7. designing a special support computer-aided tools for the route/trajectory DM problems including the following stages: (i) problem analysis and descriptions, generation/formulation; (ii) building a “design/solving space”, (iii) planning the solving processes and problem solving; (iv) results analysis; and 8. usage of the considered route/trajectory DM problems in education (CS, applied mathematics, engineering, management).

## REFERENCES

1. G.M. Adelson-Velsky, E. Levner, Project scheduling in AND-OR graphs: A generalization of Dijkstra algorithm. *Math. Oper. Res.* 27(3), 504–517, 2002.
2. R.K. Ahuja, T.L. Magnanti, J.B. Orlin, *Network Flows: Theory, Algorithms, and Applications*. Prentice Hall, 1993.
3. R.M. Aiex, M.G.C. Resende, P.M. Pardalos, G. Toraldo, GRASP with path relinking for three-index assignment. *INFORMS J. on Computing* 17(2), 224–247, 2005.
4. N. Alon, F. Fomin, G. Gutin, M. Krivelevich, S. Saurabh, Spanning directed trees with many leaves. *SIAM J. on Discr. Math.* 23(1), 466–476, 2009.
5. C. Archetti, A. Hertz, M.G. Speranza, Metaheuristics for the team orienteering problem.. *J. of Heuristics* 13, 49–76, 2007.
6. C. Archetti, M.G. Speranza. The split delivery vehicle routing problem: A survey. In: B.L. Golden, R. Raghavan, E. Wasil (eds), *The Vehicle Routing Problem: Latest Advances and New Challenges*. Springer, 103–122, 2008.
7. R.U. Ayres, *Technological Forecasting and Long-time Planning*. McGraw-Hill, New York, 1969.
8. J.S. Bellingham, M. Tillerson, M. Alighanbari, J.P. How, Cooperative path planning for multiple UAVs in dynamic and uncertain environments. In: *Proc. of the 41st IEEE Conf. on Decision and Control*, vol. 3, 2816–2822, 2002.
9. R.E. Bellman, On a routing problem. *Quart. Appl. Math.* 16, 87–90, 1958.
10. O. Berman, Repositioning of distinguishable urban service units on networks. *Comp. & Oper. Res.* 8(2), 105–118, 1981.
11. L. Biagiotti, C. Melchiorri, *Trajectory Planning for Automatic Machines and Robots*. Springer, 2008.
12. B. Boffey, Multiobjective routing problems. *Top* 3(2), 167–220, 1995.
13. S.A. Bortoff, Path planning for UAVs. In: *Proc. of the American Control Conf.*, 364–368, 2000.
14. P. Bose, J. Czyzowicz, L. Gasieniec, E. Kranakis, D. Krizanc, A. Pelc, M.V. Martin, Strategies for hotlink assignments. In: *Int. Symp. on Algorithms and Computation (ISAAC’00)*, LNCS 1969, Springer, 23–34, 2001.
15. D.E. Boyce, Route guidance systems for improving urban travel and location choices. *Transp. Res. - A* 22A(4), 275–281, 1988.
16. R. Bradfield, G. Wright, G. Burt, G. Cairns, K. van der Heijden, The origins and evolution of scenario techniques in long range business planning. *Futures* 37(8), 795–812, 2005.
17. M. Campbell, T. Schetter, Formation flying mission for the uw dawgstar satellite. In: *IEEE Aero. Conf.*, 117–125, 2000.
18. D. Cavendish, M. Gerla, Routing optimization in communication networks. In: M.X. Cheng, Y. Li, D.-Z. Du (eds), *Combinatorial Optimization in Communication Networks*. Springer, 505–547, 2006.
19. C.-Y. Chang, C.-T. Chang, S.-C. Tu, Obstacle-free geocasting protocols for single/multi-destination short message services in ad hoc networks. *Wireless Networks* 9(2), 143–155, 2003.

20. I. Chao, B. Golden, E. Wasil, The team orienteering problem. *EJOR* 88, 464–474, 1996.
21. I. Chao, B. Golden, E. Wasil, A fast and effective heuristic for the team orienteering problem. *EJOR* 88, 475–489, 1996.
22. H. Chen, C. Zhou, X. Huang, Y. Qing, Y. Shi, Management of the reconfigurable protocol stack based on SDL for networked control systems. *Information Technology J.* 9(5), 849–863, 2010.
23. B.V. Cherkassky, A.V. Goldberg, T. Radzik, Shortest paths algorithms: theory and experimental evaluation. *Mathematical Programming, Ser. A* 73(2), 129–174, 1996.
24. T.J. Chermack, Studing scenario planning: Theory, research siggestions, and hypotheses. *Technological Forecasting and Social Change* 72(1), 59–73, 2005.
25. H.M. Choset, K.M. Lynch, S. Hutchinson, G. Kantor, W. Burgard, L.E. Kavraki, S. Thrun, Principles of Robot Motion: Theory, Algorithms, and Implementaitons. MIT Press, 2005.
26. M. Cordeiro, H. Gossain, D.P. Agrawal, Multicast over wireless mobile ad hoc networks: present and future direcitons. *IEEE Netw.* 17, 52–59, 2003.
27. T.H. Cormen, C.E. Leiserson, R.L. Rivest, C. Stein, Introduction to Algorithms. 3rd ed., MIT Press, Boston, 2009.
28. J.R. Current, M. Marsh, Multiobjective transportation network design and routing problems: Taxonomy and annotation. *EJOR* 65(1), 4–19, 1993.
29. J. Czyzowicz, E. Kranakis, D. Krizanc, A. Pelc, M.V. Martin, Evaluation of hotlink structure for improving web performance. *J. Web Eng.* 1(2), 93–127, 2003.
30. L.S.H. De Mello, A.C. Sanderson, AND/OR graph representation of assembly plans. *IEEE Trans. on Robotics and Automation* 6(2), 188–199, 1990.
31. E.W. Dijkstra, A note on two problems in connexion with graphs. *Num. Math.* 1(1), 269–271, 1959.
32. T.A. Dingus, J.F. Antin, M.C. Hulse, W.W. Wierwille, Attentional demand requirements of an automobile moving-map navigation system. *Transp. Res. - Part A* 23(4), 301–315, 1989.
33. E.A. Dinic, The faster algorithm for the PERT problems with AND- and OR-nodes. In: *Proc. of the Workshop on Combinatorial Optimization*, Univ. Waterloo Press, 185–187, 1990.
34. R.C. Dorf, R.H. Bishop, Modern Control Systems. 12th ed., Addison-Wesley, 1998.
35. D. Eppstein, Finding the  $k$  shortest paths. *SIAM J. on Computing* 28(2), 652–673, 1999.
36. C. Ferrari, E. Pagello, J. Ota, T. Arai, Multirobot motion coordination in space and time. *Robotics and Autonomous Systems* 25(3-4), 219–229, 1998.
37. B.A. Forouzan, Data Communications and Networking. 5th ed., McGraw-Hill, 2012.
38. R.L. French, Historical overview of automobile navigation technology. In: *Proc. 36th IEEE Vehicular Technology Conf.*, vol. 36, 350–358, 1986.
39. B. Fiedland, Control System Design: An Introduction to State-Space Methods. Dover Publ., 2005.
40. S. Fuhrmann, S.O. Krumke, H.-C. Wirth, Multiple hotlink assignment. In: A. Brandstadt, V.B. Le (eds) *Proc. of WG 2001, LNCS 2204*, Springer, 189–200, 2001.
41. K. Gadeyne, G. Pinte, K. Berx, Describing the design space of mechanical computational design synthesis problems. *Advanced Engineering Informatics* 28(3), 198–207, 2014.
42. M.R. Garey, D.S. Johnson, Computers and Intractability. The Guide to the Theory of NP-Completeness. W.H.Freeman and Company, San Francisco, 1979.
43. D. Gavalas, C. Konstantopoulos, K. Mastakas, G. Pantziou, Mobile recommender systems in tourism. *J. of Network and Computer Applications* 39, 319–333, 2014.
44. D. Gavalas, C. Konstantopoulos, K. Mastakas, G. Pantziou, A survey on algorithmic approaches for solving tourist trip design problems. *J. of Heuristics* 20(3), 291–328, 2014.
45. D. Gavalas, C. Konstantopoulos, K. Mastakas, G. Pantziou, N. Vathis, Heuristics for the time dependent team orienteering problem: Application to tourist route planning. *Comp. & Oper. Res.* 62, 36–50, 2015.
46. D. Gavalas, V. Kasapakis, C. Konstantopoulos, G. Pantziou, N. Vathis, C. Zaroliagis, The eCOMPASS multimodal tourist tour planner. *ESwA* 42(21), 7303–7316, 2015.
47. M. Godet, The art of scenarios and strategic planning: Tools and pitfalls. *Technological Forecasting and Social Change* 65(1), 3–22, 2000.
48. V. Goel, P. Pirolli, The structure of design problem spaces. *Cognitive Science* 16(3), 395–429, 1992.
49. M.X. Goemans, Y.-s. Myung, A catalog of Steiner tree formulations. *Networks* 23(1), 19–28, 1993.
50. B.L. Golden, L. Levy, R. Vohra, The orienteering problem. *Nav. Res. Log.* 34, 307–318, 1987.

51. M. Gruber, D. Zeller, Multimedia broadcast multicast service: new transmission schemes and related challenges. *IEEE Commun. Mag.* 49(12), 176–181, 2011.
52. G. Gutin, A.P. Punnen, *The Traveling Salesman Problem and Its Variations*. Springer, 2006.
53. P.E. Hart, N.J. Nilsson, B. Raphael, A formal basis for the heuristic determination of minimum cost paths. *IEEE Trans. SMC* 4(2), 100–107, 1968.
54. Y. Huang, R. Chiba, T. Arai, T. Ueyama, J. Ota, Robust multi-robot coordination in pick-and-place tasks based on part-dispatching rules. *Robotics and Autonomous Systems* 64, 70–83, 2015.
55. F.K. Hwang, D.S. Richards, P. Winter, *The Steiner Tree Problem*. Elsevier, Amsterdam, 1992.
56. A. Isidori, *Nonlinear Control Systems*. Springer, Berlin, 1989.
57. M. Jun, R. D’Andrea, Path planning for unmanned aerial vehicles in uncertain and adversarial environments. In: S. Butenko, R. Murphey, P. Pardalos (eds), *Cooperative Control Models, Applications and Algorithms*, Springer, 95–110, 2003.
58. D. Karger, R. Motwani, G.D.S. Ramkumar, On approximating the longest path in a graph. *Algorithmica* 18, 82–98, 1997.
59. L.E. Kavraki, P. Svestka, J.-C. Latombe, M.H. Overmars, Probabilistic roadmaps for path planning in high-dimensional configuration spaces. *IEEE Trans. on Robotics&Automation* 14(4), 566–580, 1996.
60. H. Kim, B. Park, H. Nyung, Curvature path planning with high resolution graph for unmanned surface vehicle. In: *Advances in Intell. Syst. and Comput.*, Springer, vol. 208, 147–154, 2013.
61. D. Kleitman, D. West, Spanning trees with many leaves. *SIAM J. on Discr. Math.* 4(1), 99–106, 1991.
62. Y.B. Ko, N.H. Vaidya, Anycasting-based protocol for geocast service in mobile ad hoc networks. *Computer Networks* 41(6), 743–760, 2003.
63. P. Kumar, V. Singh, D. Reddy, Advanced traveler information system for Hyderabad City. *IEEE Trans. on Intell. Transp. Syst.* 6(1), 26–37, 2005.
64. S.M. La Valle, S.A. Hutchinson, Optimal motion planning for multiple robots having independent goals. *IEEE Trans. on Robotics and Automation* 14(6), 912–925, 1998.
65. G. Laporte. Fifty years of vehicle routing. *Transp. Sci.* 43(4), 408–416, 2009.
66. J.-C. Latombe, *Robot Motion Planning*. Springer, 2012.
67. E.L. Lawler, A.H.G. Rinnoooy Kan, J.K. Lenstra, D.B. Shmoys (eds), *The Traveling Salesman Problem: A Guided Tour of Combinatorial Optimization*. Wiley, 1985.
68. S.-H. Lee, Y.-B. Ko, Efficient geocasting with multi-target regions in mobile multi-hop wireless networks. *Wireless Networks* 16(5), 1253–1262, 2010.
69. M.Sh. Levin, *Combinatorial Engineering of Decomposable Systems*. Kluwer Academic Publishers, Dordrecht, 1998.
70. M.Sh. Levin, *Composite Systems Decisions*. Springer, New York, 2006.
71. M.Sh. Levin, Combinatorial optimization in system configuration design, *Autom. & Remote Control* 70(3), 519–561, 2009.
72. M.Sh. Levin, Combinatorial synthesis of communication protocol ZigBee with interval multiset estimates. In: *Proc. of Int. 4nd It. Conf. on Ultra Modern Telecommunication ICUMT-2012*, St. Petersburg, 29–34, 2012.
73. M.Sh. Levin, Towards design of system hierarchy (research survey). Electronic preprint. 36 p., Dec. 7, 2012. <http://arxiv.org/abs/1212.1735> [math.OA]
74. M.Sh. Levin, Towards multistage design of modular systems. Electronic preprint. 13 p., June 19, 2013. <http://arxiv.org/abs/1306.4635> [math.OA]
75. M.Sh. Levin, A modular approach to the communication protocol and standard for multimedia information: a review. *J. of Communications Technology and Electronics* 58(6), 594–601, 2013.
76. M.Sh. Levin, *Modular System Design and Evaluation*, Springer, 2015.
77. M.Sh. Levin, L.V. Sokolova, Hierarchical combinatorial planning of medical treatment. *Computer Methods and Programs in Biomedicine* 73(1), 3–11, 2004.
78. M.Sh. Levin, M.A. Firer, Hierarchical morphological design of immunoassay technology. *Computers in Biology and Medicine* 35(3), 229–245, 2005.
79. C.P. Low, C.L. Tan, On anycast routing with bandwidth constraint. *Computer Communications* 26(14), 1541–1550, 2003.
80. G.F. Luger, *Artificial Intelligence: Structures and Strategies for Complex Problem Solving*. 5th ed., Addison-Wesley, Boston, 2004.

81. C. Maihofer, A survey of geocast routing protocols. *IEEE Communications Surveys & Tutorials* 6(2), Second Quarter, 2004.
82. E.Q.V. Martins, On a multicriteria shortest path problem. *EJOR* 16(2), 236–245, 1984,
83. D. Medhi, K. Ramasamy, *Network Routing: Algorithms, Protocols, and Architectures*. Morgan Kaufmann, 2007.
84. Q. Meng, D.H. Lee, R.L. Cheu, Multiobjective vehicle routing and scheduling problem with time window constraints in hazardous material transportation. *J. of Transp. Eng.* 131(9), 699–707, 2009.
85. N.J. Nilsson, *Problem Solving Methods in Artificial Intelligence*. MacGraw Hill, New York, 1971.
86. N.S. Nise, *Control Systems Engineering*. 7th. ed., Wiley, 2015.
87. R.P. Pantoni, D. Brandao, Analysis and proposal of a geocast routing algorithm intended for street lighting system based on Wireless Sensor Networks. *Int. J. Comput. Network Secur.* 2, 65–70, 2010.
88. R.P. Pantoni, D. Brandao, A confirmation-based geocast routing algorithm for street lighting systems. *Comput. and Electrical Engineering* 37(6), 1147–1159, 2011.
89. C.H. Papadimitriou, K. Steiglitz, *Combinatorial Optimization: Algorithms and Complexity*. Prentice-Hall, Englewood Cliffs, NJ, 1982.
90. C.E. Perkins, *Ad Hoc Networking*. Addison Wesley, Upper Saddle River, NJ, 2001.
91. D. Petrovic, M. Morshed, S. Petrovic, Multi-objective genetic algorithms for scheduling of radiotherapy treatments for categorized cancer patients. *ESwA* 38(6), 6994–7002, 2011.
92. S. Pettie, V. Ramachandran, An optimal minimum spanning tree algorithm. *J. of the ACM* 49(1), 16–34, 2002.
93. C.L. Phillips, H.T. Nagle, *Digital control system analysis and design*. 4th ed., Prentice Hall, Upper Saddle River, NJ, 2007.
94. J.G. Quenum, S. Alnine, O. Shehory, S. Honiden, Dynamic protocol selection in open and heterogeneous systems. In: *Proc. IEEE/WIC/ACM Int. Conf. on Intell. Agent Technol.*, 333–341, 2006.
95. T.S. Rappoport, *Wireless Communications: Principles and Practices*. Prentice Hall, 1996.
96. C. Rhodes, M. Morari, L.S. Tsimring, N.F. Rulkov, Data-based control trajectory planning for nonlinear system. *Physical Review E* 56(3), 2398–2406, Sep. 1997.
97. G. Ringland, *Scenario Planning: Managing for the Future*. Wiley, 1998.
98. L.H. Sahasrabudde, B. Mukherjee, Multicast routing algorithms and protocols: A tutorial. *IEEE Networks* 90–102, Jan./Feb. 2000.
99. D.P. Scharf, F.Y. Hadaegh, S.R. Ploen, A survey of spacecraft formation flying guidance and control (part I): guidance. In: *Proc. of the American Control Conf.*, 1733–1739, 2003.
100. R. Scheubrein, S. Zionts, A problem structuring from and for multiple criteria decision support system, *Comp. & Oper. Res.* 33(1), 18–31, 2006.
101. P.J.H. Schoemaker, Scenario planning: A tool for strategic thinking. *Sloan Management Review*, 36(2), 25–40, 1995.
102. T. Schouwennars, M. Valenti, E. Feron, J. How, E. Roche, Linear programming and language processing for human-unmanned aerial-vehicle team mission. *J. of Guid., Contr., and Dyn.* 29(2), 303–313, 2006.
103. S.C. Shapiro, *Encyclopedia of Artificial Intelligence*. Wiley, New York, 1987.
104. W. Souffriau, P. Vansteenwegen, J. Vertommen, G. Vanden Berghe, D. Van Oudheusden, A personalized tourist trip design algorithm for mobile tourist guide. *Appl. Artif. Intell.* 22(10), 964–985, 2008.
105. W. Souffriau, P. Vansteenwegen, G. Vanden Berghe, D. Van Oudheusden, A path relinking approach for the team orienteering problem. *Comp. and Oper. Res.* 37(11), 1853–1859, 2010.
106. M.W. Sprong, S. Hutchinson, M. Vidyasagar, *Robot Modeling and Control*. Wiley, 2005.
107. B.L. Stevens, F.L. Lewis, *Aircraft Control and Simulation*. 2nd ed., Wiley, Hoboken, NJ, 2003.
108. P. Svestka, M.H. Overmars, Coordinated path planning for multiple robots. *Robotics and Autonomous Systems* 23(3), 125–152, 1998.
109. Z. Tarapata, On a multicriteria shortest path problem. *Int. J. Appl. Math. Comput. Sci.* 17(2), 269–287, 2007.
110. L. Tian, C. Collins, An effective robot trajectory planning method using a genetic algorithm. *Mechatronics* 14(5), 455–470, 2004.
111. P. Toth, D. Vigo, *The Vehicle Routing Problem*. Monographs on Discrete Mathematics and Applica-



- tions, SIAM, Philadelphia, 2001.
- 112.C.T. Tung, K.L. Chew, A multicriteria Pareto-optimal path algorithm. *EJOR* 62(2), 203–209, 1992.
- 113.P. Vansteenwegen, D. Van Oudheusden, The mobile tourist guide: An OR opportunity. *OR Insight* 20(3), 21–27, 2007.
- 114.P. Vansteenwegen, W. Souffriau, G. Vanden Berghe, D. Van Oudheusden, The City Trip Planner: An expert system for tourists. *ESWA* 38(6), 6540–6546, 2011.
- 115.P. Vansteenwegen, W. Souffriau, D. Van Oudheusden, The orienteering problem: A survey. *EJOR* 209(1), 1–10, 2011.
- 116.C.A. Varum, C. Melo, Directions in scenario planning literature - A review of the past decades. *Futures* 42(4), 355–369, 2010.
- 117.L.-Y. Wei, W.C. Peng, W.-C. Lee, Exploring pattern-aware travel routes for trajectory search. *ACM TISI ACM Trans. on Intelligent Systems and Technology* 4(3), art. 48, 2013.
- 118.J.E. Wieselthier, G.D. Nguen, A. Ephremides, On the construction of energy-efficient broadcast and multicast trees in wireless networks. In: *Proc. IEEE INFOCOM 2000*, 586–594, 2000.
- 119.P. Winter, Steiner problem in networks: a survey. *Networks* 17(2), 129–167, 1987.
- 120.D.T. Wooden, Graph-based path planning for mobile robots. PhD Thesis, Georgia Inst. of Technology, 2006.
- 121.M. Wzorek, P. Doherty, Reconfigurable path planning for an autonomous unmanned aerial vehicle. In: *Int. Conf. on Hybrid Information Technology ICHIT'06*, vol. 2, 242–249, 2006.
- 122.C. Xie, S.T. Waller, Parametric search and problem decomposition for approximating Pareto-optimal paths. *Transp. Res. Part B* 46, 1043–1067, 2012.
- 123.J.Y. Yen, Finding the k shortest paths in a network. *Mang. Sci.* 17(11), 712–716, 1971.
- 124.Z. Zhang, H. Li, Algorithms for long paths in graph. *Theor. Comput. Sci.* 377, 25–34, 2007.
- 125.F. Zwicky, *Discovery Invention, Research Through the Morphological Approach*. New York, McMillan, 1969.